



Acer beTouch E120 Smartphone

Model number: \_\_\_\_\_

Serial number: \_\_\_\_\_

Date of purchase: \_\_\_\_\_

Place of purchase: \_\_\_\_\_

# End User Licence Agreement

---

IMPORTANT-READ CAREFULLY: THIS END USER LICENSE AGREEMENT ("AGREEMENT") IS A LEGAL AGREEMENT BETWEEN YOU (EITHER AN INDIVIDUAL OR A SINGLE ENTITY), AND ACER INC. INCLUDING ITS SUBSIDIARIES ("ACER") FOR THE SOFTWARE (WHETHER PROVIDED BY ACER OR BY ACER'S LICENSORS OR SUPPLIERS) THAT ACCOMPANIES THIS AGREEMENT, INCLUDING ANY ASSOCIATED MEDIA, PRINTED MATERIALS AND RELATED USER ELECTRONIC DOCUMENTATION WHICH MAY BE BRANDED "ACER" ("SOFTWARE"). AGREEMENTS RELATING TO ANY OTHER PRODUCT OR TOPIC ARE NEITHER INTENDED NOR SHOULD THEY BE IMPLIED. BY INSTALLING THE ACCOMPANYING SOFTWARE OR ANY PORTION THEREOF, YOU AGREE TO BE BOUND BY THE TERMS AND CONDITIONS OF THIS AGREEMENT. IF YOU DO NOT AGREE TO ALL OF THE TERMS AND CONDITIONS OF THIS AGREEMENT, DO NOT CONTINUE THE INSTALLATION PROCESS AND IMMEDIATELY DELETE ALL INSTALLED FILES, IF ANY, OF THE ACCOMPANYING SOFTWARE FROM YOUR PHONE.

IF YOU DO NOT HAVE A VALIDLY-LICENSED COPY OF THE APPLICABLE SOFTWARE, YOU ARE NOT AUTHORIZED TO INSTALL, COPY OR OTHERWISE USE THE SOFTWARE, AND HAVE NO RIGHTS UNDER THIS AGREEMENT.

The Software is protected by U.S. and international copyright laws and conventions as well as other intellectual property laws and treaties. The Software is licensed, not sold.

## GRANT OF LICENSE

Acer grants to you the following non-exclusive and non-transferable rights with respect to the Software. Under this Agreement, you may:

1. Install and use the Software only on a single designated phone. A separate license is required for each phone on which the Software will be used;
2. Make one copy of the Software solely for backup or archival purposes;
3. Make one hardcopy of any electronic documents included in the Software, provided that you receive the documents electronically.

## RESTRICTIONS

You may NOT:

1. Use or copy the Software except as provided in this Agreement;
2. Rent or lease the Software to any third party;
3. Modify, adapt, or translate the Software in whole or in part;
4. Reverse engineer, decompile, or disassemble the Software or create derivative works based upon the Software;
5. Merge the Software with any other program or modify the Software, except for your personal use; and
6. Sublicense or otherwise make the Software available to third parties, except that you may, after prior written notification to Acer, transfer the Software as a whole to a third party so long as you do not retain any copies of the Software and such third party accepts the terms of this Agreement.
7. Transfer your rights under this Agreement to any third parties.
8. Export the Software in contravention of applicable export laws and regulations, or (i) sell, export, re-export, transfer, divert, disclose technical data, or dispose of, any Software to any prohibited person, entity, or destination including, without limitation, Cuba, Iran, North Korea, Sudan and Syria; or (ii) use any Software for any use prohibited by the laws or regulations of the United States.

## SUPPORT SERVICES

Acer is not obligated to provide technical or other support for the Software.

## ACER LIVE UPDATE

Certain of the software contains elements that enable the use of the Acer Live Update service, which allows for updates for such software to be automatically downloaded and installed on your phone. By installing the software, you hereby agree and consent that Acer (or its licensors) may automatically check the version of such software that you are using on your phone and may provide upgrades to such software that may be automatically downloaded on to your phone.

## OWNERSHIP AND COPYRIGHT

Title, ownership rights and intellectual property rights in and to the Software and all copies thereof shall remain with Acer or Acer's licensors or suppliers (as applicable). You do not have or shall not gain any proprietary interest in the Software (including any modifications or copies made by or for you) or any related intellectual property rights. Title and related rights in the content accessed through the Software is the property of the applicable content owner and may be protected by applicable law. This license gives you no rights to such contents. You hereby agree

1. Not to remove any copyright or other proprietary notices from the Software;
2. To reproduce all such notices on any authorized copies you make; and
3. To use best efforts to prevent any unauthorized copying of the Software.

## TRADEMARKS

This Agreement does not grant to you any rights in connection with any trademarks or service marks of Acer or of Acer's licensors or suppliers.

## DISCLAIMER OF WARRANTIES

TO THE MAXIMUM EXTENT PERMITTED BY APPLICABLE LAW, ACER, ITS SUPPLIERS, AND ITS LICENSORS, PROVIDE THE SOFTWARE "AS IS" AND WITH ALL FAULTS, AND HEREBY DISCLAIM ALL OTHER WARRANTIES AND CONDITIONS, EITHER EXPRESS, IMPLIED OR STATUTORY, INCLUDING, BUT NOT LIMITED TO, ANY IMPLIED WARRANTIES, DUTIES OR CONDITIONS OF MERCHANTABILITY, OF FITNESS FOR A PARTICULAR PURPOSE, OF ACCURACY OR COMPLETENESS OF RESPONSES, OF RESULTS, OF WORKMANLIKE EFFORT, OF LACK OF VIRUSES, AND OF LACK OF NEGLIGENCE, ALL WITH REGARD TO THE SOFTWARE AND THE PROVISION OF OR FAILURE TO PROVIDE SUPPORT SERVICES. ALSO, THERE IS NO

WARRANTY OR CONDITION OF TITLE, QUIET ENJOYMENT, QUIET POSSESSION, CORRESPONDENCE TO DESCRIPTION OR NON-INFRINGEMENT WITH REGARD TO THE SOFTWARE.

#### EXCLUSION OF INCIDENTAL, CONSEQUENTIAL AND CERTAIN OTHER DAMAGES

TO THE MAXIMUM EXTENT PERMITTED BY APPLICABLE LAW, IN NO EVENT SHALL ACER, ACER'S SUPPLIERS, OR ACER'S LICENSORS, BE LIABLE FOR ANY SPECIAL, INCIDENTAL, INDIRECT, PUNITIVE, OR CONSEQUENTIAL DAMAGES WHATSOEVER (INCLUDING, BUT NOT LIMITED TO, DAMAGES FOR LOSS OF PROFITS OR CONFIDENTIAL OR OTHER INFORMATION, FOR BUSINESS INTERRUPTION, FOR PERSONAL INJURY, FOR LOSS OF PRIVACY, FOR FAILURE TO MEET ANY DUTY INCLUDING OF GOOD FAITH OR OF REASONABLE CARE, FOR NEGLIGENCE, AND FOR ANY OTHER PECUNIARY OR OTHER LOSS WHATSOEVER) ARISING OUT OF OR IN ANY WAY RELATED TO THE USE OF OR INABILITY TO USE THE SOFTWARE, THE PROVISION OF OR FAILURE TO PROVIDE SUPPORT SERVICES, OR OTHERWISE UNDER OR IN CONNECTION WITH ANY PROVISION OF THIS AGREEMENT, EVEN IN THE EVENT OF THE FAULT, TORT (INCLUDING NEGLIGENCE), STRICT LIABILITY, BREACH OF CONTRACT OR BREACH OF WARRANTY OF ACER OR ITS SUPPLIERS OR LICENSORS, AND EVEN IF ACER AND ITS SUPPLIERS AND LICENSORS HAVE BEEN ADVISED OF THE POSSIBILITY OF SUCH DAMAGES.

#### LIMITATION OF LIABILITY AND REMEDIES

NOTWITHSTANDING ANY DAMAGES THAT YOU MIGHT INCUR FOR ANY REASON WHATSOEVER (INCLUDING, WITHOUT LIMITATION, ALL DAMAGES REFERENCED ABOVE AND ALL DIRECT OR GENERAL DAMAGES), THE ENTIRE LIABILITY OF ACER, ITS SUPPLIERS, AND ITS LICENSORS, UNDER ANY PROVISION OF THIS AGREEMENT, AND YOUR EXCLUSIVE REMEDY FOR ALL OF THE FOREGOING, SHALL BE LIMITED TO THE AGGREGATE AMOUNT PAID BY YOU FOR THE SOFTWARE. THE FOREGOING LIMITATIONS, EXCLUSIONS AND DISCLAIMERS (INCLUDING DISCLAIMER OF WARRANTIES AND EXCLUSION OF INCIDENTAL, CONSEQUENTIAL AND CERTAIN OTHER DAMAGES ABOVE) SHALL APPLY TO THE MAXIMUM EXTENT PERMITTED BY APPLICABLE LAW, EVEN IF ANY REMEDY FAILS ITS ESSENTIAL PURPOSE; PROVIDED, HOWEVER, THAT BECAUSE SOME JURISDICTIONS DO NOT ALLOW THE EXCLUSION OR LIMITATION OR LIABILITY FOR CONSEQUENTIAL OR INCIDENTAL DAMAGES, THE ABOVE LIMITATION MAY NOT APPLY TO YOU.

#### TERMINATION

Without prejudice to any other rights, Acer may immediately terminate this Agreement without notice if you fail to comply with any terms and conditions of this Agreement.

In such event, you must:

1. Cease all use of the Software;
2. Destroy or return to Acer the original and all copies of the Software; and
3. Delete the Software from all phones on which it was resident.

All disclaimers of warranties and limitation of liability set forth in this Agreement shall survive termination of this Agreement.

#### GENERAL

This Agreement represents the complete agreement between you and Acer relating to this license for the Software and supersedes all prior agreements, communications, proposals and representations between the parties and prevails over any conflicting or additional terms of any quote, order, acknowledgement or similar communication. This Agreement may only be modified by a written document signed by both parties. If any provision of this Agreement is held by a court of competent jurisdiction to be contrary to law that provision will be enforced to the maximum extent permissible and the remaining provisions of this Agreement will remain in full force and effect.

#### ADDITIONAL PROVISIONS APPLICABLE TO THIRD PARTY SOFTWARE AND SERVICES

Software provided hereunder by Acer's licensors or suppliers ("Third Party Software") is made available to you for your personal, non-commercial use only. You may not use the Third Party Software in any manner that could damage, disable, overburden, or impair the services provided by Acer's licensors or suppliers hereunder ("Third Party Services"). Furthermore, you may not use the Third Party Software in any manner that could interfere with any other party's use and enjoyment of the Third Party Services, or the services and products of Acer's licensors' or suppliers' third party licensors. Your use of the Third Party Software and Third Party Services is also subject to additional terms and conditions and policies which can be accessed through our global website.

## Privacy policy

During registration you will be asked to submit some information to Acer. Please refer to Acer's privacy policy at [www.acer.com](http://www.acer.com) or your local Acer website.

# Table of Contents

---

## End User Licence Agreement

### Getting to know your smartphone

Features and functions .....	7
Product registration .....	7

### Setting Up

Unpacking your smartphone .....	8
Getting to know your smartphone .....	8
Installing or removing the battery .....	10
Installing a SIM and microSD Card .....	11

### Using your Smartphone

Turning on for the first time .....	12
Using the touchscreen .....	12
The onscreen keyboard .....	13
The Home screen .....	13

### Managing contacts

Managing your contacts .....	16
------------------------------	----

### Making Calls

Before making a call .....	17
Making a call .....	17
The voice call screen .....	18
Onscreen call options .....	18

### Messaging

Creating a new message .....	20
Replying to a message .....	21
MMS messages .....	21

### Going online

Browsing the Internet .....	23
Setting up Email .....	23
Online applications .....	24

### Using the Camera

Camera icons and indicators .....	25
Taking a photo .....	26
Shooting a video .....	26
Viewing photos and videos .....	26

### Advanced Settings

Putting your smartphone in Airplane mode .....	27
Acer Settings .....	27
Activating or deactivating connections .....	28
Adjusting connection settings .....	28
Phone settings .....	29
urFozz .....	30
Connecting to a PC .....	31
Managing your calendar .....	32
GPS tracker .....	32

FM radio .....	33
Multimedia playback .....	33
Resetting your smartphone .....	36
<b>Accessories and Tips</b>	
Using the headset .....	38
Using a Bluetooth headset .....	38
Using your smartphone as a modem .....	38
Setting up the modem on your PC .....	38
Inserting a microSD Card .....	39
<b>Appendix</b>	
FAQ and troubleshooting .....	40
Other sources of help .....	40
Aux ADB .....	41
Warnings and precautions .....	41
Emergency calls .....	44
Disposal and recycling information .....	44
Taking care of your smartphone .....	44
Specifications .....	46
Regulatory information .....	48

# Getting to know your smartphone

---

## Features and functions

Your new smartphone offers leading, easy-to-access multimedia and entertainment features. You can:

- Access your email while on the move.
- Connect to the Internet at high speed, via HSDPA (3.6 Mbps) or Wi-Fi.
- Keep in touch with your friends via your Contacts and social networking applications.

## Product registration

When using your product for the first time, it is recommended that you immediately register it. This will give you access to some useful benefits, such as:

- Faster service from our trained representatives.
- Membership in the Acer community: receive promotions and participate in customer surveys.
- The latest news from Acer.

Hurry and register, as other advantages await you!

## How to register

To register your Acer product, please visit <http://mobile.acer.com>. Click **Product Registration** and follow the simple instructions.

You can also register directly from your smartphone by tapping **Acer Registration**.

After we receive your product registration, you will be sent a confirmation email with important data that you should keep in a safe place.

# Chapter 1: Setting Up

## Unpacking your smartphone

Your new smartphone comes packed in a protective box. Carefully unpack the box and remove the contents. If any of the following items is missing or damaged, contact your dealer immediately:

- Acer beTouch E120 Smartphone
- Battery
- Quick Guide
- USB cable
- AC adapter
- Headset

## Getting to know your smartphone

### Views

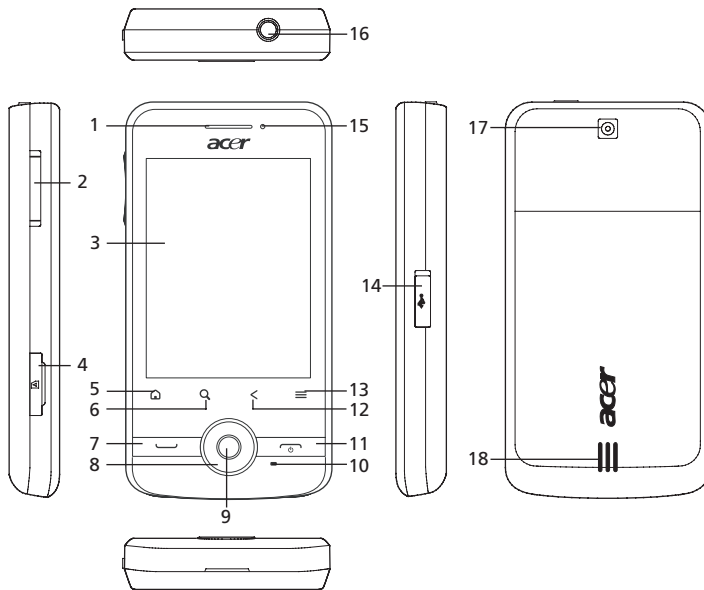

No.	Item	Description
1	Phone speaker	Emits audio from your smartphone; suitable for holding to your ear.
2	Volume up / down button	Increase or decrease the phone volume.
3	Touchscreen	2.8-inch, 320 x 240 pixel resistive touchscreen to display data, phone content and enter information.
4	microSD card slot	Insert a microSD card.



No.	Item	Description
5	Home button	Return to the Home screen; press and hold to view recently-used applications, tap an icon to open the associated program.
6	Search button	Open the Google search function.
7	Call button	Activate phone/dial/view recently dialed numbers/ answer a call.
8	Navigation buttons	4-way navigation control to move the cursor.
9	Center button	Press the center button to activate the selected item.
10	Microphone	Internal microphone.
11	End button / Power button	Press to end a call. / Press to turn the screen on/off or enter sleep mode; press and hold to turn the smartphone off.
12	Back button	Go back one menu step; close the keyboard.
13	Menu button	Open the option menu; press and hold to display the keyboard.
14	Micro USB connector	Connect to a USB cable/charger.
15	LED indicator	Indicates battery level and event status.
16	3.5 mm headphone jack	Connect to stereo headphones.
17	Camera	A 3-megapixel camera for taking high-resolution images.
18	Handsfree speaker	Emits audio from your smartphone; suitable for handsfree use.

## LED indicators

No.	Item	Description
Red	Steady	Battery is charging.
	Slow flashing	Battery level is low.
	Flashes twice rapidly	Battery level is critically low.
	Flashes rapidly	Battery level is too low to start the phone.
	Flashes every 10 seconds	New event (missed call, new message, voicemail, etc.)

# Installing or removing the battery

Your smartphone uses a replaceable battery to provide power. It is packed separately from your smartphone and needs to be inserted and charged before you can use the smartphone.

## Installing the battery

Insert your fingernail into the cutout between the battery cover and the phone. Unclip the cover and lift off the battery cover.

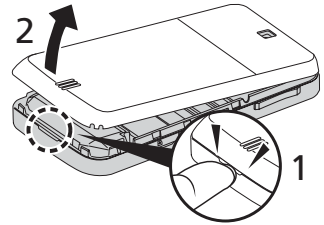

Place the battery into the battery compartment, lining up the battery connectors with those at the bottom of the compartment.

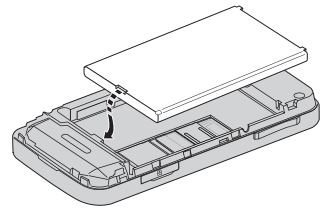

Insert the tabs on the bottom of the battery cover into the slots in the phone. Carefully press the top of the cover until the clips on the side of the cover click in place.

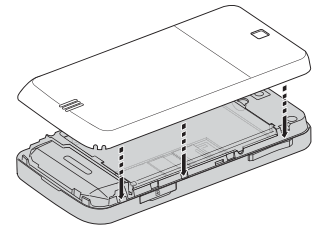

CAUTION: RISK OF EXPLOSION IF BATTERY IS REPLACED BY AN INCORRECT TYPE.  
DISPOSE OF USED BATTERIES ACCORDING TO THE INSTRUCTIONS.

## Charging the battery

For initial use, you need to charge your smartphone for eight hours. After that you can recharge the battery as needed.

Connect the AC adapter cord to the micro USB connector on your smartphone.

## Removing the battery

Open the battery compartment as shown in **“Installing the battery”**. Lift the battery out of the compartment using the clip on the top of the battery.

Replace the battery cover as described above.

# Installing a SIM and microSD Card

To take full advantage of your smartphone's telephony capabilities, you must install a SIM card. The SIM card holder is located at the bottom of the battery bay.

Additionally, you may wish to increase your smartphone's storage by inserting a microSD Card into the slot provided. This is next to the SIM card slot.

1. Turn off the phone by pressing and holding the power button.
2. Open the cover and remove the battery.
3. Insert the SIM card and microSD card as shown.
4. Replace the battery and battery cover.

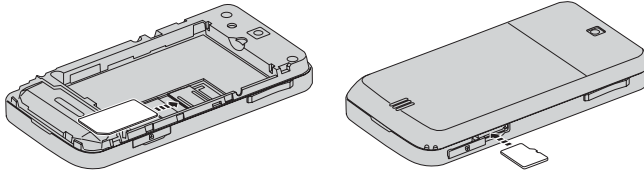

**Note:** Ensure that the microSD Card is inserted all the way into the card slot.



**Caution:** Turn off your smartphone and remove the battery before installing or removing the SIM or microSD card. You may damage the card or your smartphone if the battery is still installed.

## SIM card lock

Your smartphone may come with a SIM card lock, i.e., you will only be able to use the SIM card provided by your network operator.

To cancel the SIM lock, contact your network provider.

# Chapter 2: Using your Smartphone

---

## Turning on for the first time

To turn on your smartphone for the first time, press and hold the power button until the screen turns on. You will then be asked to configure some settings before you can use your smartphone.

Follow the onscreen instructions to complete setup.

## Sign in to or create a Google account

If you have Internet access, your smartphone allows you to synchronize information with a Google account.

During the start-up process, you may create or sign in to your account, which will be used to synchronize your contact list, email, calendar and other information. If you do not yet have Internet access then tap **Try Again**, but then tap **Back** and then skip the connection step.

## Entering your PIN

When you install a SIM card for the first time, you may need to enter a PIN using the onscreen number pad.



.....  
**Important:** Depending on your settings, you may be required to enter your PIN each time you switch on the phone function.  
.....

## Activating a new SIM card

If you are using your SIM card for the first time, it may require activation. Contact your network operator for details on how to do this.

## Using the touchscreen

Your smartphone uses a touchscreen for selecting items and entering information. Use your finger to tap the screen.

**Tap:** Touch the screen once to open items and select options.

**Drag:** Hold your finger on the screen and drag across the screen to select text and images.

**Tap and hold:** Tap and hold an item to see a list of actions available for that item. On the pop-up menu that appears, tap the action you want to perform.

**Scroll:** To scroll up or down the screen, simply drag your finger up or down the screen in the direction that you want to scroll.

# The onscreen keyboard

When you tap a text box to enter text, the onscreen keyboard will automatically display.



# The Home screen

After rebooting, your smartphone will display the Home screen. This screen gives you quick, icon-based access to many of the frequently-used features of your smartphone.

The first time you start your smartphone, you will see some icons on the screen.

At the bottom of the screen is the **Applications tab** which lists all the applications you have installed. Tap the tab to open the Applications tab. Tap an icon to open the application.

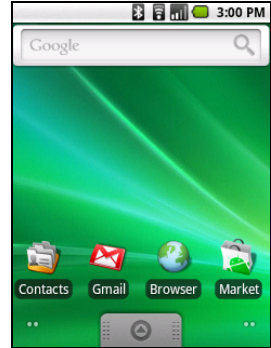

# Multitasking

You can have multiple applications open at the same time. To open a new application, press the **Home** button to return to the Home screen, then start the new application.

To view your active applications, press and hold the **Home** button. Then tap an icon to go to the application.



**Tip:** To prolong battery life, it is better to close an application when you've finished using it. Do this by either pressing the **Back** key or the **Menu** button and selecting **Exit** (if available).

# The extended Home screen

The Home screen extends to either side of the screen, giving you more room to add icons, widgets or features. To view the extended Home screen slide your finger to the left or right of the Home screen.

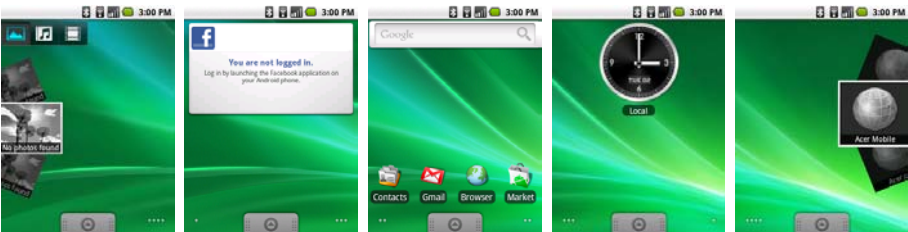

# Notification area

The Notification area is at the top of the screen.



This area contains a variety of icons to inform you of your phone's status. The left side of the Notification area displays event icons that indicate a new event (such as a new message). The icons on the right side indicate signal strength, connection, battery status and the time.

Drag the **Notification area** down the screen, or tap the area, to view more information about new events.

Icon	Description
	Indicates that storage is running low. Remove programs or files to increase the available storage.
	SD Card removed.
	WLAN signal strength.
	Vibrate mode enabled.
	SIM card is invalid or not installed.
	Battery status.
	Missed call.
	New/unread SMS.
	New/unread MMS.
	New/unread email.
	HSDPA connected: Downloading data.
	3G connected: You may make a call.
	Connected to a 2G network: You may make a call.
	Airplane mode: Wireless connectivity disconnected. Please disable airplane mode before trying to make a call.
	Incoming call or active call.

## Personalizing the Home screen

You may personalize your Home screen by adding or removing icons, shortcuts or widgets, or changing the wallpaper.

## Adding or removing icons

You can set icons for installed applications on the Home screen. Tap and hold an icon in the Applications tab to copy it to the Home screen. To remove an icon from the Home screen, tap and drag the icon from the Home screen to the trash tab that appears at the bottom of the screen.

## Adding or removing shortcuts or widgets

To add shortcuts or widgets, tap and hold anywhere on the Home screen to open the Add to Home screen menu.

Tap **Shortcuts** to open a list of quick links to applications and settings you can add to the Home screen.

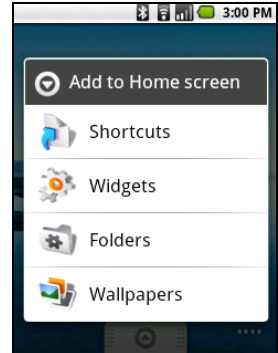

Tap **Widgets** to open a list of small applications that you can add to your Home screen. Widgets are handy applications that you can add to your Home screen to display various information.

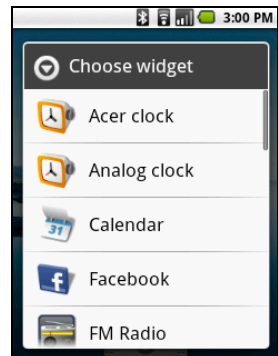

You can also add folders to your Home screen. There are some pre-defined folders available or you can add a **New folder**. This will be placed on your Home screen and named Folder. To change the name of the folder, tap to open it. Tap and hold the name bar at the top of the folder window to open a dialog box that will allow you to rename the folder.

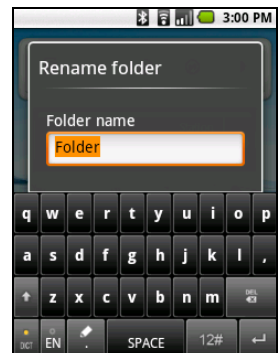







# Chapter 3: Managing contacts

## Managing your contacts

Your smartphone features an address book that allows you to save contacts to either the internal memory or onto your SIM card.

Tap **Contacts** from the Home screen or the **Contacts** tab from the Dialer to view your contacts.

If you don't have any contacts stored on your phone, you can import your Google account contacts, add a new contact or import any SIM contacts. Press the **Menu** button to open the menu.

Icon	Description
	Search for a contact.
	Add a new contact.
	Display the contacts you have assigned to a group.
	Delete contacts.
	Import contacts.
	Export contacts.

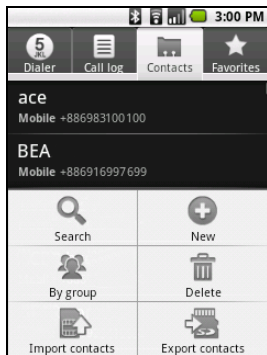

## Adding a contact

Tap **New** to add a new contact. You will be asked if you want to create a SIM contact or a Phone contact.

To create a contact, you will be asked to enter the contact's:

- Given and Family name.
- Phone numbers.
- Email addresses.
- IM addresses.
- Postal addresses.

You may also:

- Enter information such as organizations the contact belongs to.
- Any personal notes about the contact.
- Set a ringtone.
- Send any calls from this contact directly to your voicemail.

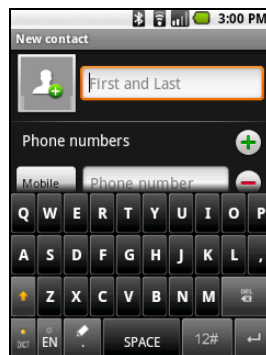





# Chapter 4: Making Calls

This chapter shows you how to make phone calls, and the various options available to you during your call.

## Before making a call

Check that the phone function is on before you make a call. You can confirm the phone status from the icon on the right-hand side of the Notification area.

Icon	Description
	Connected: You may make a call.
	Airplane mode: Wireless connectivity disconnected. Please disable airplane mode before trying to make a call.

## Making a call



**Note:** The phone function needs to be enabled before the call can be connected.

1. From the Home screen tap **Dialer** or open **Dialer** from the menu to open the onscreen number pad.
2. Enter the number you wish to dial.
3. Press the **Call** button to make the call.
4. To end the call, press the **End** button.

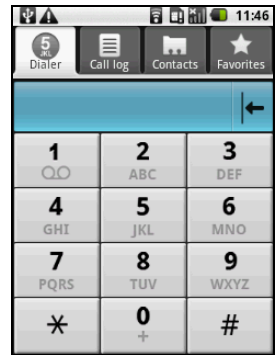

## Dialing a number from Call Log

Your call history can be viewed by tapping the **Call Log** tab. It displays recent received, dialed, and missed calls.

Tap a number to view the call details. To redial any number in the call history, select the number and tap



You may also tap and hold the number to open a menu with other options: **Call <the number>**; **Edit number before call**; **Send SMS/MMS**; **Add to contacts** or **Remove from call log**.

Missed calls will be displayed by the call indicator on the top of your phone and in the Notification area with the icon .

You can also view missed calls from the Notification area.

1. Open the notification list by tapping and dragging the Notification area downwards to display the details of the missed calls.
2. Select the call from the list and tap  to return the missed call.

You can save phone numbers to your Contacts from the Call Log. Please refer to **“Adding a contact” on page 16** for further details.

## Making a call to one of your contacts

1. Tap the **Contacts** tab in the dialer or **Contacts** from the Home screen to view your contacts.
2. Tap a contact. A dialog will open, asking if you want to Call the contact or send the contact an SMS.

## Dialing an international number

When dialing international numbers, there is no need to enter the international direct dialing prefix ('00' etc.) before the country code. Simply tap and hold **0+** on the onscreen number pad until **+** appears onscreen.



.....  
**Warning:** International call rates can vary greatly depending on the country you are calling and your network provider. We suggest you check all call rates with your network provider, to avoid excessive phone bills. If you are using your smartphone abroad, roaming charges will apply. Consult your network provider for roaming rates specific to the country you are visiting before you leave.  
.....

## The voice call screen

Once you have dialed your number the voice call screen appears, which displays the number/contact you are talking to, the call duration and the dialpad tab.

## Onscreen call options

### Answering a call

Press the **Call** button to answer a call.

### Rejecting a call

Press the **End** button to reject a call.

### Ending a call

To end a call, press the **End** button.

## Using the speakerphone

The speakerphone function allows you to make calls without having to hold your smartphone. This handsfree function is especially useful for multitasking.

To activate the speakerphone, tap **Speaker** on the voice call screen. Tap **Speaker again** to disable the speakerphone.

## Muting a call

To mute a call, tap **Mute** on the voice call screen to switch off the microphone. Tap **Mute** again to switch the microphone back on.

# Saving a dialed number to contacts

You can save a number you have dialed to your contacts for future use.

1. Select the number from the **Call log** tab, and tap **Add to contacts**.
2. Tap **Create new contact** and select how to complete the action. Please refer to **"Adding a contact"** on page 16.

# Conference calls

If you have one call on hold and another online, you can combine both calls to create a conference call.

After the first call is established, tap **Add call** to add a second call. Tap **Merge calls** to start the conference call.

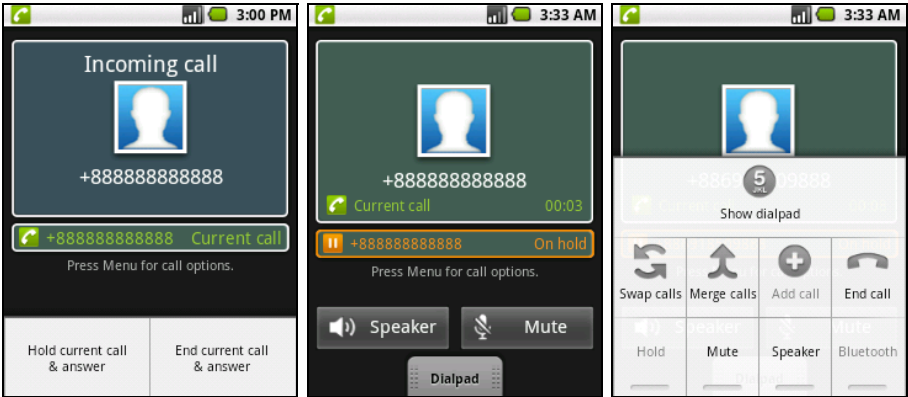

# Chapter 5: Messaging

---

This chapter shows you how to set up and use the SMS and MMS functions of your smartphone.

All SMS and MMS messages are accessed via Messaging. Messaging automatically arranges received and sent messages into threads.

To access Messaging tap **Messaging on the Home screen**.

## Creating a new message

You can use your phone to compose SMS or MMS messages.

Tap **New message** to compose a new message.



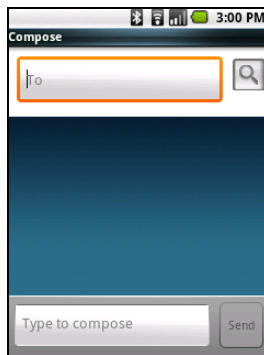

Enter the recipient's phone number or name in the **To** field. Suggested contacts will be displayed in a drop-down list below the text field. To select a suggested contact, tap the contact's name.

Once you have entered the recipient, enter your message in the text box labeled **Type to compose**.



.....  
**Note:** SMS messages may be up to 160 characters long. If your message is longer than 160 characters, it will be sent as multiple linked messages. Most phones will automatically join the linked messages to present the recipient with a single long message, however, some older phones do not have this ability.  
.....

Press the Menu button to see what options are available when creating a new message. The options change depending on the status of the message.







Icon	Description
	Convert the SMS to an MMS, allowing you to add a subject to the message.
	Convert the SMS to an MMS, allowing you to attach a file to the message.
	Discard the message.
	View all the threads currently on your phone.

# Replying to a message

When a new text message arrives a message icon appears in the Notification area and the message icon on the top of the phone lights up.

Tap **Messaging** on the Home screen to view the message list or expand the Notification area to see a summary of the message. Tap the summary to open the message list.

To reply to an SMS or MMS message, open the message from the message list. Enter your text in the text box labeled **Type to compose**. Press the Menu button to see available options.

Icon	Description
	Open the Dialer to call the recipient.
	Convert the SMS to an MMS, allowing you to add a subject to the message.
	Convert the SMS to an MMS, allowing you to attach a file to the message.
	Send the message.
	Insert a smiley/emoticon into your message text.
	Show other available options.

## MMS messages

MMS messages are similar to text messages but also allow you to attach multimedia files such as pictures, audio or video clips. Each MMS message can be up to 300 kB in size.



**Note:** You need to set up an MMS profile before you can send MMS messages. Normally, your smartphone will set up the profile for you based on information retrieved from your provider.



**Tip:** Ask your network provider for the necessary information if you need to manually set up the MMS profile.

# Receiving MMS messages

When a new MMS message arrives, a message icon appears at the top of the screen and a notification message is displayed.

1. Open Messaging to view a summary of the message.
2. Tap **Download** to download the message content.



**Note:** Downloads can take a long time, depending on your connection quality. If you reply or open another application, the download will be stopped.



**Important:** You may be charged to download message content, especially if you are roaming. Please contact your provider if you have any questions.

3. Tap the message to view the content.
4. Press the Menu button and tap **Reply**. Enter your text in the text box labeled **Type to compose** and tap **Send**. Simple text replies will be sent as SMS messages. If you wish to attach a file, press the Menu button and tap **Attach**. You will be presented with a menu of options.
5. When you have finished composing the message, press the Menu button and tap **Send**.

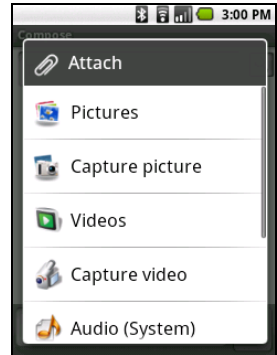

# Chapter 6: Going online

## Browsing the Internet

In order to browse the Internet with your smartphone, you must be connected to a data or wireless network.

### Using the browser

Tap **Browser** on the Home screen to start browsing. To open a new website, tap the address box at the top of the page. Enter the address using the keyboard and tap **Go**.

To view your browsing history, bookmarks or frequently visited sites, open the browser then press and hold the back button.

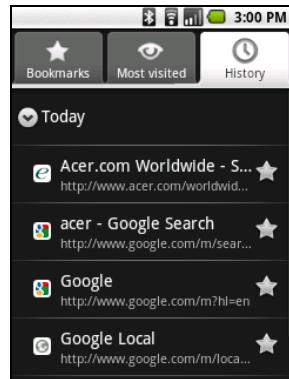
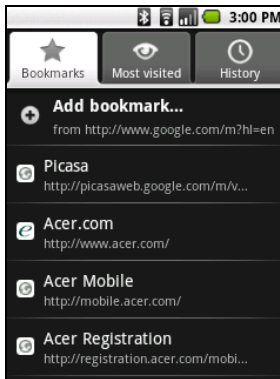
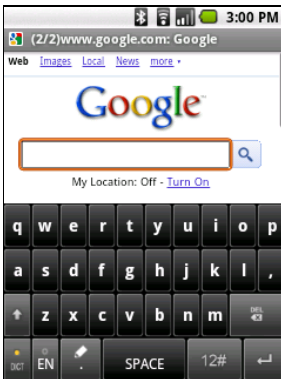

You may open multiple pages. When a page is open, press the Menu button and tap **New window** from the menu that opens. Tap **Windows** to view all the windows that are open.

You can zoom in or out of pages using the zoom bar that appears when you tap the screen. Tap and hold an item on a page to open a contextual menu.

## Setting up Email

Your smartphone enables you to access your email. Most popular ISPs can be set up in two steps. Tap the Applications tab and then **Email** to start setting up your email access.

If necessary, enter your email address and tap **Manual setup** to enter the parameters manually. Tap **Next** to finish the setup process.

The combined inbox feature of your smartphone allows you to view emails from multiple accounts in a single inbox.

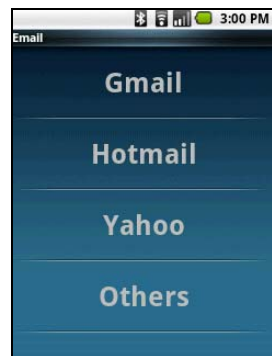

# Online applications

Your smartphone has a variety of applications installed on it from the factory.



**Note:** Applications installed may vary according to your region.

These applications may include:

- **Facebook:** View your Facebook profile and keep up-to-date with friends.
- **Maps:** Get easy-to-follow directions using Google Maps.
- **YouTube:** View the Most viewed and Most discussed video clips on YouTube.

## Android market



**Note:** The Android Market may not be available in all countries and regions.



**Note:** You need to have a Google account set up and active on your phone before you can use the Android Market.

Tap **Market** from the applications tab to open the Android Market. Here you can obtain a variety of add-on programs and applications to enhance the functionality of your smartphone. The first time you access the Android Market, you will need to read and accept the Terms of Service.

You can browse the market by category or tap the search icon to search for a specific application.

Once you have selected an application, tap the **Install** button to download and install the application. You will be told which services on your phone that the application has access to. Tap **OK** to proceed with the installation.

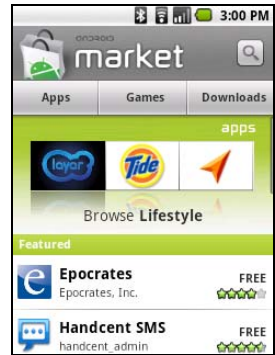

You may keep track of the download progress from the Notification Area.



**Important:** Some applications may require payment before you can download them. You will need to have a Google Checkout account in order to pay for these applications.

## Uninstalling downloaded applications

Once you've downloaded and installed an application, you may uninstall the application by tapping **Settings** from the Applications tab. Select **Applications > Manage applications**. Tap the application you wish to uninstall, tap **Uninstall** and confirm the uninstall.



# Chapter 7: Using the Camera

---

Your smartphone features a 3-megapixel digital camera mounted on the rear. This section will take you through all the steps in taking photos and videos with your smartphone.









.....  
**Note:** You need to have a microSD Card inserted into the microSD Card slot before using the camera.  
.....

To activate the camera, open the Applications tab and tap **Camera**.

## Camera icons and indicators



In the camera window, use the zoom slider at the bottom of the screen to adjust the zoom. Tap  to take a picture.

Icon	Description
	Indicates the last photo taken.
	Slide to adjust brightness.
	Slide to switch between camcorder and photo mode.
	Shutter button. Tap to take the photo. Changes to <b>Record</b> or <b>Stop</b> in video mode.
	Tap to zoom in or out.

# Camera settings menu

Tap the **Menu** button to open the Camera settings menu.

- Store location picture
- Jpeg quality
- Prompt after capture
- Grid
- Enable shutter sound
- Antibanding
- Resolution
- White balance / lighting
- Select effect
- Scene mode
- Flash mode

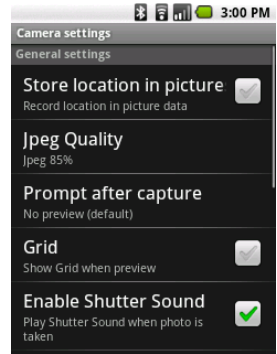

## Taking a photo

1. Ensure you have adjusted the parameters described above.
2. Frame your subject and steady your smartphone.
3. Zoom in or out as needed.
4. Tap  to take a picture.

## Shooting a video

To turn on camcorder mode, tap the Menu button and Select **Switch to video**.

1. Frame your subject and steady your smartphone and zoom in or out as needed.
2. Tap the **Record** button to begin recording. Tap again to stop recording.

## Supported formats

Type	Formats
Image	JPEG
Video	MPEG-4, H.263

## Viewing photos and videos

After you have taken your photo or video, it is automatically saved.

Once you have taken a photo or video, you can view it in Gallery by tapping the thumbnail icon in the upper right corner. Alternatively, open the Applications tab and tap **Gallery**. From Gallery you can share the file directly using various services.



**Note:** Share options vary depending on the file type.

# Chapter 8: Advanced Settings

## Putting your smartphone in Airplane mode

You can enter Airplane mode (also known as flight mode) to turn off telephone and Bluetooth functions and use your smartphone as a handheld device during a flight. Check with your airline to make sure this is permitted onboard.

Switch your smartphone off during takeoff and landing as it may interfere with aircraft electronic systems.

## Turning Airplane mode on or off



**Note:** When Airplane mode is active, the  icon will be displayed in the Notification area.

1. Press and hold the power button until you get the phone options menu.
2. Tap **Airplane mode** to switch it ON or OFF.

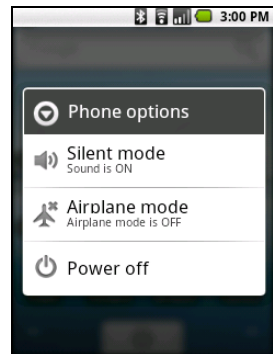

## Acer Settings

Acer Settings is a convenient all-in-one place for you to adjust commonly-used settings on your phone. Open the Applications tab and tap **Acer Settings**.

From this screen you can turn Bluetooth on or off or adjust their settings by tapping .

You can also set your **Phone network settings**, set the screen **Brightness** or **Screen Timeout**.



**Important:** If your phone is in Airplane mode, the option to turn Bluetooth on will be disabled. Please refer to **“Putting your smartphone in Airplane mode” on page 27** for instructions on turning Airplane mode on or off.

# Activating or deactivating connections

Open the Applications tab and tap **Settings > Wireless controls** to manage your connection settings.

Each connection icon will be highlighted when turned on.

## Phone network settings

Tap **Mobile networks** to adjust your network settings. You can turn data connection on or off when roaming, restrict the connection to 2G networks only, specify a network operator and define access point names. Please refer to **“Selecting a network” on page 29**.

## Adjusting connection settings

This section will show you how to adjust detailed settings for your phone, data, Wi-Fi and Bluetooth connections.

Item	Description
Wi-Fi	Turn the Wi-Fi function on or off.
Wi-Fi settings	Set up and manage your wireless access points.
Bluetooth	Turn the Bluetooth function on or off.
Bluetooth settings	Manage your Bluetooth connections, set a device name and discoverability.
Mobile networks	Set your options for connecting to mobile networks.
Airplane mode	Disable all wireless connections so you can safely use this device onboard an aircraft.

## Sound & display

Once you have inserted a SIM card, your smartphone will automatically detect your network provider.

You can adjust your phone settings by tapping **Settings > Sound & display**.

Item	Description
Silent mode	Turn off all sounds except for alarms and media.
Ringer volume	Adjust the ringer volume.
Media volume	Set the playback volume for media.
Phone ringtone	Set your phone's ringtone.
Phone vibrate	Turn the vibrate function on.
Notification ringtone	Set a ringtone for notifications.
Audible touch tones	Play tones when using dial pad.
Audible selection	Play a sound whenever a screen selection is made.
SD card notifications	Play a sound for SD card notifications.
Orientation	Switch screen orientation when the smartphone is rotated.
Animation	Animate when opening or closing windows.

Item	Description
Brightness	Adjust screen brightness.
Screen timeout	Set a delay before the screen will be turned off.
Notification LED	Turns notification LED indicators on or off.

## Selecting a network

Your phone will automatically detect your carrier/network settings when you insert a new SIM card. However, you may prefer to manually select a network. This may be a good idea when roaming.



.....  
**Tip:** When you are traveling, manually selecting a network may help to reduce your roaming charges. Check with your home service provider for the network offering the most competitive rates at your destination.  
 .....

1. Open the Applications tab and tap **Settings > Wireless controls > Mobile networks > Network operators**.
2. Your phone will search for available networks.
3. Select your preferred network from the list generated. Your phone will attempt to register on the selected network.
4. Tap **Select automatically** to connect to the available network with the strongest signal. This may lead to your phone jumping between networks when you move around.



.....  
**Note:** Contact your service provider should you have any problems obtaining voice mail and the text message service center numbers.  
 .....

## Adjusting Bluetooth settings

You can use Bluetooth to exchange information between your smartphone and other mobile devices.

### Bluetooth connections

For all Bluetooth settings, open the Applications tab and tap **Settings > Wireless controls > Bluetooth settings**. Here you can switch Bluetooth on or off, set a device name and discoverability. Tap **Scan for devices** to scan for available devices.

To connect to a device, tap the device in the list of available devices. You may be asked to enter a PIN on both devices to establish the connection.

## Phone settings

Many phone settings are automatically configured by your smartphone when you insert a SIM card. The device will communicate with your provider and automatically obtain all necessary settings, such as network name, voice mail and text message center numbers.

You can also view and modify these settings manually through the Phone Settings screen.

Open the Applications tab and tap **Settings > Call settings**.

## urFooz

urFooz is your portable profile that lives where you live.

- **Fooz Creator** lets you create a Fooz avatar, which is your virtual look-a-like.
- **Fooz World** lets you edit and manage your Fooz avatar(s), create new avatars and share them on Facebook, MySpace, blogs and more.
- **Share it** lets you post your Fooz card to Facebook, MySpace and other social networks. You can also email it to your friends.

You can email your Fooz card to friends, or post it to your social networks and blogs and always be connected.

## Launching urFooz

To launch urFooz, tap **UrFooz** from the applications tab.

## Creating your urFooz avatar

If you have not yet set up an account to urFooz, tap the **Get Started** button. If you have an existing urFooz account, select Sign in and login with your email and password.

To start creating your avatar, select your Gender, Ethnicity, Zodiac Sign, Relationship Status and Areas of Interest.

Next, start customizing your avatar. Tap **Features** to choose your face shape, eyes, nose, mouth and other facial features. Select **Clothing** to dress your savatar. Select **Accessories** to choose other items such as earrings, headbands, and whatever else to give your Fooz avatar your personal touch. Simply tap the image to apply the item to your avatar and preview how it looks on the left side of the screen.

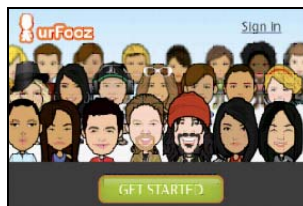

Select **SAVE** and type in a name for your Fooz avatar. The next screen will ask you for the email address, password, and required user information. The email and password you enter will be used to sign into your urFooz account.

## Managing your avatar

Now that you have created your Fooz avatar, go to Fooz World and personalize your Fooz card, or your portable profile.

Select **Profile/Apps** to fill in your profile and other information such as bookmarks of your social network profiles and favorite websites.



Select **Switch Avatar** to change your default avatar, modify existing avatars, or create a new avatar.

## Sharing your Fooz card and avatar

urFooz lets you share your Fooz card with friends by posting it to your social networks, blogs, and websites; or emailing it to friends.

In Fooz World, select Share it. Select Post to post your Fooz card to Facebook or other social networks, or select Email to email your Fooz card to a friend.



**Note:** Fuhu, Spinlets, Spinlet, urFooz, Fooz Avatars, Fooz Creator, Fooz Card, and Fooz World are trademarks or registered trademarks of Fuhu, Inc. in the U.S. and/or other countries.

## Connecting to a PC

If you wish to transfer information between the microSD Card in your phone and your computer, you can connect your phone to a PC using the supplied USB cable. Plug the USB sync cable into the micro USB connector on your smartphone. Plug the USB client connector into an available USB port on your computer.

Pull down the notification bar, and tap **USB Connected**. Click **Mount**.

You will now be able to see the microSD Card in your phone as a drive in your computer's file explorer.



**Note:** After mounting, you will not be able to access the files in the microSD card or applications such as Gallery or Music.

## Synchronizing your calendar

You can sync your calendar on your phone with your Google calendar. Tap **Calendar** from the Applications tab to connect to your Google calendar and sync appointments.



**Note:** You need a Google account to sync your calendar and appointments.

# Managing your calendar

The Calendar allows you to keep track of your events and tasks. You can access it by tapping **Calendar** on the home screen or in the Applications tab.

The Calendar offers a variety of viewing modes and settings to manage your events. Tap **Menu** and you will see the following options:

- Agenda
- Day
- Week
- Month
- New event
- Today
- More
  - Hide declined events
  - Set alerts & notifications
  - Select ringtone
  - Vibrate
  - Set default reminder



## Adding a new event

To add a new event, tap **Menu** and tap **New event**. Under Event details you have the option of filling out:

- Event name
- From – Date and time
- To – Date and time
- Location
- Description
- Repetition
- Reminder intervals

## GPS tracker

The GPS tracker will determine the precise location of the device at regular intervals.

The tracker provides information on GPS time, tracking distance, moving speed, trackers, and point of interest (POI).

You can track your location by tapping . You can also pause, mark a POI () and save your progress by tapping on the diskette.

Tapping **Menu** provides additional settings:

- Mode – (adjust data gathering intervals)
  - Walk – 6-second intervals
  - Bicycle – 4-second intervals
  - Car – 2-second intervals
- Format – Saved file format
- Save to path
- Hide





# FM radio

The FM radio allows you to listen to your favorite stations while on the move. Headphones must be inserted to the 3.5 mm jack as it functions as an antenna.

You can access the radio by tapping **Radio** from the Applications tab. Once the application is open, turn the radio on by tapping **Menu** and **Turn on**. You can now leave the radio application and use other functions of the smartphone and listen to your station.

To turn the radio off, return to the radio application and tap **Menu** and **Turn off**.

Other functions are available through the Menu such as:

- Mute
- Set frequency
- Scan
- Save
- More
  - Speaker on
  - RDS
  - Station list
  - Send station info



## Multimedia playback

Your smartphone comes supplied with a variety of programs that you can use to enjoy multimedia content.

### nemoPlayer

Open **nemoPlayer** from the applications tab to play media you have stored on your phone.

nemoPlayer enables you to listen to music, view video clips and pictures in the following formats.

Type	Formats
Audio playback	MP3, AMR, WMA
Ringtone	MP3, MIDI, iMelody, WAVE, WMA
Video recording	3GP, MPEG-4, H.263
Video playback	3GP, MPEG-4, H.263, H.264, WMV



.....  
**Note:** Music recognition technology and related data are provided by Gracenote®. Gracenote®, Gracenote logo and logotype, and the "Powered by Gracenote" logo are either a registered trademark or a trademark of Gracenote, Inc. in the United States and/or other countries.  
.....

# Spinlets

Spinlets gives you access to your favorite music, movie and television content. Get your favorite music, photos and videos from your mobile phone and share your favorite Spinlets on social networks, websites and more.



.....  
**Note:** Some contents may not be available in some countries.  
.....

## Launching Spinlets

To launch the Spinlets application, tap **Spinlets** in the applications tab.

## Browsing Spinlets gallery

You can sort or search your media content by albums or genres.

### Browsing albums

Once Spinlets is opened, you will see a display of featured albums. Browse this display by sliding your finger horizontally (left or right), and select an album by tapping it.

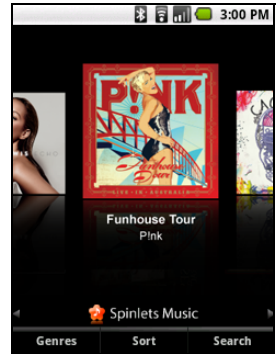

### Browsing genres

To browse the Gallery by genre, tap the **Genres** button on the bottom left corner of the screen. You will see a new screen with a list of different genres. Tap on the genre you wish to view.

### Sort

To sort through Spinlets by Name, Ratings, or Newest content, select the Sort button at the bottom of the screen.

### Search

To search the Gallery for a specific name, select the Search button at the bottom right corner of the screen. Type the name of an artist in the search box and find potential matches.

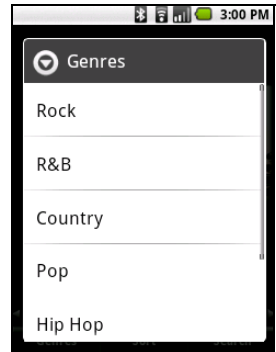

## Exploring Spinlets widgets

When you select an album, you will see a Spinlet.

To play the featured song, select the red **Play** button.

To play selected songs, select the Music tab and choose which songs you would like to play.

To view artist photos, select the Photos tab.

To visit the artist's social networks and websites, select the icons located along the bottom of the screen.

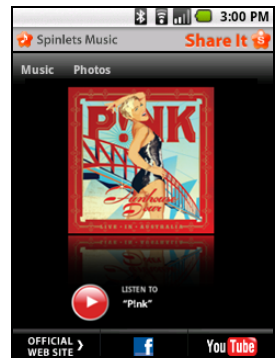

## Sharing your Spinlets

You can share your favorite Spinlets in two ways.

To post the Spinlet you are currently viewing to your social networks, blogs, or other websites, tap **Share It** at the top right corner of the Spinlet. Select **Post it** and tap the icon of the social network site or blog you want to post the widget to. Log in to your social network account or blog page and follow the steps.

You can also share Spinlets through email. Tap **Share It** at the top right corner, select **Send it**, and enter your name and your friend's email address.

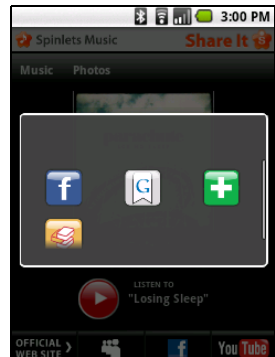

**Note:** Fuhu, Spinlets, Spinlet, urFooz, Fooz Avatars, Fooz Creator, Fooz Card, and Fooz World are trademarks or registered trademarks of Fuhu, Inc. in the U.S. and/or other countries.

## Adjusting the volume

Adjust the volume of your phone using the volume button on the side of the phone. Alternatively, you can set the **Ringer volume** and **Media volume** by opening the Applications tab and going to **Settings > Sound & display**.

## Setting the date and time

To set the date and time, open the Applications tab and tap **Settings > Date & time**.



**Tip:** If you travel frequently or live in an area that uses daylight saving time, activate **Automatic** from this menu. This will enable your smartphone to set the date and time based on information it receives from the network.

## Setting alarms

There are three predefined alarms on your phone by default. To edit alarm settings, tap **Alarm Clock** in the Applications tab. You may:

- Turn the alarm on or off.
- Set the alarm time.
- Set a ringtone.
- Enable or disable vibrate.
- Set which days to repeat the alarm.
- Give it a label.



## Changing location and text options

Set your location and language input preferences by opening the Applications tab and going to **Settings > Locale & text**.

## Managing applications



.....  
**Warning! Make sure you trust the source of any program you install. If you are not sure of the source, do not install a program. Installing programs from unknown sources increases your risk of virus attacks and theft of personal and private data.**  
.....

You can remove programs installed on your smartphone to free up extra storage memory. Open the Applications tab and go to **Settings > Applications**.

Here you can allow programs from **Unknown sources** to be installed and **Manage applications**.



.....  
**Warning! You should only remove programs if you are familiar with the Android operating system.**  
.....

## Resetting your smartphone

You may have to perform a reset if your smartphone fails to respond when buttons are pressed or the screen is tapped.



.....  
**Note:** Before performing a reset, ensure that your smartphone is not locked. Press any key or tap the screen to see if the phone responds.  
.....

# Clean boot

A clean boot will restore your smartphone to the factory settings.



.....  
**Warning! You should only perform a clean boot when all other options have failed to restore your smartphone to an operational state.**  
.....



.....  
**Warning! This will erase all your personal information, any contacts stored on your phone and any programs you installed.**  
.....

## If your phone is responding to screen input

Open **Settings** from the Applications tab, then tap **Privacy > Factory data reset**; click **Reset phone** and then **Erase everything** to format your phone.

# Chapter 9: Accessories and Tips

---

This chapter shows you how to use accessories with your smartphone, as well as provide useful tips for when you are using your smartphone.

## Using the headset

Your smartphone comes packaged with a headset with built-in microphone for handsfree use when making calls.

To use the headset, plug it into the 3.5 mm headphone jack at the top of the phone.

When the headset is plugged in, all audio is routed to the headset, and the speakers are turned off.

- To answer an incoming call, press the button on the microphone.
- Adjust the volume using the volume up/down button on the smartphone.
- End the call by pressing the button again.

## Using a Bluetooth headset

Your smartphone's Bluetooth functions make it fully compatible with all Bluetooth headsets. This allows you to use the unit handsfree when making calls, without the inconvenience of wires.

## Using your smartphone as a modem

When connected to the PC, your smartphone can function as a modem via GPRS or 3G connection.

When you insert your SIM card, please ensure the data connection setting is enabled. Click **Settings > Wireless controls > Mobile networks > Data enabled**.

Your phone will automatically configure itself to use your provider's GPRS/3G/EDGE service.



.....  
Note: You may incur additional charges depending on your data plan.  
.....

## Setting up the modem on your PC

Connect your smartphone to a PC via USB, and do the following steps:

1. Install **Acer PC Suite** on your PC or notebook.
2. After the installation is complete, click **Start > All Programs > Acer > Acer PC Suite > Acer PC Suite** to launch the application.
3. Click **Easylink** to run Easy link.
4. Click **Select Device**.
5. Click **Refresh** in the Select Device window to detect a standard modem port. Select the port and click **Select**.

6. Click **Connect** to start dialing up to data network.



.....  
**Note:** If the connection fails, restart and reconnect your smartphone to your PC, and then repeat the installation.  
.....



.....  
**Note:** Updates are available at the Acer website. Visit <http://mobile.acer.com>.  
.....

## Creating a new access point

When you need to add another GPRS/3G/EDGE connection on your phone, obtain the access point name and settings (including username and password if required) from your wireless service provider.

1. Open the Applications tab and tap **Settings > Wireless controls > Mobile networks > Access Point Names**.
2. Press the Menu button and tap **New APN**.
3. Enter the APN settings. Tap an item to adjust it.
4. When you have finished press the Menu button and tap **Save**.



.....  
**Important:** Some providers and countries do not allow the use of a smartphone as a modem over HSDPA. Please check with your provider before attempting to do so.  
.....

## Inserting a microSD Card

Your smartphone features a memory expansion slot that accepts a microSD Card to expand memory and storage capacity.

Please refer to **"Installing a SIM and microSD Card"** on **page 11** for instructions on installing a microSD Card.

# Chapter 10: Appendix

---

## FAQ and troubleshooting

This section lists frequently asked questions that may arise during the use of your smartphone, and gives easy answers and solutions to these questions.

Aspect	Question	Answer
Audio	Why is there no sound coming from the device?	If the headset is plugged into the device, the speaker is automatically shut off. Disconnect the headset.  Check that the device volume setting is not muted.  Check that the volume control is not at its lowest setting.
Multimedia files	Why can't I view my picture files?	You may be trying to view an image that is not supported. Refer to <b>"Multimedia"</b> on <b>page 46</b> for more information.
	Why can't I view my video files?	You may be trying to view a video that is not supported. Refer to <b>"Multimedia"</b> on <b>page 46</b> for more information.
	Why can't I play my music files?	You may be trying to play a file that is not supported. Refer to <b>"Multimedia"</b> on <b>page 46</b> for more information.
System information and performance	How do I check the OS version of my device?	Tap <b>Menu &gt; Settings &gt; About phone</b> to check the OS version (Kernel/build number) and other hardware and software information.
Power	I couldn't turn on the device.	The battery power may be depleted. Recharge the device. Refer to <b>"Charging the battery"</b> on page 10 for more information.
Heat	The phone heats up when charging or making long duration calls.	It is normal for the phone to heat up when charging. When charging is complete, it will return to its normal temperature.  It is also normal for the phone to heat up during long periods of use, such as watching a video or a long phone conversation.  All Acer phones are factory tested before release.

## Other sources of help

### For information on:

Up-to-date information regarding your smartphone

[www.acer.com](http://www.acer.com)  
<http://mobile.acer.com>

Service enquiries

[www.acer.com/support](http://www.acer.com/support)



# ADB

1. Set up the network configuration for the USB Ethernet device:
  - IP address: 192.168.239.5
  - Subnet mask: 255:255:255:0
2. Add ADBHOST to the PC environment variable.
  - Variable name: ADBHOST
  - Variable value: 192.168.239.4
3. Connect the smartphone via USB to the PC. Execute the following commands before running adb.
  - adb kill-server
  - adb devices

## Warnings and precautions

- Do not use this product near water.
- Do not place this product on an unstable cart, stand or table. If the product falls, it could be seriously damaged.
- Slots and openings are provided for ventilation to ensure reliable operation of the product and to protect it from overheating. These openings must not be blocked or covered. The openings should never be blocked by placing the product on a bed, sofa, rug or other similar surface. This product should never be placed near or over a radiator or heat register, or in a built-in installation unless proper ventilation is provided.
- Never push objects of any kind into this product through cabinet slots as they may touch dangerous voltage points or short-out parts that could result in a fire or electric shock. Never spill liquid of any kind onto or into the product.
- To avoid damage of internal components and to prevent battery leakage, do not place the product on a vibrating surface.
- Never use this product when engaging in sporting activities, exercising, or in any vibrating environment which may cause a short circuit or damage, and even a risk of explosion from the battery pack.

### CAUTION when listening to music

To protect your hearing, follow these instructions.

- Increase the volume gradually until you can hear clearly and comfortably.
- Do not increase the volume level after your ears have adjusted.
- Do not listen to music at high volumes for extended periods.
- Do not increase the volume to block out noisy surroundings.
- Decrease the volume if you can't hear people speaking near you.

### Battery information

This product uses a Lithium-ion battery. Do not use it in a humid, wet and/or corrosive environment. Do not put, store or leave your product in or near a heat source, in a high temperature location, in strong direct sunlight, in a microwave oven or in a pressurized container, and do not expose it to temperatures over 60 °C (140 °F). Failure to follow these guidelines may cause the battery to leak acid, become hot, explode or ignite and cause injury and/or damage. Do not pierce, open or disassemble the battery. If the battery leaks and you come into contact with the leaked fluids, rinse thoroughly with water and

seek medical attention immediately. For safety reasons, and to prolong the lifetime of the battery, charging will not occur at low (below 0 °C/32 °F) or high (over 40 °C/104 °F) temperatures.

The full performance of a new battery is achieved only after two or three complete charge and discharge cycles. The battery can be charged and discharged hundreds of times, but it will eventually wear out. When the talk and standby times are noticeably shorter than normal, buy a new battery. Use only Acer approved batteries, and recharge your battery only with Acer approved chargers designated for this device.

Unplug the charger from the electrical plug and the device when not in use. Do not leave a fully charged battery connected to the ac charger, since overcharging may shorten its lifetime. If left unused, a fully charged battery will lose its charge over time. If the battery is completely discharged, it may take a few minutes before the charging indicator appears on the display or before any calls can be made.

Use the battery only for its intended purpose. Never use any charger or battery that is damaged.

Do not short-circuit the battery. Accidental short-circuiting can occur when a metallic object such as a coin, clip, or pen causes direct connection of the positive (+) and negative (-) terminals of the battery. (These look like metal strips on the battery.) This might happen, for example, when you carry a spare battery in your pocket or purse. Short-circuiting the terminals may damage the battery or the connecting object.

Leaving the battery in hot or cold places, such as in a closed car in summer or winter conditions, will reduce the capacity and lifetime of the battery. Always try to keep the battery between 15 °C and 25 °C (59 °F and 77 °F). A device with a hot or cold battery may not work temporarily, even when the battery is fully charged. Battery performance is particularly limited in temperatures well below freezing.

Do not dispose of batteries in a fire as they may explode. Batteries may also explode if damaged. Dispose of batteries according to local regulations. Please recycle when possible. Do not dispose as household waste.

## Replacing the battery pack

Your smartphone uses lithium batteries. Replace the battery with the same type as that which came bundled with your product. Use of another battery may present a risk of fire or explosion.



.....  
**Warning! Batteries may explode if not handled properly. Do not disassemble or dispose of them in fire. Keep them away from children. Follow local regulations when disposing of used batteries.**  
.....

## Additional safety information

Your device and its enhancements may contain small parts. Keep them out of the reach of small children.

## Operating environment



.....  
**Warning! For safety reasons, turn off all wireless or radio transmitting devices when using your smartphone device under the following conditions. These devices may include, but are not limited to: Bluetooth and/or 3G.**  
.....

Remember to follow any special regulations in force in any area, and always switch off your device when its use is prohibited or when it may cause interference or danger. Use the device only in its normal operating positions. Do not cover the antenna with metal and you should position the device at the above-stated distance from your body. To successfully transmit data files or messages, this device requires a good quality connection to the network. In some cases, transmission of data files or messages may be delayed until such a connection is available. Ensure that the above separation distance instructions are followed until the transmission is completed. Parts of the device are magnetic. Metallic materials may be attracted to the device, and persons with hearing aids should not hold the device to the ear with the hearing aid. Do not place credit cards or other magnetic storage media near the device, because information stored on them may be erased.

## Medical devices

Operation of any radio transmitting equipment, including wireless phones, may interfere with the functionality of inadequately protected medical devices. Consult a physician or the manufacturer of the medical device to determine if they are adequately shielded from external RF energy or if you have any questions. Switch off your device in health care facilities when any regulations posted in these areas instruct you to do so. Hospitals or health care facilities may be using equipment that could be sensitive to external RF transmissions.

**Pacemakers.** Pacemaker manufacturers recommend that a minimum separation of 15.3 cm (6") be maintained between wireless devices and a pacemaker to avoid potential interference with the pacemaker. These recommendations are consistent with the independent research by and recommendations of Wireless Technology Research. Persons with pacemakers should do the following:

- Always keep the device more than 15.3 cm (6") from the pacemaker.
- Not carry the device near your pacemaker when the device is switched on. If you suspect interference, switch off your device, and move it.

**Hearing aids.** Some digital wireless devices may interfere with some hearing aids. If interference occurs, consult your service provider.

## Vehicles

RF signals may affect improperly installed or inadequately shielded electronic systems in motor vehicles such as electronic fuel injection systems, electronic antiskid (antilock) braking systems, electronic speed control systems, and air bag systems. For more information, check with the manufacturer, or its representative, of your vehicle or any equipment that has been added. Only qualified personnel should service the device, or install the device in a vehicle. Faulty installation or service may be dangerous and may invalidate any warranty that may apply to the device. Check regularly that all wireless equipment in your vehicle is mounted and operating properly. Do not store or carry flammable liquids, gases, or explosive materials in the same compartment as the device, its parts, or enhancements. For vehicles equipped with an air bag, remember that air bags inflate with great force. Do not place objects, including installed or portable wireless equipment in the area over the air bag or in the air bag deployment area. If in-vehicle wireless equipment is improperly installed, and the air bag inflates, serious injury could result. Using your device while flying in aircraft is prohibited. Switch off your device before boarding an aircraft. The use of wireless teledevices in an aircraft may be dangerous to the operation of the aircraft, disrupt the wireless telephone network, and may be illegal.

## Potentially explosive environments

Switch off your device when in any area with a potentially explosive atmosphere and obey all signs and instructions. Potentially explosive atmospheres include areas where you would normally be advised to turn off your vehicle engine. Sparks in such areas could cause an explosion or fire resulting in bodily injury or even death. Switch off the device at refueling points such as near gas pumps at service stations. Observe restrictions on the use of radio equipment in fuel depots, storage, and distribution areas; chemical plants; or where blasting operations are in progress. Areas with a potentially explosive atmospheres are often, but not always, clearly marked. They include below deck on boats, chemical transfer or storage facilities, vehicles using liquefied petroleum gas (such as propane or butane), and areas where the air contains chemicals or particles such as grain, dust or metal powders.

Follow any restrictions. Do not use the device where blasting is in progress.

## Emergency calls

Important: Wireless phones, including this device, operate using radio signals, wireless networks, landline networks, and user-programmed functions. Because of this, connections in all conditions cannot be guaranteed. You should never rely solely on any wireless device for essential communications like medical emergencies.

If certain features are in use, you may first need to turn those features off before you can make an emergency call. Consult this guide or your service provider for more information.

When making an emergency call, give all the necessary information as accurately as possible. Your wireless device may be the only means of communication at the scene of an accident. Do not end the call until given permission to do so.

## Disposal and recycling information



Do not throw this electronic device into the trash when discarding.

To minimize pollution and ensure utmost protection of the global environment, please recycle. For more information on the Waste from Electrical and Electronics Equipment (WEEE) regulations, visit

[www.acer-group.com/public/Sustainability/sustainability01.htm](http://www.acer-group.com/public/Sustainability/sustainability01.htm)

## Mercury advisory



For projectors or electronic products containing an LCD/CRT monitor or display: Lamp(s) inside this product contain mercury and must be recycled or disposed of according to local, state or federal laws. For more information, contact the Electronic Industries Alliance at [www.eiae.org](http://www.eiae.org). For lamp-specific disposal information, check [www.lamprecycle.org](http://www.lamprecycle.org).

## Taking care of your smartphone

1. **DO** take care not to scratch the screen of your smartphone. Keep the screen clean. When working with your smartphone, use your finger or fingernail. Never use an actual pen or pencil or other sharp object on the screen surface.
2. **DO NOT** expose your smartphone to rain or moisture. Do not let water enter the circuitry through the front panel buttons or expansion slots. In general, treat your smartphone as you would a mobile phone or other small electronic device.

3. **DO** be careful not to drop your smartphone or subject it to any strong impact. Do not place your smartphone in your back pocket.
4. **DO NOT** expose your smartphone to extreme temperatures. For example, do not leave your smartphone on the dashboard of a car on a hot day or when temperatures are below freezing point. Also, keep it away from heaters and other sources of heat.
5. **DO NOT** use or store your smartphone in any location that is dusty, damp or wet.
6. **DO** use a soft, damp cloth to clean your smartphone. If the surface of the screen becomes soiled, clean it with a soft cloth moistened with diluted window-cleaning solution.
7. **DO NOT** press down on the screen with force, otherwise you may crack the screen.

# Specifications

## Performance

- ST Ericsson PNX6715, 416 MHz
- System memory:
  - 256 MB of SDRAM
  - 512 MB of Flash ROM
- Google Android operating system

## Display

- 2.8" TFT-LCD resistive touchscreen
- 320 x 240 resolution
- 65K colors support

## Multimedia

- CD-quality stereo output
- Mono speaker 0.5 W (max)
- Omni-directional microphone
- Formats supported

Type	Formats
Audio playback	MP3, AMR, WMA
Ringtone	MP3, MIDI, iMelody, WAVE, WMA
Video recording	3GP, MPEG-4, H.263
Video playback	3GP, MPEG-4, H.263, H.264, WMV

## USB connector

- Micro USB connector
- USB Client
- DC power-in (5 V, 1 A)

## Connectivity

- Bluetooth 2.0+EDR
- IEEE Wi-Fi 802.11 b/g WLAN
- GSM 850 / 900 / 1800 / 1900
- UMTS 900 / 2100 (EU models)
- UMTS 850 / 1900 (US models)
- HSDPA / GPRS / EDGE

## Camera

- 3-megapixel EDOF

## Expansion

- microSD memory card (up to 32 GB)

## GPS

- Built-in GPS
- Supports AGPS

## Battery

- High density, rechargeable 1500 mAh Lithium-Ion battery (replaceable)



.....  
**Note:** Length of battery operation will depend on power consumption which is based on system resource use. For example, constantly using the backlight or using power-demanding applications will shorten battery life between charges.  
.....

## Dimensions

Height	104.5 mm
Width	54.2 mm
Thickness	13.2 mm
Weight	<105 g (with battery)

# Regulatory information

## Compliant with Russian regulatory certification



ME61

## RoHS compliance

This product is in compliance with Directive 2002/95/EC of the European Parliament and of the Council of 27 January 2003, on the restriction of the use of certain hazardous substances in electrical and electronic equipment (RoHS) and its amendments.

## LCD pixel statement

The LCD unit is produced with high-precision manufacturing techniques. Nevertheless, some pixels may occasionally misfire or appear as black or red dots. This has no effect on the recorded image and does not constitute a malfunction.

## Radio device regulatory notice



.....  
**Note:** Regulatory information below is for models with wireless LAN and/or Bluetooth only.  
.....

## General

This product complies with the radio frequency and safety standards of any country or region in which it has been approved for wireless use. Depending on configuration, this product may or may not contain wireless radio devices (such as wireless LAN and/or Bluetooth modules). Information below is for products with such devices.

## Preventing hearing loss



.....  
**Caution: Permanent hearing loss may occur if earphones or headphones are used at high volume for prolonged periods of time.**  
.....

This device has been tested to comply with the Sound Pressure Level requirement laid down in the applicable EN 50332-1 and/or EN 50332-2 standards.



**Note:** For France, mobile headphones or earphones for this device have been tested to comply with the Sound Pressure requirement laid down in the applicable NF EN 50332-1:2000 and/or NF EN 50332-2:2003 standards as required by French Article L. 5232-1.

## Wireless operation channels for different domains

N. America	2.412-2.462 GHz	Ch01 through Ch11
Japan	2.412-2.484 GHz	Ch01 through Ch14
Europe ETSI	2.412-2.472 GHz	Ch01 through Ch13

## France: Restricted wireless frequency bands

Some areas of France have a restricted frequency band. The worst case maximum authorized power indoors is:



- 10 mW for the entire 2.4 GHz band (2400 MHz - 2483.5 MHz)
- 100 mW for frequencies between 2446.5 MHz and 2483.5 MHz



**Note:** Channels 10 through 13 inclusive operate in the band 2446.6 MHz to 2483.5 MHz.

There are few possibilities for outdoor use: On private property or on the private property of public persons, use is subject to a preliminary authorization procedure by the Ministry of Defense, with maximum authorized power of 100 mW in the 2446.5 - 2483.5 MHz band. Use outdoors on public property is not permitted.

In the departments listed below, for the entire 2.4 GHz band:

- Maximum authorized power indoors is 100 mW
- Maximum authorized power outdoors is 10 mW

Departments in which the use of the 2400 - 2483.5 MHz band is permitted with an EIRP of less than 100 mW indoors and less than 10 mW outdoors:

01 Ain Orientales	25 Doubs	59 Nord	75 Paris
02 Aisne	26 Drome	60 Oise	82 Tarn et Garonne
03 Allier	32 Gers	61 Orne	84 Vaucluse
05 Hautes Alpes	36 Indre	63 Puy Du Dome	88 Vosges
08 Ardennes	37 Indre et Loire	64 Pyrenees Atlantique	89 Yonne
09 Ariege	41 Loir et Cher	66 Pyrenees	90 Territoire de Belfort
11 Aude	45 Loret	67 Bas Rhin	94 Val de Marne
12 Aveyron	50 Manche	68 Haut Rhin	
16 Charente	55 Meuse	70 Haute Saone	
24 Dordogne	58 Nievre	71 Saone et Loire	

This requirement is likely to change over time, allowing you to use your wireless LAN card in more areas within France.

Please check with ART for the latest information ([www.art-telecom.fr](http://www.art-telecom.fr)).



**Note:** Your WLAN Card transmits less than 100 mW, but more than 10 mW.

## List of National Codes

This equipment may be operated in the following countries:

Country	ISO 3166 (2 letter code)	Country	ISO 3166 (2 letter code)
Austria	AT	Malta	MT
Belgium	BE	Netherlands	NT
Cyprus	CY	Poland	PL
Czech Republic	CZ	Portugal	PT
Denmark	DK	Slovakia	SK
Estonia	EE	Slovenia	SL
Finland	FI	Spain	ES
France	FR	Sweden	SE
Germany	DE	United Kingdom	GB
Greece	GR	Iceland	IS
Hungary	HU	Liechtenstein	LI
Ireland	IE	Norway	NO
Italy	IT	Switzerland	CH
Latvia	LV	Bulgaria	BG
Lithuania	LT	Romania	RO
Luxembourg	LU	Turkey	TR

## FCC regulations

This mobile phone complies with part 15 of the FCC Rules. Operation is subject to the following two conditions: (1) This device may not cause harmful interference, and (2) this device must accept any interference received, including interference that may cause undesired operation.

This mobile phone has been tested and found to comply with the limits for a Class B digital device, pursuant to Part 15 of the FCC Rules. These limits are designed to provide reasonable protection against harmful interference in a residential installation. This equipment generates, uses and can radiated radio frequency energy and, if not installed and used in accordance with the instructions, may cause harmful interference to radio communications. However, there is no guarantee that interference will not occur in a particular installation. If this equipment does cause harmful interference to radio or television reception, which can be determined by turning the equipment off and on, the user is encouraged to try to correct the interference by one or more of the following measures:

- Reorient or relocate the receiving antenna.
- Increase the separation between the equipment and receiver.
- Connect the equipment into an outlet on a circuit different from that to which the receiver is connected.
- Consult the dealer or an experienced radio/TV technician for help.

Changes or modifications not expressly approved by the party responsible for compliance could void the user's authority to operate the equipment.

## RF exposure warning

The equipment complies with FCC RF exposure limits set forth for an uncontrolled environment.

The antenna(s) used for this transmitter must not be co-located or operating in conjunction with any other antenna or transmitter.

## RF exposure information (SAR)

This mobile phone meets the government's requirements for exposure to radio waves.

This phone is designed and manufactured not to exceed the emission limits for exposure to radio frequency (RF) energy set by the Federal Communications Commission of the U.S. Government.

The exposure standard for wireless mobile phones employs a unit of measurement known as the Specific Absorption Rate, or SAR. The SAR limit set by the FCC is 1.6 W/kg.

Tests for SAR are conducted using standard operating positions accepted by the FCC with the phone transmitting at its highest certified power level in all tested frequency bands. Although the SAR is determined at the highest certified power level, the actual SAR level of the phone while operating can be well below the maximum value. This is because the phone is designed to operate at multiple power levels so as to use only the power required to reach the network. In general, the closer you are to a wireless base station antenna, the lower the power output.

The highest SAR value for US model phones as reported to the FCC when tested for use at the ear is 1.03 W/kg and when worn on the body, as described in this user guide, is 1.07 W/kg.



**Important:** Body-worn measurements differ among phone models, depending upon available enhancements and FCC requirements.

While there may be differences between the SAR levels of various phones and at various positions, they all meet the government requirements.

The FCC has granted an Equipment Authorization for this model phone with all reported SAR levels evaluated as in compliance with the FCC RF exposure guidelines. SAR information on this model phone is on file with the FCC and can be found under the Display Grant section of [www.fcc.gov/oet/ea/fccid](http://www.fcc.gov/oet/ea/fccid) after searching on **FCC ID: HLZDME120** (for US models).

For body worn operation, this phone has been tested and meets the FCC RF exposure guidelines for use with accessories that contain no metal and that position the handset a minimum of 1.5 cm from the body. Use of other accessories may not ensure compliance with FCC RF exposure guidelines. If you do not use a body-worn accessory and are not holding the phone at the ear, position the handset a minimum of 1.5 cm from your body when the phone is switched on.

## Using your phone with a hearing aid device (US models)

Your device is compliant with the FCC Hearing Aid Compatibility (HAC) requirements. When some wireless phones are used near some hearing devices (hearing aids and cochlear implants) users may detect a buzzing, humming, or whining noise. Some hearing devices are more immune than others to this interference noise, and phones also vary in the amount of interference they generate. The wireless telephone industry has developed ratings for some of their mobile phones, to assist hearing-device users in finding phones that may be compatible with their hearing devices. Not all phones have been rated. Phones that have been rated have a label on the box. Your device has been tested for hearing aid device compatibility and has an M3 and/or T3 rating.

These ratings are not guarantees. Results will vary, depending on the level of immunity of your hearing device and the degree of your hearing loss. If your hearing device happens to be vulnerable to interference, you may not be able to use a rated phone successfully. Trying out the phone with your hearing device is the best way to evaluate it for your personal needs.

**M-Ratings:** Phones rated M3 or M4 meet FCC requirements and are likely to generate less interference with hearing devices than phones that are not labeled. M4 is the better/higher of the two ratings.

**T-Ratings:** Phones rated T3 or T4 meet FCC requirements and are likely to be more usable with a hearing device's telecoil ("T Switch" or "Telephone Switch") than unrated phones. T4 is the better/higher of the two ratings.



**Important:** This device does not support VoIP. WLAN and Bluetooth do not have voice capability for held-to-the-ear phone service.



**Note:** Not all hearing devices contain telecoils.

The more immune your hearing aid device is, the less likely you are to experience interference noise from your wireless phone. Hearing aid devices should have ratings

similar to those of phones. Ask your hearing health-care professional for the rating of your hearing aid.

Hearing devices may also be measured for immunity to this type of interference. Your hearing device manufacturer or hearing health professional may help you find results for your hearing device. The more immune your hearing aid is, the less likely you are to experience interference noise from wireless devices.

For additional information about the FCC's actions with regard to hearing aid compatible wireless devices and other steps the FCC has taken to ensure that individuals with disabilities have access to telecommunications services, please go to [www.fcc.gov/cgb/dro](http://www.fcc.gov/cgb/dro).

## Turning on Hearing Aid Compatibility mode

Open the Applications menu and tap **Settings > Call settings > Hearing aids**.

### For Canadian users

Operation is subject to the following two conditions: (1) this device may not cause interference, and (2) this device must accept any interference, including interference that may cause undesired operation of the device.

This Class B digital apparatus complies with Canadian ICES-003.

Cet appareil numérique de la classe B est conforme à la norme NMB-003 du Canada.

This Category II radiocommunication device complies with Industry Canada Standard RSS-310.

Ce dispositif de radiocommunication de catégorie II respecte la norme CNR-310 d'Industrie Canada.

### Important note

#### IC radiation exposure statement

This EUT is compliance with SAR for general population/uncontrolled exposure limits in IC RSS-102 and had been tested in accordance with the measurement methods and procedures specified in IEEE 1528. This equipment should be installed and operated with minimum distance 1.5cm between the radiator and your body.

This device and its antenna(s) must not be co-located or operating in conjunction with any other antenna or transmitter.



.....  
**Note:** The county code selection feature is disabled for products marketed in the US/Canada.  
.....

### Certificate Information (SAR)

This device meets the EU requirements (1999/519/EC) on the limitation of exposure of the general public to electromagnetic fields by way of health protection.

The limits are part of extensive recommendations for the protection of the general public. These recommendations have been developed and checked by independent scientific organizations through regular and thorough evaluations of scientific studies. To guarantee the safety of all persons, regardless of age and health, the limits include a significant safety buffer.

Before radio devices can be put in circulation, their agreement with European laws or limits must be confirmed; only then may the CE symbol be applied.

The unit of measurement for the European Council's recommended limit for mobile telephones is the "Specific Absorption Rate" (SAR). This SAR limit is 2.0 W/kg, averaged over 10 g of body tissue. It meets the requirements of the International Commission on Non-ionizing Radiation Protection (ICNIRP) and was included in the European Standard EN 50360 for mobile radio devices. The SAR regulation for mobile telephones is in line with European Standard EN 62209-1. The maximum SAR value is calculated at the highest output level in all frequency bands of the mobile telephone. During use, the actual SAR level is usually much lower than the maximum value, because the mobile telephone works in different output levels. It only transmits with as much output as is required to reach the network. In general the following applies: The closer you are to a base station, the lower the transmission output of your mobile telephone. The tested SAR of this device is as follows:

CE		NCC	
Head (W/kg 10g)	Body (W/kg 10g)	Head (W/kg 10g)	Body (W/kg 10g)
0.963	0.644	0.963	N/A

## NCC warning

### 警語

經型式認證合格之低功率射頻電機，非經許可，公司、商號或使用者均不得擅自變更頻率，加大功率或變更原設計之特性及功能。低功率射頻電機之使用不得影響飛航影響安全及干擾合法通信，經發現有干擾現象時，應立即停用，並改善至無干擾時方得繼續使用。前項合法通信，指一電信法規定作業之無線電通信。低功率射頻電機需忍受合法通信或工業、科學及醫療用電波輻射性電機設備之干擾，減少電磁波影響，請妥適使用。

## Lithium-ion battery warning



**ATTENZIONE!** Rischio di esplosione della batteria se sostituita in modo errato. Sostituire la batteria con una di tipo uguale o equivalente consigliata dalla fabbrica. Non disperdere le batterie nell'ambiente.



**VORSICHT!** Explosionsgefahr bei unsachgemäßen Austausch der Batterie. Ersatz nur durch denselben oder einem vom Hersteller empfohlenem ähnlichen Typ. Entsorgung gebrauchter Batterien nach Angaben des Herstellers.



**ADVARSEL!** Lithiumbatteri - Eksplosionsfare ved fejlagtig håndtering. Udskiftning må kun ske med batteri af samme fabrikat og type. Levér det brugte batteri tilbage til leverandøren.



**WARNING!** Explosionsfara vid felaktigt batteribyte. Använd samma batterityp eller en ekvivalent typ som rekommenderas av apparatillverkaren. Kassera använt batteri enligt fabrikantens instruktion.



**VAROITUS!** Paristo voi räjähtää, jos se on virheellisesti asennettu. Vaihda paristo ainoastaan laitevalmistajan suosittelemaan tyyppiin. Hävitä käytetty paristo valmistajan ohjeiden mukaisesti.



**ATTENTION !** Il y a danger d'explosion s'il y a remplacement incorrect de la batterie. Remplacer uniquement avec une batterie du même type ou d' un type équivalent recommandé par le constructeur. Mettre au rebut les batteries usagées conformément aux instructions du fabricant.



**ADVARSEL!** Eksplosjonsfare ved feilaktig skifte av batteri. Benytt samme batteritype eller en tilsvarende type anbefalt av apparatfabrikanten. Brukte batterier kasseres i henhold til fabrikantens instruksjoner.



Acer Incorporated

Date: June 15, 2010

### Declaration of Conformity

We, Acer Incorporated,  
of 8F., No. 88, Sec. 1, Hsin Tai Wu Rd. Hsichih Taipei Hsien 221, Taiwan  
Declare under sole responsibility that the product:  
Model: E120  
Description: Smart HandHeld

To which this declaration relates, is in conformity with the following standards and/ or other normative documents:

- EN 301 511 V9.0.2
- EN 300 328 V1.7.1
- EN 301 908-1/-2 V3.2.1
- EN 300 440-1 V1.5.1/ EN300 440-2 V1.3.1
- EN 301 489-1 V1.8.1/ -3 V1.4.1/ -7 V1.3.1/ -17 V2.1.1/ -24 V1.4.1
- EN 55022:2006/A1:2007 Class B; EN 55024:1998/A1:2001/A2:2003
- EN 55013:2001/A1:2003/A2:2006;
- EN 60950-1: 2006+A11:2009
- EN 50332-1:2000/ -2: 2003
- EN 50360:2001/ EN 62209-1:2006/ EN62311:2008/ OET65C

We hereby declare that the above named product is in conformance to all the essential requirements of the R&TTE Directive (99/5/EC) issued by the Commission of the European Community.  
The conformity assessment procedure referred to in Article 10 and detailed in Annex [IV] of directive 1999/5/EC has been followed related to Articles

- R&TTE Article 3.1 (a) Health and Safety
- R&TTE Article 3.1 (b) EMC
- R&TTE Article 3.2 Spectrum Usage

with the involvement of the following Notified Body:

**CETECOM, Untertuerkheimer Str. 6 – 10 66117 Saarbruecken**

Identification mark: **0682** (Notified Body) CE

The technical documentation relevant to the above equipment will be held at:

Acer Incorporated  
8F., No. 88, Sec. 1, Hsin Tai Wu Rd. Hsichih Taipei Hsien 221, Taiwan  
Authorized Person:

Name: Harriot S.L. Lee

	<b>B</b>	
battery		
charging .....		10
information .....		47
Bluetooth		
connections .....		29
headset .....		38
	<b>C</b>	
call history .....		17
calls		
answering .....		18
ending .....		18
onscreen options .....		18
rejecting .....		18
camera		
icons and indicators .....		25
information .....		46
shooting a video .....		26
supported formats .....		26
taking a photo .....		26
conference calls .....		19
connectivity .....		46
contacts		
adding .....		16
making calls to a contact .....		18
saving a dialed number .....		19
	<b>D</b>	
display .....		46
	<b>E</b>	
email .....		23
	<b>F</b>	
FAQs .....		40
FM radio .....		33
	<b>G</b>	
Google .....		12

GPS tracker .....		32
	<b>H</b>	
help		
sources .....		40
	<b>I</b>	
international numbers .....		18
	<b>L</b>	
LED indicators .....		9
	<b>M</b>	
managing your calendar .....		32
MMS messages .....		21
	<b>O</b>	
onscreen keyboard .....		13
	<b>P</b>	
performance .....		46
phone		
connections .....		29
settings .....		29
	<b>S</b>	
safety regulations .....		41
speakerphone .....		18
specifications .....		46
spinlets .....		34
	<b>T</b>	
troubleshooting .....		40
turning on .....		12
	<b>U</b>	
urFozz .....		30
USB connector .....		46
	<b>V</b>	
voice calls		
the voice call screen .....		18
volume		
adjusting .....		35