

Nokia 3250 User Guide



9244344

Issue 2

DECLARATION OF CONFORMITY

Hereby, NOKIA CORPORATION declares that this RM-38 product is in compliance with the essential requirements and other relevant provisions of Directive 1999/5/EC. A copy of the Declaration of Conformity can be found at http://www.nokia.com/phones/declaration_of_conformity/

CE 0434



The crossed-out wheeled bin means that within the European Union the product must be taken to separate collection at the product end-of-life. This applies to your device but also to any enhancements marked with this symbol. Do not dispose of these products as unsorted municipal waste. For more information, see product Eco-Declaration or country specific information at www.nokia.com.

Copyright © 2006 Nokia. All rights reserved.

Reproduction, transfer, distribution or storage of part or all of the contents in this document in any form without the prior written permission of Nokia is prohibited.

Nokia, Visual Radio, Nokia Connecting People, and Pop-Port are trademarks or registered trademarks of Nokia Corporation. Other product and company names mentioned herein may be trademarks or tradenames of their respective owners.

Nokia tune and Visual Radio are sound marks of Nokia Corporation.



This product includes software licensed from Symbian Software Ltd.
© 1998–2006. Symbian and Symbian OS are trademarks of Symbian Ltd.



Includes RSA BSAFE cryptographic or security protocol software from RSA Security.



Java™ and all Java-based marks are trademarks or registered trademarks of Sun Microsystems, Inc.

US Patent No 5818437 and other pending patents. T9 text input software
Copyright © 1997–2006. Tegic Communications, Inc. All rights reserved.

This product is licensed under the MPEG-4 Visual Patent Portfolio License (i) for personal and noncommercial use in connection with information which has been encoded in compliance with the MPEG-4 Visual Standard by a consumer engaged in a personal and noncommercial activity and (ii) for use in connection with MPEG-4 video provided by a licensed video provider. No license is granted or shall be implied for any other use. Additional information, including that related to promotional, internal, and commercial uses, may be obtained from MPEG LA, LLC. See <http://www.mpegla.com>.

Nokia operates a policy of continuous development. Nokia reserves the right to make changes and improvements to any of the products described in this document without prior notice.

Under no circumstances shall Nokia be responsible for any loss of data or income or any special, incidental, consequential or indirect damages howsoever caused.

The contents of this document are provided 'as is'. Except as required by applicable law, no warranties of any kind, either express or implied, including, but not limited to, the implied warranties of merchantability and fitness for a particular purpose, are made in relation to the accuracy, reliability or contents of this document. Nokia reserves the right to revise this document or withdraw it at any time without prior notice.

The availability of particular products may vary by region. Check with the Nokia dealer nearest to you.

This device may contain commodities, technology, or software subject to export laws and regulations from the US and other countries. Diversion contrary to law is prohibited.

9244344/Issue 2

Contents

For your safety	6	Predictive text input	31
General information	9	Copy and delete text.....	32
Overview of functions.....	9	5. Messaging	33
Access codes.....	9	Write and send messages.....	34
Configuration settings service	10	Inbox—receive messages.....	36
Download content and applications	11	My folders.....	37
Nokia support and contact information	11	Mailbox.....	38
		Outbox	40
1. Get started	12	View messages on the SIM card....	40
Insert a SIM card and battery	12	Cell broadcast	40
Insert a microSD card	14	Service command editor.....	41
Remove the microSD card	14	Messaging settings.....	41
Charge the battery.....	15	6. Contacts	47
Switch the phone on and off.....	15	Manage contacts	47
Set time and date	15	Manage contact groups.....	47
Normal operating position	16	Add a ringing tone.....	48
Attach a wrist strap	16	Assign speed dialing keys.....	48
2. Your phone	17	7. Gallery	50
Keys and parts.....	17	Gallery functions.....	50
Mechanical modes.....	18	Download files	51
Standby mode.....	19	8. Music	52
Indicators	20	Music player.....	52
Scroll and select with the joystick.	21	Visual Radio.....	54
Menu	21	9. Media	60
Help.....	22	Camera.....	60
Tutorial.....	22	RealPlayer	61
Volume control	23	Recorder	62
Keypad lock (keyguard)	23	Flash Player.....	63
		Video editor	64
3. Call functions	24	10. Services	67
Make a call	24	Basic steps for access.....	67
Answer or reject a call.....	26	Set up the phone for the browser service	67
Log.....	27	Make a connection.....	68
4. Write text	30		
Traditional text input.....	30		

View bookmarks.....	68	Application manager.....	99
Connection security.....	69	Activation keys.....	101
Browse Web pages.....	70	Device manager.....	101
Download.....	71	Transfer.....	102
End a connection.....	71		
Empty the cache.....	71	14. Connectivity.....	104
Browser settings.....	72	PC Suite.....	104
		Bluetooth connection.....	104
11. My own.....	74	Instant messaging.....	108
Themes.....	74	Connection manager.....	114
Sound meter.....	75	Push to talk.....	115
		Remote synchronization.....	122
12. Organizer.....	76	USB data cable.....	124
Clock.....	76		
Calendar.....	77	15. Battery information.....	125
Converter.....	79	Charging and discharging.....	125
Notes.....	80	Nokia battery authentication	
Calculator.....	80	guidelines.....	126
File manager.....	81		
Memory card.....	81	Care and maintenance.....	128
13. Tools.....	84	Additional safety	
Voice commands.....	84	information.....	129
Voice mailbox.....	84		
Speed dial.....	85	Index.....	133
Profiles.....	85		
Settings.....	86		

For your safety

Read these simple guidelines. Not following them may be dangerous or illegal. Read the complete user guide for further information.



SWITCH ON SAFELY

Do not switch the phone on when wireless phone use is prohibited or when it may cause interference or danger.



ROAD SAFETY COMES FIRST

Obey all local laws. Always keep your hands free to operate the vehicle while driving. Your first consideration while driving should be road safety.



INTERFERENCE

All wireless phones may be susceptible to interference, which could affect performance.



SWITCH OFF IN HOSPITALS

Follow any restrictions. Switch the phone off near medical equipment.



SWITCH OFF IN AIRCRAFT

Follow any restrictions. Wireless devices can cause interference in aircraft.



SWITCH OFF WHEN REFUELING

Do not use the phone at a refueling point. Do not use near fuel or chemicals.



SWITCH OFF NEAR BLASTING

Follow any restrictions. Do not use the phone where blasting is in progress.



USE SENSIBLY

Use only in the normal position as explained in the product documentation. Do not touch the antenna unnecessarily.



QUALIFIED SERVICE

Only qualified personnel may install or repair this product.



ENHANCEMENTS AND BATTERIES

Use only approved enhancements and batteries. Do not connect incompatible products.

**WATER-RESISTANCE**

Your phone is not water-resistant. Keep it dry.

**BACK-UP COPIES**

Remember to make back-up copies or keep a written record of all important information stored in your phone.

**CONNECTING TO OTHER DEVICES**

When connecting to any other device, read its user guide for detailed safety instructions. Do not connect incompatible products.

**EMERGENCY CALLS**

Ensure the phone is switched on and in service. Press the end key as many times as needed to clear the display and return to the start screen. Enter the emergency number, then press the call key. Give your location. Do not end the call until given permission to do so.

■ About your device

The wireless device described in this guide is approved for use on the GSM 900/1800/1900 network. Contact your service provider for more information about networks.

When using the features in this device, obey all laws and respect privacy and legitimate rights of others, including copyright.

When taking and using images or video clips, obey all laws and respect local customs as well as privacy and legitimate rights of others.



Warning: To use any features in this device, other than the alarm clock, the device must be switched on. Do not switch the device on when wireless device use may cause interference or danger.

■ Network services

To use the phone you must have service from a wireless service provider. Many of the features in this device depend on features in the wireless network to function. These network services may not be available on all networks or you may have to make specific arrangements with your service provider before you can utilize network services. Your service provider may need to give you additional instructions for their use and explain what charges will apply. Some networks may have limitations that affect how you can use network services. For instance, some networks may not support all language-dependent characters and services.

Your service provider may have requested that certain features be disabled or not activated in your device. If so, they will not appear on your device menu. Your device may also have been specially configured. This configuration may include changes in menu names, menu order, and icons. Contact your service provider for more information.

This device supports WAP 2.0 protocols (HTTP and SSL) that run on TCP/IP protocols. Some features of this device, such as Web browsing, e-mail, push to talk, instant messaging, and multimedia messaging, require network support for these technologies.

■ Enhancements, batteries, and chargers

Check the model number of any charger before use with this device. This device is intended for use when supplied with power from the AC-3 or AC-4 charger. This device uses BP-6M batteries.



Warning: Use only batteries, chargers, and enhancements approved by Nokia for use with this particular model. The use of any other types may invalidate any approval or warranty and may be dangerous.

For availability of approved enhancements, please check with your dealer. When you disconnect the power cord of any enhancement, grasp and pull the plug, not the cord.

A few practical rules about accessories and enhancements:

- Keep all accessories and enhancements out of the reach of small children.
- When you disconnect the power cord of any accessory or enhancement, grasp and pull the plug, not the cord.
- Check regularly that enhancements installed in a vehicle are mounted and are operating properly.
- Installation of any complex car enhancements must be made by qualified personnel only.

General information

■ Overview of functions

Your phone provides many functions that are practical for daily use, such as a calendar, e-mail application, clock, alarm clock, XHTML Web browser, and radio. Your phone also supports the following functions:

- 2-megapixel camera with video recording capability
- Music player with playback control keys and support for MP3, WMA, AAC, and eAAC+ files
- Enhanced voice dialing and voice commands
- Bluetooth wireless technology
- microSD memory card to extend the memory capacity of the phone

■ Access codes

Lock code

The lock code (5 to 10 digits) helps to protect your phone against unauthorized use. The preset code is 12345. Change the code, and keep the new code secret and in a safe place separate from your phone. To change the code, and to set the phone to request the code, see "Security," p. 94.

If you enter an incorrect lock code five times in succession, the phone ignores further entries of the code. Wait for 5 minutes, and enter the code again.

When the device is locked, calls may be possible to the official emergency number programmed into your device.

PIN codes

- The personal identification number (PIN) code and the universal personal identification number (UPIN) code (4 to 8 digits) help to protect your SIM card against unauthorized use. See "Security," p. 94. The PIN code is usually supplied with the SIM card.

- The PIN2 code (4 to 8 digits) may be supplied with the SIM card and is required for some functions.
- The module PIN is required to access the information in the security module. The module PIN is supplied with the SIM card if the SIM card has a security module in it.
- The signing PIN is required for the digital signature. The signing PIN is supplied with the SIM card if the SIM card has a security module in it.

PUK codes

The personal unblocking key (PUK) code and the universal personal unblocking key (UPUK) code (8 digits) are required to change a blocked PIN code and UPIN code, respectively. The PUK2 code is required to change a blocked PIN2 code.

If the codes are not supplied with the SIM card, contact your local service provider for the codes.

Barring password

The barring password (4 digits) is required when using [Call barring](#). See "Call barring," p. 97. You can obtain the password from your service provider.

If you enter an incorrect barring password three times in succession, the password is blocked. Contact your service provider or network operator.

■ Configuration settings service

Before you can use multimedia messaging, instant messaging, push to talk, e-mail application, synchronization, streaming, and the browser, you must have the proper configuration settings on your phone. Your phone may automatically configure browser, multimedia messaging, access point, and streaming settings based on the SIM card used. You may receive the settings directly as a configuration message, which you save to your phone.

For more information on availability, contact your network operator, service provider, or nearest authorized Nokia dealer.

When you receive a configuration message, and the settings are not automatically saved and activated, *1 new message* is displayed. Select **Show** to open the message. To save the settings, select **Options** > **Save**. If the phone requests *Configuration settings' PIN code*;, enter the PIN code for the settings, and select **OK**. To receive the PIN code, contact the service provider.

If no settings are saved yet, these settings are saved and set as default configuration settings. Otherwise, the phone asks *Set as default settings?*.

To discard the received settings, select **Options** > **Delete**.

■ Download content and applications

You may be able to download content and applications, such as themes, tones, video clips, and games, to the phone (network service). Select the download function (for example, in the *Gallery* menu). To access the download function, see the respective menu descriptions. For availability of different services, pricing, and tariffs, contact your service provider.



Important: Only install and use applications and other software from sources that offer adequate security and protection against harmful software.

■ Nokia support and contact information

Check www.nokia.com/support or your local Nokia Web site for the latest version of this guide, additional information, downloads, and services related to your Nokia product.

On the Web site, you can get information on the use of Nokia products and services. If you need to contact customer service, check the list of local Nokia contact centers at www.nokia.com/customerservice.

For maintenance services, check your nearest Nokia service center at www.nokia.com/repair.

1. Get started

■ Insert a SIM card and battery

Always switch the device off, and disconnect the charger before removing the battery.

Keep all SIM cards out of the reach of small children.

For availability and information on using SIM card services, contact your SIM card vendor. This may be the service provider, network operator, or other vendor.

1. With the back of the phone facing you, press the release buttons on both sides of the phone (1), and lift the back cover (2) to remove it.

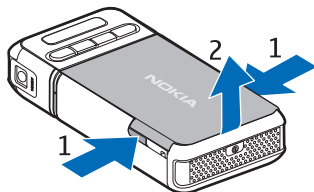

2. To remove the battery, lift it as shown (3).

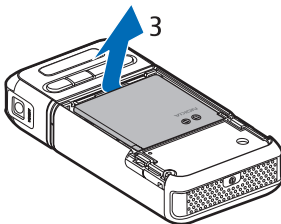

- To release the SIM card holder, slide it backwards (4), and lift it (5).
- Insert the SIM card into the SIM card holder (6). Ensure that the beveled corner faces upwards.
- Close the SIM card holder (7), and slide it forward to lock it (8).

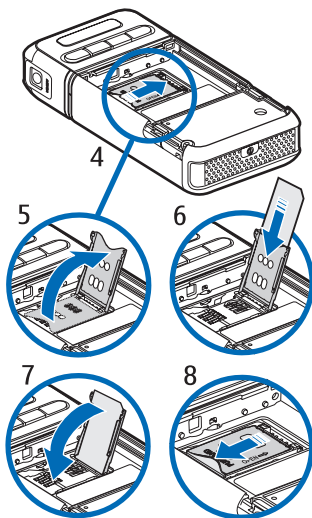

- Replace the battery (9).

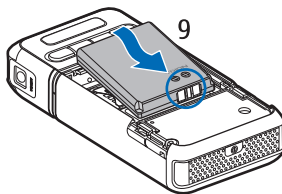

- To replace the back cover, align it with the locking catches on the phone (10), and press the cover into place (11).

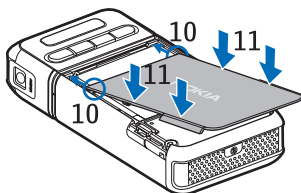

■ Insert a microSD card



1. Turn the lower part of the phone to access the microSD card slot cover.
2. To open the card slot cover, pull the corner of the cover.
3. Insert the card with the golden contact surface facing the back of the slot cover, and press it down until it locks into place.
4. Close the card slot cover.

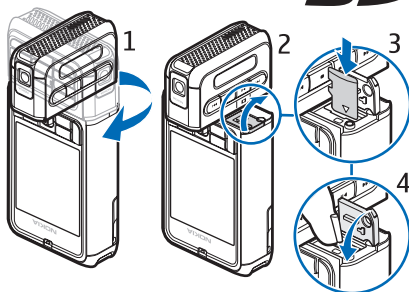

Keep microSD cards out of the reach of small children.

Use only compatible microSD cards with this device. Other memory cards, such as Reduced Size MultiMediaCards, do not fit in the microSD card slot and are not compatible with this device. Using an incompatible memory card may damage the memory card as well as the device, and data stored on the incompatible card may be corrupted.

■ Remove the microSD card



Important: Do not remove the microSD card in the middle of an operation when the card is being accessed. Removing the card in the middle of an operation may damage the memory card as well as the device, and data stored on the card may be corrupted.

You can remove or replace the microSD card during phone operation without switching the phone off.

1. Turn the key part of the phone to reveal the microSD card slot.
2. Open the microSD card slot cover, and follow the instructions on the display.
3. Remove (or replace) the microSD card, and close the card slot cover.

■ Charge the battery

1. Connect the charger to the wall socket.
2. Connect the lead from the charger to the charger connector in the phone.

If the battery is completely discharged, it may take a few minutes before the charging indicator appears on the display or before any calls can be made.

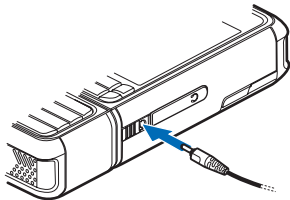

The charging time depends on the charger and the battery used. Charging a BP-6M battery with the AC-3 charger takes approximately 3 hours and with the AC-4 charger approximately 2 hours.

■ Switch the phone on and off

Press and hold the power key as shown.

If the phone asks for a PIN code, enter the PIN code, and select **OK**.

If the phone asks for the lock code, enter the lock code, and select **OK**. The factory setting for the lock code is 12345.

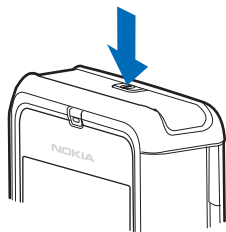

■ Set time and date

To set the correct time zone, time, and date, select your current city or the nearest city in the list that is in the same time zone, and then enter the local time and date.

■ Normal operating position

Use the phone only in its normal operating position.

Your device has an internal antenna.



Note: As with any other radio transmitting device, do not touch the antenna unnecessarily when the device is switched on. Contact with the antenna affects call quality and may cause the device to operate at a higher power level than otherwise needed. Avoiding contact with the antenna area when operating the device optimizes the antenna performance and the battery life.







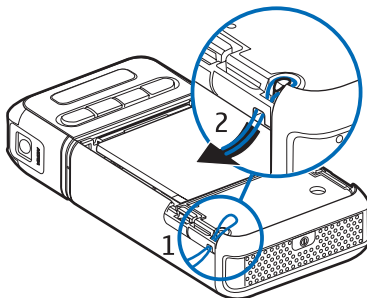



■ Attach a wrist strap

1. Remove the back cover of the phone.
2. Insert the wrist strap loop through the opening (1).
3. Set the loop around the peg, and pull the loop tight (2).
4. Replace the back cover.



2. Your phone

■ Keys and parts

- Power key (1)
- Earpiece (2)
- Joystick (3)
- Selection keys (4)
- Menu key  (5)
- Clear key  (6)
- Edit key  (7)
- End key  (8)
- Call key  (9)
- Number keys (10)
- Fast forward , zoom in (11)
- Stop  (12)
- Play/pause , capture key (13)
- Rewind , zoom out (14)
- Camera lens (15)
- Loudspeaker (16)
- Pop-Port™ connector (17)
- Charger connector (18)
- Pop-Port connector cover (19)

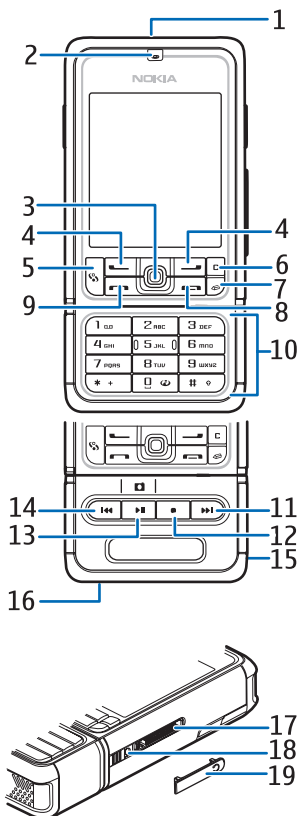

Keep the Pop-Port connector cover out of the reach of small children.
Keep your device away from magnets or magnetic fields as they may cause some applications, like the camera, to activate unexpectedly.

■ Mechanical modes

Your phone has three mechanical modes: communication, camera, and music mode. To switch between the modes, turn the lower part of the phone. There is a short pause before a mode is activated. In the communication mode, do not try to rotate the lower part of the phone more than 90 degrees to the right or 180 degrees to the left. If you force the lower part of the phone to rotate more, the phone will be damaged.

Communication mode

The communication mode is activated when the number keys of the lower part are on the same side as the display.

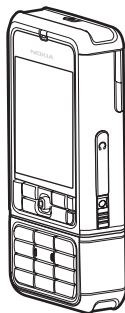

Camera mode

To activate the camera mode while in the communication mode, turn the lower part of the phone 90 degrees to the left so that the camera lens is pointing away from you when you look at the display.

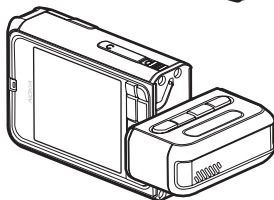

To take a self portrait, turn the lower part of the phone 90 degrees to the right so that the camera lens is pointing towards you when you look at the display.

Music mode

To activate the music mode while in the communication mode, turn the lower part of the phone 180 degrees to the left so that the keys used to control music playback are on the same side as the display.

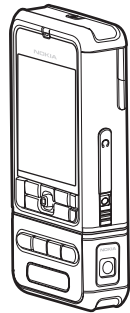

■ Standby mode

When you have switched on the phone, and it is registered to a network, the phone is in the active standby mode and ready for use.

To change the profile, press the power key, and select a profile.

To open the list of last dialed numbers, press the call key.

To use the voice commands, press and hold the right selection key.

To start a connection to the Web, press and hold 0.

Active standby mode

In the active standby mode, you can use the main display for fast access to frequently used applications. To select whether the active standby is shown, select **Menu** > **Tools** > **Settings** > **Phone** > **Standby mode** > **Active standby** > **On** or **Off**.

To access active standby applications, scroll up or down, then scroll to the application, and select it. In the active standby mode the default applications are shown across the top of the display, and calendar, to-do, and player events are listed below. To select an application or event, scroll to it, and press the joystick.

Standby mode joystick shortcuts

By default, the phone is in the active standby mode, and the joystick shortcuts available in standby mode cannot be used. You have to disable active standby to use the following shortcuts.

To open [Contacts](#), scroll up or down, or press the joystick.

To open [Calendar](#), scroll right.











To write a text message, scroll left.

To change the joystick application shortcuts:

1. Select [Menu](#) > [Tools](#) > [Settings](#) > [Phone](#) > [Standby mode](#).
2. Scroll to the shortcut you want to change, and press the joystick.
3. Scroll to a new application, and press the joystick.

Some shortcuts may be fixed and cannot be changed.

■ Indicators

-  The phone is connected to a GSM network.
-  You have received one or several messages to the [Inbox](#) folder in [Messag..](#)
-  There are messages waiting to be sent in [Outbox](#). See "Outbox," p. 40.
-  You have missed calls. See "Recent calls," p. 27.
-  Shown if [Ringing type](#) is set to [Silent](#) and [Message alert tone](#) and [E-mail alert tone](#) are set to [Off](#). See "Profiles," p. 85.
-  The phone keypad is locked. See "Keypad lock (keyguard)," p. 23.
-  The loudspeaker is activated
-  An alarm is active.
-  The second phone line is being used. See [Line in use](#) in "Call," p. 89.
-  All calls to the phone are diverted to your voice mailbox or to

another number. If you have two phone lines, the divert indicator is **1** for the first line and **2** for the second.



A headset is connected to the phone.



A loopset is connected to the phone.



The connection to a Bluetooth headset has been lost.



A data call is active.



A GPRS or EDGE packet data connection is available.



A GPRS or EDGE packet data connection is active.



A GPRS or EDGE packet data connection is on hold.



Bluetooth is active.



Data is being transmitted using Bluetooth. See "Bluetooth connection," p. 104.



A USB connection is active.

Other indicators may also be shown.

■ Scroll and select with the joystick

To scroll, move the joystick up, down, left, or right. To select the highlighted item, press the joystick.

Mark and unmark items in applications

To mark or unmark an item in applications, press and hold the edit key, and press the joystick. To mark or unmark several consecutive items, press and hold the edit key, and scroll up or down.

■ Menu

In the menu you can access the functions in your phone. To access the main menu, select **Menu**.

To open an application or a folder, scroll to it and press the joystick.

To change the menu view, select **Menu** > **Options** > *Change view* > *Grid* or *List*.

If you change the order of the functions in the menu, the order may differ from the default order described in this user guide.

To close an application or a folder, select **Back** and **Exit** as many times as needed to return to the standby mode, or select **Options** > *Exit*.

To display and switch between open applications, press and hold the menu key. The application switching window opens, showing a list of open applications. Scroll to an application, and select it.

Leaving applications running in the background increases the demand on battery power and reduces the battery life.

■ Help



Your device has context-sensitive help. You can access the help from an application or from the main menu.

To access help when an application is open, select **Options** > *Help*. To switch between help and the application that is open in the background, select and hold **Menu**. Select **Options** and from the following options:

Topic list – to view a list of available topics in the appropriate category

Help category list – to view a list of help categories

Search by keyword – to search for help topics using keywords

To open help from the main menu, select **Tools** > *Help*. In the list of help categories, select the desired application to view a list of help topics. To switch between the help category list, indicated with , and a keywords list, indicated with  abc, scroll left or right. Press the joystick to display the related help text.

■ Tutorial

Tutorial contains an introduction to the phone features and a tutorial to teach how to use the phone. The tutorial starts automatically when you turn on your phone for the first time. To start the tutorial yourself, select **Menu** > *Tutorial* and a tutorial item.

■ Volume control

To adjust the earpiece or loudspeaker volume during a call or when listening to an audio file, scroll left or right.

To activate the loudspeaker during a call, select **Loudsp.**

To deactivate the loudspeaker during a call, select **Handset**.



Warning: Do not hold the device near your ear when the loudspeaker is in use, because the volume may be extremely loud.

■ Keypad lock (keyguard)

To prevent the keys from being accidentally pressed, press the left selection key and * within 1.5 seconds to lock the keypad.

To unlock the keypad, select **Unlock**, and press * within 1.5 seconds.

When the keypad lock is on, calls may be possible to the official emergency number programmed into your device.

3. Call functions

■ Make a call

1. In the standby mode, enter the phone number, including the area code. Press the clear key to remove a number.

For international calls, press * twice for the international prefix (the + character replaces the international access code), and enter the country code, area code (omit the leading zero if necessary), and phone number.

2. To call the number, press the call key.
3. To end the call, or to cancel the call attempt, press the end key.

To make a call from *Contacts*, select **Menu** > *Contacts*. Scroll to the desired name, or enter the first letters of the name, and scroll to the desired name. To call the number, press the call key.

To call your voice mailbox (network service), press and hold 1 in the standby mode. You must define the voice mailbox number before you can call your voice mailbox. See "Voice mailbox," p. 84.

To call a recently dialed number, press the call key in the standby mode. The list of the last 20 numbers you called or attempted to call is shown. Scroll to the number you want, and press the call key.

To make a push to talk call, see "Push to talk," p. 115.

Speed dialing

You can assign a phone number to one of the speed dialing keys 2 to 9. See "Assign speed dialing keys," p. 48.

Call a speed dialing number in either of the following ways:

- Press the speed dialing key, then the call key.
- If *Speed dialing* is set to *On*, press and hold the speed dialing key until the call begins. To set *Speed dialing* to *On*, select **Menu** > *Tools* > *Settings* > *Call* > *Speed dialing* > *On*.

Enhanced voice dialing

You can make a phone call by saying the name that is saved in the contact list of the phone. A voice command is added automatically to all entries in the contact list of the phone.

Very short names are not accepted. Use long names, and avoid similar names for different numbers.

Make a voice dialing call

If an application is sending or receiving data using a packet data connection, end the application before you use voice dialing.



Note: Using voice tags may be difficult in a noisy environment or during an emergency, so you should not rely solely upon voice dialing in all circumstances.

1. In the standby mode, press and hold the right selection key. A short tone is played, and *Speak now* is displayed.
If you are using a compatible headset with the headset key, press and hold the headset key.
2. Say the voice command clearly. The phone plays the voice command of the best match. After about 1.5 seconds, the phone dials the number; if the result is not the correct one, before dialing select **Next**, and select another entry to dial it.

Using voice commands to carry out a phone function is similar to voice dialing. See "Voice commands," p. 84.

Make a conference call (network service)

1. Make a call to the first participant.
2. To make a call to another participant, select **Options** > *New call*. The first call is automatically put on hold.
3. To join the first participant in the conference call when the new call is answered, select **Options** > *Conference*.
 - To add a new person to the call, repeat step 2, and select **Options** > *Conference* > *Add to conference*. The phone supports conference calls between a maximum of six participants, including yourself.

- To have a private conversation with one of the participants, select **Options** > **Conference** > **Private**. Select a participant and **Private**. The conference call is put on hold on your phone. The other participants can still continue the conference call. To return to the conference call, select **Options** > **Add to conference**.
 - To drop a participant, select **Options** > **Conference** > **Drop participant**, scroll to the participant, and select **Drop**.
4. To end the conference call, press the end key.

■ Answer or reject a call

To answer the call, press the call key.

To mute the ringing tone before you answer the call, select **Silence**.



Tip: If a compatible headset is connected to the phone, press the headset key to answer and end a call.

To reject the call, press the end key. The caller hears a line busy tone. If you have activated the **Call divert** option **If busy** to divert calls, rejecting the call also diverts the call.

To send a text message to the caller informing why you cannot answer the call, select **Options** > **Send text message**. You can edit the text before sending it. See **Reject call with SMS** and **Message text** in "Call," p. 88.

Call waiting (network service)

During a call, to answer the waiting call, press the call key. The first call is put on hold. To end the active call, press the end key.

To activate the **Call waiting** function, select **Menu** > **Tools** > **Settings** > **Call** > **Call waiting** > **Activate**.

To switch between the two calls, select **Swap**.

Options during a call

Many of the options that you can use during a call are network services. For availability, contact your network operator or service provider.

Select **Options** during a call for some of the following options:

Mute or *Unmute*; *Activate handset*, *Activate loudsp.*, or *Activate handsfree* (if a compatible Bluetooth headset is attached); *End active call* or *End all calls*; *New call*; *Conference*; *Answer*; *Reject*; *Swap*; *Hold* or *Unhold*; and *Open active standby*.

Transfer – to connect a call on hold to an active call and disconnect yourself

Replace – to end an active call and replace it by answering the waiting call

Send DTMF – to send DTMF tone strings (for example, a password). Enter the DTMF string or search for it in *Contacts*. To enter a wait character (w) or a pause character (p), press * repeatedly. To send the tone, select **OK**.



Tip: You can add DTMF tones to the *Phone number* or *DTMF* fields in a contact card.

■ Log

In the log, you can monitor phone calls, text messages, packet data connections, and fax and data calls registered by the phone. You can filter the log to view just one type of event and create new contacts based on the log information.

Connections to your remote mailbox, multimedia messaging center, or browser pages are shown as data calls or packet data connections in the general communications log.

Recent calls

The phone registers the phone numbers of missed, received, and dialed calls, and the approximate duration of your calls. The phone registers missed and received calls only if the network supports these functions, and the phone is switched on and within the network service area.

Missed calls and received calls

To view a list of the last 20 phone numbers from which somebody has tried to call you (network service), select **Menu** > **Log** > **Recent calls** > **Missed calls**.

To view a list of the 20 numbers or names from which you have most recently accepted calls (network service), select **Menu** > **Log** > **Recent calls** > **Received calls**.

Dialed numbers

To view the 20 phone numbers that you have most recently called or attempted to call, select **Menu** > **Log** > **Recent calls** > **Dialed nos.**

Erase recent call lists

To clear all recent call lists in the **Recent calls** view, select **Options** > **Clear recent calls**.

To clear one of the call registers, open the register you want to erase and select **Options** > **Clear list**.

To clear an individual event, open a register, scroll to the event, and press the clear key.

Call duration

To view the duration of your incoming and outgoing calls, select **Menu** > **Log** > **Call duration** > **Last call**, **Dialed nos.**, **Received calls**, or **All calls**.



Note: The actual invoice for calls and services from your service provider may vary, depending on network features, rounding off for billing, taxes, and so forth.

Some timers, including the life timer, may be reset during service or software upgrades.

Erase call duration timers

To clear call duration timers, select **Options** > **Clear timers**, and enter the lock code. See "Security," p. 94.

General log

In the general log, for each communication event, you can see the sender or recipient name, phone number, name of the service provider, or access point. Subevents, such as a text message sent in more than one part and packet data connections, are logged as one communication event.

To view the general log, select **Menu** > *Log*, and scroll right.

To filter the log, select **Options** > *Filter* and the filter type.

To erase all the log contents permanently, select **Options** > *Clear log* > *Yes*.

Packet data counter and connection timer

To view how much data in kilobytes has been transferred and the approximate length of a certain packet data connection, scroll in the general log to an incoming or outgoing event indicated by *Pack.*, and select **Options** > *View details*.

Log settings

To set the general log settings, select **Options** > *Settings* and from the following settings:

Log duration — The log events remain in the phone memory for a set number of days after which they are automatically erased to free memory. If you select *No log*, all the log contents, *Recent calls* register, and messaging delivery reports are permanently deleted.



Show call duration — See "Call duration," p. 28.

Packet data counter

The packet data counter allows you to check the amount of data sent and received during packet data (GPRS) connections.

To access the counter, select **Menu** > *Log* > *Packet data*.

4. Write text

You can enter text, for example, when writing messages, using traditional or predictive text input. When you write text,  appears on the top right of the display, indicating predictive text input, and  appears, indicating traditional text input. To set the predictive text input on or off when writing text, press # twice within 1.5 seconds; or press the edit key and select *Predictive text on* or *Predictive text > Off*.

Abc, abc, or ABC appears next to the text input indicator, indicating the character case. To change the character case, press #.

123 indicates the number mode. To change between letter and number mode, press and hold #, or press the edit key, and select *Number mode* or *Alpha mode*.

■ Traditional text input

Press a number key, 1 to 9, repeatedly until the desired character appears. Not all characters available under a number key are printed on the key. The characters available depend on the selected writing language. See *Writing language* in "Phone," p. 86.

If the next letter you want is on the same key as the present one, wait until the cursor appears (or scroll forward to end the time-out period), and enter the letter.

To insert a number, press and hold the number key.

The most common punctuation marks and special characters are available under the 1 key. For more characters, press *; or press the edit key, and select *Insert symbol*.

To erase a character, press the clear key. To erase more characters, press and hold the clear key.

To insert a space, press 0. To move the cursor to the next line, press 0 three times.

■ Predictive text input

You can enter any letter with a single keypress using predictive text input. To activate predictive text input, press the edit key, and select *Predictive text on*. This activates predictive text input for all editors in the phone.

1. To write the desired word, press the keys 2–9. Press each key only once for one letter. The word changes after every keypress.

For the most common punctuation marks, press 1. For more punctuation marks and special characters, press and hold *; or press the edit key, and select *Insert symbol*.

To erase a character, press the clear key. To erase more characters, press and hold the clear key.

2. When you have finished the word and it is correct, to confirm it, scroll forward or press the 0 key to insert a space.

If the word is not correct, you have the following options:

- To view the matching words the dictionary has found one by one, press * repeatedly.
- To view a list of matching words, press the edit key, and select *Predictive text > Matches*. Scroll to the word you want to use, and press the joystick to select it.

If the ? character is shown after the word, the word you intended to write is not in the dictionary. To add a word to the dictionary, select *Spell*; or press the edit key, and select *Predictive text > Insert word*. Enter the word (max. 32 letters) using traditional text input, and select **OK**. The word is added to the dictionary. When the dictionary becomes full, a new word replaces the oldest added word.

To open a view where you can edit the word, available only if the word is active (underlined), press the edit key, and select *Predictive text > Edit word*.

Write compound words

Write the first half of a compound word, and scroll forward to confirm it. Write the last part of the compound word, and to complete the compound word, press **O** to add a space.

■ Copy and delete text

1. To select letters and words, press and hold the edit key, and at the same time scroll left or right. As the selection moves, text is highlighted. To select lines of text, press and hold the edit key, and at the same time scroll up or down.

2. To copy the text to the clipboard, press and hold the edit key, and at the same time select **Copy**.

If you want to delete the selected text from the document, press the clear key.

3. To insert the text, scroll to the insertion point, press and hold the edit key, and at the same time select **Paste**.

5. Messaging

You can create, send, receive, view, edit, and organize text messages, multimedia messages, e-mail messages, presentations, and documents. You can also receive messages and data using Bluetooth wireless technology, receive and forward picture messages, receive service messages and cell broadcast messages, and send service commands.



Note: Only devices that have compatible features can receive and display multimedia messages. The appearance of a message may vary depending on the receiving device.

To open the *Messaging* menu, select **Menu** > *Messag..* You can see the *New message* function and a list of default folders:

Inbox — contains received messages except e-mail and cell broadcast messages. E-mail messages are saved in the *Mailbox* folder. To read cell broadcast messages, select **Options** > *Cell broadcast*.

My folders — for organizing your messages into folders

Mailbox — You can either connect to your remote mailbox to retrieve your new e-mail messages or view your previously retrieved e-mail messages offline. After you define settings for a new mailbox, the name given to that mailbox is displayed instead of *Mailbox*. See "E-mail settings," p. 43.

Drafts — saves draft messages that have not been sent

Sent — saves the messages that are sent, excluding messages sent using Bluetooth. You can change the number of messages to be saved. See "Other settings," p. 46.

Outbox — temporarily saves the messages waiting to be sent

Reports (network service) — saves the delivery reports of the text messages, special message types such as business cards, and multimedia messages you have sent. Receiving a delivery report of a multimedia message that has been sent to an e-mail address may not be possible.

To request the network to send you the delivery reports, select **Options** > *Settings* > *Text message* or *Multimedia message* > *Receive report* > *Yes*.

■ Write and send messages

The wireless network may limit the size of MMS messages. If the inserted picture exceeds this limit, the device may make it smaller so that it can be sent by MMS.

Your device supports the sending of text messages beyond the character limit for a single message. Longer messages are sent as a series of two or more messages. Your service provider may charge accordingly. Characters that use accents or other marks, and characters from some language options like Chinese, take up more space limiting the number of characters that can be sent in a single message.

Before you can send and receive an SMS message, a multimedia message, or an e-mail, or connect to your remote mailbox, you must have the correct connection settings in place. See "Messaging settings," p. 41.

1. To create a message, select **Menu** > **Messag.** > **New message** and from the following options:
 - Text message** — to create a text message
 - Multimedia message** — to create a multimedia message (MMS)
 - E-mail** — to create an e-mail message. If you have not set up your e-mail account, you are asked if you want to do so.
2. Press the joystick to select the recipients or groups from **Contacts** or enter the phone number or e-mail address of the recipient in the **To** field. To add a semicolon (;) to separate each recipient, press *.
3. When creating an e-mail or multimedia message, scroll down to the subject field, and write the message subject.
4. Scroll down to move to the message field.
5. Write the message.

When writing text messages, the message length indicator shows how many characters you can enter in the message. For example, 10 (2) means that you can still add 10 characters for the text to be sent as two separate text messages.

To use a template for the text message, select **Options** > **Insert** > **Template**. To create a presentation based on a template to be sent as a multimedia message, select **Options** > **Create presentation**. To use

a text template for the multimedia message, select **Options** > *Insert object* > *Template*.

To add a media object to a multimedia message, select **Options** > *Insert object* > *Image*, *Sound clip*, or *Video clip*. To create and add a new media object, select **Options** > *Insert new* > *Image*, *Sound clip*, *Video clip* or *Slide*. When sound has been added, the  icon is shown.

To add a media object to an e-mail, select **Options** > *Insert* > *Image*, *Sound clip*, *Video clip*, *Note* or *Template*.

- To send the message, select **Options** > *Send*; or press the call key.

Copyright protections may prevent some images, music (including ringing tones), and other content from being copied, modified, transferred or forwarded.

Receive multimedia messaging settings

You may receive multimedia messaging settings as a configuration message from your network operator or service provider. See "Multimedia messaging settings," p. 42.

Select **Menu** > *Messag.* > **Options** > *Settings* > *Multimedia message*. Open *Access point in use*, and select the access point you created. See "Multimedia messaging settings," p. 42.

For availability of and subscription to the multimedia messaging service, contact your network operator or service provider.



Note: Only devices that have compatible features can receive and display multimedia messages. The appearance of a message may vary depending on the receiving device.

E-mail settings

Before you can send, receive, retrieve, reply to, and forward e-mail to a separate e-mail account, you must:

- Configure an Internet access point (IAP) correctly. See "Connection," p. 89.
- Define your e-mail settings correctly. See "E-mail settings," p. 43.

Follow the instructions given by your remote mailbox and Internet service provider.

Inbox—receive messages

Select **Menu** > **Messag.** > **Inbox**.

When there are unread messages in the Inbox, the icon changes to .

In the Inbox you may see some of the following icons:

 indicates an unread text message

 indicates an unread special message, such as a business card

 indicates an unread multimedia message

 indicates an unread WAP service message

 indicates an unknown message type

To open a received message, select **Menu** > **Messag.** > **Inbox** and the desired message.



Important: Exercise caution when opening messages. Multimedia message objects may contain malicious software or otherwise be harmful to your device or PC.

View multimedia objects

To view the list of media objects that are included in the multimedia message, open the message, and select **Options** > **Objects**. You can save the file in your phone or send it using Bluetooth technology or as a multimedia message to another compatible device.

Special message types

Your phone can receive many kinds of messages, such as operator logos, business cards, and ringing tones.

To open a received message, select **Menu** > **Messag.** > **Inbox** and the desired message.

Operator logo – To save the logo, select **Options** > **Save**. The operator logo can now be seen in the standby mode instead of the network operator's own identification.

Business card – To save the contact information, select **Options** > *Save business card*.

Ringing tone – To save the ringing tone to the gallery, select **Options** > *Save*.

Calendar entry – To save the invitation to the calendar, select **Options** > *Save to Calendar*.

Picture message – To forward the picture message, select **Options** > *Forward*.



Note: The picture message function can be used only if it is supported by your network operator or service provider. Only compatible devices that offer picture message features can receive and display picture messages. The appearance of a message may vary depending on the receiving device.

Configuration message – You may receive a text message service number, voice mailbox number, Internet access point settings, access point login script settings, multimedia messaging settings, synchronization settings, or e-mail settings from your network operator or service provider in a configuration message. To save the settings, select **Options** > *Save*.

Service messages

Service messages (network service) are notifications (for example, news headlines), and they may contain a text message or the address of a browser service. For availability and subscription, contact your service provider.

■ My folders

You can organize your messages into folders, create new folders, and rename and delete folders.

Select **Menu** > *Message* > *My folders*. To create a folder, select **Options** > *New folder* and enter a name for the folder.

■ Mailbox

Select **Menu** > *Messag.* > *Mailbox*.

When you open this folder, you can connect to your remote mailbox (network service) to do the following:

- Retrieve new e-mail headings or messages.
- View your previously retrieved e-mail headings or messages offline.

When you scroll to your mailbox and press the joystick, the phone asks you if you want to *Connect to mailbox?* Select *Yes* to connect to your mailbox or *No* to view previously retrieved e-mail messages offline.

Another way to start a connection is to select **Options** > *Connect*.

If you select *New message* > *Create:* > *E-mail* or *Mailbox* in the messaging main view and you have not set up your e-mail account, you are prompted to do so. See "E-mail settings," p. 35.

When you create a new mailbox, the name you give to the mailbox automatically replaces *Mailbox* in the Messaging main view. You can have up to six mailboxes.

When you are online, select **Options** > *Disconnect* to end the data call or packet data connection to the remote mailbox.

Retrieve e-mail messages from the mailbox

1. Select **Menu** > *Messag.* > *Mailbox* > **Options** > *Connect*. A connection is established to the remote mailbox.
2. Select **Options** > *Retrieve e-mail* and from the following options:
 - New* – to retrieve all new e-mail messages to your phone
 - Selected* – to retrieve only the e-mail messages that have been marked
 - All* – to retrieve all messages from the mailbox
 To cancel retrieving, select **Cancel**.
3. After you have retrieved the e-mail messages, you can continue viewing them online. Select **Options** > *Disconnect* to close the connection and to view the e-mail messages offline.

- To open an e-mail message, scroll to the e-mail you want to view and press the joystick. If the e-mail message has not been retrieved and you are offline and select *Open*, you are asked if you want to retrieve this message from the mailbox.

To view e-mail attachments, indicated with , select *Options* > *Attachments*. You can retrieve, open, or save attachments in supported formats. You can also send attachments using Bluetooth technology.



Important: Exercise caution when opening messages. E-mail messages may contain malicious software or otherwise be harmful to your device or PC.

Delete e-mail messages

Delete from the phone

To delete an e-mail from the phone while still retaining it in the remote mailbox, select *Menu* > *Message* > *Mailbox* > *Options* > *Delete* > *Phone only*.

The e-mail heading stays in your phone. To remove the heading as well, delete the e-mail message from your remote mailbox first, then connect from your phone to the remote mailbox to update the status.

Delete from the phone and server

To delete an e-mail from the phone and the remote mailbox, select *Options* > *Delete* > *Phone and server*.

If you are offline, the e-mail is first deleted from your phone. During the next connection to the remote mailbox, it is automatically deleted from the remote mailbox. If you are using the POP3 protocol, messages marked to be deleted are removed only after you have closed the connection to the remote mailbox.

Undelete

To cancel deletion of an e-mail from both the phone and server, scroll to an e-mail that has been marked to be deleted during the next connection, and select *Options* > *Restore*.

■ Outbox

The *Outbox* folder is a temporary storage place for messages that are waiting to be sent.

To access the *Outbox* folder, select **Menu** > *Messag.* > *Outbox*. Message statuses:

Sending – The phone is sending the message.

Waiting/Queued – The phone is waiting to send messages or e-mail.

Resend at ... (time) – Sending failed. The phone tries to send the message again after a time-out period. To restart the sending immediately, select **Options** > *Send*.

Deferred – To set documents to be on hold while they are in the *Outbox* folder, scroll to a message that is being sent, and select **Options** > *Defer sending*.

Failed – The maximum number of sending attempts has been reached. If you were trying to send a text message, open the message, and check that the sending settings are correct.

■ View messages on the SIM card

Before you can view SIM messages, you need to copy them to a folder in your phone.

1. Select **Menu** > *Messag.* > **Options** > *SIM messages*, and scroll to a message.
2. Mark the messages you want to copy.
3. To copy the marked messages, select **Options** > *Copy*, and the folder to which you want to copy the messages.
4. To start the copying, select **OK**.

■ Cell broadcast

You may be able to receive messages on various topics, such as weather or traffic conditions from your service provider (network service). For available topics and relevant topic numbers, contact your service

provider. To turn on the service, see *Cell broadcast* settings in "Cell broadcast settings," p. 46.

Select **Menu** > *Message* > **Options** > *Cell broadcast*. In the message list, you can see the status of the topic, the topic number, topic name, and whether it has been flagged  for follow-up.

A packet data connection may prevent cell broadcast reception.

■ Service command editor

To enter and send service commands (also known as USSD commands) such as activation commands for network services to your service provider, select **Menu** > *Message* > **Options** > *Service command*. To send the command, select **Options** > *Send*.

■ Messaging settings

Text message settings

Select **Menu** > *Message* > **Options** > *Settings* > *Text message* and from the following options:

Message centres – lists all the defined message centers

Msg. centre in use – defines which message center is used for delivering text messages and special message types such as business cards

Character encoding > *Full support* – to select all characters in the message to be sent as viewed. If you select *Reduced support*, characters with accents and other marks may be converted to other characters.

Receive report – When set to *Yes*, the status of the sent message (*Pending*, *Failed*, *Delivered*) is shown in *Reports* (network service). Receiving a delivery report of a multimedia message that has been sent to an e-mail address may not be possible.

Message validity – If the recipient of a message cannot be reached within the validity period, the message is removed from the message service center. Note that the network must support this feature.

Maximum time – the maximum amount of time allowed by the network for which the message remains valid

Message sent as — to define how the message is sent. Default is *Text*.

Preferred conn. — You can send text messages using the normal GSM network or GPRS, if supported by the network.

Reply via same ctr. (network service) — If you select *Yes*, and the recipient replies to your message, the return message is sent using the same message service center number. All networks do not provide this option. For availability, contact your network operator or service provider.

Multimedia messaging settings

Select **Menu** > *Messag.* > **Options** > *Settings* > *Multimedia message* and from the following options:

Image size — Define the size of the image in a multimedia message: *Small* (max. 160 x 120 pixels) or *Large* (max. 640 x 480 pixels). If you select *Original*, the image is not scaled.

MMS creation mode — If you select *Guided*, the phone informs you if you try to send a message that may not be supported by the recipient. To set the phone to prevent you from sending messages that are not supported, select *Restricted*. If you select *Free*, message creation is not restricted, but the recipient may not be able to view your message.

Access point in use — Select which access point is used as the preferred connection for multimedia messaging. See "Receive multimedia messaging settings," p. 35.

If you receive multimedia message settings in a message and save them, the received settings are automatically used for the access point. See "Special message types," p. 36.

Multimedia retrieval — To receive multimedia messages only when you are in your home network, select *Auto. in home network*. When you are outside your home network, multimedia message reception is turned off. To always receive multimedia messages, select *Always automatic*. To retrieve messages manually, select *Manual*. To not receive any multimedia messages or advertisements, select *Off*.

Allow anon. msgs. — To reject messages coming from an anonymous sender, select *No*.

Receive adverts – Define whether you want to allow reception of multimedia message advertisements.

Receive report – If you want the status of the sent message (*Pending*, *Failed*, or *Delivered*) to be shown in *Reports*, select *Yes*.

Deny report sending > *Yes* – to deny sending delivery reports

Message validity (network service) – If the recipient of a message cannot be reached within the validity period, the message is removed from the multimedia message center. *Maximum time* is the maximum amount of time allowed by the network for which the message remains valid.

E-mail settings

Settings for mailboxes

Select *Menu* > *Messag.* > *Options* > *Settings* > *E-mail* > *Mailboxes* and a mailbox.

If no mailbox settings have been defined before, you are asked if you want to define the settings. You need to define the mailbox type, e-mail address, incoming server, outgoing server, used access point, and the mailbox name. The settings are available from your e-mail service provider.

Incoming e-mail

Select *Connection settings* > *Incoming e-mail* and from the following settings:

User name – user name provided by the service provider

Password – If you leave the password field blank, every time you try to connect to your remote mailbox, you need to enter the password. Otherwise, the password is sent automatically.

Incoming mail serv.: – the IP address or host name of your service provider's incoming e-mail server

Access point in use – the Internet access point (IAP) used for the mailbox. See "Connection," p. 89.

Mailbox name – a descriptive name for the mailbox

Mailbox type — defines the e-mail protocol used. This setting can be selected only once and cannot be changed if you have saved or exited from the mailbox settings.

Security (ports) — security protocol used in the connection to the remote mailbox

Port — To define another port than the default for the remote mailbox connection, select *User defined* and enter the port number.

APOP secure login (only POP3 mailboxes) — Select *On* to encrypt the sending of passwords to the remote e-mail server.

Outgoing e-mail

Select *Connection settings > Outgoing e-mail* and from the following settings:

My e-mail address — the e-mail address given to you by your service provider. The address must contain the @ character. Replies to your messages are sent to this address.

Outgoing mail serv. — Write the IP address or host name of your service provider's outgoing e-mail server.

For *User name*, *Password*, *Security (ports)*, and *Port* settings, see settings for *Incoming e-mail* in "Settings for mailboxes," p. 43.

User settings

Select *User settings* and from the following settings:

My name — Enter the name to be displayed in outgoing e-mail.

Send message (network service) — To set when your e-mail messages are sent, select *Immediately* or *During next conn.*

Send copy to self — Select *Yes* to send a copy of the e-mail to the address defined in *My e-mail address*.

Include signature — Select *Yes* to attach a signature to your e-mail messages and to create or edit a signature text.

New e-mail alerts — To not receive alerts about new e-mail, select *Off*.

Retrieval settings

Select *Retrieval settings* and from the following settings:

E-mail to retrieve – To only retrieve headers, select *Headers only*. To limit how much data is retrieved, select *Size limit*, and enter the maximum amount of data per message in kilobytes. To retrieve messages and attachments, select *Msgs. & attachs.*. The *Size limit* and *Msgs. & attachs.* options are only available with POP3 mailboxes.

Retrieval amount – To limit the number of messages to retrieve from the inbox of the remote mailbox, select *From Inbox > No. of e-mails* and enter the maximum number of messages to retrieve. You can also limit the number of messages to retrieve from other subscribed folders in *From folders* (only IMAP4 mailboxes).

IMAP4 folder path (only IMAP4 mailboxes) – Define the folder path for IMAP4 mailboxes.

Folder subscriptions (only IMAP4 mailboxes) – Select the mailbox folders you want to subscribe to. To subscribe to or unsubscribe from a folder, scroll to it, and select *Options > Subscribe* or *Unsubscribe*.

Automatic retrieval

Select *Automatic retrieval > Header retrieval* – To have e-mail headers automatically retrieved at set intervals, select *Always enabled*, or if you only want headers to be retrieved in your home network, *Only in home net.*. Headers can be automatically retrieved for two mailboxes at most. You can set on which days, at what times, and how frequently the headers are retrieved in *Retrieval days*, *Retrieval hours*, and *Retrieval interval*.

Service message settings

Select *Menu > Messag. > Options > Settings > Service message* and from the following settings:

Service messages – Select whether you want to allow the reception of service messages.

Download messages – Select whether to download messages automatically or manually.

Cell broadcast settings

Check with your service provider whether cell broadcast (network service) is available and what the available topics and related topic numbers are.

Select **Menu** > *Messag.* > **Options** > *Settings* > *Cell broadcast* and from the following settings:

Reception — Select *On* or *Off*.

Language — *All* allows you to receive cell broadcast messages in all available languages. *Selected* allows you to choose in which languages you wish to receive cell broadcast messages. If the language you want is not in the list, select *Other*.

Topic detection — If you receive a message that does not belong to any of the existing topics, *On* allows you to save the topic number automatically. The topic number is saved to the topic list and shown without a name. Select *Off* if you do not want to save new topic numbers automatically.

Other settings

Select **Menu** > *Messag.* > **Options** > *Settings* > *Other* and from the following settings:

Save sent messages — Select to save a copy of every sent text message, multimedia message, or e-mail to the *Sent* folder.

No. of saved msgs. — Define how many sent messages are saved to the sent items folder at a time. When the limit is reached, the oldest message is deleted.

Memory in use — Select whether to save messages to the phone memory or memory card.

6. Contacts

You can save and manage contact information, such as names, phone numbers, and addresses. You can also add a personal ringing tone, voice tag, or a thumbnail image to a contact card. You can create contact groups, which allow you to send text messages or e-mail to many recipients at the same time. Contact information can only be sent to or received from compatible devices.

■ Manage contacts

Select **Menu** > *Contacts*.

To add a new contact, select **Options** > *New contact*. Fill in the fields you want, and select **Done**.

To edit a contact, scroll to it and select **Options** > *Edit*.

To delete a contact, scroll to it and select **Options** > *Delete*. If you have marked contacts, they are deleted instead.

To attach a thumbnail image to a contact, scroll to the contact, and select **Options** > *Edit* > **Options** > *Add thumbnail*.

To assign default numbers and addresses to a contact, select it, and select **Options** > *Defaults*. Scroll to the desired default option, and select **Assign**.

To copy names and numbers from a SIM card to your phone, select **Options** > *SIM contacts* > *SIM directory*. Scroll to the name you want to copy or mark the desired names, and select **Options** > *Copy to Contacts*.

To copy a phone, fax, or pager number from contacts to your SIM card, scroll to the contact you want to copy, and select **Options** > *Copy* > *To SIM directory*.

■ Manage contact groups

Create a contact group so that you can send text or e-mail messages to several recipients at the same time.

1. Select **Menu** > *Contacts*, scroll to the right, and select **Options** > *New group*.
2. Enter a name for the group or use the default name, and select **OK**.
3. Open the group, and select **Options** > *Add members*.
4. Scroll to each contact you want to add to the group, and press the joystick to mark it.
5. Select **OK** to add all marked contacts to the group.

■ Add a ringing tone

You can set a ringing tone for each contact and group. When that contact or group member calls you, the phone plays the chosen ringing tone (if the caller's telephone number is sent with the call and your phone recognizes it).

1. Select **Menu** > *Contacts*.
2. To add a ringing tone to a contact, select the contact, **Options** > *Ringing tone*, and the desired ringing tone.

To add a ringing tone to a group, select the groups list, and scroll to a contact group. Select **Options** > *Ringing tone* and the ringing tone for the group.

To remove the personal or group ringing tone, select *Default tone* as a ringing tone.

■ Assign speed dialing keys

Speed dialing is a quick way to call frequently used numbers. You can assign a phone number to the speed dialing keys 2 to 9. The number 1 is reserved for the voice mailbox. Speed dialing has to be activated before using speed dialing. See *Speed dialing* in "Call," p. 88.

1. Select **Menu** > *Contacts* and a contact.
2. Scroll to a number, and select **Options** > *Assign speed dial*. Scroll to the desired speed dialing key, and select **Assign**. When you return to the contact information view,  next to the number indicates the assigned speed dial.

To call the contact by speed dialing, in the standby or active standby mode, press the speed dialing key and the call key. Or, press and hold the speed dialing key.

7. Gallery

Select **Menu** > *Gallery*.

Use *Gallery* to store and organize your images, video clips, music tracks, sound clips, playlists, streaming links, .ram files, and presentations.

Open the gallery to see a list of the folders in the memory. Scroll to a folder (such as *Images*), and press the joystick to open it.

In the folder you can see:

- An icon depicting the type of each file in the folder or a small thumbnail picture of an image
- The name of the file
- The date and time a file was saved or the size of the file

To open a file, scroll to the file, and press the joystick. The file opens in its corresponding application.

Copyright protections may prevent some images, music (including ringing tones), and other content from being copied, modified, transferred or forwarded.

■ Gallery functions

Select **Menu** > *Gallery* and a folder.

To set an image as your wallpaper, select *Images*, and scroll to the image. Select **Options** > *Set as wallpaper*. To assign the image to a contact, select *Add to contact*.

To set a music track or a sound clip as the ringing tone, select *Tracks* or *Sound clips*, and scroll to the track or clip. Select **Options** > *Set as ringing tone*. To assign a music track or sound clip as a contact's ringing tone, select *Assign to contact*.

To copy files to phone memory or to the memory card, scroll to the file or mark the files by pressing and holding the edit key and at the same time pressing the joystick, and select **Options** > *Organise* > *Copy to phone mem.* or *Copy to memory card*.

To create track lists, mark the music tracks, and select **Options** > *New track list*.

To create image folders and move images to them, select *Images*, scroll to an image, select **Options** > *Organise* > *New folder*, and enter a name for the folder. Mark the images you want to move to the folder, select **Options** > *Organise* > *Move to folder*, and select the folder.

■ Download files

Select **Menu** > *Gallery*, the folder for the file type you want to download, and the download function (for example, *Images* > *Graphic download*). The browser opens. Choose a bookmark for the site to download from. See "View bookmarks," p. 68.

To download files, you must first configure your default access point. See "Access points," p. 90. For more information on downloading, see "Download," p. 71.

8. Music

■ Music player

To activate music mode and start *Music player*, turn the lower part of the phone so that the playback control keys are on the same side as the display. Or, select **Menu** > *Music* > *Music player*.

Music library

Music library is a database of the available music tracks. In the music library, you can choose the music to listen to, and create and manage playlists.

To open the music library, in the music player main view, scroll to , and press the joystick.

To update the music library and search for music tracks in the phone memory and on the memory card, select **Options** > *Update Music library*. After the update, the changes to the music library are displayed.

You can choose music from the music library in different ways. For example, to play a specific album, select *Albums*, scroll to the album, and select **Options** > *Play*. Or, to listen to specific tracks on the album, select *Albums* and an album, mark the tracks, and select **Options** > *Play*.

To find music by a certain artist, select *Artists* and **Options** > *Find*, and enter the name of the artist. Scroll to the desired artist, and press the joystick. To enter text, you must activate communication mode.

Track lists

To compile and save your own track list, select *Track lists* > **Options** > *New track list*. Select the memory in which to save the track list, and enter a name for the track list. Mark the desired tracks, and press the joystick.

To listen to a track list, select *Track lists*, scroll to the track list, and select **Options** > *Play*.

You can add tracks to a saved track list from other views. For example, to add an album, select *Albums*, locate the album, scroll to it, and select

Options > **Add to track list** > **Saved track list**. Scroll to the track list to which to add the album, and press the joystick.

Listen to music



Warning: Listen to music at a moderate level. Continuous exposure to high volume may damage your hearing.

To start playing or pause playback, press **▶||**. To stop playback, press **■**. To skip to the next or previous track, press **▶▶** or **◀◀**. To fast forward or rewind, press and hold **▶▶** or **◀◀**.

You can only control music playback with the dedicated music keys when the phone is in the music mode.

To see the currently playing playlist, scroll to **📀**, and press the joystick.

To return to the standby mode and leave the music player in the background, press the end key. If **Active standby** is **On**, the currently playing track is displayed in the standby mode. To adjust the music volume in the standby mode, scroll to the currently playing track, and scroll left or right. To access the music player from the standby mode, scroll to the currently playing track, and press the joystick.

You can use many of the phone and camera functions while listening to music (for example, write and send text messages in the communication mode or take photos in the camera mode). When you make a call or there is an incoming call, the music playback is paused. When the call ends, playback resumes.

To play the music tracks repeatedly, select **Options** > **Loop**. Select **All** to repeat all the currently playing tracks, **One** to repeat the currently playing track, or **Off** to not repeat tracks.

To play music in random order, select **Options** > **Random play** > **On**.

To set the currently playing track as your ringing tone in all profiles, select **Options** > **Set as ringing tone**.

Audio settings

With **Audio settings**, you can adjust the balance, add reverberation, widen the stereo image, and boost bass. Select **Options** > **Audio settings**.

Equalizer

With *Equaliser*, you can enhance or diminish frequencies during music playback and modify how your music sounds.

Select **Options** > *Audio settings* > *Equaliser*. To use a preset, scroll to it, and select **Options** > *Activate*.

Create a preset

1. To create a preset, select **Options** > *New preset*, and enter the preset name.
2. To move between frequency bands, scroll left or right. To enhance or diminish sound in the frequency band, scroll up or down.
3. Select **Back**.

■ Visual Radio

You can use the Visual Radio application as a FM radio with automatic tuning and preset stations, or with parallel visual information related to the radio program if you tune in to stations that offer Visual Radio service. The Visual Radio service uses packet data (network service). You can listen to the radio while using other applications.

To use the Visual Radio service, the following requirements must be met:

- The radio station and your network operator must support this service.
- The phone must be switched on.
- Your Internet access point must be defined for access to the network operator's visual radio server.
- The preset radio station must have the correct Visual Radio service ID defined and have Visual Radio service enabled.

Visual Radio cannot be started when the offline profile is active.

If you do not have access to the Visual Radio service, the operators and radio stations in your area may not support Visual Radio. The Visual Radio service may not be available in all areas and countries.

You can listen to FM radio on your phone with the built-in loudspeaker or a compatible headset.

The FM radio depends on an antenna other than the wireless device antenna. A compatible headset or enhancement needs to be attached to the device for the FM radio to function properly.



Warning: Listen to music at a moderate level. Continuous exposure to high volume may damage your hearing.

You can make a call or answer an incoming call while listening to the radio. The radio is turned off when there is an active call.

The quality of the radio broadcast depends on the radio station's coverage in that particular area.

Turn the radio on

Select **Menu** > **Music** > **Radio** to open Visual Radio.

The phone displays the following:

- Station location number and the name of the radio station.
- Frequency of the last used radio station.
- Graphic buttons:
 - and to scroll to the next or previous saved station. The buttons are inactive if there are no saved stations.
 - and to start automatic tuning
 - starts Visual Radio content feed if the visual service ID is defined or asks for the visual service ID if it is not defined

If you have previously saved radio stations, scroll to the station you want to listen to, or select the memory location of a station by pressing the corresponding key 1 to 9.

To adjust the volume, scroll left or right.

When using a compatible headset, press the headset key to scroll to a saved radio station.

To turn the radio off, select **Exit**.

Tune and save a radio station

To start the station search when the radio is on, scroll to or , and press the joystick. Searching stops when a station is found. To save the

station, select **Options** > *Save station*. Scroll to a location for the station with the joystick and select it. Enter the name of the station, and select **OK**.

Use the radio

When the radio is on, select **Options** and from the following options:

Start visual service — Launch viewing of visual content.

Station directory — Activate the station directory (network service) to seek available radio stations and save them for later use.

Save station — Save the radio station.

Stations — Open the station list.

Manual tuning — Set the station frequency manually. To tune, scroll up or down.

If you know the frequency of the radio station you want to listen to, enter it, and select **OK**.

Activate loudspeaker — Listen to the radio using the loudspeaker.

Deactivate loudsp. — Listen to the radio using the headset.

Play in background — Put Visual Radio in the background and display the standby screen. To go back to Visual Radio, select and hold the menu key, and select *Radio*.

Settings — Change or view Visual Radio settings.

Exit — Turn off the radio.

Station list

When the radio is on, select **Options** > *Stations*.

The station list is used for managing the saved radio stations. When you open the list, the currently active station is highlighted if it is saved. Otherwise, the first saved station is highlighted.

Select **Options** and from the following options:

Station > *Listen* — Listen to the selected station.

Station > Edit – View the settings of the highlighted station. See “Station setup,” p. 57.

Station > Move – Move a station to another position within the station list: Highlight the station to be moved, select **Move**, and highlight the position where the selected station is to be moved. Select **OK** to move the station.

Station > Delete – Delete the highlighted station from the station list.

Station directory – Activate the station directory (network service) to seek available radio stations from the network and save them for later use.

Activate loudspeaker – Listen to the radio using the loudspeaker.

Deactivate loudsp. – Listen to the radio using the headset.

Exit – Turn off the radio.

Station setup

Scroll to a station in the station list, press the joystick, and select *Edit* to change the following station parameters:

Name – to edit the name of the station

Location – to edit the location of the radio station

Frequency – to edit the frequency of the station

Visual service ID – to edit the visual service ID

Enable visual service – to allow or deny the viewing of visual content of the current radio station

Select **Back** to return to the station list.

View visual content

You can view visual content if the station is saved in the station list and visual service is enabled for this station.

To check availability and costs, and to subscribe to the service, contact your network operator or service provider.

To view visual content of the current station, scroll to , and press the joystick.

If the visual service ID was not saved in the station list, you are asked for the visual service ID. Enter the visual service ID and select **OK**. If you do not have the visual service ID, select **Retrieve** to access the station directory (network service).

When the connection to the visual service is established, the display shows the current visual content. The visual content can consist of images, text, buttons, and entry fields, and is designed by the content provider.

To navigate the displayed content, scroll up or down.

If no valid visual content is available from the service, the Visual Radio background is displayed.

To end the visual content feed but not the FM radio, select **Close**. To end both, select **Options** > **Exit**.

To set light settings and the power saver time-out, select **Options** > **Display settings**.

Visual Radio settings

When the radio is on, select **Options** > **Settings** and the following:

Start-up tone – to enable or disable the start-up tone

Auto-start service – to enable or disable the automatic display of visual content

Access point – to select the access point

Station directory

With the station directory (network service) you can select Visual Radio enabled or traditional radio stations from a list, grouped in several folders. A folder may represent geographical locations, such as continents, countries, regions, or cities, and can contain other folders or data of radio stations.

To check availability and costs, and to subscribe to the service, contact your network operator or service provider.

Access the station directory from the visual content view

To retrieve the visual service ID and to start visual content for the currently tuned radio station, scroll to , press the joystick, and select *Retrieve*. After the connection to the station directory is established, select the nearest location to your current position from a list of folders, and press the joystick.

The device compares the frequencies of the listed radio stations with the currently tuned in frequency. If a matching frequency is found, the visual service ID of the tuned radio station is displayed. Select **OK** to start viewing the visual content.

If there is more than one radio station with matching frequencies, the radio stations and their visual service ID are displayed in a list.

Scroll to the desired radio station in the list and select it. The tuned radio station and the visual service ID are displayed. Select **OK** to start viewing the visual content.

Access the station directory from Options

To access the station directory (network service) from the station list, select **Options** > *Station directory*.

After the connection to the station directory, you are requested to select the nearest location to your current position from a list of folders. Scroll to the nearest location, and press the joystick. Repeat this process until you reach the list of radio stations near your current position.

Radio stations, which provide visual content are indicated with .

Scroll to the desired radio station, and press the joystick to open the selection menu for radio stations:

Listen – to tune to the highlighted radio station

To confirm the frequency setting, select **Yes**. Select **No** to go back to the previously tuned frequency. The list of radio stations is displayed again and you may select another radio station.

Start visual service – to open the visual content of the selected radio station (if available)

Save – to save the details of the selected radio station to the station list

9. Media

■ Camera

To use the camera, turn the lower part of the phone to activate the camera mode. See "Camera mode," p. 18. Or, select **Menu** > **Media** > **Camera**.

To zoom in or out, press **▶▶** or **◀◀**. To capture an image, press **▶||**. The image is saved to the Images folder in Gallery, and the image is displayed. To return to the viewfinder, select **Back**. To delete the photo, press the clear key.

To capture images sequentially, select **Options** > **Sequence mode** > **On**. When you press **▶||**, the camera captures six images in short intervals and displays the images in a grid.

In dim lighting, to use night mode, select **Options** > **Night mode** > **On**.

To use the self-timer, select **Options** > **Self-timer** and the time you want the camera to wait before capturing the image. Press **▶||**, and the timer starts.

To adjust the white balance or color tone, select **Options** > **Adjust** > **White balance** or **Colour tone**.

To record a video, scroll right to activate the video mode, and press **▶||** to start recording.

Camera settings

Your device supports an image capture resolution of 1600 x 1200 pixels. The image resolution in these materials may appear different.

To change camera settings, select **Menu** > **Media** > **Camera** > **Options** > **Settings**.

Select **Image** and from the following settings:

Image quality and **Image resolution** – The better the image quality and the higher the resolution, the more memory the image consumes.

Show captured img. – To not display the image after capturing, select **No**.

Default image name — Change how the captured images are named.

Memory in use — Select whether you want to save your images in the phone memory or on the memory card.

Select *Video* and from the following settings:

Length — If set to *Maximum*, the length of the recorded video is only restricted by the available memory. If set to *Short*, the recording time is optimized for MMS sending.

Video resolution — Select between two video resolutions.

Default video name — Select how the video clips are named.

Memory in use — Select whether you want to save your video clips in the phone memory or on the memory card.

■ RealPlayer

With RealPlayer, you can play media files such as video clips saved in the phone memory or memory card, or stream media files over the air by opening a streaming link. To open RealPlayer, select **Menu** > *Media* > *RealPlayer*.

RealPlayer does not support all file formats or all the variations of file formats. For example, some .mp4 files may include content not supported by RealPlayer.

Play media files

To play a media file in RealPlayer, select **Options** > *Open* and from the following:

Most recent clips — to play media files that you have recently played

Saved clip — to play media files saved in the phone or memory card

To stream content over the air:

- Select a streaming link saved in the gallery. A connection to the streaming server is established.
- Open a streaming link while browsing the Web.

To stream live content, you must first configure your default access point. See "Access points," p. 90.

Many service providers require you to use an Internet access point (IAP) for your default access point. Other service providers allow you to use a WAP access point. Contact your service provider for more information.

In RealPlayer, you can only open an `rtsp://` URL address. You cannot open an `http://` URL address; however, RealPlayer recognizes an `http` link to a `.ram` file since a `.ram` file is a text file containing an `rtsp` link.



Warning: Do not hold the device near your ear when the loudspeaker is in use, because the volume may be extremely loud.

Shortcuts during play

Scroll up to seek forward or down to seek back in the media file.

Scroll left or right to increase or decrease the sound volume.

Settings

Select **Options** > **Settings** > **Video** and from the following settings:

Contrast – To change the contrast, scroll left or right.

Loop – Select **On** to have the currently playing video or audio file restart automatically after it is finished.

Select **Connection** and from the following settings:

Proxy – to define a proxy server for streaming







Network – to define network settings

- **Default access point** – Define the access point used for streaming.
- **Online time** – If you want to disconnect automatically after a period of inactivity while the playback is paused, select **User defined** and enter the time in minutes (max. 30 minutes).
- **Lowest UDP port** and **Highest UDP port** – Define the port range to be used for the connection.

■ Recorder

The voice recorder allows you to record phone conversations and voice memos. If you record a phone conversation, all parties hear a beeping sound during recording.

Recorded files are stored in *Gallery*. See "Gallery," p. 50.

Select **Menu** > *Media* > *Recorder*. Select **Options** > *Record sound clip*, or select . To pause recording, select . To stop recording, select . To rewind or fast forward, select  or . To listen to the recording, select .

■ Flash Player

With *Flash Player*, you can view, play, and interact with flash files made for mobile devices.

Organize flash files

Select **Menu** > *Media* > *Flash Player*, and scroll right.

To open a folder or play a flash file, scroll to it, and press the joystick.

To send a flash file to a compatible device, scroll to it, and press the call key.

To copy a flash file to another folder, select *Organise* > *Copy to folder*.

To move a flash file to another folder, select *Organise* > *Move to folder*.

To create a folder to organize your flash files, select *Organise* > *New folder*.

The available options may vary.

To delete a flash file, scroll to it, and press the clear key.

Play flash files

Select **Menu** > *Media* > *Flash Player*. Scroll to a flash file, and press the joystick.

Select **Options** and from the following:

Pause – to pause the playback

Stop – to stop the playback

Volume – to adjust the playback volume. To increase or decrease the volume, scroll left or right.

Quality – to select the playback quality. If the playback appears uneven and slow, change the **Quality** setting to **Normal** or **Low**.

Full screen – to play the file using the entire display. To return to the normal screen, select **Normal screen**.

The key functions are not visible in full screen, but they may still be available when you press either key below the display.

Fit to screen – to play the file in its original size after zooming it

Pan mode on – to be able to move around the display with the joystick when you have zoomed in

Options may not be available in all flash files. The available options may vary.

■ Video editor

To create custom video clips, select **Menu > Media > Vid. editor**. You can create custom video clips, combine and trim video clips, and add sound clips, transitions, and effects. Transitions are visual effects that you can add in the beginning and end of the video or between the video clips.



Tip! To take a snapshot of a video clip, select **Options > Take snapshot** in the **Cut video clip** view.

Edit video, sound, and transitions

1. In the **Edit video clip** view, to insert video clips you want to edit, select **Insert > Video clip**.
2. You can edit the clips by trimming and adding effects. You can add sound clips and change their duration.

To modify the video, select **Options** and from the following options:

Movie > Preview – previews the custom video clip

Insert > Video clip – inserts the selected video clip. A thumbnail of the video clip is shown in the main view. A thumbnail consists of the first nonblack view of the video clip. The name and length of the selected video clip is also shown.

Insert > Image – inserts an image

Insert > Text – inserts a title, subtitle, or credits

Insert > Sound clip – inserts the selected sound clip. The name and length of the selected sound clip is shown in the main view.

Insert > New sound clip – records a new sound clip to the selected location

Edit video clip or *Edit sound clip > Cut* – trims the video clip or a sound clip

Edit video clip or *Edit sound clip > Duplicate* – makes a copy of the selected video clip or sound clip

Edit video clip > Move – moves the video clip to the selected location

Edit video clip > Add colour effect – inserts a color effect on the video clip

Edit video clip > Use slow motion – slows the speed of the video clip

Edit video clip > Mute sound/Unmute sound – mutes or unmutes the original video clip sound

Edit video clip > Remove – removes the video clip from the video

Edit sound clip > Move – moves the sound clip to the selected location

Edit sound clip > Remove – removes the sound clip from the video

Edit transition – There are three types of transitions: at the start of a video, at the end of a video, and transitions between video clips. A start transition can be selected when the first transition of the video is active.

3. Select *Save* to save your video. Define the *Memory in use* in *Settings*. The default is the phone memory.



Tip! In the settings view you can define the *Default video name*, *Default sc. shot name*, *Resolution*, and *Memory in use*.

Select *Send > Via multimedia*, *Via Bluetooth*, or *Via e-mail* if you want to send the video. Contact your service provider for details of the maximum multimedia message size that you can send. If your video is too large to be sent in a multimedia message,  appears.



Tip! If you want to send a video clip that is over the maximum multimedia message size allowed by your service provider, you can send the clip using a Bluetooth connection. See "Send data using Bluetooth technology," p. 105. You can also transfer your videos using a Bluetooth connection into your Bluetooth-enabled personal computer, or by using a memory card reader (internal/external).

10. Services

Select **Menu** > **Services** or press and hold 0 in standby mode.

Various service providers maintain pages specifically designed for mobile phones. With the mobile browser, you can view these services as WAP pages written in HTML, WML, XHTML, or a mixture of WML and XHTML. If you have not yet used your phone to make a WAP connection, you may need to contact your service provider for assistance with the first-time connection.

Check the availability of services, pricing, and tariffs with your network operator or service provider. Service providers also give you instructions on how to use their services.

■ Basic steps for access

1. Save the settings that are needed to access the browser service that you want to use. See "Set up the phone for the browser service," p. 67.
2. Make a connection to the service. See "Make a connection," p. 68.
3. Start browsing the Web pages. See "Browse Web pages," p. 70.
4. End the connection to the service. See "End a connection," p. 71.

■ Set up the phone for the browser service

Receive settings in a configuration message

You may receive service settings in a configuration message, from the network operator or service provider that offers the service. See "Special message types," p. 36. For more information, contact your network operator or service provider.

Enter the settings manually

Follow the instructions given to you by your service provider.

1. Select **Menu** > **Tools** > **Settings** > **Connection** > **Access points**, and define the settings for an access point. See "Connection," p. 89.
2. Select **Menu** > **Services** > **Options** > **Bookmark manager** > **Add bookmark**. Write a name for the bookmark and the address of the browser page defined for the current access point.
3. To set the created access point as the default access point in **Services**, select **Services** > **Options** > **Settings** > **Access point**.

■ Make a connection

Once you have stored all the required connection settings, you can access browser pages.

There are three different ways to access browser pages:

- Select the home page () of your service provider.
- Select a bookmark from the bookmarks view.
- Press the keys 1–9 to start to write the address of a browser service. The **Go to** field at the bottom of the display is immediately activated, and you can continue writing the address there.



After you have selected a page or written the address, press the joystick to start to download the page.

■ View bookmarks

Your device may have some bookmarks loaded for sites not affiliated with Nokia. Nokia does not guarantee or endorse these sites. If you choose to access them, you should take the same precautions, for security or content, as you would with any Internet site.

In the bookmarks view, you can see bookmarks pointing to different kinds of browser pages. Bookmarks are indicated by the following icons:

 The starting page defined for the default access point. If you use another default access point for browsing, the starting page changes accordingly.

 The automatic bookmarks folder contains bookmarks () that are collected automatically when you browse pages. The bookmarks in this folder are automatically organized according to domain.

 Any bookmark showing the title or Internet address of the bookmark.

Add bookmarks manually

1. In the bookmarks view, select **Options** > *Bookmark manager* > *Add bookmark*.
2. Fill in the fields. Only the address must be defined. The default access point is assigned to the bookmark if no other one is selected. Press * to enter special characters such as /, ., :, and @. Press the clear key to clear characters.
3. Select **Options** > *Save* to save the bookmark.

Send bookmarks in a text message

Scroll to a bookmark, and select **Options** > *Send* > *Via text message*. You can send more than one bookmark at the same time.

■ Connection security

If the security indicator  is displayed during a connection, the data transmission between the device and the Internet gateway or server is encrypted.

The security icon does not indicate that the data transmission between the gateway and the content server (or place where the requested resource is stored) is secure. The service provider secures the data transmission between the gateway and the content server.

Select **Options** > *Details* > *Security* to view details about the connection, encryption status, and information about server and user authentication.

Security features may be required for some services, such as banking services. For such connections you need security certificates. For more information, contact your service provider. See also "Certificate management," p. 95.

■ Browse Web pages

On a browser page, new links appear underlined in blue and previously visited links in purple. Images that act as links have a blue border around them.

Keys and commands for browsing

To open a link, press the joystick.

To scroll the view, move the joystick.

To enter letters and numbers in a field, press the keys 0–9. Press * to enter special characters such as /, ., :, and @. Press the clear key to clear characters.

To go to the previous page while browsing, select **Back**. If **Back** is not available, select **Options** > *Navigation options* > *History* to view a chronological list of the pages visited during a browsing session. The history list is cleared each time a session is closed.

To check boxes and make selections, press the joystick.

To retrieve the latest content from the server, select **Options** > *Navigation options* > *Reload*.

To open a sublist of commands or actions for the currently open browser page, select **Options** > *Service options*.

Save bookmarks

To save a bookmark while browsing, select **Options** > *Save as bookmark*.

To save a bookmark received in a message, select **Options** > *Save to bookmarks*. See "Special message types," p. 36.

View saved pages

If you regularly browse pages containing information that does not change very often, you can save and then browse them when offline.

To save a page while browsing, select **Options** > *Advanced options* > *Save page*. Saved pages are indicated by .

In the saved pages view you can create folders for your saved browser pages. Folders containing saved Web pages are indicated by .

To open the saved pages view, scroll right in the bookmarks view. In the saved pages view, press the joystick to open a saved page.

To start a connection to the browser service and retrieve the page again, select **Options** > *Navigation options* > *Reload*.

The phone stays online after you reload the page.

■ Download

You can download items such as ringing tones, images, operator logos, software, and video clips using the mobile browser. These items can be provided free or you can purchase them.

Once downloaded, items are handled by the respective applications on your phone, for example, a downloaded photo is saved in the gallery.

Copyright protections may prevent some images, music (including ringing tones), and other content from being copied, modified, transferred or forwarded.



Important: Only install and use applications and other software from sources that offer adequate security and protection against harmful software.

■ End a connection

Select **Options** > *Advanced options* > *Disconnect* to end the connection and view the browser page offline, or select **Options** > *Exit* to quit browsing and to return to the standby mode.

■ Empty the cache

A cache is a memory location that is used to store data temporarily. If you have tried to access or have accessed confidential information requiring passwords, empty the cache after each use. The information or services you have accessed is stored in the cache memory of the phone. To empty the cache, select **Menu** > *Services* > **Options** > *Advanced options* > *Clear cache*.

■ Browser settings

Select **Options** > **Settings** and from the following:

Access point – To change the default access point, press the joystick to open a list of available access points. The current default access point is highlighted. See "Connection," p. 89.

Homepage – Enter the address of a Web page that you want as your homepage.

Load imgs. & sounds – Select whether to view pictures and hear sounds when you are browsing. If you select **No**, to later load images and sounds during browsing, select **Options** > **Show images**.

Text wrapping – Control whether all text in Web pages is wrapped automatically. This setting is not available when **Advanced options** > **Small screen** is selected.

Font size – Select the font size.

Default encoding – When you select **Automatic**, the browser automatically tries to choose the correct character encoding.

Auto. bookmarks – Select **On** if you want the bookmarks to be automatically saved in the **Auto. bookmarks** folder when you visit a page. When you select **Hide folder**, the bookmarks are still automatically added to the folder.

Screen size – Choose how to use the display area for viewing pages.

Search page – Enter the address of a search page that you want to open while browsing.

Volume – Select the volume for music or other sound in Web pages.

Rendering – Select the image quality for the pages. With the high image quality, the page download speed is slower.

Cookies > **Allow/Reject** – Enable or disable the receiving and sending of cookies (a means for content providers to identify users and their preferences for frequently used content).

Java/Ecma Script – Enable or disable the use of scripts.

Security warnings – Hide or show security notifications.

Conf. DTMF sending > *Always/First time only* – Choose whether you want to confirm before the phone sends DTMF tones during a voice call. See "Options during a call," p. 26. For example, you can make a voice call while you are viewing a browser page, send DTMF tones while a voice call is in progress, and save a name and phone number from a browser page into contacts.

11. My own

■ Themes

To change the look of your phone's display, activate a theme. A theme can include the standby mode wallpaper and power saver. You can edit a theme to personalize your phone further.

Select [Menu](#) > [My own](#) > [Themes](#). You see a list of the available themes. The active theme is indicated by a check mark.

To preview a theme, scroll to the theme, and select [Options](#) > [Preview](#) to view the theme. Select [Apply](#) to activate the theme. To activate the theme without previewing it, select [Options](#) > [Apply](#) from the main view.

Edit a theme:

1. Scroll to a theme, select [Options](#) > [Edit](#), and select from the following:

[Wallpaper](#) — Select an image from one of the available themes, or select your own image from the gallery to use as a background image in the standby mode.

[Power saver](#) — Select what is shown on the power saver bar: the time and date or a text that you have written yourself. The location and background color of the power saver bar moves on the display in intervals. Also, the power saver changes to indicate the number of new messages or missed calls. You can set the time-out before the power saver is activated. See "Phone," p. 88.

2. Scroll to the element to be edited and press the joystick.
3. To preview the selected element, select [Options](#) > [Preview](#). You cannot preview all elements. Select [Options](#) > [Set](#) to select the current setting.

To restore the currently selected theme to its original settings, select [Options](#) > [Restore orig. theme](#) when editing a theme.

■ Sound meter

The sound meter lets you measure the noise level of the environment.

The sound meter provides general measurements for personal use that may vary from scientific measurements.

Select **Menu** > *My own* > *Sound meter* to display the noise level of your surroundings in units of dB.

Select **Options** and from the following:

Hold peak – The peak value is held in the measured maximum until you exit the application.

Weighting options – Select *A weighting* to simulate the ear in a noisy environment, *C weighting* to simulate the ear in a quiet environment, or *Off* to measure without a weighting algorithm

Dynamic peak – The current peak value is kept for 5 sec.

Reset peak – The current peak value is reset.

If the peak or current value is higher than 114 dB or lower than 50 dB a > or < character is shown before the value.

12. Organizer

■ Clock

Select [Menu](#) > [Organiser](#) > [Clock](#).

Clock settings

To change the time or date, select [Options](#) > [Settings](#). For more information about the settings, see "Date and time," p. 94.

Set an alarm

1. To set a new alarm, select [Options](#) > [Set alarm](#).
2. Enter the alarm time and select **OK**. When the alarm is active,  is shown.

To cancel an alarm, select [Options](#) > [Remove alarm](#).

Turn off the alarm

Select [Stop](#) to turn off the alarm.

Select [Snooze](#) to stop the alarm for 5 minutes, after which it resumes. You can do this a maximum of five times.

If the alarm time is reached while the device is switched off, the device switches itself on and starts sounding the alarm tone. If you select [Stop](#), the device asks whether you want to activate the device for calls. Select [No](#) to switch off the device or [Yes](#) to make and receive calls. Do not select [Yes](#) when wireless phone use may cause interference or danger.

Personalize the alarm tone

1. To personalize the alarm tone, select [Options](#) > [Settings](#).
2. Scroll to [Clock alarm tone](#), and press the joystick.
3. When you scroll through the list of tones, you can stop on a tone to listen to it before you make your selection. Select the tone.

■ Calendar

Select **Menu** > *Organiser* > *Calendar*.

In the calendar, you can keep track of your appointments, meetings, birthdays, anniversaries, and other events. You can also set a calendar alarm to remind you of upcoming events.

Create calendar entries

1. Select **Options** > *New entry* and from the following:

Meeting – reminds you of an appointment that has a specific date and time

Memo – a general entry for a day

Anniversary – reminds you of birthdays or special dates. Anniversary entries are repeated every year.

To-do – a to-do note

2. Fill in the fields:

Subject/Occasion – Write a description of the event.

Location – Enter the place of a meeting (optional).

Start time, *End time*, *Start date*, and *End date*

Alarm – Press the joystick to activate the fields for *Alarm time* and *Alarm date*.

Repeat – Press the joystick to change the entry to be repeated. A repeating entry is indicated by  in the day view.

Repeat until – Set an ending date for the repeated entry, for example, the last date of a weekly course you are taking. This option is shown only if you have selected to repeat the event.

Synchronisation > *Private* – After synchronization the calendar entry can be seen only by you, and it is not shown to others even if they have online access to view the calendar. *Public* – The calendar entry is shown to others who have access to view your calendar online. *None* – The calendar entry is not copied when you synchronize your calendar.

3. To save the entry, select **Done**.

When editing or deleting a repeated entry, choose how you want the changes to take effect:

All occurrences – All repeated entries are changed.

This entry only – Only the current entry is changed.

Calendar views

Press # in the month, week, or day views to automatically highlight today's date.

To write a calendar entry, press any number key (0–9) in any calendar view. A meeting entry opens, and the characters entered are added to the *Subject* field.

To go to a certain date, select **Options** > *Go to date*. Write the date, and select **OK**.

To-do

Select **Options** > *To-do view*.

In the *To-do view*, you can keep a list of tasks that you need to do.

Create a to-do note

1. To start to write a to-do note, press any number key (0–9). The editor opens, and the cursor blinks after the letters you have entered.
2. Write the task in the *Subject* field. Press * to add special characters.
To set the due date for the task, scroll to the *Due date* field, and enter a date.
To set a priority for the to-do note, scroll to the *Priority* field, and press the joystick.
3. To save the to-do note, select **Done**.

Handle to-do notes

To open a to-do note, scroll to it, and press the joystick.

To delete a to-do note, scroll to it, and select **Options** > *Delete* or press the clear key.

To mark a to-do note as completed, scroll to it, and select **Options** > *Mark as done*.

To restore a completed to-do note as not completed, select **Options** > *Mark as not done*.

■ Converter

Select **Menu** > *Organiser* > *Converter*.

In the converter, you can convert measurement parameters such as *Length* from one unit to another, for example, *Yards* to *Metres*.

The converter has limited accuracy and rounding errors may occur.

Convert units

To convert currency, you must first set the exchange rate. See "Set a base currency and exchange rates," p. 79.

1. Scroll to the *Type* field, and press the joystick to open a list of measurement parameters. Scroll to the measurement parameter you want to use, and select **OK**.
2. Scroll to the first *Unit* field and press joystick to open a list of available units. Select the unit **from** which you want to convert and select **OK**.
3. Scroll to the next *Unit* field, and select the unit to which you want to convert.
4. Scroll to the first *Amount* field, and enter the value that you want to convert. The other *Amount* field changes automatically to show the converted value.

Press **#** to add a decimal and press ***** for the **+**, **-** (for temperature), and **E** (exponent) symbols.

The conversion order changes if you write a value in the second *Amount* field. The result is shown in the first *Amount* field.

Set a base currency and exchange rates

Before you can convert currency, you need to choose a base currency (usually your domestic currency) and add exchange rates.

The rate of the base currency is always 1. The base currency determines the conversion rates of the other currencies.

1. Select **Currency** as the measurement parameter type, and select **Options > Currency rates**. A list of currencies opens; you can see the current base currency at the top.
2. To change the base currency, scroll to the currency (usually your domestic currency), and select **Options > Set as base curr.**
3. Add exchange rates, scroll to the currency, and enter a new rate, that is, how many units of the currency equal one unit of the base currency you selected.
4. After you insert all the required exchange rates, you can convert currency. See "Convert units," p. 79.



Note: When you change base currency, you must enter new exchange rates because all previously set exchange rates are cleared.

■ Notes

Select **Menu > Organizer > Notes**.

You can send notes to other devices. You can save plain text files (TXT format) you receive to notes.

Press keys 1–9 to start to write. Press the clear key to clear letters.

Select **Done** to save.

■ Calculator

Select **Menu > Organizer > Calculator**.



1. Enter the first number of your calculation. If you make a mistake, press the clear key to erase it.
2. Scroll to an arithmetic function, and press the joystick to select it.
3. Enter the second number.
4. To execute the calculation, scroll to **=** and press the joystick.



Note: This calculator has limited accuracy and is designed for simple calculations.

To add a decimal, press **#**.

Press and hold the clear key to clear the result of the previous calculation.

Use  and  to view previous calculations and move in the sheet.

■ File manager

Select **Menu** > *Organiser* > *File mgr.*

In the file manager, you can browse, open, and manage files and folders in the phone memory or on the memory card.

Open the file manager to see a list of the folders in the phone memory. Scroll right to see the folders on the memory card.

You can browse, open, and create folders; and mark, copy, and move items to folders.

View memory consumption

If you have a memory card installed in your phone, you have a choice of two memory views, one for the phone memory and one for the memory card.

Move the joystick to the right or to the left to move from one memory tab to another.

To check memory consumption of the current memory, select **Options** > *Memory details*.

The phone calculates the approximate amount of free memory for storing data and installing new applications.

In the memory views, you can view the memory consumption of the different data groups: *Calendar*, *Contacts*, *Documents*, *Images*, *Sound files*, *Video clips*, *Messages*, *Applications*, *Memory in use*, and *Free memory*.

If the phone memory is getting low, remove some files, or move them to the memory card.

■ Memory card

Keep all memory cards out of the reach of small children.

Select [Menu](#) > [Organiser](#) > [Memory](#).

For details on inserting a memory card into the phone, see "Get started," p. 12. You can use it to store your multimedia files such as video clips, music tracks, and sound files, photos, and messaging data, and to back up information from phone memory.

Included with your phone is a microSD memory card that may contain add-on applications from independent developers. These applications are designed by the developers to be compatible with your phone.

Details of how you can use the memory card with other features and applications of your phone are given in the sections describing these features and applications.

The third-party applications provided on the microSD card have been created and are owned by persons or entities that are not affiliated with or related to Nokia. Nokia does not own the copyrights or intellectual property rights to these third-party applications. As such, Nokia does not take responsibility for any end-user support or the functionality of these applications, nor the information presented in the applications or these materials. Nokia does not provide any warranty for these applications.

YOU ACKNOWLEDGE THE SOFTWARE AND/OR APPLICATIONS (COLLECTIVELY, THE SOFTWARE) ARE PROVIDED AS IS WITHOUT WARRANTY OF ANY KIND EXPRESS OR IMPLIED AND TO THE MAXIMUM EXTENT PERMITTED BY APPLICABLE LAW. NEITHER NOKIA NOR ITS AFFILIATES MAKE ANY REPRESENTATIONS OR WARRANTIES, EXPRESS OR IMPLIED, INCLUDING BUT NOT LIMITED TO WARRANTIES OF TITLE, MERCHANTABILITY OR FITNESS FOR A PARTICULAR PURPOSE, OR THAT THE SOFTWARE WILL NOT INFRINGE ANY THIRD-PARTY PATENTS, COPYRIGHTS, TRADEMARKS, OR OTHER RIGHTS.

Format the memory card

When a memory card is formatted, all data on the card is permanently lost.

Some memory cards are supplied preformatted and others require formatting. Consult your retailer to find out if you must format the memory card before you can use it.

1. Select [Options](#) > [Format mem. card](#).
2. Select [Yes](#) to confirm.

3. When formatting is complete, enter a name for the memory card (max. 11 letters or numbers).

Back up and restore information

To back up information from phone memory to the memory card, select **Options** > *Backup phone mem.*

To restore information from the memory card to the phone memory, select **Options** > *Restore from card.*

You can only back up the phone memory and restore it to the same phone.

Lock the memory card

To set a password to lock your memory card to help prevent unauthorized use, select **Options** > *Set password.*

You are asked to enter and confirm your password. The password can be up to eight characters long.

The password is stored in your phone and you do not have to enter it again while you are using the memory card on the same phone. If you want to use the memory card on another phone, you are asked for the password.

Unlock a memory card

If you insert another password-protected memory card into your phone, you are prompted to enter the password of the card. To unlock the card, select **Options** > *Unlock memory card.*

Once the password is removed, the memory card is unlocked and can be used on another phone without a password.

Check memory consumption

To check the memory consumption of different data groups and the available memory for installing new applications or software on your memory card, select **Options** > *Memory details.*

13. Tools

■ Voice commands

You can call contacts and carry out phone functions by saying voice commands.

To select the phone functions to activate with a voice command, select **Menu** > **Tools** > **Voice comm..** The voice commands for changing profiles are in the **Profiles** folder.

To activate a new voice command for an application, select **Options** > **New application** and the application.

To manage the voice commands, scroll to a function, select **Options** and from the following options:

Change command or **Remove application** – to change or deactivate the voice command of the selected function

Playback – to play the activated voice command

To use voice commands, see “Enhanced voice dialing,” p. 25.



Note: Using voice tags may be difficult in a noisy environment or during an emergency, so you should not rely solely upon voice dialing in all circumstances.

To change voice command settings, select **Options** > **Settings** and from the following options:

Synthesiser – to activate or deactivate the text-to-speech synthesizer that says out loud the recognized voice command

Reset voice adapts. – to reset the voice adaptations. The phone adapts to the user’s voice to better recognize the voice commands.

■ Voice mailbox

To define or change the voice mailbox number, select **Menu** > **Tools** > **Voice mail** > **Options** > **Define number** or **Change number**, and enter the number. Voice mailbox is a network service. Contact your network operator for the voice mailbox number.

■ Speed dial

To assign phone numbers to the speed dialing keys, select **Menu** > **Tools** > **Spd. dial**, scroll to the speed dialing key, and select **Options** > **Assign**. Select the contact and the number for the speed dial.

To view the number assigned to a speed-dialing key, scroll to the speed dialing key, and select **Options** > **View number**. To change or remove the number, select **Change** or **Remove**.

■ Profiles

Select **Menu** > **Tools** > **Profiles**.

In **Profiles**, you can adjust and personalize the phone tones for different events, environments, or caller groups. You can see the currently selected profile at the top of the display in the standby mode. If the **General** profile is in use, only the current date is shown.

To activate the profile, scroll to a profile, press the joystick, and select **Activate**.



Tip: To quickly change between the **General** and **Silent** profile, in the standby mode, press and hold **#**.

To modify a profile, scroll to the profile in the profile list, press the joystick, and select **Personalise**. To create a new profile, select **Options** > **Create new**. A list of profile settings opens. Scroll to the setting you want to change, and press the joystick to open the choices:

Ringtone — To set the ringing tone for voice calls, choose a ringing tone from the list. Press any key to stop the sound. You can also change ringing tones in contacts. See "Add a ringing tone," p. 48.

Say caller's name — Select **On** to have the phone say the caller's name when the phone is ringing.

Ring type — When **Ascending** is selected, the ringing volume starts from level one and increases level by level to the set volume level.

Ring volume — Set the volume level for the ringing and message alert tones.

Message alert tone — Set the alert tone for text and multimedia messages.

E-mail alert tone – Set the alert tone for e-mail messages.

Vibrating alert – Set the phone to vibrate to alert for incoming calls and messages.

Keypad tones – Set the volume level for keypad tones.

Warning tones – Activate or deactivate warning tones. The phone sounds a warning tone, for example, when the battery is running low.

Alert for – Set the phone to ring only upon calls from phone numbers that belong to a selected contact group. Phone calls coming from people outside the selected group have a silent alert. The choices are *All calls* or a list of contact groups, if you have created any.

Camera start-up tone and *Music Player start-up tone* – Set start-up tones for the camera and the music player.

Profile name – Name the profile. This setting is not shown for the *General* and *Offline* profiles.

When using the *Offline* profile, the phone is not connected to the network. You can use certain functions of the phone without a SIM card by starting the phone with the *Offline* profile.

In the offline profile, you may need to enter the lock code and change the device to a calling profile before making any call, including a call to an emergency number.



Warning: In the offline profile you cannot make or receive any calls, including emergency calls, or use other features that require network coverage. To make calls, you must first activate the phone function by changing profiles. If the device has been locked, enter the lock code.

■ Settings

Phone

General

Select **Menu** > *Tools* > *Settings* > *Phone* > *General* and from the following options:

Phone language – to change the language for the display texts in your phone. This change may also affect the format used for date and time

and the separators used, for example, in calculations. If you select *Automatic*, the phone selects the language according to the information on your SIM card. After you have changed the display text language, the phone restarts.

Changing the settings for *Phone language* or *Writing language* affects every application in your phone, and the change remains effective until you change these settings again.

Writing language – to change the writing language of your phone.

Changing the language affects the characters and special characters available when writing text and the predictive text dictionary used.

Predictive text – to set predictive text input *On* or *Off* for all editors in the phone. Select a language for entering predictive text from the list. To change this setting when you are in an editor, press the edit key, and select *Predictive text > Off* or *Predictive text on*.

Welcome note / logo – to set the welcome note or logo which is displayed briefly each time you switch on the phone. To use the default image or animation, select *Default*. To write your own welcome note (max. 50 characters), select *Text*. To select a photo or picture from the gallery, select *Image*.

Orig. phone settings – to reset some of the settings to their original values. You need the lock code. See "Security," p. 94. After resetting, the phone may take a longer time to power up. All documents and files that you have created are left as they are.

Standby mode

Select *Menu > Tools > Settings > Phone > Standby mode* and from the following options:

Active standby – to set the active standby mode *On* or *Off*. By default, active standby is on. See "Active standby mode," p. 19.

Left selection key and *Right selection key* – to assign a shortcut to the left and right selection keys in the standby mode

Active standby apps. – to select the application shortcuts you want to appear in the active standby. This setting is available only if *Active standby* is set to *On*.

Navigation key right, *Navigation key left*, *Navigation key down*, *Navigation key up*, and *Selection key* – to assign function shortcuts for scrolling in different directions or pressing the joystick in the standby mode. The joystick shortcuts are not available if *Active standby* is *On*.

Operator logo – this setting is visible only if you have received and saved an operator logo. You can select whether the operator logo is shown.

Display

Select **Menu** > *Tools* > *Settings* > *Phone* > *Display* and from the following options:

Brightness – to adjust the brightness of the display

Power saver time-out – to set the time-out for the power saver to activate. When the power saver is active, the display is cleared and you can see the power saver bar. To deactivate the power saver, press any key.

Light time-out – to set the time-out for the phone backlights

Call

Select **Menu** > *Tools* > *Settings* > *Call* and from the following options:

Send my caller ID (network service) – to set your phone number to be displayed (*Yes*) or hidden (*No*) from the person whom you are calling. The value may be set by your network operator or service provider when you subscribe to the service (*Set by network*).

Call waiting (network service) – to set the network to notify you of a new incoming call while you have a call in progress. To request the network to activate call waiting, select *Activate*. To request the network to deactivate call waiting, select *Cancel*. To check whether the function is active, select *Check status*.

Reject call with SMS – to enable rejecting phone calls with a text message. See "Answer or reject a call," p. 26.

Message text – to enter a text to be sent in a text message when you reject a call

Automatic redial – to set the phone to make a maximum of 10 attempts to connect the call after an unsuccessful call attempt. Press the end key to stop automatic redialing.

Summary after call – to set the phone to briefly display the approximate duration of the last call

Speed dialling > On – to set the phone to dial the numbers assigned to the speed dialing keys 2 to 9 by pressing and holding the corresponding number key

Anykey answer > On – to answer an incoming call by briefly pressing any key, except the right selection key, the power key, and the end key

Line in use (network service) – this setting is shown only if the SIM card supports two subscriber numbers, that is, two phone lines. Select which phone line (*Line 1* or *Line 2*) you want to use for making calls and sending short messages. Calls on both lines can be answered irrespective of the selected line.

You cannot make calls if you select *Line 2* and have not subscribed to this network service.

To prevent line selection, select *Line change > Disable* if supported by your SIM card. To change this setting, you need the PIN2 code.

Connection

Your phone supports packet data connections , such as GPRS in the GSM network. See "Indicators," p. 20. To establish a data connection, an access point is required. You can define different kinds of access points:

- MMS access point to send and receive multimedia messages
- Access point for the Web application to view WML or XHTML pages
- Internet access point (IAP) (for example, to send and receive e-mail)

Check which kind of access point you need with your service provider for the service you wish to access. For availability and subscription to packet data connection services, contact your network operator or service provider.

Receive access point settings

You may receive access point settings in a message from your service provider, or you may have preset access point settings in your phone.

Access points

To create a new access point or edit an existing access point, select **Menu > Tools > Settings > Connection > Access points > Options > New access point** or **Edit**. If you create a new access point, use the settings of an existing access point as a basis by selecting **Use existing settings**, or start with default settings by selecting **Use default settings**.

Follow the instructions from your network operator or service provider.

Connection name — to give a descriptive name for the connection

Data bearer — The options are **Packet data**, **Data call**, and **High speed (GSM)**. Depending on what data connection you select, only certain setting fields are available. Fill in all fields marked with **Must be defined**, or with an asterisk. Other fields can be left empty, unless you have been instructed otherwise by your service provider.

To be able to use a data connection, the network operator or service provider must support this feature, and if necessary, activate it for your SIM card.

Access point name (for packet data only) — The access point name is needed to establish a connection to the GPRS network. You obtain the access point name from your network operator or service provider.

Dial-up number (for data call only) — the modem telephone number of the access point

User name — The user name may be needed to make a data connection and is usually provided by the service provider. The user name is often case-sensitive.

Prompt password — If you must enter a new password every time you log onto a server, or if you do not want to save your password to the phone, select **Yes**.

Password — A password may be needed to make a data connection, and is usually provided by the service provider. The password is often case-sensitive.

Authentication — *Normal* or *Secure*

Homepage — Depending on whether you are setting up an Internet access point or MMS access point, enter the Web address or the address of the multimedia messaging center.

Data call type (for data call only) — *Analogue*, *ISDN v.110*, or *ISDN v.120* defines whether the phone uses an analog or digital connection. This setting depends on your GSM network operator and Internet service provider (ISP), because some GSM networks do not support certain types of ISDN connections. For details, contact your ISP. If ISDN connections are available, they establish connections more quickly than analog methods.

Max. data speed (for data call only) — The options are *Automatic*, 9600, 14400, 19200, 28800, 38400 or 43200, depending on the chosen *Data call type*. This option allows you to limit the maximum connection speed when a data call connection is used.

The speeds represent the maximum speed at which your connection operates. During the connection, the operating speed may be less, depending on network conditions.

Select **Options** > *Advanced settings* to change the following options:

Network type (for packet data only) — to select the Internet protocol (IP) version of the network: *IPv4* or *IPv6*. The other settings depend on the selected network type.

IPv4 settings and *IPv6 settings* (for data call only) — to select the Internet protocol settings. The settings depend on the network type.

Phone IP address (for IPv4) — to enter the IP address of your phone

DNS address — to enter the IP address of the primary and secondary DNS servers

Proxy serv. address — to enter the IP address of the proxy server

Proxy port number — to enter the port number of the proxy server

Contact your Internet service provider for the necessary settings.

The following settings are shown if you have selected data call as the connection type:

Use callback > *Yes* – to allow a server to call you back once you have made the initial call. Contact your service provider to subscribe to this service.

The phone expects the callback call to use the same data call settings that were used in the callback-requesting call. The network must support that type of call in both directions, to and from the phone.

Callback type – The options are *Use server no.* and *Use other no.*. Ask your service provider for the correct setting to use.

Callback number – to enter your phone number which the dial-back server uses. Usually, this number is the data-call phone number of your phone.

Use PPP compress. – To speed up data transfer, select *Yes* if supported by the remote PPP server. If you have problems with establishing a connection, select *No*. Contact your service provider for guidance.

Use login script > *Yes* – to use a login script when establishing the connection

Login script – to insert the login script

Modem initialisation (modem initialization string) – to control your phone using modem AT commands. If required, enter commands specified by your service provider or Internet service provider.

Packet data

The packet data settings affect all access points using a packet data connection.

Select **Menu** > *Tools* > *Settings* > *Connection* > *Packet data* and from the following options:

Packet data conn. – If you select *When available* and you are in a network that supports packet data, the phone registers to the GPRS network and short messages are sent using GPRS. Also, starting an active packet data connection, for example, to send and receive e-mail, is quicker. If you select *When needed*, the phone uses a packet data connection only if you start an application or function that needs it. The

GPRS connection can be closed when it is not needed by any application.

If there is no GPRS coverage and you have chosen *When available*, the phone periodically tries to establish a packet data connection.

Access point — The access point name is needed when you want to use your phone as a packet data modem to your computer.

SIP settings

Session Initiation Protocol (SIP) profiles include the settings for communications sessions using SIP, such as push to talk calls. To view, create, and edit SIP profiles, select **Menu** > *Tools* > *Settings* > *Connection* > *SIP settings*.

Data call

The *Data call* settings affect all access points that use a GSM data call. Select **Menu** > *Tools* > *Settings* > *Connection* > *Data call* and from the following options:

Online time — to set the data call to disconnect automatically after a time-out if there is no activity. To enter a time-out, select *User defined*, and enter the time in minutes. If you select *Unlimited*, the data call is not disconnected automatically.

Configurations

Certain functions, such as Web browsing and multimedia messaging, may require configuration settings. You may receive the settings from your service provider. See "Configuration settings service," p. 10.

To view the list of configurations saved to your phone, select **Menu** > *Tools* > *Settings* > *Connection* > *Configurations*. To delete a configuration, scroll to the configuration, press the joystick, and select *Delete*.

Date and time

To define the date and time used in your phone, and change the date and time format and separators, select **Menu** > *Tools* > *Settings* > *Date and time* and from the following options:

Time and *Date* – to set the time and date

Time zone – to set the time zone of your location. If you set *Network operator time* > *Auto-update*, the local time is shown.

Date format – to select the format to display dates

Date separator – to select the date separator

Time format – to select between 24-hour and 12-hour time format

Time separator – to select the time separator

Clock type – to select whether the analog or digital clock is shown in the standby or active standby mode. See "Clock," p. 76.

Clock alarm tone – to select the alarm clock tone

Network operator time (network service) – to allow the network to update time, date, and time zone information to your phone. If you select *Auto-update*, all active connections are disconnected. Check any alarms as these may be affected.

Security

Phone and SIM

You can change the following codes: lock code, PIN code, and PIN2 code. These codes can only include the numbers from 0 to 9.

Avoid using access codes similar to emergency numbers, to prevent accidental dialing of the emergency number.

To set the security settings, select **Menu** > *Tools* > *Settings* > *Security* > *Phone and SIM* and from the following options:

Code in use – to select the active code, *PIN* or *UPIN*, for the active USIM. This is shown only if the active USIM supports UPIN, and the UPIN is not rejected.

PIN code request (or *UPIN code request*) – to set the phone to request the code each time the phone is switched on. Some SIM cards may not

allow the PIN code request to be turned *Off*. If you select *Code in use* > *UPIN*, *UPIN code request* is shown instead.

PIN code (or *UPIN code*) / *PIN2 code* / *Lock code* — to change the codes

Autolock period — to set a time-out after which the phone is automatically locked. To use the phone again, you need to enter the correct lock code. To turn off the autolock period, select *None*.

Lock if SIM changed — to set the phone to prompt for the lock code when an unknown, new SIM card is inserted into your phone. The phone keeps a list of SIM cards that are recognized as the owner cards.

Closed user group (network service) — to specify a group of people whom you can call and who can call you. For more information, contact your network operator or service provider. To activate the default group agreed on with the network operator, select *Default*. If you want to use another group (you need to know the group index number), select *On*.

When security features that restrict calls are in use (such as call barring, closed user group, and fixed dialing) calls may be possible to the official emergency number programmed into your device.

Confirm SIM services (network service) — to set the phone to display confirmation messages when you use a SIM card service

Certificate management

Digital certificates do not guarantee safety: they are used to verify the origins of software.

To view a list of authority certificates that have been stored in your phone, select *Menu* > *Tools* > *Settings* > *Security* > *Certif. management*. To see a list of personal certificates if available, scroll right.

Digital certificates should be used if you want to connect to an online bank or another site or remote server for actions that involve transferring confidential information. They should also be used if you want to reduce the risk of viruses or other malicious software and be sure of the authenticity of software when downloading and installing software.



Important: Even if the use of certificates makes the risks involved in remote connections and software installation considerably smaller, they must be used correctly in order to benefit from increased security. The existence of a certificate does not offer any protection by itself; the certificate manager must contain correct, authentic, or trusted certificates for increased security to be available. Certificates have a restricted lifetime. If Expired certificate or Certificate not valid yet is shown even if the certificate should be valid, check that the current date and time in your device are correct.

Before changing any certificate settings, you must make sure that you really trust the owner of the certificate and that the certificate really belongs to the listed owner.

View certificate details and check authenticity

You can only be sure of the correct identity of a server when the signature and the period of validity of a server certificate have been checked.

The phone notifies you if the identity of the server is not authentic or if you do not have the correct security certificate in your phone.

To check certificate details, scroll to a certificate, and select **Options** > **Certificate details**. While opening the certificate details, the phone checks the validity of the certificate, and one of the following notes may appear:

Expired certificate – The validity period has ended for the selected certificate.

Certificate not valid yet – The validity period has not yet begun for the selected certificate.

Certificate corrupted – The certificate cannot be used. Contact the certificate issuer.

Certificate not trusted – You have not set any application to use the certificate.

Change the trust settings

Before changing any certificate settings, you must make sure that you really trust the owner of the certificate and that the certificate really belongs to the listed owner.

Scroll to an authority certificate, and select **Options** > *Trust settings*. Depending on the certificate, a list of the applications that can use the selected certificate is shown.

Security module

To view or edit security modules, select **Menu** > *Tools* > *Settings* > *Security* > *Secur.mod.*.

Call divert

1. To divert your incoming calls to your voice mailbox or another phone number, select **Menu** > *Tools* > *Settings* > *Call divert*. For details, contact your service provider.
2. Select which calls you want to divert: *Voice calls*, *Data calls*, or *Fax calls*.
3. Select the desired option. For example, to divert voice calls when your number is busy or when you reject an incoming call, select *If busy*.
4. To set the divert option on or off, select **Options** > *Activate* or *Cancel*. To check whether the option is activated, select *Check status*. Several divert options can be active at the same time.

Call barring and call diverting cannot be active at the same time.

Call barring

Call barring (network service) allows you to restrict the calls that you make and receive with your phone. To change the settings, you need the barring password from your service provider.

1. Select **Menu** > *Tools* > *Settings* > *Call barring*.
2. Scroll to the desired barring option, and to request the network to set call restriction on, select **Options** > *Activate*. To set the selected call restriction off, select *Cancel*. To check whether the calls are barred, select *Check status*.

To change the barring password, select *Edit barrings passw.*.

To cancel all active call barrings, select *Cancel all barrings*.

Call barring and call diverting cannot be active at the same time.

When calls are barred, calls still may be possible to certain official emergency numbers.

Network

Select **Menu** > *Tools* > *Settings* > *Network* and from the following options:

Operator selection – To set the phone to search for and select automatically one of the available networks, select *Automatic*. To select the desired network manually from a list of networks, select *Manual*. If the connection to the manually selected network is lost, the phone sounds an error tone and asks you to select a network again. The selected network must have a roaming agreement with your home network, that is, the operator whose SIM card is in your phone.

Cell info display (network service) – To set the phone to indicate when it is used in a cellular network based on Micro Cellular Network (MCN) technology and to activate cell info reception, select *On*.

Enhancement

To change settings of an enhancement, select **Menu** > *Tools* > *Settings* > *Enhancement* and an enhancement, such as *Headset*. Select from the following options:

Default profile – to select the profile you want to activate each time you connect the enhancement to your phone

Automatic answer – to set the phone to answer an incoming call automatically after 5 seconds when this enhancement is connected to your phone. If the *Ring type* is set to *Beep once* or *Silent*, automatic answer cannot be used, and you must answer the phone manually.

Lights – To set the phone lights continuously on while using the enhancement, select *On*.

To use the text phone, select *Text phone* > *Use text phone* > *Yes*.

■ Application manager

You can install two types of applications and software to your phone:



J2ME™ applications based on Java™ technology with the extension .jad or .jar. Do not download PersonalJava™ applications to your phone as they cannot be installed.



Other applications and software suitable for the Symbian operating system. The installation files have the .sis extension. Only install software specifically designed for your phone.

Installation files may be transferred to your phone from a compatible computer, downloaded during browsing, or sent to you in a multimedia message, as an e-mail attachment, or using Bluetooth. You can use Nokia Application Installer in Nokia PC Suite to install an application to your phone or a memory card.

To open *App. manager*, select **Menu** > *Tools* > *App. mgr.*

Install an application



Important: Only install and use applications and other software from sources that offer adequate security and protection against harmful software.

Before installation, select **Menu** > *Tools* > *App. mgr.*, scroll to the installation file, and select **Options** > *View details* to view information such as the application type, version number, and the supplier or manufacturer of the application.

If you install a file that contains an update or repair to an existing application, you can only restore the original application if you have the original installation file or a full back-up copy of the removed software package. To restore the original application, remove the application, and install the application again from the original installation file or the back-up copy.

The .jar file is required for installing Java applications. If it is missing, the phone may ask you to download it. If there is no access point defined for the application, you are asked to select one. When you are downloading the .jar file, you may need to enter a user name and password to access

the server. You obtain these from the supplier or manufacturer of the application.

To install an application or software package:

1. Scroll to an installation file. Applications on the memory card are indicated with .
2. Select **Options** > *Install*.

Alternatively, search the phone memory or the memory card, select the application, and press the joystick to start the installation.

During the installation, the phone shows information about the progress of the installation. If you are installing an application without a digital signature or certification, the phone displays a warning. Continue installation only if you are sure of the origins and contents of the application.

To view extra information about the application, scroll to it, and select **Options** > *Go to web address*.

To see what software packages have been installed or removed and when, select **Options** > *View log*. To send your installation log to a help desk so that they can see what has been installed or removed, select *Send log*.

Remove an application

Select **Menu** > *Tools* > *App. mgr.*, scroll to the software package, and select **Options** > *Remove*.

If you remove software, you can only reinstall it if you have the original software package or a full backup of the removed software package. If you remove a software package, you may no longer be able to open documents created with that software.

Application settings

Select **Menu** > *Tools* > *App. mgr.* > **Options** > *Settings* and from the following settings:

Software installation – to select if you want to allow installation of all Symbian applications (*All*) or only signed applications (*Signed only*)

Online certif. check — to select if you want *App. manager* to check the online certificates for an application before installing it

Default web address — default address used when checking online certificates

Some Java applications may require a phone call, a message to be sent, or a network connection to be made to a specific access point for downloading extra data or components. In the *App. manager* main view, scroll to an application, and select **Options** > *Suite settings* to change the settings related to that specific application.

■ Activation keys

Copyright protections may prevent some images, music (including ringing tones), and other content from being copied, modified, transferred or forwarded.

Select **Menu** > **Tools** > *Actv. keys* to view the digital rights activation keys stored in your phone.

To view valid keys (✓) that are connected to one or more media files, select *Valid keys*.

To view expired keys (✗) with which the time period for using the file is exceeded, select *Invalid keys*. To buy more usage time or extend the usage period for a media file, scroll to a key, and select **Options** > *Get activation key*. Activation keys cannot be updated if Web service message reception is disabled. See "Service message settings," p. 45.

To view activation keys that are not in use, select *Not in use*. Unused activation keys have no media files connected to them saved in the phone.

To view detailed information such as the validity status and the ability to send the file, scroll to an activation key, and press the joystick.

■ Device manager

You may receive server profiles and configuration settings from your network operator, service provider, or company information management department. These configuration settings may include

access point settings for data connections and other settings used by different applications in your phone.

To open *Device mgr.*, select **Menu** > **Tools** > *Dev. mgr.*. If you have no server profiles defined, the phone asks whether you want to define one.

To connect to a server and receive configuration settings for your phone, scroll to the server profile, and select **Options** > *Start configuration*.

To edit a server profile, select **Options** > *Edit profile* and from the following settings:

Server name – Enter a name for the configuration server.

Server ID – Enter the unique ID to identify the configuration server.

Server password – Enter the password to be sent to the server.

Access point – Select the access point to be used when connecting to the server.

Host address – Enter the URL address of the server.

Port – Enter the port number of the server.

User name and *Password* – Enter your user name and password.

Allow configuration – To receive configuration settings from the server, select *Yes*.

Auto-accept all reqs. – If you want the phone to ask for confirmation before accepting a configuration from the server, select *No*.

■ Transfer

With *Transfer*, you can copy or synchronize contacts, calendar entries, and possibly other data, such as video clips and images, from a compatible phone using a Bluetooth connection.

Depending on the other phone, synchronization may not be possible and data can be copied only once.

1. Select **Menu** > **Tools** > *Transfer*. If you have not used Transfer before, information about the application is displayed. Select **Continue** to start transferring data.

If you have used Transfer, select *Transfer data*.

2. The phones need to be paired in order to transfer data. Depending on the type of the other phone, an application may be sent and installed on the other phone to enable the data transfer. Follow the instructions.
3. Select what content you want to be transferred to your phone.
4. Content is transferred to your phone. The transfer time depends on the amount of data. You can stop the transfer and continue later.

14. Connectivity

■ PC Suite

You can use your phone with a variety of PC connectivity and data communications applications. With PC Suite you can synchronize contacts, calendar and to-do notes and notes between your phone and a compatible PC, or a remote Internet server (network service).

You may find more information about PC Suite and the download link in the support area on the Nokia Web site, www.nokia.com/support.

■ Bluetooth connection

This device is compliant with Bluetooth technology Specification 2.0 supporting the following profiles: Generic Access Profile, Hands-free Profile, Headset Profile, Basic Imaging Profile, Human Interface Device Profile, Object Push Profile, File Transfer Profile, Dial Up Networking Profile, Serial Port Profile, Generic Object Exchange Profile, Service Discovery Profile, and SIM Access Profile. To ensure interoperability between other devices supporting Bluetooth technology, use Nokia approved enhancements for this model. Check with the manufacturers of other devices to determine their compatibility with this device.

There may be restrictions on using Bluetooth technology in some locations. Check with your local authorities or service provider.

Features using Bluetooth technology, or allowing such features to run in the background while using other features, increase the demand on battery power and reduce the battery life.

Bluetooth technology enables wireless connections between electronic devices within a maximum range of 10 meters (32 feet). A Bluetooth connection can be used to send images, videos, texts, business cards, calendar notes, or to connect wirelessly to compatible devices using Bluetooth technology, such as computers. Not all computers using Bluetooth technology are necessarily compatible.

Since devices using Bluetooth technology communicate using radio waves, your phone and the other devices do not need to be in direct line-of-sight. The two devices only need to be within a maximum of 10 meters (32 feet) of each other, although the connection can be

subject to interference from obstructions such as walls or from other electronic devices.

Bluetooth connection settings

Select **Menu** > **Connect** > **Bluetooth**.

When you activate Bluetooth technology for the first time, you are asked to give a name to your phone.

Bluetooth – to switch Bluetooth **On** or **Off**

My phone's visibility > **Shown to all** – your phone can be found by other Bluetooth devices or **Hidden** – Your phone cannot be found by other devices. For security reasons it is advisable to use the hidden mode whenever possible.

My phone's name – define a name for your phone. After you have set the Bluetooth connection as active and changed **My phone's visibility** to **Shown to all**, your phone and this name can be seen by other Bluetooth device users.

Remote SIM mode > **On** – to enable the usage of the SIM card of the phone by another device (for example a car kit) by Bluetooth technology (SIM Access Profile SAP)

When the wireless device is in the remote SIM mode, you can only use a compatible connected enhancement, such as a car kit, to make or receive calls. Your wireless device will not make any calls, except to the emergency numbers programmed into your device, while in this mode. To make calls from your device, you must first leave the remote SIM mode. If the device has been locked, enter the code to unlock it first.

Send data using Bluetooth technology

There can be only one active Bluetooth connection at a time.

1. Open an application where the item you wish to send is stored. For example, to send a photo to another device, open the gallery application.
2. Scroll to the item you want to send, and select **Options** > **Send** > **Via Bluetooth**.

3. The phone starts to search for devices within range. Devices using Bluetooth technology that are within range start to appear on the display one by one. You can see a device icon, the device name, the device type, or a short name. Paired devices are shown with . To interrupt the search, select **Stop**. The device list freezes and you can start to form a connection to one of the devices already found.
4. When searching for devices, some devices may show only the unique device addresses. To find out the unique address of your phone, enter the code ***#2820#** in the standby mode.
If you have searched for devices earlier, a list of the devices that were found previously is shown first. To start a new search, select **More devices**. If you switch off the phone, the list of devices is cleared and the device search needs to be started again before sending data.
5. Scroll to the device you want to connect with, and select it. The item you are sending is copied to the outbox, and the note **Connecting** is shown.
6. Pairing (if not required by the other device, go to step 7.)
 - If the other device requires pairing before data can be transmitted, a tone sounds and you are asked to enter a passcode.
 - Create your own passcode (1-16 characters long, numeric) and agree with the owner of the other device to use the same code. This passcode is used only once and you do not have to memorize it.
 - After pairing, the device is saved to the **Paired devices** view.
7. When the connection has been successfully established, the note **Sending data** is shown.

Data received using Bluetooth connection can be found in the **Inbox** folder in **Messag.**

Icons for different devices:  (**Computer**),  (**Phone**),  (**Audio/video**), and  (**Bluetooth device**)

If sending fails, the message or data are deleted. The **Drafts** folder in **Messag.** does not store messages sent using a Bluetooth connection.

Paired devices view

Paired devices are indicated by  in the search result list. In the Bluetooth main view, scroll right to open a list of paired devices.

Do not accept Bluetooth connections from sources you do not trust.

To pair with a device, select **Options** > *New paired device*. The phone starts a device search. Scroll to the device you want to pair with, and select it. Exchange passcodes. The device is added to the *Paired devices* list.

To cancel pairing, scroll to the device whose pairing you want to cancel and press the clear key, or select **Options** > *Delete*. If you want to cancel all pairings, select **Options** > *Delete all*.

If you are currently connected to a device, and delete the pairing with that device, the pairing is removed and the device connection is ended, but Bluetooth connection remains active on the handset.

To set a device to be authorized, scroll to the device, and select **Options** > *Set as authorised*. Connections between your phone and this device can be made without your knowledge. No separate acceptance or authorization is needed. Use this status only for your own devices that others do not have access to, for example, your PC, or devices that belong to someone you trust. The icon  is added next to authorized devices in the *Paired devices* view. If you select *Set as unauthorised*, connection requests from this device need to be accepted separately every time.

Receive data using Bluetooth technology

When you receive data using Bluetooth technology, a tone is played, and you are asked if you want to accept the message. If you accept, the item is placed in the *Inbox* folder in *Messag.*. See "Inbox—receive messages," p. 36.

Disconnect Bluetooth connection

A Bluetooth connection is disconnected automatically after sending or receiving data.

■ Instant messaging

Instant messaging (network service) allows you to converse with other people using instant messages, and join discussion forums (IM groups) with specific topics. Once you have registered with an instant messaging (IM) service, you can log into the service provider's IM server.

Check the availability of IM services, pricing, and tariffs with your network operator or service provider. Service providers also provide you instructions on how to use their services.

To access an instant messaging service you need to save the settings for that service. You may receive the settings from the network operator or service provider that offers the service in a configuration message. You can also enter the settings manually. See "Instant messaging settings," p. 108.

Connect to an instant messaging server

Select **Menu** > **Connect** > **IM**.

1. To log in, select **Options** > **Login**.
2. Enter your user ID and password. For the user ID and password, contact your service provider.

To log out, select **Options** > **Logout**.

Instant messaging settings

Select **Menu** > **Connect** > **IM** > **Options** > **Settings** > **IM settings** and from the following settings:

Use screen name – Select **Yes** to enter a nickname (max. 10 characters).

Show my availability – To allow only people in your contacts to see if you are online, select **To IM contacts only**. To prevent others from seeing if you are online, select **To no-one**.

Allow messages from – Select **All**, **From IM contacts**, or **None**.

Allow invitations from – Select **All**, **From IM contacts**, or **None**.

Msg. scrolling speed – Select the speed at which new messages are displayed.

Sort IM contacts – Select how contacts are sorted. To sort contacts so that online contacts are shown first, select *By online status*.

Availabil. reloading – Choose how to update information about whether your IM contacts are active: select *Automatic* or *Manual*.

Offline contacts – To hide contacts that are offline, select *Hide*.

Own message colour and *Received msg colour* – to set the colors of your own messages and messages you receive

IM alert tone – to set the IM alert tone

Select **Menu** > **Connect.** > **IM** > **Options** > **Settings** > **Server settings** and from the following settings:

Servers – To edit connection settings, scroll to the server, and select **Options** > **Edit**. Contact your service provider for the settings. To define new server settings, select **Options** > **New server**. To delete a server, scroll to it, and select **Options** > **Delete**.

Default server – Choose the default server.

IM login type – To be automatically connected to the IM server during the days and times you define, select *Automatic*. To only be automatically connected while in your home network, select *Auto. in home network*. To be automatically connected when you start the IM application, select *On app. start-up*. To connect manually, select *Manual*.

Automat. login days and *Automatic login hrs.* – to set at what times you want to establish a connection automatically. These settings are only visible if *IM login type* is set to *Automatic* or *Auto. in home network*.

Join and leave an IM group

Select **Menu** > **Connect.** > **IM** > **IM groups**.

IM groups are only available if supported by the service provider.

A list of IM groups that you have saved or are currently joined to is shown. The icon next to a group indicates what type it is:



Group that you have created



Group that you have saved



Group that you are currently joined to but which you have not saved

To join an IM group, scroll to the group on the list, and press the joystick. To join an IM group not on the list but whose group ID you know, select **Options** > *Join new group*. Enter the group ID, and press the joystick.

Scroll to a group, select **Options** > *Group* and from the following options: *Save* to save it to *IM groups*, *Delete* to delete the group, *View participants* to see who is currently joined to the group, and *Details* to see the group ID, topic, members, editing rights in the group, and whether sending private messages is allowed in the group.

To leave the IM group, select **Options** > *Leave IM group*.

Search for IM groups and users

To search for groups, select **Menu** > *Connect* > *IM* > *IM groups* > **Options** > *Search*. You can search IM groups by *Group name*, *Topic*, or *Members* (user ID). To join or save a group that is found in the search, scroll to it, and select **Options** > *Join* or *Save*. If you want to search again, select **Options** > *New search*.

To search for new contacts, select **Options** > *IM contacts* > *New IM contact* > *Search from server*. You can search by *User's name*, *User ID*, *Phone number*, and *E-mail address*. To search again, select **Options** > *New search*. To start a conversation with a user that is found, scroll to the user, and select **Options** > *Open conversation*. To save the user to contacts, select *Add to IM contacts*. To invite the user to a group, select *Send invitation*.

When the search result is displayed, to see more search results, select **Options** > *New search* > *More results*.

Chat in an IM group

Select **Menu** > *Connect* > *IM* > *IM groups*.

After you join an IM group, you can view the messages that are exchanged in the group, and send your own messages.

To send a message, write the message, and press the joystick.

To send a private message to a member (if allowed in the group), select **Options** > *Send private msg.*, select the recipient, write the message, and press the joystick.

To reply to a private message sent to you, scroll to the message, and select **Options** > *Reply*.

To invite IM contacts who are online to join the IM group (if allowed in the group), select **Options** > *Send invitation*, select the contacts you want to invite, write the invitation message, and select **Done**.

Record messages

To record the messages that are exchanged in an IM group or during an individual conversation, select **Options** > *Record chat*. Enter the name for the message file, and press the joystick. To stop recording, select **Options** > *Stop recording*.

The recorded message files are saved to notes. See "Notes," p. 80.

Start and view individual conversations

Select **Menu** > *Connect* > *IM* > *Conversations*.

This shows a list of the IM users with whom you have an ongoing conversation.



next to a user indicates that you have received a new message from that user.

To view an ongoing conversation, scroll to the user, and press the joystick. To send a message, write your message, and press the joystick. To return to the conversations list without closing the conversation, select **Back**.

To start a new conversation, select **Options** > *New conversation* > *Select recipient* to select from a list of your saved IM contacts that are currently online, or *Enter user ID* to enter the user ID.

To close the conversation, select **Options** > *End conversation*. Ongoing conversations are automatically closed when you exit instant messaging.

To save a user to your IM contacts, scroll to the user, and select **Options** > *Add to IM contacts*.

To prevent receiving messages from certain users, select **Options** > *Blocking options* and from the following:

Add to blocked list – to block messages from the currently selected user



Add ID to list manually – Enter the user ID of the user, and press the joystick.

View blocked list – to see the users whose messages are blocked

Unblock – Select the user that you want to remove from the blocked list, and press the joystick.

IM contacts

Select **Menu** > *Connect.* > *IM* > *IM contacts*.

You can see a list of your saved IM contacts.  indicates contacts that are currently online, and  indicates contacts that are offline.

To create a new contact, select **Options** > *New IM contact*. Fill in the *Nickname* and *User ID* fields, and select **Done**.

To view contact details, scroll to a contact, and select **Options** > *Contact details*.

Scroll to a contact, and select **Options** and from the following options:

Open conversation – Start a new conversation or continue an ongoing conversation with the contact.

Contact details – View the contact's details.

Switch tracking on – Be notified every time the IM contact goes online or offline.

Belongs to groups – See which groups the IM contact has joined.

Blocking options – Prevent or allow receiving messages from the contact.

Reload users' availab. – Update information about whether contacts are online or offline. This option is not available if you have selected *Availabil. reloading* > *Automatic* in *IM settings*.

Editing options – Edit the contact's details, delete the contact, move the contact, or be notified when the contact's status changes.

Create a new IM group

Select [Menu](#) > [Connect.](#) > [IM](#) > [IM groups](#) > [Options](#) > [Create new group](#). Enter the settings for the group:

[Group name](#), [Group topic](#), and a [Welcome note](#) that the participants see when they join the group

[Group size](#) – Specify the maximum number of members allowed to join the group.

[Allow search](#) – Define if others can find the IM group by searching.

[Editing rights](#) – Scroll to the IM group members to whom you want to give editing rights and permission to invite contacts to join the group.

[Group members](#) – See "Restrict access to an IM group," p. 113.

[Banned](#) – Display a list of banned users.

[Allow private msg.](#) – Allow or prevent private messaging between members.

[Group ID](#) – The group ID is created automatically and cannot be changed.

Edit IM group settings

Select [Menu](#) > [Connect.](#) > [IM](#) > [IM groups](#).

You can edit the settings for an IM group if you have created the group or if the creator of the group has given you editing rights. In the [IM groups](#) view, scroll to the desired group, and select [Options](#) > [Group](#) > [Settings](#). See "Create a new IM group," p. 113.

Restrict access to an IM group

You can make an IM group closed by creating a group members list. Only the users on the list are allowed to join the group. Select the [IM groups](#) view, scroll to the group, and select [Options](#) > [Group](#) > [Settings](#) > [Group members](#) > [Selected only](#).

To add a user to the list, select [Add](#) > [From IM contacts](#) or [Enter user ID](#).

To remove a user from the list, scroll to the user, and select [Remove](#).

To clear the list and allow all IM users to join the group again, select [Remove all](#).

■ Connection manager

Select **Menu** > **Connect.** > **Conn. mgr.**

In the connection manager, you can identify the status of multiple data connections, view details on the amount of data sent and received, and end unused connections. You can view details of data connections only. Voice calls are not listed.

When you open the connection manager, you can see the following:

- Open data connections. **D** indicates a *Data call*, and **≡** indicates *Packet data*.
- The status of each connection.
- Amount of data uploaded and downloaded for each connection (packet data connections only).
- The duration of each connection (data call connections only).



Note: The actual invoice for calls and services from your service provider may vary, depending on network features, rounding off for billing, taxes, and so forth.

View connection details

To view the details of a connection, scroll to a connection, and select **Options** > **Details**. The following is displayed:

Name – name of the Internet access point (IAP) in use

Bearer – type of data connection: *Data call* or *Packet data*

Status – current status of the connection

Recvd. – amount of data, in bytes, received to the phone

Sent – amount of data, in bytes, sent from the phone

Duration – length of time that the connection has been open

Speed – current speed of both sending and receiving data in KB/s (kilobytes per second)

Dial-up (data call) or **Acc. pt.** (packet data) – dial-up number or name of access point used

Shared (not displayed if the connection is not shared) — number of applications using the same connection

End connections

To end a connection, scroll to the connection, and select **Options** > *Disconnect*.

To close all currently active connections, select **Options** > *Disconnect all*.

■ Push to talk

Push to talk (PTT) (network service) is a real-time voice over IP service (network service) available over a GSM/GPRS network. Push to talk provides direct voice communication connected with the push of a key. Use push to talk to have a conversation with one person or with a group of people.

Before you can use the push to talk service, you must define the push to talk access point and push to talk settings. You may receive the settings in a configuration message from the push to talk service provider.

In push to talk communication, one person talks while the others listen from the built-in loudspeaker. Speakers take turns responding to each other. Because only one group member can talk at any time, the maximum duration of a speech turn is limited. The maximum duration is usually set to 30 seconds. For details of the speech turn duration for your network, contact your network operator or service provider.

Phone calls always take priority over push to talk calls.

Besides the packet data counters, the phone registers only one-to-one calls in the recent calls lists in *Log*. The participants should confirm the reception of any communications where appropriate as there is no other confirmation of whether the recipients have heard the call.

To check availability and costs, and to subscribe to the service, contact your network operator or service provider. Note that roaming services may be more limited than home network services.

While connected to the push to talk service, you can use the other functions of the phone. Many of the services available for traditional voice calls (for example, voice mailbox) are not available for push to talk communications.

Define a push to talk access point

Many service providers require you to use an Internet access point for your default access point. Other service providers allow you to use a WAP access point. Contact your service provider for more information.

If you do not have a WAP connection, you may need to contact your service provider for assistance with the connection.

Settings for push to talk

For push to talk service settings, contact your network operator or service provider. You may receive the settings over the air in a configuration message.

To view and change push to talk settings, select **Menu** > **Connect** > **PTT** > **Options** > **Settings**.

User settings

Incoming PTT calls – To see a notification of incoming calls, select **Notify**. To answer PTT calls automatically, select **Auto-accept**. If you do not want to receive PTT calls, select **Not allowed**.

PTT call alert tone – Select the tone for incoming push to talk calls. If you want the incoming call alert setting for push to talk to follow your profile settings, select **Set by profile**. For example, if your profile is silent, push to talk is set to do not disturb (DND) and, except for callback requests, you are not available to others using push to talk.

Callback request tone – Select a tone for callback requests.

Application start-up – To start push to talk automatically, select **Always automatic**. To start push to talk automatically only while in your home network, select **Auto. in home network**.

Default nickname – Enter your nickname shown to other users. Your service provider may have disabled the editing of this option in your phone.

Show my PTT address – Select *Never* if you want to hide your push to talk address from others in push to talk channels and one-to-one calls.

Show my login status – Select *Yes* if you want your status to be shown or *No* if you want your status to be hidden.

Connection settings

Domain – Enter the domain name obtained from your service provider.

Access point name – Enter the push to talk access point name. The access point name is needed to establish a connection to the GSM/GPRS network.

Server address – Enter the IP address or domain name of the push to talk server obtained from your service provider.

User name – Enter your user name obtained from your service provider.

Password – Enter your password used to enter the push to talk service.

Log in to push to talk

Select **Menu** > **Connect.** > **PTT.** Push to talk automatically logs in to the service when started.

When log in is successful, push to talk automatically connects to channels that were active when the application was last closed. If the connection is lost, the device automatically tries to log back in until you exit push to talk.

 indicates a push to talk connection.

 indicates that push to talk is set to do not disturb (DND).

Exit push to talk

Select **Menu** > **Connect.** > **PTT** > **Options** > **Exit. Switch push to talk off after exiting application?** is displayed. Select *Yes* to log out and close the

service. If you want to keep the application active in the background, select *No*.

Make a one-to-one call



Warning: Do not hold the device near your ear when the loudspeaker is in use, because the volume may be extremely loud.

1. Select **Menu** > *Connect* > *PTT* > **Options** > *PTT contacts*, scroll to the contact you want to talk to, and select **Options** > *Talk 1 to 1*.
2. When the connection has been established, to talk to the other participant, press and hold the call key the entire time you are talking. When you have finished talking, release the call key, so that the other participant can talk.
Select **Options** > *Deactivate loudsp./Activate loudspeaker* to use the earpiece or loudspeaker for push to talk communication. When *Deactivate loudsp.* is selected, you can hold the phone normally to your ear.
3. To end the PTT call, select *Disconnect*, or if there are several PTT calls, select **Options** > *Disconnect*.

Answer a push to talk call

If you select **Options** > *Settings* > *User settings* > *Incoming PTT calls* > *Notify*, a short tone notifies you of an incoming group or one-to-one call. To accept the call, select **Accept**. To silence the tone, select **Silence**. To reject the call, press the end key.

When receiving a one-to-one call from a person whose information you have saved in *Contacts*, the saved name is displayed; otherwise, only the nickname of the caller is displayed.

Make a push to talk group call

To call a group, select **Options** > *PTT contacts*, select **Options** > *Make PTT group call*, mark the contacts you want to call by scrolling to them and pressing the joystick, and press the call key.

Subscribe to the login status of others

To subscribe to or unsubscribe from the push to talk online status of others, select **Options** > *PTT contacts*, scroll to the contact, and select **Options** > *Show login status* or *Hide login status*.

Callback requests

Respond to a callback request

When someone sends you a callback request, *1 new callback request* is displayed in the standby mode. Select **Show** to open *Callback inbox*. Select a contact and **Options** > *Talk 1 to 1*.

Send a callback request

If you make a one-to-one call and do not get a response, you can send a request for the person to call you back. You can send a callback request in different ways:

- To send a callback request from *PTT contacts*, scroll to a contact, and select **Options** > *Send callback request*.
- To send a callback request from *Contacts*, scroll to a contact, and select **Options** > *PTT options* > *Send callback request*.

Save the callback request sender

When you receive a callback request from someone who is not in your contacts list, you can save the name to your contacts.

1. Select *Callback inbox*.
2. Scroll to a callback request from the person you want to add to contacts, and select **Options** > *Add to Contacts*.

Channels

When you are connected to a channel, all members joined to the channel hear you talking. Up to five channels can be active at the same time. When more than one channel is active, select **Swap** to change the channel you want to talk to.

Each member in the channel is identified by a user name given by the service provider. Channel members can choose a nickname for within each channel, which is shown as a caller identification.

Channels are registered with a URL address. One user registers the channel URL in the network by joining the channel the first time.

Create your own channel

1. Select **Options** > *PTT channels*.
2. Select **Options** > *New channel* > *Create new*.
3. Enter a *Channel name*.
4. Select a *Channel privacy* level.
5. Enter your own nickname in *Nickname in channel*.
6. If you want to add a thumbnail image to the group, select *Channel thumbnail*, and select an image.
7. Select **Done**. When you have created a channel, you are asked if you want to send channel invitations. Channel invitations are text messages.

The members you invite to the open channels can also invite more members to the channels.

Join a preconfigured channel

A preconfigured channel is a talk group that is set up by your service provider. Only preconfigured users are allowed to join and use the channel. When you join an existing channel, you must fill in a URL for the channel.

For channel detail information, contact your network operator or service provider. You may receive the details in a text message.

1. Select **Options** > *PTT channels*.
2. Select **Options** > *New channel* > *Add existing*.
3. Enter the *Channel name*, *Channel address*, and *Nickname in channel*.
You can also add a *Channel thumbnail*.
4. Select **Done**.

Respond to a channel invitation

To save a received channel invitation, select **Options** > *Save PTT channel*. The channel is added to your PTT contacts, channels view. After you save the channel invitation, you are asked if you want to connect to the channel.

If you reject or clear the invitation, the invitation is stored in your messaging inbox. To join the channel later, open the invitation message, and select **Options** > *Connect to channel*.

PTT sessions

PTT sessions are displayed as call bubbles in the push to talk display, giving information about the status of the PTT sessions:

 indicates the currently active PTT session

Wait – shown when you press and hold the call key and somebody else is still speaking in the PTT session

Talk – shown when you press and hold the call key and get the permission to speak

The text field displays the nickname for one-to-one calls or the channel name for dial-in channel calls. For a dial-out group call, *Group call* is displayed. Other information may be the connection status or the time elapsed since the last incoming speech turn.

Select **Options** to access the following:

Activate loudspeaker/Deactivate loudsp. – to switch the loudspeaker on/off

Disconnect – to disconnect the selected PTT session and to close the call bubble

PTT contacts – to open the PTT contacts list

PTT channels – to open the PTT channels list

Callback inbox – to open the callback request inbox

PTT log – to view the push to talk log

Settings – to access the push to talk main settings

Additional options are available for group calls and channels:

Active members – to view a list of active group members

Send invitation – to start the invitation view (only available for your own channels and channels whose *Channel privacy* is set to *Public*)

■ Remote synchronization

Select **Menu** > *Connect* > *Sync*.

Sync enables you to synchronize your calendar, contacts, or notes with various calendar and address book applications on a compatible computer or on the Internet.

The synchronization application uses SyncML technology for synchronization. For information on SyncML compatibility, contact the supplier of the calendar or address book application you want to synchronize your phone data with.

Create a new synchronization profile

1. If no profiles have been defined, the phone asks you if you want to create a new profile. Select **Yes**.

To create a new profile in addition to existing ones, select **Options** > *New sync profile*. Choose whether you want to use the default setting values or copy the values from an existing profile to be used as the basis for the new profile.

2. Define the *Applications* to be synchronized.

Select an application, press the joystick, and edit the synchronization settings:

Include in sync – to enable/disable the synchronization

Remote database – the name of the used remote database

Synchronisation type – Select *Normal* for synchronization of the data on your phone and the remote database, *To phone only* for the synchronization of the data on your phone only, or *To server only* for the synchronization of the data on the remote database only.

The available applications that you can synchronize may vary. Contact your service provider for more information.

3. Define the *Connection settings*:

Server version – Select the server protocol version.

Server ID – ID of the server (only visible with *Server version 1.2*)

Data bearer – Select *Internet* or *Bluetooth*.

Access point – Select an access point you want to use for the data connection.

Host address – Contact your service provider or system administrator for the correct values.

Port – Contact your service provider or system administrator for the correct values.

User name – your user ID for the synchronization server. Contact your service provider or system administrator for your correct ID.

Password – Enter your password. Contact your service provider or system administrator for the correct value.

Allow sync requests > *Yes* – to allow that the server starts the synchronization

Accept all sync reqs. > *No* – to require a confirmation before the server starts the synchronization

Network authentic. > *Yes* – to require HTTP authentication

Network user name – user name for HTTP authentication

Network password – password for HTTP authentication

Synchronize data

In the main view, scroll to a profile, and select **Options** > *Synchronise*. The status of the synchronization is shown.

To cancel synchronization before it is finished, select **Cancel**.

You are notified when the synchronization has been completed.

After synchronization is complete, select **Options** > *View log* to open a log file showing the synchronization status (*Complete* or *Incomplete*)

and how many calendar or contact entries have been added, updated, deleted, or discarded (not synchronized) in the phone or on the server.

■ USB data cable

You can use the USB data cable to transfer data between the phone and a compatible PC. You can also use the USB data cable with Nokia PC Suite.

Select **Menu** > **Connect** > **Data cbl.**. Select what the USB data cable connection is used for: **Media player**, **PC Suite**, or **Data transfer**. To have the device ask the purpose of the connection each time the cable is connected, select **Ask on connection**.

For **Data transfer** and **Media player** connections the phone is in the offline mode, and no incoming or outgoing calls are possible.

After transferring data, ensure that it is safe to unplug the USB data cable from the PC.

15. Battery information

■ Charging and discharging

Your device is powered by a rechargeable battery. The full performance of a new battery is achieved only after two or three complete charge and discharge cycles. The battery can be charged and discharged hundreds of times, but it will eventually wear out. When the talk and standby times are noticeably shorter than normal, replace the battery. Use only Nokia approved batteries, and recharge your battery only with Nokia approved chargers designated for this device.

If a replacement battery is being used for the first time or if the battery has not been used for a prolonged period, it may be necessary to connect the charger then disconnect and reconnect it to begin charging the battery.

Unplug the charger from the electrical plug and the device when not in use. Do not leave a fully charged battery connected to a charger, since overcharging may shorten its lifetime. If left unused, a fully charged battery will lose its charge over time.

If the battery is completely discharged, it may take a few minutes before the charging indicator appears on the display or before any calls can be made.

Use the battery only for its intended purpose. Never use any charger or battery that is damaged.

Do not short-circuit the battery. Accidental short-circuiting can occur when a metallic object such as a coin, clip, or pen causes direct connection of the positive (+) and negative (-) terminals of the battery. (These look like metal strips on the battery.) This might happen, for example, when you carry a spare battery in your pocket or purse. Short-circuiting the terminals may damage the battery or the connecting object.

Leaving the battery in hot or cold places, such as in a closed car in summer or winter conditions, will reduce the capacity and lifetime of the battery. Always try to keep the battery between 15°C and 25°C (59°F and 77°F). A device with a hot or cold battery may not work temporarily, even when the battery is fully charged. Battery performance is particularly limited in temperatures well below freezing.

Do not dispose of batteries in a fire as they may explode. Batteries may also explode if damaged. Dispose of batteries according to local regulations. Please recycle when possible. Do not dispose as household waste.

■ Nokia battery authentication guidelines

Always use original Nokia batteries for your safety. To check that you are getting an original Nokia battery, purchase it from an authorized Nokia dealer, look for the Nokia Original Enhancements logo on the packaging, and inspect the hologram label using the following steps:

Successful completion of the four steps is not a total assurance of the authenticity of the battery. If you have any reason to believe that your battery is not an authentic original Nokia battery, you should refrain from using it, and take it to the nearest authorized Nokia service point or dealer for assistance. Your authorized Nokia service point or dealer will inspect the battery for authenticity. If authenticity cannot be verified, return the battery to the place of purchase.

Authenticate hologram



1. When looking at the hologram on the label, you should see the Nokia connecting hands symbol from one angle and the Nokia Original Enhancements logo when looking from another angle.



2. When you angle the hologram left, right, down, and up, you should see 1, 2, 3, and 4 dots on each side respectively.



3. Scratch the side of the label to reveal a 20-digit code, for example, 12345678919876543210. Turn the battery so that the numbers are facing upwards. The 20-digit code reads starting from the number at the top row followed by the bottom row.



4. Confirm that the 20-digit code is valid by following the instructions at www.nokia.com/batterycheck.

To create a text message enter the 20-digit code, for example, 12345678919876543210, and send to +44 7786 200276.

National and international operator charges will apply.

You should receive a message indicating whether the code can be authenticated.

What if your battery is not authentic?

If you cannot confirm that your Nokia battery with the hologram on the label is an authentic Nokia battery, please do not use the battery. Take it to the nearest authorized Nokia service point or dealer for assistance. The use of a battery that is not approved by the manufacturer may be dangerous and may result in poor performance and damage to your device and its enhancements. It may also invalidate any approval or warranty applying to the device.

To find out more about original Nokia batteries, visit www.nokia.com/battery.

Care and maintenance

Your device is a product of superior design and craftsmanship and should be treated with care. The suggestions below will help you protect your warranty coverage.

- Keep the device dry. Precipitation, humidity, and all types of liquids or moisture can contain minerals that will corrode electronic circuits. If your device does get wet, remove the battery, and allow the device to dry completely before replacing it.
- Do not use or store the device in dusty, dirty areas. Its moving parts and electronic components can be damaged.
- Do not store the device in hot areas. High temperatures can shorten the life of electronic devices, damage batteries, and warp or melt certain plastics.
- Do not store the device in cold areas. When the device returns to its normal temperature, moisture can form inside the device and damage electronic circuit boards.
- Do not attempt to open the device other than as instructed in this guide.
- Do not drop, knock, or shake the device. Rough handling can break internal circuit boards and fine mechanics.
- Do not use harsh chemicals, cleaning solvents, or strong detergents to clean the device.
- Do not paint the device. Paint can clog the moving parts and prevent proper operation.
- Use a soft, clean, dry cloth to clean any lenses, such as camera, proximity sensor, and light sensor lenses.
- Use only the supplied or an approved replacement antenna. Unauthorized antennas, modifications, or attachments could damage the device and may violate regulations governing radio devices.
- Use chargers indoors.
- Always create a backup of data you want to keep, such as contacts and calendar notes, before sending your device to a service facility.

All of the above suggestions apply equally to your device, battery, charger, or any enhancement. If any device is not working properly, take it to the nearest authorized service facility for service.

Additional safety information

Your device and its enhancements may contain small parts. Keep them out of the reach of small children.

■ Operating environment

Remember to follow any special regulations in force in any area, and always switch off your device when its use is prohibited or when it may cause interference or danger. Use the device only in its normal operating positions. This device meets RF exposure guidelines when used either in the normal use position against the ear or when positioned at least 2.2 centimeters (7/8 inch) from the body. When a carry case, belt clip, or holder is used for body-worn operation, it should not contain metal and should position the device the above-stated distance from your body.

To transmit data files or messages, this device requires a quality connection to the network. In some cases, transmission of data files or messages may be delayed until such a connection is available. Ensure that the above separation distance instructions are followed until the transmission is completed.

Parts of the device are magnetic. Metallic materials may be attracted to the device. Do not place credit cards or other magnetic storage media near the device, because information stored on them may be erased.

■ Medical devices

Operation of any radio transmitting equipment, including wireless phones, may interfere with the functionality of inadequately protected medical devices. Consult a physician or the manufacturer of the medical device to determine if they are adequately shielded from external RF energy or if you have any questions. Switch off your device in health care facilities when any regulations posted in these areas instruct you to do so. Hospitals or health care facilities may be using equipment that could be sensitive to external RF energy.

Pacemakers

Pacemaker manufacturers recommend that a minimum separation of 15.3 centimeters (6 inches) be maintained between a wireless phone and a pacemaker to avoid potential interference with the pacemaker. These recommendations are consistent with the independent research by and recommendations of Wireless Technology Research. Persons with pacemakers should do the following:

- Always keep the device more than 15.3 centimeters (6 inches) from the pacemaker
- Not carry the device in a breast pocket
- Hold the device to the ear opposite the pacemaker to minimize the potential for interference.

If you suspect interference, switch off your device, and move the device away.

Hearing aids

Some digital wireless devices may interfere with some hearing aids. If interference occurs, consult your service provider.

■ Vehicles

RF signals may affect improperly installed or inadequately shielded electronic systems in motor vehicles such as electronic fuel injection systems, electronic antiskid (antilock) braking systems, electronic speed control systems, and air bag systems. For more information, check with the manufacturer, or its representative, of your vehicle or any equipment that has been added.

Only qualified personnel should service the device, or install the device in a vehicle. Faulty installation or service may be dangerous and may invalidate any warranty that may apply to the device. Check regularly that all wireless device equipment in your vehicle is mounted and operating properly. Do not store or carry flammable liquids, gases, or explosive materials in the same compartment as the device, its parts, or enhancements. For vehicles equipped with an air bag, remember that air bags inflate with great force. Do not place objects, including installed or portable wireless equipment in the area over the air bag or in the air bag deployment area. If in-vehicle wireless equipment is improperly installed, and the air bag inflates, serious injury could result.

Using your device while flying in aircraft is prohibited. Switch off your device before boarding an aircraft. The use of wireless teledevices in an aircraft may be dangerous to the operation of the aircraft, disrupt the wireless telephone network, and may be illegal.

■ Potentially explosive environments

Switch off your device when in any area with a potentially explosive atmosphere, and obey all signs and instructions. Potentially explosive atmospheres include areas where you would normally be advised to turn off your vehicle engine.

Sparks in such areas could cause an explosion or fire resulting in bodily injury or even death. Switch off the device at refueling points such as near gas pumps at service stations. Observe restrictions on the use of radio equipment in fuel

depots, storage, and distribution areas; chemical plants; or where blasting operations are in progress. Areas with a potentially explosive atmosphere are often, but not always, clearly marked. They include below deck on boats, chemical transfer or storage facilities, vehicles using liquefied petroleum gas (such as propane or butane), and areas where the air contains chemicals or particles such as grain, dust, or metal powders.

■ Emergency calls



Important: Wireless phones, including this device, operate using radio signals, wireless networks, landline networks, and user-programmed functions. Because of this, connections in all conditions cannot be guaranteed. You should never rely solely on any wireless device for essential communications like medical emergencies.

To make an emergency call:

1. If the device is not on, switch it on. Check for adequate signal strength. Some networks may require that a valid SIM card is properly inserted in the device.
2. Press the end key as many times as needed to clear the display and ready the device for calls.
3. Enter the official emergency number for your present location. Emergency numbers vary by location.
4. Press the call key.

If certain features are in use, you may first need to turn those features off before you can make an emergency call. If the device is in the offline mode, you must change the profile to activate the phone function before you can make an emergency call. Consult this guide or your service provider for more information.

When making an emergency call, give all the necessary information as accurately as possible. Your wireless device may be the only means of communication at the scene of an accident. Do not end the call until given permission to do so.

■ Certification information (SAR)

This mobile device meets guidelines for exposure to radio waves

Your mobile device is a radio transmitter and receiver. It is designed not to exceed the limits for exposure to radio waves recommended by international guidelines. These guidelines were developed by the independent scientific organization ICNIRP and include safety margins designed to assure the protection of all persons, regardless of age and health.

The exposure guidelines for mobile devices employ a unit of measurement known as the Specific Absorption Rate or SAR. The SAR limit stated in the ICNIRP guidelines is 2.0 watts/kilogram (W/kg) averaged over 10 grams of tissue. Tests for SAR are conducted using standard operating positions with the device transmitting at its highest certified power level in all tested frequency bands. The actual SAR level of an operating device can be below the maximum value because the device is designed to use only the power required to reach the network. That amount changes depending on a number of factors such as how close you are to a network base station. The highest SAR value under the ICNIRP guidelines for use of the device at the ear is 0.64 W/kg.

Use of device accessories and enhancements may result in different SAR values. SAR values may vary depending on national reporting and testing requirements and the network band. Additional SAR information may be provided under product information at www.nokia.com.

Index

A

- access codes
 - barring password 10
 - change 94
 - lock code 9, 15
 - module PIN 10
 - PIN 9, 15
 - PIN2 10
 - PUK 10
 - PUK2 10
 - signing PIN 10
 - UPIN 9
 - UPUK 10
- access point
 - receiving settings 90
 - settings 90
- accessories. See enhancements
- activation keys 101
- active standby 19
- alarm clock. See clock.
- application
 - installing 99
 - removing 100
 - settings 100
- application manager 99

B

- battery
 - authentication 126
 - charging 15, 125
 - discharging 125
 - information 125
- Bluetooth
 - connection settings 105
 - disconnecting 107
 - paired devices 107
 - receiving data 107
 - sending data 105
- bookmarks
 - adding 69
 - saving 70
 - sending 69
 - viewing 68
- browser. See Web.

C

- cache 71
 - calculator 80
 - calendar 77
 - call register. See log.
 - calls
 - answering 26
 - barring 97
 - conference call 25
 - diverting 97
 - emergency 7, 131
 - ending 24
 - international 24
 - making 24
 - options during a call 26
 - rejecting 26
 - rejecting with SMS 26
 - speed dial 24, 49
 - swapping 26
 - voice dial 25
 - voice mailbox 24
 - waiting 26
 - camera 60
 - camera mode 18
 - certificates 95
 - certification information. See SAR.
 - clock 76
 - communication mode 18
 - connection manager 114
 - connectivity 104
 - contacts 47
 - converter 79
 - copyright protection. See activation keys.
- ## D
- data cable 124
 - data connection indicators 20
 - data transfer 102
 - device manager 101
 - downloading 11, 71

E

- e-mail
 - mailbox 38
 - settings 35
- e-mail messages
 - deleting 39
 - retrieving 38
- emergency calls 7, 131
- enhancements
 - general 8
 - settings 98

F

- file manager 81
- Flash Player 63

G

- gallery 50

H

- help 22

I

- IM. See instant messaging.
- indicators 20
- inserting
 - battery 12
 - memory card 14
 - SIM card 12
- instant messaging
 - connecting 108
 - contacts 112
 - conversation 111
 - groups 109, 110, 113
 - recording 111
 - settings 108

J

- joystick
 - scrolling 21
 - selecting 21

K

- keyguard. See keypad lock.
- keypad lock 23

L

- log
 - call duration 28
 - connection timer 29
 - dialed numbers 28
 - general 29
 - missed calls 28
 - packet data counter 29
 - received calls 28
 - recent calls 27, 28
 - settings 29

M

- mechanical modes 18
- media player. See RealPlayer.
- memory card 81
 - backing up information 83
 - formatting 82
 - inserting 14
 - locking 83
 - memory consumption 83
 - removing 14
- memory consumption
 - memory card 83
 - phone memory 81
- menu
 - accessing the functions 21
 - changing the view 21
- message settings
 - cell broadcast 46
 - e-mail 43
 - multimedia settings 42
 - other settings 46
 - service messages 45
 - text messages 41
- messages
 - cell broadcast 40
 - multimedia objects 36
 - organizing 37
 - outbox 40
 - receiving 36
 - sending 34
 - service commands 41
 - service messages 37
 - SIM messages 40
 - special message types 36
 - writing 34
- microSD card. See memory card

mobile browser. See Web.
music mode 19
music player
 library 52
 listening to music 53

N

network
 cell info 98
 selecting 98
network services 7
notes 80

O

one-touch dial. See speed dial.

P

phonebook. See contacts.
profiles 85
PTT. See push to talk.
push to talk
 access point 116
 callback requests 119
 channels 119
 group calls 118
 logging in 117
 logging out 117
 one-to-one calls 118
 settings 116

R

RealPlayer
 playing 61
 settings 62
recorder 62

S

SAR 131
security module 97
settings
 call 88
 connection 89
 data call 93
 date 94
 display 88
 enhancements 98

packet data 92
phone 86
phone language 86
predictive text input 87
security 94
standby mode 87
time 94
writing language 87
shortcuts 20
SIP 93
sound meter 75
speed dial
 assigning a phone number 48, 85
 calling 24
 changing a phone number 85
 deleting a phone number 85
standby mode
 active standby 19
 settings 87
 shortcuts 20
synchronization 122

T

text input
 copying text 32
 deleting text 32
 predictive 30, 31, 87
 traditional 30
themes 74
to-do 78
tutorial 22

U

USB. See data cable.

V

video editor 64
Visual Radio
 saving a station 55
 settings 58
 station directory 58
 station list 56
 station setup 57
 tuning a station 55
 turning on 55
 viewing visual content 57
voice commands 84
voice dialing 25

voice mailbox 84
voice recorder. See recorder.
volume 23

W

Web

browser settings 72
browsing 70
connecting 68

connection security 69
disconnecting 71
Nokia support 11
saving a page 70
settings 67
viewing a saved page 70
viewing bookmarks 68
writing text. See text input