

User guide



DECLARATION OF CONFORMITY

We, NOKIA CORPORATION, declare under our sole responsibility that the product RM-104 is in conformity with the provisions of the following Council Directive: 1999/5/EC.

A copy of the Declaration of Conformity can be found from http://www.nokia.com/phones/declaration_of_conformity/.

CE 0434



The crossed-out wheeled bin means that within the European Union the product must be taken to separate collection at the product end-of life. This applies to your device but also to any enhancements marked with this symbol. Do not dispose of these products as unsorted municipal waste.

Copyright © 2006 Nokia. All rights reserved.

Reproduction, transfer, distribution or storage of part or all of the contents in this document in any form without the prior written permission of Nokia is prohibited.

Nokia, Nokia Connecting People, Xpress-on and Pop-Port are trademarks or registered trademarks of Nokia Corporation. Other product and company names mentioned herein may be trademarks or tradenames of their respective owners.

Nokia tune is a sound mark of Nokia Corporation.

US Patent No 5818437 and other pending patents. T9 text input software Copyright (C) 1997-2006. Tegic Communications, Inc. All rights reserved.



Includes RSA BSAFE cryptographic or security protocol software from RSA Security.



Java
POWERED

Java is a trademark of Sun Microsystems, Inc.

This product is licensed under the MPEG-4 Visual Patent Portfolio License (i) for personal and non-commercial use in connection with information which has been encoded in compliance with the MPEG-4 Visual Standard by a consumer engaged in a personal and non-commercial activity and (ii) for use in connection with MPEG-4 video provided by a licensed video provider. No license is granted or shall be implied for any other use. Additional information including that relating to promotional, internal and commercial uses may be obtained from MPEG LA, LLC. See <http://www.mpegla.com>.

Nokia operates a policy of continuous development. Nokia reserves the right to make changes and improvements to any of the products described in this document without prior notice.

This device complies with Directive 2002/95/EC on the restriction of the use of certain hazardous substances in electrical and electronic equipment.

Under no circumstances shall Nokia be responsible for any loss of data or income or any special, incidental, consequential or indirect damages howsoever caused.

The contents of this document are provided "as is". Except as required by applicable law, no warranties of any kind, either express or implied, including, but not limited to, the implied warranties of

merchantability and fitness for a particular purpose, are made in relation to the accuracy, reliability or contents of this document. Nokia reserves the right to revise this document or withdraw it at any time without prior notice.

The availability of particular products may vary by region. Please check with the Nokia dealer nearest to you.

This device may contain commodities, technology or software subject to export laws and regulations from the US and other countries. Diversion contrary to law is prohibited.

9238054/Issue 3

Contents

For your safety	6	Delete messages	38
General information	9	Message settings	38
Overview of functions	9	Message counter	41
Access codes	9	7. Contacts	41
Configuration settings service	10	Search for a contact	41
Download content and applications	11	Save names and phone numbers	41
Nokia support on the Web	11	Save numbers, items, or an image	42
1. Get started	11	Copy contacts	42
Install the SIM card and battery	11	Edit contact details	42
Charge the battery	14	Delete contacts or contact details	43
Switch the phone on and off	15	Business cards	43
2. Your phone	16	My presence	43
Keys and parts	16	Subscribed names	44
Standby mode	17	Settings	45
Keypad lock (keyguard)	19	Groups	46
3. Call functions	20	Voice dialing	46
Make a call	20	Speed dials	47
Answer or reject a call	20	Info, service, and my numbers	47
Options during a call	21	8. Call register	48
4. Write text	22	Recent calls lists	48
Settings	22	Counters and timers	48
Predictive text input	22	Positioning	48
Traditional text input	23	9. Settings	49
5. Navigate the menus	23	Profiles	49
6. Messages	24	Themes	49
Text messages (SMS)	24	Tones	50
Multimedia messages (MMS)	26	Lights	50
Memory full	29	Display	50
Flash messages	29	Time and date	51
Nokia Xpress audio messaging	30	My shortcuts	51
Folders	30	Connectivity	52
Instant messages (IM)	31	Call	54
E-mail application	36	Phone	55
Voice messages	38	Enhancement	55
Info messages	38	Configuration	56
Service commands	38	Security	57
		Restore factory settings	58
		10. Operator menu	58

11. Gallery	58	16. Applications	78
12. Media	59	Games.....	78
Camera.....	59	Collection	79
Radio	60	17. Web	82
Recorder	61	Set up browsing.....	82
Sound meter.....	62	Connect to a service.....	82
13. Push to talk	63	Browse pages	83
Push to talk menu	63	Appearance settings.....	84
Connect to and disconnect PTT	64	Cookies.....	85
Make and receive a PTT call	64	Scripts over secure connections	85
Callback requests.....	66	Bookmarks.....	85
Add a one-to-one contact.....	67	Downloads.....	86
Create and set up groups	68	Service inbox.....	86
PTT settings	69	Cache memory	87
14. Sports	70	Browser security.....	87
Compass	70	18. SIM services	89
Stopwatch.....	72	19. PC connectivity	90
Countdown timer.....	73	PC Suite.....	90
Audio message.....	73	Packet data, HSCSD, and CSD	90
Thermometer.....	73	Data-communication applications	90
15. Organiser	74	20. Battery information	91
Alarm clock.....	74	Charging and discharging.....	91
Calendar	74	Nokia battery authentication guidelines.	92
To-do list.....	75	CARE AND MAINTENANCE	94
Notes	76	Additional safety information	95
Calculator.....	76		
Synchronization	77		

For your safety

Read these simple guidelines. Not following them may be dangerous or illegal. Read the complete user guide for further information.



SWITCH ON SAFELY

Do not switch the phone on when wireless phone use is prohibited or when it may cause interference or danger.



ROAD SAFETY COMES FIRST

Obey all local laws. Always keep your hands free to operate the vehicle while driving. Your first consideration while driving should be road safety.



INTERFERENCE

All wireless phones may be susceptible to interference, which could affect performance.



SWITCH OFF IN HOSPITALS

Follow any regulations or rules. Switch the phone off near medical equipment.



SWITCH OFF IN AIRCRAFT

Follow any restrictions. Wireless devices can cause interference in aircraft.



SWITCH OFF WHEN REFUELLING

Do not use the phone at a refuelling point. Do not use near fuel or chemicals.



SWITCH OFF NEAR BLASTING

Follow any restrictions. Do not use the phone where blasting is in progress.



USE SENSIBLY

Use only in the normal position as explained in the product documentation. Do not touch the antenna unnecessarily.



QUALIFIED SERVICE

Only qualified personnel may install or repair this product.



ENHANCEMENTS AND BATTERIES

Use only approved enhancements and batteries. Do not connect incompatible products.

**WATER-RESISTANCE**

Your phone is not water-resistant. Keep it dry.

**BACK-UP COPIES**

Remember to make back-up copies or keep a written record of all important information stored in your phone.

**CONNECTING TO OTHER DEVICES**

When connecting to any other device, read its user guide for detailed safety instructions. Do not connect incompatible products.

**EMERGENCY CALLS**

Ensure the phone is switched on and in service. Press the end key as many times as needed to clear the display and return to the start screen. Enter the emergency number, then press the call key. Give your location. Do not end the call until given permission to do so.

■ About your device

The wireless device described in this guide is approved for use on the EGSM 900 and GSM 1800 and 1900 networks. Contact your service provider for more information about networks.

When using the features in this device, obey all laws and respect the privacy and legitimate rights of others.



Warning: To use any features in this device, other than the alarm clock, the device must be powered on. Do not switch the device on when the use of wireless devices may cause interference or danger.

■ Network services

To use the phone, you must have service from a wireless service provider. Many of the features in this device depend on features in the wireless network to function. These network services may not be available on all networks or you may have to make specific arrangements with your service provider before you can utilize network services. Your service provider may need to give you additional instructions for their use and explain what charges will apply. Some networks may have limitations that affect how you can use network services. For instance, some networks may not support all language-dependent characters and services. Your service provider may have requested that certain features be disabled or not activated in your device. If so, they will not appear on your device menu. Your device may also have been specially configured. This configuration may include

changes in menu names, menu order and icons. Contact your service provider for more information.

This device supports WAP 2.0 protocols (HTTP and SSL) that run on TCP/IP protocols. Some features of this device, such as text messages, multimedia messages, Nokia Xpress audio messaging, instant messaging service, e-mail, presence enhanced contacts, mobile Internet services, content and application download, synchronization with a remote Internet server, and push to talk require network support for these technologies.

■ Shared memory

The phone has two memories. The following features may share the first memory: contacts, text messages, multimedia messages (but no attachments), instant messaging, groups, voice tags, calendar, and to-do notes. The second shared memory is used by files stored in *Gallery*, attachments of multimedia messages, e-mail, and Java™ applications. Use of one or more of these features may reduce the memory available for the remaining features sharing memory. For example, saving many Java applications may use all of the available memory. Your device may display a message that the memory is full when you try to use a shared memory feature. In this case, delete some of the information or entries stored in the shared memory features before continuing. Some of the features, such as text messages, may have a certain amount of memory specially allotted to them in addition to the memory shared with other features.

■ Enhancements

A few practical rules about accessories and enhancements are as follows:

- Keep all accessories and enhancements out of the reach of small children.
- When you disconnect the power cord of any accessory or enhancement, grasp and pull the plug, not the cord.
- Check regularly that enhancements installed in a vehicle are mounted and are operating properly.
- Installation of any complex car enhancements must be made by qualified personnel only.

General information

■ Overview of functions

Your phone provides many functions that are practical for daily use, such as a calendar, a clock, an alarm clock, a radio and a built-in camera. Your phone also supports the following functions:

- Enhanced data rates for GSM evolution (EDGE): see Packet data (EGPRS) p. 53
- Extensible hypertext markup language (XHTML): see Web p. 82
- E-mail application: see E-mail application p. 36
- Audio messaging: see Nokia Xpress audio messaging p. 30
- Instant messaging: see Instant messages (IM) p. 31
- Push to talk: see Push to talk p. 63
- Presence-enhanced contacts: see My presence p. 43
- Java 2 Platform, Micro Edition (J2ME™) including Fitness coach, an interactive, personal trainer: see Applications p. 78

■ Access codes

Security code

The security code (5 to 10 digits) helps to protect your phone against unauthorized use. The preset code is 12345. To change the code and set the phone to request the code, see Security p. 57.

PIN codes

The personal identification number (PIN) code and the universal personal identification number (UPIN) code (4 to 8 digits) help to protect your SIM card against unauthorized use. See Security p. 57.

The PIN2 code (4 to 8 digits) may be supplied with the SIM card and is required for some functions.

The module PIN is required to access the information in the security module. See Security module p. 87.

The signing PIN is required for the digital signature. See Digital signature p. 89.

PUK codes

The personal unblocking key (PUK) code and the universal personal unblocking key (UPUK) code (8 digits) is required to change a blocked PIN code and UPIN code, respectively. The PUK2 code (8 digits) is required to change a blocked PIN2 code. If the codes are not supplied with the SIM card, contact your local service provider for the codes.

Barring password

The barring password (4 digits) is required when using the [Call barring service](#). See Security p. 57.

■ Configuration settings service

To use some of the network services, such as the mobile Internet services, MMS, or remote Internet server synchronization, your phone needs the correct configuration settings. You may be able to receive the settings directly as a configuration message. Upon receiving the settings, you need to save them to your phone. The service provider may provide a PIN that is needed to save the settings. For more information on availability, contact your network operator, service provider, nearest authorized Nokia dealer, or visit the support area on the Nokia Web site: <www.nokia.com/support>.

When you have received a configuration message, [Configuration sett. received](#) is displayed.

To save the settings, select **Show** > **Save**. If the phone requests [Enter settings' PIN](#); enter the PIN code for the settings, and select **OK**. To receive the PIN code, contact the service provider that supplies the settings. If no settings are saved yet, these settings are saved and set as default configuration settings. Otherwise, the phone asks [Activate saved configuration settings?](#)

To discard the received settings, select **Exit** or **Show > Discard**.

To edit the settings, see Configuration p. 56.

■ Download content and applications

You may be able to download new content (for example, themes) to the phone (network service). Select the download function (for example, in the *Gallery* menu). To access the download function, see the respective menu descriptions. For the availability of different services, pricing, and tariffs, contact your service provider.



Important: Use only services that you trust and that offer adequate security and protection against harmful software.

■ Nokia support on the Web

Check <www.nokia.com/support> or your local Nokia Web site for the latest version of this guide, additional information, downloads, and services related to your Nokia product.

1. Get started

■ Install the SIM card and battery

Always switch the device off and disconnect the charger before removing the battery.

Keep all SIM cards out of the reach of small children. For availability and information on using SIM card services, contact your SIM card vendor. This may be the service provider, network operator, or another vendor.

This device is intended for use with a BL-5B battery.

The SIM card and its contacts can easily be damaged by scratches or bending, so be careful when handling, inserting, or removing the card.

Before installing the SIM card, always make sure that the phone is switched off and disconnected from any enhancement before removing the battery.

Get started

With the back of the phone facing you, press the indentations on both sides of the lower shell (1). Slide the bottom of the shell off to remove it (2).

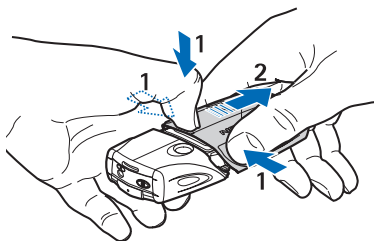

Grasp the removal flap, and gently pull it up (3).

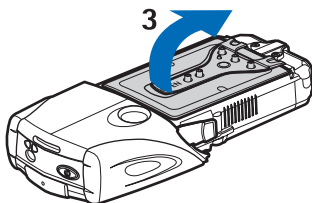

Lift the battery from the compartment (4).

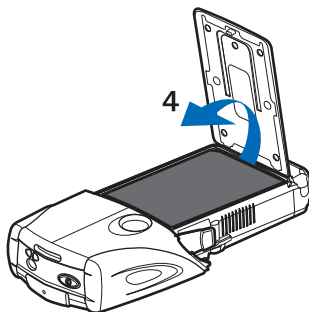

Slide the cover of the SIM card holder toward the bottom end of the phone until it unlocks (5). Swing the cover of the SIM card holder open (6). Insert the SIM card into the holder.

Ensure that the beveled corner of the SIM card is on the left, and the golden contact area is facing down (7)

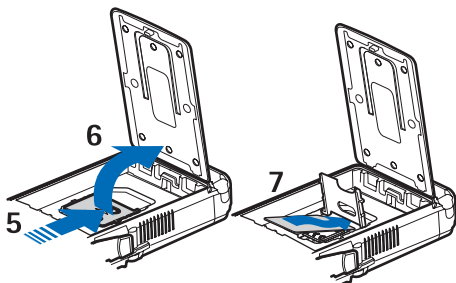

Close the cover of the SIM card holder (8). Slide the cover of the SIM card holder toward the top end of the phone until it locks into place (9). Position the battery with the contacts aligned to the golden contacts on the phone. Insert the battery into the battery slot, contact end first (10). Close the battery flap (11).

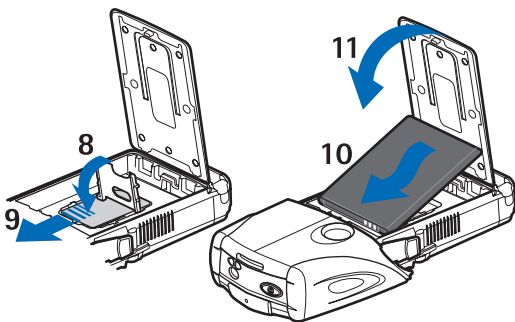

Place the phone into the lower shell, sliding the shell forward until it locks into place (12).

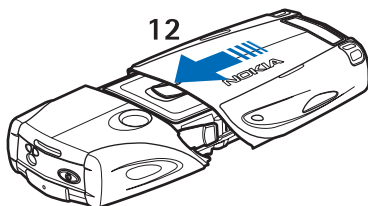

Always use original Nokia batteries. See the Nokia battery authentication guidelines p. 92.

■ Charge the battery



Warning: Use only batteries, chargers and enhancements approved by Nokia for use with this particular model. The use of any other types may invalidate any approval or warranty, and may be dangerous.

Check the model number of any charger before use with this device. This device is intended for use when supplied with power from an AC-2, ACP-12, ACP-7, or AC-1 battery charger.

For availability of approved enhancements, please check with your dealer. When you disconnect the power cord of any enhancement, grasp and pull the plug, not the cord.

1. Open the flap on the bottom of the phone.
2. Connect the charger to a wall socket.
3. Connect the lead from the charger to the socket on the bottom of your phone.

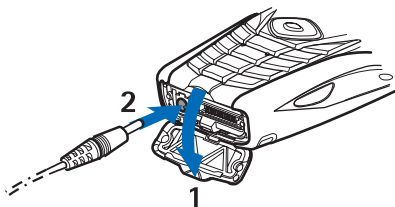

If the battery is completely discharged, it may take a few minutes before the charging indicator appears on the display, or before calls can be made.

The charging time depends on the charger and the battery used. For example, charging a BL-5B battery with the ACP-12 charger takes approximately 1 hour and 10 minutes and with the AC-2 charger approximately 1 hour and 50 minutes while the phone is in the standby mode.

■ Switch the phone on and off



Warning: Do not switch the phone on when wireless phone use is prohibited or when it may cause interference or danger.

Press and hold the power key.

If the phone asks for a PIN or a UPIN code, enter the code (displayed as ****), and select *OK*.

Turn off the phone when replacing the battery or SIM card. Wait until the backlights are off before removing the battery.

Your device has an internal antenna.

Note: As with any other radio transmitting device, do not touch the antenna unnecessarily when the device is switched on. Contact with the antenna affects call quality and may cause the device to operate at a higher power level than otherwise needed. Avoiding contact with the antenna area when operating the device optimizes the antenna performance and the battery life.



2. Your phone

■ Keys and parts

- Flashlight (1). To activate it, press and hold # in the standby mode.
- Power key to turn the phone on and off (2)
- Bubble level to level the phone while using the compass, and standby light (3)
- Volume keys to adjust the volume of the earpiece, loudspeaker, or headset when connected to the phone (4)
- Push to talk (PTT) key (5)
- Left selection key, middle selection key and right selection key (6). The function of these keys depends on the guiding texts shown above the keys in the display.
- 4-way scroll key (7) to scroll through the menu, for example, or to move the cursor when writing text (7)
- Call key (8) to dial a phone number or answer a call
- End key (9) to end a call or exit functions
- Keys 0 – 9 to enter numbers and characters (10). Keys * and # have various functions in different situations.

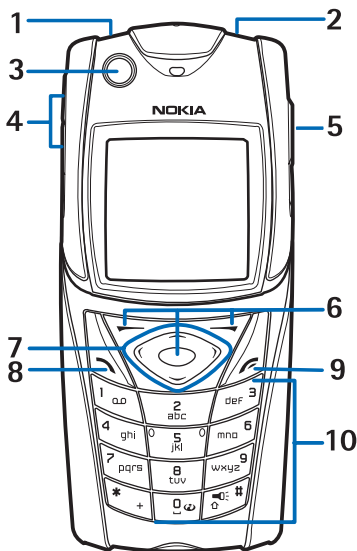

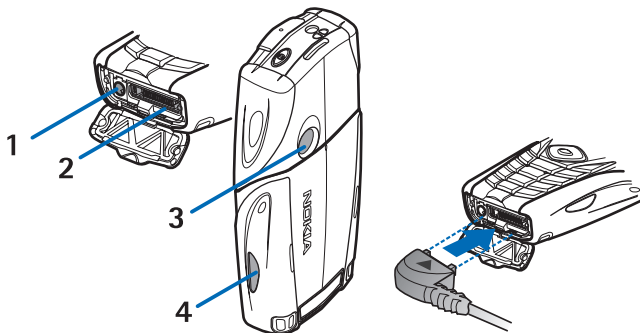

- Charger connector (1)
- Pop-Port™ connector used, for example, with headsets and the data cable (2)
- Camera lens (3)
- Infrared (IR) port (4)

■ Standby mode

When the phone is ready for use, and you have not entered any characters, the phone is in the standby mode.

Display

- Name of the network or the operator logo (1)
- Signal strength of the cellular network at your current location (2)
- Battery charge level (3)
- Left selection key is **Go to** (4)
- Middle selection key is **Menu** (5)
- Right selection key is **Audio message** (6) or another shortcut to a function

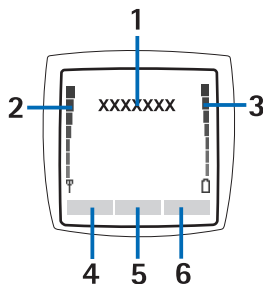

you have selected: see My shortcuts p. 51. Operator variants may have an operator-specific name to access an operator-specific Web site.

Personal shortcut list

The left selection key is **Go to**.

To view the functions in the personal shortcut list, select **Go to**. To activate a function select it.

To view a list with available functions, select **Go to** > **Options** > **Select options**. To add a function to the shortcut list, select **Mark**. To remove a function from the list, select **Unmark**.

To rearrange the functions on your personal shortcut list, select **Go to** > **Options** > **Organise**. Select the desired function and **Move** and the place where you want to move the function.

Shortcuts in standby mode











- To access the list of dialed numbers, press the call key once. Scroll to the number or name that you want and press the call key to call the number.
- To open the Web browser, press and hold 0.
- To call your voice mailbox, press and hold 1.
- Use the scroll key as a shortcut. See My shortcuts p. 51.
- To change the profile, open the list of profiles, briefly press the power key, and select the desired profile from the list.

Power saving

A digital clock view overwrites the display when no phone function has been used for a certain period of time. To activate the power saver, see [Power saver](#) in Display p. 50. To deactivate the screen saver, press any key.



Indicators

-  You received one or several text or picture messages. See [Read and reply to a SMS message p. 25](#).
-  You received one or more multimedia messages. See [Read and reply to a multimedia message p. 28](#).
-  The phone registered a missed call. See [Call register p. 48](#).
-  The keypad is locked. See [Keypad lock \(keyguard\) p. 19](#).
-  The phone does not ring for an incoming call or text message when [Incoming call alert](#) and [Message alert tone](#) are set to *Off*. See [Tones p. 50](#).
-  The alarm clock is set to *On*. See [Alarm clock p. 74](#).
-  When the packet data connection mode [Always online](#) is selected and the packet data service is available, the indicator is shown. See [Packet data \(EGPRS\) p. 53](#).
-  A packet data connection is established. See [Packet data \(EGPRS\) p. 53](#) and [Browse pages p. 83](#).
-  The packet data connection is suspended (on hold), for example, if there is an incoming or outgoing call during a packet data dial-up connection.
-  When the infrared connection is activated, this indicator is shown continuously.

■ Keypad lock (keyguard)

To prevent the keys from being accidentally pressed, select [Menu](#), and press * within 3.5 seconds to lock the keypad.

To unlock the keypad, select [Unlock](#), and press *. If the [Security keyguard](#) is set *On*, enter the security code if requested.

To answer a call when the keyguard is on, press the call key. When you end or reject the call, the keypad automatically locks again.

For [Automatic keyguard](#) and [Security keyguard](#), see [Phone p. 55](#).

When the keyguard is on, calls still may be possible to the official emergency number programmed into your device.

3. Call functions

■ Make a call

1. Enter the phone number, including the area code.

For international calls, press * twice for the international prefix (the + character replaces the international access code) and then enter the country code, the area code without the leading 0, if necessary, and the phone number.

2. To call the number, press the call key.
3. To end the call or to cancel the call attempt, press the end key.

To make a call using names, search for a name or phone number in *Contacts*, see Search for a contact p. 41. Press the call key to call the number.

To access the list of up to 20 numbers you last called or attempted to call, press the call key once in the standby mode. To call the number, select a number or name, and press the call key.

Speed dialing

Assign a phone number to one of the speed-dialing keys, 2 to 9. See Speed dials p. 47. Call the number in either of the following ways:

- Press a speed-dialing key, and then press the call key.
- If *Speed dialing* is set to *On*, press and hold a speed-dialing key until the call begins. See *Speed dialing* in Call p. 54.

■ Answer or reject a call

To answer an incoming call, press the call key. To end the call, press the end key.

To reject an incoming call, press the end key.

To mute the ringing tone, select *Silence*. Then, either answer or reject the call.



Tip: If the *Divert if busy* function is activated to divert the calls (for example, to your voice mailbox) rejecting an incoming call will also diverts the call. See Call p. 54.

If a compatible headset supplied with the headset key is connected to the phone, to answer and end a call, press the headset key.

Call waiting

To answer the waiting call during an active call, press the call key. The first call is put on hold. To end the active call, press the end key.

To activate the *Call waiting* function, see Call p. 54.

■ Options during a call

Many of the options that you can use during a call are network services. For availability, contact your network operator or service provider.

During a call, select *Options* and from the following options:

Call options are *Mute* or *Unmute*, *Contacts*, *Menu*, *Record*, *Lock keypad*, *Auto volume on*, *Loudspeaker* or *Handset*.

Network services options are *Answer* and *Reject*, *Hold* or *Unhold*, *New call*, *Add to conference*, *End call*, *End all calls*, and the following:

Send DTMF – to send tone strings

Swap – to switch between the active call and the call on hold

Transfer – to connect a call on hold to an active call and disconnect yourself

Conference – to make a conference call that allows up to five persons to take part in a conference call



Private call –to discuss privately in a conference call



Warning: Do not hold the device near your ear when the loudspeaker is in use, because the volume may be extremely loud.

4. Write text

You can enter text (for example, when writing messages) using traditional or predictive text input. When using traditional text input, press a number key, 1 to 9, repeatedly until the desired character appears. In predictive text input you can enter a letter with a single keypress.

When you are writing text, predictive text input is indicated by  and traditional text input by  at the top left of the display. **abc**, **abc**, or **ABC** appear next to the text input indicator, indicating the character case.

To change the character case and the text input mode, press #. **123** indicates number mode. To change from the letter to number mode, press and hold #, and select *Number mode*.

■ Settings

To set the writing language, select **Options** > *Writing language*. Predictive text input is only available for the languages listed.

Select **Options** > *Dictionary on* to set the predictive text input or *Dictionary off* to set traditional text input.

■ Predictive text input

Predictive text input is based on a built-in dictionary to which you can also add new words.

1. Start writing a word using the 2 to 9 keys. Press each key only once for a single letter. The word changes after each keypress.
2. When you have finished writing the word and it is correct, to confirm it, press 0 to add a space, or press any of the scroll keys. Press a scroll key to move the cursor.

If the word is not correct, press * repeatedly, or select **Options** > *Matches*. When the word that you want appears, confirm it.

If ? is displayed after the word, the word you intended to write is not in the dictionary. To add the word to the dictionary, select **Spell**. Enter the word (traditional text input is used), and select **Save**.

3. Start writing the next word.

Write compound words

Enter the first part of the word, and press the scroll key right to confirm it. Write the last part of the word, and confirm the word.

■ Traditional text input

Press a number key, 1 to 9, repeatedly until the desired character appears. Not all characters available under a number key are printed on the key. The characters available depend on the writing language. See Settings p. 22.

If the next letter you want is located on the same key as the present one, wait until the cursor appears, or press any of the scroll keys and enter the letter.

The most common punctuation marks and special characters are available under the 1 key.

5. Navigate the menus

The phone offers you an extensive range of functions, which are grouped into menus.

1. To access the menu, select **Menu**. To change the menu view, select **Options** > **Main menu view** > **List** or **Grid**.
2. Scroll through the menu and select a submenu (for example, **Settings**).
3. If the menu contains submenus, select the one that you want (for example, **Call settings**).
4. If the selected menu contains further submenus, select the one that you want (for example, **Anykey answer**).

5. Select the setting of your choice.
6. To return to the previous menu level, select **Back**. To exit the menu, select **Exit**.

6. Messages



The message services can only be used if they are supported by your network or service provider.



Note: When sending messages, your phone may display the words *Message sent*. This is an indication that the message has been sent by your device to the message centre number programmed into your device. This is not an indication that the message has been received at the intended destination. For more details about messaging services, check with your service provider.



Important: Exercise caution opening messages. Messages may contain malicious software or otherwise be harmful to your device or PC.

Only devices that have compatible features can receive and display messages. The appearance of a message may vary depending on the receiving device.

■ Text messages (SMS)

Using the short message service (SMS) you can send and receive multipart messages made of several ordinary text messages (network service) that can contain pictures.

Before you can send any text, picture, or e-mail message, you must save your message center number. See Message settings p. 38.

To check SMS e-mail service availability and to subscribe to the service, contact your service provider.

Your device supports the sending of text messages beyond the character limit for a single message. Longer messages will be sent as a series of two or more messages. Your service provider may charge accordingly. Characters that use accents or other marks, and characters from some language options like Chinese, take up more space limiting the number of characters that can be sent in a single message.





Note: Picture message function can be used only if it is supported by your network operator or service provider. Only compatible devices that offer picture message features can receive and display picture messages. The appearance of a message may vary depending on the receiving device.

At the top of the display, you can see the message length indicator that tracks the number of characters available. For example, 10/2 means that you can still add 10 characters for the text to be sent as two messages.

Write and send a SMS message

1. Select **Menu** > **Messages** > **Create message** > **Text message**.
2. Enter a message. See Write text p. 22. To insert text templates or a picture into the message, see Templates p. 26. Each picture message comprises several text messages. Sending one picture or multipart message may cost more than sending one text message.
3. To send the message, select **Send** > **Recently used**, **To phone number**, **To many**, or **To e-mail address**. To send a message using a predefined message profile, select **Via sending profile**. For the message profile, see Text and SMS e-mail p. 38. Select or enter a phone number or e-mail address, or select a profile.

Read and reply to a SMS message



 is shown when you have received a message or an e-mail using SMS. The blinking  indicates that the message memory is full. Before you can receive new messages, delete some of your old messages from the **Inbox** folder.

1. To view a new message, select **Show**. To view it later, select **Exit**.
To read the message later, select **Menu** > **Messages** > **Inbox**. If more than one message has been received, select the message that you want to read.  indicates an unread message.
2. While reading a message, select **Options** and delete or forward the message, edit the message as a text message or an SMS e-mail, rename the message you are reading, move it to another folder, or view or extract message details. You can also copy text from the

beginning of the message to your phone calendar as a reminder note. To save the picture in the *Templates* folder when reading a picture message, select *Save picture*.

3. To reply as a message, select **Reply** > *Text message*, *Multimedia msg.*, *Flash message* or *Audio message*. Enter the reply message. When replying to an e-mail, first confirm or edit the e-mail address and subject.
4. To send the message to the displayed number, select **Send** > **OK**.

Templates

Your phone has text templates  and picture templates  that you can use in text, picture, or SMS e-mail messages.

To access the template list, select **Menu** > *Messages* > *Saved items* > *Text messages* > *Templates*.

■ Multimedia messages (MMS)

A multimedia message can contain text, sound, a picture, a calendar note, a business card, or a video clip. If the message is too large, the phone may not be able to receive it. Some networks allow text messages that include an Internet address where you can view the multimedia message.

You cannot receive multimedia messages during a call, a game, another Java application, or an active browsing session over GSM data. Because delivery of multimedia messages can fail for various reasons, do not rely solely upon them for essential communications.



Note: Only devices that have compatible features can receive and display multimedia messages. The appearance of a message may vary depending on the receiving device.

Write and send a multimedia message

To set the settings for multimedia messaging, see Multimedia p. 39. To check availability and to subscribe to the multimedia messaging service, contact your service provider.

1. Select **Menu** > *Messages* > *Create message* > *Multimedia msg.*
2. Enter a message. See Write text p. 22.

To insert a file, select **Options** > *Insert* and from the following options:

Image, *Sound clip* or *Video clip* – to insert a file from *Gallery*

New image opens the *Camera* – to take a new image to be added to the message

New sound clip opens the *Recorder* – to make a new record to be added to the message

Business card or *Calendar note* – to insert a business card or a calendar note in the message.

Slide – to insert a slide to the message. Your phone supports multimedia messages that contain several pages (slides). Each slide can contain text, one image, a calendar note, a business card, and one sound clip. To open a desired slide if the message contains several slides, select **Options** > *Previous slide*, *Next slide*, or *Slide list*. To set the interval between the slides, select **Options** > *Slide timing*. To move the text component to the top or bottom of the message, select **Options** > *Place text first* or *Place text last*.

The following options may also be available: *Delete* to delete an image, slide, or sound clip from the message, *Clear text*, *Preview*, or *Save message*. In *More options* the following options may be available: *Insert contact*, *Insert number*, *Message details*, and *Edit subject*.

3. To send the message, select **Send** > *Recently used*, *To phone number*, *To e-mail address*, or *To many*.
4. Select the contact from the list, or enter the recipient's phone number or e-mail address, or search for it in *Contacts*. Select **OK**. The message is moved to the *Outbox* folder for sending.

While the multimedia message is being sent, the animated indicator  is displayed and you can use other functions on the phone. If the sending fails, the phone tries to resend it a few times. If this fails, the

message remains in the *Outbox* folder, and you can try to resend it later.

If you select *Save sent messages* > *Yes*, the sent message is saved in the *Sent items* folder. See Multimedia p. 39. When the message is sent, it is not an indication that the message has been received at the intended destination.



Copyright protections may prevent some images, ringing tones, and other content from being copied, modified, transferred or forwarded.

Read and reply to a multimedia message

The default setting of the multimedia message service is generally on.





Important: Exercise caution when opening messages. Multimedia message objects may contain malicious software or otherwise be harmful to your device or PC.

When your phone receives a multimedia message, the animated  is displayed. When the message has been received,  and the text *Multimedia message received* are shown.

1. To read the message, select *Show*. To view it later, select *Exit*.
To read the message later, select *Menu* > *Messages* > *Inbox*. In the list of messages,  indicates an unread message. Select the message that you want to view.
2. The function of the middle selection key changes according to the currently displayed attachment in the message.
To view the whole message if the received message contains a presentation, a sound clip, or view a video clip, select *Play*. To zoom in on an image, select *Zoom*. To view a business card or calendar note or to open a theme object, select *Open*.
3. To reply to the message, select *Options* > *Reply* > *Text message*, *Multimedia msg.*, *Flash message*, or *Audio message*. Enter the reply message, and select *Send*. You can send the reply message only to the person who sent you the original message.
Select *Options* to access available options.

■ Memory full

When you have received a new text message and the message memory is full,  blinks and *Text msgs. memory full. Delete msgs.* is shown. Select **No**, and delete some messages from a folder. To discard the waiting message, select **Exit > Yes**.

When you have a new multimedia message waiting and the memory for the messages is full,  blinks and *Multimedia memory full. View waiting msg.* is shown. To view the waiting message, select **Show**. Before you can save the waiting message, delete old messages to free memory space. To save the message, select **Save**.

To discard the waiting message, select **Exit > Yes**. If you select **No**, you can view the message.

■ Flash messages

Flash messages are text messages that are instantly displayed upon reception.

Write a flash message

Select **Menu > Messages > Create message > Flash message**. Write your message. The maximum length of a flash message is 70 characters. To insert a blinking text into the message, select *Insert blink char.* from the options list to set a marker. The text after the marker blinks until a second marker is inserted.

Receive a flash message

A received flash message is not automatically saved. To read the message, select **Read**. To extract phone numbers, e-mail addresses, and Web site addresses from the current message, select **Options > Use detail**. To save the message, select **Save** and the folder in which you want to save the message.

■ Nokia Xpress audio messaging

With this functionality, use the multimedia message service to create and send a voice message in a convenient way. Multimedia messaging service must be activated before this service can be used.

1. Select **Menu** > *Messages* > *Create message* > *Audio message*. The recorder opens. To use the recorder, see Recorder p. 61.
2. When the message is ready to send, select **Options** > *Play* to check the message before sending, *Replace sound clip* to repeat the recording, *Save message*, *Save sound clip* to save the recording in *Gallery*, *Edit subject* to insert a subject to the message, *Message details* to view the message details, or *Loudspeaker* or *Handset*.
3. To send the message, select **Send** > *Recently used*, *To phone number*, *To e-mail address*, or *To many*. Depending on your operator, more options may be available.
4. Select the contact from the list, enter the recipient's phone number or e-mail address, or search for it in *Contacts*. Select **OK**, and the message is moved to the *Outbox* folder for sending.

Receive an audio message

When your phone is receiving an audio message, the text *1 audio message received* is shown. Select **Play** to open the message, or select **Show** > **Play**, if there are more than one message received. Select **Options** to see the options available. To listen to the message later, select **Exit**.

To save the message, select **Options** > **Save** and the folder in which you want to save the message.

■ Folders

The phone saves received text and multimedia messages in the *Inbox* folder.

Multimedia messages that have not yet been sent are moved to the *Outbox* folder.

If you have selected *Message settings* > *Text messages* > *Save sent messages* > *Yes*, and *Message settings* > *Multimedia msgs.* > *Save sent messages* > *Yes*, sent messages are saved in the *Sent items* folder.

To save the text message that you are writing and wish to send later in the *Saved items* folder, select *Options* > *Save message* > *Saved text msgs.* For multimedia messages, select the option *Save message*.  indicates unsent messages.

To organize your text messages, you can move some of them to *My folders* or add new folders for your messages. Select *Messages* > *Saved items* > *Text messages* > *My folders*.

To add a folder, select *Options* > *Add folder*. If you have not saved any folders, select *Add*.

To delete or rename a folder, scroll to the desired folder, and select *Options* > *Delete folder* or *Rename folder*.

■ Instant messages (IM)

Instant messaging (network service) is a way to send short, simple text messages to online users.

Before you can use instant messaging, you must subscribe to the service. To check availability and costs, and to subscribe to the service, contact your network operator or service provider, from whom you also receive a unique ID, password, and settings.

To set the required settings for the instant messaging service, see *Connect. settings* in *Access the instant messaging menu* p. 31. The icons and texts on the display may vary, depending on the instant messaging service.

Depending on the network, an active instant messaging conversation may consume the phone battery faster than normal, and you may need to connect the phone to a charger.

Access the instant messaging menu

To access the menu while still offline, select *Menu* > *Messages* > *Instant messages*. If more than one set of connection settings for the

instant messaging service is available, select the desired one. If there is only one set defined, it is selected automatically.

The following options are shown:

Login – to connect to the instant messaging service

Saved convers. – to view, erase or rename the instant messaging conversations that you have saved during the instant messaging session

Connect. settings – to edit the settings needed for messaging and presence connection

Connect to the instant messaging service





To connect to the instant messaging service, enter the *Instant messages* menu, activate an instant messaging service, and select *Login*. When the phone has successfully connected, *Logged in* is displayed.

To disconnect from the instant messaging service, select *Logout*.

Start an instant messaging session

Open the *Instant messages* menu, and connect to the service. Start the service in different ways.





- Select *Conversations* to view the list of new and read instant messages or invitations for instant messaging during the active instant messaging session. Scroll to the message or invitation that you want, and select *Open* to read the message.

 indicates the new and  read group messages.  indicates the new and  the read instant messages.

 indicates the invitations.

The icons and texts on the display may vary, depending on the instant messaging service.

- *IM contacts* to view the contacts that you have added. Scroll to the contact with whom you would like to chat and select *Chat* or *Open* if a new contact is shown in the list. To add contacts see *Contacts for instant messaging* p. 34.

 indicates the online and  the offline contacts in the phone contacts memory.  indicates a blocked contact.  indicates a contact that has been sent a new message.

- **Groups** > **Public groups** to display the list of bookmarks to public groups provided by the network operator or service provider. To start a instant messaging session with a group, scroll to a group, and select **Join**. Enter your screen name that you want to use in the conversation. When you have successfully joined the group conversation, you can start a group conversation. To create a private group, see Groups p. 35.
- **Search** > **Users** or **Groups** to search for other instant messaging users or public groups on the network by phone number, screen name, e-mail address, or name. If you select **Groups**, you can search for a group by a member in the group or by group name, topic, or ID. To start the conversation when you have found the user or the group that you want, select **Options** > **Chat** or **Join group**. Start a conversation from **Contacts**, see View the subscribed names p. 45.

Accept or reject an invitation

In the standby mode, when you are connected to the instant messaging service and you receive a new invitation, **New invitation received** is displayed. To read it, select **Read**. If more than one invitation is received, scroll to the invitation you want, and select **Open**. To join a private group conversation, select **Accept**, and enter a screen name; to reject or delete the invitation, select **Options** > **Reject** or **Delete**.

Read a received instant message

In the standby mode, when you are connected to the instant messaging service and you receive a new message that is not a message associated with an active conversation, **New instant message** is displayed. To read it, select **Read**. If you receive more than one message, scroll to the message and select **Open**.

New messages received during an active conversation are held in *Instant messages > Conversations*. If you receive a message from someone who is not in *IM contacts*, the sender ID is displayed. To save a new contact that is not in the phone memory, select *Options > Save contact*.

Participate in a conversation



To join or start an instant messaging session, select *Write*. Write your message, and select *Send* or press the call key to send it. Select *Options* to access available options: *View conversation*, *Save contact*, *Group members*, *Block contact*, *End conversation*.

Edit your availability status

1. Open the *Instant messages* menu, and connect to the instant messaging service.
2. To view and edit your own availability information or screen name, select *My settings*.
3. To allow all other instant messaging users to see you when you are online, select *Availability > Available for all*.

To allow only the contacts on your instant messaging contact list to see you when you are online, select *Availability > Avail. for contacts*.

To appear as being offline, select *Availability > Appear offline*.

When you are connected to the instant messaging service,  indicates that you are online, and  indicates that you are not visible to others.

Contacts for instant messaging

To add contacts to the instant messaging contacts list, connect to the instant messaging service, and select *IM contacts*. To add a contact to the list, select *Options > Add contact* or, if you have no contacts added, select *Add*. Select *Enter ID manually*, *Search from serv.*, *Copy from server*, or *By mobile number*.

Scroll to a contact, and to start a conversation, select **Chat**, or select **Options** > *Contact info*, *Block contact* or *Unblock contact*, *Add contact*, *Remove contact*, *Change list*, *Copy to server*, or *Availability alerts*.

Block and unblock messages

To block messages, connect to the instant messaging service and select **Conversations** > *IM contacts*, or join or start a conversation. Scroll to the contact from whom you want to block incoming messages, and select **Options** > *Block contact* > *OK*.

To unblock the messages, connect to the instant messages service and select *Blocked list*. Scroll to the contact from whom you want to unblock messages, and select *Unblock*.

Groups

You can create your own private groups for an instant messaging conversation, or use the public groups provided by the service provider. The private groups exist only during an instant messaging conversation. The groups are saved on the server of the service provider. If the server you are logged on to does not support group services, all group-related menus are dimmed.

Public groups

Groups – You can bookmark public groups that your service provider may maintain. Connect to the instant messaging service, and select **Public groups**. Scroll to a group with which you want to chat, and select **Join**. If you are not in the group, enter your screen name as your nickname for the group. To delete a group from your group list, select **Options** > *Delete group*.

To search for a group, select **Groups** > **Public groups** > **Search groups**. You can search for a group by a member in the group, by group name, topic, or ID.

Create a private group

Connect to the instant messaging service, and select **Groups** > **Create group**. Enter the name for the group and the screen name that you want

to use. Mark the private group members in the contacts list, and write an invitation.

■ E-mail application

The e-mail application allows you to access your compatible e-mail account from your phone when you are not in the office or at home. This e-mail application is different from the SMS and MMS e-mail function.

Your phone supports POP3 and IMAP4 e-mail servers. Before you can send and retrieve any e-mail, you may need to do the following:

- Obtain a new e-mail account or use the current one. Regarding the availability of your e-mail account, contact your e-mail service provider.
- For the settings required for e-mail, contact your e-mail service provider. You may receive the e-mail configuration settings as a configuration message. See Configuration settings service p. 10. You can also enter the settings manually. See Configuration p. 56.

To activate the e-mail settings, select **Menu** > *Messages* > *Message settings* > *E-mail messages*. See E-mail p. 40.

This application does not support keypad tones.

Write and send an e-mail

1. Select **Menu** > *Messages* > *E-mail* > *Create e-mail*.
2. Enter the recipient's e-mail address, a subject and the e-mail message.

To attach a file to the e-mail, select **Options** > *Attach* and the file in *Gallery*.

3. Select *Send* > *Send now*.

Download e-mail

1. To access the e-mail application, select **Menu** > *Messages* > *E-mail*.
2. To download e-mail messages that have been sent to your e-mail account, select *Retrieve*.

To download new e-mail messages and to send e-mail that has been saved in the *Outbox* folder, select **Options** > *Retrieve and send*.

To download first the headings of the new e-mail messages that have been sent to your e-mail account, select **Options** > *Check new e-mail*. Then, to download the selected e-mail, mark the desired ones, and select **Options** > *Retrieve*.

3. Select the new message in *Inbox*. To view it later, select **Back**.  indicates an unread message.

Read and reply to e-mail

Select **Menu** > *Messages* > *E-mail* > *Inbox*. While reading the message, select **Options** to view the available options.

To reply to an e-mail, select **Reply** > *Original text* or *Empty screen*. To reply to many, select **Options** > *Reply to all*. Confirm or edit the e-mail address and subject; then write your reply. To send the message, select **Send** > *Send now*.

Inbox and other folders

Your phone saves e-mail that you have downloaded from your e-mail account in the *Inbox* folder. *Other folders* contains the following folders: *Drafts* for saving unfinished e-mail, *Archive* for organizing and saving your e-mail, *Outbox* for saving e-mail that has not been sent, and *Sent items* for saving e-mail that has been sent.

To manage the folders and their e-mail content, select **Options** > *Manage folder*.

Delete e-mail messages

Select **Menu** > *Messages* > *E-mail* > **Options** > *Manage folder* and the desired folder. Mark the messages that you want to delete. To delete them, select **Options** > *Delete*.

Deleting an e-mail from your phone does not delete it from the e-mail server. To set the phone to delete the e-mail also from the e-mail server, select **Menu** > *Messages* > *E-mail* > **Options** > *Extra settings* > *Leave copy*: > *Delete retr. msgs*.

■ Voice messages

The voice mailbox is a network service and you may need to subscribe to it. For details, contact your service provider.

To call your voice mailbox, select [Menu](#) > [Messages](#) > [Voice messages](#) > [Listen to voice messages](#). To enter, search for, or edit your voice mailbox number, select [Voice mailbox number](#).

If supported by the network,  indicates that there are new voice messages. Select [Listen](#) to call your voice mailbox number.

■ Info messages

Select [Menu](#) > [Messages](#) > [Info messages](#). With the [Info messages](#) network service, you can receive messages on various topics from your service provider. To check availability, topics, and the relevant topic numbers, contact your service provider.

■ Service commands

Select [Menu](#) > [Messages](#) > [Service commands](#). Write and send service requests (also known as USSD commands) to your service provider, such as activation commands for network services.

■ Delete messages

To delete all messages from a folder, select [Menu](#) > [Messages](#) > [Delete messages](#) and the folder from which you want to delete the messages. Select [Yes](#), and if the folder contains unread messages, the phone asks whether you want to delete them also. Select [Yes](#) again.

■ Message settings

Text and SMS e-mail

The message settings affect the sending, receiving, and viewing of messages.

Select [Menu](#) > [Messages](#) > [Message settings](#) > [Text messages](#), and from the following options:

Sending profile – If more than one message profile set is supported by your SIM card, select the set you want to change.

The following options may be available: *Message centre number* (delivered from your service provider), *Messages sent via*, *Message validity*, *Default recipient number* (text messages) or *E-mail server* (e-mail), *Delivery reports*, *Use packet data*, *Reply via same centre* (network service) and *Rename sending profile*.

Save sent messages > *Yes* – Set the phone to save the sent text messages in the *Sent items* folder.

Multimedia

The message settings affect the sending, receiving, and viewing of multimedia messages.

Select **Menu** > *Messages* > *Message settings* > *Multimedia msgs.* and from the following options:

Save sent messages > *Yes* – to set the phone to save sent multimedia messages in the *Sent items* folder

Delivery reports – to ask the network to send delivery reports about your messages (network service)

Default slide timing – to define the default time between slides in multimedia messages

Allow multimedia reception > *Yes* or *No* – to receive or to block the multimedia message. If you select *In home network*, you cannot receive multimedia messages when outside your home network.

Incoming multimedia messages > *Retrieve*, *Retrieve manually*, or *Reject* – to allow the reception of multimedia messages automatically, manually after being prompted, or to reject the reception

Configuration settings > *Configuration* – Only the configurations that support multimedia messaging are shown. Select a service provider, *Default*, or *Personal config.* for multimedia messaging. Select *Account* and select a multimedia messaging service account contained in the active configuration settings.

Allow adverts – to receive or reject advertisements. This setting is not shown if *Allow multimedia reception* is set to *No*.

E-mail

The settings affect the sending, receiving, and viewing of e-mail.

You may receive the configuration settings for the e-mail application as a configuration message. See Configuration settings service p. 10. You can also enter the settings manually. See Configuration p. 56.

To activate the settings for the e-mail application, select **Menu** > *Messages* > *Message settings* > *E-mail messages* and from the following options:

Configuration – Select the set that you would like to activate.

Account – Select an account provided by the service provider.

My name – Enter your name or nickname.

E-mail address – Enter e-mail address.

Include signature – You can define a signature that is automatically added to the end of your e-mail when you write your message.

Reply-to address – Enter the e-mail address to which you want the replies to be sent.

SMTP user name – Enter the name that you want to use for outgoing mail.

SMTP password – Enter the password that you want to use for outgoing mail.

Display terminal window – Select *Yes* to perform manual user authentication for Intranet connections.

Incoming server type – Select either *POP3* or *IMAP4*, depending on the type of e-mail system that you are using. If both types are supported, select *IMAP4*.

Incoming mail settings – Select available options for POP3 or IMAP4.

Other settings

To select other settings for messages, select **Menu** > *Messages* > *Message settings* > *Other settings*. To change the font size for reading and writing messages, select *Font size*. To set the phone to replace character-based smileys with graphical ones, select *Graphical smileys* > *Yes*.

■ Message counter

Select **Menu** > *Messages* > *Message counter* for approximate information on your recent communications.

7. Contacts



You can save names and phone numbers (*Contacts*) in the phone memory and in the SIM-card memory.

The phone memory can save contacts with numbers and text items. You can also save an image for a certain number of names.

Names and numbers saved in the SIM-card memory are indicated by .

■ Search for a contact

Select **Menu** > *Contacts* > *Names* > *Options* > *Search*. Scroll through the list of contacts or enter the first letter of the name for which you are searching.

■ Save names and phone numbers

Names and numbers are saved in the used memory. Select **Menu** > *Contacts* > *Names* > *Options* > *Add new contact*. Enter the name and the phone number.

■ Save numbers, items, or an image

In the phone memory for contacts, you can save different types of phone numbers and short text items per name.

The first number you save is automatically set as the default number. It is indicated with a frame around the number type indicator (for example, ). When you select a name (for example, to make a call), the default number is used unless you select another number.

1. Make sure that the memory in use is either *Phone* or *Phone and SIM*.
2. Scroll to the name to which you want to add a new number or text item, and select **Details** > **Options** > *Add detail*.
3. To add a number, select *Number* and one of the number types.

To add another detail select a text type or an image from *Gallery*.

To search for an ID from the server of your service provider if you have connected to the presence service, select *User ID* > *Search*. See My presence p. 43. If only one ID is found, it is automatically saved. Otherwise, to save the ID, select **Options** > *Save*. To enter the ID, select *Enter ID manually*.

To change the number type, scroll to the desired number, and select **Options** > *Change type*. To set the selected number as the default number, select *Set as default*.

4. Enter the number or text item; to save it, select **OK**.
5. To return to the standby mode, select **Back** > **Exit**.

■ Copy contacts

Search for the contact you want to copy and select **Options** > *Copy*. You can copy names and phone numbers from the phone contact memory to the SIM card memory, or vice versa. The SIM card memory can save names with one phone number attached to them.

■ Edit contact details

1. Search for the contact you want to edit, select *Contact details*, and scroll to the desired name, number, text item, or image.

2. To edit a name, number, or text item, or to change an image, select **Options** > *Edit name*, *Edit number*, *Edit detail*, or *Change image*.

You cannot edit an ID when it is on the *IM contacts* or *Subscribed names* list.

■ Delete contacts or contact details

To delete all the contacts and the details attached to them from the phone or SIM card memory, select **Menu** > *Contacts* > *Delete all contacts* > *From phone mem.* or *From SIM card*. Confirm with the security code.

To delete a contact, search for the desired contact, and select **Options** > *Delete contact*.

To delete a number, text item, or an image attached to the contact, search for the contact, and select *Contact details*. Scroll to the desired detail, and select **Options** > *Delete* > *Delete number*, *Delete detail*, or *Delete image*. Deleting an image from contacts does not delete it from *Gallery*.

■ Business cards

You can send and receive a person's contact information from a compatible device that supports the vCard standard as a business card.

To send a business card, search for the contact whose information you want to send, and select *Contact details* > **Options** > *Send bus. card* > *Via multimedia*, *Via text message*, or *Via infrared*.

When you have received a business card, select **Show** > **Save** to save the business card in the phone memory. To discard the business card, select **Exit** > **Yes**.

■ My presence

With the presence service (network service), you can share your presence status with other users with compatible devices and access to the service. Presence status includes your availability, status message, and personal logo. Other users who have access to the service and who

request your information are able to see your status. The requested information is shown in *Subscribed names* in the viewers' *Contacts* menu. You can personalize the information that you want to share with others and control who can see your status.

Before you can use presence, you must subscribe to the service. To check the availability and costs, and to subscribe to the service, contact your network operator or service provider from whom you receive your unique ID, password, and the settings for the service. See Configuration p. 56.

While you are connected to the presence service, you can use the other phone functions of the phone; the presence service is active in the background. If you disconnect from the service, your presence status is shown for a certain amount of time to viewers depending on the service provider.

Select *Menu* > *Contacts* > *My presence* and select from the following options:

Connect to 'My presence' service or *Disconnect from service* — to connect to or disconnect from the service.

View my presence — to view the status in *Private pres.* and *Public presence*.

Edit my presence — to change your presence status. Select *My availability*, *My presence message*, *My presence logo*, or *Show to*.

My viewers > *Current viewers*, *Private list*, or *Blocked list*

Settings > *Show current presence in idle*, *Synchronise with profiles*, *Connection type*, or *Connect. settings*

■ Subscribed names

You can create a list of contacts whose presence status information you want to be aware of. You can view the information if allowed by the contacts and the network. To view these subscribed names, scroll through the contacts or use the *Subscribed names* menu.

Make sure that the memory in use is either *Phone* or *Phone and SIM*.

To connect to the Presence service, select [Menu](#) > [Contacts](#) > [My presence](#) > [Connect to 'My presence' service](#).

Add contacts to the subscribed names



1. Select [Menu](#) > [Contacts](#) > [Subscribed names](#).
2. If you have no contacts on your list, select [Add](#). Otherwise, select [Options](#) > [Subscribe new](#). The list of your contacts is shown.
3. Select a contact from the list and, if the contact has an user ID saved, the contact is added to the subscribed names list.

View the subscribed names

To view presence information, see Search for a contact p. 41.

1. Select [Menu](#) > [Contacts](#) > [Subscribed names](#).

The status information of the first contact on the subscribed names list is displayed. The information that the person wants to give to the others may include text and some of the following icons:

, , or  indicates that the person is available, discreet or not available.

 indicates that the person's presence information is not available.

2. Select [Details](#) to view the details of the selected contact, or select [Options](#) > [Subscribe new](#), [Chat](#), [Send message](#), [Send bus. card](#), or [Unsubscribe](#).

Unsubscribe a contact

To unsubscribe a contact from the [Contacts](#) list, select the contact and [Details](#) > the user ID > [Options](#) > [Unsubscribe](#) > [OK](#).

To unsubscribe, use the [Subscribed names](#) menu. See View the subscribed names p. 45.

■ Settings

Select [Menu](#) > [Contacts](#) > [Settings](#) and from the following options:

[Memory in use](#) – to select SIM card or phone memory for your contacts

Contacts view – to select how the names and numbers in contacts are displayed

Memory status – to view the free and used memory capacity

■ Groups

Select **Menu** > *Contacts* > *Groups* to arrange the names and phone numbers saved in the memory into caller groups with different ringing tones and group images.

■ Voice dialing

You can make a phone call by saying a voice tag that has been added to a phone number. Any spoken words, such as a name, can be a voice tag. The number of voice tags you can create is limited.

Before using voice tags, note that:

- Voice tags are not language-dependent. They are dependent on the speaker's voice.
- You must say the name exactly as you said it when you recorded it.
- Voice tags are sensitive to background noise. Record voice tags and use them in a quiet environment.
- Very short names are not accepted. Use long names and avoid similar names for different numbers.



Note: Using voice tags may be difficult in a noisy environment or during an emergency, so you should not rely solely upon voice dialling in all circumstances.

Add and manage voice tags

Save or copy the contacts to the phone memory for which you want to add a voice tag. You can also add voice tags to the names in the SIM card, but if you replace your SIM card with a new one, you must first delete the old voice tags before you can add new ones.

1. Search for the contact to which you want to add a voice tag.
2. Select **Details**, scroll to the desired phone number, and select **Options** > *Add voice tag*.

3. Select **Start**, and say clearly the words you want to record as a voice tag. After recording, the phone plays the recorded tag.

 appears after the phone number with a voice tag in *Contacts*.

To check the voice tags, select **Menu** > *Contacts* > *Voice tags*. Scroll to the contact with the voice tag that you want, and select an option to listen to, delete, or change the recorded voice tag.

Make a call with a voice tag

If the phone has an application running that is sending or receiving data using a GPRS connection, you must end the application before voice dialing.

1. In the standby mode, press and hold the volume down key. A short tone is heard, and *Speak now* is displayed.
2. Say the voice tag clearly. The phone plays the recognized voice tag, and dials the phone number of the voice tag after 1.5 seconds.

If you are using a compatible headset with the headset key, press and hold the headset key to start the voice dialing.

■ Speed dials

To assign a number to a speed-dialing key, select **Menu** > *Contacts* > *Speed dials*, and scroll to the speed-dialing number that you want.

Select *Assign*, or if a number has already been assigned to the key, select **Options** > *Change*. Select **Search**, the name, then the number you want to assign. If the *Speed dialling* function is off, the phone asks whether you want to activate it. See also *Speed dialling* in Call p. 54.

To make a call using the speed-dialing keys, see Speed dialing p. 20.

■ Info, service, and my numbers

Select **Menu** > *Contacts* and from the following functions:

Info numbers – to call the information numbers of your service provider if the numbers are included on your SIM card (network service)

Service numbers – to call the service numbers of your service provider if the numbers are included on your SIM card (network service)

My numbers – to view the phone numbers assigned to your SIM card, if the numbers are included on your SIM card

8. Call register



The phone registers the phone numbers of identified, missed, received, and dialed calls; the message recipients; and the approximate length of your calls.

The phone registers if it is switched on and within the network's service area, and the network supports these functions.

■ Recent calls lists

When you select **Options** in the *Missed calls*, *Received calls* or *Dialled numbers*, or *Message Recipients* menu, you can view the time of the call; edit, view or call the registered phone number; add it to the memory; or delete it from the list. You can also send a text message. To delete the recent calls lists, select *Clear recent call lists*.

■ Counters and timers



Note: The actual invoice for calls and services from your service provider may vary, depending upon network features, rounding-off for billing, taxes and so forth.

Some timers may be reset during service or software upgrades.

Select **Menu** > *Call register* > *Call duration*, *Packet data counter*, or *Packet data conn. timer* for approximate information on your recent communications.

■ Positioning

The network may send you a location request. You can ensure that the network delivers location information from your phone only if you

approve it (network service). Contact your network operator or service provider to subscribe and to agree upon the delivery of location information.

To accept or reject the location request, select [Accept](#) or [Reject](#). If you miss the request, the phone automatically accepts or rejects it according to what you have agreed with your network operator or service provider. The phone displays *1 missed position request*. To view the missed location request, select [Show](#).

To view the information on the 10 most recent privacy notifications and requests, or to delete them, select [Menu](#) > [Call register](#) > [Positioning](#) > [Position log](#) > [Open folder](#) or [Delete all](#).

9. Settings



■ Profiles

Your phone has various setting groups, called profiles, for which you can customize the phone tones for different events and environments.

Select [Menu](#) > [Settings](#) > [Profiles](#). Scroll to a profile, and select it.

To activate the selected profile, select [Activate](#).

To set the profile to be active until a certain time up to 24 hours, select [Timed](#) and set the time the profile setting shall end. When the time set for the profile expires, the previous profile that was not timed, becomes active.

To personalize the profile, select [Personalise](#). Select the setting you want to change, and make the changes. To change your presence status information, select [My presence](#) > [My availability](#) or [My presence message](#). The [My presence](#) menu is available if you set [Synchronise with profiles](#) to [On](#). See My presence p. 43.

■ Themes

A theme contains many elements for personalizing your phone, such as wallpaper, screen saver, color scheme, and a ringing tone.

Select **Menu** > *Settings* > *Themes* and select from the following options:

Select theme — to set a theme in your phone. A list of folders in *Gallery* opens. Open the *Themes* folder, and select a theme.

Theme downloads — to open a list of links to download more themes. See Downloads p. 86.

■ Tones

You can change the settings of the selected active profile.

Select **Menu** > *Settings* > *Tones*. Select and change *Incoming call alert*, *Ringing tone*, *Ringing volume*, *Vibrating alert*, *Push to talk settings*, *Message alert tone*, *Instant message alert tone*, *Keypad tones*, *Warning tones* and *Alert for*. You can find the same settings in the *Profiles* menu. See Profiles p. 49.

To set the phone to ring only for calls from phone numbers that belong to a selected caller group, select *Alert for*. Scroll to the caller group you want or *All calls*, and select **Mark**.

■ Lights

Select **Menu** > *Settings* > *Lights* > *Light effects* to activate the standby light if the phone is switched on and the display light is switched off. The light has two blinking sequences: one for indicating standby mode and one for indicating received messages or missed calls.

Using the light effects increases the demand on battery power and reduces the battery life.

■ Display

Select **Menu** > *Settings* > *Display* and from the following options:

Wallpaper — to add the background image to the display in standby mode. To select, activate, or deactivate the wallpaper, select *Select wallpaper* > *On* or *Off*. Select *Select slide set* and a folder in the *Gallery* to use the images in the folder as a slide set. To download more images for wallpaper, select *Graphic downloads*.

Screen saver > *On* – to activate the screen saver. To set the time after which the screen saver is activated, select *Time-out*. To select a graphic for the screen saver, select *Image* and choose an image or a graphic from the *Gallery*. Select *Select slide set* and a folder in the *Gallery* to use the images in the folder as a slide set. To download more images for the screen saver, select *Graphic downloads*.

Power saver > *On* – to save some battery power. A digital clock is displayed when no function of the phone is used for a certain time.

Colour schemes – to change the color in some display components, for example, menu background color and signal and battery bar colors.

Idle state font colour – to select the color for the texts on the display in the standby mode.

Operator logo – to set your phone to display or hide the operator logo. The menu is dimmed, if you have not saved the operator logo. For more information on availability of an operator logo, contact your network operator or service provider.

Display contrast – to adjust the contrast level on the phone display

■ Time and date

Select *Menu* > *Settings* > *Time and date* and from the following options:

Clock – to set the phone to show the clock in the standby mode, adjust the clock, and select the time zone and the time format

Date – to set the phone to show the date in the standby mode, set the date, and select the date format and date separator

Auto-update of date & time (network service) – to set the phone to automatically update the time and date according to the current time zone

■ My shortcuts

With personal shortcuts, you get quick access to often used functions of the phone. To manage the shortcuts, select *Menu* > *Settings* > *My shortcuts* and from the following options:

Right selection key – to select a function from the list for the right selection key. See also Standby mode p. 17. This menu may not be shown, depending on your service provider.

Scroll key – to select shortcut functions for the scroll key. Scroll to the desired scroll key, select **Change** and a function from the list. To remove a shortcut function from the key, select *(empty)*. To reassign a function for the key, select **Assign**. This menu may not be shown, depending on your service provider.

Voice commands – to activate phone functions by saying a voice tag. Select a folder, scroll to a function to which you want to add a voice tag, and select **Add**.  indicates a voice tag. To add a voice command, see Add and manage voice tags p. 46. To activate a voice command, see Make a call with a voice tag p. 47.

■ Connectivity

You can connect your phone to compatible devices using an infrared connection. You can also define the settings for packet data dial-up connections.

Infrared

You can set up the phone to send and receive data through its infrared (IR) port. To use an IR connection, the device with which you want to establish a connection must be IrDA compliant. You can send or receive data to or from a compatible phone or data device (for example, a computer) through the IR port of your phone.

Do not point the IR (infrared) beam at anyone's eye or allow it to interfere with other IR devices. This device is a Class 1 laser product.

When sending or receiving data, ensure that the IR ports of the sending and receiving devices are pointing at each other and that there are no obstructions between the devices.

To activate the IR port of your phone to receive data using IR, select **Menu > Settings > Connectivity > Infrared**.

To deactivate the IR connection, select **Menu > Settings > Connectivity > Infrared**. When the phone displays *Deactivate infrared?*, select **Yes**.

If data transfer is not started within 2 minutes after the activation of the IR port, the connection is cancelled and must be started again.

IR connection indicator

When **IR** is shown continuously, the IR connection is activated, and your phone is ready to send or receive data through its IR port.

When **IR** blinks, your phone is trying to connect to the other device, or a connection has been lost.

Packet data (EGPRS)

Enhanced general packet radio service (EGPRS), packet data, is a network service which allows mobile phones to send and receive data over an Internet protocol (IP)-based network. It enables wireless access to data networks such as the Internet.

The applications that may use packet data are MMS, browsing sessions, e-mail, remote SyncML, Java application downloading, and the PC dial-up.

To define how to use the service, select **Menu > Settings > Connectivity > Packet data > Packet data connection**.

Select **When needed** to set the packet data connection to be established when an application needs it. The connection will be closed when the application is terminated.

Select **Always online** to set the phone to automatically connect to a packet data network when it is switched on.

G indicates a packet data connection.

Modem settings

You can connect the phone using an IR or a data cable (CA-42) connection to a compatible PC, and use the phone as a modem to enable packet data connectivity from the PC.

To define the settings for connections from the PC, select **Menu** > **Settings** > **Connectivity** > **Packet data** > **Packet data settings** > **Active access point**, activate the access point you want to use, and select **Edit active access point**. Select **Alias for access point**, and enter a nick name for the currently selected access point. Select **Packet data access point**, and enter the access point name (APN) to establish a connection to an EGPRS network.

You can also set the dial-up service settings (access point name) on your PC using the Nokia Modem Options software. See PC Suite p. 90. If you have set the settings both on the PC and on your phone, the PC settings are used.

■ Call

Select **Menu** > **Settings** > **Call** and from the following options:

Automatic volume control – to set the phone to automatically adjust the speaker volume according to the background noise

Call divert (network service) – to divert your incoming calls. You may not be able to divert your call, if some call barring functions are active. See **Call barring service** in Security p. 57.

Anykey answer > **On** – to answer an incoming call, briefly press any key, except the end key and the left and right selection keys.

Automatic redial > **On** – to set your phone to make a maximum of 10 attempts to connect the call after an unsuccessful call attempt

Speed dialling > **On** – to activate speed dialling. To set up speed dialling, see Speed dials p. 47. To dial, press and hold the corresponding number key.

Call waiting > **Activate** – to set the network to notify you of an incoming call while you have a call in progress (network service). See Call waiting p. 21.

Summary after call > **On** – to briefly display the approximate duration and cost (network service) of the call after each call

Send my caller ID (network service) > **Yes, No, or Set by network**

Line for outgoing calls (network service) — to select the phone line 1 or 2 to make calls, if supported by your SIM card

■ Phone

Select **Menu** > *Settings* > *Phone* and from the following options:

Language settings — to set the display and writing language

Memory status — to view the free and used memory in *Gallery*, *Messages*, and *Applications*

Automatic keyguard — to set the keypad of your phone to lock automatically after a preset time delay when the phone is in the standby mode and no function of the phone has been used. Select *On*, and set the delay from 5 seconds to 60 minutes.

Security keyguard — to set the phone to ask for the security code when you unlock the keyguard. Enter the security code, and select *On*.

When the keyguard is on, calls still may be possible to the official emergency number programmed into your device.

Cell info display > *On* — to receive information from the network operator depending on the network cell used (network service).

Welcome note — to enter a welcome note to be shown briefly when the phone is switched on

Operator selection > *Automatic* — to set the phone automatically to select one of the cellular networks available in your area. With *Manual*, you can select a network that has a roaming agreement with your home network operator.

Confirm SIM service actions — see SIM services p. 89.

Help text activation — to select whether the phone shows help texts

Start-up tone — to select whether the phone plays a start-up tone when the phone is switched on

■ Enhancement

This menu is shown only if the phone is, or has been, connected to a compatible mobile enhancement.

Select **Menu** > **Settings** > **Enhancements**. You can select an enhancement menu if the corresponding enhancement is, or has been, connected to the phone. Depending on the enhancement, select from the following options:

Default profile – to select the profile that you want to be automatically activated when you connect to the selected enhancement

Automatic answer – to set the phone to answer an incoming call automatically after 5 seconds. If **Incoming call alert** is set to **Beep once** or **Off**, automatic answer is off.

Lights – to set the lights permanently **On**. Select **Automatic** to set the lights on for 15 seconds after a key press

Text phone > **Use text phone** > **Yes** – to use the text phone settings instead of headset or loopset settings

■ Configuration

You can configure your phone with settings that are required for certain services to function correctly. The services are browser, multimedia messaging, remote Internet server synchronization, presence, and e-mail application. Get the settings from your SIM card, from a service provider as a configuration message, or enter your personal settings manually. You can store configuration settings from up to 10 service providers in the phone and manage them within this menu.

To save the configuration settings received by a configuration message from a service provider, see Configuration settings service p. 10.

Select **Menu** > **Settings** > **Configuration** and from the following options:

Default configuration settings – to view the service providers saved in the phone. Scroll to a service provider, and select **Details** to view the applications that the configuration settings of this service provider support. To set the configuration settings of the service provider as default settings, select **Options** > **Set as default**. To delete configuration settings, select **Delete**.

Activate default in all applications – to activate the default configuration settings for supported applications

Preferred access point – to view the saved access points. Scroll to an access point, and select **Options** > *Details* to view the name of the service provider, data bearer, and packet data access point or GSM dial-up number.

Connect to service provider support – to download the configuration settings from your service provider

Personal configuration settings – to add new personal accounts for various services manually, and to activate or delete them. To add a new personal account if you have not added any, select **Add new**; otherwise, select **Options** > *Add new*. Select the service type, and select and enter each of the required parameters. The parameters differ according to the selected service type. To delete or activate a personal account, scroll to it, and select **Options** > *Delete* or *Activate*.

■ Security

When security features that restrict calls are in use (such as call barring, closed user group and fixed dialing) calls still may be possible to the official emergency number programmed into your device.

Select **Menu** > **Settings** > *Security* and from the following options:

PIN code request – to set the phone to ask for your PIN or UPIN code every time the phone is switched on. Some SIM cards do not allow the code request to be turned off.

Call barring service (network service) – to restrict incoming calls to and outgoing calls from your phone. A barring password is required.

Fixed dialling – to restrict your outgoing calls to selected phone numbers if this function is supported by your SIM card

Closed user group (network service) – to specify a group of people whom you can call and who can call you

Security level > *Phone* – the phone asks for the security code whenever a new SIM card is inserted into the phone. Select *Memory* and the phone asks for the security code when SIM card memory is selected and you want to change the memory in use.

Access codes – to set the PIN code or UPIN code in use, or to change the security code, PIN code, UPIN code, PIN2 code, and barring password

Code in use – to select whether the PIN code or UPIN code should be active

Pin2 code request – to select whether PIN2 code is required when using a specific phone feature which is covered by the PIN2 code

■ Restore factory settings

To reset some of the menu settings to their original values, select **Menu** > *Settings* > *Restore factory sett.*. Enter the security code. The data you have entered or downloaded is not deleted, for example, the names and phone numbers saved in *Contacts*.

10. Operator menu

This menu lets you access a portal to services provided by your network operator. The name and the icon depend on the operator. For more information, contact your network operator. If this menu is not shown the following menu numbers change accordingly.

The operator can update this menu with a service message. For more information. See to Service inbox p. 86.

11. Gallery



In this menu you can manage graphics, images, recordings, video clips, themes, tones and received files. These files are arranged in folders.

Your phone supports an activation key system to protect acquired content. Always check the delivery terms of any content and activation key before acquiring them, as they may be subject to a fee.

Copyright protections may prevent some images, ringing tones, and other content from being copied, modified, transferred, or forwarded.

The files stored in *Gallery* use a memory that may have a capacity of approximately 3.5 MB.

1. Select **Menu** > *Gallery*.
2. Scroll to the desired folder. To view a list of files in the folder, select **Open** > **Options** and one of the available options.
3. Scroll to the file you want to view, and select **Open** > **Options** and one of the available functions.

Send – to send the selected file using MMS or IR

Delete all – to delete all the files and folders in the selected folder

Edit image – to insert text, a frame or clip-art into the selected picture, or to crop the image

Open in sequence – to view the files in the folder one by one

Zoom – to increase the size of the image

Mute audio (*Unmute audio*) – to mute (unmute) the sound file

Set contrast – to adjust the contrast level of the image

Activate content – to update the activation key of the selected file. The option is only shown if the activation key updating is supported by the file.

Activation key list – to view the list of all available activation keys. You can delete the activation keys (for example, delete the expired ones).

12. Media



Copyright protections may prevent some images, ringing tones, and other content from being copied, modified, transferred or forwarded.

■ Camera

You can take photos or record video clips with the built-in camera. The camera produces pictures in JPEG format and video clips in 3GP format.

When taking and using images or video clips, obey all laws and respect local customs as well as the privacy and legitimate rights of others.

Take a photo

Select **Menu** > **Media** > **Camera** > **Capture** or, if Push to talk is switched off, press the camera release key. The phone saves the photo in **Gallery** > **Images**. To take another photo, select **Back**; to send the photo as a multimedia message, select **Send**. To view options, select **Options**.

Record a video clip

Select **Menu** > **Media** > **Camera**. To select video mode, scroll left, or select **Options** > **Change mode** > **Video**; select **Record**. To pause the recording, select **Pause**; to resume the recording, select **Continue**. To stop the recording, select **Stop**. The phone saves the recording in **Gallery** > **Video clips**. To view the options, select **Options**.

■ Radio

The FM radio depends on an antenna other than the wireless devices antenna. A compatible headset or enhancement needs to be attached to the device for the FM radio to function properly.



Warning: Listen to music at a moderate level. Continuous exposure to high volume may damage your hearing. Do not hold the device near your ear when the loudspeaker is in use, because the volume may be extremely loud.

Select **Menu** > **Media** > **Radio**. To use the graphical keys ▲, ▼, ◀, or ▶ on the display, scroll left or right to the desired key, and select it. To change the volume, press the volume keys.

Save radio channels

1. To start the channel search, select and hold ◀ or ▶. To change the radio frequency in 0.05 MHz steps, briefly press ◀ or ▶.
2. To save the channel to a memory location, 1 to 9, press and hold the corresponding number key. To save the channel in the memory

location from 10 to 20, press briefly 1 or 2, and press and hold the desired number key, 0 to 9.

3. Enter the name of the channel, and select **OK**.

Listen to the radio

Select **Menu** > **Media** > **Radio**. To scroll to the desired channel, select ▲ or ▼ or press the headset key To select a radio channel location, briefly press the corresponding number keys.

Select **Options** and from the following options:

Switch off – to turn off the radio

Save channel – to save a new channel, and enter the channels name

Channels – to select the list of saved channels. To delete or rename a channel, scroll to the desired channel, and select **Options** > *Delete channel* or *Rename*.

Mono output or *Stereo output* – to listen to the radio in monophonic sound or in stereo

Loudspeaker or *Headset* – to listen to the radio using the loudspeaker or headset. Keep the headset connected to the phone. The lead of the headset functions as the radio antenna.

Set frequency – to enter the frequency of the desired radio channel

You can normally make a call or answer an incoming call while listening to the radio. During the call, the volume of the radio is muted.

When an application using a packet data or HSCSD connection is sending or receiving data, it may interfere with the radio.



■ Recorder



You can record pieces of speech, sound, or an active call for 3 minutes.

The recorder cannot be used when a data call or packet data connection is active.

Record sound

1. Select **Menu** > **Media** > **Recorder**.

To use the graphical keys, , , or , on the display, scroll left or right to the desired key, and select it.

2. To start the recording, select . To start the recording during a call, select **Options** > *Record*. While recording a call, all parties to the call hear a faint beeping sound about every 5 seconds. When recording a call, hold the phone in the normal position near to your ear.
3. To end the recording, select . The recording is saved in *Gallery* > *Recordings*.
4. To listen to the latest recording, select **Options** > *Play last recorded*.
5. To send the last recording using a multimedia message or IR, select **Options** > *Send last recorded*.

List of recordings

Select *Menu* > *Media* > *Recorder* > **Options** > *Recordings list*. The list of folders in the *Gallery* is shown. Open *Recordings* to see the list with recordings. Select **Options** to select options for files in the *Gallery*. See *Gallery* p. 58.

■ Sound meter

The sound meter enables you to measure the approximate noise level of the environment.

It provides general measurements for personal use that may vary from scientific measurements.

You cannot measure the noise level during a call or while a headset is connected to the phone.

To start sound monitoring, select **Menu** > *Media* > *Sound meter*.

The sound meter bar graphically shows the noise level, and the peak level is indicated. The upper number indicates the peak level and the lower framed number the current level of the sound.

To open the list of options, select **Options**.

13. Push to talk



Push to talk (PTT) over cellular is a two-way radio service available over a GSM/GPRS cellular network (network service). PTT provides direct voice communication. To connect to, press the PTT key.

You can use PTT to have a conversation with one person or with a group of people having compatible devices. When your call is connected, the person or group you are calling does not have to answer the phone. The participants should confirm the reception of any communications where appropriate, as there is no other confirmation whether the recipients have heard the call.

To check availability and costs, and to subscribe to the service, contact your network operator or service provider. Roaming services may be more limited than for normal calls.

Before you can use the PTT service, you must define the required PTT service settings. See PTT settings p. 69.

While you are connected to the PTT service, you can use the other functions of the phone. The PTT over cellular service is not connected to traditional voice communication, and therefore many of the services available for traditional voice calls (for example, voice mailbox) are not available for PTT over cellular communications.



■ Push to talk menu

Select **Menu** > *Push to talk*.

- To connect to or disconnect from the PTT service, select *Switch PTT on* or *Switch PTT off*.
- To view received callback requests, select *Callback inbox*.
- To view the list of PTT groups, select *Group list*.
- To view the list of contacts to which you have added the PTT address received from the service provider, select *Contacts list*.
- To add a new PTT group to the phone, select *Add group*.

- To set the PTT settings for use, select [PTT settings](#).
- To set the required settings for the PTT connection, select [Config. settings](#).
- To open the browser and to connect to the PTT network portal provided by the service provider, select [Web](#).

■ Connect to and disconnect PTT

To connect to the PTT service, select [Menu](#) > [Push to talk](#) > [Switch PTT on](#).  indicates the PTT connection.  indicates that the service is temporarily unavailable. The phone automatically tries to reconnect to the service until you disconnect from the PTT service. If you have added groups to the phone, you are automatically joined to the active ([Default](#) or [Listened](#)) groups, and the name of the default group is displayed in the standby mode.

To disconnect from the PTT service, select [Switch PTT off](#).

■ Make and receive a PTT call

Set the phone to use the loudspeaker or earpiece for PTT communication.







Warning: Do not hold the device near your ear when the loudspeaker is in use, because the volume may be extremely loud.

When connected to the PTT service, you can make or receive dial out calls, group calls or one-to-one calls. One-to-one calls are calls you make to only one person.

Make a dial out PTT call

For a dial-out PTT call you can select multiple PTT contacts from the contact list. The recipients get an incoming call and need to accept the call in order to participate. A dial out call creates a temporary group and the participants join this group only for the duration of the call. After the call the temporary dial out group is deleted.

Select [Menu](#) > [Push to talk](#) > [Contacts list](#) and mark the desired contacts for the dial-out call.

The icon behind the contact in the list denotes current login status: , , or  indicate that the person is either available, unavailable, or unknown,  indicates that the login status is not available. The login status is only available for subscribed contacts. To change the subscribed contacts, select **Options** and from the available contact list options *Subscribe contact* or *Unsubscr. contact*, or if one or more contacts are already marked *Subscribe marked* or *Unsubscribe marked*.

Press the PTT key briefly to start the dial-out call. The marked contacts are called by the PTT service, and the joining contacts are shown on the display. Press and hold the PTT key to talk to the joined contacts. Release the PTT key to hear the response.

Press the end-key to terminate the dial-out call.

Make a group call

To make a call to the default group, press the PTT key. A tone sounds, indicating that the access is granted, and the phone displays your nickname and group name.

To make a call to a non-default group, select *Group list* in the PTT menu, scroll to the desired group, and press the PTT key.

Press and hold the PTT key the entire time you are talking, and hold the phone in front of you so that you can see the display. When you have finished, release the PTT key. Talking is allowed on a first-come, first-served basis. When someone stops talking, the first person to press the PTT key can talk next.

Make a one-to-one call

- To start a one-to-one call from the list of contacts to which you have added the PTT address, select *Contacts list*. Scroll to a contact, and press the PTT key.

You can also select the contact from *Contacts*.

- To start a one-to-one call from the list of PPTT groups, select *Group list*, and scroll to the desired group. Select **Options** > *Active members*, scroll to the desired contact, and press the PTT key.

- To start a one-to-one call from the list of callback requests you have received, select *Callback inbox*. Scroll to the desired nickname, and press the PTT key.

Receive a PTT call

A short tone notifies you of an incoming group and one-to-one call. When receiving a group call, the group name and the nickname of the caller are displayed. When receiving a one-to-one call from a person whose information you have saved in *Contacts*, the saved name is displayed if identified; otherwise, only the nickname of the caller is displayed.

You can either accept or reject an incoming one-to-one call if you have set the phone to first notify you of the one-to-one calls.

If you press the PTT key to try to respond to a group while another member is talking, you hear a queuing tone, and *Queuing* is displayed as long as you press the PTT key. Press and hold the PTT key, and wait for the other person to finish; then you can talk.

■ **Callback requests**

If you make a one-to-one call and do not get a response, you can send a request for the person to call you back.

When someone sends you a callback request, *Callback request received* is displayed in the standby mode. When you receive a callback request from someone who is not in your contacts list, you can save the name to your *Contacts*.

Send a callback request

You can send a callback request in the following ways:

- To send a callback request from the contacts list in the *Push to talk* menu, select *Contacts list*. Scroll to a contact, and select *Options > Send callback*.

- To send a callback request from *Contacts*, search for the desired contact, select **Options** > *Contact details*, scroll to the PTT address, and select **Options** > *Send callback*.
- To send a callback request from the group list in the PTT menu, select *Group list*, and scroll to the desired group. Select **Options** > *Active members*, scroll to the desired contact, and select **Options** > *Send callback*.
- To send a callback request from the callback request list in the *Push to talk* menu, select *Callback inbox*. Scroll to a contact, and select **Options** > *Send callback*.

Respond to a callback request

1. To open the *Callback inbox*, select **View**. The list of nicknames of the persons who have sent you callback requests is shown.
2. To make a one-to-one call, press the PTT key.
3. To send a call request back to the sender, select **Options** > *Send callback*.
To delete the request, select **Delete**.

Save the callback request sender

1. To open the *Callback inbox*, select **View**. The list of nicknames of the persons who have sent you callback requests is shown.
2. To view the sender's PTT address, select **Options** > *View PTT address*.
To save a new contact or to add the PTT address to a contact, select **Options** > *Save as* or *Add to contact*.

■ Add a one-to-one contact

You can save the names of persons to whom you often make one-to-one calls in the following ways:

- To add a PTT address to a name in *Contacts*, search for the desired contact, and select **Options** > *Add detail* > *PTT address*.

- To add a contact to the PTT contacts list, select **Menu** > *Push to talk* > *Contacts list* > **Options** > *Add contact*.
- To add a contact from the group list, connect to the Push to talk service, select *Group list*, and scroll to the desired group. Select **Options** > *Active members*. Scroll to the member whose contact information you want to save, and select **Options**. To add a new contact, select *Save as*. To add a PTT address to a name in *Contacts*, select *Add to contact*.

■ Create and set up groups

When you call a group, all members joined to the group hear the call simultaneously.

Each member in the group is identified by a nickname, which is shown as a caller identification. Group members can choose a nickname for themselves in each group.

Groups are registered with a URL address. One user registers the group URL in the network by joining the group session the first time.

There are three types of PTT groups:

- Provisioned groups are closed groups that allow only selected participants provisioned by the service provider to join.
- Ad hoc groups are groups that the users can create. You can create your own group, and invite members to the group.
- Ad hoc pro groups are groups you can create from members in a provisioned group. For example, a business can have a closed group and separate groups created for certain business functions.

Add a group

Select **Menu** > *Push to talk* > *Add group*. Select from the following options:

- *Guided* — to add a new group. To set the security level for the group, select *Public group* or *Private group*. If you select *Private group*, the phone automatically creates a scrambled part to the group address that the members cannot view when they receive the invitation to

the group. Only the person who creates the private group can invite more members to the group. Enter the name for the group. Select *Default*, *Listened*, or *Inactive*. The phone indicates that the group is saved and its status. *Default* and *Listened* are active groups. When you press the PTT key to make a group call, the default group is called if you have not scrolled to any other group or contact. To send an invitation to the group, select **Yes** when the phone requests it. You can send the invitation using a text message or IR.

The members you invite to the public groups can also invite more members to the group.

- **Manual** – to join an existing group. Enter the group address. Select *Default*, *Listened*, or *Inactive*. The phone indicates that the group is saved and its status. *Default* and *Listened* are active groups. When you press the PTT key to make a group call, the default group is called if you have not scrolled to any other group or contact.

Receive an invitation

1. When you receive a text message invitation to a group, *Group invitation received*: is displayed.
2. To view the nickname of the person who sent the invitation and the group address if the group is not a private group, select **View**.
3. To add the group to your phone, select **Save**. To set the status for the group, select *Default*, *Listened*, or *Inactive*.

To reject the invitation, select **Exit** > **Yes**, or select **View** > **Discard** > **Yes**.

■ PTT settings

There are two kinds of PTT settings: settings for connecting to the service and settings for use.

You may receive the settings for connecting to the service from your network operator or service provider. See Configuration settings service p. 10. You can enter the settings manually. See Configuration p. 56.

To select the settings for connecting to the service, select **Menu** > *Push to talk* > *Config. settings*. Select from the following options:

Configuration — to select a service provider, *Default*, or *Personal config.* for PTT service. Only the configurations that support the PTT service are shown.

Account — to select a PTT service account contained in the active configuration settings

PTT user name, *Default nickname*, *PTT password*, *Domain*, and *Server address*

To edit the PTT settings for use, select **Menu** > *Push to talk* > *PTT settings*.

To select the phone to allow the reception of incoming one-to-one calls, select *1 to 1 calls* > *On*. To make but not receive one-to-one calls, select *Off*. The service provider may offer some services that override these settings. To set the phone to first notify you of incoming one-to-one calls with a ringing tone, select *Notify*.

To activate the listened groups, select *Listened groups* > *On*.

To set the phone to automatically connect to the PTT service when you switch the phone on, select *PTT status in startup* > *Yes*.

To hide your PTT address from group and one-to-one calls, select *Send my PTT address* > *No*.

14. Sports



■ Compass

The phone has a digital compass that shows direction both graphically and in digits.

The compass should always be properly calibrated. Electromagnetic fields, large metal objects, and other external circumstances may reduce the accuracy of the compass. Never rely solely on the phone compass.

Proper calibration of the compass requires that you calibrate the compass against magnetic north and set the declination value according to your location. The declination is the difference between

magnetic north and true north. The compass adjusts for each direction with the set value.

You can find declination values in special maps or lists of locations. The declination value is dependent on both location and time, therefore, you should periodically check the correct value from up-to-date sources and always set the declination according to your location when using the compass. For more information on declination, see <www.nokia.com/support>.

While using the compass, hold the phone horizontally by using the bubble level in the top left corner of the phone. The compass deactivates and goes into the standby mode after a certain time to save power; select **Continue** to activate the compass again. To prevent the compass from going into the standby mode, press a number key every few minutes.

You can use the flashlight when the compass is active.

Calibrate the compass

1. Select **Menu** > *Sports* > *Compass*.
2. If the phone asks you to calibrate the compass, *Compass must be calibrated first* appears. Otherwise, select **Options** > *Calibration*.
3. To start the calibration, select **Yes**. Place the phone on a horizontal, level surface, and carefully rotate it; or, while holding it horizontally, slowly turn it around. Use the rotating graphic on the display to observe the speed of rotation. When the calibration is finished, *Compass calibrated* appears.

Set the declination

1. Select **Menu** > *Sports* > *Compass*.
2. To set the declination, select **Options** > *Settings* > *Variation* > *Set variation*.

To activate the last set declination value, select *On*.

3. Enter the declination value in degrees from 0 to 180, and select **OK**.
4. Select the direction of the declination: *East* (+) or *West* (-).

Set and reset the direction

1. Select **Menu** > *Sports* > *Compass*.
2. To set the compass direction, follow the commands on the display. To reset the direction of the intended destination, select **Reset** > **Yes**. Point the phone in the direction of the intended destination and select **Set direc.**

The arrow points in the direction you have set, and the numeric value is shown at the top right of the display. When the arrow points up on the display, the phone is pointed in the correct direction.

■ Stopwatch

To measure time, take intermediate times, or take lap times, use the stopwatch. During timing, the other functions of the phone can be used. To set the stopwatch timing in the background, press the end key.

Using the stopwatch or allowing it to run in the background when using other features increases the demand on battery power and reduces the battery life.

Select **Menu** > *Sports* > *Stopwatch* and from the following options:

Split timing – to take intermediate times. To start time observation, select **Start**. Select **Split** every time that you want to take an intermediate time. To stop time observation, select **Stop**. To save the measured time, select **Save**. To start time observation again, select **Options** > **Start**. The new time is added to the previous time. To reset the time without saving it, select **Reset**. To set the stopwatch timing in the background, press the end key.

Lap timing – to take lap times. To set the stopwatch timing in the background, press the end key.

Continue – to view the timing that you have set in the background

Show last – to view the most recently measured time if the stopwatch is not reset

View times or *Delete times* – to view or delete saved times

■ Countdown timer

Select **Menu** > *Sports* > *Countdown timer*. Enter the alarm time in hours, minutes and seconds, and select **OK**. If you wish, write your own note that is displayed when the time expires. To start the countdown timer, select *Start*. To change the countdown time, select *Change time*. To stop the timer, select *Stop timer*.

If the alarm time is reached when the phone is in the standby mode, the phone sounds a tone and flashes the note text if it is set or *Countdown time up*. To stop the alarm, press any key. If no key is pressed, the alarm automatically stops within 30 seconds. To stop the alarm and to delete the note text, select **Exit**. To restart the countdown timer, select **Restart**.

■ Audio message

See Nokia Xpress audio messaging p. 30.

■ Thermometer

The thermometer measures temperature in Celsius and Fahrenheit. You can set the phone to display the temperature in the standby mode. The thermometer is useful to plan and monitor your outdoor activities, but is not intended for professional use.

The thermometer provides general measurements for personal use that may vary from scientific measurements.

Select **Menu** > *Sports* > *Thermometer*.

To show (or hide) the temperature value in the standby mode, select *Show thermom.* (or *Hide thermometer*).

To set the phone to show the temperature in either Celsius or Fahrenheit, select *Temp. format*.

15. Organiser



■ Alarm clock

You can set the phone alarm to sound at a desired time. Select **Menu** > **Organiser** > **Alarm clock**.

To set the alarm, select **Alarm time**, and enter the alarm time. To change the alarm time when the alarm time is set, select **On**. To set the phone to alert you on selected days of the week, select **Repeat alarm**.

To select the alarm tone or set a radio channel as the alarm tone, select **Alarm tone**. If you select the radio as an alarm tone, connect the headset to the phone. The phone uses the last channel you listened to as the alarm, and the alarm plays through the loudspeaker. If you remove the headset or switch off the phone, the default alarm tone replaces the radio.

To set a snooze time-out, select **Snooze time-out**.

Stop the alarm

The phone sounds an alert tone, and flashes **Alarm!** and the current time on the display, even if the phone was switched off. To stop the alarm, select **Stop**. If you let the phone continue to sound the alarm for a minute or select **Snooze**, the alarm stops for the selected snooze time-out and then resumes.

If the alarm time is reached while the device is switched off, the device switches itself on and starts sounding the alarm tone. If you select **Stop**, the device asks whether you want to activate the device for calls. Select **No** to switch off the device or **Yes** to make and receive calls. Do not select **Yes** when wireless phone use may cause interference or danger.

■ Calendar

Select **Menu** > **Organiser** > **Calendar**.

The current day is indicated by a frame. If there are any notes set for the day, the day is in bold type. To view the day notes, select **View**. To view a

week, select **Options** > *Week view*. To delete all notes in the calendar, select the month or week view, and select **Options** > *Delete all notes*.

Other options for the day view may be *Make a note*, *Delete*, *Edit*, *Move*, or *Repeat* a note; *Copy* a note to another day; *Send note* as text message or multimedia message, with IR, or to the calendar of another compatible phone. In *Settings* you can set the date and time settings. In *Auto-delete notes* you can set the phone to delete old notes automatically after a specified time.

Make a calendar note

Select **Menu** > *Organiser* > *Calendar*. Scroll to the date you want, and select **Options** > *Make a note* and select one of the following note types:

 *Meeting*,  *Call*,  *Birthday*,  *Memo* or  *Reminder*.

Note alarm

The phone beeps and displays the note. With a call note  on the display, to call the displayed number, press the call key. To stop the alarm and to view the note, select **View**. To stop the alarm for approximately 10 minutes, select **Snooze**. To stop the alarm without viewing the note, select **Exit**.

■ To-do list

To save notes for tasks that you must do, select **Menu** > *Organiser* > *To-do list*.

To create a note if no note is added, select *Add note*; otherwise, select **Options** > *Add note*. Write the note, and select **Save**. Select the priority, the deadline, and the alarm type for the note.

To view a note, scroll to it, and select **View**.

You can also select an option to delete the selected note and delete all the notes that you have marked as done. You can sort the notes by priority or by deadline, send a note to another phone as a text message or a multimedia message, save a note as a calendar note, or access the calendar.

While viewing a note, you can also select an option to edit the deadline or priority for the note or mark the note as done.

■ Notes

To use this application for writing and sending notes, select **Menu** > **Organiser** > **Notes**. To create a note if no note is added, select **Add note**; otherwise, select **Options** > **Make a note**. Write a note, and select **Save**.

Other options for notes include deleting, and editing a note. While editing a note, you can also exit the text editor without saving the changes. You can send the note to compatible devices using a text message, a multimedia message, or IR. If the note is too long to send as a text message, the phone asks you to delete the appropriate number of characters from your note.

■ Calculator

The calculator in your phone adds, subtracts, multiplies, divides, calculates the square and the square root and converts currency values.



Note: This calculator has limited accuracy and is designed for simple calculations.

Select **Menu** > **Organiser** > **Calculator**. When 0 is displayed on the screen, enter the first number in the calculation. Press the # key for a decimal point. Select **Options** > **Add**, **Subtract**, **Multiply**, **Divide**, **Square**, **Square root**, or **Change sign**. Enter the second number. For a total, select **Equals**. Repeat this sequence as many times as it is necessary. To start a new calculation, first select and hold **Clear**.

To perform a currency conversion, select **Menu** > **Organiser** > **Calculator**. To save the exchange rate, select **Options** > **Exchange rate**. Select either of the displayed options. Enter the exchange rate, press the # key for a decimal point, and select **OK**. The exchange rate remains in the memory until you replace it with another one. To perform the currency conversion, enter the amount to be converted, and select **Options** > **In domestic** or **In foreign**.



Note: When you change base currency, you must enter the new rates because all previously set exchange rates are set to zero.

■ Synchronization

Synchronization allows you to save your calendar and [Contacts](#) data on a remote Internet server (network service) or on a compatible PC. If you have saved data on the remote Internet server, to synchronize your phone, start the synchronization from your phone. To synchronize the data in the phone contacts, calendar, and notes to correspond with the data of your compatible PC, start the synchronization from the PC. The contact data in your SIM card is not synchronized.

Answering an incoming call during synchronization ends the synchronization, and you must restart it.

Synchronize from your phone

Before synchronizing from your phone, you must do the following:

- Subscribe to a synchronization service. For details, contact your service provider.
- Retrieve the synchronization settings from your service provider. See [Synchronization settings](#) p. 77.

To start the synchronization from your phone, do the following:

1. Select the configuration settings you need for the synchronization. See [Synchronization settings](#) p. 77.
2. Select [Menu](#) > [Organiser](#) > [Sync](#) > [Server sync](#) > [Data to be synchronised](#). Mark the data to be synchronized.
3. Select [Menu](#) > [Organiser](#) > [Sync](#) > [Server sync](#) > [Synchronise](#). The marked data of the active set is synchronized after confirmation.

Synchronizing for the first time or after an interrupted synchronization may take up to 30 minutes to complete, if the contacts or calendar are full.

Synchronization settings

You may receive the configuration settings required for synchronization as a configuration message from the network operator or service provider. To manage the configuration settings, see [Configuration](#) p. 56.

1. Select **Menu** > *Organiser* > *Sync* > *Server sync* > *Sync settings* and from the following options:

Configuration – Only the configurations that support the synchronization are shown. Select a service provider, *Default*, or *Personal config*. for synchronization.

Account– Select a synchronization service account contained in the active configuration settings.

2. Select *PC sync settings* to enter the settings for server alerted synchronization. Set the *User name* and *Password*.

The user name and password must be the same in the phone and in the PC.

Synchronize from a compatible PC

To synchronize *Contacts*, *Calendar*, and *Notes* from a compatible PC, use an IR, or data cable connection. You also need Nokia PC Suite software of your phone installed on the PC. Start the synchronization from the PC using Nokia PC Suite.

16. Applications



■ Games

Your phone software includes some games.

Launch a game

Select **Menu** > *Applications* > *Games*. Scroll to the desired game, and select **Open**.

For options related to a game, see Other application options p. 80.

Game downloads

Select **Menu** > *Applications* > *Options* > *Downloads* > *Game downloads*. The list of available bookmarks is shown. Select *More*

[bookmarks](#) to access the list of bookmarks in the [Web](#) menu. See [Bookmarks](#) p. 85.



Important: Only install and use applications and other software from sources that offer adequate security and protection against harmful software.

Game settings

To set sounds, lights, and shakes for the game, select [Menu](#) > [Applications](#) > [Options](#) > [App. settings](#).

■ Collection

Your phone software includes some Java applications specially designed for this Nokia phone.

Launch an application

Select [Menu](#) > [Applications](#) > [Collection](#). Scroll to an application, and select [Open](#).

Fitness coach

Fitness coach is an interactive, personal trainer to help you improve your fitness level, strength, and endurance. Programs are created based on your personal data, whether for training indoors or outdoors.

Before beginning a regular exercise program consult your physician or doctor.



Warning: Exercise may include some risk, especially for those who have been sedentary. Before beginning a regular exercise program consult your physician or doctor.

There are numerous factors to consider when determining pace limits and exercise intensity levels. Some of these factors include age, exercise frequency and overall physical fitness.

To begin using Fitness coach, select [Menu](#) > [Applications](#) > [Collection](#) > [Fitness coach](#) > [Open](#).

Read the disclaimer, and select [Disclaimer accepted](#) to accept the terms.

The first time you use Fitness coach, enter your personal details, including your sex, birthday, measurement unit, height, weight, endurance level and strength level. Additional data includes your maximum heart rate and resting heart rate.

Select a program with *Planner* to guide you through planning and setting goals for your fitness program. Or, you can select *Quick start* to immediately begin a program based on your personal profile.

Introduction

The introduction is a presentation of the core features of your phone.

To begin using Introduction, select *Menu* > *Applications* > *Collection* > *Introduction* > *Open*.

To control the sound volume during the presentation, press the left selection key, and then the scroll key right or left. To exit the presentation, press the right selection key or the end key.

Other application options

Delete – to delete the application or application set from the phone

Move – to move an application to a different folder

Details – to view additional information about the application

Update version – to check if a new version of the application is available for download from *Web* (network service)

App. access – to restrict the application from accessing the network. Different categories are shown. Select in each category, if available, one of the following permissions: *Ask every time* to set the phone to always ask for network access, *Ask first time only* to set the phone to ask for network access on the first attempt, *Always allowed* to allow network access, or *Not allowed* to not allow the network access.

Web page – to provide further information or additional data for the application from an Internet page. This feature must be supported by the network. It is only shown if an Internet address has been provided with the application.

Type of view – to display the applications in the folder as a *List with details*, a plain *List*, or a *Grid*

Sort – to sort applications by name, date, format, or size

Delete all – to delete all applications in the folder

Add folder – to add a new folder

Memory status – to view the free and used memory of the phone

Activation key list – to view the list of all available activation keys. You can delete expired activation keys.

Download an application

Your phone supports J2ME™ Java applications. Make sure that the application is compatible with your phone before downloading it.



Important: Only install and use applications and other software from sources that offer adequate security and protection against harmful software.

You can download new Java applications in different ways.

Select **Menu** > *Applications* > **Options** > *Downloads* > *App. downloads*.

The list of available bookmarks is shown. Select *More bookmarks* to access the list of bookmarks in the *Web* menu. Select the appropriate bookmark to connect to the desired page. For the availability of different services, pricing, and tariffs, contact your service provider.

Select **Menu** > *Web* > *Downloads*. Download an appropriate application or game. See Downloads p. 86.

Use the game download function. See Game downloads p. 78.

Use the Nokia Application Installer in PC Suite to download the applications to your phone.

Your device may have some bookmarks loaded for sites not affiliated with Nokia. Nokia does not warrant or endorse these sites. If you choose to access them, you should take the same precautions, for security or content, as you would with any Internet site.

When downloading an application, it may be saved in the *Games* menu instead of the *Applications* menu.

17. Web



You can access various mobile Internet services with your phone browser.



Important: Use only services that you trust and that offer adequate security and protection against harmful software.

Check the availability of these services, pricing, tariffs, and instructions with your service provider.

With the phone browser, you can view the services that use wireless markup language (WML) or extensible hypertext markup language (XHTML) on their pages – appearance may vary due to screen size. You may not be able to view all details of the Internet pages.

■ Set up browsing

You may receive the configuration settings required for browsing as a configuration message from the network operator or service provider that offers the service that you want to use: see Configuration settings service p. 10. You can also enter all the configuration settings manually: see Configuration p. 56.

■ Connect to a service

First, verify that the correct configuration settings of the service that you want to use are activated.

1. To select the settings for connecting to the service, select **Menu** > **Web** > **Settings** > **Configuration settings**.
2. Select **Configuration** – only the configurations that support a browsing service are shown. Select a service provider, **Default**, or **Personal config** for browsing: see Set up browsing p. 82.

Select **Account** and a browsing service account contained in the active configuration settings.



Select **Display terminal window** > **Yes** to perform manual user-authentication for Intranet connections.

Secondly, make a connection to the service in one of the following ways:

- Select **Menu** > **Web** > **Home** or, in standby mode, press and hold **0**.
- To select a service bookmark, select **Menu** > **Web** > **Bookmarks**.
- To select the last URL accessed, select **Menu** > **Web** > **Last web address**.
- To enter the address of a service, select **Menu** > **Web** > **Go to address**, enter the address and select **OK**.

■ Browse pages

After you make a connection to a service, you can start browsing its pages. Note that phone-key function may vary for different services; follow the text guides on the phone display. For more information, contact your service provider.

If packet data is selected as the data bearer,  is shown on the top left of the display during browsing. If you receive a call or text message, or make a call during a packet-data connection,  is shown on the top right of the display to indicate that the packet-data connection is suspended (on hold). After a call, the phone tries to reconnect the packet-data connection.

Browse with phone keys

Scroll in any direction to browse through the page.

To select a highlighted item, press the call key, or select **Select**.

To enter letters and numbers, press keys **0** to **9**. To enter special characters, press *****.

Options while browsing

Nokia.com, *Home*, *Shortcuts*, *Add bookmark*, *Bookmarks*, *Page options*, *History*, *Downloads*, *Other options*, *Reload*, and *Quit* may be available. The service provider may also offer other options.

A cache is a memory location that is used to store data temporarily. If you have tried to access or have accessed confidential information requiring passwords,

empty the cache after each use. The information or services you have accessed is stored in the cache.

To empty the cache, see *Cache memory* p. 87.

Direct calling

The browser supports functions that you can access while browsing. You can make a phone call, send DTMF tones while a voice call is in progress, and save a name and a phone number from a page.

■ **Appearance settings**

While browsing, select **Options** > *Other options* > *Appear. settings*; or in standby mode, select **Menu** > *Web* > *Settings* > *Appearance settings* and from the following options:

Text wrapping > *On* – to set the text to continue on the next line on the display. If you select *Off*, the text is abbreviated.

Font size > *Extra small*, *Small*, or *Medium* – to set the font size

Show images > *No* – to hide pictures on the page. This can speed up the browsing of pages that contain a lot of pictures.

Alerts > *Alert for unsecure connection* > *Yes* – to set the phone to alert when a encrypted connection changes to an unencrypted one during browsing

Alerts > *Alert for unsecure items* > *Yes* – to set the phone to alert when a encrypted page contains an unsecure item – these alerts do not guarantee a secure connection. For more information, see *Browser security* p. 87.

Character encoding > *Content encoding* – to select the encoding for the browser page content

Character encoding > *Unicode (UTF-8) web addresses* > *On* – to set the phone to send a URL as UTF-8 encoding. You may need this setting when you access a Web page created in a foreign language.

Screen size > *Full* or *Small* – to set the screen size

■ Cookies

A cookie is data that a site saves in the cache memory of your phone. Cookies are saved until you clear the cache memory: see *Cache memory* p. 87.

While browsing, select [Options](#) > [Other options](#) > [Security](#) > [Cookie settings](#) or, in standby mode, select [Menu](#) > [Web](#) > [Settings](#) > [Security settings](#) > [Cookies](#). To allow or prevent the phone from receiving cookies, select [Allow](#) or [Reject](#).

■ Scripts over secure connections

You can select whether to allow the running of scripts from a secure page. The phone supports WML scripts.

1. While browsing, select [Options](#) > [Other options](#) > [Security settings](#) > [Script settings](#) or, in standby mode, select [Menu](#) > [Web](#) > [Settings](#) > [Security settings](#) > [Scripts over secure connection](#).
2. To allow the scripts, select [Allow](#).

■ Bookmarks

You can save page addresses as bookmarks in the phone memory.

1. While browsing, select [Options](#) > [Bookmarks](#) or, in standby mode, select [Menu](#) > [Web](#) > [Bookmarks](#).
2. Scroll to a bookmark and select it, or press the call key to make a connection to the page associated with the bookmark.
3. Select [Options](#) to view, edit, delete or send a bookmark; create a new bookmark; or save the bookmark to a folder.

Your device may have some bookmarks loaded for sites not affiliated with Nokia. Nokia does not warrant or endorse these sites. If you choose to access them, you should take the same precautions for security or content as you would with any Internet site.

Receive a bookmark

When you have received a bookmark that is sent as a bookmark, [1 bookmark received](#) is displayed. To save the bookmark, select [Show](#) >

Save. To view or delete the bookmark, select **Options** > *View* or *Delete*. To discard the bookmark as soon as you have received it, select **Exit** > **OK**.

■ Downloads

To download more tones, images, games or applications to your phone (network service), select **Menu** > *Web* > *Downloads* > *Tone downloads*, *Graphic downloads*, *Game downloads*, *Video downloads*, *Theme downloads*, or *App. downloads*.



Important: Only install and use applications and other software from sources that offer adequate security and protection against harmful software.

■ Service inbox

The phone is able to receive service messages (pushed messages) sent by your service provider (network service). Service messages are notifications of, for example, news headlines and may contain a text message or the address of a service.

To access the *Service inbox* in standby mode when you have received a service message, select **Show**. If you select **Exit**, the message is moved to the *Service inbox*. To access the *Service inbox* later, select **Menu** > *Web* > *Service inbox*.

To access the *Service inbox* while browsing, select **Options** > *Other options* > *Service inbox*. Scroll to the message you want, and select **Retrieve** to activate the browser and download the marked content. To display detailed information on the service notification, or to delete the message, select **Options** > *Details* or *Delete*.

Service inbox settings

Select **Menu** > *Web* > *Settings* > *Service inbox settings*.

To set whether you want to receive service messages or not, select *Service messages* > *On* or *Off*.

To set the phone to receive service messages only from content authors approved by the service provider, select *Message filter* > *On*.

To set the phone to automatically activate the browser from the standby mode when the phone has received a service message, select *Automatic connection* > *On* (not available for all message types). If you select *Off*, the phone activates the browser only after you select *Retrieve* when the phone has received a service message.

■ Cache memory

A cache is a memory location that is used to store data temporarily. If you have tried to access or have accessed confidential information requiring passwords, empty the cache after each use. The information or services you have accessed is stored in the cache.

To empty the cache while browsing, select *Options* > *Other options* > *Clear the cache*; from standby mode, select *Menu* > *Web* > *Clear the cache*.

■ Browser security

Security features may be required for some services, such as online banking or shopping. For such connections, you need security certificates and possibly a security module, which may be available on your SIM card. For more information, contact your service provider.

Security module

The security module improves security services for applications requiring a browser connection, and allows you to use a digital signature. The security module may contain certificates as well as private and public keys. The certificates are saved in the security module by the service provider.

Select *Menu* > *Web* > *Settings* > *Security settings* > *Security module settings* and from the following options:

Security module details – to show the security-module title, status, manufacturer, and serial number.

Module PIN request – to set the phone to ask for the module PIN when using services provided by the security module. Enter the code and select *On*. To disable the module PIN request, select *Off*.

Change module PIN – to change the module PIN, if allowed by the security module. Enter the current module PIN code, then enter the new code twice.

Change signing PIN – to change the signing PIN code for the digital signature. Select the signing PIN you want to change. Enter the current PIN code, then enter the new code twice.

See also Access codes p. 9.

Certificates



Important: Note that even if the use of certificates makes the risks involved in remote connections and software installation considerably smaller, they must be used correctly in order to benefit from increased security. The existence of a certificate does not offer any protection by itself; the certificate manager must contain correct, authentic or trusted certificates for increased security to be available. Certificates have a restricted lifetime. If Expired certificate or Certificate not valid yet is shown even if the certificate should be valid, check that the current date and time in your device are correct.

Before changing any certificate settings, you must make sure that you really trust the owner of the certificate and that the certificate really belongs to the listed owner.

There are three kinds of certificates: server certificates, authority certificates and user certificates; you may receive any of these certificates from your service provider. Authority certificates and user certificates may also be saved in the security module by the service provider.

To view the list of the authority or user certificates downloaded to your phone, select [Menu](#) > [Web](#) > [Settings](#) > [Security settings](#) > [Authority certificates](#) or [User certificates](#).

The security indicator  is displayed during a connection, if the data transmission between the phone and the content server is encrypted.

The security icon does not indicate that the data transmission between the gateway and the content server (or place where the requested resource is stored) is secure. The service provider secures the data transmission between the gateway and the content server.

Digital signature

You can make digital signatures with your phone if your SIM card has a security module. Using the digital signature can be the same as signing your name to a paper bill, contract, or other document.

To make a digital signature, select a link on a page, for example, the title of a book you want to buy and its price. The text to sign, which may include the price and date, is shown.

Check that the header text is *Read* and that the digital signature icon  is shown.

If the digital signature icon does not appear, there is a security breach and you should not enter any personal data such as your signing PIN.

To sign the text, read it all first and select *Sign*.

The text may not fit within a single screen. Therefore, make sure you scroll through and read all of the text before signing.

Select the user certificate you want to use. Enter the signing PIN (see Access codes p. 9), and select *OK*. The digital signature icon disappears, and the service may display a confirmation of your purchase.

18. SIM services



Your SIM card may provide additional services that you can access. This menu is shown only if it is supported by your SIM card. The name and contents of the menu depend on the SIM card.

For availability, rates and information on using SIM services, contact your SIM-card vendor, for example, network operator, service provider or other vendor.

To set the phone to show you the confirmation messages sent between your phone and the network when you are using the SIM services, select *Menu* > *Settings* > *Phone* > *Confirm SIM service actions* > *Yes*.

Note that accessing these services may involve sending messages or making a phone call for which you may be charged.

19. PC connectivity

You can send and receive e-mail and access the Internet when your phone is connected to a compatible PC through an infrared or a data cable (CA-42) connection. You can use your phone with a variety of PC connectivity and data-communications applications.

■ PC Suite

With PC Suite, you can synchronize contacts, calendar and to-do notes, and notes between your phone and the compatible PC, or a remote Internet server (network service).

You may find more information about PC suite, for example, downloadable files in the support area on the Nokia Web site at <www.nokia.com/support>.

■ Packet data, HSCSD, and CSD

With your phone you can use the packet data, high-speed circuit switched data (HSCSD), and circuit switched data (CSD, *GSM data*).

For availability and subscription to data services, contact your network operator or service provider.

The use of HSCSD services consumes the phone battery faster than normal voice or data calls. You may need to connect the phone to a charger for the duration of data transfer.

See Packet data (EGPRS) p. 53.

■ Data-communication applications

For information on using a data-communication application, refer to the documentation provided with it. Making or answering phone calls during a computer connection is not recommended as it might disrupt operations. For better performance during data calls, place the phone on a stationary surface with the keypad facing down. Do not move the phone by holding it in your hand during a data call.

20. Battery information

■ Charging and discharging

Your device is powered by a rechargeable battery. The full performance of a new battery is achieved only after two or three complete charge and discharge cycles. The battery can be charged and discharged hundreds of times, but it will eventually wear out. When the talk and standby times are noticeably shorter than normal, replace the battery. Use only Nokia approved batteries, and recharge your battery only with Nokia approved chargers designated for this device.

If a replacement battery is being used for the first time or if the battery has not been used for a prolonged period, it may be necessary to connect the charger and then disconnect and reconnect it to start the charging.

Unplug the charger from the electrical plug and the device when not in use. Do not leave fully charged battery connected to a charger, since overcharging may shorten its lifetime. If left unused, a fully charged battery will lose its charge over time.

Use the battery for its intended purpose only. Never use any charger or battery that is damaged.

Do not short-circuit the battery. Accidental short-circuiting can occur when a metallic object such as a coin, clip, or pen causes direct connection of the positive (+) and negative (-) terminals of the battery. (These look like metal strips on the battery.) This might happen, for example, when you carry a spare battery in your pocket or purse. Short-circuiting the terminals may damage the battery or the connecting object.

Leaving the battery in hot or cold places, such as in a closed car in summer or winter conditions, will reduce the capacity and lifetime of the battery. Always try to keep the battery between 15°C and 25°C (59°F and 77°F). A device with a hot or cold battery may not work temporarily, even when the battery is fully charged. Battery performance is particularly limited in temperatures well below freezing.

Do not dispose of batteries in a fire as they may explode. Batteries may also explode if damaged. Dispose of batteries according to local regulations. Please recycle when possible. Do not dispose as household waste.

■ Nokia battery authentication guidelines

Always use original Nokia batteries for your safety. To check that you are getting an original Nokia battery, purchase it from an authorized Nokia dealer, look for the Nokia Original Enhancements logo on the packaging, and inspect the hologram label using the following steps:

Successful completion of the four steps is not a total assurance of the authenticity of the battery. If you have any reason to believe that your battery is not an authentic original Nokia battery, you should refrain from using it and take it to the nearest authorized Nokia service point or dealer for assistance. Your authorized Nokia service point or dealer will inspect the battery for authenticity. If authenticity cannot be verified, return the battery to the place of purchase.

Authenticate hologram



1. When looking at the hologram on the label, you should see the Nokia connecting hands symbol from one angle and the Nokia Original Enhancements logo when looking from another angle.



2. When you angle the hologram left, right, down, and up, you should see 1, 2, 3, and 4 dots on each side respectively.

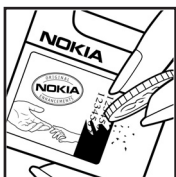

3. Scratch the side of the label to reveal a 20-digit code, for example, 12345678919876543210. Turn the battery so that the numbers are facing upwards. The 20-digit code reads starting from the number at the top row followed by the bottom row.



4. Confirm that the 20-digit code is valid by following the instructions at www.nokia.com/batterycheck.

To create a text message, enter the 20-digit code, for example, 12345678919876543210, and send it to +44 7786 200276.

National and international operator charges will apply.

You should receive a message indicating whether the code can be authenticated.

What if your battery is not authentic?

If you cannot confirm that your Nokia battery with the hologram on the label is an authentic Nokia battery, please do not use the battery. Take it to the nearest, authorized Nokia service point or dealer for assistance. The use of a battery that is not approved by the manufacturer may be dangerous and can result in poor performance and damage to your device and its enhancements. It may also invalidate any approval or warranty applying to the device.

To find out more about original Nokia batteries, visit www.nokia.com/battery.

CARE AND MAINTENANCE

Your device is a product of superior design and craftsmanship and should be treated with care. The suggestions below will help you protect your warranty coverage.

- Keep the device dry. Precipitation, humidity and all types of liquids or moisture can contain minerals that will corrode electronic circuits. If your device does get wet, remove the battery and allow the device to dry completely before replacing it.
- Do not use or store the device in dusty, dirty areas. Its moving parts and electronic components can be damaged.
- Do not store the device in hot areas. High temperatures can shorten the life of electronic devices, damage batteries, and warp or melt certain plastics.
- Do not store the device in cold areas. When the device returns to its normal temperature, moisture can form inside the device and damage electronic circuit boards.
- Do not attempt to open the device other than as instructed in this guide.
- Do not drop, knock, or shake the device. Rough handling can break internal circuit boards and fine mechanics.
- Do not use harsh chemicals, cleaning solvents, or strong detergents to clean the device.
- Do not paint the device; paint can clog the moving parts and prevent proper operation.
- Use a soft, clean, dry cloth to clean any lenses (such as camera, proximity sensor, and light sensor lenses).
- Use only the supplied or an approved replacement antenna. Unauthorised antennas, modifications, or attachments could damage the device and may violate regulations governing radio devices.
- Use chargers indoors.
- Always create a backup of data you want to keep (such as contacts and calendar notes) before sending your device to a service facility.

All of the above suggestions apply equally to your device, battery, charger or any enhancement. If any device is not working properly, take it to the nearest, authorized service facility for service.

Additional safety information

Your device and its enhancements may contain small parts. Keep them out of the reach of small children.

■ Operating environment

Remember to follow any special regulations in force in any area and always switch off your device when its use is prohibited or when it may cause interference or danger. Use the device only in its normal operating positions. This device meets RF exposure guidelines when used either in the normal use position against the ear or when positioned at least 1.5 cm away from the body. When a carry case, belt clip or holder is used for body-worn operation, it should not contain metal and should position the device the above-stated distance from your body.

In order to transmit data files or messages, this device requires a good quality connection to the network. In some cases, transmission of data files or messages may be delayed until such a connection is available. Ensure the above separation distance instructions are followed until the transmission is completed.

Parts of the device are magnetic. Metallic materials may be attracted to the device, and persons with a hearing aid should not hold the device to the ear with the hearing aid. Do not place credit cards or other magnetic storage media near the device, because information stored on them may be erased.

■ Medical devices

Operation of any radio transmitting equipment, including wireless phones, may interfere with the functionality of inadequately protected medical devices. Consult a physician or the manufacturer of the medical device to determine if they are adequately shielded from external RF energy or if you have any questions. Switch off your device in health care facilities when any regulations posted in these areas instruct you to do so. Hospitals or health care facilities may be using equipment that could be sensitive to external RF energy.

Pacemakers

Pacemaker manufacturers recommend that a minimum separation of 15.3 cm (6 inches) be maintained between a wireless phone and a pacemaker to avoid potential interference with the pacemaker. These recommendations are consistent with the independent research by and recommendations of Wireless Technology Research. Persons with pacemakers should:

- always keep the device more than 15.3 cm (6 inches) from the pacemaker;
- not carry the device in a breast pocket; and
- hold the device to the ear opposite the pacemaker to minimize the potential for interference.

If you suspect interference, switch off your device and move the device away.

Hearing aids

Some digital, wireless devices may interfere with some hearing aids. If interference occurs, consult your service provider.

■ Vehicles

RF signals may affect improperly installed or inadequately shielded electronic systems in motor vehicles such as electronic, fuel-injection systems, electronic, antiskid (antilock) braking systems, electronic speed-control systems, air-bag systems. For more information, check with the manufacturer or its representative of your vehicle or any equipment that has been added.

Only qualified personnel should service the device or install the device in a vehicle. Faulty installation or service can be dangerous and may invalidate any warranty that may apply to the device. Check regularly that all wireless-device equipment in your vehicle is mounted and operating properly. Do not store or carry flammable liquids, gases or explosive materials in the same compartment as the device, its parts or enhancements. For vehicles equipped with an air bag, remember that air bags inflate with great force. Do not place objects, including installed or portable wireless equipment, in the area over the air bag or in the air bag deployment area. If in-vehicle wireless equipment is improperly installed and the air bag inflates, serious injury could result.

Using your device while flying in aircraft is prohibited. Switch off your device before boarding an aircraft. The use of wireless teledevices in an aircraft may be dangerous to the operation of the aircraft, disrupt the wireless telephone network, and may be illegal.

■ Potentially explosive environments

Switch off your device when in any area with a potentially explosive atmosphere and obey all signs and instructions. Potentially explosive atmospheres include areas where you would normally be advised to turn off your vehicle engine. Sparks in such areas could cause an explosion or fire resulting in bodily injury or even death. Switch off the device at refuelling points such as near gas pumps at service stations. Observe restrictions on the use of radio equipment in fuel depots, storage, and distribution areas, chemical plants or where blasting

operations are in progress. Areas with a potentially explosive atmosphere are often, but not always, clearly marked. They include below deck on boats, chemical transfer or storage facilities, vehicles using liquefied petroleum gas (such as propane or butane), and areas where the air contains chemicals or particles such as grain, dust, or metal powders.

■ Emergency calls



Important: Wireless phones, including this device, operate using radio signals, wireless networks, landline networks, and user-programmed functions. Because of this, connections in all conditions cannot be guaranteed. You should never rely solely on any wireless device for essential communications like medical emergencies.

To make an emergency call:

1. If the device is not on, switch it on. Check for adequate signal strength.
Some networks may require that a valid SIM card is properly inserted in the device.
2. Press the end key as many times as needed to clear the display and ready the device for calls.
3. Enter the official emergency number for your present location. Emergency numbers vary by location.
4. Press the call key.

If certain features are in use, you may first need to turn those features off before you can make an emergency call. Consult this guide or your service provider for more information.

When making an emergency call, give all the necessary information as accurately as possible. Your wireless device may be the only means of communication at the scene of an accident. Do not end the call until given permission to do so.

■ Certification information (SAR)

THIS DEVICE MEETS INTERNATIONAL GUIDELINES FOR EXPOSURE TO RADIO WAVES

Your mobile device is a radio transmitter and receiver. It is designed and manufactured not to exceed the limits for exposure to radio frequency (RF) recommended by international guidelines (ICNIRP). These limits are part of comprehensive guidelines and establish permitted levels of RF energy for the general population. The guidelines were developed by independent scientific organizations through periodic and thorough evaluation of scientific studies.

The guidelines include a substantial safety margin designed to assure the safety of all persons, regardless of age and health.

The exposure standard for mobile devices employs a unit of measurement known as the Specific Absorption Rate, or SAR. The SAR limit stated in the international guidelines is 2.0 watts/kilogram (W/kg)*. Tests for SAR are conducted using standard operating positions with the device transmitting at its highest certified power level in all tested frequency bands. Although the SAR is determined at the highest certified power level, the actual SAR of the device while operating can be well below the maximum value. This is because the device is designed to operate at multiple power levels so as to use only the power required to reach the network. In general, the closer you are to a base station, the lower the power output of the device.

The highest SAR value for this device when tested for use at the ear is 0.77 W/kg. SAR values may vary depending on national reporting and testing requirements and the network band. Use of device accessories and enhancements may result in different SAR values. Additional SAR information may be provided under product information at www.nokia.com.

* The SAR limit for mobile devices used by the public is 2.0 W/kg averaged over ten grams of body tissue. The guidelines incorporate a substantial margin of safety to give additional protection for the public and to account for any variations in measurements. SAR values may vary depending on national reporting requirements and the network band. For SAR information in other regions please look under product information at www.nokia.com.