

# **Nokia E5-00 User Guide**

Issue 1.1

### Contents

#### Safety 6

|                                 |   |
|---------------------------------|---|
| About your device               | 6 |
| Network services                | 7 |
| About Digital Rights Management | 8 |
| Battery removing                | 9 |

#### Get started 10

|                                 |    |
|---------------------------------|----|
| Keys and parts                  | 10 |
| Insert the SIM card and battery | 11 |
| Insert the memory card          | 12 |
| Remove the memory card          | 13 |
| Wrist strap                     | 13 |
| Charge the battery              | 13 |
| Lock or unlock the keyboard     | 14 |
| Connect a compatible headset    | 14 |
| Switch the device on and off    | 15 |
| Antenna locations               | 15 |
| Nokia Switch                    | 16 |
| Nokia Ovi Suite                 | 18 |
| Visit Ovi by Nokia              | 19 |
| About Ovi Store                 | 20 |

#### Access codes 20

#### Basic use 21

|                |    |
|----------------|----|
| Home screen    | 21 |
| One-touch keys | 22 |

|              |    |
|--------------|----|
| Write text   | 23 |
| Contacts     | 25 |
| Calendar     | 27 |
| Multitasking | 29 |
| Flashlight   | 30 |
| Ovi Files    | 30 |

#### Make calls 30

|                                |    |
|--------------------------------|----|
| Voice calls                    | 30 |
| During a call                  | 31 |
| Voice mail                     | 32 |
| Answer or decline a call       | 32 |
| Make a conference call         | 33 |
| Speed dial a phone number      | 33 |
| Call waiting                   | 34 |
| Call divert                    | 34 |
| Call barring                   | 35 |
| Voice dialling                 | 36 |
| Make a video call              | 36 |
| During a video call            | 38 |
| Answer or decline a video call | 38 |
| Video sharing                  | 39 |
| Log                            | 42 |

#### Messaging 43

|                   |    |
|-------------------|----|
| Messaging folders | 44 |
| Organise messages | 44 |
| E-mail            | 45 |
| Nokia Messaging   | 49 |
| Ovi Contacts      | 50 |

---

|                                    |           |                                   |            |
|------------------------------------|-----------|-----------------------------------|------------|
| Message reader                     | 56        | Connection security               | 86         |
| Speech                             | 57        | Web settings                      | 87         |
| Text and multimedia messages       | 57        |                                   |            |
| Special message types              | 62        | <b>Nokia Office Tools</b>         | <b>89</b>  |
| Cell broadcast                     | 63        | Active notes                      | 89         |
| Messaging settings                 | 64        | Calculator                        | 90         |
| About Chat                         | 67        | File manager                      | 90         |
|                                    |           | Quickoffice                       | 91         |
| <b>Connectivity</b>                | <b>67</b> | Converter                         | 91         |
| Data connections and access points | 67        | Zip manager                       | 92         |
| Network settings                   | 68        | PDF reader                        | 92         |
| Wireless LAN                       | 68        | Printing                          | 93         |
| Access points                      | 71        | Dictionary                        | 95         |
| Active data connections            | 75        | Notes                             | 95         |
| Sync                               | 76        |                                   |            |
| Bluetooth connectivity             | 76        | <b>Positioning (GPS)</b>          | <b>96</b>  |
| Data cable                         | 81        | About GPS                         | 96         |
| PC connections                     | 81        | Assisted GPS (A-GPS)              | 96         |
| About home network                 | 82        | Hold your device correctly        | 97         |
|                                    |           | Tips on creating a GPS connection | 97         |
| <b>Internet</b>                    | <b>82</b> | Position requests                 | 98         |
| Browse the web                     | 83        | Landmarks                         | 98         |
| Browser toolbar                    | 84        | GPS data                          | 99         |
| Navigate pages                     | 84        | Positioning settings              | 100        |
| Web feeds and blogs                | 85        |                                   |            |
| Content search                     | 85        | <b>Maps</b>                       | <b>101</b> |
| Bookmarks                          | 86        | Maps overview                     | 101        |
| Empty the cache                    | 86        | View your location and the map    | 102        |
| End the connection                 | 86        | Map view                          | 102        |
|                                    |           | Change the look of the map        | 103        |

---

## 4 Contents

---

|                                    |            |                                     |            |
|------------------------------------|------------|-------------------------------------|------------|
| Download and update maps           | 103        | Nokia Podcasting                    | 129        |
| About positioning methods          | 103        | Music player                        | 131        |
| Find a location                    | 104        | RealPlayer                          | 134        |
| View location details              | 105        | Recorder                            | 135        |
| Save places and routes             | 105        | Nokia Internet Radio                | 136        |
| View and organise places or routes | 106        | <b>Security and data management</b> | <b>138</b> |
| Send places to your friends        | 106        | Lock the device                     | 139        |
| Share location                     | 106        | Memory card security                | 139        |
| Synchronise your Favourites        | 107        | Encryption                          | 140        |
| Get voice guidance                 | 108        | Fixed dialling                      | 141        |
| Drive to your destination          | 108        | Certificate manager                 | 142        |
| Navigation view                    | 109        | View and edit security modules      | 143        |
| Get traffic and safety information | 109        | Remote configuration                | 144        |
| Walk to your destination           | 110        | Application manager                 | 146        |
| Plan a route                       | 111        | Licenses                            | 148        |
| <b>Personalisation</b>             | <b>112</b> | Sync                                | 150        |
| Profiles                           | 112        | Mobile VPN                          | 151        |
| Select ringing tones               | 113        | <b>Settings</b>                     | <b>153</b> |
| Customise profiles                 | 113        | General settings                    | 153        |
| Change the display theme           | 114        | Telephone settings                  | 158        |
| Download a theme                   | 115        | Connection settings                 | 159        |
| 3-D ringing tones                  | 115        | Application settings                | 171        |
| <b>Media</b>                       | <b>116</b> | <b>Shortcuts</b>                    | <b>171</b> |
| Camera                             | 116        | General shortcuts                   | 171        |
| Gallery                            | 119        | <b>Glossary</b>                     | <b>173</b> |
| Photos                             | 121        |                                     |            |
| Create a post                      | 129        |                                     |            |

**Troubleshooting 178****Find help 182**

---

Support 182

---

Update device software 182

---

In-device help 183

---

Do more with your device 184

---

Settings 184

---

Prolong battery life 184

---

Free memory 186

**Green tips 186**

---

Save energy 186

---

Recycle 187

**Product and safety information 187****Index 194**

### Safety

Read these simple guidelines. Not following them may be dangerous or illegal. Read the complete user guide for further information.

#### SWITCH ON SAFELY



Do not switch the device on when wireless phone use is prohibited or when it may cause interference or danger.

#### ROAD SAFETY COMES FIRST



Obey all local laws. Always keep your hands free to operate the vehicle while driving. Your first consideration while driving should be road safety.

#### INTERFERENCE



All wireless devices may be susceptible to interference, which could affect performance.

#### SWITCH OFF IN RESTRICTED AREAS



Follow any restrictions. Switch the device off in aircraft, near medical equipment, fuel, chemicals, or blasting areas.

#### QUALIFIED SERVICE



Only qualified personnel may install or repair this product.

#### ACCESSORIES AND BATTERIES



Use only approved accessories and batteries. Do not connect incompatible products.

#### WATER-RESISTANCE



Your device is not water-resistant. Keep it dry.

#### About your device

The wireless device described in this guide is approved for use on the UMTS 900, 1900, and 2100 MHz networks, and GSM 850, 900, 1800, and 1900 MHz networks. Contact your service provider for more information about networks.

Your device supports several connectivity methods and like computers may be exposed to viruses and other harmful content. Exercise caution with messages, connectivity requests, browsing, and downloads. Only install and use services and software from trustworthy sources that offer adequate security and protection, such as applications that are Symbian Signed or have passed the Java Verified™ testing. Consider installing antivirus and other security software on your device and any connected computer.

Your device may have preinstalled bookmarks and links for third-party internet sites and may allow you to access third-party sites. These are not affiliated with Nokia, and Nokia does not endorse or assume liability for them. If you access such sites, take precautions for security or content.

**Warning:**

To use any features in this device, other than the alarm clock, the device must be switched on. Do not switch the device on when wireless device use may cause interference or danger.

When using this device, obey all laws and respect local customs, privacy and legitimate rights of others, including copyrights. Copyright protection may prevent some images, music, and other content from being copied, modified, or transferred.

Make back-up copies or keep a written record of all important information stored in your device.

When connecting to any other device, read its user guide for detailed safety instructions. Do not connect incompatible products.

The images in this guide may differ from your device display.

Refer to the user guide for other important information about your device.

**Network services**

To use the device you must have service from a wireless service provider. Some features are not available on all networks; other features may require that you make specific arrangements with your service provider to use them. Network services involve transmission

of data. Check with your service provider for details about fees in your home network and when roaming on other networks. Your service provider can explain what charges will apply. Some networks may have limitations that affect how you can use some features of this device requiring network support such as support for specific technologies like WAP 2.0 protocols (HTTP and SSL) that run on TCP/IP protocols and language-dependent characters.

Your service provider may have requested that certain features be disabled or not activated in your device. If so, these features will not appear on your device menu. Your device may also have customized items such as menu names, menu order, and icons.

### **About Digital Rights Management**

When using this device, obey all laws and respect local customs, privacy and legitimate rights of others, including copyrights. Copyright protection may prevent you from copying, modifying, or transferring images, music, and other content.

Content owners may use different types of digital rights management (DRM)

technologies to protect their intellectual property, including copyrights. This device uses various types of DRM software to access DRM-protected content. With this device you can access content protected with WMDRM 10 and OMA DRM 2.0. If certain DRM software fails to protect the content, content owners may ask that such DRM software's ability to access new DRM-protected content be revoked. Revocation may also prevent renewal of such DRM-protected content already in your device. Revocation of such DRM software does not affect the use of content protected with other types of DRM or the use of non-DRM-protected content.

Digital rights management (DRM) protected content comes with an associated licence that defines your rights to use the content.

If your device has OMA DRM-protected content, to back up both the licence and the content, use the backup feature of Nokia Ovi Suite.

Other transfer methods may not transfer the licences which need to be restored with the content for you to be



able to continue the use of OMA DRM-protected content after the device memory is formatted. You may also need to restore the licence in case the files on your device get corrupted.

If your device has WMDRM-protected content, both the licence and the content will be lost if the device memory is formatted. You may also lose the licence and the content if the files on your device get corrupted. Losing the licence or the content may limit your ability to use the same content on your device again. For more information, contact your service provider.

Some licences may be connected to a specific SIM card, and the protected content can be accessed only if the SIM card is inserted in the device.

During extended operation such as an active video call and high speed data connection, the device may feel warm. In most cases, this condition is normal. If you suspect the device is not working properly, take it to the nearest authorised service facility.

### **Battery removing**

Switch the device off and disconnect the charger before removing the battery.

### Get started

Learn how to start using your device.

### Keys and parts

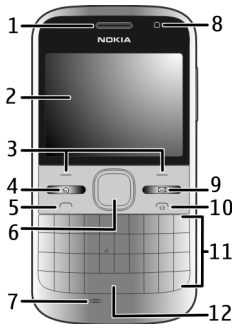

- 1 Ear piece
- 2 Display
- 3 Left and right selection keys
- 4 Home key
- 5 Call key
- 6 Navi™ key (scroll key). Also used to zoom and capture images when using the camera.
- 7 Microphone
- 8 Light sensor
- 9 Messaging key

- 10 End/Power key
- 11 Keyboard
- 12 Flashlight key

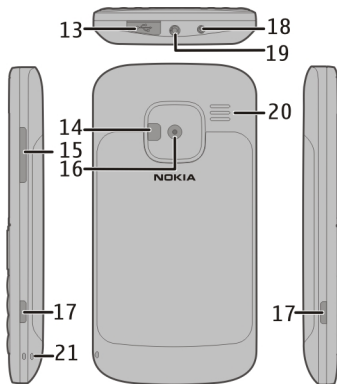

- 13 Micro USB connector
- 14 Camera flash/Flashlight
- 15 Volume key
- 16 Camera lens
- 17 Release buttons for back cover
- 18 Charger connector
- 19 Headset connector
- 20 Loudspeaker
- 21 Wrist strap hole

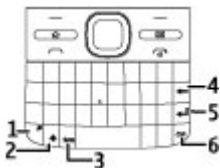

- 1 Function key
- 2 Shift key
- 3 Sym key
- 4 Backspace key
- 5 Enter key
- 6 Ctrl/Mute key

During extended operation such as an active video call and high speed data connection, the device may feel warm. In most cases, this condition is normal. If you suspect the device is not working properly, take it to the nearest authorised service facility.

### Insert the SIM card and battery

Safe removal. Always switch the device off and disconnect the charger before removing the battery.

- 1 Remove the back cover.

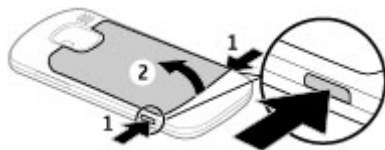

- 2 Remove the battery, if inserted.

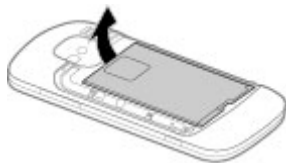

- 3 Slide the SIM card holder to unlock it, and swing it open. Insert the SIM card, with the contact area facing down, and swing the holder back. Slide the card holder to lock it.



- 4 Line up the battery contacts, and insert the battery.



- 5 Replace the back cover.

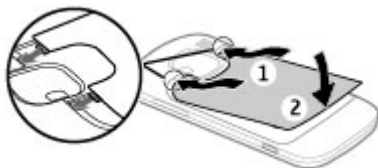

### Insert the memory card

A memory card may already be inserted in the device. If not, do the following:

- 1 Remove the back cover and battery, if inserted.
- 2 Slide the card holder to unlock it, and swing it open.



- 3 Insert the memory card, with the contact area facing down.

- 4 Swing the card holder back. Slide the card holder to lock it.
- 5 Replace the battery and back cover.

Use only compatible microSD cards approved by Nokia for use with this device. Nokia uses approved industry standards for memory cards, but some brands may not be fully compatible with this device. Incompatible cards may damage the card and the device and corrupt data stored on the card.

### Remove the memory card

- 1 Switch the device off.
- 2 Remove the back cover and the battery.
- 3 Open the memory card holder, and remove the memory card. Close the memory card holder.
- 4 Replace the battery and back cover.

### Wrist strap

Thread the wrist strap, and tighten it.

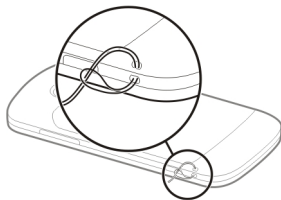

### Charge the battery

Your battery has been partially charged at the factory. If the device indicates a low charge, do the following:

- 1 Connect the charger to a wall outlet.
- 2 Connect the charger plug to the device.

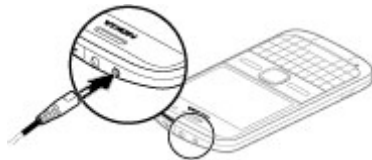

If you are using a USB charger, connect the charger plug to the USB connector.

## 14 Get started

---

- 3 When the device indicates a full charge, disconnect the charger from the device, then from the wall outlet.

You do not need to charge the battery for a specific length of time, and you can use the device while it is charging. If the battery is completely discharged, it may take several minutes before the charging indicator appears on the display or before any calls can be made.

### Charging with the USB data cable

Charging with the USB data cable is slower than charging with the charger. Charging with the USB data cable may not work if you use a USB hub. USB hubs may be incompatible for charging a USB device.

When the USB data cable is connected, you can transfer data at the same time as charging.

- 1 Connect a compatible USB device to your device using a compatible USB data cable.  
Depending on the type of the device that is used for charging, it may take a while for charging to start.

- 2 If the device is switched on, select from the available USB modes.

### Lock or unlock the keyboard

#### Lock the keyboard

In the home screen, select **Menu**, and quickly press the right selection key.

#### Set the keyboard to lock automatically after a defined length of time

Select **Menu** > **Ctrl. panel** > **Settings** and **General** > **Security** > **Phone and SIM card** > **Keypad autolock period** > **User defined**, and select the desired length of time.

#### Unlock the keyboard

Select **Unlock** > **OK**.

When the device or keypad is locked, calls may be possible to the official emergency number programmed into your device.

### Connect a compatible headset

Do not connect products that create an output signal as this may cause damage to the device. Do not connect any

voltage source to the Nokia AV Connector.

When connecting any external device or any headset, other than those approved by Nokia for use with this device, to the Nokia AV Connector, pay special attention to volume levels.



### Switch the device on and off

To switch on the device:

- 1 Press and hold the power key.



- 2 If the device asks for a PIN code or lock code, enter it, and select **OK**. The preset lock code is **12345**. If you forget the code and your device is locked, your device will require service and additional charges may apply. For more information, contact a Nokia Care point or your device dealer.

To switch off the device, press the power key briefly, and select **Switch off!**.

### Antenna locations

Your device may have internal and external antennas. Avoid touching the antenna area unnecessarily while the antenna is transmitting or receiving.

Contact with antennas affects the communication quality and may cause a higher power level during operation and may reduce the battery life.



### Nokia Switch About Switch



Select Menu > Ctrl. panel > Switch.

You can use the Switch application to copy content such as phone numbers, addresses, calendar items, and images from your previous Nokia device to your device. The type of content you can transfer depends on the model of your old device.

If you cannot use your old device without a SIM card, insert the card in it.

You can use Switch in your new device without a SIM card.

### Copy content from your old device

You can use the Switch application to copy content such as phone numbers, addresses, calendar items, and images from your previous compatible Nokia device to your new device.

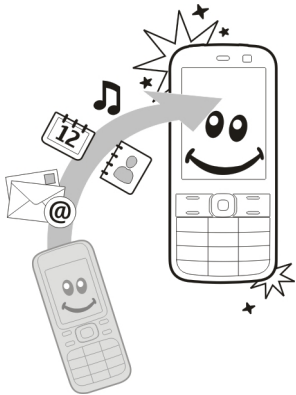

### Copy content for the first time

- 1 To retrieve data from the other device for the first time, on your



- device, select **Menu > Ctrl. panel > Switch.**
- 2 Pair the two devices. To have your device search for devices with Bluetooth connectivity, select **Continue**. Select the device from which you want to transfer content. You are asked to enter a code on your device. Enter a code (1-16 digits), and select **OK**. Enter the same code on the other device, and select **OK**. The devices are now paired.

If your old Nokia device does not have the Switch application, your new device sends it in a message. Open the message in the old device, and follow the instructions on the display.

- 3 On your device, select the content you want to transfer from the other device.
- When the transfer has started, you can cancel it and continue later.

Content is transferred from the memory of the other device to the corresponding location in your device. The transfer time depends on the amount of data to be transferred.

The type of content that can be transferred depends on the model of the device from which you want to transfer content. If that device supports synchronisation, you can also synchronise data between the devices. Your device notifies you if the other device is not compatible.

### Synchronise, retrieve, or send content

Select **Menu > Ctrl. panel > Switch.**

After the first transfer, select from the following to start a new transfer, depending on the model:



to synchronise content between your device and the other device, if the other device supports synchronisation. The synchronisation is two-way. If an item is deleted in one device, it is deleted in both. You cannot restore deleted items with synchronisation.



to retrieve content from the other device to your device. With retrieval, content is transferred from the other device to your device. You may be asked to keep or delete the

original content in the other device, depending on the device model.



to send content from your device to your other device

If you cannot send an item, depending on the type of the other device, you can add the item to the Nokia folder, to **C:\Nokia** or **E:\Nokia** in your device. When you select the folder to transfer, the items are synchronised in the corresponding folder in the other device, and vice versa.

### Use shortcuts to repeat a transfer

---

After a data transfer, you can save a shortcut with the transfer settings to the main view to repeat the same transfer later.

To edit the shortcut, select **Options > Shortcut settings**. For example, you can create or change the name of the shortcut.

A transfer log is shown after every transfer. To view the log of the last transfer, select a shortcut in the main view and **Options > View log**.

### Handle transfer conflicts

---

If an item to be transferred has been edited in both devices, the device attempts to merge the changes automatically. If this is not possible, there is a transfer conflict. Select **Check one by one**, **Priority to this phone**, or **Priority to other phone** to solve the conflict.

### Nokia Ovi Suite

Nokia Ovi Suite is a set of applications that you can install to a compatible PC. Ovi Suite groups all available applications in a launcher window from which you can open the applications. Ovi Suite may be included on a memory card, if provided with your device.

You can use Ovi Suite to synchronise contacts, calendar, and to-do and other notes between your device and a compatible PC application. You can also use Ovi Suite to transfer bookmarks between your device and compatible browsers, and transfer images and video clips between your device and a compatible PC.

Pay attention to synchronisation settings. Data deletion as part of normal synchronisation process is determined by the settings selected.

To use Ovi Suite, you need a PC that runs Microsoft Windows XP (SP2 or newer) or Windows Vista (SP1 or newer), and is compatible with a USB data cable or with Bluetooth connectivity.

Ovi Suite is not compatible with Apple Macintosh computers.

For further information on Ovi Suite, see the built-in help, or go to [www.nokia.com/support](http://www.nokia.com/support).

### Install Nokia Ovi Suite

- 1 Ensure the memory card is inserted in your Nokia E5-00.
- 2 Connect the USB cable. Your PC recognises the new device and installs the necessary drivers. This can take several minutes to complete.
- 3 Select **Mass storage** as the USB connection mode in your device. Your device is displayed in the Windows file browser as a Removable Disk.

- 4 Open the root of the memory card drive with the Windows file browser, and select the Ovi Suite installation file.
- 5 The installation is started. Follow the instructions.

**Tip:** To update Ovi Suite, or if you have problems when installing Ovi Suite from the memory card, copy the installation file to your PC, and install from your PC.

### Visit Ovi by Nokia

 With Ovi by Nokia, you can find new places and services, and stay in touch with your friends. You can do, for example, the following:

- Create a mail account
- Plan trips and view locations on a map
- Download games, applications, videos, and ringing tones to your device
- Purchase music

Some downloadable items are free of charge, others you may need to pay for.

The available services may vary by country or region, and not all languages are supported.

To access Nokia's Ovi services, go to [www.ovi.com](http://www.ovi.com), and register your own Nokia account.

For more information, go to [www.ovi.com/support](http://www.ovi.com/support).

### About Ovi Store

 In Ovi Store, you can download mobile games, applications, videos, images, themes, and ringing tones to your device. Some items are free of charge; others you need to pay for with your credit card or in your phone bill. The availability of payment methods depends on your country of residence and your network service provider. Ovi Store offers content that is compatible with your mobile device and relevant to your tastes and location.

### Access codes

If you forget any of the access codes, contact your service provider.

**Personal identification number (PIN) code** — This code protects your SIM card

against unauthorised use. The PIN code (4 - 8 digits) is usually supplied with the SIM card. After three consecutive incorrect PIN code entries, the code is blocked, and you need the PUK code to unblock it.

**UPIN code** — This code may be supplied with the USIM card. The USIM card is an enhanced version of the SIM card and is supported by 3G mobile phones.

**PIN2 code** — This code (4 - 8 digits) is supplied with some SIM cards, and is required to access some functions in your device.

**Lock code** (also known as security code) — The lock code helps you to protect your device against unauthorised use. The preset code is 12345. You can create and change the code, and set the device to request the code. Keep the new code secret and in a safe place separate from your device. If you forget the code and your device is locked, your device will require service. Additional charges may apply, and all the personal data in your device may be deleted. For more information, contact a Nokia Care Point or your device dealer.

**Personal Unblocking Key (PUK) code and PUK2 code** — These codes (8 digits) are required to change a blocked PIN code

or PIN2 code, respectively. If the codes are not supplied with the SIM card, contact the network service provider whose SIM card is in your device.

**UPUK code** — This code (8 digits) is required to change a blocked UPIN code. If the code is not supplied with the USIM card, contact the network service provider whose USIM card is in your device.

**International Mobile Equipment Identity (IMEI) number** — This number (15 or 17 digits) is used to identify valid devices on the GSM network. Devices that are, for example, stolen, can be blocked from accessing the network. The IMEI number for your device can be found under the battery.

## Basic use

Learn how to use the basic features of your device.

### Home screen

Learn how to use and personalise your home screen, and organise the content to your liking.

### Home screen

The home screen is your starting point where you can collect all your important contacts and application shortcuts.

When you have switched on the device, and it is registered to a network, the device is in the home screen view.

Use the scroll key to navigate in the home screen.



The home screen consists of the following:

- 1 Contacts bar
- 2 Application plug-ins
- 3 Application shortcuts

To customise application plug-ins and shortcuts, or to change the home screen

theme, select **Menu > Ctrl. panel > Settings and General > Personalisation > Standby mode** and the appropriate option. You might not be able to change all shortcuts.

### Contacts bar

To add a contact to your home screen, select the Add icon and a contact from the list.

To create a new contact, select **Options > New contact**, enter the details, and select **Done**. You can also add an image to the contact information.

To remove a contact from the home screen, in the contact information view, select the Open icon and **Remove**.

### One-touch keys

With the One-touch keys, you can access applications and tasks quickly. Your service provider may have assigned applications to the keys, in which case you cannot change them.



- 1 Home key
- 2 Messaging key

### Home key

To access the home screen, press the home key briefly. Press the home key briefly again to access the menu.

To view the list of active applications, press the home key for a few seconds. When the list is open, press the home key briefly to scroll the list. To open the selected application, press the home key for a few seconds, or press the scroll key. To close the selected application, press the backspace key.

Leaving applications running in the background increases the demand on battery power and reduces the battery life.

### Messaging key

To open the Messaging application, press the messaging key.

To start writing a new message, press and hold the messaging key.

When you press the messaging key for the first time, you are asked to define the messaging key settings. Follow the instructions on the display. You can modify the settings later.

### Write text

The available input methods may vary.

### Use the keyboard

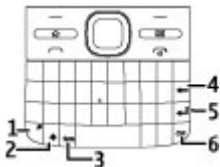

- 1 Function key
- 2 Shift key
- 3 Sym key
- 4 Backspace key
- 5 Enter key
- 6 Ctrl key

### Switch between the different character cases

To change between the upper and lower case modes, press the shift key twice. To enter a single upper case letter in lower case mode, or vice versa, press the shift key once, and then the desired alphabet key.

### Insert a number or special character printed at the top of a key

Press the function key, and then press the corresponding alphabet key, or press and hold the alphabet key only. To enter several special characters in a row, press the function key twice quickly, and then press the desired alphabet keys. To return to normal mode, press the function key once.

### Insert a special character that is not on the keyboard

Press the sym key, and select **\*#** and a character.

### Insert a letter that is not on the keyboard

It is possible to insert variations of letters, for example, letters with accents. For example, to insert á, press

and hold the sym key, and simultaneously press the A key repeatedly, until the desired character is displayed. The order and availability of letters depends on the selected writing language.

### Insert a smiley

Press the sym key, and select a smiley. Smileys are only available for text and multimedia messages.

**Tip:** To add a recently used special character, while pressing and holding the ctrl key, press the sym key, and from the pop-up menu, select the character.

### Copy and paste text

- 1 Press and hold the shift key, and scroll to highlight the text you want to copy.
- 2 Press **ctrl + C**.
- 3 Go to the place where you want to paste the text, and press **ctrl + V**.

### Change the writing language or activate predictive text input

Select **Options > Input options**.

### Predictive text input

To activate predictive text input, select **Options > Input options > Activate prediction**. The indicator  is displayed.

When you start writing a word, your device suggests possible words. When the correct word is found, scroll right to confirm it.

While writing, you can also scroll down to access a list of suggested words. If the desired word is on the list, select the word.

If the word you are writing is not in the dictionary of the device, the device suggests a possible word, while the word you were writing is shown above the suggested word. Scroll up to select your word. The word is added to the dictionary when you start writing the next word.

To deactivate predictive text input, select **Options > Input options > Deactivate prediction**.

To define the settings for text input, select **Options > Input options > Settings**.



To change the writing language, select **Options** > **Input options** > **Writing language**.

## Contacts

### Stay connected with your online friends

You can synchronise the contact information on your device with contacts you have on Facebook. When you allow synchronisation, you are able to view your contacts' Facebook profile information, such as their picture and status updates, in the Contacts application on your device.

Synchronising your contacts and retrieving status updates are network services. Roaming and data transfer charges may apply. If the social networking service is not available or functioning correctly, you may not be able to synchronise or retrieve status updates.

### Synchronise your contacts

Open the social networking service application, and follow the instructions.

This feature may not be available in certain regions.

### Copy contacts

Select **Menu** > **Contacts**.

When you open the contacts list for the first time, the device asks if you want to copy names and numbers from the SIM card to your device.

### Start copying

Select **OK**.

### Cancel copying

Select **Cancel**.

The device asks if you want to view the SIM card contacts in the contacts list. To view the contacts, select **OK**. The contacts list opens, and the names stored on your SIM card are indicated with .

### Manage names and numbers

Select **Menu** > **Contacts**.

### Delete a contact

Go to a contact, and select **Options** > **Delete**.

### Delete several contacts

- 1 To mark a contact to be deleted, go to the contact, and select **Options > Mark/Unmark**.
- 2 To delete the marked contacts, select **Options > Delete**.

### Copy a contact

Go to a contact, and select **Options > Copy** and the desired location.

### Send a contact to another device

Select the contact and **Options > View details > Options > Send business card**.

### Listen to the voice tag assigned to a contact

Select the contact and **Options > View details > Options > Voice tag details > Options > Play voice tag**.

When entering contacts or editing voice commands, do not use very short or similar names for different contacts or commands.

Using voice tags may be difficult in a noisy environment or during an emergency, so you should not rely solely upon voice dialling in all circumstances.

### Save and edit names and numbers

Select **Menu > Contacts**.

### Add a new contact to the contacts list

- 1 Select **Options > New contact**.
- 2 Fill in the appropriate fields, and select **Done**.

### Edit a contact

Select a contact and **Options > View details > Options > Edit**.

### Ring tones, images, and call text for contacts

You can define a ringing tone for a contact or group, and an image and a call text for a contact. When the contact calls you, the device plays the selected ringing tone and shows the call text or image if the caller's phone number is sent with the call and your device recognises it.

To define a ringing tone for a contact or a contact group, select the contact or contact group, **Options > View details > Options > Ringing tone**, and a ringing tone.

To define the call text for a contact, select the contact and **Options > View details > Options > Add text for call**. Enter the call text, and select **OK**.

- 1 To add an image for a contact saved in the device memory, select the contact and **Options > View details > Options > Add image**.
- 2 Select an image from Photos.

To remove the ringing tone, select **Default tone** from the list of ringing tones.

To view, change, or remove the image from a contact, select the contact, **Options > View details > Options > Image**, and the desired option.

## Calendar

### About Calendar

Select **Menu > Calendar**.

With calendar, you can create and view scheduled events and appointments, and switch between different calendar views.

In the month view, calendar entries are marked with a triangle. Anniversary entries are also marked with an exclamation mark. The entries of the selected day are displayed as a list.

To open calendar entries, select a calendar view and an entry.

Whenever you see the  icon, scroll right to access a list of available actions. To close the list, scroll left.

### Create calendar entries

Select **Menu > Calendar**.

You can create the following types of calendar entries:

- Meeting entries remind you of events that have a specific date and time.
- Meeting requests are invitations that you can send to the participants. Before you can create meeting requests you must have a compatible mailbox configured to your device.
- Memo entries are related to the whole day but not to a specific time of the day.

- Anniversary entries remind you of birthdays and special dates. They refer to a certain day but not a specific time of the day. Anniversary entries are repeated every year.
- To-do entries remind you of a task that has a due date but not a specific time of the day.

To create a calendar entry, select a date, **Options** > **New entry**, and the entry type.

To set the priority for meeting entries, select **Options** > **Priority**.

To define how the entry is handled during synchronisation, select **Private** to hide the entry from viewers if the calendar is available online, **Public** to make the entry visible to viewers, or **None** to not copy the entry to your computer.

To send the entry to a compatible device, select **Options** > **Send**.

To make a meeting request of a meeting entry, select **Options** > **Add participants**.

### Create meeting requests

Select **Menu** > **Calendar**.

Before you can create meeting requests, you must have a compatible mailbox configured for your device.

To create a meeting entry:

- 1 To create a meeting entry, select a day and **Options** > **New entry** > **Meeting request**.
- 2 Enter the names of the required participants. To add names from your contacts list, enter the first few characters, and select from the proposed matches. To add optional participants, select **Options** > **Add optional participants**.
- 3 Enter the subject.
- 4 Enter the start and end times and dates, or select **All-day event**.
- 5 Enter the location.
- 6 Set an alarm for the entry, if needed.
- 7 For a recurring meeting, set the recurrence time, and enter the end date.
- 8 Enter a description.

To set the priority for the meeting request, select **Options** > **Priority**.

To send the meeting request, select **Options** > **Send**.

## Calendar views

Select **Menu** > **Calendar**.

You can switch between the following views:

- Month view shows the current month and the calendar entries of the selected day in a list.
- Week view shows the events for the selected week in seven day boxes.
- Day view shows the events for the selected day grouped into time slots according to their starting time.
- To-do view shows all to-do items.
- Agenda view shows the events for the selected day in a list.

To change the view, select **Options** > **Change view** and the desired view.

To move to the next or the previous day in month, week, day, and agenda view, select the desired day.

To change the default view, select **Options** > **Settings** > **Default view**.

## Multitasking

You can have several applications open at the same time. To switch between active applications, press and hold , scroll to an application, and press the scroll key. To close the selected application, press the backspace key.

**Example:** When you have an active phone call and want to check your calendar, press  to access the menu, and open the Calendar application. The phone call remains active in the background.

**Example:** When you are writing a message and want to check a web site, press  to access the menu, and open the Web application. Select a bookmark or enter the web address manually, and select **Go to**. To return to your message,

press and hold , scroll to the message and press the scroll key.

### Flashlight

The camera flash can be used as a flashlight. To switch the flashlight on or off, in the home screen, press and hold the space bar.

Do not point the flashlight at anyone's eye.

### Ovi Files

With Ovi Files, you can use your Nokia E5-00 to access content on your computer if it is switched on and connected to the internet. You will need to install the Ovi Files application on every computer you want to access with Ovi Files.

With Ovi Files, you can:

- Browse, search, and view your images. You do not need to upload the images to the website but you can access your computer content with your mobile device.
- Browse, search, and view your files and documents.

- Transfer songs from your computer to your device.
- Send files and folders from your computer without moving them to and from your device first.
- Access files on your computer even when your computer is switched off. Just choose which folders and files you want to be available, and Ovi Files automatically keeps an up-to-date copy stored in a protected, online storage for access even when your computer is switched off.

For support, see [files.ovi.com/support](http://files.ovi.com/support).

## Make calls

### Voice calls

- 1 In the home screen, enter the phone number, including the area code. To remove a number, press the backspace key.  
For international calls, press + (+ replaces the international access code), and enter the country code, area code (omit the leading zero if necessary), and phone number.
- 2 To make the call, press the call key.

- 3 To end the call (or to cancel the call attempt), press the end key. Pressing the end key always ends a call, even if another application is active.

To make a call from the contacts list, select **Menu > Contacts**.

Scroll to the desired name, or enter the first letters or characters of the name to the search field.

To call the contact, press the call key. If you have saved several numbers for a contact, select the desired number from the list, and press the call key.

### During a call

#### Mute or unmute the microphone

Select **Mute** or **Unmute**.

#### Put an active voice call on hold

Select **Options > Hold**.

#### Activate the loudspeaker

Select **Options > Activate loudspeaker**. If you have attached a compatible headset with Bluetooth

connectivity, to route the sound to the headset, select **Options > Activate handsfree**.

#### Switch back to the handset

Select **Options > Activate handset**.

#### End a call

Press the end key.

#### Switch between active and held calls

Select **Options > Swap**.

**Tip:** To put an active call on hold, press the call key. To activate the held call, press the call key again.

#### Send DTMF tone strings

- 1 Select **Options > Send DTMF**.
- 2 Enter the DTMF string or search for it from the contacts list.
- 3 To enter a wait character (w) or a pause character (p), press \* repeatedly.
- 4 To send the tone, select **OK**. You can add DTMF tones to the phone number or DTMF field in contact details.

### End an active call and replace it with another incoming call

Select **Options** > **Replace**.

### End all calls

Select **Options** > **End all calls**.

Many of the options that you can use during a voice call are network services.

### Voice mail

Select **Menu** > **Settings** > **Call mailbox**.

When you open the Voice mail application (network service) for the first time, you are asked to enter the number of your voice mailbox.

To call your voice mailbox, scroll to **Voice mailbox**, and select **Options** > **Call voice mailbox**.

To call your mailbox in the home screen, press and hold **1**; or press **1** and then the call key. Select the mailbox you want to call.

To change the mailbox number, select the mailbox and **Options** > **Change number**.

### Answer or decline a call

To answer the call, press the call key.

To mute the ringing tone of an incoming call, select **Silence**.

If you do not want to answer a call, press the end key. If you activate the **Call divert** > **Voice calls** > **If busy** function in phone settings to divert calls, declining an incoming call also diverts the call.

When you select **Silence** to mute the ringing tone of an incoming call, you can send a text message without rejecting the call, informing the caller that you cannot answer the call. Select **Options** > **Send message**.

To activate or deactivate rejecting calls with a text message, select **Menu** > **Ctrl. panel** > **Settings** and **Phone** > **Call** > **Reject call with message**. To



edit the content of the message sent to the caller, select **Message text**.

### Make a conference call

- 1 Make a call to the first participant.
- 2 To make a call to another participant, select **Options > New call**. The first call is put on hold.
- 3 When the new call is answered, to join the first participant in the conference call, select **Options > Conference**.

To add a new person to the call, repeat step 2, and select **Options > Conference > Add to conference**.

Your device supports conference calls between a maximum of six participants, including yourself.

To have a private conversation with one of the participants, select **Options > Conference > Private**.

Select a participant, and select **Private**. The conference call is put on hold on your device. The other participants can still continue the conference call.

After you finish the private conversation, select **Options > Conference** to return to the conference call.

To drop a participant, select **Options > Conference > Drop participant**, scroll to the participant, and select **Drop**.

- 4 To end the active conference call, press the end key.

### Speed dial a phone number

To activate the feature, select **Menu > Ctrl. panel > Settings and Phone > Call > Speed dialing**.

- 1 To assign a phone number to one of the number keys (2-9), select **Menu > Ctrl. panel > Speed dial**.
- 2 Scroll to the key to which you want to assign the phone number, and select **Options > Assign**.  
1 is reserved for the voice mailbox.

To call an assigned number, in the home screen, press the assigned key and then the call key.

### Call waiting

You can answer a call while you have another call in progress. To activate call waiting (network service), select **Menu > Ctrl. panel > Settings and Phone > Call > Call waiting.**

To answer the waiting call, press the call key. The first call is put on hold.

To switch between the two calls, select **Swap.**

To connect an incoming call or a call on hold with an active call and to disconnect yourself from the calls, select **Options > Transfer.**

To end the active call, press the end key.

To end both calls, select **Options > End all calls.**

### Call divert

Select **Menu > Ctrl. panel > Settings and Phone > Call divert.**

Divert incoming calls to your voice mailbox or to another phone number. For details, contact your service provider.

Select the type of calls to divert and from the following:

**All voice calls, All data and video calls, or All fax calls** — Divert all incoming voice, data, video, or fax calls. You cannot answer the calls, only divert the calls to another number.

**If busy** — Divert incoming calls if you have an active call.

**If not answered** — Divert incoming calls after your device rings for a specified length of time. Select the length of time for the device to ring before diverting the call.

**If out of reach** — Divert calls when the device is switched off or out of network coverage.

**If not available** — Divert calls if you have an active call, do not answer, or the device is switched off or out of network coverage.

To divert calls to your voice mailbox, select a call type, a diverting option, and **Options > Activate > To voice mailbox**.

To divert calls to another phone number, select a call type, a diverting option, and **Options > Activate > To other number**. Enter the number, or select **Find** to retrieve a number saved in Contacts.

To check the current diverting status, scroll to the diverting option, and select **Options > Check status**.

To stop diverting calls, scroll to the diverting option, and select **Options > Deactivate**.

### Call barring

Select **Menu > Ctrl. panel > Settings and Phone > Call barring**.

You can bar the calls that can be made or received with the device (network service). To modify the settings, you need the barring password from your service provider. Call barring affects all call types.

Select from the following voice call barring settings:

**Outgoing calls** — Prevent making voice calls with your device.

**Incoming calls** — Prevent incoming calls.

**International calls** — Prevent calling to foreign countries or regions.

**Incoming calls when roaming** — Prevent incoming calls when outside your home country.

**International calls except to home country** — Prevent calls to foreign countries or regions, but allow calls to your home country.

To check the status of voice call barrings, select the barring option and **Options > Check status**.

To deactivate all voice call barrings, select a barring option and **Options > Deactivate all barrings**.

To change the password used for barring voice, fax, and data calls, select **Options > Edit barring password**. Enter the current code, then the new code twice. The barring password must

be four digits long. For details, contact your service provider.

### Voice dialling

Your device supports enhanced voice commands. Enhanced voice commands are not dependent on the speaker's voice, so you do not need to record voice tags in advance. The device creates a voice tag for the entries in the contacts, and compares the spoken voice tag to it. The voice recognition in the device adapts to the main user's voice to recognise the voice commands better.

The voice tag for a contact is the name that is saved for the contact. To listen to the synthesised voice tag, select a contact and **Options > View details > Options > Voice tag details > Options > Play voice tag**.

**Note:** Using voice tags may be difficult in a noisy environment or during an emergency, so you should not rely solely upon voice dialling in all circumstances.

### Make a call with a voice tag

When you use voice dialling, the loudspeaker is in use. Hold the device at

a short distance away when you say the voice tag.

- 1 To start voice dialling, in the home screen, press and hold the right selection key. If a compatible headset with the headset key is attached, press and hold the headset key to start voice dialling.
- 2 A short tone sounds, and **Speak now** is displayed. Say clearly the name that is saved for the contact.
- 3 The device plays a synthesised voice tag for the recognised contact, and displays the name and number. If you do not want to call that contact, select another contact from the list of matches within 2.5 seconds, or, to cancel, select **Quit**.

If several numbers are saved for a name, the device selects the default number, if defined. Otherwise, the device selects the first available number in a contact card. You can also say the name and telephone number type, such as mobile or home.

### Make a video call

When you make a video call (network service), you can see a real-time, two-

way video between you and the recipient of the call. The live video image, or video image captured by the camera in your device is shown to the video call recipient.

To be able to make a video call, you must have a USIM card and be in the coverage of a 3G network. For availability of and subscription to video call services, contact your network service provider.

A video call can only be made between two parties. The video call can be made to a compatible mobile device or an ISDN client. Video calls cannot be made while another voice, video, or data call is active.

## Icons



You are not receiving video (the recipient is not sending video or the network is not transmitting it).



You have denied video sending from your device. To send a still image instead, select **Menu > Ctrl. panel > Settings and Phone > Call > Image in video call.**

Even if you denied video sending during a video call, the call is still charged as a video call. Check the pricing with your service provider.

- 1 To start a video call, enter the phone number in the standby mode, or select **Contacts** and a contact.
- 2 Select **Options > Call > Video call.**

Starting a video call may take a while. **Waiting for video image** is shown. If the call is not successful (for example, video calls are not supported by the network, or the receiving device is not compatible), you are asked if you want to try a normal call or send a text or multimedia message instead.

The video call is active when you see two video images, and hear the sound through the loudspeaker. The call recipient may deny video sending () , in which case you only hear the sound and may see a still image or a grey background graphic.

- 3 To end the video call, press the end key.

### During a video call

#### View live video or listen to the caller only

Select **Options** > **Enable** or **Disable** and the desired option.

#### Mute or unmute the microphone

Select **Mute** or **Unmute**.

#### Activate the loudspeaker

Select **Options** > **Activate loudspeaker**. If you have attached a compatible headset with Bluetooth connectivity, to route the sound to the headset, select **Options** > **Activate handsfree**.

#### Switch back to the handset

Select **Options** > **Activate handset**.

#### Take a snapshot of the video you are sending

Select **Options** > **Send snapshot**. Video sending is paused and the snapshot is displayed to the recipient. The snapshot is not saved.

#### Zoom your image

Select **Options** > **Zoom**.

### Set the video quality

Select **Options** > **Adjust** > **Video preference** > **Normal quality**, **Clearer detail**, or **Smoother motion**.

### Answer or decline a video call

When a video call arrives,  is displayed.

To answer the video call, press the call key. **Allow video image to be sent to caller?** is displayed.

To start sending live video image, select **Yes**.

If you do not activate the video call, you only hear the sound of the caller. A grey screen replaces the video image. To replace the grey screen with a still image captured by the camera in your device, select **Menu** > **Ctrl. panel** > **Settings and Phone** > **Call** > **Image in video call**.

To end the video call, press the end key.

## Video sharing

Use video sharing (network service) to send live video or a video clip from your mobile device to another compatible mobile device during a voice call.

The loudspeaker is active when you activate video sharing. If you do not want to use the loudspeaker for the voice call while you share video, you can also use a compatible headset.

### Warning:

Continuous exposure to high volume may damage your hearing. Listen to music at a moderate level, and do not hold the device near your ear when the loudspeaker is in use.

## Video sharing requirements

Video sharing requires a 3G connection. For more information on the service, 3G network availability, and fees associated with using this service, contact your service provider.

To use video sharing you must do the following:

- Ensure that your device is set up for person-to-person connections.
- Ensure you have an active 3G connection and are within 3G network coverage. If you move outside the 3G network during a video sharing session, the sharing stops while your voice call continues.
- Ensure that both the sender and recipient are registered to the 3G network. If you invite someone to a sharing session and the recipient's device is not within 3G network coverage, does not have video sharing installed, or person-to-person connections set up, the recipient does not receive invitations. You receive an error message that indicates that the recipient cannot accept the invitation.

## Settings

To set up video sharing, you need person-to-person and 3G connection settings.

### Person-to-person connection settings

A person-to-person connection is also known as a Session Initiation Protocol (SIP) connection. The SIP profile settings

must be configured in your device before you can use video sharing. Ask your service provider for the SIP profile settings, and save them in your device. Your service provider may send you the settings or give you a list of the needed parameters.

To add a SIP address to a contact card:

- 1 Select  > **Contacts**.
- 2 Open the contact card (or start a new card for that person).
- 3 Select **Options** > **Add detail** > **Share video**.
- 4 Enter the SIP address in the format `username@domainname` (you can use an IP address instead of a domain name).

If you do not know the SIP address for the contact, you can use the phone number of the recipient, including the country code, to share video (if supported by the network service provider).

### 3G connection settings

---

To set up your 3G connection:

- Contact your service provider to establish an agreement for you to use the 3G network.
- Ensure that your device 3G access point connection settings are configured properly.

### Share live video or video clips

During an active voice call, select **Options** > **Share video**.

- 1 To share live video during the call, select **Live video**.  
To share a video clip, select **Video clip** and the clip you want to share. Your device checks if the video clip needs to be converted. If needed, the video clip is automatically converted.
- 2 If the recipient has several SIP addresses or phone numbers including the country code saved in the contacts list, select the desired address or number. If the SIP address or phone number of the recipient is not available, enter the address or number of the recipient including the country code, and select **OK** to send the invitation. Your device sends the invitation to the SIP address.



Sharing begins automatically when the recipient accepts the invitation.

### Options during video sharing



Zoom the video (available for sender only).



Adjust the brightness (available for sender only).



Mute or unmute the microphone.



Turn the loudspeaker on and off.



Pause and resume video sharing.



Switch to full screen mode (available for receiver only).

- To stop sharing video, select **Stop**. To end the voice call, press the end key. When you end the call, video sharing also ends.

To save the live video you shared, select **Yes** when prompted. The device notifies you of the memory location of the saved video. To define the preferred memory location, select **Menu > Ctrl. panel >**

**Settings and Connection > Video sharing > Preferred saving memory.**

If you access other applications while you are sharing a video clip, the sharing is paused. To return to the video sharing view, and to continue sharing, in the home screen, select **Options > Resume video sharing**.

### Accept an invitation

When someone sends you a video sharing invitation, the invitation message displays the sender's name or SIP address. If your device is not set to silent, it rings when you receive an invitation.

If someone sends you a share invitation and you are not within UMTS network coverage, you will not know that you received an invitation.

When you receive an invitation, select from the following:

**Yes** — Accept the invitation, and activate the sharing session.

**No** — Reject the invitation. The sender receives a message that you rejected the invitation. You can also press the

end key to reject the invitation and end the voice call.

To mute the video on your device, select **Options > Mute**.

To play the video at the original volume, select **Options > Original volume**. This does not affect the audio playback of the other party of the phone call.

To end the sharing session, select **Stop**. To end the voice call, press the end key. When you end the call, also video sharing ends.

### Log

The log stores information about the communication history of the device. The device registers missed and received calls only if the network supports these functions, the device is switched on, and within the network service area.

### Recent calls

You can view information about your recent calls.

Select **Menu > Log and Recent calls**.

### View missed, received, and dialled calls

Select **Missed calls, Received calls, or Dialled numbers**.

Select **Options** and from the following: **Save to Contacts** — Save a phone number from a recent calls list to your contacts.

**Clear list** — Clear the selected recent calls list.

**Delete** — Clear an event in the selected list.

**Settings** — Select **Log duration** and the length of time that the communication information is saved in the log. If you select **No log**, no information is saved in the log.

### Call duration

Select **Menu > Log**.

To view the approximate duration of your last call, and dialled and received calls, select **Call duration**.

### Packet data



Select **Menu > Log**.

To check the amount of data sent or received during packet data connections, select **Packet data** > **All sent data** or **All received data**.

To clear both sent and received information, select **Options** > **Clear counters**. You need the lock code to clear the information.

### Monitor all communication events

Select Menu > Log.

To open the general log where you can monitor all voice calls, text messages, or data and wireless LAN connections registered by the device, select the general log tab   .

Subevents, such as a text message sent in more than one part and packet data connections, are logged as one communication event. Connections to your mailbox, multimedia messaging centre, or web pages are shown as packet data connections.

To view how much data was transferred and how long a certain packet data connection lasted, scroll to an incoming

or outgoing event indicated by **Pack.**, and select **Options** > **View**.

To copy a phone number from the log to the clipboard, and paste it into a text message, for example, select **Options** > **Use number** > **Copy**.

To filter the log, select **Options** > **Filter** and a filter.

To set the log duration, select **Options** > **Settings** > **Log duration**. If you select **No log**, all the log contents, recent calls register, and messaging delivery reports are permanently deleted.

## Messaging

Select Menu > Messaging.

In Messaging (network service), you can send and receive text messages, multimedia messages, audio messages, and e-mail messages. You can also receive web service messages, cell broadcast messages, and special messages containing data, and send service commands.

Before sending or receiving messages, you may need to do the following:

- Insert a valid SIM card in the device and be located in the service area of a cellular network.
- Verify that the network supports the messaging features you want to use and that they are activated on your SIM card.
- Define the internet access point settings on the device.
- Define the e-mail account settings on the device.
- Define the text message settings on the device.
- Define the multimedia message settings on the device.

The device may recognise the SIM card provider and automatically configure some of the message settings. If not, you may need to define the settings manually; or contact your service provider to configure the settings.

### Messaging folders

Select **Menu > Messaging**.

Messages and data received using Bluetooth connectivity are stored in the

Inbox folder. E-mail messages are stored in the Mailbox folder. Messages that you have been writing can be stored in the Drafts folder. Messages that are waiting to be sent are stored in the Outbox folder, and messages that have been sent, excluding Bluetooth messages, are stored in the Sent folder.

**Tip:** Messages are placed in the Outbox folder, for example, when your device is outside network coverage.

**Note:** The message sent icon or text on your device screen does not indicate that the message is received at the intended destination.

To request the network to send you a delivery report of the text messages and multimedia messages you have sent (network service), select **Options > Settings > Text message > Receive report or Multimedia message > Receive reports**. The reports are saved in the Reports folder.

### Organise messages

Select **Menu > Messaging and My folders**.

To create a new folder to organise your messages, select **Options > New folder**.

To rename a folder, select **Options > Rename folder**. You can only rename folders that you have created.

To move a message to another folder, select the message, **Options > Move to folder**, the folder, and **OK**.

To sort messages in a specific order, select **Options > Sort by**.

To view the properties of a message, select the message and **Options > Message details**.

## E-mail

### Set up your e-mail

With the E-mail wizard, you can set up your corporate e-mail account, such as Mail for Exchange, and your internet e-mail account.

When setting up your corporate e-mail, you may be prompted for the name of the server associated with your e-mail address. For details, contact your company IT department.

- 1 To open the wizard, in the home screen, select **Set up e-mail**.
- 2 Enter your e-mail address and password. If the wizard is not able to configure your e-mail settings automatically, you need to select your e-mail account type, and enter the related account settings.

If your device contains any additional e-mail clients, those are offered to you when you open the wizard.

### Send e-mail

Select **Menu > Messaging**.

- 1 Select your mailbox and **Options > Create email**.
- 2 In the **To** field, enter the recipient's e-mail address. If the recipient's e-mail address can be found in **Contacts**, start entering the recipient's name, and select the recipient from the proposed matches. If you add several recipients, insert **;** to separate the e-mail addresses. Use the **Cc** field to send a copy to other recipients, or the **Bcc** field to send a blind copy to recipients. If the **Bcc** field is not

visible, select **Options** > **More** > **Show Bcc field**.

- 3 In the Subject field, enter the subject of the e-mail.
- 4 Enter your message in the text area.
- 5 Select **Options** and from the following:

**Add attachment** — Add an attachment to the message.

**Priority** — Set the priority of the message.

**Flag** — Flag the message for follow-up.

**Insert template** — Insert text from a template.

**Add recipient** — Add recipients to the message from Contacts.

**Editing options** — Cut, copy, or paste the selected text.

**Input options** — Activate or deactivate predictive text input, or select the writing language.

- 6 Select **Options** > **Send**.

The available options may vary.

### Add attachments

Select Menu > Messaging.

To write an e-mail message, select your mailbox and **Options** > **Create email**.

To add an attachment to the e-mail message, select **Options** > **Add attachment**.

To remove the selected attachment, select **Options** > **Remove attachment**.

### Read e-mail

Select Menu > Messaging.

**Important:** Exercise caution when opening messages. Messages may contain malicious software or otherwise be harmful to your device or PC.

To read a received e-mail message, select the mailbox, and select the message from the list.

To reply to the message sender, select **Options** > **Reply**. To reply to the sender and all other recipients, select **Options** > **Reply to all**.

To forward the message, select **Options** > **Forward**.

### Download attachments

Select **Menu** > **Messaging** and a mailbox.

To view the attachments in a received e-mail message, scroll to the attachment field, and select **Options** > **Actions**. If there is one attachment in the message, select **Open** to open the attachment. If there are several attachments, select **View list** to see a list showing which attachments have been downloaded.

To download the selected attachment or all the attachments from the list to your device, select **Options** > **Actions** > **Download** or **Download all**. The attachments are not saved in your device, and are deleted when you delete the message.

To save the selected attachment or all the downloaded attachments in your device, select **Options** > **Actions** > **Save** or **Save all**.

To open the selected, downloaded attachment, select **Options** > **Actions** > **Open**.

### Reply to a meeting request

Select **Menu** > **Messaging** and a mailbox.

Select a received meeting request, **Options**, and from the following:

**Accept** — Accept the meeting request.

**Decline** — Decline the meeting request.

**Forward** — Forward the meeting request to another recipient.

**Remove from calendar** — Remove a cancelled meeting from your calendar.

### Search for e-mail messages

Select **Menu** > **Messaging** and a mailbox.

To search for items within the recipients, subjects, and body texts of the e-mail messages in the mailbox, select **Options** > **Search**.

To stop the search, select **Options** > **Stop search**.

To start a new search, select **Options** > **New search**.

### Delete e-mails

Select **Menu** > **Messaging** and a mailbox.

To delete an e-mail message, select the message and **Options** > **Actions** > **Delete**. The message is placed in the Deleted items folder, if available. If there is no Deleted items folder available, the message is deleted permanently.

To empty the Deleted items folder, select the folder and **Options** > **Empty deleted items**.

### Switch between e-mail folders

Select **Menu** > **Messaging** and a mailbox.

To open another e-mail folder or mailbox, select **Inbox** at the top of the display. Select the e-mail folder or mailbox from the list.

### Disconnect from the mailbox

Select **Menu** > **Messaging** and a mailbox.

To cancel the synchronisation between the device and the e-mail server, and to work with e-mail without a wireless connection, select **Options** > **Disconnect**. If your mailbox does not have the **Disconnect** option, select **Options** > **Exit** to disconnect from the mailbox.

To start the synchronisation again, select **Options** > **Connect**.

### Set an out-of-office reply

Select **Menu** > **Applications** > **Installations** > **Email**.

To set an out-of-office reply, if available, select your mailbox and **Options** > **Settings** > **Mailbox settings**. Depending on the mailbox type, select either **Mailbox** > **Out of office** > **On** or **Mailbox settings** > **Out of office** > **On**.

To enter the text for the reply, select **Out of office reply**.



## General e-mail settings

Select **Menu > Applications > Installations > Email and Settings > Global settings.**

Select from the following:

**Message list layout** — Select whether the e-mail messages in Inbox display one or two lines of text.

**Body text preview** — Preview messages when scrolling through the list of e-mail messages in Inbox.

**Title dividers** — To be able to expand and collapse the list of e-mail messages, select **On**.

**Download notifications** — Set the device to display a notification when an e-mail attachment has been downloaded.

**Warn before delete** — Set the device to display a warning before you delete an e-mail message.

**Home screen** — Define how many lines of e-mail are displayed in the home screen information area.

## Nokia Messaging

The Nokia Messaging service automatically pushes e-mail from your existing e-mail address to your Nokia

E5-00. You can read, respond to, and organise your e-mails on the go. The Nokia Messaging service works with a number of internet e-mail providers that are often used for personal e-mail, such as Google e-mail services.

The Nokia Messaging service must be supported by your network and may not be available in all regions.

## Install the Nokia Messaging application

- 1 Select **Menu > Messaging and New mailbox.**
- 2 Read the information on the display, and select **Start.**
- 3 If requested, allow your device to connect to the internet.
- 4 Select your e-mail service provider or account type.
- 5 Enter the required account details, such as e-mail address and password.

The Nokia Messaging service can run on your device even if you have installed other e-mail applications, such as Mail for Exchange.

### Ovi Contacts

#### About Ovi Contacts

 With Ovi Contacts, you can stay connected to your friends and family, follow what they are up to, and discover new friends in the Ovi community. You can also back up contacts from your device to Ovi.

Additionally, you can share your location with your friends.

To use Ovi Contacts, go to [www.ovi.com](http://www.ovi.com).

#### Start using Ovi Contacts

Select **Contacts**, and open the Ovi tab.

The Ovi Contacts service is part of Ovi, and uses the same account information.

If you are new to Ovi and its services, to start using the Ovi Contacts application, you must register to Ovi by creating a Nokia account.

#### Create a Nokia account

- 1 Select **Ovi Chat**, and when prompted, connect to the internet.
- 2 Enter the required information.

- 3 In the My profile view, enter your profile information. Your first and last name are mandatory details.
- 4 Select **Done**.

If you have already registered to Ovi using your PC or mobile device, you can start using Ovi Contacts with the same account details.

#### Sign in to Ovi Contacts and activate the service

Select **Ovi Chat**, and enter your user name and password. When you have activated the Ovi Contacts service on your device, you can connect to the service directly from the home screen.

If you have not yet provided your profile information for Ovi Contacts, do so, and select **Done**. Your first and last name are mandatory details.

#### Connect to the service

Select **Menu** > **Contacts**, and open the Ovi tab.

#### Connect to Ovi Contacts

Select **Go online** and the connection method. Use a wireless LAN (WLAN) connection where available.

## Cancel the connection

Select **Options** > **Cancel connecting**.

A packet data connection may generate additional data transmission charges. For pricing details, contact your network service provider.

Select **Go online** > **Options** and from the following:

**Select** — Select the item.

**Go online** — Connect to the service if you are offline.

**My profile** — Edit your profile information.

**Recommend to friend** — Invite a contact to join Ovi Contacts. The invitation is sent as a text message.

**Settings** — Modify the Ovi Contacts settings.

The available options may vary.

## Create and edit your profile

### Edit your profile information

Select **My profile**.

## View the profiles of your Ovi Contacts friends

Select a friend and **Options** > **Profile**.

Your profile information is visible to your Ovi Contacts friends. Only the following profile details are displayed to other Ovi Contacts users, for example, during a search: first name and last name. To modify your privacy settings, access Ovi on your PC, and sign in to your Nokia account.

## Change your profile image

Select **Options** > **Edit image** > **Select existing image** and the new image. You can also edit or remove the current profile image or capture a new one.

## Change your availability

By default, your availability is set to **Available**. To change your availability, select the icon.

## Tell your friends what you are doing at the moment

Select **What are you doing?**, and enter text in the field.

### Show your friends what music you are currently listening to

Select **Now playing**. To do this, you must allow your now playing information to be shared in the presence settings.

### Edit your contact information

Select a field, and enter text.

In the My profile view, select **Options** and from the following:

**Edit** — Cut, copy, or paste text.

**Change** — Change your status (when the status field is selected).

**Activate** — Start broadcasting your location or your now playing information to your friends (when either field is selected).

**Undo changes** — Undo the changes you made in the profile view.

**Edit shared locations** — Select the landmarks you want to broadcast to your friends (when the My location field is selected).

**Stop sharing** — Stop broadcasting your location to your friends (when the My location field is selected).

The available options may vary.

### Broadcast your location to your friends

To broadcast your location, you must create landmarks in the presence settings and allow these to be shared. To receive location information from your friend, you must have the Maps application. To send and receive location information, both the Maps and Positioning applications are needed.

- 1 Select **My location**. If your location is unknown, select **My location > Add current location**.
- 2 Enter a name for the location. The location is broadcast to your friends and added to your landmarks list.

### Find and add friends

Select **Options > Invite friend**.

### Search for a friend

Enter the name of the friend in the Search friends field, and select **Search**. You cannot search for friends based on their mobile number or e-mail address.

### Browse the search results

Select **Next results** or **Previous results**.

### Start a new search

Select **New search**.

If the friends you searched for could not be found, they are not registered Ovi members, or they have chosen to be invisible in searches. When prompted, send a text message to your friends to invite them to join Ovi Contacts.

### Send an invitation to join Ovi Contacts

Select **Select service:** and the service you know your friend uses. Enter your friend's user name, and select **Invite**.

Select **Options** and from the following:

**Select** — Select an item.

**Open** — Open an item.

**Invite as friend** — Send an invitation to the contact.

**Show profile** — View the profile of the contact.

**Renew invitation** — Resend an invitation to join Ovi Contacts to a pending friend.

**Search** — Search for the contact whose name or other related keyword you entered in the Search friends field.

**Edit text** — Cut, copy, or paste text.

The available options may vary.

### Chat with your friends

#### Start a chat with a friend

Select **Options** > **Chat**.

#### Send a chat message

Enter the text in the message field, and select **Send**.

In the chat view, select **Options** and from the following:

**Send** — Send the message.

**Send file** — Send an image, video clip, audio file, or other file to your chat partner.

**Send my location** — Send your location details to your chat partner (if supported by both devices).

**Add smiley** — Insert a smiley.

**Profile** — View the details of a friend.

**My profile** — Select your presence status or profile image, personalise your message, or change your details.

**Edit text** — Copy or paste text.

**End chat** — End the active chat.

**Exit** — End all active chats, and close the application.

The available options may vary.

To receive location information from your friend, you must have the Maps application. To send and receive location information, both the Maps and Positioning applications are needed.

To receive any files, you or the recipient must accept the file. To cancel sending or receiving while the file is being transferred, select **Cancel**.

**View the location of your friend**

Select **Show on map**.

**Return to the Ovi Contacts main view without ending the chat**

Select **Back**.

**Add, call, or copy phone numbers from a chat**

Go to a phone number in a chat, and select **Options** and the appropriate option.

**Edit your landmarks**

To edit your landmarks, in the Landmarks view, select **Options** and from the following:

**Mark/Unmark** — Mark or unmark items on the list.

**Edit** — Edit the name and other properties of the landmark.

**New landmark** — To create a new landmark of your current position, select a location from a map, or enter the details manually.

**Ovi Contacts settings**

Select **Options** > **Settings** and from the following:

**Account** — Access your account details, and define your visibility to others in a search.

**Presence** — Share your current location with your friends, and let them see when you are making a phone call (call status).

**Personalisation** — Modify the settings related to the startup and tones of the Ovi Contacts application, and set your device to automatically accept friend invitations.

**Connection** — Select the network connection to use, and activate roaming warnings.

**Exit** — End all active chats, and close the application.

---

### Nokia account settings

Select **Options** > **Settings** > **Account**.

#### Edit your account details

Select **My account**.

#### Define your visibility in searches

Select **My account** > **Visibility in search**. You must be online to change your visibility.

---

### Presence settings

Select **Options** > **Settings** > **Presence**.

---

### Modify presence settings

Select from the following:

**Share my location** — Allow your friends to see your location.

**Share now playing** — Allow your friends to see what music you are currently listening to on your mobile device.

**Share call status** — Allow your friends to see your call status.

---

### Share your location

Select **Share my location** and from the following:

**Sharing allowed** — Allow your friends to see your location in selected landmarks.

**My shared landmarks** — Select the landmarks from where your location is broadcast to your friends.

**Refresh interval** — Select how often you broadcast your current location.

#### Add a location to the landmarks list

Select **Share my location** > **My shared landmarks** > **Options** > **New landmark**.

#### Add your current location as a landmark

Select **Current position**.

### Browse for a location on a map

Select **Select from map**.

### Add a landmark manually

Select **Enter manually**.

### Select locations you want to share with your friends

- 1 Select **Share my location > My shared landmarks**.
- 2 Select the landmarks from the list.
- 3 Select **Options** to edit, mark, and unmark items on the list.  
Depending on your settings, your friends can see your location when you are in one of the selected locations.

### Personalisation settings

---

Select **Options > Settings > Personalisation**.

Select from the following:

**Login on start-up** — Sign in automatically to Ovi Contacts when you switch on your mobile device.

**Auto-accept friend invit.** — Accept friend requests automatically without notification.

**Message tone** — Select a tone for new messages.

**Friend online tone** — Select the tone that sounds when a friend comes online.

**Icon on Home screen** — Add the Ovi Contacts shortcut icon to your device home screen.

### Connection settings

---

Select **Options > Settings > Connection**.

#### Modify connection settings

Select **Network connection** and the desired connection. To use the default connection defined in your device connection settings, select **Default connection**.

#### Set the device to notify you when your home network is not available

To receive a warning when your device is trying to connect to another network, select **Roaming warning > On**.

### Message reader

With Message reader you can listen to text, multimedia, audio, and e-mail messages.



To listen to new messages or e-mail, in the home screen, press and hold the left selection key until Message reader opens.

To listen to a message from your Inbox, scroll to the message, and select **Options** > **Listen**. To listen to an e-mail message from your mailbox, scroll to the message, and select **Options** > **Listen**. To stop the reading, press the end key.

To pause and continue the reading, press the scroll key. To skip to the next message, scroll right. To replay the current message or e-mail, scroll left. To skip to the previous message, scroll left at the beginning of the message.

To view the current message or e-mail in text format without the sound, select **Options** > **View**.

## Speech

Select **Menu** > **Ctrl. panel** > **Speech**.

With Speech, you can set the language, voice, and voice properties for the message reader.

To set the language for the message reader, select **Language**. To download additional languages to your device, select **Options** > **Download languages**.

When you download a new language, you must download at least one voice for that language.

To set the speaking voice, select **Voice**. The voice depends on the selected language.

To set the speaking rate, select **Speed**.

To set the speaking volume, select **Volume**.

To view the details of a voice, open the voice tab, and select the voice and **Options** > **Voice details**. To listen to a voice, select the voice and **Options** > **Play voice**.

To delete languages or voices, select the item and **Options** > **Delete**.

## Text and multimedia messages

Select **Menu** > **Messaging**.

Only devices that have compatible features can receive and display multimedia messages. The appearance of a message may vary depending on the receiving device.

A multimedia message (MMS) can contain text and objects such as images, sound clips, or video clips. Before you can send or receive multimedia messages on your device, you must define the multimedia message settings. Your device may recognise the SIM card provider and configure the correct multimedia message settings automatically. If not, contact your service provider for the correct settings, order the settings from your service provider in a configuration message, or use the Settings wizard application.

### Write and send messages

Select Menu > Messaging.

**Important:** Exercise caution when opening messages. Messages may contain malicious software or otherwise be harmful to your device or PC.

Before you can create a multimedia message or write an e-mail, you must

have the correct connection settings in place.

The wireless network may limit the size of MMS messages. If the inserted picture exceeds this limit, the device may make it smaller so that it can be sent by MMS.

Check the size limit of e-mail messages with your service provider. If you attempt to send an e-mail message that exceeds the size limit of the e-mail server, the message is left in the Outbox folder, and the device attempts to resend it periodically. Sending an e-mail requires a data connection, and continuous attempts to resend the e-mail may increase your data transfer costs. In the Outbox folder, you can delete such a message, or move it to the Drafts folder.

- 1 Select **New message**.
- 2 To send a text or multimedia message (MMS), select **Message**. To send a multimedia message that includes one sound clip, select **Audio message**. To send an e-mail, select **E-mail**.
- 3 In the To field, press the scroll key to select recipients or groups from the contacts list, or enter the

recipient's phone number or e-mail address. You can also copy and paste the number or address from the clipboard.

- 4 In the subject field, enter the subject of the message for a multimedia or an e-mail message. To hide or display fields when writing a text or multimedia message, select **Options** > **Message header fields**.
- 5 In the message field, write the message. To add a template or note to a text or multimedia message, select **Options** > **Insert content** > **Insert text** > **Template** or **Note**. To add a template to an e-mail message, select **Options** > **Insert template**.
- 6 To add a media file to a multimedia message, select **Options** > **Insert content**, the file type or source, and the desired file. To add a business card, slide, note, or other file to the message, select **Options** > **Insert content** > **Insert other**.
- 7 To capture an image or record a video or sound clip for a multimedia message, select **Options** > **Insert content** > **Insert image** > **New**,

**Insert video clip** > **New**, or **Insert sound clip** > **New**.

- 8 To insert a smiley to a text or multimedia message, press the sym key, and select the smiley.
- 9 To add an attachment to an e-mail, select **Options** > **Add attachment**, the memory, and the file to attach.  indicates an e-mail attachment.
- 10 To send the message, select **Options** > **Send**, or press the call key.

The available options may vary.

**Note:** The message sent icon or text on your device screen does not indicate that the message is received at the intended destination.

Your device supports text messages beyond the limit for a single message. Longer messages are sent as two or more messages. Your service provider may charge accordingly. Characters with accents, other marks, or some language options take more space, and limit the number of characters that can be sent in a single message.

You may not be able to send video clips that are saved in the MP4 file format or that exceed the size limit of the wireless network in a multimedia message.

### Text messages on the SIM card

Select **Menu > Messaging and Options > SIM messages.**

Text messages may be stored on your SIM card. Before you can view SIM messages, you must copy the messages to a folder in the device. After copying the messages to a folder, you can view them in the folder or delete them from the SIM card.

- 1 Select **Options > Mark/Unmark > Mark** or **Mark all** to mark every message.
- 2 Select **Options > Copy.**
- 3 Select a folder and **OK** to begin copying.

To view SIM card messages, open the folder where you copied the messages, and open a message.

### Receive and reply to multimedia messages

**Important:** Exercise caution when opening messages. Messages may contain malicious software or otherwise be harmful to your device or PC.

**Tip:** If you receive multimedia messages that contain objects unsupported by your device, you cannot open them. Try to send these objects to another device such as a computer, and open them there.

- 1 To reply to a multimedia message, open the message, and select **Options > Reply.**
- 2 Select **To sender** to reply to the sender, **To all** to reply to everyone included in the received message, **Via audio message** to reply with an audio message, or **Via e-mail** to reply with an e-mail message. E-mail message is available only if a mailbox is configured and the message is sent from an e-mail address.
- 3 Enter the text of the message, and select **Options > Send.**

## Create presentations

Select **Menu > Messaging**.

Creating multimedia presentations is not possible if **MMS creation mode** is set to **Restricted**. To change the setting, select **Options > Settings > Multimedia message > MMS creation mode > Free or Guided**.

- 1 To create a presentation, select **New message > Message**. The message type is changed to multimedia message based on the inserted content.
- 2 In the To field, enter a recipient's number or e-mail address, or press the scroll key to add a recipient from the contacts list. If you enter more than one number or e-mail address, separate them with a semicolon.
- 3 Select **Options > Insert content > Insert presentation** and a presentation template. A template may define which media objects you can include in the presentation, where they appear, and which effects are displayed between images and slides.
- 4 Scroll to the text area, and enter the text.

- 5 To insert images, sound or video clips, or notes in your presentation, scroll to the corresponding object area, and select **Options > Insert content**.
- 6 To add slides, select **Options > Insert content > New slide**.

To select the background colour for the presentation and background images for different slides, select **Options > Background settings**.

To set effects between images or slides, select **Options > Effect settings**.

To preview the presentation, select **Options > Preview**. Multimedia presentations may only be viewed in compatible devices that support presentations. They may appear different in different devices.

## View presentations

To view a presentation, open the multimedia message from the Inbox folder. Scroll to the presentation, and press the scroll key.

To pause the presentation, press either selection key.

To resume playing the presentation, select **Options** > **Continue**.

If the text or images are too large to fit on the display, select **Options** > **Activate scrolling**, and scroll to see the entire presentation.

To find phone numbers and e-mail or web addresses in the presentation, select **Options** > **Find**. You may use these numbers and addresses to make calls, send messages, or create bookmarks, for example.

### View and save multimedia attachments

To view multimedia messages as complete presentations, open the message, and select **Options** > **Play presentation**.

**Tip:** To view or play a multimedia object in a multimedia message, select **View**

**image**, **Play sound clip**, or **Play video clip**.

To view the name and size of an attachment, select the message and **Options** > **Objects**.

To save a multimedia object, select **Options** > **Objects**, the object, and **Options** > **Save**.

### Special message types

Select **Menu** > **Messaging**.

You can receive special messages that contain data, such as operator logos, ringing tones, bookmarks, or internet access or e-mail account settings.

To save the contents of these messages, select **Options** > **Save**.

### Service messages

Service messages are sent to your device by service providers. Service messages may contain notifications such as news headlines, services, or links through which the message content can be downloaded.

To define the service message settings, select **Options > Settings > Service message**.

To download the service or message content, select **Options > Download message**.

To view information about the sender, web address, expiration date, and other details of the message before downloading it, select **Options > Message details**.

### Send service commands

You can send a service request message (also known as a USSD command) to your service provider and request activation for certain network services. Contact your service provider for the service request text.

To send a service request message, select **Options > Service commands**. Enter the service request text and select **Options > Send**.

### Cell broadcast

Select **Menu > Messaging and Options > Cell broadcast**.

With the cell broadcast network service, you can receive messages on various topics from your service provider, such as weather or traffic conditions in a particular region. For available topics and relevant topic numbers, contact your service provider. Cell broadcast messages cannot be received when the device is in the remote SIM mode. A packet data (GPRS) connection may prevent cell broadcast reception.

Cell broadcast messages cannot be received in UMTS (3G) networks.

To receive cell broadcast messages, you may need to turn cell broadcast reception on. Select **Options > Settings > Reception > On**.

To view messages related to a topic, select the topic.

To receive messages related to a topic, select **Options > Subscribe**.

**Tip:** You can set important topics as hot topics. You are notified in the home screen, when you receive a message related to a hot topic. Select a topic and **Options > Hotmark**.

To add, edit, or delete topics, select **Options > Topic**.

### Messaging settings

Select **Menu > Messaging and Options > Settings**.

Open the message type in question, and define all fields marked with **Must be defined** or with a red asterisk.

Your device may recognise the SIM card provider and configure the correct text message, multimedia message, and GPRS settings automatically. If not, contact your service provider for the correct settings, order the settings from your service provider in a configuration message, or use the Settings wizard application.

### Text message settings

Select **Menu > Messaging and Options > Settings > Text message**.

Select from the following:

**Message centres** — View the available message centres for your device, or add a new one.

**Message centre in use** — Select a message centre to send the message.

**Character encoding** — Select **Reduced support** to use automatic character conversion to another encoding system when available.

**Receive report** — Select **Yes** if you want the network to send you delivery reports on your messages (network service).

**Message validity** — Select how long the message centre resends your message if the first attempt fails (network service). If the recipient cannot be reached within the validity period, the message is deleted from the message centre.

**Message sent as** — Convert the message to another format, for example, fax or e-mail. Change this option only if you are sure that your message centre is able to convert text messages into these other formats. For more information, contact your service provider.



**Preferred connection** — Select the preferred method of connection when sending text messages from your device.

**Reply via same centre** — Select whether you want the reply message to be sent using the same text message centre number (network service).

### Multimedia message settings

Select **Menu > Messaging and Options > Settings > Multimedia message**.

Select from the following:

**Image size** — Scale images in multimedia messages.

**MMS creation mode** — Select **Restricted** to set your device to prevent you from including content in multimedia messages that may not be supported by the network or the receiving device. To receive warnings about including such content, select **Guided**. To create a multimedia message with no restrictions on attachment type, select **Free**. If you select **Restricted**, creating multimedia presentations is not possible.

**Access point in use** — Select the default access point to connect to the multimedia message centre. You may not be able to change the default access point if it is preset in your device by your service provider.

**Multimedia retrieval** — Select how you want to receive messages, if available. Select **Always automatic** to receive multimedia messages always automatically, **Auto in home netw.** to receive notification of a new multimedia message that you can retrieve from the message centre (for example, when you are travelling abroad and are outside your home network), **Manual** to retrieve multimedia messages from the message centre manually, or **Off** to prevent receipt of any multimedia messages. Automatic retrieval may not be supported in all regions.

**Allow anonymous msgs.** — Receive messages from unknown senders.

**Receive adverts** — Receive messages defined as advertisements.

**Receive reports** — Request for delivery and read reports of sent messages (network service). Receiving a delivery report of a multimedia message that

has been sent to an e-mail address may not be possible.

**Deny report sending** — Select **Yes** to not send delivery reports from your device for received multimedia messages.

**Message validity** — Select how long the messaging centre tries to send the message (network service). If the recipient of a message cannot be reached within the validity period, the message is removed from the multimedia messaging centre.

**Maximum time** is the maximum amount of time allowed by the network.

The device requires network support to indicate that a sent message has been received or read. Depending on the network and other circumstances, this information may not always be reliable.

### Service message settings

Select **Menu > Messaging and Options > Settings > Service message**.

To allow your device to receive service messages from your service provider, select **Service messages > On**.

To select how to download services and service message content, select **Download messages > Automatically or Manually**. If you select **Automatically**, you may still need to confirm some downloads since not all services can be downloaded automatically.

### Cell broadcast settings

Select **Menu > Messaging and Options > Settings > Cell broadcast**.

To receive cell broadcast messages, select **Reception > On**.

To select the languages in which you want to receive cell broadcast messages, select **Language**.

To display new topics in the cell broadcast topics list, select **Topic detection > On**.

### Other settings

Select **Menu > Messaging and Options > Settings > Other**.

Select from the following:

**Save sent messages** — Select whether to save sent messages in the Sent folder.

**Number of saved msgs.** — Enter the number of sent messages to save. When the limit is reached, the oldest message is deleted.

**Memory in use** — Select where to save your messages. You can save messages to the memory card only if a memory card is inserted.

**Folder view** — Select if you want to see folder information on one or two lines.

### About Chat

With IM (network service), you can exchange instant messages with your friends. You can access several chat services or communities simultaneously and switch between them. If you want to, for example, browse the web, you can leave the IM application to run in the background, and still be notified of new instant messages.

The IM application is preinstalled on your device. To start chatting, select **Menu > Applications > Chat**.

Using network services and downloading content to your device may result in data traffic costs.

## Connectivity

Your device offers several options to connect to the internet or to another compatible device or computer.

### Data connections and access points

Your device supports packet data connections (network service), such as GPRS in the GSM network. When you use your device in GSM and UMTS networks, multiple data connections can be active at the same time, and access points can share a data connection. In the UMTS network, data connections remain active during voice calls.

You can also use a WLAN data connection. Only one connection in one wireless LAN can be active at a time, but several applications can use the same internet access point.

To establish a data connection, an access point is required. You can define different kinds of access points, such as the following:

- MMS access point to send and receive multimedia messages

- Internet access point (IAP) to send and receive e-mail and connect to the internet

Check the type of access point you need with your service provider for the service you want to access. For availability and subscription to packet data connection services, contact your service provider.

### Network settings

Your device can automatically switch between GSM and 3G networks. The GSM network is indicated with **G** in the standby mode. The 3G network is indicated with **3G**.

Select **Menu > Ctrl. panel > Settings and Phone > Network** and from the following:

**Network mode** — Select which network to use. If you select **Dual mode**, the device uses the GSM or 3G network automatically, according to the network parameters and the roaming agreements between the wireless service providers. For details and roaming costs, contact your network service provider. This option is shown

only if supported by the wireless service provider.

A roaming agreement is an agreement between two or more service providers to enable the users of one service provider to use the services of other service providers.

**Operator selection** — Select **Automatic** to set the device to search for and select one of the available networks, or **Manual** to manually select the network from a list. If the connection to the manually selected network is lost, the device sounds an error tone and asks you to reselect a network. The selected network must have a roaming agreement with your home cellular network.

**Cell info display** — Set the device to indicate when it is used in a cellular network based on microcellular network (MCN) technology and to activate cell info reception.

### Wireless LAN

Your device can detect and connect to wireless local area networks (WLAN). Using a WLAN, you can connect your device to the internet and compatible devices that have WLAN support.

## About WLAN

To use a wireless local area network (WLAN) connection, it must be available in the location, and your device must be connected to the WLAN. Some WLANs are protected, and you need an access key from the service provider to connect to them.

**Note:** Using WLAN may be restricted in some countries. For example, in France, you are only allowed to use WLAN indoors. For more information, contact your local authorities.

Features that use WLAN, or that are allowed to run in the background while using other features, increase the demand on battery power and reduce the battery life.

Use encryption to increase the security of your WLAN connection. Using encryption reduces the risk of others accessing your data.

## WLAN connections

To use a wireless LAN (WLAN) connection, you must create an internet access point (IAP) for WLAN. Use the access point for applications that need to connect to the internet.

A WLAN connection is established when you create a data connection using a WLAN internet access point. The active WLAN connection ends when you end the data connection.

You can use WLAN during a voice call or when packet data is active. You can only be connected to one WLAN access point device at a time, but several applications can use the same internet access point.

When the device is in the offline profile, you can still use WLAN (if available). Remember to comply with any applicable safety requirements when establishing and using a WLAN connection.

**Tip:** To check the unique media access control (MAC) address that identifies your device, enter **\*#62209526#** in the home screen.

## WLAN wizard

Select **Menu > Ctrl. panel > Connectivity > WLAN wiz..**

The WLAN wizard helps you to connect to a wireless LAN (WLAN) and manage your WLAN connections.

If the search finds WLANs, to create an internet access point (IAP) for a connection and start the web browser using this IAP, select the connection and **Start web browsing**.

If you select a secured WLAN, you are asked to enter the relevant password. To connect to a hidden network, you must enter the correct network name (service set identifier, SSID).

If you already have the web browser running using the currently active WLAN connection, to return to the web browser, select **Cont.web browsing**.

To end the active connection, select the connection and **Disconnect WLAN**.

### WLAN internet access points

Select **Menu > Ctrl. panel > Connectivity > WLAN wiz. and Options**.

Select from the following:

**Filter WLAN networks** — Filter out wireless LANs (WLANs) from the list of found networks. The selected networks

are not displayed the next time the application searches for WLANs.

**Details** — View the details of a network shown in the list. If you select an active connection, the connection details are displayed.

### Operating modes

There are two operating modes in WLAN: infrastructure and ad hoc.

The infrastructure operating mode allows two kinds of communication: wireless devices are connected to each other through a WLAN access point device, or wireless devices are connected to a wired LAN through a WLAN access point device.

In the ad hoc operating mode, devices can send and receive data directly with each other.

### WLAN settings

Select **Menu > Ctrl. panel > Settings and Connection > Wireless LAN**.

To have an indicator displayed when there is a wireless LAN (WLAN) available in your current location, select **Show WLAN availability > Yes**.

To select the interval for your device to scan for available WLANs, and to update the indicator, select **Scan for networks**. This setting is not available unless you select **Show WLAN availability > Yes**.

To set the device to test the internet capability of the selected WLAN automatically, to ask for permission every time, or to never perform the connectivity test, select **Internet connectivity test > Run automatically, Ask every time, or Never run**. If you select **Run automatically** or allow the test to be performed when the device asks for it, and the connectivity test is performed successfully, the access point is saved to internet destinations.





To check the unique media access control (MAC) address that identifies your device, enter **\*#62209526#** in the home screen. The MAC address is displayed.

## Access points

### Create a new access point

Select **Menu > Ctrl. panel > Settings and Connection > Destinations**.

You may receive access point settings in a message from a service provider. Some or all access points may be preset for your device by your service provider, and you may not be able to change, create, edit, or remove them.

When you select one of the access point groups (, , , , ) you can see the access point types:



indicates a protected access point



indicates a packet data access point



indicates a wireless LAN (WLAN) access point

**Tip:** You can create internet access points in a WLAN with the WLAN wizard.

To create a new access point, select  **Access point**.

The device asks to check for available connections. After the search, connections that are already available

are displayed and can be shared by a new access point.

If you skip this step, you are asked to select a connection method and to define the settings needed.

To edit the settings of an access point, select one of the access point groups, scroll to an access point, and select **Options** > **Edit**. Use the instructions provided by your service provider to edit the following:

**Connection name** — Enter a name for the connection.

**Data bearer** — Select the data connection type.

Depending on the data connection you select, only certain setting fields are available. Fill in all fields marked with **Must be defined** or with a red \*. Other fields can be left empty, unless your service provider has instructed otherwise.

To use a data connection, your service provider must support this feature, and if necessary, activate it for your SIM card.

### Create access point groups

Select **Menu** > **Ctrl. panel** > **Settings and Connection** > **Destinations**.

Some applications allow you to use access point groups to connect to a network.

To avoid selecting which access point to use every time the device attempts to connect to a network, you can create a group that contains various access points, and define the order in which the access points are used to connect to a network.

For example, you can add wireless LAN (WLAN) and packet data access points to an internet access point group and use the group for browsing the web. If you give the WLAN access point the higher priority, the device connects to the internet through a WLAN if available and through a packet data connection if not.

To create a new access point group, select **Options** > **Manage** > **New destination**.



To add access points to an access point group, select the group and **Options** > **New access point**. To copy an existing access point from another group, select the group, scroll to an existing access point, and select **Options** > **Organise** > **Copy to other dest..**

To change the priority order of access points within a group, scroll to an access point, and select **Options** > **Organise** > **Change priority**.

### Packet data access points

Select **Menu** > **Ctrl. panel** > **Settings and Connection** > **Destinations** > **Access point**, and follow the instructions on the screen.

To edit a packet data access point, open one of the access point groups, and select an access point marked with



Follow the instructions from your service provider.

Select from the following:

**Connection name** — Define a name for the connection.

**Data bearer** — You might not be able to edit the data bearer once defined. Define a new access point if needed.

**Access point name** — You obtain the access point name from your service provider.

**User name** — The user name may be needed to make a data connection, and is usually provided by your service provider.

**Prompt password** — If you must enter the password every time you log in to a server, or if you do not want to save your password in the device, select **Yes**.

**Password** — A password may be needed to make a data connection and is usually provided by your service provider.

**Authentication** — Select **Secure** to always send your password encrypted or **Normal** to send your password encrypted when possible.

**Homepage** — Depending on the access point you are setting up, enter the web address or the address of the multimedia message centre.

**Use access point** — Select **After confirmation** if you want the device to ask for confirmation before the connection using this access point is

created, or **Automatically** if you want the device to connect to the destination using this access point automatically.

Select **Options** > **Advanced settings** and from the following:

**Network type** — Select the internet protocol type to transfer data to and from your device. The other settings depend on the selected network type.

**Phone IP address** (for IPv4 only) — Enter the IP address of your device.

**DNS addresses** — Enter the IP addresses of the primary and secondary DNS servers, if required by your service provider. To obtain these addresses, contact your internet service provider.

**Proxy server address** — Enter the address of the proxy server.

**Proxy port number** — Enter the port number of the proxy server.

### WLAN internet access points

Select **Menu** > **Ctrl. panel** > **Settings** and **Connection** > **Destinations** > **Access point**, and follow the instructions on the display. Or, open one of the access point groups, select an

access point marked with , and select **Edit**.

Use the instructions provided by your service provider to edit the following:

**Connection name** — Define a name for the connection.

**Data bearer** — You might not be able to edit the data bearer once defined. Define a new access point if needed.

**WLAN network name** — Select **Enter manually** or **Search for networks**. If you select an existing network, **WLAN network mode** and **WLAN security mode** are determined by the settings of its access point device.

**Network status** — Define whether the network name is displayed.

**WLAN network mode** — Select **Ad-hoc** to create an ad hoc network, and to allow devices to send and receive data directly; a WLAN access point device is not needed. In an ad hoc network, all devices must use the same WLAN network name.

**WLAN security mode** — Select the encryption used: **WEP**, **802.1x**, or **WPA/WPA2**. (802.1x and WPA/WPA2 are not available for ad hoc networks.) If you

select **Open network**, no encryption is used. The WEP, 802.1x, and WPA functions can be used only if the network supports them.

**Use access point** — Select **After confirmation** to set the device to ask for confirmation before the connection using this access point is created or **Automatically** to set the device to connect to the destination using this access point automatically.

To enter the settings for the selected security mode, select **WLAN security settings**.

### Advanced WLAN settings

Select **Options** > **Advanced settings** and from the following:

**IPv4 settings** — Enter the IP address of your device, the subnet IP address, the default gateway, and the IP addresses of the primary and secondary DNS servers. Contact your internet service provider for these addresses.

**IPv6 settings** — Define the type of DNS address.

**Ad-hoc channel** (only for ad hoc networks) — To enter a channel

number (1-11) manually, select **User defined**.

**Proxy server address** — Enter the address for the proxy server.

**Proxy port number** — Enter the proxy port number.

### Active data connections

Select **Menu** > **Ctrl. panel** > **Connectivity** > **Conn. mgr..**

Select **Active data connections**.

In the active data connections view, you can see the open data connections:



data calls

packet data connections

wireless LAN (WLAN)  
connections

**Note:** The actual invoice for calls and services from your service provider may vary, depending on network features, rounding off for billing, taxes, and so forth.

To end a connection, select **Options** > **Disconnect**.

To close all open connections, select **Options > Disconnect all**.

To view the details of a connection, select **Options > Details**.

### Sync

Select **Menu > Ctrl. panel > Connectivity > Sync**.

Sync enables you to synchronise your notes, calendar entries, text and multimedia messages, browser bookmarks, or contacts with various compatible applications on a compatible computer or on the internet.

You may receive synchronisation settings in a special message from your service provider.

A synchronisation profile contains the necessary settings for synchronisation.

When you open the Sync application, the default or previously used sync profile is displayed. To modify the profile, scroll to a sync item, and select **Mark** to include it in the profile or **Unmark** to leave it out.

To manage sync profiles, select **Options** and the desired option.

To synchronise data, select **Options > Synchronise**.

To cancel synchronisation before it finishes, select **Cancel**.

### Bluetooth connectivity About Bluetooth connectivity

With Bluetooth connectivity, you can make a wireless connection to other compatible devices, such as mobile phones, computers, headsets, and car kits.

You can use the connection to send images, video clips, music and sound clips, and notes, transfer files from your compatible PC, and print images with a compatible printer.

Since devices with Bluetooth wireless technology communicate using radio waves, they do not need to be in direct line-of-sight. However, they must be within 10 metres (33 feet) of each other, although the connection may be subject to interference from obstructions such

as walls or from other electronic devices.

This device is compliant with Bluetooth Specification 2.0 + EDR supporting the following profiles: Advanced Audio Distribution, Audio Video Remote Control, Basic Imaging, Basic Printing, Dial-up Networking, File Transfer, Generic Access, Hands-free, Headset, Human Interface Device, Object Push, Phone Book Access, SIM Access, Serial Port, Service Discovery Application, Generic Object Exchange. To ensure interoperability between other devices supporting Bluetooth technology, use Nokia approved accessories for this model. Check with the manufacturers of other devices to determine their compatibility with this device.

Features using Bluetooth technology increase the demand on battery power and reduce the battery life.

When the device is locked, only connections to authorised devices are possible.

### Bluetooth settings

Select **Menu > Ctrl. panel > Settings and Connectivity > Bluetooth.**

Select from the following:

**Bluetooth** — Activate Bluetooth connectivity.

**My phone's visibility** — To allow your device to be visible to other Bluetooth devices, select **Shown to all**. To set a length of time, after which the visibility is set from shown to hidden, select **Define period**. To hide your device from other devices, select **Hidden**.

**My phone's name** — Edit the name of your device. The name is shown to other Bluetooth devices.

**Remote SIM mode** — Allow another device, such as a compatible car kit accessory, to use the SIM card in your device to connect to the network.

### Security tips

Select **Menu > Ctrl. panel > Settings and Connectivity > Bluetooth.**

When you are not using Bluetooth connectivity, to control who can find your device and connect to it, select **Bluetooth > Off** or **My phone's visibility > Hidden**. Deactivating the Bluetooth function does not affect other functions in your device.

Do not pair with or accept connection requests from an unknown device. This helps to protect your device from harmful content. Operating the device in hidden mode is a safer way to avoid malicious software.

### Send data using Bluetooth connectivity

Several Bluetooth connections can be active at a time. For example, if you are connected to a compatible headset, you can also transfer files to another compatible device at the same time.

- 1 Open the application where the item you want to send is stored.
- 2 Scroll to an item, and select **Options > Send > Via Bluetooth**.

Devices with Bluetooth wireless technology that are within range are displayed. Device icons are as follows:



computer



phone



audio or video device



other device

To interrupt the search, select **Stop**.

- 3 Select the device with which you want to connect.
- 4 If the other device requires pairing before data can be transmitted, a tone sounds, and you are asked to enter a passcode. The same passcode must be entered in both devices.

When the connection is established, **Sending data** is displayed.

**Tip:** When searching for devices, some devices may show only the unique address (device address). To find the unique address of your device, enter **\*#2820#**.

### Pair devices

To pair with compatible devices and view your paired devices, in the main view of Bluetooth connectivity, scroll right.

Before pairing, create your own passcode (1 to 16 digits), and agree with the owner of the other device to use the same code. Devices that do not have a user interface have a factory-set passcode. The passcode is used only once.

- 1 To pair with a device, select **Options > New paired device**. Devices that are within range are displayed.
- 2 Select the device, and enter the passcode. The same passcode must be entered on the other device as well.
- 3 Some audio enhancements connect automatically to your device after pairing. Otherwise, scroll to the enhancement, and select **Options > Connect to audio device**.

Paired devices are indicated by  in the device search.

To set a device as authorised or unauthorised, scroll to the device, and select from the following options:



**Set as authorised** — Connections between your device and the authorised device can be made without your knowledge. No separate acceptance or authorisation is needed. Use this status for your own devices, such as your compatible headset or PC or devices that belong to someone you trust.  indicates authorised devices in the paired devices view.

**Set as unauthorised** — Connection requests from this device must be accepted separately every time.

To cancel a pairing, scroll to the device, and select **Options > Delete**.

If you want to cancel all pairings, select **Options > Delete all**.

### Receive data using Bluetooth connectivity

When you receive data through Bluetooth connectivity, a tone sounds, and you are asked if you want to accept the message. If you accept,  is displayed, and the item is placed in the Inbox folder in Messaging. Messages received through Bluetooth connectivity are indicated by .

**Tip:** If your device notifies you that the memory is full when you try to receive data through Bluetooth connectivity, change memory card as the memory where the data is stored.

### Block devices

You can prevent devices from establishing a Bluetooth connection to your device.

Select **Menu > Ctrl. panel > Settings and Connectivity > Bluetooth.**

### Block a device

On the Paired devices tab, go to a device you want to block, and select **Options > Block.**

### Unblock a device

On the Blocked devices tab, go to a device, and select **Options > Delete.**

### Unblock all blocked devices

Select **Options > Delete all.**

If you reject a pairing request from another device, you are asked if you want to block all future connection requests from this device. If you accept the query, the device is added to the list of blocked devices.

### Remote SIM mode

Before the remote SIM mode can be activated, the two devices must be paired and the pairing initiated from

the other device. When pairing, use a 16-digit passcode, and set the other device as authorised.

To use the remote SIM mode with a compatible car kit enhancement, activate Bluetooth connectivity, and enable the use of the remote SIM mode with your device.

Activate the remote SIM mode from the other device.

When the remote SIM mode is on in your device, **Remote SIM mode** is displayed in the standby mode. The connection to the wireless network is turned off, as indicated by **X** in the signal strength indicator area, and you cannot use SIM card services or features requiring cellular network coverage.

When the wireless device is in the remote SIM mode, you can only use a compatible connected enhancement, such as a car kit, to make or receive calls. Your wireless device will not make any calls while in this mode, except to the emergency numbers programmed into your device. To make calls from your device, you must leave the remote SIM



mode. If the device is locked, enter the lock code to unlock it.

To leave the remote SIM mode, press the power key, and select **Exit remote SIM mode**.

### Data cable

To avoid corrupting data, do not disconnect the USB data cable during data transfer.

### Transfer data between your device and a PC

- 1 Insert a memory card in your device, and connect the device to a compatible PC with the data cable.
- 2 When the device asks which mode to use, select **Mass storage**. In this mode, you can see your device as a removable hard drive in your computer.
- 3 End the connection from the computer (from the Unplug or Eject Hardware wizard in Microsoft Windows, for example) to avoid damaging the memory card.

To use Nokia Ovi Suite with your device, install Nokia Ovi Suite on your PC,

connect the data cable, and select **PC Suite** as the USB connection mode.

To synchronise the music in your device with Nokia Ovi Player, install the Nokia Ovi Player software on your PC, connect the data cable, and select **PC Suite** as the USB connection mode.

To change the USB mode you normally use with the data cable, select **Menu > Ctrl. panel > Connectivity > USB and USB connection mode**, and the desired option.

To set the device to ask for the mode each time you connect the data cable to the device, select **Menu > Ctrl. panel > Connectivity > USB and Ask on connection > Yes**.

### PC connections

You can use your mobile device with a variety of compatible PC connectivity and data communications applications. With Nokia Ovi Suite you can, for example, transfer files and images between your device and a compatible computer.

To use Ovi Suite with USB connection mode, select **PC Suite**.

For more information about Ovi Suite, see the support area at [www.ovi.com](http://www.ovi.com).

### About home network

With home network, you can share and synchronise media files in your mobile device with other devices, such as a computer, sound system, or television. You can also view and play media files from other home network devices on your device or on other compatible devices. For example, you can play music stored in your device using a home stereo system certified by the Digital Living Network Alliance (DLNA), controlling the playlists and volume levels directly from your device.

Your device is compatible with Universal Plug and Play (UPnP) and certified by the Digital Living Network Alliance. You can create a home network with a wireless LAN (WLAN) access point device or router. You can connect compatible WLAN enabled and DLNA certified UPnP devices to the network.

### Examples of compatible devices

- Mobile device

- Compatible computer
- Television
- Sound system
- Compatible wireless multimedia receiver, connected to a sound system

You can also store your media files to a media server or retrieve media files from a compatible home server.

To use the WLAN function of your device in a home network, you must have a working WLAN home connection.

The home network uses the security settings of the WLAN connection. Use the home network feature in a WLAN infrastructure network with a WLAN access point device and encryption enabled.

### Internet

With the Web browser, you can view hypertext markup language (HTML) web pages on the internet as originally designed. You can also browse web pages that are designed specifically for mobile devices, and use extensible

hypertext markup language (XHTML), or the wireless markup language (WML).

To browse the web, you need to have an internet access point configured in your device. Using the web browser requires network support.

## Browse the web

With the Browser application, you can browse web pages.

Select **Menu** > **Internet** > **Web**.

**Shortcut:** To open the browser, press and hold **0** (zero) in the home screen.

## Go to a web page

In the bookmarks view, select a bookmark, or start entering a web address (the  field opens automatically), and select **Go to**.

Some web pages may contain material, such as video clips, that requires a large amount of memory to view. If your device runs out of memory while loading such a web page, insert a memory card. Otherwise, the video clips are not displayed.

## Disable graphics to save memory and speed up downloading

Select **Options** > **Settings** > **Page** > **Load content** > **Text only**.

## Refresh the content of the web page

Select **Options** > **Web page options** > **Reload**.

## View snapshots of web pages you have visited

Select **Back**. A list of pages you have visited during the current browsing session opens. This option is available if **History list** is activated in the browser settings.

## Block or allow the automatic opening of multiple windows

Select **Options** > **Web page options** > **Block pop-ups** or **Allow pop-ups**.

## View the shortcut keys

Select **Options** > **Keypad shortcuts**. To edit the shortcut keys, select **Edit**.

## Zoom in and out on a web page

To zoom in, press **\***. To zoom out, press **#**.

**Tip:** To send the browser to the background without exiting the application or closing the connection, press the end key once.

### Browser toolbar

The browser toolbar helps you select frequently used functions of the browser.

#### Open the toolbar

Press and hold the scroll key on a blank area of a web page.

#### Move within the toolbar

Scroll left or right.

#### Select a feature from the toolbar

Press the scroll key

From the toolbar, select from the following:

 **Go to web address** — Enter a web address.

 **Recently visited pages** — View a list of the web addresses you visit frequently.

 **Bookmarks** — Open the bookmarks view.

 **Full screen** — View the web page in full screen.

 **Page overview** — Display an overview of the current web page.

 **Search by keyword** — Search the current web page.

 **Settings** — Modify the web browser settings.

### Navigate pages

Mini Map and Page overview help you navigate web pages that contain a large amount of information.

To activate Mini Map, select **Options > Settings > General > Mini map > On**.

When you scroll through a large web page, Mini Map opens and shows an overview of the page.

To move in Mini Map, scroll left, right, up, or down. When you find the desired location, stop scrolling. Mini Map disappears and leaves you at the selected location.

When you are browsing a web page that contains a large amount of information, you can also use Page overview to view

what kind of information the web page contains.

To display an overview of the current web page, press **8**.

To scroll around the overview, use the scroll key.

To zoom in on a section, scroll to the section, and select **OK**.

### Web feeds and blogs

With web feeds, you can easily follow news headlines and your favourite blogs.

Select **Menu > Internet > Web**.

Web feeds are XML files on web pages. They are used to share, for example, the latest news headlines or blogs. It is common to find web feeds on web, blog, and wiki pages.

The browser application automatically detects if a web page contains web feeds.

**Subscribe to a web feed when a feed is available on the page**

Select **Options > Subscribe to web feeds**.

**Update a web feed**

In the Web feeds view, select a feed and **Options > Web feed options > Refresh**.

**Set automatic update for all web feeds**

In the Web feeds view, select **Options > Edit > Edit**. This option is not available if one or more feeds are marked.

### Content search

Select **Menu > Internet > Web**.

To search for text, phone numbers, or e-mail addresses within the current web page, select **Options > Find keyword** and the appropriate option.

To go to the next match, scroll down.

To go to the previous match, scroll up.

**Tip:** To search for text within the current web page, press **2**.

### Bookmarks

You can store your favourite web pages in Bookmarks for instant access.

Select **Menu > Internet > Web**.

#### Access bookmarks

- 1 If you have a page other than Bookmarks as your homepage, select **Options > Go to > Bookmarks**.
- 2 Select a web address from the list or from the collection of bookmarks in the Recently visited pages folder.

#### Save the current web page as a bookmark

While browsing, select **Options > Web page options > Save as bookmark**.

#### Edit or delete bookmarks

Select **Options > Bookmark manager**.

#### Send or add a bookmark, or set a bookmarked web page as the homepage

Select **Options > Bookmark options**.

### Empty the cache

Emptying the cache memory helps you keep your data secure. The information or services you have accessed are stored in the cache memory of the device. If you have accessed or tried to access confidential information requiring passwords, empty the cache after each browsing session.

Select **Options > Clear privacy data > Cache**.

### End the connection

To end the connection and close the browser, select **Options > Exit**.

To delete the information the network server collects about your visits to various web pages, select **Options > Clear privacy data > Cookies**.

### Connection security

If the security indicator () is displayed during a connection, the data transmission between the device and the internet gateway or server is encrypted.

The security icon does not indicate that the data transmission between the gateway and the content server (where the data is stored) is secure. The service provider secures the data transmission between the gateway and the content server.

Security certificates may be required for some services, such as banking services. You are notified if the identity of the server is not authentic or if you do not have the correct security certificate in your device. For more information, contact your service provider.

**Important:** Even if the use of certificates makes the risks involved in remote connections and software installation considerably smaller, they must be used correctly in order to benefit from increased security. The existence of a certificate does not offer any protection by itself; the certificate manager must contain correct, authentic, or trusted certificates for increased security to be available. Certificates have a restricted lifetime. If "Expired certificate" or "Certificate not valid yet" is shown, even if the certificate should be valid, check that

the current date and time in your device are correct.

Before changing any certificate settings, you must make sure that you really trust the owner of the certificate and that the certificate really belongs to the listed owner.

### Web settings

Select **Menu > Internet > Web and Options > Settings** and from the following:

#### General settings

**Access point** — Change the default access point. Some or all access points may be preset for your device by your service provider. You may not be able to change, create, edit, or remove them.

**Homepage** — Define the homepage.

**Mini map** — Turn Mini Map on or off. Mini Map helps with web page navigation.

**History list** — If you select **On**, while browsing, to see a list of the pages you have visited during the current session, select **Back**.

**Web address suffix** — Enter a web address suffix that the device uses by

default when you enter a web address in the Go to field (for example, .com or .org).

**Security warnings** — Hide or show security notifications.

**Java/ECMA script** — Enable or disable the use of scripts.

**Java/ECMA script errors** — Select whether you want to receive script notifications.

### Page settings

---

**Load content** — Select whether you want to load images and other objects while browsing. If you select **Text only**, to load images or objects later during browsing, select **Options > Display options > Load images**.

**Default encoding** — If text characters are not shown correctly, you can select another encoding according to the language for the current page.

**Block pop-ups** — Allow or block automatic opening of different pop-ups while browsing.

**Automatic reload** — Select whether you want the web pages to be refreshed automatically while browsing.

**Font size** — Define the font size that is used for web pages.

### Privacy settings

---

**Recently visited pages** — Enable or disable automatic bookmark collecting. If you want to continue saving the addresses of the visited web pages into the **Recently visited pages** folder, but hide the folder from the bookmarks view, select **Hide folder**.

**Form data saving** — Select whether you want the password data or data you enter on different forms on a web page to be saved and used the next time you open the page.

**Cookies** — Enable or disable the receiving and sending of cookies.

### Web feed settings

---

**Acc. point for auto-update** — Select the desired access point for updating. This option is only available when **Automatic updates** is active.

**Update when roaming** — Select whether you want the web feeds to be updated automatically when roaming.



## Nokia Office Tools

Nokia Office Tools support mobile business and enable effective communication with work teams.

### Active notes

Select **Menu > Office > Active notes.**

Active notes allows you to create, edit, and view different kinds of notes, for example, meeting memos, hobby notes, or shopping lists. You can insert images, videos, and sound in the notes. You can link notes to other applications, such as Contacts, and send notes to others.

### Create and edit notes

Select **Menu > Office > Active notes.**

#### Create a note

Start writing.

#### Edit a note

Select **Options > Editing options.**

#### Add boldface, italics, or underlining

Press and hold the shift key, and scroll to select the text. Then select **Options > Text.**

Select **Options** and from the following:

**Insert object** — Insert items to the note.

**Send** — Send the note to a compatible device.

**Link note to call** — Select **Add contacts** to link a note to a contact. The note is displayed when making a call to or receiving a call from the contact.

### Active notes settings

Select **Menu > Office > Active notes and Options > Settings.**

#### Select where to save notes

Select **Memory in use** and the desired memory.

#### Change the layout of active notes

Select **Change view > Grid or List.**

#### Display a note during phone calls

Select **Show note during call > Yes.**

**Tip:** If you temporarily do not want to see notes during phone calls, select **Show note during call > No.** This way you do not have to remove the links between notes and contact cards.

### Calculator

Select **Menu > Office > Calculator**.

This calculator has limited accuracy and is designed for simple calculations.

To make a calculation, enter the first number of the calculation. Select a function such as add or subtract from the function map. Enter the second number of the calculation, and select **=**. The calculator performs operations in the order they are entered. The result of the calculation remains in the editor field and can be used as the first number of a new calculation.

The device saves the result of the last calculation in its memory. Exiting the Calculator application or switching off the device does not clear the memory. To recall the last saved result the next time you open the Calculator application, select **Options > Last result**.

To save the numbers or results of a calculation, select **Options > Memory > Save**.

To retrieve the results of a calculation from the memory and use them in a

calculation, select **Options > Memory > Recall**.

### File manager

#### About File manager

Select **Menu > Office > File mgr..**

With File manager, you can browse, manage, and open files.

The available options may vary.

To map or delete drives, or to define settings for a compatible remote drive connected to your device, select **Options > Remote drives**.

#### Find and organise files

Select **Menu > Office > File mgr..**

To find a file, select **Options > Find**. Select where to search, and enter a search term that matches the file name.

To move or copy files and folders, or to create new folders, select **Options > Organise**.

### Edit the memory card

You can format a memory card to erase the data on it, or you can protect the data on the memory card with a password.

Select **Menu > Office > File mgr..**

### Rename or format a memory card

Select **Options > Memory card options** and the desired option.

### Password protect a memory card

Select **Options > Memory card password**.

These options are available only if a compatible memory card is inserted in the device.

### Back up files to a memory card

Select **Menu > Office > File mgr..**

To back up files to a memory card, select the file types you want to back up, and **Options > Back up phone memory**. Ensure that your memory card has enough free memory for the files that you have chosen to back up.

### Quickoffice

#### About Quickoffice

Select **Menu > Office > Quickoffice**.

Quickoffice consists of Quickword for viewing Microsoft Word documents, Quicksheet for viewing Microsoft Excel worksheets, Quickpoint for Microsoft PowerPoint presentations, and Quickmanager for purchasing software. You can view Microsoft Office 2000, XP, 2003, and 2007 documents (DOC, XLS, and PPT file formats) with Quickoffice. If you have the editor version of Quickoffice, you can also edit files.

Not all file formats or features are supported.

#### Converter

Select **Menu > Office > Converter**.

The converter has limited accuracy, and rounding errors may occur.

#### Convert measurements

Select **Menu > Office > Converter**.

- 1 Scroll to the type field, and select **Options > Conversion type** to open a list of measures. Select the

- measurement type to use (other than currency) and **OK**.
- 2 Scroll to the first unit field, and select **Options > Select unit**. Select the unit from which to convert and **OK**. Scroll to the next unit field, and select the unit to which to convert.
  - 3 Scroll to the first amount field, and enter the value to convert. The other amount field changes automatically to show the converted value.
  - 2 Scroll to the currency type, and enter the exchange rate you would like to set per single unit of currency.
  - 3 To change the base currency, scroll to the currency, and select **Options > Set as base currency**.
  - 4 Select **Done > Yes** to save the changes.

After you have set all the necessary exchange rates, you can make currency conversions.

### Set base currency and exchange rate

Select **Menu > Office > Converter**.

When you change base currency, you must enter new exchange rates because all previously set exchange rates are cleared.

Before you can make currency conversions, you must choose a base currency and add exchange rates. The rate of the base currency is always 1. The base currency determines the conversion rates of the other currencies.

- 1 To set the exchange rate for the unit of currency, scroll to the type field, and select **Options > Currency rates**.

### Zip manager

 Select **Menu > Office > Zip**.

With Zip manager, you can create new archive files to store compressed ZIP formatted files; add single or multiple compressed files or directories to an archive; set, clear, or change the archive password for protected archives; and change settings, such as the level of compression used.

You can save the archived files in the device memory or on a memory card.

### PDF reader

Select **Menu > Office > Adobe PDF**.

With PDF reader, you can read PDF documents on the display of your device; search for text in the documents; modify settings, such as zoom level and page views; and send PDF files using e-mail.

## Printing

You can print documents, such as files, messages, images, or web pages, from your device. You may not be able to print all types of documents.

### File printing

#### Print files

---

Select **Menu > Ctrl. panel > Connectivity > Printers.**

Before printing, ensure that all the necessary configurations have been done to connect your device to the printer.

Select **Options > Printing options** and from the following:

**Print** — Print a document. To print to a file, select **Print to file**, and define the location for the file.

**Page setup** — You can change the paper size and orientation, define the margins, and insert a header or a footer.

The maximum length of the header and footer is 128 characters.

**Preview** — Preview the document before printing.

### Printing options

---

Open a document, such as a file or message, and select **Options > Printing options > Print.**

Define the following options:

**Printer** — Select an available printer from the list.

**Print** — Select **All pages, Even pages, or Odd pages** as the print range.

**Print range** — Select **All pages in range, Current page, or Defined pages** as the page range.

**Number of copies** — Select the number of copies to print.

**Print to file** — Select to print to a file and determine the location for the file.

The available options may vary.

### Printer settings

---

Select **Menu > Ctrl. panel > Connectivity > Printers.**

To add a new printer, select **Options > Add**.

Define the following:

**Printer** — Enter a name for the printer.

**Driver** — Select a driver for the printer.

**Bearer** — Select a bearer for the printer.

**Access point** — Select the access point.

**Port** — Select the port.

**Host** — Define the host.

**User** — Enter the user.

**Queue** — Enter the print queue.

**Orientation** — Select the orientation.

**Paper size** — Select the paper size.

**Media type** — Select the media type.

**Colour mode** — Select the colour mode.

**Printer model** — Select the printer model.

The available options may vary.

### Image print

You can print images from your device using a printer compatible with PictBridge. You can only print images that are in the JPEG file format.

To print images in Photos, camera, or image viewer, mark the images, and select **Options > Print**.

### Connect to printer

Connect your device to a compatible printer with a compatible data cable, and select **Image transfer** as the USB connection mode.

To set your device to ask the purpose of the connection each time the cable is connected, select **Menu > Ctrl. panel > Settings and Connectivity > USB > Ask on connection > Yes**.

### Print preview

After you select the printer, the selected images are displayed using predefined layouts.

If the images do not fit on a single page, scroll up or down to display the additional pages.

### Image print view

After you select the images to print and the printer, define the printer settings.

Select from the following:

**Layout** — Select the layout for the images.

**Paper size** — Select the paper size.

**Print quality** — Select the print quality.

## Dictionary

You can translate words from one language to another. Not all languages may be supported.

### Look up a word to translate

- 1 Select **Menu > Office > Dictionary**.
- 2 Enter text in the search field. As you enter text, suggestions of words to translate are displayed.
- 3 Select the word from the list.

Select **Options** and from the following:

**Listen** — Listen to the selected word.

**History** — Find previously translated words from the current session.

**Languages** — Change the source or target language, download languages from the internet, or remove a language from the dictionary. You cannot remove the English language from the

dictionary. You can have two additional languages installed, besides English.

**Speech** — Edit the voice feature settings. You can adjust the speed and volume of the voice.

## Notes

Select **Menu > Office > Notes**.

You can create and send notes to other compatible devices, and save received plain text files (TXT file format) to Notes.

To write a note, start entering the text. The note editor opens automatically.

To open a note, select **Open**.

To send a note to other compatible devices, select **Options > Send**.

To synchronise or to define synchronisation settings for a note, select **Options > Synchronisation**. Select **Start** to initialise synchronisation or **Settings** to define the synchronisation settings for the note.

### Positioning (GPS)

You can use applications such as GPS data to find out your location or measure distances. These applications require a GPS connection.

#### About GPS

The Global Positioning System (GPS) is operated by the government of the United States, which is solely responsible for its accuracy and maintenance. The accuracy of location data can be affected by adjustments to GPS satellites made by the United States government and is subject to change with the United States Department of Defense civil GPS policy and the Federal Radionavigation Plan. Accuracy can also be affected by poor satellite geometry. Availability and quality of GPS signals may be affected by your location, buildings, natural obstacles, and weather conditions. GPS signals may not be available inside buildings or underground and may be impaired by materials such as concrete and metal.

GPS should not be used for precise location measurement, and you should never rely solely on location data from

the GPS receiver and cellular radio networks for positioning or navigation.

The trip meter has limited accuracy, and rounding errors may occur. Accuracy can also be affected by availability and quality of GPS signals.

The coordinates in the GPS are expressed using the international WGS-84 coordinate system. The availability of the coordinates may vary by region.

#### Assisted GPS (A-GPS)

Your device also supports assisted GPS (A-GPS).

A-GPS requires network support.

Assisted GPS (A-GPS) is used to retrieve assistance data over a packet data connection, which assists in calculating the coordinates of your current location when your device is receiving signals from satellites.

When you activate A-GPS, your device receives useful satellite information from an assistance data server over the cellular network. With the help of



assisted data, your device can obtain the GPS position faster.

Your device is preconfigured to use the Nokia A-GPS service, if no service provider-specific A-GPS settings are available. The assistance data is retrieved from the Nokia A-GPS service server only when needed.

To disable the A-GPS service, select **Menu > Applications > Location > GPS data and Options > Positioning settings > Positioning methods > Assisted GPS > Options > Disable**.

You must have an internet access point defined in the device to retrieve assistance data from the Nokia A-GPS service over a packet data connection. The access point for A-GPS can be defined in positioning settings. A wireless LAN (WLAN) access point cannot be used for this service. Only a packet data internet access point can be used. Your device asks you to select the internet access point when GPS is used for the first time.

### Hold your device correctly

When using the GPS receiver, ensure you do not cover the antenna with your hand.



Establishing a GPS connection may take from a couple of seconds to several minutes. Establishing a GPS connection in a vehicle may take longer.

The GPS receiver draws its power from the device battery. Using the GPS receiver may drain the battery faster.

### Tips on creating a GPS connection

If your device cannot find the satellite signal, consider the following:

- If you are indoors, go outdoors to receive a better signal.
- If you are outdoors, move to a more open space.

- Ensure that your hand does not cover the GPS antenna of your device.
- If the weather conditions are bad, the signal strength may be affected.
- Some vehicles have tinted (athermic) windows, which may block the satellite signals.

### Check satellite signal status

---

To check how many satellites your device has found, and whether your device is receiving satellite signals, select **Menu > Applications > Location > GPS data and Options > Satellite status**.



If your device has found satellites, a bar for each satellite is displayed in the satellite information view. The longer the bar, the stronger the satellite signal is. When your device has received enough data from the satellite signal to

calculate the coordinates of your location, the bar colour changes.

Initially, your device must receive signals from at least four satellites to be able to calculate the coordinates of your location. When the initial calculation has been made, it may be possible to continue calculating the coordinates of your location with three satellites. However, the accuracy is generally better when more satellites are found.

### Position requests

You may receive a request from a network service to receive your position information. Service providers may offer information about local topics, such as weather or traffic conditions, based on the location of your device.

When you receive a position request, the service that is making the request is displayed. Select **Accept** to allow your position information to be sent or **Reject** to deny the request.

### Landmarks

With Landmarks, you can save the position information of specific locations in your device. You can sort the saved locations into different

categories, such as business, and add other information to them, such as addresses. You can use your saved landmarks in compatible applications, such as GPS data.

Select **Menu > Applications > Installations > Landmarks.**

The coordinates in the GPS are expressed using the international WGS-84 coordinate system.

Select **Options** and from the following:

**New landmark** — Create a new landmark. To make a positioning request for your current location, select **Current position**. To select the location from the map, select **Select from map**. To enter the position information manually, select **Enter manually**.

**Edit** — Edit or add information to a saved landmark (for example, a street address).

**Add to category** — Add a landmark to a category in Landmarks. Select each category to which you want to add the landmark.

**Send** — Send one or several landmarks to a compatible device. Your received

landmarks are placed in the Inbox folder in Messaging.

You can sort your landmarks into preset categories, and create new categories. To edit and create new landmark categories, open the categories tab, and select **Options > Edit categories.**

### GPS data

#### Route guidance

Select **Menu > Applications > Location > GPS data and Navigation.**

Start the route guidance outdoors. If started indoors, the GPS receiver may not receive the necessary information from the satellites.

Route guidance uses a rotating compass on the device display. A red ball shows the direction to the destination, and the approximate distance to it is shown inside the compass ring.

Route guidance is designed to show the straightest route and the shortest distance to the destination, measured in a straight line. Any obstacles on the route, such as buildings and natural obstacles, are ignored. Differences in altitude are not taken into account

## 100 Positioning (GPS)

---

when calculating the distance. Route guidance is active only when you move.

To set your trip destination, select **Options > Set destination** and a landmark as the destination, or enter the latitude and longitude coordinates.

To clear the destination set for your trip, select **Stop navigation**.

### Trip meter

Select **Menu > Applications > Location > GPS data and Trip distance**.

The trip meter has limited accuracy, and rounding errors may occur. Accuracy can also be affected by availability and quality of GPS signals.

To turn trip distance calculation on or off, select **Options > Start** or **Stop**. The calculated values remain on the display. Use this feature outdoors to receive a better GPS signal.

To set the trip distance and time and average and maximum speeds to zero, and to start a new calculation, select

**Options > Reset**. To set the trip meter and total time to zero, select **Restart**.

### Positioning settings

Select **Menu > Ctrl. panel > Settings and General > Positioning**.

### Positioning methods

---

Select from the following:

**Integrated GPS** — Use the integrated GPS receiver of your device.

**Assisted GPS** — Use Assisted GPS (A-GPS) to receive assistance data from an assistance data server.

**Bluetooth GPS** — Use a compatible external GPS receiver with Bluetooth connectivity.

**Network based** — Use information from the cellular network (network service).

### Positioning server

---

To define an access point and positioning server for network-assisted positioning methods, such as assisted GPS or network-based positioning, select **Positioning server**.

The positioning server may be preset by your service provider, and you may not be able to edit the settings.

## Notation settings

To select which measurement system you want to use for speeds and distances, select **Measurement system** > **Metric** or **Imperial**.

To define in which format the coordinate information is displayed in your device, select **Coordinate format** and the desired format.

## Maps

### Maps overview



Select Menu > Maps.

Welcome to Maps.

Maps shows you what is nearby, helps you plan your route, and guides you where you want to go.

- Find cities, streets, and services.

- Find your way with turn-by-turn directions.
- Synchronise your favourite locations and routes between your mobile device and the Ovi Maps internet service.
- Check weather forecasts and other local information, if available.

**Note:** Downloading content such as maps, satellite images, voice files, guides or traffic information may involve transmission of large amounts of data (network service).

Some services may not be available in all countries, and may be provided only in selected languages. The services may be network dependent. For more information, contact your network service provider.

Almost all digital cartography is inaccurate and incomplete to some extent. Never rely solely on the cartography that you download for use in this device.

Content such as satellite images, guides, weather and traffic information and related services are generated by third parties independent of Nokia. The

content may be inaccurate and incomplete to some extent and is subject to availability. Never rely solely on the aforementioned content and related services.

### View your location and the map

See your current location on the map, and browse maps of different cities and countries.

Select **Menu > Maps and My position.**

When the GPS connection is active,  marks your current or last known location on the map. If the icon's colours are faint, no GPS signal is available.

If only cell ID based positioning is available, a red halo around the positioning icon indicates the general area you might be in. The accuracy of the estimate increases in densely populated areas.

### Move on the map

Use the scroll key. By default, the map is oriented north.

### View your current or last known location

Press **0**.

### Zoom in or out

Press **\* or #**.

If you browse to an area not covered by maps that are stored on your device and you have an active data connection, new maps are automatically downloaded.

Map coverage varies by country and region.

### Map view

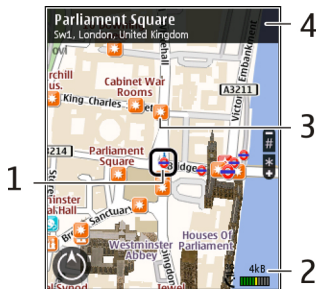

- 1 Selected location
- 2 Indicator area
- 3 Point of interest (for example, a railway station or a museum)
- 4 Information area

### Change the look of the map

View the map in different modes, to easily identify where you are.

Select **Menu > Maps and My position.**

Press **1**, and select from the following:

**Map** — In the standard map view, details such as location names or motorway numbers, are easy to read.

**Satellite** — For a detailed view, use satellite images.

**Terrain** — View at a glance the ground type, for example, when you are travelling off-road.

### Change between 2D and 3D views

Press **3**.

### Download and update maps

To avoid mobile data transfer costs, download the latest maps and voice guidance files to your computer, and

then transfer and save them to your device.

Use the Nokia Ovi Suite application to download the latest maps and voice guidance files to your compatible computer. To download and install Nokia Ovi Suite on your compatible computer, go to [www.ovi.com](http://www.ovi.com).

**Tip:** Save new maps to your device before a journey, so you can browse the maps without an internet connection when travelling abroad.

To make sure your device does not use an internet connection, in the main menu, select **Options > Settings > Internet > Connection > Offline.**

### About positioning methods

Maps displays your location on the map using GPS, A-GPS, or cell ID based positioning.

The Global Positioning System (GPS) is a satellite-based navigation system used for calculating your location. Assisted GPS (A-GPS) is a network service that sends you GPS data, improving the speed and accuracy of the positioning.

When you use Maps for the first time, you are prompted to define an internet access point to download map information or use A-GPS.

 indicates the availability of the satellite signals. One bar is one satellite. When the device is searching for satellite signals, the bar is yellow. When there is enough data available to calculate your location, the bar turns green. The more green bars, the more reliable the location calculation.

The Global Positioning System (GPS) is operated by the government of the United States, which is solely responsible for its accuracy and maintenance. The accuracy of location data can be affected by adjustments to GPS satellites made by the United States government and is subject to change with the United States Department of Defense civil GPS policy and the Federal Radionavigation Plan. Accuracy can also be affected by poor satellite geometry. Availability and quality of GPS signals may be affected by your location, buildings, natural obstacles, and weather conditions. GPS signals may not be available inside buildings or

underground and may be impaired by materials such as concrete and metal.

GPS should not be used for precise location measurement, and you should never rely solely on location data from the GPS receiver and cellular radio networks for positioning or navigation.

The trip meter has limited accuracy, and rounding errors may occur. Accuracy can also be affected by availability and quality of GPS signals.

With cell ID based positioning, the position is determined through the antenna tower your mobile device is currently connected to.

Depending on the available positioning method, the accuracy of positioning may vary from a few metres to several kilometres.

### Find a location

Maps helps you find specific locations and types of business you are looking for.

Select **Menu > Maps and Find places.**



- 1 Enter search terms, such as a street address or postcode. To clear the search field, select **Clear**.
- 2 Select **Go**.
- 3 In the list of proposed matches, go to the desired item. To display the location on the map, select **Map**.

To view the other locations of the search result list on the map, scroll up and down with the scroll key.

### **Return to the list of proposed matches**

Select **List**.

### **Search for different types of nearby places**

Select **Browse categories** and a category, such as shopping, accommodation, or transport.

If no search results are found, ensure the spelling of your search terms is correct. Problems with your internet connection may also affect results when searching online.

To avoid data transfer costs, you can also get search results without an active

internet connection, if you have maps of the searched area stored on your device.

### **View location details**

View more information about a specific location or place, such as a hotel or restaurant, if available.

Select **Menu > Maps and My position**.

### **View the details of a place**

Select a place, press the scroll key, and select **Show details**.

### **Save places and routes**

Save addresses, places of interest, and routes, so they can be quickly used later.

Select **Menu > Maps**.

### **Save a place**

- 1 Select **My position**.
- 2 Go to the location. To search for an address or place, select **Search**.
- 3 Press the scroll key.
- 4 Select **Save place**.

### **Save a route**

- 1 Select **My position**.

- 2 Go to the location. To search for an address or place, select **Search**.
- 3 To add another route point, press the scroll key, and select **Add to route**.
- 4 Select **Add new route point** and the appropriate option.
- 5 Select **Show route > Options > Save route**.

### View your saved places and routes

Select **Favourites > Places or Routes**.

### View and organise places or routes

Use your Favourites to quickly access the places and routes you have saved.

Group the places and routes into a collection, for example, when planning a trip.

Select **Menu > Maps and Favourites**.

### View a saved place on the map

- 1 Select **Places**.
- 2 Go to the place.
- 3 Select **Map**.

To return to the list of saved places, select **List**.

### Create a collection

Select **Create new collection**, and enter a collection name.

### Add a saved place to a collection

- 1 Select **Places** and the place.
- 2 Select **Organise collections**.
- 3 Select **New collection** or an existing collection.

If you need to delete places or routes, or add a route to a collection, go to the Ovi Maps internet service at [www.ovi.com](http://www.ovi.com).

### Send places to your friends

When you want to share place information with your friends, send these details directly to their devices.

Select **Menu > Maps and My position**

### Send a place to your friend's compatible device

Select a location, press the scroll key, and select **Send**.

### Share location

Publish your current location to Facebook, together with text and a

picture. Your Facebook friends can see your location on a map.

### Select Menu > Maps and Share location.

To share your location, you need a Nokia account and a Facebook account.

- 1 Sign in to your Nokia account, or, if you do not yet have one, select **Create new account**.
- 2 Sign in to your Facebook account.
- 3 Select your current location.
- 4 Enter your status update.
- 5 To attach a picture to your post, select **Add a photo**.
- 6 Select **Share location**.

### Manage your Facebook account

In the main view, select **Options > Account > Share location settings > Facebook**.

Sharing your location and viewing the location of others requires an internet connection. This may involve the transmission of large amounts of data and related data traffic costs.

The Facebook terms of use apply to sharing your location on Facebook. Familiarise yourself with the Facebook terms of use and the privacy practices.

Before sharing your location to others, always consider carefully with whom you are sharing it. Check the privacy settings of the social networking service you are using as you might share your location with a large group of people.

### Synchronise your Favourites

Plan a trip on your computer at the Ovi Maps website, synchronise the saved places, routes, and collections with your mobile device, and access the plan on the go.

To synchronise places, routes, or collections between your mobile device and the Ovi Maps internet service, you need a Nokia account. If you do not have one, in the main view, select **Options > Account > Nokia account > Create new account**.

### **Synchronise saved places, routes, and collections**

Select **Favourites > Synchronise with Ovi**. If you do not have a Nokia account, you are prompted to create one.

### **Set the device to synchronise Favourites automatically**

Select **Options > Settings > Synchronisation > Change > At start-up and shut-d.**

Synchronising requires an active internet connection, and may involve the transmission of large amounts of data through your service provider's network. Contact your service provider for information about data transmission charges.

To use the Ovi Maps internet service, go to [www.ovi.com](http://www.ovi.com).

### **Get voice guidance**

Voice guidance, if available for your language, helps you find your way to a destination, leaving you free to enjoy the journey.

Select **Menu > Maps and Drive or Walk**.

When you use drive or walk navigation for the first time, you are asked to select the language of the voice guidance, and download the appropriate files.

If you select a language that includes street names, also the street names are said aloud. Voice guidance may not be available for your language.

### **Change the voice guidance language**

In the main view, select **Options > Settings > Navigation > Drive guidance or Walk guidance** and the appropriate option.

### **Repeat the voice guidance for car navigation**

In the navigation view, select **Options > Repeat**.

### **Adjust the volume of the voice guidance for car navigation**

In the navigation view, select **Options > Volume**.

### **Drive to your destination**

When you need turn-by-turn directions while driving, Maps helps you get to your destination.

Select **Menu > Maps and Drive**.

### Drive to a destination

Select **Set destination** and the appropriate option.

### Drive to your home

Select **Drive home**.

When you select **Drive home** or **Walk home** for the first time, you are prompted to define your home location. To later change the home location, do the following:

- 1 In the main view, select **Options > Settings > Navigation > Home Location > Change > Redefine**.
- 2 Select the appropriate option.

**Tip:** To drive without a set destination, select **Map**. Your location is displayed on the centre of the map as you move.

### Change views during navigation

Press the scroll key, and select **2D view**, **3D view**, **Arrow view**, or **Route overview**.

Obey all local laws. Always keep your hands free to operate the vehicle while

driving. Your first consideration while driving should be road safety.

### Navigation view

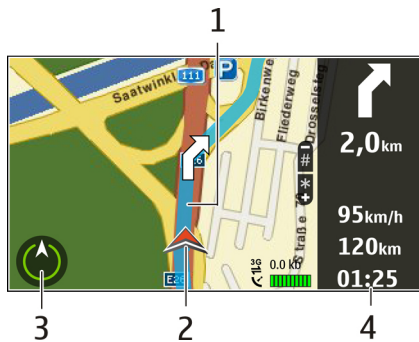

- 1 Route
- 2 Your location and direction
- 3 Compass
- 4 Information bar (speed, distance, time)

### Get traffic and safety information

Enhance your driving experience with real-time information about traffic events, lane assistance, and speed limit

warnings, if available for your country or region.

Select **Menu** > **Maps and Drive**.

### View traffic events on the map

During drive navigation, select **Options** > **Traffic info**. The events are displayed as triangles and lines.

### Update traffic information

Select **Options** > **Traffic info** > **Update traffic info**.

When planning a route, you can set the device to avoid traffic events, such as traffic jams or roadworks.

### Avoid traffic events

In the main view, select **Options** > **Settings** > **Navigation** > **Reroute due to traffic**.

The location of speed cameras may be shown on your route during navigation, if this feature is enabled. Some jurisdictions prohibit or regulate the use of speed camera location data. Nokia is not responsible for the accuracy, or the consequences of using speed camera location data.

### Walk to your destination

When you need directions to follow a route on foot, Maps guides you over squares, and through parks, pedestrian zones, and even shopping centres.

Select **Menu** > **Maps and Walk**.

### Walk to a destination

Select **Set destination** and the appropriate option.

### Walk to your home

Select **Walk home**.

When you select **Drive home** or **Walk home** for the first time, you are prompted to define your home location. To later change the home location, do the following:

- 1 In the main view, select **Options** > **Settings** > **Navigation** > **Home Location** > **Change** > **Redefine**.
- 2 Select the appropriate option.

**Tip:** To walk without a set destination, select **Map**. Your location is displayed on the centre of the map as you move.

## Plan a route

Plan your journey, and create your route and view it on the map before setting off.

Select **Menu** > **Maps** and **My position**.

## Create a route

- 1 Go to your starting point.
- 2 Press the scroll key, and select **Add to route**.
- 3 To add another route point, select **Add new route point** and the appropriate option.

## Change the order of the route points

- 1 Go to a route point.
- 2 Press the scroll key, and select **Move**.
- 3 Go to the place where you want to move the route point to, and select **OK**.

## Edit the location of a route point

Go to the route point, press the scroll key, and select **Edit** and the appropriate option.

## View the route on the map

Select **Show route**.

## Navigate to the destination

Select **Show route** > **Options** > **Start driving** or **Start walking**.

## Change the settings for a route

The route settings affect the navigation guidance and the way the route is displayed on the map.

- 1 In the route planner view, open the **Settings** tab. To get to the route planner view from the navigation view, select **Options** > **Route points** or **Route point list**.
- 2 Set the transportation mode to **Drive** or **Walk**. If you select **Walk**, one-way streets are regarded as normal streets, and walkways and routes through, for example, parks and shopping centres, can be used.
- 3 Select the desired option.

## Select the walking mode

Open the **Settings** tab, and select **Walk** > **Preferred route** > **Streets** or **Straight line**. **Straight line** is useful on off-road terrain as it indicates the walking direction.

### Use the faster or shorter driving route

Open the Settings tab, and select **Drive > Route selection > Faster route** or **Shorter route**.

### Use the optimised driving route

Open the Settings tab, and select **Drive > Route selection > Optimised**. The optimised driving route combines the advantages of both the shorter and the faster routes.

You can also choose to allow or avoid using, for example, motorways, toll roads, or ferries.

## Personalisation

You can personalise your device by, for example, adjusting the various tones, background images, and screen savers.

### Profiles

Select **Menu > Ctrl. panel > Profiles**.

You can adjust and customise the ringing tones, alert tones, and other device tones for different events, environments, or caller groups. The active profile is shown at the top of the

display in the home screen. However, if the active profile is General, only today's date is shown.

To create a new profile, select **Options > Create new**, and define the settings.

To customise a profile, select a profile and **Options > Personalise**.

To activate a profile, select a profile and **Options > Activate**.

To set the profile to be active until a certain time within the next 24 hours, scroll to the profile, select **Options > Timed**, and set the time. When the time expires, the profile changes back to the previously active non-timed profile. When the profile is timed, ⌚ is displayed in the home screen. The Offline profile cannot be timed.

To delete a profile that you created, select **Options > Delete profile**. You cannot delete the predefined profiles.

When the Offline profile is activated, your connection to the cellular network is closed. All radio frequency signals



between the device and the cellular network are prevented. If you try to send a message, it is placed in the Outbox folder, and is sent only when another profile is activated.

You can also use your device without a SIM card. If you remove the SIM card, the Offline profile is activated.

**Important:** In the Offline profile you cannot make or receive any calls, or use other features that require cellular network coverage. Calls may still be possible to the official emergency number programmed into your device. To make calls, you must first activate the phone function by changing profiles. If the device has been locked, enter the lock code.

When you use the Offline profile, you can still use a wireless LAN (WLAN), for example, to read your mail or browse the internet. You can also use Bluetooth connectivity. Remember to comply with any applicable safety requirements when you establish and use WLAN or Bluetooth connections.

## Select ringing tones

To set a ringing tone for a profile, select **Options > Personalise > Ringing tone**. Select a ringing tone from the list, or select **Download sounds** to open a bookmark folder containing a list of bookmarks for downloading tones using the browser. Any downloaded tones are saved to Gallery.

To play the ringing tone for a selected contact group only, select **Options > Personalise > Alert for**, and select the desired group. Phone calls coming from outside that group have a silent alert.

To change the message tone, select **Options > Personalise > Message alert tone**.

## Customise profiles

Select **Menu > Ctrl. panel > Profiles**.

Select **Options > Personalise** and from the following:

**Ringing tone** — Select a ringing tone from the list, or select **Download sounds** to open a bookmark folder

containing a list of bookmarks for downloading tones using the browser.

**Video call tone** — Select a ringing tone for video calls.

**Say caller's name** — When you select this option and someone from your contacts list calls you, the device sounds a ringing tone that is a combination of the spoken name of the contact and the selected ringing tone.

**Ring type** — Select how you want the ringing tone to alert.

**Ring volume** — Select the volume level of the ringing tone.

**Message alert tone** — Select a tone for received text messages.

**E-mail alert tone** — Select a tone for received e-mail messages.

**Vibrating alert** — Set the device to vibrate when you receive a call or message.

**Keypad tones** — Select the volume level of the keypad tones.

**Warning tones** — Deactivate the warning tones. This setting also affects the tones of some games and Java™ applications.

**Alert for** — Set the device to ring only upon calls from phone numbers that

belong to a selected contact group. Phone calls coming from outside that group have a silent alert.

**PTT call alert tone** — Select a ringing tone for PTT calls.

**Push to talk status** — Set the PTT status to each profile.

**Profile name** — You can give a name to a new profile or rename an existing profile. The General and Offline profiles cannot be renamed.

### Change the display theme

Select Menu > Ctrl. panel > Themes.

Select from the following:

**General** — Change the theme used in all applications.

**Menu view** — Change the theme used in the main menu.

**Standby** — Change the theme used in the home screen.

**Wallpaper** — Change the background image of the home screen.

**Call image** — Change the image displayed during calls.

**Audio themes** — Set sounds for various device events.

To activate or deactivate the theme effects, select **General > Options > Theme effects**.

### Download a theme

Select **Menu > Ctrl. panel > Themes**.

To download a theme, select **General > Download themes > Options > Go to > New web page**. Enter the web address from which you want to download your theme. Once the theme is downloaded, you can preview or activate the theme.

To preview a theme, select **Options > Preview**.

To activate a theme, select **Options > Set**.

### 3-D ringing tones

Select **Menu > Ctrl. panel > 3-D tones**.

To enable three-dimensional (3-D) sound effects for ringing tones, select **3-D ringing tone effects > On**. Not all ringing tones support 3-D effects.

To change the 3-D effect that is applied to the ringing tone, select **Sound trajectory** and the desired effect.

To modify the 3-D effect, select from the following:

**Trajectory speed** — Select the speed at which sound moves from one direction to another. This setting is not available for all effects.

**Reverberation** — Select the desired effect to adjust the amount of echo.

**Doppler effect** — Select **On** to set the ringing tone sound higher when you are closer to your device, and lower when you are farther away. This setting is not available for all effects.

To listen to the ringing tone with the 3-D effect, select **Options > Play tone**.

To adjust the volume of the ringing tone, select **Menu > Ctrl. panel > Profiles and Options > Personalise > Ringing volume**.

### Media

Your device contains a variety of media applications for both business and leisure time use.

#### Camera

Select **Menu > Media > Camera**.

#### Capture an image

Select **Menu > Media > Camera**.

Your device supports an image capture resolution of 2592x1944 pixels. The image resolution in this guide may appear different.

- 1 Use the display as a viewfinder.
- 2 To zoom in or out before capturing an image, use the volume keys.
- 3 To temporarily activate the toolbar when it is hidden, scroll left.

The toolbar provides you with shortcuts to different items and settings before and after capturing an image or recording a video clip. Select from the following:



Switch to image mode.



Switch to video mode.



Select the scene.



Switch to panorama mode.



Switch the video light off (video mode only)



Switch the video light on (video mode only)



Select the flash mode (images only).



Activate the self-timer (images only).



Activate sequence mode (images only).



Select a colour tone.



Adjust the white balance.

The available options vary depending on the mode and view you are in. The settings return to the default values when you close the camera.

To customise the camera toolbar, switch to image mode, and select **Options > Customise toolbar**.

#### Scenes

Select **Menu > Media > Camera**.

A scene helps you to find the right colour and lighting settings for the current environment. The settings of each scene

have been set according to a certain style or environment.

To change the scene, select **Scene modes** from the toolbar.

To make your own scene, scroll to User defined, and select **Options > Change**.

To copy the settings of another scene, select **Based on scene mode** and the desired scene.

To activate your own scene, select **User defined > Select**.

### Capture images in a sequence

Select **Menu > Media > Camera**.

To capture several images in a sequence, if enough memory is available, select **Sequence mode** from the toolbar and press the scroll key.

The captured images are shown in a grid on the display. To view an image, scroll to it and press the scroll key. If you used a time interval, only the last image is shown on the display, and the other images are available in Gallery.

To send the image, select **Options > Send**.

To send the image to a caller during an active call, select **Options > Send to caller**.

To deactivate sequence mode, select **Sequence mode > Single shot** in the toolbar.

### View captured image

Select **Menu > Media > Camera**.

The image you captured is automatically saved in Gallery. If you do not want to keep the image, select **Delete** from the toolbar.

Select from the following toolbar items:  
**Send** — Send the image to a compatible device.

**Sign in to Share online** — Send the image to your compatible online album (network service).

To use the image as the background image, select **Options > Use image > Set as wallpaper**.

To add the image to a contact, select **Options > Use image > Assign to contact**.

The available toolbar items and options may vary.

### Record videos

Select **Menu > Media > Camera**.

- 1 If the camera is in image mode, select video mode from the toolbar.
- 2 To start recording, press the scroll key.
- 3 To pause recording, select **Pause**. Select **Continue** to resume recording.
- 4 To stop recording, select **Stop**. The video clip is automatically saved in Gallery. The maximum length of the video clip depends on the available memory.

### Play a video clip

Select **Menu > Media > Camera**.

To play a recorded video clip, select **Play** from the toolbar.

Select from the following toolbar items:

**Send** — Send the video clip to a compatible device.

**Sign in to Share online** — Send the video clip to an online album (network service).

**Delete** — Delete the video clip.

To enter a new name for the video clip, select **Options > Rename video clip**.

The available toolbar items and options may vary.

### Image settings

Select **Menu > Media > Camera**.

To modify still image settings, select **Options > Settings** and from the following:

**Image quality** — Set the image quality. The better the image quality, the more memory the image consumes.

**Add to album** — Define to which album the captured images are saved.

**Show captured image** — To see the image after the capture, select **Yes**. To continue capturing images immediately, select **Off**.

**Default image name** — Define the default name for the captured images.

**Extended digital zoom** — The **On (continuous)** option allows the zoom increments to be smooth and continuous between the digital and extended digital zoom. The **Off** option allows a limited amount of zoom while retaining the image resolution.

**Capture tone** — Set the tone that sounds when you capture an image.

**Memory in use** — Select where to store your images.

**Restore camera settings** — Restore the camera settings to the default values.

## Video settings

Select **Menu** > **Media** > **Camera**.

Select **Options** > **Settings** and from the following:

**Video quality** — Set the quality of the video clip. Select **Sharing**, if you want to send the video clip using a multimedia message. The clip is recorded with OCIF resolution, in the 3GPP file format, and the size is limited to 300 kB (approximately 20 seconds). You may not be able to send video clips saved in

the MPEG-4 file format in a multimedia message.

**Audio recording** — Select **Mute** if you do not want to record sound.

**Add to album** — Define to which album the recorded videos are saved.

**Show captured video** — View the first frame of the recorded video clip after the recording stops. To view the entire video clip, select **Play** from the toolbar.

**Default video name** — Define the default name for recorded video clips.

**Memory in use** — Select where to store your video clips.

**Restore camera settings** — Restore the camera settings to the default values.

## Gallery

### About Gallery

Select **Menu** > **Media** > **Gallery**.

Gallery is a storage place for your images, video and sound clips, songs, and streaming links.

### Main view

Select **Menu** > **Media** > **Gallery**.

Select from the following:

**Images**  — View images and video clips in Photos.

**Video clips**  — View video clips in Video centre.

**Songs**  — Open Music player.

**Sound clips**  — Listen to sound clips.

**Streaming links**  — View and open streaming links.

**Presentations**  — View presentations.

You can browse and open folders and copy and move items to folders. You can also create albums and copy and add items to albums.

Files stored on your compatible memory card (if inserted) are indicated with



To open a file, select the file from the list. Video clips and streaming links open and play in Video centre, and music and sound clips in Music player.

To copy or move files to another memory location, select a file, **Options** > **Move and copy**, and the appropriate option.

### Sound clips

Select **Menu** > **Media** > **Gallery and Sound clips**.

This folder contains all the sound clips you have downloaded from the web. The sound clips created with the Recorder application with MMS optimised or normal quality settings are also saved in this folder, but the sound clips created with high quality settings are stored in the Music player application.

To listen to a sound file, select the file from the list.

To rewind or fast-forward, scroll left or right.

To download sounds, select **Download sounds**.

### Streaming links

Select **Menu** > **Media** > **Gallery and Streaming links**.

To open a streaming link, select the link from the list.



To add a new streaming link, select **Options** > **New link**.

## Presentations

Select **Menu** > **Media** > **Gallery**.

With presentations, you can view scalable vector graphics (SVG) and flash files (SWF), such as cartoons and maps. SVG images maintain their appearance when printed or viewed with different screen sizes and resolutions.

To view files, select **Presentations**. Go to an image, and select **Options** > **Play**. To pause playing, select **Options** > **Pause**.

To zoom in, press **5**. To zoom out, press **0**.

To rotate the image 90 degrees clockwise or anticlockwise, press **1** or **3**, respectively. To rotate the image 45 degrees, press **7** or **9**.

To switch between full and normal screen mode, press **\***.

## Photos

Learn how to view, edit, and share pictures and videos on your device.

## About Photos

Select **Menu** > **Media** > **Gallery** > **Images** and from the following:

**Captured** — View all the images and videos you have captured.

**Months** — View images and videos categorised by the month they were captured.

**Albums** — View the default albums and the ones you have created.

**Tags** — View the tags you have created for each item.

**Downloads** — View items and videos downloaded from the web or received as a multimedia or e-mail message.

**All** — View all items.

**Share online** — Post your images or videos to the web.

Files stored on your compatible memory card (if inserted) are indicated with



To copy or move files to another memory location, select a file, **Options** > **Move and copy**, and from the available options.

### View images and videos

Select **Menu** > **Media** > **Gallery** > **Images** and from the following:

**All** — View all images and video clips.

**Captured** — View images captured and video clips recorded with the camera of your device.

**Downloads** — View downloaded video clips.

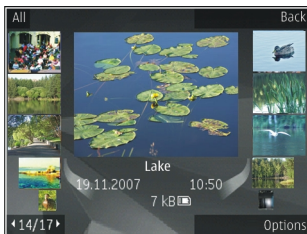

Images and video clips can also be sent to you from a compatible device. To be

able to view a received image or video clip in Photos, you must first save it.

The images and video clip files are in a loop and ordered by date and time. The number of files is displayed. To browse the files one by one, scroll left or right. To browse files in groups, scroll up or down.

To open a file, select the file. When an image opens, to zoom in the image, use the zoom keys. The zooming ratio is not stored permanently.

To edit an image or a video clip, select **Options** > **Edit**.

To print your images on a compatible printer, select **Options** > **To printer or kiosk**.

To move images to an album for later printing, select **Options** > **Add to album** > **Print later**.

### View and edit file details

Select **Menu** > **Media** > **Gallery** > **Images**. Go to an item.

To view and edit image or video properties, select **Options** > **Details** > **View and edit** and from the following:

**Tags** — View the currently used tags. To add more tags to the current file, select **Add**.

**Description** — View a free-form description of the file. To add a description, select the field.

**Title** — View the thumbnail image of the file and the current file name. To edit the file name, select the file name field.

**Albums** — View in which albums the current file is located.

**Resolution** — View the size of the image in pixels.

**Duration** — View the length of the video.

**Usage rights** — To view the DRM rights of the current file, select **View**.

### Organise images and videos

Select **Menu** > **Media** > **Gallery** > **Images**. You can organise files as follows:

To view items in the Tags view, add tags to the items.

To view items by months, select **Months**.

To create an album to store items, select **Albums** > **Options** > **New album**.

To add an image or a video clip to an album, select the item and **Options** > **Add to album**.

To delete an image or video clip, select the item and **Delete** from the active toolbar.

### Active toolbar

The active toolbar is available only when you have selected an image or a video clip in a view.

In the active toolbar, go to different items, and select the desired option. The available options vary depending on the view you are in and whether you have selected an image or a video clip.

To hide the toolbar, select **Options** > **Hide toolbar**. To activate the active

toolbar when it is hidden, press the scroll key.

Select an image or a video clip and from the following:



View the image in landscape or portrait mode.



Play the video clip.



Send the image or video clip.



Upload the image or video clip to a compatible online album (only available if you have set up an account for a compatible online album).



Add the item to an album.



Manage tags and other properties of the item.

### Albums

Select **Menu** > **Media** > **Gallery** > **Images** and **Albums**.

With albums, you can conveniently manage your images and video clips.

To create a new album, select **Options** > **New album**.

To add an image or a video clip to an album, select the item and **Options** >

**Add to album**. A list of albums opens. Select the album to which you want to add the image or video clip. The item you added to the album is still visible in Photos.

To remove an image or a video clip from an album, select the album and the item, and **Options** > **Remove from album**.

### Tags

Select **Menu** > **Media** > **Gallery** > **Images**.

Use tags to categorise media items in Photos. You can create and delete tags in Tag manager. Tag manager shows the currently used tags and the number of items associated with each tag.

To open Tag manager, select an image or video clip and **Options** > **Details** > **Tag manager**.

To create a tag, select **Options** > **New tag**.

To assign a tag to an image, select the image and **Options** > **Add tags**.

To see the tags you have created, select **Tags**. The size of the tag name corresponds to the number of items the tag is assigned to. To view all the images associated with a tag, select the tag from the list.

To view the list in most frequently used order, select **Options > Most used**.

To remove an image from a tag, select the tag and the image, and select **Options > Remove from tag**.

### Slide show

Select **Menu > Media > Gallery > Images**.

To view your images as a slide show, select an image and **Options > Slide show > Play forwards** or **Play backwards**. The slide show starts from the selected file.

To view only the selected images as a slide show, select **Options > Mark/Unmark > Mark** to mark images. To start the slide show, select **Options > Slide show > Play forwards** or **Play backwards**.

To resume a paused slide show, select **Continue**.

To end the slide show, select **End**.

To browse the images, scroll left or right.

Before starting the slide show, to adjust the slide show settings, select **Options > Slide show > Settings** and from the following:

**Music** — Add sound to the slide show.

**Song** — Select a music file from the list.

**Delay between slides** — Adjust the tempo of the slide show.

To adjust the volume during the slide show, use the volume keys.

### Edit images

#### Image editor

---

To edit the pictures after taking them or the ones already saved in Photos, select **Options > Edit**. The image editor opens.

To open a grid where you can select different edit options indicated by small icons, select **Options > Apply effect**. You can crop and rotate the image; adjust the brightness, colour, contrast, and resolution; and add effects, text, clip art, or a frame to the picture.

### Crop image

---

To crop an image, select **Options > Apply effect > Crop**, and a predefined aspect ratio from the list. To crop the image size manually, select **Manual**.

If you select **Manual**, a cross appears in the upper left corner of the image. Use the scroll key to select the area to crop, and select **Set**. Another cross appears in the lower right corner. Again select the area to be cropped. To adjust the first selected area, select **Back**. The selected areas form a rectangle that forms the cropped image.

If you select a predefined aspect ratio, select the upper left corner of the area to be cropped. To resize the highlighted area, use the scroll key. To freeze the selected area, press the scroll key. To

move the area within the picture, use the scroll key. To select the area to be cropped, press the scroll key.

### Reduce red-eye

---

- 1 Select **Menu > Media > Gallery > Images**.
- 2 Select an image and **Options > Edit >  (Red eye reduction)**.
- 3 Scroll the cross onto the eye, and press the scroll key. Scroll to resize the loop to fit the size of the eye. To reduce the redness, press the scroll key. When you have finished editing the image, select **Done**.
- 4 To save the changes and return to the previous view, select **Back**.

### Useful shortcuts

---

You can use the following shortcuts when editing images:

- To view a full-screen image, press **\***. To return to the normal view, press **\*** again.
- To rotate an image clockwise or anticlockwise, press **3** or **1**.
- To zoom in or out, press **5** or **0**.

- To move on a zoomed image, scroll up, down, left, or right.

## Edit videos

The video editor supports .3gp and .mp4 video file formats, and .aac, .amr, .mp3, and .wav audio file formats. It does not necessarily support all features of a file format or all the variations of file formats.

To edit video clips in Photos, scroll to a video clip, select **Options** > **Edit**, and from the following:

**Merge** — to add an image or a video clip to the beginning or the end of the selected video clip

**Change sound** — to add a new sound clip, and to replace the original sound in the video clip.

**Add text** — to add text to the beginning or the end of the video clip

**Cut** — to trim the video and mark the sections you want to keep in the video clip

To take a snapshot of a video clip, in the cut video view, select **Options** > **Take snapshot**. In the thumbnail preview

view, press the scroll key, and select **Take snapshot**.

## Print images

### Image print

To print images with Image print, select the image you want to print, and the print option in Photos, camera, image editor, or image viewer.

Use Image print to print your images using a compatible USB data cable, or Bluetooth connectivity. You can also print images using wireless LAN. If a compatible memory card is inserted, you can store the images to the memory card, and print them using a compatible printer.

You can only print images that are in .jpeg format. The pictures taken with the camera are automatically saved in .jpeg format.

### Printer selection

To print images with Image print, select the image and the print option.

When you use Image print for the first time, a list of available compatible printers is displayed. Select a printer. The printer is set as the default printer.

To use a printer compatible with PictBridge, connect the compatible data cable before you select the print option, and check that the data cable mode is set to **Image print** or **Ask on connection**. The printer is automatically displayed when you select the print option.

If the default printer is not available, a list of available printers is displayed.

To change the default printer, select **Options > Settings > Default printer**.

### Print preview

After you select the printer, the selected images are displayed using predefined layouts.

To change the layout, scroll left or right to browse through the available layouts for the selected printer. If the images do

not fit on a single page, scroll up or down to display the additional pages.

### Print settings

The available options vary depending on the capabilities of the printing device you selected.

To set a default printer, select **Options > Default printer**.

To select the paper size, select **Paper size**, the size of paper from the list, and **OK**. Select **Cancel** to return to the previous view.

### Print online

With Print online, you can order prints of images online directly to your home or to a store where you can pick them up. You can also order different products with the selected image, such as mugs or mouse pads. The available products depend on the service provider.

For more information on the application, see the guides available at the Nokia product support pages or your local Nokia website.



## Create a post

Select **Menu** > **Media** > **Share online**.

To post media files to a service, go to a service, and select **Options** > **New upload**. If the online sharing service provides channels for posting files, select the desired channel.

To add an image, video clip, or sound clip to the post, select **Options** > **Insert**.

Enter a title or description for the post, if available.

To add tags to the post, select **Tags**:

To send the post to the service, select **Options** > **Upload**.

## Nokia Podcasting

Select **Menu** > **Media** > **Podcasting**.

Download podcasts to your device, and play them.

## Play and manage podcasts

Podcasting delivers audio or video content over the internet for playback on mobile devices and PCs.

With the Nokia Podcasting application, you can search, discover, subscribe, and download podcasts over the air; and play, manage, and share podcasts with your device.

Define the connection and downloading settings before using the application. Select **Options** > **Settings** > **Connection and Download**.

To search for new podcast episodes to subscribe to, select **Directories**.

To search for podcasts using keywords and podcast show titles, select **Search**.

To display the available episodes from the selected podcast, open the **Podcasts** folder and select **Open**.

To download the selected episode, select **Download**.

To play the downloaded episode, select **Play**.

To update the selected podcast or marked podcasts, for a new episode, select **Options > Update**.

To open the web site of the podcast (network service), select **Options > Open web page**.

Some podcasts provide the opportunity to interact with the creators by commenting and voting. To connect to the internet to do this, select **Options > View comments**.

### Directories

Select **Directories**.

Directories help you find new podcast episodes to which to subscribe.

Contents of the directories change. Select the desired directory folder to update it (network service). The colour of the folder changes, when the update is complete.

To subscribe to a podcast, scroll to the podcast title and select **Update**. After you have subscribed to episodes of a

podcast, you can download, manage, and play them in the podcasts menu.

To add a new directory or folder, select **Options > New > Web directory or Folder**.

Select a title, URL of the .opml (outline processor markup language) file, and **Done**.

To import an .opml file stored on your device, select **Options > Import OPML file**.

To save a received .opml file, open the file to save the file into the **Received** folder in Directories. Open the folder to subscribe to any of the links to add to your podcasts.

### Search podcasts

Search helps you find podcasts by keyword or title.

The search engine uses the podcast search service you set up in **Podcasting > Options > Settings > Connection > Search service URL**.

To search for podcasts, select **Search**, and enter the desired keywords.

**Tip:** Search looks for podcast titles and keywords in descriptions, not specific episodes. General topics, such as football or hip-hop, usually give better results than a specific team or artist.

To subscribe to selected channels and add them to your podcasts, select **Subscribe**.

To start a new search, select **Options > New search**.

To see the details of a podcast, select **Options > Description**.

### Podcasting settings

To edit the connection settings, select **Options > Settings > Connection**.

To edit the download settings, select **Options > Settings > Download**.

To restore the default settings, open the corresponding settings and select **Options > Restore default**.

### Music player

Select **Menu > Media > Music player**.

Music player supports file formats such as AAC, AAC+, eAAC+, MP3, and WMA. Music player does not necessarily support all features of a file format or all the variations of file formats.

### Play a song

Select **Menu > Media > Music player**.

To add all available songs to the music library, select **Options > Refresh library**.

To play a song, select the desired category, and the song.

To pause playback, press the scroll key; to resume, press the scroll key again. To stop playback, scroll down.

To fast-forward or rewind, press and hold the scroll key to the right or left.

To skip to the next item, scroll right. To return to the beginning of the item, scroll left. To skip to the previous item, scroll left again within 2 seconds after a song has started.

To modify the tone of the music playback, select **Options** > **Equaliser**.

To modify the balance and stereo image, or to enhance the bass, select **Options** > **Settings**.

To return to the home screen and leave the player playing in the background, press the end key briefly.

### **Warning:**

Continuous exposure to high volume may damage your hearing. Listen to music at a moderate level, and do not hold the device near your ear when the loudspeaker is in use.

### **Playlists**

To view and manage playlists, select **Music library** > **Playlists**.

To create a new playlist, select **Options** > **New playlist**.

To add songs to the playlist, select the song and **Options** > **Add to playlist** > **Saved playlist** or **New playlist**.

To reorder songs in a playlist, scroll to the song you want to move, and select **Options** > **Reorder playlist**.

### **Ovi Music**

With Ovi Music (network service), you can search, browse, purchase, and download music to your device.

The Ovi Music service will eventually replace the Music store.

**Select Menu** > **Media** > **Ovi Music**.

To download music, you first need to register for the service.

Downloading music may involve additional costs and the transmission of large amounts of data (network service). For information about data transmission charges, contact your network service provider.

To access Ovi Music, you must have a valid internet access point in the device. You may be asked to select the access point to use when connecting to Ovi Music.

### Select the access point

Select **Default access point**.

The availability and appearance of Ovi Music settings may vary. The settings may also be predefined and you may not be able to modify them. When browsing Ovi Music, you may be able to modify the settings.

### Modify Ovi Music settings

Select **Options > Settings**.

Ovi Music is not available for all countries or regions.

### Transfer music from a computer

You can use the following methods to transfer music:

- To install Nokia Ovi Player to manage and organise your music files, download the PC software

from [www.ovi.com](http://www.ovi.com), and follow the instructions.

- To view your device on a computer as a mass memory device where you can transfer any data files, make the connection with a compatible USB data cable or Bluetooth connectivity. If you are using a USB data cable, select **Mass storage** as the USB connection mode. A compatible memory card must be inserted in the device.
- To synchronise music with Windows Media Player, connect a compatible USB data cable, and select **PC Suite** as the USB connection mode. A compatible memory card must be inserted in the device.

To change the default USB connection mode, select **Menu > Ctrl. panel > Connectivity > USB and USB connection mode**.

### Preset frequency settings

Select **Menu > Media > Music player and Options > Go to Now playing > Options > Equaliser**.

To use a preset frequency setting when playing music, select the frequency setting you want to use and **Options** > **Activate**.

To modify the frequency of a preset setting, select **Options** > **Edit** and a frequency band, and scroll up or down to adjust its value. You hear your frequency adjustment immediately in the playback.

To reset the frequency bands to their original values, select **Options** > **Reset to defaults**.

To create your own frequency setting, select **Options** > **New preset**.

Enter a name for the frequency setting.

Scroll up or down to move between the frequency bands, and set the frequency for each band.

### RealPlayer

Select **Menu** > **Media** > **RealPlayer**.

RealPlayer plays video and sound clips that are stored on your device, transferred from an e-mail message, or

a compatible computer, or streamed to your device over the web. Supported file formats include MPEG-4, MP4 (not streaming), 3GP, RV, RA, AMR, and Midi. RealPlayer does not necessarily support all variations of a media file format.

### Play video clips and stream links

To play a video clip, select **Video clips** and a clip.

To list recently played files, in the application main view, select **Recently played**.

To stream content over the air (network service), select **Streaming links** and a link. RealPlayer recognises two kinds of links: an `rtsp://` URL and an `http://` URL that points to a RAM file. Before the content begins streaming, your device must connect to a website and buffer the content. If a network connection problem causes a playback error, RealPlayer attempts automatically to reconnect to the internet access point.

To download video clips from the web, select **Downld. videos**.

To adjust the volume during playback, use the volume keys.

To fast-forward during playback, scroll right and hold. To rewind during play, scroll left and hold.

To stop the playback or streaming, select **Stop**. Buffering or the connection to the streaming site stops, the playback of the clip stops, and the clip rewinds to the beginning.

To view the video clip in normal screen mode, select **Options > Continue in normal scr..**

### View information about a media clip

To view the properties of a video or sound clip, or web link, select **Options > Clip details**. Information may include for example the bit rate or the internet link of a streaming file.

### RealPlayer settings

Select **Menu > Media > RealPlayer**.

You may receive RealPlayer settings in a message from your service provider.

To define the settings manually, select **Options > Settings > Video or Streaming**.

### Recorder

Select **Menu > Media > Recorder**.

With the Recorder application, you can record voice memos and telephone conversations.

The recorder cannot be used when a data call or GPRS connection is active.

To record a sound clip, select .

To stop recording a sound clip, select .

To listen to the sound clip, select .

To select the recording quality or where you want to save your sound clips, select **Options > Settings**.

Recorded sound clips are saved in the Sound clips folder in Gallery.

To record a telephone conversation, open recorder during a voice call, and

select . Both parties hear a tone at regular intervals during recording.

### Nokia Internet Radio

Select **Menu > Media > Radio > Internet radio.**

With the Nokia Internet Radio application (network service), you can listen to available radio stations on the internet. To listen to radio stations, you must have a wireless LAN (WLAN) or packet data access point defined in your device. Listening to the stations may involve the transmission of large amounts of data through your service provider's network. The recommended connection method is WLAN. Check with your service provider for terms and data service fees before using other connections. For example, a flat rate data plan can allow large data transfers for a set monthly fee.

### Listen to internet radio stations

Select **Menu > Media > Radio > Internet radio.**

To listen to a radio station on the internet, do the following:

- 1 Select a station from your favourites or the station directory, or search for stations by name from the Nokia Internet Radio service.

To add a station manually, select **Options > Add station manually.** You can also browse for station links with the Web browser application. Compatible links are automatically opened in the Internet Radio application.

- 2 Select **Options > Listen.**

The Now playing view opens, displaying information about the currently playing station and song.

To pause the playback, press the scroll key; to resume, press the scroll key again.

To view station information, select **Options > Station information** (not available if you have saved the station manually).

If you are listening to a station saved in your favourites, scroll left or right to listen to the previous or next saved station.



## Favourite stations

Select **Menu > Media > Radio > Internet radio**.

To view and listen to your favourite stations, select **Favourites**.

To add a station manually to favourites, select **Options > Add station manually**. Enter the web address of the station and a name that you want to appear in the favourites list.

To add the currently playing station to favourites, select **Options > Add to Favourites**.

To view station information, to move a station up or down in the list, or to delete a station from favourites, select **Options > Station** and the desired option.

To view only stations beginning with particular letters or numbers, start entering the characters. Matching stations are displayed.

## Search for stations

Select **Menu > Media > Radio > Internet radio**.

To search for radio stations in the Nokia Internet Radio service by name, do the following:

- 1 Select **Search**.
- 2 Enter a station name or the first letters of the name in the search field, and select **Search**.  
Matching stations are displayed.

To listen to a station, select the station and **Listen**.

To save a station to your favourites, select the station and **Options > Add to Favourites**.

To make another search, select **Options > Search again**.

## Station directory

Select **Menu > Media > Radio > Internet radio and Station directory**.

The station directory is maintained by Nokia. If you want to listen to internet

radio stations outside the directory, add station information manually or browse for station links on the internet with the Web browser application.

Select from the following:

**Browse by genre** — View the available radio station genres.

**Browse by language** — View the languages in which there are stations broadcasting.

**Browse by country/region** — View the countries in which there are stations broadcasting.

**Top stations** — View the most popular stations in the directory.

### Internet radio settings

Select Menu > Media > Radio > Internet radio and Options > Settings.

To select the default access point to connect to the network, select **Default access point** and from the available options. If you want the device to ask you to select the access point every time you open the application, select **Always ask**.

To change the connection speeds for different connection types, select from the following:

**GPRS connection bitrate** — GPRS packet data connections

**3G connection bitrate** — 3G packet data connections

**Wi-Fi connection bitrate** — WLAN connections

The quality of the radio broadcast depends on the selected connection speed. The higher the speed, the better the quality. To avoid buffering, use the highest quality only with high speed connections.

### Security and data management

Manage the data and software on your device, and take care of the security of the device and its contents.

**Important:** Your device can only support one antivirus application. Having more than one application with antivirus functionality could affect performance and operation or cause the device to stop functioning.

## Lock the device

The lock code protects your device against unauthorised use. The preset code is 12345.

To lock the device, in the home screen, press the power key, and select **Lock phone**.

To unlock your device, select **Unlock** > **OK**, enter the lock code, and select **OK**.

To change the lock code, select **Menu** > **Ctrl. panel** > **Settings and General** > **Security** > **Phone and SIM card**. Enter the old code and then the new code twice. A minimum of 6 characters is required, and numbers, symbols, and upper and lower case letters can be used.

Keep the lock code secret and in a safe place separate from your device. If you forget the lock code and your device is locked, your device will require service. Additional charges may apply, and all the personal data in your device may be deleted. For more information, contact a Nokia Care point or your device dealer.

You can also lock the device remotely by sending a text message to the device.

## Lock your device remotely

- 1 To enable remote locking, select **Menu** > **Ctrl. panel** > **Settings and General** > **Security** > **Phone and SIM card** > **Remote phone locking** > **Enabled**.
- 2 Enter the text message content. It can be 5-20 characters, and both upper and lower case letters can be used.
- 3 Enter the same text again to verify it.
- 4 Enter the lock code.
- 5 To lock the device remotely, write the predefined text, and send it to your device as a text message. To unlock your device, you need the lock code.

## Memory card security

Select **Menu** > **Office** > **File mgr.**.

To set a password, select **Options** > **Memory card password** > **Set**. The password can be up to 8 characters long and is case-sensitive. The password is stored in your device. You do not need

to enter it again while you use the memory card on the same device. If you use the memory card on another device, you are asked for the password. Not all memory cards support password protection.

To remove the memory card password, select **Options > Memory card password > Remove**. When you remove the password, the data on the memory card is not protected against unauthorised use.

To open a locked memory card, select **Options > Unlock memory card**. Enter the password.

If you cannot recall the password to unlock a locked memory card, you may reformat the card, in which case the card is unlocked and password removed. Formatting a memory card deletes all data stored on the card.

### Encryption

Select **Menu > Ctrl. panel > Data mgr. > Encryption**.

Encrypt your device or memory card to prevent outsiders from accessing your important information.

### Encrypt device memory or memory card

To encrypt the device memory, select **Phone memory**.

To encrypt the memory card, select **Memory card** and from the following:

**Encrypt without saving key** — Encrypt the memory card without saving the encryption key. If you select this option, you cannot use the memory card in other devices, and if you restore factory settings, you cannot decrypt the memory card.

**Encrypt and save key** — Encrypt the memory card and save the key manually in the default folder. For security, store the key to a safe place outside the device. For example, you can send the key to your computer. Enter a pass phrase for the key and a name for the key file. The pass phrase should be long and complex.

**Encrypt with restored key** — Encrypt the memory card with a key you have

received. Select the key file, and enter the pass phrase.

### **Decrypt device memory or memory card**

Always remember to decrypt the device memory and/or the memory card before updating the device software.

To decrypt the device memory, select **Phone memory**.

To decrypt the memory card without destroying the encryption key, select **Memory card > Decrypt**.

To decrypt the memory card and destroy the encryption key, select **Memory card > Decrypt and turn off encryption**.

### **Fixed dialling**

Select **Menu > Contacts and Options > SIM numbers > Fixed dial contacts**.

With the fixed dialling service, you can restrict calls from your device to certain phone numbers. Not all SIM cards support the fixed dialling service. For

more information, contact your service provider.

When security features that restrict calls are in use (such as call barring, closed user group, and fixed dialling), calls may be possible to the official emergency number programmed into your device. Call barring and call diverting cannot be active at the same time.

You need your PIN2 code to activate and deactivate fixed dialling or edit your fixed dialling contacts. Contact your service provider for your PIN2 code.

Select **Options** and from the following:

**Activate fixed dialling** — Activate the fixed dialling.

**Deactivate fixed dialling** — Deactivate the fixed dialling.

**New SIM contact** — Enter the contact name and phone number to which calls are allowed.

**Add from Contacts** — Copy a contact from the list of contacts to the fixed dialling list.

To send text messages to the SIM contacts while the fixed dialling service is active, you need to add the text

message centre number to the fixed dialling list.

### Certificate manager

Select Menu > Ctrl. panel > Settings and General > Security > Certificate management.

Digital certificates are used to verify the origins of software but do not guarantee safety. There are four different types of certificates: authority certificates, personal certificates, trusted site certificates, and device certificates. During a secure connection, a server may send a server certificate to your device. Upon receipt, it is checked through an authority certificate stored in your device. You receive notification if the identity of the server is not authentic or if you do not have the correct certificate in your device.

You can download a certificate from a web site, or receive a certificate as a message. Certificates should be used when you connect to an online bank or a remote server to transfer confidential information. They should also be used if you want to reduce the risk of viruses or other malicious software, and to check the authenticity of software when you

download and install software to your device.

**Tip:** When you add a new certificate, check its authenticity.

### View certificate details

You can only be sure of the correct identity of a server when the signature and the validity period of a server certificate have been checked.

To view certificate details, open a certificate folder, and select a certificate and **Options > Certificate details**.

One of the following notes may appear:

**Certificate not trusted** — You have not set any application to use the certificate. You may want to change the trust settings.

**Expired certificate** — The period of validity has ended for the selected certificate.

**Certificate not valid yet** — The period of validity has not yet begun for the selected certificate.

**Certificate corrupted** — The certificate cannot be used. Contact the certificate issuer.

## Certificate trust settings

Select Menu > Ctrl. panel > Settings and General > Security > Certificate management.

Trusting a certificate means that you authorise it to verify web pages, e-mail servers, software packages, and other data. Only trusted certificates can be used to verify services and software.

**Important:** Even if the use of certificates makes the risks involved in remote connections and software installation considerably smaller, they must be used correctly in order to benefit from increased security. The existence of a certificate does not offer any protection by itself; the certificate manager must contain correct, authentic, or trusted certificates for increased security to be available. Certificates have a restricted lifetime. If "Expired certificate" or "Certificate not valid yet" is shown, even if the certificate should be valid, check that the current date and time in your device are correct.

Before changing any certificate settings, you must make sure that you really trust the owner of the certificate and that the

certificate really belongs to the listed owner.

To change the trust settings, select a certificate and **Options > Trust settings**. Scroll to an application field, and press the scroll key to select **Yes** or **No**. You cannot change the trust settings of a personal certificate.

Depending on the certificate, a list of applications that can use the certificate is displayed:

**Symbian installation** — New Symbian operating system application.

**Internet** — E-mail and graphics.

**App. installation** — New Java application.

**Online certif. check** — Online certificate status protocol.

## View and edit security modules

Select Menu > Ctrl. panel > Settings and General > Security > Security module.

To view or edit a security module, select the module from the list.

To view detailed information about a security module, select **Options** > **Security details**.

To edit the PIN codes for the security module, open the module, and select **Module PIN** to edit the PIN code for the security module or **Signing PIN** to edit the PIN code for digital signatures. You may not be able to change these codes for all security modules.

The key store contains the contents of the security module. To delete the key store, select **Options** > **Delete**. You may not be able to delete the key store of all security modules.

### Remote configuration

Select **Menu** > **Ctrl. panel** > **Data mgr.** > **Device mgr.**

With Device manager, you can manage settings, data, and software on your device remotely.

You can connect to a server, and receive configuration settings for your device. You may receive server profiles and different configuration settings from your service providers or company

information management department. Configuration settings may include connection and other settings used by different applications in your device. The available options may vary.

The remote configuration connection is usually started by the server when the device settings need to be updated.

To create a new server profile, select **Options** > **Server profiles** > **Options** > **New server profile**.

You may receive these settings from your service provider in a configuration message. If not, define the following:

**Server name** — Enter a name for the configuration server.

**Server ID** — Enter the unique ID to identify the configuration server.

**Server password** — Enter a password to identify your device to the server.

**Access point** — Select the access point to use for the connection, or create a new access point. You can also choose to be asked for the access point every time you start a connection. This setting is available only if you have selected **Internet** as the bearer type.



**Host address** — Enter the web address of the configuration server.

**Port** — Enter the port number of the server.

**User name** and **Password** — Enter your user ID and password for the configuration server.

**Allow configuration** — Select **Yes** to allow the server to initiate a configuration session.

**Auto-accept all requests** — Select **Yes** if you do not want the server to ask for your confirmation when it initiates a configuration session.

**Network authentication** — Select whether to use http authentication.

**Network user name** and **Network password** — Enter your user ID and password for the http authentication. This setting is available only if you have selected **Network authentication** to be used.

To connect to the server and receive configuration settings for your device, select **Options > Start configuration**.

To view the configuration log of the selected profile, select **Options > View log**.

To update the device software over the air, select **Options > Check for updates**. The update does not erase your settings. When you receive the update package on your device, follow the instructions on the display. Your device is restarted once the installation is complete.

Downloading software updates may involve the transmission of large amounts of data (network service).

Make sure that the device battery has enough power, or connect the charger before starting the update.

**Warning:**

If you install a software update, you cannot use the device, even to make emergency calls, until the installation is completed and the device is restarted. Be sure to back up data before accepting installation of an update.

### Application manager

With Application manager, you can see the software packages installed in your device. You can view details of installed applications, remove applications, and define installation settings.

You can install two types of applications and software to your device:

- JME applications based on Java technology with the .jad or .jar file extensions
- Other applications and software suitable for the Symbian operating system with the .sis or .six file extensions

Only install software that is compatible with your device.

### Install applications and software

You can transfer installation files to your device from a compatible computer, download them during browsing, or receive them in a multimedia message, as an e-mail attachment, or using other connectivity methods, such as Bluetooth connectivity. You can use Nokia Application Installer in Nokia Ovi Suite to install an application to your device.

Select **Menu > Ctrl. panel > Data mgr. > App. mgr.**

The installation files are in the Installation files folder, and installed applications in the Installed apps. folder.

Icons indicate the following:



.sis or .six application



Java application



Application not fully installed

Application installed on the memory card

**Important:** Only install and use applications and other software from trusted sources, such as applications that are Symbian Signed or have passed the Java Verified™ testing.

Before installation, note the following:

- To view the application type, version number, and the supplier or manufacturer of the application, select **Options > View details**.

To display the security certificate details of the application, select **Details: > Certificates: > View details**.

- If you install a file that contains an update or repair to an existing application, you can only restore the original application if you have the original installation file or a full backup copy of the removed software package. To restore the original application, remove the application, and install the application again from the original installation file or the backup copy.

The JAR file is required for installing Java applications. If it is missing, the device may ask you to download it. If there is no access point defined for the application, you are asked to select one. When you are asked to download the JAR file, you may need to enter a user name and password to access the server. You obtain these from the supplier or manufacturer of the application.

To install an application or software, do the following:

- 1 To locate an installation file, select **Menu > Ctrl. panel > Data mgr. > App. mgr. and Installation files.** Alternatively, search installation files using File manager, or select

**Messaging > Inbox**, and open a message that contains an installation file.

- 2 In Application manager, select the application you want to install.

During installation, the device shows information about the progress of the installation. If you install an application without a digital signature or certification, the device displays a warning. Continue installation only if you are sure of the origin and contents of the application.

To start an installed application, select the application. If the application does not have a default folder defined, it is installed in the Installations folder in the main menu.

To see which software packages are installed or removed and when, select **Options > View log.**

**Important:** Your device can only support one antivirus application. Having more than one application with antivirus functionality could affect performance and operation or cause the device to stop functioning.

After you install applications to a compatible memory card, installation files (.sis, .sisx) remain in the device memory. The files may use large amounts of memory and prevent you from storing other files. To maintain sufficient memory, use Nokia Ovi Suite to back up installation files to a compatible PC, then use the file manager to remove the installation files from the device memory. If the .sis file is a message attachment, delete the message from the Messaging inbox.

### Remove applications and software

Select **Menu > Ctrl. panel > Data mgr. > App. mgr.**.

Scroll to a software package, and select **Options > Uninstall**. Select **Yes** to confirm.

If you remove software, you can only reinstall it if you have the original software package or a full backup of the removed software package. If you remove a software package, you may no longer be able to open documents created with that software.

If another software package depends on the software package that you

removed, the other software package may stop working. For more information, see the documentation of the installed software package.

### Application manager settings

Select **Menu > Ctrl. panel > Data mgr. > App. mgr.**.

Select **Options > Settings** and from the following:

**Software installation** — Select whether Symbian software that has no verified digital signature can be installed.

**Online certificate check** — Check the online certificates before installing an application.

**Default web address** — Set the default address used when checking online certificates.

Some Java applications may require that a message be sent or a network connection be made to a specific access point to download extra data or components.

### Licenses

#### Digital rights management

Content owners may use different types of digital rights management (DRM) technologies to protect their intellectual property, including copyrights. This device uses various types of DRM software to access DRM-protected content. With this device you can access content protected with WMDRM 10 and OMA DRM 2.0. If certain DRM software fails to protect the content, content owners may ask that such DRM software's ability to access new DRM-protected content be revoked. Revocation may also prevent renewal of such DRM-protected content already in your device. Revocation of such DRM software does not affect the use of content protected with other types of DRM or the use of non-DRM-protected content.

### **About Licenses**

Select **Menu > Ctrl. panel > Data mgr. > Licences.**

Some media files, such as images, music, or video clips, are protected by digital usage rights. The licenses for such files may allow or restrict their usage. For example, with some licenses you may listen to a song only a limited number of times. During one playback

session you may rewind, fast-forward, or pause the song, but once you stop it, you have used one of the instances allowed.

### **Use licences**

Digital rights management (DRM) protected content comes with an associated licence that defines your rights to use the content.

If your device has OMA DRM-protected content, to back up both the licence and the content, use the backup feature of Nokia Ovi Suite.

Other transfer methods may not transfer the licence which need to be restored with the content for you to be able to continue the use of OMA DRM-protected content after the device memory is formatted. You may also need to restore the licence in case the files on your device get corrupted.

If your device has WMDRM-protected content, both the licence and the content will be lost if the device memory is formatted. You may also lose the licence and the content if the files on your device get corrupted. Losing the licence or the content may limit your

ability to use the same content on your device again. For more information, contact your service provider.

Some licence may be connected to a specific SIM card, and the protected content can be accessed only if the SIM card is inserted in the device.

To view your licences by type, select **Valid licences**, **Invalid licences**, or **Not in use**.

To view the licence details, select **Options** > **Licence details**.

The following details are displayed for each media file:

**Status** — The status is **Licence is valid**, **Licence expired**, or **Licence not yet valid**.

**Content sending** — **Allowed** indicates that you can send the file to another device.

**Content in phone** — **Yes** indicates that the file is in the device and the path of the file is displayed. **No** indicates that the related file is not currently in the device.

To activate a licence, in the licences main view, select **Invalid licences** > **Options** > **Get licence**. Establish a network connection at the prompt, and you are directed to a website where you can purchase rights to the media.

To remove file rights, go to the desired file, and select **Options** > **Delete**. If there are several rights related to the same media file, all the rights are deleted.

The group licence view displays all of the files related to a group right. If you have downloaded multiple media files with the same rights, they are all displayed in this view. You can open the group view from either the valid licences or invalid licences tabs. To access these files, open the group rights folder.

### **Sync**

Select **Menu** > **Ctrl. panel** > **Connectivity** > **Sync**.

Sync enables you to synchronise your notes, calendar entries, text and multimedia messages, browser bookmarks, or contacts with various

compatible applications on a compatible computer or on the internet.

You may receive synchronisation settings in a special message from your service provider.

A synchronisation profile contains the necessary settings for synchronisation.

When you open the Sync application, the default or previously used sync profile is displayed. To modify the profile, scroll to a sync item, and select **Mark** to include it in the profile or **Unmark** to leave it out.

To manage sync profiles, select **Options** and the desired option.

To synchronise data, select **Options** > **Synchronise**.

To cancel synchronisation before it finishes, select **Cancel**.

### **Mobile VPN**

Select **Menu** > **Ctrl. panel** > **Settings** and **Connection** > **VPN**.

The Nokia mobile virtual private network (VPN) client creates a secure connection to compatible corporate intranet and services, such as e-mail. Your device connects from a mobile network, through the internet, to a corporate VPN gateway that acts as a front door to the compatible corporate network. The VPN client uses IP Security (IPSec) technology. IPSec is a framework of open standards for supporting the secure exchange of data over IP networks.

VPN policies define the method used by the VPN client and a VPN gateway to authenticate each other, and the encryption algorithms that they use to help protect the confidentiality of data. For a VPN policy, contact your company's IT department.

To install and configure the VPN client, certificates, and policies, contact the IT administrator of your organisation.

### **Manage VPN**

Select from the following:

**VPN policies** — Install, view, and update VPN policies.

**VPN policy servers** — Edit the connection settings of VPN policy servers from which you can install and update VPN policies. A policy server refers to a Nokia Security Service Manager (NSSM), which is not necessarily required.

**VPN log** — View the log for your VPN policy installations, updates and synchronisations, and other VPN connections.

### Edit VPN access points

Select **Menu > Ctrl. panel > Settings and Connection > Destinations**.

An access point is where your phone connects to the network. To use e-mail and multimedia services, or to browse web pages, you must first define internet access points for these services. Virtual private network (VPN) access points pair VPN policies with regular internet access points to create secure connections.

Your service provider may preset some or all access points for your device, and you may not be able to create, edit, or remove them.

Select a destination and **Options > Edit**, and define the following:

**Connection name** — Enter a name for the VPN access point.

**VPN policy** — Select the VPN policy to combine with the internet access point.

**Internet access point** — Select the internet access point with which to combine the VPN policy to create secure connections for data transfer.

**Proxy server address** — Enter the proxy server address of the private network.

**Proxy port number** — Enter the proxy port number.

**Use access point** — Select whether connections using this access point are established automatically.

The settings available for editing may vary.

For the correct settings, contact your company's IT department.

### Use a VPN connection in an application

You may have to prove your identity when you log on to the enterprise



network. Contact your company's IT department for the credentials.

To use a VPN connection in an application, the application must be associated with a VPN access point.

**Tip:** You can configure the application's connection setting to **Always ask**, in which case you select the VPN access point from a list of connections when a connection is established.

- 1 In the application in which you want to create a VPN connection, select a VPN access point as the access point.
- 2 If you are using legacy authentication, enter your VPN user name and passcode or password. If the SecurID token has become out of synchronisation with the clock of the ACE/Server, enter the next passcode. If you are using certificate-based authentication, you may have to enter the key store password.

## Settings

Select **Menu** > **Ctrl. panel** > **Settings**.

You can define and modify various settings of your device. Modifying these settings affects the operation of your device across several applications.

Some settings may be preset for the device or sent to you in a special message by your service provider. You may not be able to change such settings.

Select the setting you want to edit to do the following:

- Switch between two values, such as on or off.
- Select a value from a list.
- Open a text editor to enter a value.
- Open a slider, and scroll left or right to adjust a value.

### General settings

Select **Menu** > **Ctrl. panel** > **Settings** and **General**.

Select from the following:

**Personalisation** — Modify the display settings, and personalise the device.

**Date and time** — Change the date and time.

**Enhancement** — Modify the settings for your accessories.

**Security** — Modify the security settings.

**Factory settings** — Restore the original settings of the device.

**Positioning** — Define the positioning method and server for GPS-based applications.

The available options may vary.

### Personalisation settings

Select **Menu > Ctrl. panel > Settings** and **General > Personalisation**.

### Display settings

---

To define the level of light that the device needs before switching on the backlight, select **Display > Light sensor**.

To change the text size, select **Display > Font size**.

To adjust the length of time the display can be left idle before the screen saver is activated, select **Display > Power saver time-out**.

To select a welcome note or logo for the display, select **Display > Welcome**

**note / logo**. You can either choose the default welcome note, enter your own text, or select an image.

To set how quickly the display dims after the last keypress, select **Display > Light time-out**.

### Tone settings

---

Select **Menu > Ctrl. panel > Settings**.

Select **General > Personalisation > Tones** and from the following:

**Ringing tone** — Select a ringing tone from the list, or select **Download sounds** to open a bookmark folder containing a list of bookmarks for downloading tones using the browser. If you have two alternate phone lines in use, you can specify a ringing tone for each line.

**Video call tone** — Select a ringing tone for video calls.

**Say caller's name** — If you select this setting, and someone from your contacts list calls you, the device sounds a ringing tone that is a combination of the spoken name of the contact and the selected ringing tone.

**Ringing type** — Select how you want the ringing tone to alert you.

**Ringing volume** — Set the volume level of the ringing tone.

**Message alert tone** — Select a tone for received text messages.

**E-mail alert tone** — Select a tone for received e-mail messages.

**Calendar alarm tone** — Select a tone for calendar alerts.

**Clock alarm tone** — Select a tone for clock alarms.

**Vibrating alert** — Set the device to vibrate when you receive a call or message.

**Keypad tones** — Set the volume level of the keypad tones.

**Warning tones** — Activate the warning tones.

**T-coil hearing aid mode** — Activate T-coil hearing aid mode.

---

## Language settings

Select Menu > Ctrl. panel > Settings and General > Personalisation > Language.

**Phone language** — Set the device language.

**Writing language** — Select the language used for writing notes and messages.

**Predictive text** — Activate predictive text input.

**Input options** — Define the settings for predictive text input.

---

## Messaging key settings

Select Menu > Ctrl. panel > Settings and General > Personalisation > Messaging key.

To select which application or task is opened when you press the messaging key, select **Messaging key**.

To restore the preset application or task, select **Restore defaults**.

---

## Date and time settings

Select Menu > Ctrl. panel > Settings and General > Date and time.

Select from the following:

**Date and Time** — Set the current date and time.

**Time zone** — Define your time zone.

**Date format and Date separator** — Define the date format and separator.

**Time format and Time separator** — Select whether to use the 12-hour or 24-hour clock system and with which symbol to separate hours and minutes.

**Clock type** — Define the clock type.

**Clock alarm tone** — Select the tone for the alarm clock.

**Alarm snooze time** — Define the snooze time for the alarm clock.

**Workdays** — Define the days of the week that are work days for you.

**Automatic time update** — Update the time, date, and time zone information automatically (network service).

### Accessory settings

Select **Menu** > **Ctrl. panel** > **Settings** and **General** > **Enhancement**.

To define which profile is activated when you attach an accessory to your device, select the accessory and **Default profile**.

To set the device to answer phone calls automatically after 5 seconds when an

accessory is attached, select the accessory and **Automatic answer** > **On**. If the ringing type is set to **Beep once** or **Silent** in the selected profile, automatic answering is disabled.

To illuminate the device while it is attached to an accessory, select **Lights** > **On**. This option is only available for certain accessories.

### Security settings

#### Security settings

---

Select **Menu** > **Ctrl. panel** > **Settings** and **General** > **Security**.

Select from the following:

**Phone and SIM card** — Modify the security settings for your device and SIM card.

**Certificate management** — Manage your security certificates.

**Protected content** — Modify your settings for DRM-protected content.

**Security module** — Manage your security module.

Avoid using codes that are similar to emergency numbers to prevent accidental dialling of the emergency

number. Codes are shown as asterisks. When you change a code, enter the current code, then the new code twice.

### Device and SIM card security

Select **Menu > Ctrl. panel > Settings > General > Security.**

To change the PIN code, select **Phone and SIM card > PIN code.** The new code must be 4 to 8 digits long. The PIN code protects your SIM card against unauthorised use and is provided with the SIM card. After three consecutive incorrect PIN code entries, the code is blocked, and you need to use the PUK code to unblock it before you can use the SIM card again.

To set the keypad to lock automatically after a defined period, select **Phone and SIM card > Keypad autolock period.**

To set a time-out period after which the device is automatically locked and can be used only if the correct lock code is entered, select **Phone and SIM card > Phone autolock period.** Enter the length of the time-out period in minutes, or select **None** to deactivate the autolock feature. When the device is

locked, you can still answer incoming calls, and calls may still be possible to the official emergency number programmed into your device.

To change the lock code, select **Phone and SIM card > Lock code.** The default lock code is 12345. Enter the current code and then the new code twice. The new code must be 4-255 characters long. Alphanumeric (uppercase and lowercase) characters can be used. The device notifies you if the lock code is not properly formatted.

### Restore original settings

To restore the original device settings, select **Menu > Ctrl. panel > Settings and General > Factory settings.** To do this, you need your device lock code. After resetting, the device may take a longer time to switch on. Documents, contact information, calendar entries, and files are unaffected.

### Positioning settings

Select **Menu > Ctrl. panel > Settings and General > Positioning.**

To use a specific positioning method to detect the location of your device, select **Positioning methods**.

To select a positioning server, select **Positioning server**.

To select which measurement system you want to use for speeds and distances, select **Notation preferences** > **Measurement system**.

To define in which format the coordinate information is displayed in your device, select **Notation preferences** > **Coordinate format**.

### Telephone settings

Select **Menu** > **Ctrl. panel** > **Settings** and **Phone**.

Select from the following:

**Call** — Define general call settings.

**Call divert** — Define your call divert settings. [See "Call divert", p. 34.](#)

**Call barring** — Define your call barring settings. [See "Call barring", p. 35.](#)

**Network** — Adjust the network settings.

### Call settings

Select **Menu** > **Ctrl. panel** > **Settings** and **Phone** > **Call**.

Select from the following:

**Send my caller ID** — Display your phone number to the person you are calling.

**Call waiting** — Set the device to notify you of incoming calls while you are in a call (network service).

**Reject call with message** — Reject a call, and send a text message to the caller.

**Message text** — Write the standard text message that is sent when you reject a call.

**Own video in recvd. call** — Allow or deny video sending during a video call from your device.

**Image in video call** — Display a still image if video is not sent during a video call.

**Automatic redial** — Set your device to make a maximum of 10 attempts to connect the call after an unsuccessful call attempt. To stop automatic redialling, press the end key.

**Show call duration** — Display the length of a call during the call.

**Summary after call** — Display the length of a call after the call.

**Speed dialling** — Activate speed dialling.

**Anykey answer** — Activate anykey answer.

**Noise cancellation** — Activate earpiece active noise cancellation.

**Contact search** — Activate contact search in the home screen.

## Network settings

Select **Menu > Ctrl. panel > Settings and Phone > Network.**

To select the network mode, select **Network mode** and **Dual mode**, **UMTS**, or **GSM**. In dual mode, the device switches automatically between networks.

**Tip:** Selecting **UMTS** enables faster data transfer, but may increase the demand on battery power and reduce the battery life. In regions close to both **GSM** and **UMTS** networks, selecting **Dual mode** may cause constant jumping

between the two networks, which also increases the demand on battery power.

To select the operator, select **Operator selection** and **Manual** to select from available networks, or **Automatic** to set the device to select the network automatically.

To set the device to indicate when it is used in a microcellular network (MCN), select **Cell info display > On.**

## Connection settings

Select **Menu > Ctrl. panel > Settings and Connection.**

Select from the following:

**Bluetooth** — Edit the Bluetooth settings.

**USB** — Edit the data cable settings.

**Destinations** — Set up new or edit existing access points. Some or all access points may be preset for your device by your service provider, and you may not be able to create, edit, or remove them.

**VPN** — Manage the settings for virtual private networking.

**Packet data** — Define when packet data network is attached, and enter the default packet switched access point name if you use your device as a modem for a computer.

**Wireless LAN** — Set the device to display an indicator when a wireless LAN (WLAN) is available, and define how often the device searches for networks.

**Video sharing** — Enable video sharing, select the SIP profile for video sharing, and define the video saving settings.

**SIP settings** — View or create session initiation protocol (SIP) profiles.

**XDM profile** — Create an XDM profile. The XDM profile is required for many communications applications, for example, presence.

**Presence** — Edit the settings for presence (network service). To register for the service, contact your service provider.

**Remote drives** — Connect the device to a remote drive.

**Configurations** — View and delete trusted servers from which your device may receive configuration settings.

### Access points

#### Create a new access point

---

Select **Menu > Ctrl. panel > Settings and Connection > Destinations**.

You may receive access point settings in a message from a service provider. Some or all access points may be preset for your device by your service provider, and you may not be able to change, create, edit, or remove them.

When you select one of the access point groups (🌐, 📶, 0, ?, 🌐), you can see the access point types:



indicates a protected access point



indicates a packet data access point



indicates a wireless LAN (WLAN) access point

**Tip:** You can create internet access points in a WLAN with the WLAN wizard.

To create a new access point, select **Access point**.

The device asks to check for available connections. After the search, connections that are already available



are displayed and can be shared by a new access point.

If you skip this step, you are asked to select a connection method and to define the settings needed.

To edit the settings of an access point, select one of the access point groups, scroll to an access point, and select **Options** > **Edit**. Use the instructions provided by your service provider to edit the following:

**Connection name** — Enter a name for the connection.

**Data bearer** — Select the data connection type.

Depending on the data connection you select, only certain setting fields are available. Fill in all fields marked with **Must be defined** or with a red \*. Other fields can be left empty, unless your service provider has instructed otherwise.

To use a data connection, your service provider must support this feature, and if necessary, activate it for your SIM card.

---

## Create access point groups

Select **Menu** > **Ctrl. panel** > **Settings and Connection** > **Destinations**.

Some applications allow you to use access point groups to connect to a network.

To avoid selecting which access point to use every time the device attempts to connect to a network, you can create a group that contains various access points, and define the order in which the access points are used to connect to a network.

For example, you can add wireless LAN (WLAN) and packet data access points to an internet access point group and use the group for browsing the web. If you give the WLAN access point the higher priority, the device connects to the internet through a WLAN if available and through a packet data connection if not.

To create a new access point group, select **Options** > **Manage** > **New destination**.

To add access points to an access point group, select the group and **Options** > **New access point**. To copy an existing access point from another group, select the group, scroll to an existing access point, and select **Options** > **Organise** > **Copy to other dest..**

To change the priority order of access points within a group, scroll to an access point, and select **Options** > **Organise** > **Change priority**.

### Packet data access points

---

Select **Menu** > **Ctrl. panel** > **Settings** and **Connection** > **Destinations** > **Access point**, and follow the instructions on the screen.

To edit a packet data access point, open one of the access point groups, and select an access point marked with .

Follow the instructions from your service provider.

Select from the following:

**Connection name** — Define a name for the connection.

**Data bearer** — You might not be able to edit the data bearer once defined. Define a new access point if needed.

**Access point name** — You obtain the access point name from your service provider.

**User name** — The user name may be needed to make a data connection, and is usually provided by your service provider.

**Prompt password** — If you must enter the password every time you log in to a server, or if you do not want to save your password in the device, select **Yes**.

**Password** — A password may be needed to make a data connection and is usually provided by your service provider.

**Authentication** — Select **Secure** to always send your password encrypted or **Normal** to send your password encrypted when possible.

**Homepage** — Depending on the access point you are setting up, enter the web address or the address of the multimedia message centre.

**Use access point** — Select **After confirmation** if you want the device to ask for confirmation before the connection using this access point is created, or **Automatically** if you want the device to connect to the destination using this access point automatically.

Select **Options > Advanced settings** and from the following:

**Network type** — Select the internet protocol type to transfer data to and from your device. The other settings depend on the selected network type.

**Phone IP address** (for IPv4 only) — Enter the IP address of your device.

**DNS addresses** — Enter the IP addresses of the primary and secondary DNS servers, if required by your service provider. To obtain these addresses, contact your internet service provider.

**Proxy server address** — Enter the address of the proxy server.

**Proxy port number** — Enter the port number of the proxy server.

### **WLAN internet access points**

Select **Menu > Ctrl. panel > Settings and Connection > Destinations >**

**Access point**, and follow the instructions on the display. Or, open one of the access point groups, select an access point marked with , and select **Edit**.

Use the instructions provided by your service provider to edit the following:

**Connection name** — Define a name for the connection.

**Data bearer** — You might not be able to edit the data bearer once defined. Define a new access point if needed.

**WLAN network name** — Select **Enter manually** or **Search for networks**. If you select an existing network, **WLAN network mode** and **WLAN security mode** are determined by the settings of its access point device.

**Network status** — Define whether the network name is displayed.

**WLAN network mode** — Select **Ad-hoc** to create an ad hoc network, and to allow devices to send and receive data directly; a WLAN access point device is not needed. In an ad hoc network, all devices must use the same WLAN network name.

**WLAN security mode** — Select the encryption used: **WEP**, **802.1x**, or **WPA/WPA2**. (802.1x and WPA/WPA2 are not available for ad hoc networks.) If you select **Open network**, no encryption is used. The WEP, 802.1x, and WPA functions can be used only if the network supports them.

**Use access point** — Select **After confirmation** to set the device to ask for confirmation before the connection using this access point is created or **Automatically** to set the device to connect to the destination using this access point automatically.

To enter the settings for the selected security mode, select **WLAN security settings**.

### Advanced WLAN settings

---

Select **Options** > **Advanced settings** and from the following:

**IPv4 settings** — Enter the IP address of your device, the subnet IP address, the default gateway, and the IP addresses of the primary and secondary DNS servers. Contact your internet service provider for these addresses.

**IPv6 settings** — Define the type of DNS address.

**Ad-hoc channel** (only for ad hoc networks) — To enter a channel number (1-11) manually, select **User defined**.

**Proxy server address** — Enter the address for the proxy server.

**Proxy port number** — Enter the proxy port number.

### Packet data (GPRS) settings

Select **Menu** > **Ctrl. panel** > **Settings** and **Connection** > **Packet data**.

Your device supports packet data connections, such as GPRS in the GSM network. When you are using your device in GSM and UMTS networks, it is possible to have multiple data connections active at the same time; access points can share a data connection, and data connections remain active, for example, during voice calls.

To define the packet data settings, select **Packet data connection** and **When available** to register the device to the packet data network when you switch the device on in a supported

network, or **When needed** to register the device to a packet data network only when an application or action attempts to establish a packet data connection. This setting affects all access points for packet data connections.

To use the device as a packet data modem for your computer, select **Access point**, and enter the access point name provided by your service provider.

### WLAN settings

Select **Menu > Ctrl. panel > Settings and Connection > Wireless LAN**.

To have an indicator displayed when there is a wireless LAN (WLAN) available in your current location, select **Show WLAN availability > Yes**.

To select the interval for your device to scan for available WLANs, and to update the indicator, select **Scan for networks**. This setting is not available unless you select **Show WLAN availability > Yes**.

To set the device to test the internet capability of the selected WLAN

automatically, to ask for permission every time, or to never perform the connectivity test, select **Internet connectivity test > Run automatically, Ask every time, or Never run**. If you select **Run automatically** or allow the test to be performed when the device asks for it, and the connectivity test is performed successfully, the access point is saved to internet destinations.

To check the unique media access control (MAC) address that identifies your device, enter **\*#62209526#** in the home screen. The MAC address is displayed.

### Advanced WLAN settings

Select **Options > Advanced settings**. The advanced WLAN settings are normally defined automatically, and changing them is not recommended.

To edit the settings manually, select **Automatic configuration > Disabled**, and define the following:

**Long retry limit** — Enter the maximum number of transmission attempts if the device does not receive a receiving

acknowledgement signal from the network.

**Short retry limit** — Enter the maximum number of transmission attempts if the device does not receive a clear-to-send signal from the network.

**RTS threshold** — Select the data packet size at which the WLAN access point device issues a request to send before sending the packet.

**TX power level** — Select the power level of your device when sending data.

**Radio measurements** — Enable or disable the radio measurements.

**Power saving** — Select whether to use the WLAN power saving mechanism to save the power in the device battery. Using the power saving mechanism enhances the battery performance but may weaken WLAN interoperability.

To restore all settings to their original values, select **Options > Restore defaults**.

### WLAN security settings

Select **Menu > Ctrl. panel > Settings and Connection > Destinations >**

**Access point**, and follow the instructions on the display.

To edit a wireless LAN (WLAN) access point, open one of the access point groups, and select an access point marked with .

To enter the settings for the selected security mode, select **WLAN security settings**.

### WEP security settings

Select **WEP** as the WLAN security mode.

The wired equivalent privacy (WEP) encryption method encrypts data before it is transmitted. Access to the network is denied to users who do not have the required WEP keys. When the WEP security mode is in use, and your device receives a data packet not encrypted with the WEP keys, the data is discarded.

In an ad-hoc network, all devices must use the same WEP key.

Select **WLAN security settings** and from the following:

**WEP key in use** — Select the desired WEP key.

**Authentication type** — Select **Open** or **Shared**.

**WEP key settings** — Edit the settings for the WEP key.

### WEP key settings

In an ad-hoc network, all devices must use the same WEP key.

Select **WLAN security settings** > **WEP key settings** and from the following:

**WEP encryption** — Select the desired WEP encryption key length.

**WEP key format** — Select whether you want to enter the WEP key data in **ASCII** or **Hexadecimal** format.

**WEP key** — Enter the WEP key data.

### 802.1x security settings

Select **802.1x** as the WLAN security mode.

**802.1x** authenticates and authorises devices to access a wireless network, and prevents access if the authorisation process fails.

Select **WLAN security settings** and from the following:

**WPA/WPA2** — Select **EAP** (Extensible Authentication Protocol) or **Pre-shared key** (a secret key used for device identification).

**EAP plug-in settings** — If you selected **WPA/WPA2** > **EAP**, select which EAP plug-ins defined in your device to use with the access point.

**Pre-shared key** — If you selected **WPA/WPA2** > **Pre-shared key**, enter the shared private key that identifies your device to the WLAN to which you connect.

### WPA security settings

Select **WPA/WPA2** as the WLAN security mode.

Select **WLAN security settings** and from the following:

**WPA/WPA2** — Select **EAP** (Extensible Authentication Protocol) or **Pre-shared key** (a secret key used for device identification).

**EAP plug-in settings** — If you select **WPA/WPA2** > **EAP**, select which EAP plug-ins defined in your device to use with the access point.

**Pre-shared key** — If you select **WPA/WPA2 > Pre-shared key**, enter the shared private key that identifies your device to the WLAN to which you connect.

**WPA2 only mode** — To allow both TKIP and AES (Advanced Encryption Standard) encryption, select **Off**. To allow AES only, select **On**.

### Wireless LAN plugins

Select **Menu > Ctrl. panel > Settings and Connection > Destinations**, and an access point group.

The extensible authentication protocol (EAP) plug-ins are used in wireless networks to authenticate wireless devices and authentication servers, and the different EAP plug-ins make possible the use of various EAP methods (network service).

You can view the EAP plug-ins currently installed in your device (network service).

### EAP plug-ins

- 1 To define the EAP plug-in settings, select **Options > New access**

**point** and define an access point that uses WLAN as a data bearer.

- 2 Select **802.1x** or **WPA/WPA2** as the security mode.
- 3 Select **WLAN security settings > WPA/WPA2 > EAP > EAP plug-in settings**.

### Use EAP plug-ins

---

To use an EAP plug-in when you connect to a WLAN using the access point, select the desired plug-in and **Options > Enable**. The EAP plug-ins enabled for use with this access point have a check mark next to them. To not use a plug-in, select **Options > Disable**.

To edit the EAP plug-in settings, select **Options > Edit**.

To change the priority of the EAP plug-in settings, select **Options > Raise priority** to attempt to use the plug-in before other plug-ins when connecting to the network with the access point, or **Options > Lower priority** to use this plug-in for network authentication after attempting to use other plug-ins.



See the device help for more information on EAP plugins.

### Session initiation protocol (SIP) settings

Select **Menu > Ctrl. panel > Settings and Connection > SIP settings.**

The session initiation protocol (SIP) is used for creating, modifying, and terminating certain types of communication sessions with one or more participants (network service). SIP profiles include settings for these sessions. The SIP profile used by default for a communication session is underlined.

To create a SIP profile, select **Options > New SIP profile > Use default profile** or **Use existing profile.**

To select the SIP profile you want to use by default for communication sessions, select **Options > Default profile.**

### Edit SIP profiles

Select **Menu > Ctrl. panel > Settings and Connection > SIP settings.**

Select **Options > Edit** and from the following:

**Profile name** — Enter a name for the SIP profile.

**Service profile** — Select IETF or Nokia 3GPP.

**Default destination** — Select the destination to use for the internet connection.

**Default access point** — Select the access point to use for the internet connection.

**Public user name** — Enter your user name provided by your service provider.

**Use compression** — Select if compression is used.

**Registration** — Select the registration mode.

**Use security** — Select if security negotiation is used.

**Proxy server** — Enter the proxy server settings for this SIP profile.

**Registrar server** — Enter the registration server settings for this SIP profile.

### Edit SIP proxy servers

Select **Options > New SIP profile or Edit > Proxy server.**

## 170 Settings

---

Proxy servers are intermediate servers between a browsing service and its users used by some service providers. These servers may provide additional security and speed up access to the service.

Select from the following:

**Proxy server address** — Enter the host name or IP address of the proxy server in use.

**Realm** — Enter the proxy server realm.

**User name** and **Password** — Enter your user name and password for the proxy server.

**Allow loose routing** — Select if loose routing is allowed.

**Transport type** — Select **UDP**, **Automatic**, or **TCP**.

**Port** — Enter the port number of the proxy server.

### Edit registration servers

Select **Options** > **New SIP profile** or **Edit** > **Registrar server**.

Select from the following:

**Registrar server address** — Enter the host name or IP address of the registrar server in use.

**Realm** — Enter the registrar server realm.

**User name** and **Password** — Enter your user name and password for the registrar server.

**Transport type** — Select **UDP**, **Automatic**, or **TCP**.

**Port** — Enter the port number of the registrar server.

### Configuration settings

Select **Menu** > **Ctrl. panel** > **Settings** and **Connection** > **Configurations**.

You can receive messages from your service provider or company information management containing configuration settings for trusted servers. These settings are automatically saved in Configurations. You may receive configuration settings for access points, multimedia, or e-mail services, and instant messaging (IM) or synchronisation settings from trusted servers.

To delete configurations for a trusted server, select **Options** > **Delete**. The configuration settings for other

applications provided by this server are also deleted.

### Application settings

Select **Menu > Ctrl. panel > Settings and Applications.**

Select an application from the list to adjust its settings.

### Shortcuts

Here are some of the available keyboard shortcuts in your device. Shortcuts can make the use of the applications more efficient.

#### General shortcuts

|           |  |
|-----------|--|
| Power key | Press and hold to switch your device on and off.<br><br>Press once to switch between profiles. |
| Sym key   | Press and hold to activate or deactivate Bluetooth connectivity.                               |

|          |  |
|----------|--|
| Ctrl key | Press and hold to activate or deactivate the Silent profile. |
|----------|--|

|                 |             |
|-----------------|-------------|
| <b>Ctrl + C</b> | Copy text.  |
| <b>Ctrl + V</b> | Paste text. |
| <b>Ctrl + X</b> | Cut text.   |
| <b>Ctrl + A</b> | Select all. |

#### Home screen

|  |  |
|--|--|
| Left selection key + right selection key | Lock and unlock the keypad and keyboard.                 |
| Call key                                 | Open the call log.                                       |
| <b>0</b>                                 | Press and hold to open your homepage in the Web browser. |
| <b>1</b>                                 | Press and hold to call your voice mailbox.               |

|                  |   |
|------------------|---|
| Number key (2–9) | Call a phone number using speed dialling. You must first activate speed dialling in <b>Menu &gt; Ctrl. panel &gt; Settings and Settings &gt; Phone &gt; Call &gt; Speed dialling.</b> |
|------------------|---|

### Web shortcuts

|          |                                      |
|----------|--------------------------------------|
| <b>*</b> | Zoom in the page.                    |
| <b>#</b> | Zoom out the page.                   |
| <b>0</b> | Go to the homepage.                  |
| <b>1</b> | Show the toolbar                     |
| <b>2</b> | Open the search dialog.              |
| <b>3</b> | Return to the previous page.         |
| <b>4</b> | Save the current page as a bookmark. |
| <b>5</b> | Open the map of keypad shortcuts.    |
| <b>6</b> | Reload the current page.             |
| <b>7</b> | View the page in full screen.        |
| <b>8</b> | View the page overview.              |

|          |   |
|----------|---|
| <b>9</b> | Open the dialog for entering a new web address. |
|----------|---|

### E-mail

|          |  |
|----------|--|
| <b>C</b> | Create a new e-mail message.                                   |
| <b>D</b> | Remove the selected e-mail messages.                           |
| <b>R</b> | Create a reply message to the sender of the e-mail message.    |
| <b>A</b> | Create a reply message to the sender and all other recipients. |
| <b>F</b> | Forward the e-mail message.                                    |
| <b>O</b> | Open the selected e-mail message.                              |
| <b>J</b> | Move up one page in the e-mail message.                        |
| <b>K</b> | Move down one page in the e-mail message.                      |

|          |  |
|----------|--|
| <b>T</b> | Move to the first e-mail message in the mailbox or move to the beginning of an e-mail message. |
| <b>B</b> | Move to the last e-mail message in the mailbox or move to the end of an e-mail message.        |
| <b>U</b> | Change the read or unread status of an e-mail message.   |
| <b>E</b> | Accept a meeting request.  |
| <b>G</b> | Tentatively accept a meeting request.  |
| <b>V</b> | Decline a meeting request.   |
| <b>W</b> | Sort e-mail messages.  |
| <b>I</b> | Expand and collapse the messages.  |
| <b>S</b> | Start the search.  |

### Calendar shortcuts for keyboard

|          |                       |
|----------|-----------------------|
| <b>A</b> | Open the agenda view. |
|----------|-----------------------|

|          |                      |
|----------|----------------------|
| <b>D</b> | Open the day view.   |
| <b>W</b> | Open the week view.  |
| <b>M</b> | Open the month view. |
| <b>T</b> | Open the to-do view. |
| <b>N</b> | Add a new meeting.   |

## Glossary

### Glossary

|                              |   |
|------------------------------|---|
| <b>3G</b>                    | 3rd generation mobile communications. A digital system for mobile communications which aims at global use and provides increased bandwidth. 3G lets a mobile device user access a wide variety of services, such as multimedia. |
| <b>Ad-hoc operating mode</b> | A WLAN network mode where two or more devices connect to each other using WLAN directly without a WLAN access point.  |

|            |   |
|------------|---|
| Cookies    | Cookies are little pieces of information, given by the server to you, to store information about your visits to a web site. When you accept cookies, the server is able to evaluate your use of the web site, what you are interested in, what you want to read, and so on.                 |
| DNS        | Domain name service. An internet service that translates domain names such as <a href="http://www.nokia.com">www.nokia.com</a> into IP addresses such as 192.100.124.195. Domain names are easier to remember but this translation is needed because the internet is based on IP addresses. |
| DTMF tones | Dual-tone multifrequency tones. The DTMF system is used by touch-tone telephones. DTMF assigns a specific frequency, or tone, to each key so that it can easily be identified by a microprocessor. DTMF tones   |

|       |   |
|-------|---|
|       | allow you to communicate with voice mailboxes, computerised telephony systems, and so on.   |
| EAP   | Extensible authentication protocol. EAP plug-ins are used in wireless networks to authenticate wireless devices and authentication servers.         |
| EGPRS | Enhanced GPRS. EGPRS is similar to GPRS, but it enables faster connection. For availability and data transfer speed, contact your service provider. |

|      |  |                               |  |
|------|--|-------------------------------|--|
| GPRS | <p>General packet radio service. GPRS enables wireless access for mobile phones to data networks (network service). GPRS uses packet data technology where information is sent in short bursts of data over the mobile network. The benefit of sending data in packets is that the network is occupied only when sending or receiving data. As GPRS uses the network efficiently, it allows for quick data connection setup and fast data transmission speeds.</p> <p>You must subscribe to the GPRS service. For availability and subscription to GPRS, contact your service provider.</p> <p>During a voice call, you cannot establish a GPRS connection, and any existing GPRS connection is put on hold unless the</p> |                               | network supports dual transfer mode.   |
|      |  | GPS                           | Global positioning system. GPS is a worldwide radio navigation system.   |
|      |  | HTTP                          | Hypertext transfer protocol. A document transfer protocol used in the web.   |
|      |  | HTTPS                         | HTTP over a secure connection.   |
|      |  | IMAP4                         | Internet mail access protocol, version 4. A protocol used for accessing your remote mailbox.   |
|      |  | Internet access point         | An access point is where your device connects to a network. To use e-mail and multimedia services or to connect to the internet and browse web pages, you must first define internet access points for these services. |
|      |  | Infrastructure operating mode | A WLAN network mode where devices are connected to WLAN using a WLAN access point.   |

|              |  |
|--------------|--|
| PIN          | Personal identity number. The PIN code protects your device from unauthorised use. The PIN code is supplied with the SIM card. If the PIN code request is selected, the code is required each time the device is switched on. The PIN code must be 4 to 8 digits long. |
| PIN2         | The PIN2 code is supplied with some SIM cards. The PIN2 code is required to access certain functions supported by the SIM card. The length of the PIN2 code is 4 to 8 digits.  |
| POP3         | Post office protocol, version 3. A common mail protocol that can be used for accessing your remote mailbox.  |
| PUK and PUK2 | Personal Unblocking Key. PUK and PUK2 codes are required to change a blocked PIN code or PIN2 code, respectively. The  |

|           |  |
|-----------|--|
|           | length of the code is 8 digits.  |
| SIP       | Session Initiation Protocol. SIP is used for creating, modifying, and terminating certain types of communication sessions with one or more participants. |
| SSID      | Service set identifier. SSID is the name that identifies the specific WLAN.  |
| Streaming | Streaming audio and video files means playing them directly from the web without downloading them first to your device.                                  |



|      |   |
|------|---|
| UMTS | <p>Universal Mobile Telecommunications System. UMTS is a 3G mobile communication system. Besides voice and data, UMTS enables audio and video delivery to wireless devices.</p> <p>When you use your device in GSM and UMTS networks, multiple data connections can be active at the same time, and access points can share a data connection. In the UMTS network, data connections remain active during voice calls. You can, for example, browse the web faster than previously possible while simultaneously speaking on the phone.</p> |
| UPIN | PIN code used in UMTS network.  |
| UPUK | UPIN Unblocking Key. UPUK code is required to change a blocked UPIN code or PIN2 code. The length of the code is 8 digits.  |

|              |  |
|--------------|--|
| USIM         | SIM card used in UMTS network.   |
| USSD command | A service request, such as request to activate an application or configure various settings remotely, that you can send to your operator or service provider with your device. |
| VPN          | Virtual private network. VPN creates a secure connection to compatible corporate intranet and services, such as e-mail.  |
| WAP          | Wireless application protocol. WAP is an international standard for wireless communication.  |
| WEP          | Wired equivalent privacy. WEP is an encryption method that encrypts data before it is transmitted in WLAN.   |
| WLAN         | Wireless local area network.   |
| WPA          | Wi-Fi Protected Access. Security method for WLAN.  |

|      |  |
|------|--|
| WPA2 | Wi-Fi Protected Access 2.<br>Security method for WLAN. |
|------|--|

### Troubleshooting

To view frequently asked questions about your device, go to [www.nokia.com/support](http://www.nokia.com/support).

#### **Q: What is my lock, PIN, or PUK code?**

A: The default lock code is 12345. If you forget or lose the lock code, contact your device dealer. If you forget or lose a PIN or PUK code, or if you have not received such a code, contact your network service provider.

#### **Q: How do I close an application that is not responding?**

A: Press and hold the menu key. Scroll to the application, and press the backspace key to close the application.

#### **Q: Why do images look smudgy?**

A: Ensure that the camera lens protection windows are clean.

#### **Q: Why do missing, discoloured, or bright dots appear on the screen every time I switch on my device?**

A: This is a characteristic of this type of display. Some displays may contain pixels or dots that remain on or off. This is normal, not a fault.

#### **Q: Why can't I find my friend's device while using Bluetooth connectivity?**

A: Check that both devices are compatible, have activated Bluetooth connectivity, and are not in hidden mode. Check also that the distance between the two devices is not over 10 metres (33 feet) and that there are no walls or other obstructions between the devices.

#### **Q: Why can't I close a Bluetooth connection?**

A: If another device is connected to your device, you can close the connection using the other device or by deactivating Bluetooth connectivity. Select **Menu > Ctrl. panel >**

**Connectivity > Bluetooth and Bluetooth > Off.**

**Q: Why can't I see a wireless LAN (WLAN) access point even though I know I'm within its range?**

---

A: Check that the Offline profile is not in use in your device.

The WLAN access point may use a hidden service set identifier (SSID). You can only access networks that use a hidden SSID if you know the correct SSID, and have created a WLAN access point for the network on your Nokia device.

Check that the WLAN access point is not on channels 12-13, as they cannot be associated with.

**Q: How do I turn the WLAN off on my Nokia device?**

---

A: The WLAN on your Nokia device deactivates when you are not connected or trying to connect to another access point, or not scanning for available networks. To further

reduce battery consumption, you can specify that your Nokia device does not scan, or scans less often, for available networks in the background. The WLAN deactivates in between background scans.

To stop the background scans, select **Menu > Ctrl. panel > Settings and Connection > Wireless LAN > Show WLAN availability > Never**. You can still manually scan for available WLANs and connect to WLANs as usual.

To increase the background scan interval, select **Show WLAN availability > Yes**, and define the interval in **Scan for networks**.

**Q: Why can't I browse the web even though the WLAN connection is working and the IP settings are correct?**

---

A: Check that you have defined the HTTP/ HTTPS proxy settings correctly in the advanced settings of your WLAN access point.

### **Q: How do I check the signal quality of my WLAN connection?**

Select **Menu** > **Ctrl. panel** > **Connectivity** > **Conn. mgr. and Active data connections** > **Options** > **Details**. If the signal quality is weak or moderate, you may encounter connection problems. Try again closer to the access point.

### **Q: Why do I have problems with the security mode?**

---

A: Check that you have configured the security mode correctly, and that it is the same that the network uses. To check the security mode the network uses, select **Menu** > **Ctrl. panel** > **Connectivity** > **Conn. mgr. and Active data connections** > **Options** > **Details**.

Check also the following: you have the correct WPA mode (preshared key or EAP), you have disabled all EAP types that are not needed, and all the EAP type settings are correct (passwords, user names, certificates).

### **Q: Why can't I select a contact for my message?**

---

A: The contact card does not have a phone number, an address, or an e-mail address. Select **Menu** > **Contacts**, and edit the contact card.

### **Q: The note Retrieving message is shown briefly. What is happening?**

---

A: The device is trying to retrieve a multimedia message from the multimedia messaging centre. This note is shown if you have selected **Menu** > **Messaging and Options** > **Settings** > **Multimedia message** > **Multimedia retrieval** > **Always automatic**.

Check that the settings for multimedia messaging are defined correctly and that there are no mistakes in phone numbers or addresses.

### **Q: How can I end the data connection when the device starts a data connection again and again?**

---

A: The device may be trying to retrieve a multimedia message from the multimedia message centre. To stop the

device from making a data connection, select **Menu > Messaging and Options > Settings > Multimedia message > Multimedia retrieval > Manual** to have the multimedia messaging centre save messages to be retrieved later, or **Off** to ignore all incoming multimedia messages. If you select **Manual**, you receive a notification when there is a new multimedia message that you can retrieve in the multimedia message centre. If you select **Off**, the device does not make any network connections related to multimedia messaging.

To set the device to use a packet data connection only if you start an application or action that needs it, select **Menu > Ctrl. panel > Settings and Connection > Packet data > Packet data connection > When needed**.

If this does not help, restart the device.

### **Q: How do I save battery power?**

---

A: Many features in your device increase the demand on battery power and

reduce the battery life time. To save battery power, do the following:

- Deactivate Bluetooth connectivity when you do not need it.
- Stop the background scans for WLAN. Select **Menu > Ctrl. panel > Settings and Connection > Wireless LAN > Show WLAN availability > Never**. You can still manually scan for available WLANs and connect to WLANs as usual.
- Set the device to use a packet data connection only if you start an application or action that needs it. Select **Menu > Ctrl. panel > Settings and Connection > Packet data > Packet data connection > When needed**.
- Prevent the device from automatically downloading new maps in the Maps application. Select **Menu > Maps and Options > Settings > Internet > Connection**.
- Change the time-out after which the backlight is switched off. Select **Menu > Ctrl. panel > Settings and General > Personalisation > Display > Light time-out**.

- Close the applications you are not using. Press and hold the menu key. Scroll to the application, and press the backspace key to close the application.

### Find help

#### Support

When you want to learn more about how to use your product or you are unsure how your device should function, go to [www.nokia.com/support](http://www.nokia.com/support), or using a mobile device, [nokia.mobi/support](http://nokia.mobi/support). You can also select **Menu > Help > Help** in your device.

If this does not resolve your issue, do one of the following:

- Reboot your device. Switch off the device, and remove the battery. After about a minute, replace the battery, and switch on the device.
- Restore the original factory settings.
- Update your device software.

If your issue remains unsolved, contact Nokia for repair options. Go to [www.nokia.com/repair](http://www.nokia.com/repair). Before sending

your device for repair, always back up the data in your device.

#### Update device software About software updates

Software updates may include new features and enhanced functions that were not available at the time of purchase of your device. Updating the software may also improve the device performance.

To get a notification when new software is available for your device, register with My Nokia, and subscribe to notifications for text or e-mail messages. For more information, go to [www.nokia.com/mynokia](http://www.nokia.com/mynokia).

#### Warning:

If you install a software update, you cannot use the device, even to make emergency calls, until the installation is completed and the device is restarted. Be sure to back up data before accepting installation of an update.

Downloading software updates may involve the transmission of large amounts of data (network service).

Make sure that the device battery has enough power, or connect the charger before starting the update.

After updating your device software or applications, the instructions related to the updated applications in the user guide or helps may no longer be up to date.

### Update software using your PC

Nokia Software Updater is a PC application that enables you to update your device software. To update your device software, you need a compatible PC, broadband internet access, and a compatible USB data cable to connect your device to the PC.

To get more information and to download the Nokia Software Updater application, go to [www.nokia.com/softwareupdate](http://www.nokia.com/softwareupdate).

### In-device help

Your device contains instructions to help to use the applications in your device.

To open help texts from the main menu, select **Menu > Help > Help** and the

application for which you want to read instructions.

When an application is open, to access the help text for the current view, select **Options > Help**.

When you are reading the instructions, to change the size of the help text, select **Options > Decrease font size or Increase font size**.

You may find links to related topics at the end of the help text.

If you select an underlined word, a short explanation is displayed.

Help texts use the following indicators:



Link to a related help topic.



Link to the application being discussed.

When you are reading the instructions, to switch between help texts and the application that is open in the background, select **Options > Show open apps**, and the desired application.

### Do more with your device

There are various applications provided by Nokia and third party software developers, that help you do more with your device. To find and download applications, visit the Ovi Store at [store.ovi.com](http://store.ovi.com). These applications are explained in the guides that are available on the product support pages at [www.nokia.com/support](http://www.nokia.com/support) or your local Nokia website.

### Settings

Your device normally has MMS, GPRS, streaming, and mobile internet settings automatically configured, based on your network service provider information. You may have settings from your service providers already installed in your device, or you may receive or request the settings from the network service providers as a special message.

You can change the general settings in your device, such as language, standby mode, display, and keypad lock settings.

### Prolong battery life

Many features in your device increase the demand on battery power and reduce the battery lifetime. To save battery power, note the following:

- Features that use Bluetooth technology, or allowing such features to run in the background while using other features, increase the demand on battery power. Deactivate Bluetooth technology when you do not need it.
- Features that use wireless LAN (WLAN), or allowing such features to run in the background while using other features, increase the demand on battery power. WLAN on your Nokia device deactivates when you are not trying to connect, not connected to an access point, or not scanning for available networks. To further reduce battery consumption, you can specify that your device does not scan, or scans less often, for available networks in the background.
- If you have set **Packet data connection** to **When available** in connection settings, and there is no packet data coverage (GPRS), the



device periodically tries to establish a packet data connection. To prolong the operating time of your device, select **Menu > Ctrl. panel > Settings and Connection > Packet data > Packet data connection > When needed.**

- The Maps application downloads new map information when you scroll to new areas on the map, which increases the demand on battery power. You can prevent the automatic download of new maps.
- If the signal strength of the cellular network varies much in your area, your device must scan for the available network repeatedly. This increases the demand on battery power.

If the network mode is set to dual mode in the network settings, the device searches for the 3G network. You can set the device to use only the GSM network. To use only the GSM network, select **Menu > Ctrl. panel > Settings and Phone > Network > Network mode > GSM.**

- The backlight of the display increases the demand on battery power. In the display settings, you can change the length of the time-out period after which the backlight is switched off. Select **Menu > Ctrl. panel > Settings and General > Personalisation > Display > Light time-out.** To adjust the light sensor that observes lighting conditions and adjusts the display brightness, in the display settings, select **Light sensor.**
- Leaving applications running in the background increases the demand on battery power. To close the applications you are not using, press and hold the menu key, scroll to the application, and press the backspace key.
- To save power, activate the power save mode. Press the power key, and select **Activate power saving.** To deactivate it, press the power key, and select **Deactivate power saving.** You may not be able to change the settings of certain applications when the power save mode is activated.

### Free memory

To view how much memory is available for different data types, select **Menu > Office > File mgr..**

Many features of the device use memory to store data. The device notifies you if available memory is low.

To free memory, transfer data to an alternative memory (if available) or compatible computer.

To remove data you no longer need, use File manager or the respective application. You can remove the following:

- Messages in the folders in Messaging and retrieved e-mail messages from the mailbox
- Saved web pages
- Contact information
- Calendar notes
- Applications shown in Application manager that you do not need
- Installation files (with .sis or .six file extensions) of installed

applications. Back up the installation files to a compatible computer.

- Images and video clips in Photos.

### Green tips



### Save energy

You do not need to charge your battery so often if you do the following (if available for your device):

- Close applications and data connections, for example, your Bluetooth connection, when not in use.
- Decrease the brightness of the screen.
- Set your device to enter power saver mode after the minimum period of inactivity, if available in your device.
- Deactivate unnecessary sounds, such as key tones.

## Recycle

All materials of this device can be recovered as materials and energy. For information on how to recycle your old Nokia products, go to [www.nokia.com/wecycle](http://www.nokia.com/wecycle), or using a mobile device, [nokia.mobi/wecycle](http://nokia.mobi/wecycle).

Recycle packaging and user guides at your local recycling scheme.



The crossed-out wheeled-bin symbol on your product, battery, literature, or packaging reminds you that all electrical and electronic products, batteries, and accumulators must be taken to separate collection at the end of their working life. This requirement applies in the European Union. Do not dispose of these products as unsorted municipal waste. For more information on the environmental attributes of your device, see [www.nokia.com/ecodeclaration](http://www.nokia.com/ecodeclaration).

## Product and safety information

### Accessories

#### Warning:

Use only batteries, chargers, and accessories approved by Nokia for use with this particular model. The use of any other types may invalidate any approval or warranty, and may be dangerous. In particular, use of unapproved chargers or batteries may present a risk of fire, explosion, leakage, or other hazard.

For availability of approved accessories, please check with your dealer. When you disconnect the power cord of any accessory, grasp and pull the plug, not the cord.

### Battery

#### Battery and charger information

Your device is powered by a rechargeable battery. The battery intended for use with this device is BL-4D. Nokia may make additional battery models available for this device. This device is intended for use when supplied with power from the following chargers: AC-8. The exact charger model number may vary depending on the type of plug. The plug variant is identified by one of the following: E, EB, X, AR, U, A, C, K, or UB.

The battery can be charged and discharged hundreds of times, but it will eventually wear out. When the talk and standby times are noticeably shorter than normal, replace the battery. Use only Nokia approved batteries, and recharge your battery only with Nokia approved chargers designated for this device.

If a battery is being used for the first time or if the battery has not been used for a prolonged period, it may be necessary to connect the charger, then disconnect and reconnect it to begin charging the battery. If the battery

## 188 Product and safety information

---

is completely discharged, it may take several minutes before the charging indicator appears on the display or before any calls can be made.

**Safe removal.** Always switch the device off and disconnect the charger before removing the battery.

**Proper charging.** Unplug the charger from the electrical plug and the device when not in use. Do not leave a fully charged battery connected to a charger, since overcharging may shorten its lifetime. If left unused, a fully charged battery will lose its charge over time.

**Avoid extreme temperatures.** Always try to keep the battery between 15°C and 25°C (59°F and 77°F). Extreme temperatures reduce the capacity and lifetime of the battery. A device with a hot or cold battery may not work temporarily. Battery performance is particularly limited in temperatures well below freezing.

**Do not short-circuit.** Accidental short-circuiting can occur when a metallic object such as a coin, clip, or pen causes direct connection of the positive (+) and negative (-) terminals of the battery. (These look like metal strips on the battery.) This might happen, for example, when you carry a spare battery in your pocket or purse. Short-circuiting the terminals may damage the battery or the connecting object.

**Disposal.** Do not dispose of batteries in a fire as they may explode. Dispose of batteries according to local regulations. Please recycle when possible. Do not dispose as household waste.

**Leak.** Do not dismantle, cut, open, crush, bend, puncture, or shred cells or batteries. In the event of a battery leak, prevent battery liquid contact with skin or eyes. If this happens, flush the affected areas immediately with water, or seek medical help.

**Damage.** Do not modify, remanufacture, attempt to insert foreign objects into the battery, or immerse or expose it to water or other liquids. Batteries may explode if damaged.

**Correct use.** Use the battery only for its intended purpose. Improper battery use may result in a fire, explosion, or other hazard. If the device or battery is dropped, especially on a hard surface, and you believe the battery has been damaged, take it to a service centre for inspection before continuing to use it. Never use any charger or battery that is damaged. Keep your battery out of the reach of small children.

### **Nokia battery authentication guidelines**

Always use original Nokia batteries for your safety. To check that you are getting an original Nokia battery, purchase it from a Nokia authorised service centre or dealer, and inspect the hologram label using the following steps:

#### **Authenticate hologram**

- 1 When you look at the hologram on the label, you should see the Nokia connecting hands symbol from one angle and the Nokia Original Enhancements logo when looking from another angle.



- 2 When you angle the hologram left, right, down and up, you should see 1, 2, 3 and 4 dots on each side respectively.



Successful completion of the steps is not a total assurance of the authenticity of the battery. If you cannot confirm authenticity or if you have any reason to believe that your Nokia battery with the hologram on the label is not an authentic Nokia battery, you should refrain from using it, and take it to the nearest Nokia authorised service centre or dealer for assistance.

To find out more about original Nokia batteries, see [www.nokia.com/battery](http://www.nokia.com/battery).

### Taking care of your device

Your device is a product of superior design and craftsmanship and should be treated with care. The following suggestions will help you protect your warranty coverage.

- Keep the device dry. Precipitation, humidity, and all types of liquids or moisture can contain minerals that will corrode electronic circuits. If your device does get wet, remove the battery, and allow the device to dry completely before replacing it.
- Do not use or store the device in dusty, dirty areas. Its moving parts and electronic components can be damaged.
- Do not store the device in high or cold temperature. High temperatures can shorten the life of electronic devices, damage batteries, and warp or melt certain plastics. When the device warms to its normal temperature from a cold temperature, moisture can form inside the device and damage electronic circuit boards.
- Do not attempt to open the device other than as instructed in this guide.
- Do not drop, knock, or shake the device. Rough handling can break internal circuit boards and fine mechanics.
- Do not use harsh chemicals, cleaning solvents, or strong detergents to clean the device. Only use a soft, clean, dry cloth to clean the surface of the device.
- Do not paint the device. Paint can clog the moving parts and prevent proper operation.
- Use only the supplied or an approved replacement antenna. Unauthorised antennas, modifications, or attachments could damage the device and may violate regulations governing radio devices.
- Use chargers indoors.
- Backup all data you want to keep, such as contacts and calendar notes.
- To reset the device from time to time for optimum performance, power off the device and remove the battery.

These suggestions apply equally to your device, battery, charger, or any accessory.

## 190 Product and safety information

---

### Recycle

Always return your used electronic products, batteries, and packaging materials to dedicated collection points. This way you help prevent uncontrolled waste disposal and promote the recycling of materials. Check product environmental information and how to recycle your Nokia products at [www.nokia.com/werecycle](http://www.nokia.com/werecycle), or [nokia.mobi/werecycle](http://nokia.mobi/werecycle).

### Additional safety information

#### Small children

Your device and its accessories are not toys. They may contain small parts. Keep them out of the reach of small children.

#### Operating environment

This device meets RF exposure guidelines in the normal use position at the ear or at least 1.5 centimetres (5/8 inch) away from the body. Any carry case, belt clip, or holder for body-worn operation should not contain metal and should position the device the above-stated distance from your body.

To send data files or messages requires a quality connection to the network. Data files or messages may be delayed until such a connection is available. Follow the separation distance instructions until the transmission is completed.

Parts of the device are magnetic. Metallic materials may be attracted to the device. Do not place credit cards or other magnetic storage media near the device, because information stored on them may be erased.

#### Medical devices

Operation of radio transmitting equipment, including wireless phones, may interfere with the function of inadequately protected medical devices. Consult a physician or the manufacturer of the medical device to

determine whether they are adequately shielded from external RF energy. Switch off your device when regulations posted instruct you to do so. Hospitals or health care facilities may use equipment sensitive to external RF energy.

#### Implanted medical devices

Manufacturers of medical devices recommend a minimum separation of 15.3 centimetres (6 inches) between a wireless device and an implanted medical device, such as a pacemaker or implanted cardioverter defibrillator, to avoid potential interference with the medical device. Persons who have such devices should:

- Always keep the wireless device more than 15.3 centimetres (6 inches) from the medical device.
- Not carry the wireless device in a breast pocket.
- Hold the wireless device to the ear opposite the medical device.
- Turn the wireless device off if there is any reason to suspect that interference is taking place.
- Follow the manufacturer directions for the implanted medical device.

If you have any questions about using your wireless device with an implanted medical device, consult your health care provider.

#### Hearing aids

Some digital wireless devices may interfere with some hearing aids.

**Note:** The surface of this device does not contain nickel in the platings. The surface of this device contains stainless steel.

### Vehicles

RF signals may affect improperly installed or inadequately shielded electronic systems in motor vehicles such as electronic fuel injection, electronic antilock braking, electronic speed control, and air bag systems. For more information, check with the manufacturer of your vehicle or its equipment.

Only qualified personnel should service the device or install the device in a vehicle. Faulty installation or service may be dangerous and may invalidate your warranty. Check regularly that all wireless device equipment in your vehicle is mounted and operating properly. Do not store or carry flammable liquids, gases, or explosive materials in the same compartment as the device, its parts, or accessories. Remember that air bags inflate with great force. Do not place your device or accessories in the air bag deployment area.

Switch off your device before boarding an aircraft. The use of wireless teledevices in an aircraft may be dangerous to the operation of the aircraft and may be illegal.

### Potentially explosive environments

Switch off your device in any area with a potentially explosive atmosphere. Obey all posted instructions. Sparks in such areas could cause an explosion or fire resulting in bodily injury or death. Switch off the device at refuelling points such as near gas pumps at service stations. Observe restrictions in fuel depots, storage, and distribution areas; chemical plants; or where blasting operations are in progress. Areas with a potentially explosive atmosphere are often, but not always, clearly marked. They include areas where you would be advised to turn off your vehicle engine, below deck on boats, chemical transfer or storage facilities and where the air contains chemicals or particles such as grain, dust, or metal powders. You should check with the manufacturers of vehicles using liquefied petroleum gas (such as propane or butane) to determine if this device can be safely used in their vicinity.

### Emergency calls

**Important:** This device operates using radio signals, wireless networks, landline networks, and user-programmed functions. If your device supports voice calls over the internet (internet calls), activate both the internet calls and the cellular phone. The device may attempt to make emergency calls over both the cellular networks and through your internet call provider if both are activated. Connections in all conditions cannot be guaranteed. You should never rely solely on any wireless device for essential communications like medical emergencies.

To make an emergency call:

- 1 If the device is not on, switch it on. Check for adequate signal strength. Depending on your device, you may also need to complete the following:
  - Insert a SIM card if your device uses one.
  - Remove certain call restrictions you have activated in your device.
  - Change your profile from Offline or Flight profile to an active profile.
- 2 Press the end key as many times as needed to clear the display and ready the device for calls.
- 3 Enter the official emergency number for your present location. Emergency numbers vary by location.
- 4 Press the call key.

When making an emergency call, give all the necessary information as accurately as possible. Your wireless device may be the only means of communication at the scene of an accident. Do not end the call until given permission to do so.

### Certification information (SAR)

#### This mobile device meets guidelines for exposure to radio waves.

Your mobile device is a radio transmitter and receiver. It is designed not to exceed the limits for exposure to radio waves recommended by international guidelines. These guidelines were developed by the independent scientific organisation ICNIRP and include safety margins designed to assure the protection of all persons, regardless of age and health.

The exposure guidelines for mobile devices employ a unit of measurement known as the Specific Absorption Rate or SAR. The SAR limit stated in the ICNIRP guidelines is 2.0 watts/kilogram (W/kg) averaged over 10 grams of tissue. Tests for SAR are conducted using standard operating positions with the device transmitting at its highest certified power level in all tested frequency bands. The actual SAR level of an operating device can be below the maximum value because the device is designed to use only the power required to reach the network. That amount changes depending on a number of factors such as how close you are to a network base station.

The highest SAR value under the ICNIRP guidelines for use of the device at the ear is 0.88 W/kg.

Use of device accessories may result in different SAR values. SAR values may vary depending on national reporting and testing requirements and the network band. Additional SAR information may be provided under product information at [www.nokia.com](http://www.nokia.com).

## Copyright and other notices

### DECLARATION OF CONFORMITY

# CE 0434 !

Hereby, NOKIA CORPORATION declares that this RM-632 product is in compliance with the essential requirements and other relevant provisions of Directive 1999/5/EC. A copy of the Declaration of Conformity can be found at [http://www.nokia.com/phones/declaration\\_of\\_conformity/](http://www.nokia.com/phones/declaration_of_conformity/).

© 2010 Nokia. All rights reserved.

Nokia, Nokia Connecting People, and Navi are trademarks or registered trademarks of Nokia Corporation. Nokia tune is a sound mark of Nokia Corporation. Other product and company names mentioned herein may be trademarks or tradenames of their respective owners.

Reproduction, transfer, distribution, or storage of part or all of the contents in this document in any form without the prior written permission of Nokia is prohibited. Nokia operates a policy of continuous development. Nokia reserves the right to make changes and improvements to any of the products described in this document without prior notice.



Java and all Java-based marks are trademarks or registered trademarks of Sun Microsystems, Inc.



This product is licensed under the MPEG-4 Visual Patent Portfolio License (i) for personal and noncommercial use in connection with information which has been encoded in compliance with the MPEG-4 Visual Standard by a consumer engaged in a personal and noncommercial activity and (ii) for use in connection with MPEG-4 video provided by a licensed video provider. No license is granted or shall be implied for any other use. Additional information, including that related to promotional, internal, and commercial uses, may be obtained from MPEG LA, LLC. See <http://www.mpegla.com>.

TO THE MAXIMUM EXTENT PERMITTED BY APPLICABLE LAW, UNDER NO CIRCUMSTANCES SHALL NOKIA OR ANY OF ITS LICENSORS BE RESPONSIBLE FOR ANY LOSS OF DATA OR INCOME OR ANY SPECIAL, INCIDENTAL, CONSEQUENTIAL OR INDIRECT DAMAGES HOWSOEVER CAUSED.

THE CONTENTS OF THIS DOCUMENT ARE PROVIDED "AS IS". EXCEPT AS REQUIRED BY APPLICABLE LAW, NO WARRANTIES OF ANY KIND, EITHER EXPRESS OR IMPLIED, INCLUDING, BUT NOT LIMITED TO, THE IMPLIED WARRANTIES OF MERCHANTABILITY AND FITNESS FOR A PARTICULAR PURPOSE, ARE MADE IN RELATION TO THE ACCURACY, RELIABILITY OR CONTENTS OF THIS DOCUMENT. NOKIA RESERVES THE RIGHT TO REVISE THIS DOCUMENT OR WITHDRAW IT AT ANY TIME WITHOUT PRIOR NOTICE.

Reverse engineering of software in the device is prohibited to the extent permitted by applicable law. Insofar as this user guide contains any limitations on Nokia's representations, warranties, damages and liabilities, such limitations shall likewise limit any representations, warranties, damages and liabilities of Nokia's licensors.

The third-party applications provided with your device may have been created and may be owned by persons or entities not affiliated with or related to Nokia. Nokia does not own the copyrights or intellectual property rights to the third-party applications. As such, Nokia does not take

any responsibility for end-user support, functionality of the applications, or the information in the applications or these materials. Nokia does not provide any warranty for the third-party applications. BY USING THE APPLICATIONS YOU ACKNOWLEDGE THAT THE APPLICATIONS ARE PROVIDED AS IS WITHOUT WARRANTY OF ANY KIND, EXPRESS OR IMPLIED, TO THE MAXIMUM EXTENT PERMITTED BY APPLICABLE LAW. YOU FURTHER ACKNOWLEDGE THAT NEITHER NOKIA NOR ITS AFFILIATES MAKE ANY REPRESENTATIONS OR WARRANTIES, EXPRESS OR IMPLIED, INCLUDING BUT NOT LIMITED TO WARRANTIES OF TITLE, MERCHANTABILITY OR FITNESS FOR A PARTICULAR PURPOSE, OR THAT THE APPLICATIONS WILL NOT INFRINGE ANY THIRD-PARTY PATENTS, COPYRIGHTS, TRADEMARKS, OR OTHER RIGHTS.

The availability of particular products and applications and services for these products may vary by region. Please check with your Nokia dealer for details and availability of language options. This device may contain commodities, technology or software subject to export laws and regulations from the US and other countries. Diversion contrary to law is prohibited.

#### FCC/INDUSTRY CANADA NOTICE

Your device may cause TV or radio interference (for example, when using a telephone in close proximity to receiving equipment). The FCC or Industry Canada can require you to stop using your telephone if such interference cannot be eliminated. If you require assistance, contact your local service facility. This device complies with part 15 of the FCC rules. Operation is subject to the following two conditions: (1) This device may not cause harmful interference, and (2) this device must accept any interference received, including interference that may cause undesired operation. Any changes or modifications not expressly approved by Nokia could void the user's authority to operate this equipment.

/Issue 1.1 EN

**Index****Symbols/Numbers**

|                     |     |
|---------------------|-----|
| 3-D ringing tones   | 115 |
| 802.1x              |     |
| — security settings | 167 |

**A**

|                      |             |
|----------------------|-------------|
| A-GPS (assisted GPS) | 96          |
| access codes         | 20          |
| access points        | 70, 71, 160 |
| — groups             | 72, 161     |
| — VPN                | 152         |
| accessories          |             |
| — settings           | 156         |
| accounts             | 55          |
| Active notes         | 89          |
| active toolbar       |             |
| — in Photos          | 123         |
| albums               |             |
| — media              | 124         |
| answering calls      | 32          |
| antennas             | 15          |
| application manager  | 146         |
| application settings | 171         |
| applications         | 146         |
| assisted GPS (A-GPS) | 96          |

|                       |     |
|-----------------------|-----|
| attachments           |     |
| — multimedia messages | 62  |
| audio files           |     |
| — details             | 135 |
| audio messages        | 58  |
| autolock period       | 157 |

**B**

|                          |        |
|--------------------------|--------|
| background image         | 114    |
| backing up device memory | 90     |
| battery                  |        |
| — charging               | 13     |
| — inserting              | 11     |
| — saving power           | 184    |
| blocking                 |        |
| — device                 | 80     |
| blogs                    | 85     |
| Bluetooth                | 77, 80 |
| Bluetooth connectivity   |        |
| — device address         | 78     |
| — low memory             | 79     |
| — pairing devices        | 78     |
| — receiving data         | 79     |
| — sending data           | 78     |
| bookmarks                | 86     |
| browser                  |        |
| — bookmarks              | 83, 86 |
| — browsing pages         | 83, 84 |
| — cache memory           | 86     |

|                           |        |                                  |         |
|---------------------------|--------|----------------------------------|---------|
| — searching content       | 85     | camera                           |         |
| — security                | 86     | — capturing images               | 116     |
| — settings                | 87     | — image settings                 | 118     |
| — toolbar                 | 84     | — playing videos                 | 118     |
|                           |        | — scenes                         | 116     |
|                           |        | — sequence mode                  | 117     |
|                           |        | — toolbar                        | 116     |
|                           |        | — video clips                    | 118     |
|                           |        | — video settings                 | 119     |
|                           |        | — viewing images                 | 117     |
|                           |        | cell broadcast                   | 63      |
|                           |        | — settings                       | 66      |
|                           |        | certificates                     |         |
|                           |        | — details                        | 142     |
|                           |        | — settings                       | 143     |
|                           |        | charging the battery             | 13      |
|                           |        | chat services (IM)               | 53, 67  |
|                           |        | computer connections             | 81      |
|                           |        | See also <i>data connections</i> |         |
|                           |        | conference calls                 | 33      |
|                           |        | configuration messages           | 170     |
|                           |        | connectors                       | 10      |
|                           |        | contacts                         |         |
|                           |        | — copying                        | 16, 25  |
|                           |        | — images in                      | 26      |
|                           |        | — in social networks             | 25      |
|                           |        | — managing                       | 25, 26  |
|                           |        | — ringing tones                  | 26      |
|                           |        | — synchronising                  | 76, 150 |
| <b>C</b>                  |        |                                  |         |
| cable connection          | 81     |                                  |         |
| cache memory              | 86     |                                  |         |
| calculator                | 90     |                                  |         |
| calendar                  | 27     |                                  |         |
| — creating entries        | 27     |                                  |         |
| — meeting requests        | 28     |                                  |         |
| — views                   | 29     |                                  |         |
| call barring              | 35     |                                  |         |
| call divert               | 34     |                                  |         |
| call log                  | 42, 43 |                                  |         |
| call waiting              | 34     |                                  |         |
| caller ID                 | 158    |                                  |         |
| calls                     | 30     |                                  |         |
| — answering               | 32     |                                  |         |
| — conference              | 33     |                                  |         |
| — duration of             | 42     |                                  |         |
| — options during          | 31     |                                  |         |
| — rejecting               | 32     |                                  |         |
| — restricting             |        |                                  |         |
| See <i>fixed dialling</i> |        |                                  |         |
| — settings                | 158    |                                  |         |
| — voice mail              | 32     |                                  |         |

|  |         |
|--|---------|
| — voice tags                             | 25      |
| contacts bar                             | 22      |
| content                                  |         |
| — synchronising, sending, and retrieving | 17      |
| converting                               |         |
| — currencies                             | 92      |
| — measurements                           | 91      |
| copying content                          | 16      |
| currency conversions                     | 92      |
| <b>D</b>                                 |         |
| data cable                               | 81      |
| data connections                         |         |
| — PC connectivity                        | 81      |
| — synchronisation                        | 76, 150 |
| date                                     |         |
| — settings                               | 155     |
| declining calls                          | 32      |
| decrypting                               |         |
| — device memory and memory card          | 141     |
| device manager                           | 144     |
| dictionary                               | 95      |
| dismissing calls                         | 32      |
| display                                  |         |
| — settings                               | 154     |
| DLNA                                     | 82      |
| duration of calls                        | 42      |

|                                 |        |
|---------------------------------|--------|
| <b>E</b>                        |        |
| e-mail                          |        |
| — accounts                      | 48     |
| — adding attachments            | 46     |
| — attachments                   | 47     |
| — deleting                      | 48     |
| — disconnecting                 | 48     |
| — folders                       | 48     |
| — out-of-office reply           | 48     |
| — reading                       | 46     |
| — searching                     | 47     |
| — sending                       | 45, 58 |
| — settings                      | 49     |
| — setup                         | 45     |
| EAP                             |        |
| — plug-in settings              | 168    |
| — using an EAP plug-in          | 168    |
| encrypting                      |        |
| — device memory and memory card | 140    |
| equaliser                       | 133    |
| <b>F</b>                        |        |
| feeds, news                     | 85     |
| file management                 | 90, 91 |
| file manager                    | 90     |
| fixed dialling                  | 141    |
| flashlight                      | 30     |

**G**

|                                 |     |
|---------------------------------|-----|
| gallery                         | 119 |
| — presentations                 | 121 |
| — sound clips                   | 120 |
| — streaming links               | 120 |
| general information             | 182 |
| GPRS                            |     |
| — settings                      | 164 |
| GPS                             |     |
| — position requests             | 98  |
| GPS (Global Positioning System) | 96  |
| GPS (global positioning system) | 96  |

**H**

|                  |     |
|------------------|-----|
| headphones       | 14  |
| headset          | 14  |
| help application | 183 |
| home key         | 22  |
| home network     | 82  |
| home screen      | 21  |

**I**

|                               |          |
|-------------------------------|----------|
| IAPs (internet access points) | 70       |
| IM (instant messaging)        | 53, 67   |
| images                        | 122      |
| — editing                     | 125, 126 |
| — printing                    | 127, 128 |
| installing applications       | 146      |
| internet browser              | 82       |

|                          |     |
|--------------------------|-----|
| internet connection      | 82  |
| See also <i>browser</i>  |     |
| internet radio           | 136 |
| — favourites             | 137 |
| — searching for stations | 137 |
| — settings               | 138 |
| — station directory      | 137 |

**J**

|                              |     |
|------------------------------|-----|
| Java applications            | 146 |
| JME Java application support | 146 |

**K**

|                 |     |
|-----------------|-----|
| key store       | 143 |
| keyboard        | 23  |
| keyguard        | 14  |
| keypad          |     |
| — lock settings | 157 |
| keypad lock     | 14  |
| keys            |     |
| — WEP keys      | 167 |
| keys and parts  | 10  |

**L**

|                      |     |
|----------------------|-----|
| landmarks            | 98  |
| language             |     |
| — settings           | 155 |
| licences             | 149 |
| location information | 96  |

|                            |                  |                                     |            |
|----------------------------|------------------|-------------------------------------|------------|
| lock code                  | 15, 20, 139, 157 | — voice guidance                    | 108        |
| locking                    |                  | — walking routes                    | 110        |
| — device                   | 139              | measurements                        |            |
| — device autolock          | 157              | — converting                        | 91         |
| — keypad                   | 157              | meeting requests                    |            |
| logos                      |                  | — receiving                         | 47         |
| — welcome logo             | 154              | memory                              |            |
| <b>M</b>                   |                  | — clearing                          | 186        |
| Maps                       | 101              | — web cache                         | 86         |
| — browsing                 | 102              | memory card                         | 12, 13, 91 |
| — changing views           | 103              | — locking                           | 139        |
| — display elements         | 102, 109         | — passwords                         | 139        |
| — downloading maps         | 103              | message reader                      | 56, 57     |
| — driving routes           | 108              | messages                            | 44         |
| — Favourites               | 106              | — cell broadcast settings           | 66         |
| — finding locations        | 104              | — configuration messages            | 170        |
| — navigating               | 108, 110         | — service messages                  | 62         |
| — organising places        | 106              | — settings                          | 66         |
| — organising routes        | 106              | — speech options                    | 57         |
| — planning routes          | 111              | — text message settings             | 64         |
| — positioning              | 103              | messaging                           |            |
| — saving places            | 105              | — folders                           | 44         |
| — saving routes            | 105              | messaging key                       | 22, 155    |
| — sending places           | 106              | Mini Map                            | 84         |
| — sharing locations        | 106              | MMS (multimedia message<br>service) | 58, 65     |
| — synchronising            | 107              | multimedia                          | 119        |
| — traffic information      | 109              | multimedia messages                 | 58, 65     |
| — viewing location details | 105              | — attachments                       | 62         |

---

|                             |        |                           |         |
|-----------------------------|--------|---------------------------|---------|
| — creating presentations    | 61     | — connection settings     | 56      |
| — receiving                 | 60     | — landmarks               | 54, 55  |
| — replying to               | 60     | — personalisation         | 56      |
| multitasking                | 29     | — presence                | 55      |
| music player                |        | — profiles                | 51      |
| — playing                   | 131    | — searching               | 52      |
| — playlists                 | 132    | — sharing your location   | 51, 55  |
| <b>N</b>                    |        |                           |         |
| navigation tools            | 96     | Ovi Files                 | 30      |
| network                     |        | Ovi Music                 | 132     |
| — settings                  | 159    | Ovi Store                 | 20      |
| network settings            | 68     | Ovi Suite                 | 18      |
| news feeds                  | 85     | <b>P</b>                  |         |
| Nokia account               | 50, 55 | packet data               |         |
| Nokia Ovi Player            | 133    | — settings                | 164     |
| Nokia support information   | 182    | packet data connection    |         |
| notes                       | 95     | — access point settings   | 73, 162 |
| <b>O</b>                    |        |                           |         |
| operator                    |        | — counters                | 42      |
| — selecting                 | 159    | page overview             | 84      |
| original settings           | 157    | PDF reader                | 92      |
| out-of-office reply message | 48     | personalisation           | 154     |
| Ovi                         | 30     | — changing language       | 155     |
| Ovi by Nokia                | 19     | — display                 | 154     |
| Ovi Contacts                | 50     | personalising your device | 112     |
| — adding friends            | 52     | Photos                    |         |
| — availability status       | 51     | — tags                    | 124     |
|                             |        | photos                    | 122     |
|                             |        | — editing                 | 125     |
|                             |        | — file details            | 122     |

---





---

|                             |                  |                                |                  |
|-----------------------------|------------------|--------------------------------|------------------|
| service messages            | 62               | — restoring                    | 157              |
| — settings                  | 66               | — security                     | 156              |
| settings                    |                  | — service messages             | 66               |
| — access points             | 71, 72, 160, 161 | — SIP                          | 169              |
| — accessories               | 156              | — text messages                | 64               |
| — advanced WLAN             | 165              | — time                         | 155              |
| — applications              | 171              | — tones                        | 154              |
| — Bluetooth                 | 77               | — video sharing                | 39               |
| — browser                   | 87               | — WEP security                 | 166              |
| — call                      | 158              | — WLAN                         | 70, 75, 164, 165 |
| — camera                    | 118              | — WLAN internet access points  | 74, 163          |
| — cell broadcast            | 66               | — WLAN security                | 166              |
| — certificate               | 143              | Share online                   |                  |
| — date                      | 155              | — creating posts               | 129              |
| — display                   | 154              | shared video                   | 39               |
| — EAP plug-ins              | 168              | shortcuts                      | 126, 171         |
| — GPRS                      | 164              | SIM card                       |                  |
| — internet radio            | 138              | — inserting                    | 11               |
| — keypad lock               | 157              | — text messages                | 60               |
| — language                  | 155              | SIP                            |                  |
| — messages                  | 65               | — creating profiles            | 169              |
| — network                   | 68, 159          | — editing profiles             | 169              |
| — packet data               | 164              | — editing proxy servers        | 169              |
| — packet data access points | 73, 162          | — editing registration servers | 170              |
| — podcasting                | 131              | — settings                     | 169              |
| — positioning               | 100, 157         | slide show                     | 125              |
| — printer                   | 93               | SMS (short message service)    | 58               |
| — RealPlayer                | 135              | software applications          | 146              |

---

|                         |          |
|-------------------------|----------|
| software updates        | 182, 183 |
| sound clips             | 120      |
| speech                  | 57       |
| speed dialling          | 33       |
| streaming links         | 120      |
| support                 | 182      |
| Switch                  | 16       |
| Symbian applications    | 146      |
| synchronisation of data | 76, 150  |

### T

|                        |     |
|------------------------|-----|
| text                   |     |
| — changing size        | 154 |
| — predictive input     | 24  |
| text input             | 23  |
| text messages          |     |
| — messages on SIM card | 60  |
| — sending              | 58  |
| — settings             | 64  |
| themes                 | 114 |
| — downloading          | 115 |
| time                   |     |
| — settings             | 155 |
| tones                  |     |
| — settings             | 154 |
| transferring           |     |
| — data                 | 16  |
| transferring content   | 16  |
| transferring music     | 133 |

|                 |     |
|-----------------|-----|
| troubleshooting | 178 |
|-----------------|-----|

### U

|                    |     |
|--------------------|-----|
| updates            | 183 |
| UPIN code          | 20  |
| — changing         | 157 |
| UPUK code          | 20  |
| USB data cable     | 81  |
| useful information | 182 |

### V

|                         |        |
|-------------------------|--------|
| video                   |        |
| — playing               | 118    |
| video calls             | 36, 38 |
| video clips             | 122    |
| — details               | 135    |
| — playing               | 134    |
| — shared                | 39     |
| video sharing           |        |
| — accepting invitation  | 41     |
| — sharing live video    | 40     |
| — sharing video clips   | 40     |
| videos                  |        |
| — copying               | 16     |
| virtual private network |        |
| — use in applications   | 152    |
| voice calls             |        |
| — See <i>calls</i>      |        |
| voice commands          | 36     |

---

voice mail

— calling 32

— changing number 32

VPN

— access points 152

— use in applications 152

## W

web browser 82

web connection 82

welcome note 154

WEP

— keys 167

— security settings 166

wireless LAN (WLAN) 68

WLAN

— 802.1x security settings 167

— advanced settings 165

— MAC address 70, 165

— security settings 166

— settings 70, 165

— WEP keys 167

— WPA security settings 167

WLAN (wireless local area

network) 69

WPA security settings 167

wrist strap 13

## Z

Zip manager 92