



XPERIA™

Xperia™ active
Extended User guide

Sony Ericsson
make.believe

Contents

| | |
|--|-----------|
| Important information..... | 6 |
| Water resistance guide..... | 7 |
| Android™ – what and why?..... | 8 |
| Applications..... | 8 |
| Getting started..... | 9 |
| Assembly..... | 9 |
| Turning on the phone..... | 12 |
| Screen lock..... | 12 |
| Setup guide..... | 12 |
| Accounts and services..... | 13 |
| Getting to know your phone..... | 14 |
| Phone overview..... | 14 |
| Using the keys..... | 15 |
| Charging the battery..... | 15 |
| Using the touch screen..... | 16 |
| Home screen..... | 19 |
| Accessing and using applications..... | 21 |
| Status and notifications..... | 23 |
| Phone settings menu..... | 24 |
| Typing text..... | 24 |
| Keyboard and Phonepad settings..... | 27 |
| Adjusting the volume..... | 27 |
| Customising your phone..... | 28 |
| Battery..... | 30 |
| Memory..... | 31 |
| Stereo portable handsfree..... | 32 |
| Internet and messaging settings..... | 32 |
| Turning off data traffic..... | 33 |
| Data roaming..... | 34 |
| Network settings..... | 34 |
| Calling..... | 35 |
| Emergency calls..... | 35 |
| Call handling..... | 35 |
| Voicemail..... | 36 |
| Multiple calls..... | 37 |
| Conference calls..... | 37 |
| Call settings..... | 38 |
| Contacts | 39 |
| Opening the Contacts application for the first time..... | 39 |

| | |
|--|-----------|
| Getting contacts into your phone..... | 39 |
| Contacts screen overview..... | 40 |
| Managing your contacts..... | 40 |
| Communicating with your contacts..... | 42 |
| Sharing your contacts..... | 42 |
| Backing up contacts..... | 43 |
| Messaging..... | 44 |
| Using text and multimedia messaging..... | 44 |
| Text and multimedia message options..... | 45 |
| Email..... | 46 |
| Using email..... | 46 |
| Using email accounts..... | 48 |
| Gmail™ and other Google™ services | 48 |
| Google Talk™ | 50 |
| Sony Ericsson Timescape™..... | 51 |
| Timescape™ main view..... | 51 |
| Timescape™ widget..... | 51 |
| Using Timescape™..... | 52 |
| Timescape™ settings..... | 54 |
| Getting started with Android Market™..... | 55 |
| Payment options..... | 55 |
| Downloading from Android Market™..... | 55 |
| Clearing your application data..... | 56 |
| Permissions..... | 56 |
| Installing non-Android Market™ applications..... | 57 |
| PlayNow™ service..... | 58 |
| Before you download content..... | 58 |
| Downloading from the PlayNow™ service..... | 58 |
| Qriocity™ Video..... | 59 |
| Qriocity™ menu overview..... | 59 |
| Creating a Qriocity™ account..... | 59 |
| Exploring the Qriocity™ video selection..... | 59 |
| Renting or buying a video..... | 59 |
| Watching a video from Qriocity™..... | 60 |
| Getting organised..... | 61 |
| Calendar..... | 61 |
| Alarm clock..... | 61 |
| NeoReader™ application..... | 64 |
| NeoReader™ application menu overview..... | 64 |
| ANT+..... | 65 |

| | |
|--|------------|
| Synchronising..... | 66 |
| Synchronising with Google™..... | 66 |
| Synchronising your corporate email, calendar and contacts..... | 67 |
| Synchronising with Facebook™..... | 67 |
| Synchronising and storing your contacts and calendar..... | 68 |
| Synchronising using SyncML™..... | 69 |
| Connecting to wireless networks..... | 70 |
| Wi-Fi®..... | 70 |
| Virtual private networks (VPNs)..... | 74 |
| Web browser..... | 75 |
| Toolbar..... | 75 |
| Browsing the web..... | 75 |
| Navigating web pages..... | 76 |
| Managing bookmarks..... | 76 |
| Managing text and images..... | 77 |
| Multiple windows..... | 77 |
| Downloading from the web..... | 78 |
| Browser settings..... | 78 |
| Music..... | 79 |
| Copying media files to your memory card..... | 79 |
| Using the music player..... | 79 |
| TrackID™ technology..... | 84 |
| Using TrackID™ technology results..... | 84 |
| FM radio..... | 85 |
| FM radio overview..... | 85 |
| Moving between radio channels..... | 85 |
| Using your favourite radio channels..... | 85 |
| Making a new search for radio channels..... | 86 |
| Switching between the speaker and the handsfree..... | 86 |
| Identifying radio tracks using TrackID™..... | 86 |
| Taking photos and recording videos..... | 87 |
| Camera controls..... | 87 |
| Using the still camera..... | 88 |
| Using the video camera..... | 93 |
| Viewing your photos and videos in Gallery..... | 97 |
| Working with albums..... | 97 |
| Working with photos..... | 99 |
| Bluetooth™ wireless technology..... | 102 |
| Phone name..... | 102 |
| Pairing with another Bluetooth™ device..... | 102 |
| Sending and receiving items using Bluetooth™ technology..... | 103 |

| | |
|---|------------|
| Connecting your phone to a computer..... | 105 |
| Transferring and handling content using a USB cable..... | 105 |
| USB connection modes..... | 105 |
| Transferring files using Media transfer mode via Wi-Fi®..... | 106 |
| PC Companion..... | 107 |
| Media Go™ | 107 |
| Location services..... | 108 |
| Using GPS..... | 108 |
| Google Maps™..... | 109 |
| Getting directions..... | 109 |
| Locking and protecting your phone..... | 110 |
| IMEI number..... | 110 |
| SIM card protection..... | 110 |
| Setting a screen lock..... | 111 |
| Updating your phone..... | 113 |
| Updating your phone wirelessly..... | 113 |
| Updating your phone using a USB cable connection..... | 113 |
| Phone settings overview..... | 115 |
| Icon overview..... | 116 |
| Status icons..... | 116 |
| Notification icons..... | 116 |
| Application overview..... | 118 |
| User support..... | 120 |
| Troubleshooting..... | 121 |
| My phone is not working as expected..... | 121 |
| Resetting the phone..... | 121 |
| I cannot charge the phone..... | 121 |
| No battery charging icon appears when phone starts charging..... | 121 |
| The battery performance is low..... | 121 |
| I cannot transfer content between my phone and the computer, when using a USB cable..... | 121 |
| I cannot use Internet-based services..... | 122 |
| Error messages..... | 122 |
| Recycle your phone..... | 123 |
| Legal information..... | 124 |
| Index..... | 125 |

Important information

Please read the *Important information* leaflet before you use your mobile phone.

- ! Some of the services and features described in this User guide are not supported in all countries/regions or by all networks and/or service providers in all areas. Without limitation, this applies to the GSM International Emergency Number 112. Please contact your network operator or service provider to determine availability of any specific service or feature and whether additional access or usage fees apply.

Water resistance guide

In order for your **Xperia™ active** to be water resistant, the covers for the micro USB port and the headset connector must be firmly closed. Also, make sure that the back cover and the battery cover are attached correctly. The Startup guide provides instructions on how to correctly attach the battery cover and the back cover.

Avoid exposing your device to environments with excessive dust or moisture. Normal wear and tear along with damage to your device can reduce its ability to resist dust or moisture.



Ocean water



Swimming pool



Diving



Hot water



Sand/mud



Other liquid
chemicals

Never submerge the mobile phone, the micro USB port or the headset connector in water, expose the mobile phone to any liquid chemicals, or expose your mobile phone to moist environments with extreme high or low temperatures. If water or liquid gets on the micro USB port and the headset connector, wipe it off with a dry cloth. The water resistance of the micro USB port and the headset connector are not guaranteed in all environments or conditions.

All compatible accessories including batteries, chargers, handsfree devices, micro USB cables, microSD™ cards, lanyards and so on are not dust and water resistant on their own.

Your warranty does not cover damage or defects caused by abuse or improper use of your device. If you have any further questions about the use of your products, get help from our Customer support service.

Android™ – what and why?

An Android™ phone can perform many of the same functions as a computer. But you can also adjust it to better suit your needs, to receive the information you want, and have fun at the same time. You can add and delete applications, or enhance them to improve functionality. At Android Market™ you can download a range of applications and games from a constantly growing collection. You can also integrate applications on your Android™ phone with your personal data and online accounts. For example, you can back up your phone contacts, access your different email accounts and calendars from one place, keep track of your appointments, and engage in as much social networking as you like.

Android™ phones are constantly evolving. When a new software version is available and your phone supports this new software, you can update your phone to get new features and the latest improvements.

- 💡 Your Android™ phone is pre-loaded with Google™ services. To get the most out of the provided Google™ services, you should have a Google™ account and sign in to it when you first start your phone. You also need to have Internet access to use many of the features in Android™.

Applications

An application is a phone program that helps you perform a task. For example, there are applications to make calls, take photos and download more applications.

Getting started

Assembly

To remove the back cover and the battery cover



- 1 Insert a thumb nail into the gap under the headset connector cover and the micro USB port cover, then lift up the two covers.
- 2 Insert a thumb nail into the gap (as shown in step 2 of the illustration above), then lift up the back cover slowly but firmly.
- 3 Place a thumb nail under the lip (indicated by the arrow on the battery cover), then lift up and remove the battery cover.

! Do not use sharp objects that may damage parts of the phone.

To insert the SIM card and the memory card

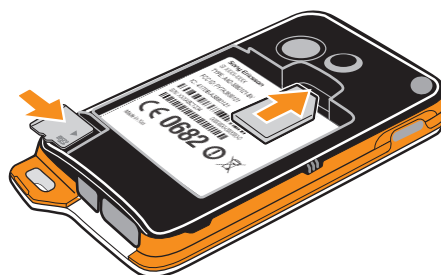

- Remove the back cover and the battery cover, then insert the SIM card and the memory card into the relevant slots.

! Memory card may not be included with purchase in all markets.

To remove the battery



- 1 Remove the back cover and the battery cover.
- 2 Place the tip of your finger into the opening on the bottom side of the battery and lift up the battery.

To remove the memory card

- ! You must unmount your memory card or turn off your phone before you can safely remove the memory card. For more information, see *Safely removing the memory card* on page 31.

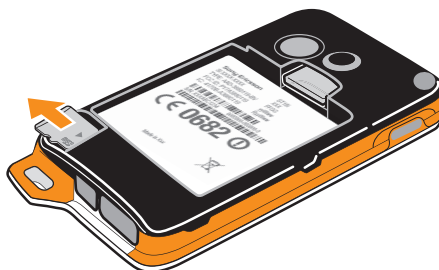

- Remove the back cover and the battery cover, then draw the memory card outwards to remove it.

To remove the SIM card



- 1 Remove the back cover, the battery cover and the battery.
- 2 Place the tip of your finger on the SIM card and slide it out of its slot.

To attach the battery cover and the back cover

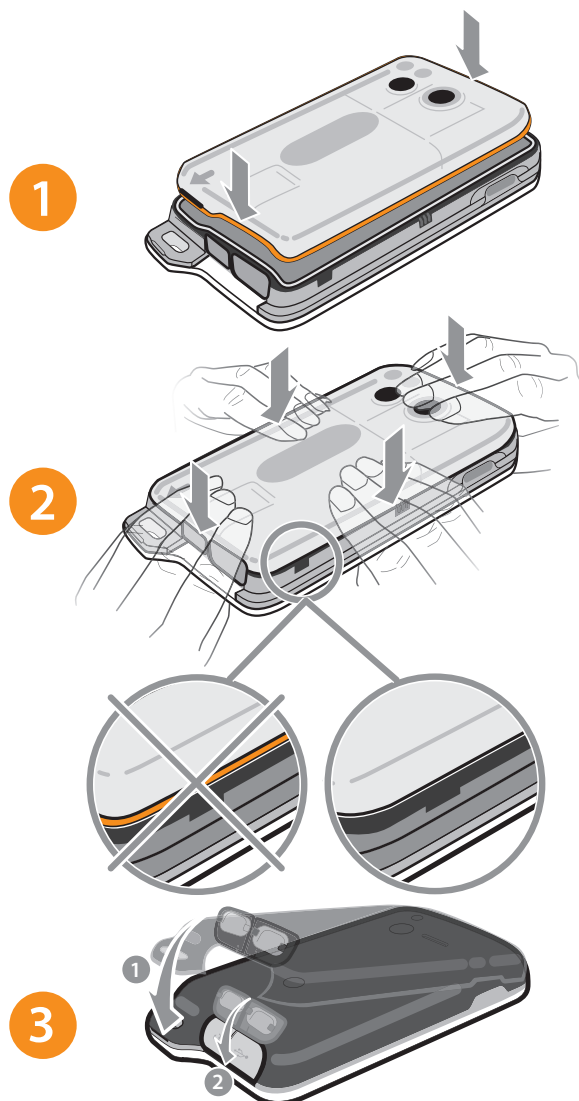





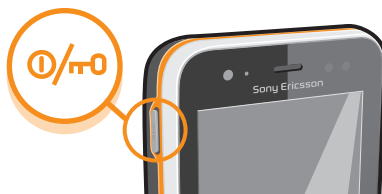

- 1 Place the battery cover over the back of the phone so that the camera lens hole in the cover fits over the camera lens.
 - 2 Press down gently on all edges of the battery cover to attach it securely.
 - 3 Place the back cover over the back of the phone so that the camera lens hole in the cover fits over the camera lens. Then press down firmly on all edges of the back cover to attach it tightly.
 - 4 Press down the micro USB port cover and the headset connector cover to make sure they are fully latched.
- ! Correctly attaching the back cover and the battery cover can keep your phone resistant to water. The phone is not resistant to water when the micro USB port cover or the headset connector cover is open, for example, when the phone is charging or when it's connected to a wired headset.



Turning on the phone

To turn on the phone



- 1 Press and hold down the power  key on the left side of the phone until the phone vibrates.
 - 2 If your screen goes dark, briefly press the  key to activate the screen.
 - 3 To unlock the screen, drag  to the right across the screen.
 - 4 Enter your SIM card PIN when requested, and select **OK**.
-  Your SIM card PIN is initially supplied by your network operator, but you can change it later from the **Settings** menu. To correct a mistake made while entering your SIM card PIN, press .
-  It may take a while for the phone to start up.

To turn off the phone

- 1 Press and hold down the power  key until the options menu opens.
 - 2 In the options menu, tap **Power off**.
 - 3 Tap **OK**.
-  It may take a while for the phone to shut down.

Screen lock

When your phone is on and left idle for a set period of time, the screen darkens to save battery power, and locks automatically. This lock prevents unwanted actions on the touch screen when you are not using it.

To activate the screen

- Briefly press the  key.

To unlock the screen



- Drag the  icon to the right across the screen.

To lock the screen manually

- When the screen is active, briefly press the  key.

Setup guide

The first time you start your phone, a setup guide opens to explain basic phone functions and help you enter essential settings. This is a good time to configure your phone to your specific needs.

The setup guide covers the following:

- Basic phone settings such as language and Internet. For example, you can adjust settings for how you access the Internet.
- Wi-Fi® settings – speed up your connection and decrease data transfer costs.
- Online service settings – helps you with email setup, online service accounts, and contact transfers from an old phone or other data source.

You can also refer to the respective chapters in the in-phone User guide, available through the Support application in the phone and at www.sonyericsson.com/support, for more help with the following:

- Wi-Fi®
- Sony Ericsson Sync

 If you prefer, you can skip some steps and access the setup guide later from the Application screen or change the settings from the **Settings** menu.

To access the setup guide

- 1 From the Home screen, tap .
- 2 Find and tap **Setup guide**.

Accounts and services

Sign in to your online service accounts from your phone and benefit from a range of services. Combine services and get even more out of them. For example, collect contacts from your Google™ and Facebook™ accounts and integrate them into your phonebook, so you have everything in one place.

You can sign up to online services from your phone as well as from a computer. When you sign up for the first time, an account is created with your user name, password, settings and personal information. The next time you sign in, you get a personalised view.

Google™ account

Having a Google account is key to using a range of applications and services with your Android phone. You need a Google™ account, for example, to use the Gmail™ application in your phone, to chat to friends using Google Talk™, to synchronise your phone calendar with your Google Calendar™, and to download applications and games from Android Market™.

Sony Ericsson account

Store your phone contacts on a secure Sony Ericsson server, and you'll always have a backup online. You can also store your phone calendar and Internet bookmarks in your Sony Ericsson account.

Exchange ActiveSync® account

Synchronise your phone with your corporate Exchange ActiveSync® account. This way, you keep your work email, contacts and calendar events with you at all times.

Facebook™ account

Facebook™ connects you with friends, family and colleagues all over the world. Log in now to share your world with others.

Getting to know your phone

Phone overview

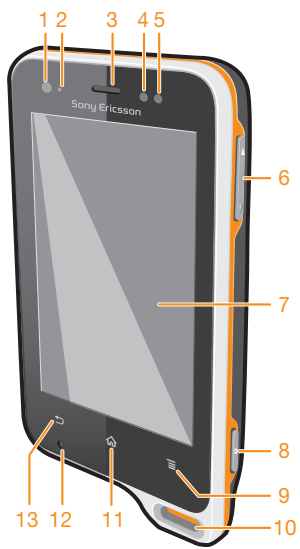

1. Light sensor
2. Notification LED
3. Ear speaker
4. Proximity sensor 1
5. Proximity sensor 2
6. Volume key/Zoom key
7. Touch screen
8. Camera key
9. Menu key
10. Strap hole
11. Home key
12. Main microphone
13. Back key
14. Second microphone
15. Camera LED light
16. Power key/Screen lock
17. Speaker
18. Camera lens
19. Micro USB port cover
20. Headset connector cover
21. Micro USB port
22. Headset connector

Using the keys

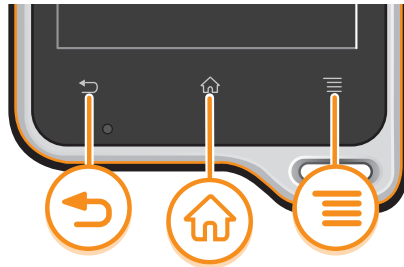

Back

- Go back to the previous screen
- Close the on-screen keypad, a dialog box, an options menu, or the Notification panel



Home

- Go to the Home screen
- Press and hold to open a window showing your most recently used applications



Menu

- Open a list of options available in the current screen or application

Charging the battery

Your phone battery is partly charged when you buy the phone. It may take a few minutes before the battery icon  appears on the screen when you connect the phone charger cable to a power source, such as a USB port or a phone charger. You can still use your phone while it is charging.

- ! The battery will start to discharge a little after it is fully charged and then charges again after a certain time when the phone charger is connected. This is to extend battery life and may result in the charge status showing a level below 100 percent.

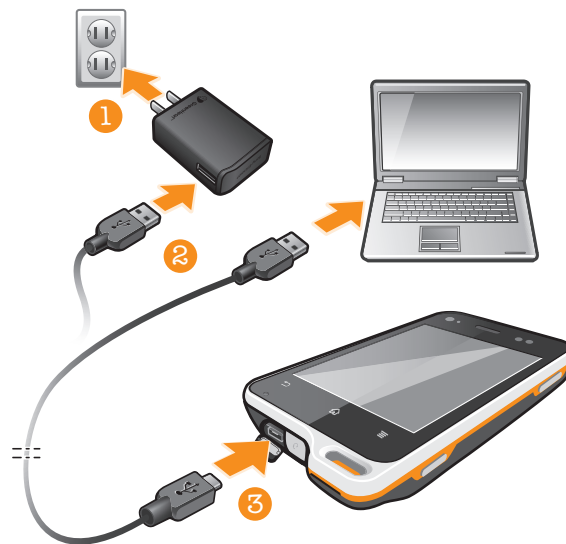

To charge the phone

- 1 Plug the phone charger into a power outlet.
- 2 Plug one end of the USB cable into the charger (or into the USB port of a computer).
- 3 Plug the other end of the cable into the micro USB port on your phone, with the USB symbol facing up.
- 4 When the phone is fully charged, disconnect the USB cable from your phone by pulling it straight outwards.

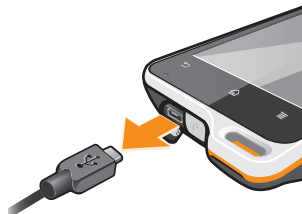

- ! Make sure not to bend the connector when removing the cable from the phone.

Using the touch screen

A protective plastic sheet is attached to the screen of your phone when you buy it. You need to peel off this sheet before using the touch screen. Otherwise, the touch screen might not function properly.

When your phone is on and left idle for a set period of time, the screen darkens to save battery power, and locks automatically. This lock prevents unwanted actions on the touch screen when you are not using it. You can also set personal locks to protect your subscription and make sure only you can access your phone.

- ! Your phone screen is made from glass. Do not touch the screen if the glass is cracked or shattered. Avoid trying to repair a damaged screen yourself. Glass screens are sensitive to mechanical shocks. Cases of negligent care are not covered by the Sony Ericsson warranty service.

To open or highlight an item

- Tap the item.

To mark or unmark options

- Tap the relevant checkbox, or in some cases the right side of the list option, to mark or unmark an option.

| | |
|-------------------------------------|----------------------|
| <input checked="" type="checkbox"/> | Marked checkbox |
| <input type="checkbox"/> | Unmarked checkbox |
| <input checked="" type="radio"/> | Marked list option |
| <input type="radio"/> | Unmarked list option |

Zooming

There are two ways to zoom. The zoom options available depend on the application you are using.

To zoom

- When available, tap **-** or **+** to zoom in or out.
- ! You may have to drag the screen (in any direction) to make the zoom icons appear.

To zoom with two fingers

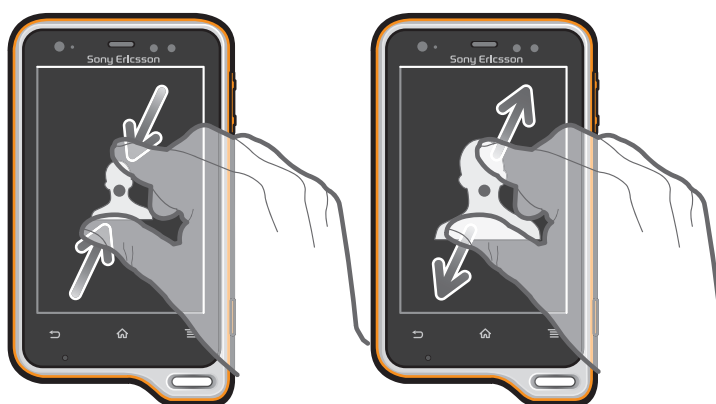

- Place two fingers on the screen at once and pinch them together (to zoom out) or spread them apart (to zoom in).
- 💡 Use the zoom function when viewing photos and maps, or when browsing the web.

Scrolling

Scroll by moving your finger up or down on the screen. On some web pages you can also scroll to the sides.

- ! Dragging or flicking will not activate anything on the screen.

To scroll

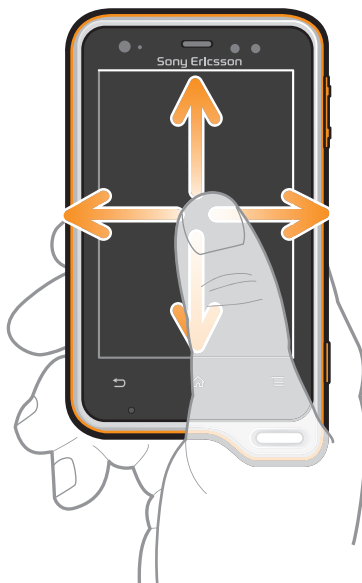

- Drag or flick your finger in the direction you want to scroll on the screen.
- 💡 To scroll more quickly, flick your finger in the direction you want to go on the screen.

To flick

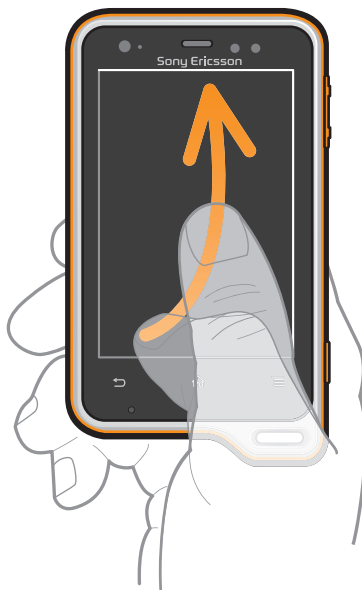

- To scroll more quickly, flick your finger in the direction you want to go on the screen. You can wait for the scrolling movement to stop by itself, or you can stop it immediately by tapping the screen.

Sensors

Your phone includes a light sensor and a proximity sensor. The light sensor detects the ambient light level and adjusts the brightness of the screen accordingly. The proximity sensor turns the touch screen off when your face touches the screen. This prevents you from unintentionally activating phone functions when you are engaged in a call.

Home screen

Your phone Home screen is the equivalent of the desktop on a computer. It's your gateway to the main features in your phone. You can customise your Home screen with widgets, shortcuts, folders, themes, wallpaper and other items.

The four corners on the Home screen help you access applications or web page shortcuts quickly.

The Home screen extends beyond the regular screen display width, so you need to flick left or right to view content in one of the screen's four extensions.  shows which part of the Home screen you are in.





To go to the Home screen

- Press .

To browse the Home screen

- Flick right or left.

To share an item from your Home screen

- 1 Press  to open your Home screen.
- 2 Touch and hold an item until it magnifies and the phone vibrates, then drag the item to .
- 3 Select an option and confirm, if necessary. You can now share the applications and widgets you like with your friends so they can download and use them.

Widgets

Widgets are small applications that you can use directly on your Home screen. For example, the **Music player** widget allows you to start playing music directly and the Sony Ericsson Timescape™ widget displays incoming messages.

To add a widget to the Home screen

- 1 From your Home screen, press .
- 2 Tap **Add > Widgets**.
- 3 Tap a widget.

To get an overview of all widgets on your Home screen

- Pinch on any area of your Home screen. All widgets from different parts of your Home screen are now displayed in one view.
-  When all Home screen widgets are combined in one view, tap on any widget to go to the part of the Home screen containing that widget.

Rearranging your Home screen

Customise the appearance of your Home screen and change the features that you can access from it. Change the screen background, move items around, create folders, and add shortcuts to contacts.

To open the options menu of your Home screen

You can open the Home screen options menu in two ways:

- From your Home screen, press .
- Touch and hold on any part of your Home screen.

Rearranging your Home screen corners

Rearrange the items in your Home screen corners with the applications or web page shortcuts (bookmarks) you access most frequently. You can add a maximum of four shortcuts to each of the corners.

To add an application to a corner

- 1 From your Home screen, tap .
- 2 Touch and hold an application until the Home screen appears and the phone vibrates, then drag the application to one of the corners.

To add a web page shortcut to a corner

- 1 From your Home screen, press .
- 2 Tap **Add > Shortcuts > Bookmark**.
- 3 Select a bookmark to add the bookmark to your Home screen.
- 4 Drag the bookmark to one of the corners.

 See *To add a web page shortcut to your Home screen* on page 76.

To delete an item from a corner

- 1 From your Home screen, tap one of the corners to magnify the corner.
- 2 Touch and hold an item in the corner until the phone vibrates, then drag the item to .

To move an item away from a corner

- 1 From your Home screen, tap one of the corners to magnify the corner.
- 2 Touch and hold an item in the corner until the phone vibrates, then drag the item away from the corner and drop the item on an area of your Home screen.

To add a shortcut to the Home screen

- 1 From your Home screen, press .
- 2 Tap **Add > Shortcuts**.
- 3 Find and select a shortcut.

 Add an application shortcut directly from the Application screen by touching and holding the application.

To add a folder to the Home screen

- 1 From your Home screen, press .
- 2 Tap **Add > Folder**.
- 3 Enter a name for the folder, select an icon, and tap **Done**.

 Drop an item on top of another item on your Home screen to create a folder automatically.

To add items to a folder

- Touch and hold an item until it magnifies and the phone vibrates, then drag the item to the folder.

To rename a folder

- 1 Tap the folder to open it.
- 2 Touch the folder's title bar to show the **Folder name** field.
- 3 Enter the new folder name and tap **Done**.

To move an item on the Home screen

- 1 Press  to open your Home screen.
- 2 Touch and hold an item until it magnifies and the phone vibrates, then drag the item to the new location.



To delete an item from the Home screen

- Touch and hold an item until it magnifies and the phone vibrates, then drag the item to .



Changing the background of your Home screen

Adapt the Home screen to your own style using wallpapers and different themes.

To change your Home screen wallpaper

- 1 From your Home screen, press .
 - 2 Tap **Wallpaper**, then select a wallpaper.
-  You can use a photo you have taken, or an animation. Go to Android Market™ and other sources to download, for example, live wallpapers that change with the changing hours of the day.

To set a theme

- 1 From your Home screen, press .
 - 2 Tap **Theme**, then select a theme.
-  When you change a theme, the background also changes in some applications.

Accessing and using applications

Open applications from shortcuts on your Home screen or from the Application screen.

Application screen

The Application screen, which you open from your Home screen, contains the applications that come installed with your phone as well as the applications you download.

The Application screen extends beyond the regular screen width, so you need to flick left and right to view all content.

To open the Application screen



- From your Home screen, tap .



To browse the Application screen

- Open the Application screen, then flick right or left.

To create a shortcut to an application on the Home screen

- 1 From your Home screen, tap .
- 2 Touch and hold an application until it appears on your Home screen, then drag it to the desired location.

To share an application from your Application screen

- 1 From your Home screen, tap .
- 2 Touch and hold an application until it appears on your Home screen, then drag the item to .
- 3 Select an option and confirm, if necessary. You can now share the applications you like with your friends so they can download and use them.

Opening and closing applications

To open an application

- From your Home screen or the Application screen, tap the application.

To close an application

- Press .
- 💡 Some applications are paused when you press  to exit, while other applications may continue to run in the background. In the first case, the next time you open the application, you can continue where you left off.

Recently used applications window

You can view and access recently used applications from this window.

To open the recently used applications window

- Press and hold down .

Application menu

You can open a menu at any time when you are using an application by pressing the  key on your phone. The menu will look different depending on which application you are using.

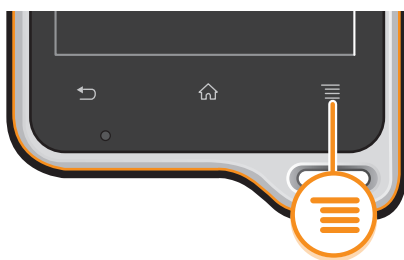

To open a menu in an application

- While using the application, press .
- ! A menu is not available in all applications.



Rearranging your Application screen

Move the applications around on the Application screen according to your preferences.



To arrange applications on the Application screen

- 1 From your Home screen, tap  to go to the Application screen.
- 2 Tap  and select an option.

To move an application on the Application screen

- 1 Open the Application screen, then tap .
 - 2 Touch and hold an item until it magnifies and the phone vibrates, then drag the item to the new location.
 - 3 Tap  to exit edit mode.
- ! You can only move your applications when  is selected.

To uninstall an application from the Application screen

- 1 From your Home screen, tap .
- 2 Tap . All uninstalleable applications are marked with a  icon.
- 3 Tap the application you want to uninstall, then tap **OK**.

Status and notifications

The status bar at the top of your screen shows what's going on in your phone. To the left you get notifications when there is something new or ongoing. For example, new message and calendar notifications appear here. The right side shows the signal strength, battery status, and other information.



Checking notifications and ongoing activities

You can drag down the status bar to open the Notification panel and get more information. For example, open a new message or view a calendar event from the Notification panel. You can also open running applications, such as the music player.

To open the Notification panel



- Drag the status bar downwards.

To close the Notification panel

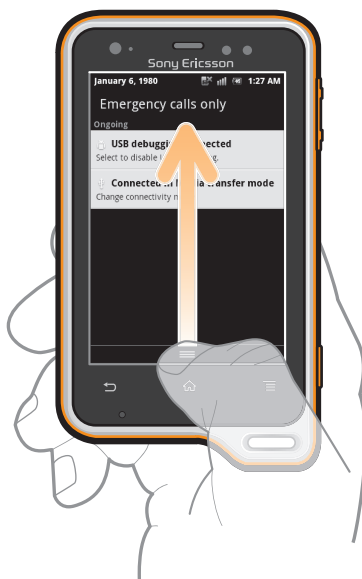

- Drag the tab at the bottom of the Notification panel upwards.

To open a running application from the Notification panel

- From the Notification panel, tap the icon for the running application to open it.

To clear the Notification panel

- From the Notification panel, tap **Clear**.

Phone settings menu

View and change your phone settings from the Settings menu.

To access the phone settings

- 1 From the Home screen, tap .
- 2 Tap **Settings**.

Typing text

Use either the Phonepad or the on-screen keyboard to enter letters, numbers and other characters. The Phonepad is similar to a standard 12-key telephone keypad while the on-screen keyboard has a QWERTY layout.

Phonepad

The Phonepad is similar to a standard 12-key telephone keypad. It gives you predictive text and multi-tap input options. You can activate the Phonepad text input method via the keyboard settings. The Phonepad is only available in portrait orientation.

Using the Phonepad

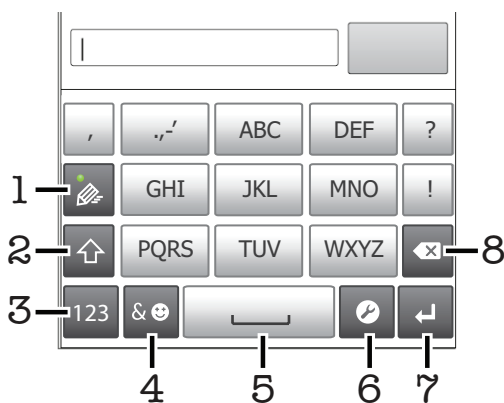

- 1 Choose a text input option
- 2 Change the character case and turn on the caps lock
- 3 Display numbers
- 4 Display symbols and smileys
- 5 Enter a space
- 6 Open the input settings menu to change, for example, the **Writing languages**. This key also changes the writing language when more than one input language is selected.
- 7 Enter a carriage return or confirm text input
- 8 Delete a character before the cursor

! All illustrations are for illustration purposes only and may not accurately depict the actual phone.

To display the Phonepad to enter text

- While holding the phone in portrait orientation, tap a text entry field.

To enter text using the Phonepad

When using the Phonepad, you can choose from two input options:

- When appears in the Phonepad, tap each character key only once, even if the letter you want is not the first letter on the key. Tap the word that appears or tap to view more word suggestions and select a word from the list.
- When appears in the Phonepad, tap the on-screen key for the character you want to enter. Keep pressing this key until the desired character is selected. Then do the same for the next character you want to enter, and so on.

To hide the Phonepad

- When the Phonepad is open, press .

To shift between upper-case and lower-case letters

- Before you enter a letter, tap to switch to upper-case , or vice versa.

To turn on the caps lock

- Before you type a word, tap or until appears.

To enter numbers using the Phonepad

- When the Phonepad is open, tap . A Phonepad with numbers appears.

To insert symbols and smileys using the Phonepad

- 1 When the Phonepad is open, tap . A grid with symbols and smileys appears.
- 2 Scroll up or down to view more options. Tap a symbol or smiley to select it.

To delete characters

- Tap to place the cursor after the character you want to delete, then tap .

To enter a carriage return

- When you enter text, tap .

To edit text

- 1 When you enter text, touch and hold the text field until the **Edit text** menu appears.
- 2 Select an option.

On-screen keyboard

Tap the keys of the on-screen QWERTY keyboard to enter text conveniently. Some applications open the on-screen keyboard automatically. You can also open this keyboard by touching a text field.

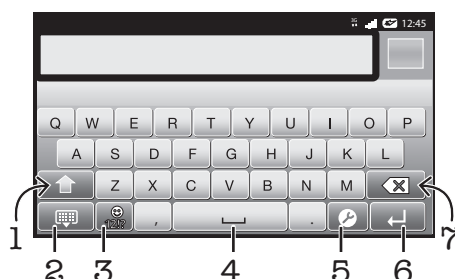

Using the on-screen keyboard





- 1 Change the character case and turn on the caps lock. For some languages, this key is used to access extra characters in the language.
- 2 Close the on-screen keyboard view
- 3 Display numbers and symbols. Touch and hold to display smileys.
- 4 Enter a space
- 5 Open the input settings menu to change, for example, the **Writing languages**. This key also changes the writing language when more than one input language is selected.
- 6 Enter a carriage return or confirm text input
- 7 Delete a character before the cursor

! All illustrations are for illustration purposes only and may not accurately depict the actual phone.

To open the on-screen keyboard for the first time

- Hold your phone horizontally and tap a text entry field.
 - To use the on-screen keyboard in portrait orientation, tap a text entry field, then tap  or touch and hold  if you have already selected more than one input language. Tap **Portrait keyboard** and select an option.
- 💡 Once you've made the setting, you can simply activate the on-screen keyboard by tapping a text entry field.



To switch between the on-screen keyboard and the Phonepad

- 1 When you enter text, tap , or touch and hold  if you have already selected more than one input language.
 - 2 Tap **Portrait keyboard** and select an option.
- ! Remember the Phonepad is only available in portrait orientation.

To enter text using the on-screen keyboard

- To enter a character visible on the keyboard, tap the character.
- To enter a character variant, touch and hold a regular keyboard character to get a list of available options, then select from the list. For example, to enter "é", touch and hold "e" until other options appear, then, while keeping your finger pressed on the keyboard, drag to and select "é".

To enter numbers or symbols

- When you enter text, tap . A keyboard with numbers and symbols appears. Tap  to view more options.



To insert a smiley

- 1 When you enter text, touch and hold .
- 2 Select a smiley.



Keyboard and Phonepad settings

You can select settings for the on-screen keyboard and the Phonepad, such as writing language and automatic correction.

To access the on-screen keyboard and the Phonepad settings

- When you enter text using the on-screen keyboard or Phonepad, tap . If you have selected more than one writing language, touch and hold  instead.



To change writing language using the on-screen keyboard or the Phonepad

- 1 When you enter text, tap , or touch and hold  if you have already selected more than one input language.
- 2 Tap **Writing languages** and select the languages you want to use for writing.
- 3 If you have selected more than one input language, tap  to switch between the selected writing languages.

Text input settings

When entering text, you can access a text input settings menu that helps you set options for text prediction. For example, you can decide how you want the phone to present word alternatives and correct words as you type, or enable the text input application to remember new words you write.

To change the text input settings

- 1 When you enter text using the on-screen keyboard or the Phonepad, tap , or touch and hold .
- 2 Tap **Text input settings**.
- 3 Select the desired settings.

Adjusting the volume

You can adjust the ringtone volume for phone calls and notifications as well as for music and video playback.

To adjust the ring volume with the volume key

- Press the volume key up or down.

To adjust the media playing volume with the volume key

- When playing music or watching video, press the volume key up or down.

To set the phone to silent and vibrate mode

- 1 From the Home screen, tap .
- 2 Find and tap **Settings** > **Sound**.
- 3 Mark the **Silent mode** checkbox.
- 4 Select **Vibrate** and choose an option.

To enhance the speaker loudness

- 1 From the Home screen, tap .
- 2 Find and tap **Settings** > **Sound**.
- 3 Mark the **xLOUD™** checkbox.

Customising your phone

Adapt the phone to your needs by adjusting, for example, your personal ringtone, phone language and your Privacy settings.

Time and date

You can change the time and date in your phone.

To set the date manually

- 1 From the Home screen, tap .
- 2 Find and tap **Settings** > **Date & time**.
- 3 Unmark the **Automatic** checkbox, if it is marked.
- 4 Tap **Set date**.
- 5 Adjust the date by scrolling up and down.
- 6 Tap **Set**.

To set the time manually

- 1 From the Home screen, tap .
- 2 Find and tap **Settings** > **Date & time**.
- 3 Unmark the **Automatic** checkbox, if it is marked.
- 4 Tap **Set time**.
- 5 Adjust the hour and minute by scrolling up and down.
- 6 Tap **AM** to change to **PM** or vice versa.
- 7 Tap **Set**.

! If you want to use **AM** and **PM**, you have to unmark **Use 24-hour format**.

To set the time zone

- 1 From the Home screen, tap .
- 2 Find and tap **Settings** > **Date & time**.
- 3 Unmark the **Automatic** checkbox, if it is marked.
- 4 Tap **Select time zone**.
- 5 Select an option.

To set the date format

- 1 From your Home screen, tap .
- 2 Find and tap **Settings** > **Date & time** > **Select date format**.
- 3 Select an option.

Ringtone settings

To set a phone ringtone

- 1 From your Home screen, tap .
- 2 Find and tap **Settings** > **Sound** > **Phone ringtone**.
- 3 Select a ringtone.
- 4 Tap **Done**.

To enable touch tones

- 1 From your Home screen, tap .
- 2 Find and tap **Settings** > **Sound**.
- 3 Mark the **Audible touch tones** and **Audible selection** checkboxes.

To select a notification ringtone

- 1 From your Home screen, tap .
- 2 Find and tap **Settings** > **Sound** > **Notification ringtone**.
- 3 Select a ringtone.
- 4 Tap **Done**.

To set a vibrating alert

- 1 From your Home screen, tap .
- 2 Find and tap **Settings** > **Sound**.
- 3 Select **Vibrate** and choose an option.

Screen settings

To adjust the screen brightness

- 1 From your Home screen, tap .
- 2 Find and tap **Settings** > **Display** > **Brightness**.
- 3 To decrease the screen brightness, drag the slider to the left. To increase it, drag the slider to the right.
- 4 Tap **OK**.

 The brightness level affects your battery performance. For tips on how to improve battery performance, see *Battery performance* on page 30.

To set the screen to vibrate

- 1 From your Home screen, tap .
- 2 Find and tap **Settings** > **Sound**.
- 3 Mark the **Haptic feedback** checkbox. The screen now vibrates when you tap soft keys and certain applications.

To adjust the idle time before the screen turns off

- 1 From your Home screen, tap .
- 2 Find and tap **Settings** > **Display** > **Screen timeout**.
- 3 Select an option.

 To turn off the screen quickly, briefly press the power key .

To keep the screen on while charging the phone



- 1 From the Home screen, tap .
- 2 Find and tap **Settings** > **Applications** > **Development**.
- 3 Mark the **Stay awake** check box.

Phone language

You can select a language to use in your phone.

To change the phone language

- 1 From your Home screen, tap .
- 2 Find and tap **Settings** > **Language & keyboard** > **Select language**.
- 3 Select an option.
- 4 Tap **Done**.

 If you choose the wrong language and cannot read the menu texts, find and tap the **Settings** icon . Then select the entry beside , and select the first entry in the following menu. You can then select the language you want.

Airplane mode

In Airplane mode, your phone's network and radio transceivers are turned off to prevent disturbance to sensitive equipment. However, you can still play games, listen to music, watch videos and other content, as long as all this content is saved on your memory card. You can also be notified by alarms, if alarms are activated.

- 💡 Turning on Airplane mode reduces battery consumption.

To turn on Airplane mode

- 1 From your Home screen, tap .
- 2 Find and tap **Settings** > **Wireless & networks**.
- 3 Mark the **Airplane mode** checkbox.

- 💡 You can also select **Airplane mode** from the **Phone options** menu. To access the **Phone options** menu, press and hold the power key .

Battery

Your Android™ phone keeps you connected and updated wherever you are. This affects the battery life of your phone. Below are some tips on how to prolong battery life while still staying connected and up to date.

Battery performance

- ! Standby time, a common term when it comes to battery performance, refers to the time during which the phone is connected to the network and is not being used. The more time your phone is in standby and not otherwise in operation, the longer the battery lasts.

The following tips can help you improve battery performance:

- Charge your phone often. This will not affect the lifetime of the battery.
 - Downloading data from the Internet is power consuming. When you're not using the Internet, you can save power by disabling all data connections over mobile networks. You can do this from **Settings** > **Wireless & networks** > **Mobile networks**. This setting does not prevent your phone from transmitting data over other wireless networks.
 - Turn off GPS, Bluetooth™ and Wi-Fi® when you don't need these features. You can turn them on and off more easily by adding the Status switch widget to your Home screen. You do not need to turn off 3G.
 - Set your synchronisation applications (used to synchronise your email, calendar and contacts), to synchronise manually. You can also synchronise automatically, but increase the intervals.
 - Check the battery usage menu in the phone to see which applications use the most power. Your battery consumes more power when you use video and music streaming applications such as YouTube™. Some Android Market™ applications also consume more power.
 - Close and exit applications that you are not using since multitasking affects the battery performance.
 - Lower the screen display brightness level.
 - Turn off your phone or use **Airplane mode** if you are in an area with no network coverage. Otherwise, your phone repeatedly scans for available networks, and this consumes power.
 - Use a Sony Ericsson original handsfree device to listen to music. This consumes less battery power than when you listen to music through the phone's loudspeakers.
- ! For more information about how to maximise your battery performance, visit www.sonyericsson.com/support.

To access the battery usage menu

- 1 From the Home screen, tap .
- 2 Find and tap **Settings** > **About phone** > **Battery use** to see which installed applications consume the most battery power.

To add the Data traffic widget to your Home screen

- 1 From your Home screen, press .
- 2 Tap **Add > Widgets**.
- 3 Select the **Data traffic** widget. You can now turn on and off your data connection more easily.

To add the Status switch widget to your Home screen

- 1 From your Home screen, press .
- 2 Tap **Add > Widgets**.
- 3 Select the **Status switch** widget.

Battery LED status

| | |
|--------------|--|
| Green | The battery is fully charged |
| Flashing red | The battery level is low |
| Orange | The battery is charging. The battery level is between low and full |

To check the battery level

- 1 From the Home screen, tap .
- 2 Find and tap **Settings > About phone > Status**.

Memory

You can save content on a memory card and in the phone memory. Music, video clips and photos are saved on the memory card while applications, contacts and messages are saved in the phone memory.

- ! You can move some applications from the phone memory to the memory card.

To move an application to the memory card

- 1 From your Home screen, tap .
- 2 Find and tap **Settings > Applications > Manage applications**.
- 3 Tap the desired application.
- 4 Tap **Move to SD card**.

- ! It is not possible to move some applications from the phone memory to the memory card.

Memory card

- ! You may have to purchase a memory card separately.

Your phone supports a microSD™ memory card, which is used for media content. This type of card can also be used as a portable memory card with other compatible devices.

- ! Without a memory card you cannot use the camera, nor can you play or download music files and video clips.

Safely removing the memory card

You can safely remove the memory card from your phone any time when the phone is turned off. If you want to remove the memory card when your phone is on, you must first unmount the memory card before you physically remove it from the phone. This can prevent damaging the memory card or losing data stored on the memory card.

To unmount the memory card

- 1 From your Home screen, tap .
- 2 Find and tap **Settings > Storage > Unmount SD card**.

Formatting the memory card

You can format the memory card in your phone, for example, to free up memory. This means that you erase all data on the card.

- ! All content on the memory card gets erased when you format it. Make sure you make backups of everything you want to save before formatting the memory card. To back up your content, you can copy it to your computer. For more information, refer to the chapter *Connecting your phone to a computer* on page 105.

To format the memory card

- 1 From your Home screen, tap .
- 2 Find and tap **Settings** > **Storage** > **Unmount SD card**.
- 3 After you have unmounted the memory card, tap **Erase SD card**.

Stereo portable handsfree



To use a handsfree

- 1 Connect a portable handsfree.
 - 2 To answer a call, press the call handling key. If you listen to music, it stops when you receive a call and resumes when the call has ended.
 - 3 To end a call, press the call handling key.
- ! If a portable handsfree is not included with the phone, you may purchase it separately.

Internet and messaging settings

To send text and multimedia messages and to access the Internet, you must have a 2G/3G mobile data connection and the correct settings. There are different ways to get these settings:

- For most mobile phone networks and operators, Internet and messaging settings come preinstalled on your phone. You can then start using the Internet and send messages right away.
- In some cases you will get the option to download Internet and messaging settings the first time you turn on your phone. It is also possible to download these settings later from the **Settings** menu.
- You can manually add and change Internet and network settings in your phone at any time. Contact your network operator for detailed information on your Internet and messaging settings.

To download Internet and messaging settings





- 1 From your Home screen, tap .
- 2 Find and tap **Settings** > **Sony Ericsson** > **Internet settings**.

To view the current Access Point Name (APN)

- 1 From the Home screen, tap .
- 2 Find and tap **Settings** > **Wireless & networks** > **Mobile networks**.
- 3 Tap **Access Point Names**.



! If you have several available connections, the active network connection will be indicated by a marked button to the right.

To configure APN settings manually

- 1 From the Home screen, tap .
- 2 Find and tap **Settings** > **Wireless & networks** > **Mobile networks** > **Access Point Names**.
- 3 Press .
- 4 Tap **New APN**.
- 5 Tap **Name** and enter the name of the network profile you want to create.
- 6 Tap **APN** and enter the access point name.
- 7 Enter all other information required by your network operator.
- 8 Press  and tap **Save** .

! Contact your network operator for detailed information about your network settings.

To reset the default Internet settings

- 1 From the Home screen, tap .
- 2 Tap **Settings** > **Wireless & networks** > **Mobile networks** > **Access Point Names**.
- 3 Press .
- 4 Tap **Reset to default**.

Usage info

For quality purposes, Sony Ericsson collects anonymous bug reports and statistics regarding your phone usage. None of the information gathered includes personal data. By default, the usage info sending option is not activated. But you can choose to activate it if you like.

To send usage info

- 1 From your Home screen, tap .
- 2 Find and tap **Settings** > **Sony Ericsson** > **Usage info**.
- 3 Mark the **Send usage info** checkbox.

Turning off data traffic

You can disable all data connections over 2G/3G networks with your phone to avoid any unwanted data downloads and synchronisations. Contact your network operator if you need detailed information about your subscription plan and data traffic costs.

💡 When data traffic is turned off, you can still use Wi-Fi® and Bluetooth™ connections. You can also send and receive multimedia messages.

To turn off all data traffic

- 1 From your Home screen, tap .
- 2 Find and tap **Settings** > **Wireless & networks** > **Mobile networks**.
- 3 Unmark the **Data enabled** checkbox.

Data roaming

Depending on your network operator, it might be possible to allow mobile data connections via 2G/3G outside of your home network (roaming). Please note that data transmission charges may apply. Contact your network operator for more information.

- ! Applications may sometimes use the Internet connection in your home network without any notification, for example, when sending search and synchronisation requests. Additional charges may apply for data roaming. Consult your service provider.

To activate data roaming

- 1 From the Home screen, tap .
- 2 Find and tap **Settings** > **Wireless & networks** > **Mobile networks**.
- 3 Mark the **Data roaming** checkbox.

- ! You can't activate data roaming when data connections have been deactivated

Network settings

Your phone automatically switches between networks depending on available networks over different locations. Initially, your phone is configured to use the fastest mobile network mode available for data. But you can configure your phone manually to use only a slower 2G network mode for data, to extend the life of your battery between charges. You can also configure your phone to access a different set of network modes entirely, or to behave in special ways when roaming.

To select a network mode

- 1 From your Home screen, tap .
- 2 Find and tap **Settings** > **Wireless & networks** > **Mobile networks**.
- 3 Tap **Network Mode**.
- 4 Select a network mode.

To select another network manually

- 1 From the Home screen, tap .
- 2 Find and tap **Settings** > **Wireless & networks** > **Mobile networks** > **Network operators**.
- 3 Tap **Search mode**.
- 4 When a popup window appears, tap **Select manually**.
- 5 Select a network.

- ! If you select a network manually, your phone will not search for other networks, even if you move out of range of the manually selected network.

To activate automatic network selection

- 1 From the Home screen, tap .
- 2 Find and tap **Settings** > **Wireless & networks** > **Mobile networks** > **Network operators**.
- 3 Tap **Search mode**.
- 4 Tap **Select automatically**.

Calling

Emergency calls

Your phone supports international emergency numbers, for example, 112 or 911. You can normally use these numbers to make emergency calls in any country, with or without the SIM card inserted, if you are within range of a network.

To make an emergency call

- 1 From your Home screen, tap .
- 2 Find and Tap **Phone**.
- 3 Enter the emergency number and tap **Call**. To delete a number, tap .

 You can make emergency calls when no SIM card is inserted or when outgoing calls are barred.

To make an emergency call while the SIM card is locked

- 1 Tap **Emergency call**.
- 2 Enter the emergency number and tap **Call**. To delete a number, tap .



Call handling

You can make a call by manually dialling a phone number, by tapping a number saved in your phone's contact list, or by tapping  next to a phone number in your **Call log**.

When you make a call, your phone's main microphone works together with the second microphone to suppress noise and background sound.

 Do not cover the second microphone while you make a call.

To make a call by dialling

- 1 From your Home screen, tap .
- 2 Find and tap **Phone**.
- 3 Enter the number of the recipient and tap **Call**. To delete a number, tap .

To end a call

- Tap .

To make an international call

- 1 From your Home screen, tap .
- 2 Find and tap **Phone**.
- 3 Touch and hold 0 until a "+" sign appears.
- 4 Enter the country code, area code (without the first 0) and phone number, then tap **Call**.

To answer a call



- Drag  to the right across the screen.

 If you are using regular headphones without a microphone, you have to remove the headphones from the headset connector to be able to answer the call.

To decline a call

- Drag  to the left across the screen.

To change the ear speaker volume during a call

- Press the volume key up or down.

To turn on the loudspeaker during a call

- Tap .

To mute the microphone during a call

- Tap .

To activate the screen during a call

- Press .

To enter numbers during a call

- 1 During a call, tap . A keypad appears.
- 2 Enter numbers.

To mute the ringtone for an incoming call

- When you receive the call, press the volume key.



Recent calls

In the call log, you can view recently missed , received  and dialled  calls.

To view your missed calls

- 1 When you have missed a call,  appears in the status bar. Drag the status bar downwards.
- 2 Tap **Missed call**.

To call a number from your call log

- 1 From your Home screen, tap .
- 2 Find and tap **Phone** > **Call log** to enter the call log view.
- 3 To call a number directly, tap  next to the number. To edit a number before calling, touch and hold the number, then tap **Edit number before call**.

To add a number from the call log to your contacts

- 1 From your Home screen, tap .
- 2 Find and tap **Phone** > **Call log**.
- 3 Touch and hold the number, then tap **Add to Contacts**.
- 4 Tap the desired contact, or tap **Create new contact**.
- 5 Edit the contact details and tap **Done**.

Voicemail

If your subscription includes a voicemail service, callers can leave voice messages for you when you can't answer calls. Your voicemail service number is normally saved on your SIM card. If not, you can get the number from your service provider and enter it manually.

To enter your voicemail number

- 1 From the Home screen, tap .
- 2 Find and tap **Settings** > **Call settings** > **Voicemail settings** > **Voicemail number**.
- 3 Enter your voicemail number.
- 4 Tap **OK**.

To call your voicemail service

- 1 From your Home screen, tap .
- 2 Find and tap **Phone**.
- 3 Touch and hold **1**.

Multiple calls

If you have activated call waiting, you can handle multiple calls at the same time. When it is activated, you will be notified by a beep if you receive another call.

To activate or deactivate call waiting

- 1 From the Home screen, tap .
- 2 Find and tap **Settings** > **Call settings** > **Additional settings**.
- 3 To activate or deactivate call waiting, tap **Call waiting**.

To reject a second call

- When you hear repeated beeps during a call, tap **Busy**.



To answer a second call and end the ongoing call

- When you hear repeated beeps during a call, tap **End current call & answer**.

To answer a second call and put the ongoing call on hold

- When you hear repeated beeps during a call, tap **Answer**.

To make a second call

- 1 During an ongoing call, tap .
- 2 Enter the number of the recipient and tap .
- 3 If the recipient answers, the first call is put on hold.

- 💡 The same procedure applies to subsequent calls.

To switch between multiple calls

- To switch to another call and put the current call on hold, tap the desired number or contact.



To end the ongoing call and return to the next call on hold

- Tap .

Conference calls

With a conference or multiparty call, you can have a joint conversation with two or more persons.

To make a conference call

- 1 During an ongoing call, tap .
- 2 Dial the number of your second participant and tap .
- 3 If the second participant answers, the first call is put on hold.
- 4 Tap .

- 💡 To add more participants, repeat steps 1 to 4.

To have a private conversation with a conference call participant

- 1 During an ongoing conference call, tap the button showing the number of participants. For example, tap **3 participants** if there are three participants on the call.
- 2 Tap the name of the participant you want to talk to privately.
- 3 To end the private conversation and return to the conference call, tap .

To release a participant from a conference call

- 1 During an ongoing conference call, tap the button showing the number of participants. For example, tap **3 participants** if there are three participants.
- 2 Tap  next to the participant you want to release.

To end a conference call

- During the call, tap .

Call settings

Barring calls

You can bar all or certain categories of incoming and outgoing calls. When you use call barring for the first time, you need to enter your PUK (Personal Unblocking Key) and then a new password to activate the call barring function.

To bar incoming or outgoing calls

- 1 From your Home screen, tap .
- 2 Find and tap **Settings** > **Call settings** > **Call barring**.
- 3 Select an option.
- 4 Enter the password and tap **Enable**.

Forwarding calls

You can forward calls, for example, to another phone number, or to an answering service.

To forward calls

- 1 From your Home screen, tap .
- 2 Find and tap **Settings** > **Call settings** > **Call forwarding**.
- 3 Select an option.
- 4 Enter the number you want to forward the calls to, then tap **Enable**.

To turn off call forwarding

- 1 From your Home screen, tap .
- 2 Find and tap **Settings** > **Call settings** > **Call forwarding**.
- 3 Select an option, then tap **Disable**.

Showing or hiding your phone number

You can select to show or hide your phone number on call recipients' devices when you call them.

To show or hide your phone number

- 1 From your Home screen, tap .
- 2 Find and tap **Settings** > **Call settings** > **Additional settings** > **Caller ID**.

Fixed Dialling Numbers

If you have received a PIN2 code from your service provider, you can use a list of Fixed Dialling Numbers (FDN) to restrict outgoing calls.

To enable or disable fixed dialling

- 1 From your Home screen, tap .
- 2 Find and tap **Settings** > **Call settings** > **Fixed dialling numbers**.
- 3 Tap **Activate fixed dialling** or **Deactivate fixed dialling**.
- 4 Enter your PIN2 and tap **OK**.

To access the list of accepted call recipients

- 1 From your Home screen, tap .
- 2 Find and tap **Settings** > **Call settings** > **Fixed dialling numbers** > **Fixed dialling numbers**.

Contacts

Use the Contacts application to store and manage all your contacts. Keep your phone numbers, email addresses, and other contact data in one place. Contacts shows you all communication with a particular contact. Just tap on the contact to access this information in one easy overview.





You can add new contacts in your phone and synchronise them with the contacts in your Sony Ericsson Sync account, Google™ account, Microsoft® Exchange ActiveSync® account, or other accounts that support the syncing of contacts. The Contacts application automatically tries to join new addresses with existing contacts, to create single entries. You can also manage this process manually. For more information, go to www.sonyericsson.com/support/contacts.

Opening the Contacts application for the first time

The first time you open the Contacts application, you get hints on how to start adding contacts to your phone. This is a good time to choose a method that suits your situation and setup.

Getting contacts into your phone

There are several methods to get your existing contacts and other data into your new phone:





-  Synchronise your phone with contacts already stored with an online synchronisation service, such as Sony Ericsson Sync or Google Sync™.
-  Import contacts from a SIM card. You may not be able to transfer all information from one phone to another using this method because of limited memory on the SIM card.
-  Import contacts from a memory card.
-  Use a Bluetooth™ connection.
-  Send contacts via messaging services such as SMS, MMS or email.

! The online synchronisation method works best for most users. This way, you always have a backup online.





To view your contacts

- From your Home screen, tap , then tap . Your contacts are listed here.



To synchronise your phone contacts with a synchronisation account

- 1 From your Home screen, tap , then tap .
- 2 Press , then tap **Settings > Accounts & sync**.
- 3 To set up a synchronisation account, tap **Add account** and follow the on-screen instructions. If you have already set up a synchronisation account and you want to sync with that account, tap the account, press , and tap **Sync now**.

To import contacts from a SIM card

- 1 From your Home screen, tap , then tap .
- 2 Press , then tap **Import contacts > SIM card**.
- 3 If you have set up a synchronisation account, you can choose to add the SIM card contacts under that account. Or you can choose to only use these contacts in the phone. Select your desired option.
- 4 To import an individual contact, find and tap the contact. To import all contacts, press , then tap **Import all**.

To import contacts from a memory card

- 1 From your Home screen, tap , then tap .
- 2 Press , then tap **Import contacts** > **Memory card**.
- 3 If you have set up a synchronisation account, you can add the imported memory card contacts under that account. Or you can choose to only use the imported contacts in the phone. Select your desired option.
- 4 If you have more than one vCard file on the SD card, a list appears showing different batches of phone contacts, with the corresponding dates for when they were created. Select the batch you want to import.

To receive contact data sent using Bluetooth™ technology

- 1 Make sure you have the Bluetooth™ function turned on and your phone set to visible. If not, then you cannot receive data from other devices.
- 2 When you are asked to confirm whether you want to receive the file, tap **Accept**.
- 3 Drag down the Notification panel and tap the file you received to import the contact data.

To receive contacts sent using a messaging service

- 1 When you receive a new text message, multimedia message, or email message, open the message.
- 2 The received contact data appears as a vCard attachment. Tap, or touch and hold the vCard file to open a menu so you can save the contact data.

Contacts screen overview

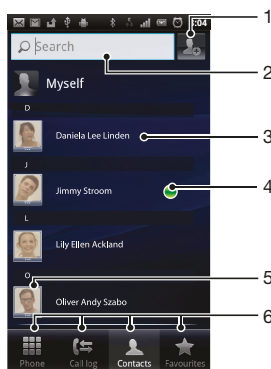



- | | |
|---|---|
| 1 | Tap this icon to create a contact |
| 2 | Contact search field |
| 3 | Tap a contact to view its details |
| 4 | Icon shows the contact's status on instant messaging services |
| 5 | Tap a contact thumbnail to access the quick contact menu |
| 6 | Shortcut tabs |

Managing your contacts





Create, edit and synchronise your contacts in a few simple steps. Select to display only the contacts you want to use in the phone. If you synchronise your contacts with more than one account, you can join contacts in your phone to avoid duplicates.

- ! Some synchronisation services, for example some social networking services, do not allow you to edit contact details.



To select which contacts to display in the Contacts application

- 1 From your Home screen, tap , then tap .
- 2 Press , then tap **Filter**.
- 3 In the list that appears, mark and unmark the desired options. If you have synchronised your contacts with a synchronisation account, that account appears in the list. You can tap the account to further expand the list of options. When you are finished, tap **OK**.





To add a contact

- 1 From your Home screen, tap , then tap .
 - 2 Tap .
 - 3 If you have synchronised your contacts with one or more accounts, select the account to which you want to add this contact, or tap **Phone contact** if you only want to use this contact in your phone.
 - 4 Enter or select the desired information for the contact.
 - 5 When you are finished, tap **Done**.
-  If you add a plus sign and the country code before a contact phone number, you can use the number when you make calls from other countries.



To edit a contact

- 1 From the Home screen, tap , then tap .
- 2 Touch and hold the contact you want to edit, then tap **Edit contact**.
- 3 Edit the desired information. When you are finished, tap **Done**.



To associate a picture with a contact

- 1 From your Home screen, tap , then tap .
 - 2 Touch and hold the contact you want to edit, then tap **Edit contact**.
 - 3 Tap  and select the desired method for adding the contact picture.
 - 4 When you have added the picture, tap **Done**.
-  You can also add a picture to a contact directly from the **Gallery** application.



To view your communication with a contact

- 1 From the Home screen, tap , then tap .
- 2 Tap the contact you want to view.
- 3 To view your communication with the contact for different media, tap or flick through the filter items at the bottom of the screen.

To delete contacts

- 1 From your Home screen, tap , then tap .
- 2 Press , then tap **Delete contacts**.
- 3 Mark the contacts you want to delete, or tap **Mark all** if you want to delete all contacts.
- 4 Tap **Delete > OK**.



To edit contact information about yourself

- 1 From your Home screen, tap , then tap .
- 2 Touch and hold **Myself** at the top of the contact list, then tap **Edit contact**.
- 3 Enter the new information or make the changes you want.
- 4 When you are done, tap **Done**.



Avoiding duplicate entries in the Contacts application

If you synchronise your contacts with a new account or import contact information in other ways, you could end up with duplicate entries in the Contacts application. If this happens, you can join such duplicates to create a single entry. And if you join entries by mistake, you can separate them again later.

To join contacts

- 1 From your Home screen, tap , then tap .
- 2 Touch and hold the contact you want to join with another contact, then tap **Join contacts**.
- 3 From the list that appears, tap the contact whose information you want to join with the first contact, then tap **OK** to confirm. The information from the first contact is merged with the second contact, and the first contact is no longer displayed in the Contacts list.



To separate joined contacts

- 1 From your Home screen, tap , then tap .
- 2 Touch and hold the joined contact you want to edit, then tap **Edit contact**.
- 3 Press , then tap **Separate**.
- 4 Tap **OK**.

Favourites



You can mark a contact as a favourite. The **Favourite** tab gives you quick access to your marked contacts. In **Favourite**, you can also find a list of the contacts you communicate with most frequently.

To mark or unmark a contact as a favourite

- 1 From the Home screen, tap , then tap .
- 2 Tap the contact you want to add to or remove from your favourites.
- 3 Tap .

Communicating with your contacts

To search for a contact

- 1 From your Home screen, tap , then tap .
- 2 Enter the first few letters of the contact name in the **Search** field. All contacts beginning with those letters appear.



The quick contact menu

Tap a contact's thumbnail to view quick communication options for a particular contact. Options include calling the contact, sending a text or multimedia message, and starting a chat using the Google Talk™ application.



- ! For an application to appear as an option in the quick contact menu, you may need to set up the application in your phone and be logged in to the application. For example, you need to start the Gmail™ application and enter your login details before you can use Gmail™ from the quick contact menu.

Sharing your contacts



To send your business card

- 1 From your Home screen, tap , then tap .
- 2 Tap **Myself**.
- 3 Press , then tap **Send contact > OK**.
- 4 Select an available transfer method and follow the on-screen instructions.

To send a contact

- 1 From your Home screen, tap , then tap .
- 2 Tap the contact whose details you want to send.
- 3 Press , then tap **Send contact > OK**.
- 4 Select an available transfer method and follow the on-screen instructions.



To send several contacts at once

- 1 From your Home screen, tap , then tap .
- 2 Press , then tap **Send contacts**.
- 3 Mark the contacts you want to send, or select all if you want to send all contacts.
- 4 Tap **Send**, then tap **OK** to confirm.
- 5 Select an available transfer method and follow the on-screen instructions.



Backing up contacts

You can use a memory card, a SIM card or an online synchronisation tool such as Microsoft® Exchange ActiveSync® to back up contacts.

To export all contacts to the memory card

- 1 From your Home screen, tap , then tap .
- 2 Press , then tap **Back up contacts** > **Memory card**.
- 3 Tap **OK**.

To export contacts to a SIM card

- 1 From your Home screen, tap , then tap .
- 2 Press , then tap **Back up contacts** > **SIM card**.
- 3 Mark the contacts you want to export, or tap **Mark all** if you want to export all your contacts.
- 4 Tap **Back up**.
- 5 Select **Add contacts** if you want to add the contacts to existing contacts on your SIM card, or select **Replace all contacts** if you want to replace the existing contacts on your SIM card.

- ! When you export contacts to a SIM card, not all information may get exported. This is due to memory limitations on SIM cards.





Messaging

Using text and multimedia messaging



You can send and receive text messages from your phone using SMS (Short Message Service). If your subscription includes MMS (Multimedia Messaging Service), you can also send and receive messages that contain media files, for example, pictures and videos. A single text message may contain up to 160 characters. If you exceed 160 characters, then all your single messages are linked and sent together. You are charged for each 160-character message sent. When you view your messages, they appear as conversations, which means that all messages to and from a particular person are grouped together.

- ! To send multimedia messages, you need the correct MMS settings in your phone. See *Internet and messaging settings* on page 32.

To create and send a message

- 1 From your Home screen, tap , then find and tap .
 - 2 Tap **New message**.
 - 3 Tap **Write message** and enter your message text.
 - 4 To add a recipient, tap **Add recipient**, then select a contact or enter the full number manually.
 - 5 If you want to add a media file, tap  and select an option.
 - 6 If you want to add or remove recipients before sending the message, press . To add a recipient, tap **Add recipient**. To remove a recipient, tap **Edit recipients** and tap  next to a recipient field. When you are finished, tap **Done**.
 - 7 To send the message, tap **Send**.
- 💡 If you exit a message before sending, it gets saved as a draft. The conversation gets tagged with the word **Draft**.

To read a received message

- 1 From your Home screen, tap , then find and tap .
 - 2 Tap the desired conversation.
 - 3 If the message is not yet downloaded, tap and hold the message, then tap **Download message**.
- 💡 When you receive a text or multimedia message,  appears in the status bar. To read the message, you can also drag the status bar downwards and tap the received message when the status bar is open.

To reply to a message

- 1 From your Home screen, tap , then tap **Messaging**.
- 2 Tap the desired conversation.
- 3 Enter your reply and tap **Send**.



To forward a message

- 1 From your Home screen, tap , then tap **Messaging**.
- 2 Tap the desired conversation.
- 3 Touch and hold the message you want to forward, then tap **Forward message**.
- 4 Select a recipient from the list, or tap **Add recipient** to add a recipient who is not in the list.
- 5 Edit the message and tap **Send**.



To delete a message

- 1 From your Home screen, tap , then tap **Messaging**.
- 2 Tap the desired conversation.
- 3 Touch and hold the message you want to delete, then tap **Delete message** > **Yes**.



To delete conversations

- 1 From your Home screen, tap , then tap **Messaging**.
- 2 Press , then tap **Delete several**.
- 3 Mark the checkboxes for the conversations you want to delete, then tap **Delete**.

To save a sender's number to a contact

- 1 From your Home screen, tap , then tap **Messaging**.
- 2 Tap a conversation.
- 3 Tap the sender's number at the top of the screen.
- 4 Tap .
- 5 Select an existing contact, or tap  if you want to create a new contact.
- 6 Edit the contact information and tap **Done**.

To call a message sender



- 1 From your Home screen, tap , then tap **Messaging**.
- 2 Tap a conversation.
- 3 Tap the recipient name or number at the top of the screen.
- 4 If the recipient is saved in your contacts, tap the phone number you want to call. If you have not saved the recipient in your contacts, tap .

To save a file contained in a message you receive



- 1 From your Home screen, tap , then tap **Messaging**.
- 2 Tap the desired conversation.
- 3 If the message has not been downloaded yet, tap and hold the message, then tap **Download message**.
- 4 Touch and hold the file you want to save, then select the desired option.

Text and multimedia message options



To change the notification settings for messages

- 1 From your Home screen, tap , then tap **Messaging**.
- 2 Press , then tap **Settings**.
- 3 If desired, tap **Notification tone** and select a notification sound.
- 4 If desired, tap **Notification vibration** and mark the checkbox to activate.

To change the delivery report settings for outgoing messages

- 1 From your Home screen, tap , then tap **Messaging**.
- 2 Press , then tap **Settings**.
- 3 Tap **Delivery report** to activate or deactivate the delivery report.
- ! When a message has been delivered to the recipient, appears in the message.

To view messages saved on the SIM card

- 1 From your Home screen, tap , then tap **Messaging**.
- 2 Press , then tap **Settings** > **SIM messages**.

Email

Use the Email application in your phone to send and receive emails through your regular email account or through your corporate account. Or you can do both. Your phone can handle several email accounts at the same time. You can set up these accounts to run through one combined inbox, or through separate inboxes. Note that emails you receive to your Gmail™ account can be accessed in the phone from both the Email and the Gmail™ applications.



- 💡 Your corporate Microsoft® Outlook® email messages have to be stored on a Microsoft® Exchange server for the functionality described above to work. See *Synchronising your corporate email, calendar and contacts* on page 67 for more information.

To set up an email account in your phone



- 1 From your Home screen, tap .
 - 2 Find and tap **Email**.
 - 3 Enter your email address and password, then tap **Next**.
 - 4 If the settings for the email account cannot be downloaded automatically, complete the setup manually.
 - 5 If you are prompted, enter a name for your email account, so that it is easily identifiable. Then tap **Done**.
- ! If you need to enter the settings manually, contact your email service provider for the correct email account settings. For corporate email, select **Exchange Active Sync** as the account type.
- 💡 You can set up more than one email account. See *To add an extra email account in your phone* on page 48.

Using email

To create and send an email message

- 1 From your Home screen, tap .
- 2 Tap **Email**.
- 3 If you are using several email accounts, tap the account you want to send the message from.
- 4 Tap **New mail**.
- 5 Tap **To** and start typing the recipient's address. Matches are displayed in a dynamic list. Tap the relevant match or continue typing the complete email address. To add more recipients, enter a comma (,) or a semi colon (;) and start typing another name. To delete a recipient, tap the  key.
- 6 Tap **Subject** and enter the email subject.
- 7 In the message area, enter your message text.
- 8 To attach a file, tap **Add attachment**. Select the type of file, then tap the file you want to attach from the list that appears.
- 9 Tap **Send**.

To receive email messages

- 1 From your Home screen, tap .
- 2 Tap **Email**.
- 3 If you are using several email accounts, tap the account that you want to check. If you want to check all your email accounts at once, tap **Combined Inbox**.
- 4 To download new messages, press , then tap **Refresh**.

- 💡 For corporate accounts set to push mode, you do not have to refresh the inbox. When push mode is enabled, your phone is updated automatically when new emails are received.



To read your email messages

- 1 From your Home screen, tap .
- 2 Find and tap **Email**.
- 3 If you are using several email accounts, tap the account you want to check. If you want to check all your email accounts at once, tap **Combined Inbox**.
- 4 In the email inbox, scroll up or down and tap the email you want to read.

To preview and read email using the preview pane

- 1 From your Home screen, tap .
- 2 Find and tap **Email**.
- 3 If you are using several email accounts, tap the account you want to check. If you want to check all your email accounts at once, tap **Combined Inbox**.
- 4 If enabled, the email preview pane appears.
- 5 Scroll up or down in the email inbox and tap the email you want to read. The email opens in the preview pane.
- 6 To view the email in fullscreen format, drag the split bar (located between the inbox and the preview pane) accordingly. In fullscreen format, use the forward and back arrows at the top of the screen to read your next or previous messages.
- 7 To return to the inbox view, drag the split bar accordingly.

To change the email preview pane settings

- 1 From your Home screen, tap , then find and tap **Email**.
- 2 If you are using several email accounts, tap the account you want to check. If you want to check all your email accounts at once, tap **Combined Inbox**.
- 3 Press , then tap **Preview pane** and select an option.

To view an email message attachment

- 1 From your Home screen, tap .
- 2 Find and tap **Email**.
- 3 Find and tap the desired message in your email inbox.
- 4 If necessary, scroll down in the email preview pane to see the attachment. Tap **Open** or **Save** next to it.

To save a sender's email address to your contacts

- 1 From your Home screen, tap .
- 2 Find and tap **Email**.
- 3 Find and tap the desired message in your email inbox.
- 4 Tap the name of the sender at the top of the screen.
- 5 Tap **OK** when you are prompted to add the name to your contacts.
- 6 Select an existing contact, or tap **Create new contact** if you want to create a new contact.
- 7 Edit the contact information and tap **Done**.

To reply to an email message

- 1 From your Home screen, tap .
- 2 Tap **Email**.
- 3 In your email inbox, touch and hold the message you want to reply to.
- 4 Tap **Reply** or **Reply all**.
- 5 Enter your reply, then tap **Send**.



To forward an email message

- 1 From your Home screen, tap .
- 2 Tap **Email**.
- 3 In your email inbox, touch and hold the message you want to forward.
- 4 Tap **Forward**.
- 5 Tap **To** and enter the recipient's address.
- 6 Enter your message, then tap **Send**.

To delete an email message





- 1 From your Home screen, tap .
- 2 Tap **Email**.
- 3 In your email inbox, touch and hold the message you want to delete, then tap **Delete**.

To change the inbox checking frequency



- 1 From your Home screen, tap .
- 2 Find and tap **Email**.
- 3 If you have set up more than one email account, tap the account you want to adjust.
- 4 Press , then tap **Account settings** > **Inbox check frequency** and select an option.

Using email accounts



To add an extra email account in your phone

- 1 From your Home screen, tap .
 - 2 Find and tap **Email**.
 - 3 Press , then tap **Accounts**.
 - 4 Press , then tap **Add account**.
 - 5 Enter the email address and password, then tap **Next**. If the settings for the email account cannot be downloaded automatically, complete the setup manually.
 - 6 If you are prompted, enter a name for your email account, so that it is easily identifiable. Then tap **Done**.
-  If you have more than one email account in your phone, you see a list of your accounts when you open the **Email** application. Just tap the name of the account you want to open.

To set an email account as your default account

- 1 From your Home screen, tap .
 - 2 Find and tap **Email**.
 - 3 Tap the account you want to use as the default account for composing and sending email.
 - 4 Press , then tap **Account settings**.
 - 5 Mark the **Default account** checkbox.
-  If you only have one email account, then this account is automatically the default account.



To remove an email account from your phone

- 1 From your Home screen, tap .
- 2 Find and tap **Email**.
- 3 If you have several email accounts in your phone, go to step 4. If you only have one email account, press , then tap **Accounts**.
- 4 Touch and hold the account you want to remove, then tap **Delete account** > **OK**.

Gmail™ and other Google™ services

If you have a Google™ account, you can use the Gmail™ application in your phone to read, write and organise email messages. After you set up your Google™ account to work in the phone, you can also chat to friends using the Google Talk™ application, synchronise your phone calendar application with your Google Calendar™, and download applications and games from Android Market™.

To set up a Google™ account in your phone

- 1 From your Home screen, tap .
 - 2 Find and tap **Settings** > **Accounts & sync** > **Add account** > **Google**.
 - 3 Follow the registration wizard to create a Google™ account, or sign in if you already have an account. Your phone is now ready to use with Gmail™, Google Talk™ and Google Calendar™.
-  You can also sign in or create a Google™ account from the setup guide the first time you start your phone. Or you can go online and create an account at www.google.com/accounts.

To open the Gmail™ application

- 1 From the Home screen, tap .
- 2 Find and tap **Gmail™**.

Google Talk™

You can use Google Talk™ instant messaging in your phone to chat with friends who also use this application.

To start Google Talk™

- 1 From your Home screen, tap .
- 2 Find and tap **Talk**.

To reply to an instant message with Talk



- 1 When someone contacts you on **Talk**,  appears in the status bar.
- 2 Drag the status bar downwards, then tap the message and begin to chat.

Sony Ericsson Timescape™

Sony Ericsson Timescape™ changes the way you interact with others by collecting all your communications into one view. Every event (such as text and multimedia messages, missed calls and web service updates) appears as a tile in a chronological flow on the screen. This way, you can see a snack-size preview of events before choosing to open and view the full content. Also, you can tap the infinite button  to view a range of content related to the item you are currently viewing in Timescape™.

- ! The services and features described in this chapter may not be supported in all countries or regions, or by all networks and/or service providers in all areas.

To start Timescape™

- 1 From your Home screen, tap .
- 2 Find and tap **Timescape™** .
- 3 The first time you start Timescape, you can tap the tile in the welcome screen to log in to your **Facebook** or **Twitter** account. If you do not want to log in, tap **Done**.

Timescape™ main view



- | | |
|---|--|
| 1 | Your status on the web services you have selected |
| 2 | Timescape™ tiles, in chronological order, with the most recent tile at the top |
| 3 | Timescape™ event filter |

Timescape™ widget

The Timescape™ widget shows the latest Timescape™ events. For quick access, the Timescape™ widget can be added on your Home screen. See *Home screen* on page 19.

Timescape™ widget view



| | |
|---|---------------------------------|
| 1 | Timescape™ tile |
| 2 | Refresh |
| 3 | Shortcut to Timescape main view |
| 4 | Tap to update your status |

 You can not preview tiles in the Timescape™ widget.

To add the Timescape™ widget to your Home screen

- 1 From your Home screen, press .
- 2 Tap **Add > Widgets**.
- 3 Tap **Timescape™ Widget**.
- 4 Select an item you want to add.

To remove the Timescape widget from your Home screen

- 1 From your Home screen, touch and hold the Timescape widget.
- 2 Drag the widget to  at the bottom of the screen.

Using Timescape™





To scroll through tiles in Timescape™

- 1 From your Home screen, tap .
- 2 Find and tap **Timescape™**.
- 3 Flick up or down to scroll through the tiles.

To preview a tile in Timescape™

- 1 From your Home screen, tap .
- 2 Find and tap **Timescape™**.
- 3 Scroll to the tile you want to preview, and then tap it.

Timescape™ event filter

| | |
|---|---------------------------------------|
|  | All events |
|  | Missed calls |
|  | Received text and multimedia messages |
|  | Updates from your Twitter™ contacts |
|  | Updates from your Facebook™ contacts |

To filter the events displayed in Timescape™



- 1 From your Home screen, tap .
- 2 Find and tap **Timescape™**.
- 3 Tap or flick through the filter icons.

To refresh the main view in Timescape™

- When the Timescape™ event filter is set to all events, press , then tap **Refresh**.



 When you refresh the main view, your phone connects to the Internet to update information from the web service accounts you have linked to Timescape™.

To log in to Facebook™ or Twitter™ from Timescape™



- 1 From your Home screen, tap .
- 2 Find and tap **Timescape™**.
- 3 Press , then tap **Settings > Set up services**.
- 4 Tap the service you want to log in to.
- 5 Enter your login details.

 When you have logged in to a web service, you can update your status or view updates from the web service in Timescape™.

To update your Facebook™ or Twitter™ status in Timescape™

- 1 From your Home screen, tap .
- 2 Find and tap **Timescape™**.
- 3 Tap  > **Update status**.
- 4 Tap the service for which you want to update your status. If you are not signed in to the service, you need to sign in before proceeding. When you have selected the desired service, tap **Continue**.
- 5 Tap the text field and enter your new status, then tap **Post**.



To log out of Facebook™ or Twitter™ from Timescape™

- 1 From your Home screen, tap .
 - 2 Find and tap **Timescape™**.
 - 3 Press , then tap **Settings > Set up services**.
 - 4 Tap the service you want to log out of.
-  Your account information gets deleted when you log out.

To view an event in Timescape™

- 1 From the Home screen, tap .
- 2 Find and tap **Timescape™**.
- 3 Scroll to and tap the tile for the desired event so it appears in preview mode. Then tap the tile again.

To call back from Timescape™ when you have a missed call

- 1 From the Home screen, tap .
- 2 Find and tap **Timescape™**.
- 3 Tap the tile representing the missed call, then tap the tile again.
- 4 Tap  to return the call.



To reply to a text or multimedia message in Timescape™

- 1 From your Home screen, tap .
- 2 Find and tap **Timescape™**.
- 3 Scroll to a text or multimedia message tile, then tap the tile.
- 4 Tap the message tile again, then edit the message and tap **Send**.

The infinite button in Timescape™



When you tap a tile, the infinite button  appears in the upper right corner. If the tile is connected to a contact, you can access related content by tapping the infinite button.

To view all communication with a contact in Timescape™



- 1 From your Home screen, tap .
- 2 Find and tap **Timescape™**.
- 3 Tap a tile for an event related to a contact.
- 4 Tap . All communication with the contact appears.
- 5 Tap or flick the filter items at the bottom of the screen to view communication with the contact through other media.

Timescape™ settings

To access Timescape™ settings

- 1 From the Home screen, tap .
- 2 Find and tap **Timescape™**.
- 3 Press , then tap **Settings**.

To schedule web service content updates in Timescape™

- 1 From your Home screen, tap .
- 2 Find and tap **Timescape™**.
- 3 Press , then tap **Settings > Update mode**.
- 4 Tap the desired option. If you select **Manual**, no automatic updates get scheduled.

Getting started with Android Market™

Open Android Market™ and enter a world of applications and games. You can browse these applications and games through different categories. You can also rate an application or game and send feedback on it.

To use Android Market™, you need to have a Google™ account. See *To set up a Google™ account in your phone* on page 49.

- ! Android Market™ may not be available in all countries or regions

To open Android Market™

- 1 From the Home screen, tap .
- 2 Find and tap **Market**.

Payment options

When you download paid applications from Android Market™, your purchase is handled through Google Checkout™. In some cases, you can download free trial versions of applications through Android Market™, but if you want to continue using the application, the download and payment of the full version must be made through the manufacturer's website.

- **Google Checkout™** – Google Checkout™ is an online payment processing service. It offers, for example, information about your purchase history and gives you protection from credit card fraud by not giving your full credit card number to the vendor. You can use your Google™ account to log in to Google Checkout™ from your phone. If you do not have a Google Checkout™ account, you can sign up for a new account from your phone. Payment can be made with a credit, debit, or gift card. Some vendors may also accept payment through your phone billing account.

- ! It may not be possible to buy applications through Android Market™ in all countries or regions.

Downloading from Android Market™

You can download all kinds of applications from Android Market™, including free applications. If you pay for an application through Google Checkout™, the application is tied to your Google™ account so that it can be installed an unlimited amount of times on any device.

Before you download applications

Before you start downloading from Android Market™, make sure that you have a working Internet connection.

Also, remember that you might incur data traffic charges when you download content to your phone. Contact your operator for more information.

To download a free application

- 1 In Android Market™, find an item you wish to download by browsing categories, or by using the search function.
- 2 Tap the item to view its details, and follow the instructions to complete the installation.
- 3 If the application you want to download requires access to your data or control of any functions on your phone, an additional screen appears with details. Read this screen carefully because the functionality of your phone may be seriously affected if you proceed. Tap **OK** if you agree, or **Cancel** if you wish to cancel the download.

To download a paid application

- 1 In Android Market™, find an item you wish to download by browsing categories, or by using the search function.
- 2 Tap the item to view its details, and follow the instructions in your phone to complete your purchase.
- 3 If the application you want to download requires access to your data or control of any functions on your phone, an additional screen appears with details. Read this screen carefully because the functionality of your phone may be seriously affected if you proceed. Tap **OK** if you agree, or **Cancel** if you wish to cancel the download.

To open a downloaded application

- 1 In Android Market™, press , then tap **My apps**.
- 2 Tap the downloaded application.

 You can also access downloaded applications from the Application screen.

Clearing your application data

You may sometimes need to clear data for an application. This might happen if, for example, the application memory becomes full, or you want to clear high scores for a game. You might also want to erase incoming email, text and multimedia messages in some applications.

To clear all cache for an application

- 1 From your Home screen, tap .
- 2 Find and tap **Settings**.
- 3 Tap **Applications > Manage applications**.
- 4 Tap the application for which you want to clear all cache.
- 5 Tap **Clear cache**.

 It is not possible to clear the cache for some applications.

To delete an installed application

- 1 From the Home screen, tap .
- 2 Find and tap **Settings**.
- 3 Tap **Applications > Manage applications**.
- 4 Tap the desired application.
- 5 Tap **Uninstall**.

 It is not possible to delete some preinstalled applications.

Permissions

Some applications need to access parts of your phone to be able to work properly. For example, a navigation application needs permissions to send and receive data traffic, and access your location. Some applications might misuse their permissions by stealing or deleting data, or reporting your location. Make sure you only install and give permissions to applications you trust.

To view permissions of an application

- 1 From the Home screen, tap .
- 2 Find and tap **Settings**.
- 3 Tap **Applications > Manage applications**.
- 4 Tap the desired application.
- 5 Scroll down to view **Permissions**.

Installing non-Android Market™ applications

Installing applications of unknown or unreliable origin can damage your phone. By default, your phone is set to block such installations. However, you can change this setting and allow installations from unknown sources.

- ! Sony Ericsson does not warrant or guarantee the performance of any third-party applications or content transferred via download or other interface to your phone. Similarly, Sony Ericsson is not responsible for any damage or reduced performance of your phone attributable to the transfer of third-party content. Only use content from reliable sources. Contact the content provider if you have any questions or concerns.

To allow the installation of non-Android Market™ applications

- 1 From the Home screen, tap .
- 2 Find and tap **Settings** > **Applications**.
- 3 Mark the **Unknown sources** checkbox.

PlayNow™ service

You can use the PlayNow™ service to download applications, games and music. The PlayNow™ service offers both free and non-free downloads.

- 💡 The PlayNow™ service is not available in all countries.

Before you download content

Before you download, make sure that you have an Internet connection. Also, you may need to have a memory card inserted in your phone to download content, such as music, ringtones and themes.

- ! When you download content to your phone, you might be charged for the amount of data transferred. Contact your operator for information about data transfer rates in your country.

To start PlayNow™

- 1 From the Home screen, tap .
- 2 Find and tap .

Downloading from the PlayNow™ service

Download a range of content from the PlayNow™ service direct to your phone. Choose from a variety of applications, games, music, ringtones and other content. Note that payment options for non-free applications may vary per country.

To download a PlayNow item to your phone

- 1 From your Home screen, tap .
- 2 Find and tap **Store**.
- 3 Find an item you want to download by browsing categories, or by using the search function.
- 4 Tap the item to view its details.
- 5 Click “Buy now!” to start the purchase process. After your purchase has been validated, you can start to download your content.

Qriocity™ Video









Rent and purchase videos that you can view not only on your phone, but also on your PC, PlayStation® Portable (PSP) and PlayStation® 3.

- ! Qriocity™ Video might not be available in all countries or regions.

To open Qriocity™

- 1 From your Home screen, tap .
- 2 Find and tap .

Qriocity™ menu overview

| | |
|---|--|
|  | View your account information |
|  | Go to the search function to search for a video |
|  | View the download status for all your items |
|  | View and change settings for your account, purchases, and downloads |
|  | Add the current video to a wish list |
|  | Delete all items in your wish list |
|  | Delete the video you're currently viewing from the wish list |
|  | Share information about the current video via a social network, email, Bluetooth or other method |
|  | View legal information |

- ! The Qriocity™ menu is dynamic, which means that all options are not always available. For example, the option to delete all items in your wish list is only available when you are viewing the list.

To open the Qriocity™ menu

- Open Qriocity™, then press .

Creating a Qriocity™ account

You need to create a Qriocity™ account if you want to buy or rent movies with this service. If you already have a PlayStation® network account, then you can use that account instead.

Exploring the Qriocity™ video selection







Browse videos by category, or enter text to search for a particular item. You can also choose to preview videos you're interested in.

Renting or buying a video

Rent or buy a video from a selection of the latest Hollywood releases, action movies, comedies and much more. When you rent a video, you have a fixed amount of time in which to view it. This varies from market to market. You can also choose to download a purchased video to most Sony™ device connected to your Qriocity™ account.

Qriocity™ notifications overview

When you buy or rent videos, the following notifications may appear:





| | |
|---|--|
|  | Downloading of video is completed |
|  | Downloading has failed. You need to check that, for example, your phone is connected to a Wi-Fi® network, and that you have enough free space on your memory card. |
|  | Downloading of video is ongoing |
|  | Downloading is paused |
|  | Confirmation of successful purchase |
|  | Rental countdown period has started |

Watching a video from Qriocity™

You can watch your rented or purchased video on most Sony™ device connected to your Qriocity™ account.

Qriocity™ video menu overview

When you watch a video, you can open a menu to get the following options:

| | |
|--|---|
|  | Delete the current video |
|  | View information about the current video |
|  | Change the language of subtitles, or remove subtitles |
|  | Change the audio language |

Getting organised



Calendar

Your phone has a calendar for managing your time schedule. If you have a Sony Ericsson account or a Google™ account, you can also synchronise your phone calendar with your web calendar. See *Synchronising* on page 66.



To set the calendar view



- 1 From your Home screen, tap , then find and tap **Calendar**.
- 2 Press  and select an option.

To view multiple calendars

- 1 From your Home screen, tap , then find and tap **Calendar**.
- 2 Press , then tap **More > My calendars**.
- 3 Tap to select the calendars you want to view.

To create a calendar event



- 1 From your Home screen, tap , then tap **Calendar**.
- 2 Press , then tap **New event**.
- 3 Enter the name, time, location and description for the event.
- 4 If desired, select another option under **Repetition**.
- 5 Select a reminder for the event. To add a new reminder for the event, tap .
- 6 Tap **Save**.

-  When the appointment time approaches, your phone plays a short sound to remind you. Also,  appears in the status bar.

To view a calendar event

- 1 From your Home screen, tap , then tap **Calendar**.
- 2 Tap the event you want to view.

To change the calendar settings

- 1 From your Home screen, tap , then tap **Calendar**.
- 2 Press , then tap **More > Settings**.
- 3 Tap to open the setting you want to change, and edit as desired.

Alarm clock

Use your phone as an alarm clock and select any sound in your phone as your alarm signal. The alarm does not sound if your phone is turned off. But it does sound when your phone is set to silent mode.

To open the alarm clock

- 1 From your Home screen, tap .
- 2 Find and tap **Alarms**.

-  You can also open the alarm clock by tapping the analog clock after adding it as widget to your Home screen.

To set a new alarm

- 1 From your Home screen, tap .
- 2 Find and tap **Alarms**.
- 3 Tap **Add alarm**.
- 4 Adjust the time by scrolling up and down.
- 5 Tap **Set**.
- 6 If desired, edit other alarm settings.
- 7 Tap **Done**.

To edit an existing alarm

- 1 From your Home screen, tap .
- 2 Find and tap **Alarms**.
- 3 Tap the alarm you want to edit.
- 4 Tap **Time**.
- 5 Scroll up or down to adjust the time.
- 6 Tap **Set**.
- 7 If desired, edit other alarm settings.
- 8 Tap **Done**.

! The alarm time format displayed is the same as the format you select for your general time settings, for example, 12-hour or 24-hour.

To deactivate an alarm

- 1 From your Home screen, tap .
- 2 Find and tap **Alarms**.
- 3 Tap one of the marked alarms.
- 4 Unmark the **Turn alarm on** checkbox.

To activate an existing alarm

- 1 From your Home screen, tap .
- 2 Find and tap **Alarms**.
- 3 Tap one of the unmarked alarms.
- 4 Mark the **Turn alarm on** checkbox.

To delete an alarm

- 1 From your Home screen, tap .
- 2 Find and tap **Alarms**.
- 3 Tap the alarm you want to delete.
- 4 Tap **Delete**, then tap **OK**.

To set the ringtone for an alarm

- 1 From your Home screen, tap .
- 2 Find and tap **Alarms**.
- 3 Tap the alarm you want to edit.
- 4 Tap **Ringtone** and select an option.
- 5 Tap **Done**.

To set a recurring alarm

- 1 From your Home screen, tap .
- 2 Find and tap **Alarms**.
- 3 Tap the alarm you want to edit.
- 4 Tap **Repeat**.
- 5 Mark the checkboxes for the desired days, then tap **OK**.



To set the title for an alarm

- 1 From your Home screen, tap .
- 2 Find and tap **Alarms**.
- 3 Tap the alarm you want to edit.
- 4 Tap **Label** and enter a name for the alarm.
- 5 Tap **OK**.

To activate the vibrate function for an alarm

- 1 From your Home screen, tap .
- 2 Find and tap **Alarms**.
- 3 Tap the alarm you want to edit.
- 4 Mark the **Vibrate** checkbox.

To set alarms to sound when the phone is in silent mode

- 1 From your Home screen, tap .
- 2 Find and tap **Alarms**, then press .
- 3 Tap **Settings**.
- 4 Mark the **Alarm in silent mode** checkbox.

To snooze an alarm when it sounds

- When the alarm sounds, tap **Snooze**.



To turn off an alarm when it sounds

- When the alarm sounds, tap **Dismiss**.

NeoReader™ application

Use your phone as a barcode scanner to find out more about items you scan. For example, you see a coat in a magazine ad and want to find the nearest retail outlet to buy it. If the ad contains a readable barcode, the NeoReader™ application uses this code to access mobile web content, such as a web page with more product information or a map of nearby outlets. NeoReader™ supports most standard barcode types.

To start the NeoReader™ application

- 1 From the Home screen, tap .
- 2 Find and tap  NeoReader™.

To scan a bar code









- 1 In the NeoReader™ application, hold the phone camera over the bar code until the complete bar code is visible in the viewfinder.
- 2 The phone automatically scans the bar code, and vibrates when the bar code is recognised. If the bar code is not recognised, tap  to scan the code manually.
- 3 When the bar code is recognised, tap **Continue** to display the bar code information, or tap **Back** to cancel the operation.

To enter bar code numbers manually

- 1 In the NeoReader™ application, tap .
- 2 Tap the text field, then enter the bar code numbers.
- 3 Tap **OK**.

NeoReader™ application menu overview

The following menu options are available in the NeoReader™ application:

-  Click to scan the bar code manually, using a higher image resolution
-  Enter the bar code numbers manually. This option can be used if your camera has difficulty reading the bar code
-  View a list of previously scanned bar codes
-  Set your preferences:
 - Mute or enable the sound
 - Enable or disable the message confirmation function. If enabled, you will receive a confirmation message asking if you want to continue to view bar code mobile web content after a successful scan
 - Choose if you want to go back to the NeoReader™ application, or to the applications panes, after you have viewed the bar code content
 - Select how many bar codes to keep in the history list
-  View information about the NeoReader™ application
-  Read more about different bar code types, and about how to use NeoReader™
-  Select your personal settings. This information will be used to personalise the bar code content
-  Send a text message to invite a friend to download the NeoReader™ application
-  Exit the NeoReader™ application

ANT+

Your phone is equipped with ANT+, which is an interoperability function that enables the collection, automatic transfer and tracking of sensor data for monitoring of personal wellness. When you connect your phone to different fitness and sports equipment, ANT+ enables your phone to capture information from devices such as a heart rate monitor.

- 💡 An application, such as iMapMyFitness, is needed for rendering the data that an ANT+ compatible device gathers.

Synchronising

You can sync contacts, email, calendar events, and other information with your phone from multiple email accounts, synchronisation services and other kinds of accounts, depending on the applications installed on your phone. Synchronising your phone with other information sources is an easy and practical way to stay up to date.

You can:

- access your Gmail™, Google Calendar™, Google™ contacts and other Google services you use.
- access your corporate email, contacts and calendar.
- access your Facebook™ contacts, calendar, albums and other services you use.
- synchronise your phone with an Internet server using SyncML™.
- synchronise, store and manage your contacts on the Sony Ericsson website and download them to a new phone, or to several phones, using Sony Ericsson Sync.

Synchronising with Google™



Synchronise your phone with your Gmail™, Google Calendar™, Google™ contacts and data from other Google services you use. View and manage them from your phone just as easily as you would from a computer.

After synchronising, you can find Gmail™ in the Gmail™ application; Google Calendar™ in the Calendar application; Google™ contacts in the Contacts application; and other data in corresponding Google applications that you have installed.

To set up a Google™ account in your phone for synchronisation

- 1 From your Home screen, tap .
- 2 Tap **Settings > Accounts & sync**.
- 3 Make sure the **Activate auto-sync** checkbox is marked so that applications can synchronise data automatically.
- 4 Tap **Add account > Google**.
- 5 Follow the registration wizard to create a Google™ account, or sign in if you already have an account.
- 6 Tap your newly created Google™ account and then tap the items you want to synchronise.

To synchronise manually with your Google™ account

- 1 From the Home screen, tap .
- 2 Tap **Settings > Accounts & sync**.
- 3 Tap the Google™ account you want to synchronise.
- 4 Press , then tap **Sync now**.

To remove a Google™ account from your phone

- 1 From your Home screen, tap .
- 2 Tap **Settings > Accounts & sync**.
- 3 Tap the Google™ account you want to remove from the accounts list.
- 4 Tap **Remove account**.
- 5 Tap **Remove account** again to confirm.

- ! You can remove all your Google™ accounts from the accounts list, except for the first one. To remove the first account, you have to completely reset your phone. See *Resetting the phone* on page 121.

Synchronising your corporate email, calendar and contacts

Access your corporate email messages, calendar appointments and contacts directly from your phone. View and manage them just as easily as you would from a computer. After setup, you can find your information in the **Email**, **Calendar** and **Contacts** applications.

- ! For you to access the functionality described above, your corporate information must be stored on a Microsoft® Exchange server.

To set up corporate email, calendar and contacts in your phone

- 1 From your Home screen, tap .
- 2 Tap **Settings** > **Accounts & sync**.
- 3 Make sure the **Activate auto-sync** checkbox is marked so that your data will synchronise automatically according to the sync interval you set.
- 4 Tap **Add account** > **Exchange Active Sync**.
- 5 Enter your corporate email address and password.
- 6 Tap **Next**.
- 7 Follow the steps to configure your account and select the kinds of data you want to sync to the phone, such as contacts and calendar. If the settings for your corporate account are not found automatically, complete the setup manually. Contact your corporate network administrator if you need more information.
- 8 When the setup is done, enter a name for this corporate account, so that it is easily identifiable, then tap **Done**.
- 9 If prompted, activate the device administrator to allow your corporate server to control certain security features in your phone. Device administrators for your phone are typically email, calendar, or other applications to which you grant authority to implement security policies on the phone when you connect to enterprise services that require this authority.

To edit the setup of corporate email, calendar and contacts

- 1 From your Home screen, tap .
- 2 Tap **Settings** > **Accounts & sync** and select your corporate account.
- 3 Tap **Account settings**.
- 4 Change the settings to suit your needs. For example, you can decide:
 - how often the phone should check for new email messages.
 - to get your corporate calendar and contacts in your phone.
 - server settings in **Incoming settings**.

To set a synchronisation interval for a corporate account

- 1 From your Home screen, tap .
- 2 Tap **Settings** > **Accounts & sync** and select your corporate account.
- 3 Tap **Account settings**.
- 4 Tap **Inbox check frequency** and select an interval option.

To remove a corporate account from your phone

- 1 From your Home screen, tap .
- 2 Tap **Settings** > **Accounts & sync**, then tap your corporate account.
- 3 Tap **Remove account**.
- 4 Tap **Remove account** again to confirm.

Synchronising with Facebook™

Synchronise your Facebook™ contacts, calendar, albums with Gallery and data from other services you use. View and manage them from your phone just as easily as you would from a computer. When you set up a Facebook account to work in your phone, a Sony Ericsson Facebook Integration account is automatically created. You can use this Sony Ericsson Facebook Integration account to synchronise your contacts, calendar and albums.

To set up a Facebook™ account in your phone

- 1 From your Home screen, tap .
- 2 Tap **Settings > Accounts & sync**.
- 3 Make sure the **Activate auto-sync** checkbox is marked so that applications can synchronise data automatically..
- 4 Tap **Add account > Facebook**.
- 5 Follow the registration wizard to create a Facebook™ account, or sign in if you already have a Facebook account.
- 6 Select a synchronisation option for your account, then tap **Finish**. The Facebook account is now set up to work on your phone. A Sony Ericsson Facebook integration account is also created.

To synchronise manually with your Facebook™ account

- 1 From your Home screen, tap .
- 2 Tap **Settings > Accounts & sync**.
- 3 Tap the Facebook™ account or the Sony Ericsson Facebook Integration account.
- 4 Press , then tap **Sync now**.

To remove a Facebook™ account from your phone

- 1 From your Home screen, tap .
- 2 Tap **Settings > Accounts & sync**.
- 3 Tap the Facebook™ account.
- 4 Tap **Remove account**.
- 5 Tap **Remove account** again to confirm. The Facebook account and the Sony Ericsson Facebook Integration account are now removed. When you remove a Facebook account from your phone, the Facebook account is not deleted and you can still access it from a computer.

Synchronising and storing your contacts and calendar



Use Sony Ericsson Sync to synchronise your contacts with a Sony Ericsson web page at www.sonyericsson.com/user.

This way, your contacts are stored in one place and you can easily transfer them to other phones. And you always have a backup online. You need a Sony Ericsson account for this method to work.

To set up a Sony Ericsson account in your phone

- 1 From your Home screen, tap .
- 2 Tap **Settings > Accounts & sync**.
- 3 Make sure the **Activate auto-sync** checkbox is marked so that data is synchronised automatically according to the interval you set.
- 4 Tap **Add account > Sony Ericsson Sync**.
- 5 Log in if you already have a Sony Ericsson account, or sign up and follow the registration wizard to create one.
- 6 Tap **Sync interval** and select how often you want the phone to synchronise automatically.
- 7 Tap **Done**.

To synchronise manually using Sony Ericsson Sync

- 1 From your Home screen, tap .
- 2 Tap **Settings > Accounts & sync**, then tap your Sony Ericsson account.
- 3 Press , then tap **Sync now**.

To edit your Sony Ericsson account

- 1 From your Home screen, tap .
- 2 Tap **Settings > Accounts & sync**, then tap your Sony Ericsson account.
- 3 Mark or unmark the checkboxes for the items you want to synchronise.
- 4 If you need to change your account settings, tap **Account settings**, edit the desired information and tap **Done**.

To set a synchronisation interval

- 1 From your Home screen, tap .
- 2 Tap **Settings > Accounts & sync**, then tap your Sony Ericsson account.
- 3 Tap **Account settings**.
- 4 Tap **Sync interval** and select an interval option.

To remove a Sony Ericsson account from your phone

- 1 From your Home screen, tap .
- 2 Tap **Settings > Accounts & sync**, then tap your Sony Ericsson account.
- 3 Tap **Remove account**.
- 4 Tap **Remove account** again to confirm.

- ! The account is removed from your phone, but it still exists on the Sony Ericsson server. You can use your account details to log in to the Sony Ericsson website at www.sonyericsson.com/user.

Synchronising using SyncML™



Synchronise your phone with an Internet server using SyncML™. View and manage contacts, calendar and bookmarks from your phone just as easily as you would from a computer.

To set up a SyncML™ account in your phone

- 1 From your Home screen, tap .
- 2 Find and tap **Settings > Accounts & sync**.
- 3 Make sure the **Activate auto-sync** checkbox is marked so that your data will synchronise automatically according to the interval you set.
- 4 Tap **Add account > SyncML**.
- 5 Tap the account, server address, user name and password fields, and enter the information required.
- 6 Tap **Sync interval** and select how often you want the phone to synchronise automatically.
- 7 Tap an item that you want to synchronise, for example, Contacts. Then enter the server address, user name, and password. Repeat this step for each item you want to synchronise.
- 8 When you're finished, tap **Done**.

- ! Contact your SyncML™ service provider for more information about your account settings.

To synchronise manually with your SyncML™ account

- 1 From your Home screen, tap .
- 2 Tap **Settings > Accounts & sync**.
- 3 Tap the SyncML™ account that you want to synchronise.
- 4 Press , then tap **Sync now**.

To set a synchronisation interval

- 1 From your Home screen, tap .
- 2 Tap **Settings > Accounts & sync**, then tap your SyncML™ account.
- 3 Tap **Account settings**.
- 4 Tap **Sync interval** and select an interval option.

To remove a SyncML™ account from your phone

- 1 From your Home screen, tap .
- 2 Tap **Settings > Accounts & sync**, then tap your SyncML™ account.
- 3 Tap **Remove account**.
- 4 Tap **Remove account** again to confirm.

Connecting to wireless networks

You can access the Internet wirelessly from your phone using Wi-Fi® technology. This way you can browse the web and access cheaper call and data rates.

If your company or organisation has a virtual private network (VPN), you can connect to this network with your phone. You can use a VPN to access intranets and other internal services at your company.

Wi-Fi®

Using Wi-Fi® technology you can access the Internet wirelessly with your phone. To access the Internet using a Wi-Fi® connection, you first need to search for and connect to an available Wi-Fi® network. The signal strength of the Wi-Fi® network may differ depending on your phone's location. Moving closer to the Wi-Fi® access point may increase the signal strength.

Before using Wi-Fi®



To browse the Internet using a Wi-Fi® connection, you need to search for and connect to an available Wi-Fi® network and then open the Internet browser. The signal strength of the Wi-Fi® network may differ depending on your phone's location. Move closer to the Wi-Fi® access point to increase the signal strength.

To turn on Wi-Fi®

- 1 From the Home screen, tap .
- 2 Find and tap **Settings** > **Wireless & networks**.
- 3 Mark the **Wi-Fi** checkbox. The phone scans for available Wi-Fi® networks.

! It may take a few seconds before Wi-Fi® is enabled.

To connect to a Wi-Fi® network

- 1 From the Home screen, tap .
- 2 Find and tap **Settings** > **Wireless & networks** > **Wi-Fi settings**.
- 3 Available Wi-Fi® networks are displayed under **Wi-Fi networks**. The available networks may be open or secured. Open networks are indicated by  and secured networks are indicated by  next to the Wi-Fi® network name.
- 4 Tap a Wi-Fi® network to connect to it. If you are trying to connect to a secure Wi-Fi® network, you are asked to enter a password.  is displayed in the status bar once you are connected.

! Your phone remembers Wi-Fi® networks you connect to. The next time you come within reach of a previously connected Wi-Fi® network, your phone automatically connects to it.

💡 In some locations, open Wi-Fi® networks require you to log in to a web page before you can get access to the network. Contact the relevant Wi-Fi® network administrator for more information.

To connect to another Wi-Fi® network

- 1 From the Home screen, tap .
- 2 Find and tap **Settings** > **Wireless & networks** > **Wi-Fi settings**. Detected Wi-Fi® networks are displayed in the **Wi-Fi networks** section.
- 3 Tap another Wi-Fi® network to connect to it.



Wi-Fi® network status

When you are connected to a Wi-Fi® network or when there are Wi-Fi® networks available in your vicinity, it is possible to see the status of these Wi-Fi® networks. You can also enable the phone to notify you whenever an open Wi-Fi® network is detected.

To enable Wi-Fi® network notifications

- 1 Turn on Wi-Fi®, if it is not already on.
- 2 From your Home screen, tap .
- 3 Find and tap **Settings** > **Wireless & networks** > **Wi-Fi settings**.
- 4 Mark the **Network notification** checkbox.

To scan for Wi-Fi® networks manually

- 1 From your Home screen, tap .
- 2 Find and tap **Settings** > **Wireless & networks** > **Wi-Fi settings**.
- 3 Press .
- 4 Tap **Scan**. The phone scans for Wi-Fi® networks and displays available networks in a list.
- 5 Tap a Wi-Fi® network in the list to connect to it.

Advanced Wi-Fi® settings

Before you add a Wi-Fi® network manually, you need to turn on the Wi-Fi® setting in your phone.

To add a Wi-Fi® network manually

- 1 From the Home screen, tap .
 - 2 Find and tap **Settings** > **Wireless & networks** > **Wi-Fi settings**.
 - 3 Tap **Add Wi-Fi network**.
 - 4 Enter the **Network SSID** for the network.
 - 5 Tap the **Security** field to select a security type.
 - 6 If required, enter a password.
 - 7 Tap **Save**.
- ! Contact your Wi-Fi® network administrator to get the **Network SSID** name and **Wireless password**.

To view detailed information about a connected Wi-Fi® network



- 1 From the Home screen, tap .
- 2 Find and tap **Settings** > **Wireless & networks** > **Wi-Fi settings**.
- 3 Tap the Wi-Fi® network that you are currently connected to. Detailed network information is displayed.

Wi-Fi® sleep policy

By adding a Wi-Fi® sleep policy, you can specify when to switch from Wi-Fi to mobile data.

- ! If you are not connected to a Wi-Fi® network, the phone uses mobile data connection to access the Internet (if you have set up and enabled a mobile data connection in your phone).





To add a Wi-Fi® sleep policy

- 1 From the Home screen, tap .
- 2 Find and tap **Settings** > **Wireless & networks** > **Wi-Fi settings**.
- 3 Press .
- 4 Tap **Advanced** .
- 5 Tap **Wi-Fi sleep policy**.
- 6 Select a **Wi-Fi sleep policy** to use.

Using a static IP address

You can set up the phone to connect to a Wi-Fi® network using a static IP address.





To set up a static IP address

- 1 From the Home screen, tap .
- 2 Find and tap **Settings** > **Wireless & networks** > **Wi-Fi settings**.
- 3 Press .
- 4 Tap **Advanced** .
- 5 Mark the **Use static IP** checkbox.
- 6 Tap and enter the information needed for your Wi-Fi® network:
 - **IP address**
 - **Gateway**
 - **Netmask**
 - **DNS 1**
 - **DNS 2**
- 7 Press  and tap **Save** .

Connected devices

Share media files in your phone with other devices over a shared Wi-Fi® connection. When your phone is connected to your home network via Wi-Fi® and has the **Connected devices** function turned on, other client devices connected to the same home network can access media files saved on your phone. For example, you can view photos or play a music track on a connected client device. A connected client device can be, for example, a computer with client software, a camera, TV, or a PlayStation®3. All devices must be DLNA™ (Digital Living Network Alliance) certified.

To use the Connected devices function

- 1 Connect your phone to a Wi-Fi® network.
- 2 From your Home screen, tap , then find and tap **Connected devices**.
- 3 Tap  beside **Change server name** and edit your phone name if needed. This name will later appear on other client device(s) connected to the Wi-Fi network, to identify your phone.
- 4 Mark the **Share contents** checkbox.  appears in the status bar. Your phone can now work as a media server.
- 5 Connect your computer or other client devices to the same Wi-Fi® network.
- 6 Activate client software installed on your computer. Find and select your phone as the server.
- 7 A notification appears in the status bar of the phone. Tap it and set access permissions.
- 8 Transfer to and show your phone content on client devices. It may take a couple of minutes to show all the content on the client devices if many photo or music files are saved on the phone.
- 9 To close the **Connected devices** view, press . The **Connected devices** function stays running in the background.
- 10 To disconnect from the server, go to the **Connected devices** view in the phone and unmark the **Share contents** checkbox.

A client device for which you have already set access permissions is a registered client device and is displayed in the **Registered devices** list. A client device that is waiting for you to grant access permissions is displayed in the **Pending devices** list.

-  The instructions described above may differ depending on the client devices. Also refer to your client device User guide. If the device cannot connect, check that your home network is working.

To set access permissions for a pending client device

- 1 From your Home screen, tap , then find and tap **Connected devices**.
- 2 Select a client device from the **Pending devices** list.
- 3 Select an access permission level.

To change the name of a registered client device

- 1 From your Home screen, tap , then find and tap **Connected devices**.
- 2 Select a client device from the **Registered devices** list, then select **Change name**.
- 3 Enter a new name for the client device.

To change the access level of a registered client device

- 1 From the Home screen, tap , then find and tap **Connected devices**.
- 2 Select a client device from the **Registered devices** list.
- 3 Tap **Change access level** and select an option.

To get more information about sharing content

- When the **Connected devices** view is open, tap **Help** to get information about how to share content in your phone with client devices.

Sharing your phone's mobile data connection

You can share your phone's mobile data connection with a single computer using a USB cable. This process is called USB tethering. You can also share your phone's data connection with up to eight devices at once, by turning your phone into a portable Wi-Fi® hotspot.

When your phone is sharing its data connection, the following icons may appear in the status bar or in the Notification panel:



USB tethering is active



Portable Wi-Fi® hotspot is active



Both USB tethering and portable hotspot are active

To share your phone's data connection using a USB cable

- 1 Use the USB cable that came with your phone to connect your phone to a computer.
- 2 From your Home screen, tap .
- 3 Find and tap **Settings > Wireless & networks > Tethering & portable hotspot**.
- 4 Mark the **USB tethering** check box. The phone starts sharing its mobile network data connection with the computer over the USB connection. An ongoing notification appears in the status bar and the Notification panel.
- 5 Unmark the **USB tethering** checkbox, or disconnect the USB cable to stop sharing your data connection.

- ! You cannot share your phone's data connection and SD card over a USB cable at the same time. If you are using your USB connection to make your SD card available to your computer, you must first deactivate this connection before you can start sharing your phone's data connection. See *Connecting your phone to a computer* on page 105.

- 💡 You may need to prepare your computer to establish a network connection via USB cable. Go to android.com/tether for the most current information about which operating systems support USB tethering and how to configure them.

To share your phone's data connection as a portable Wi-Fi® hotspot

- 1 From the Home screen, tap .
- 2 Find and tap **Settings > Wireless & networks > Tethering & portable hotspot**.
- 3 Mark the **Portable Wi-Fi hotspot** checkbox. The phone starts broadcasting its Wi-Fi® network name (SSID). You can now connect to this network with up to 8 computers or other devices.
- 4 Unmark the **Portable Wi-Fi hotspot** checkbox when you want to stop sharing your data connection via Wi-Fi®.

To rename or secure your portable hotspot



- 1 From the Home screen, tap .
- 2 Find and tap **Settings > Wireless & networks > Tethering & portable hotspot**.
- 3 Make sure the **Portable Wi-Fi hotspot** checkbox is marked.
- 4 Tap **Portable Wi-Fi hotspot settings > Configure Wi-Fi hotspot**.
- 5 Enter the **Network SSID** for the network.
- 6 Tap the **Security** field to select a security type.
- 7 If required, enter a password.
- 8 Tap **Save**.

Virtual private networks (VPNs)

Use your phone to connect to virtual private networks (VPNs), which allow you to access resources inside a secured local network from outside the actual network. For example, VPN connections are commonly used by corporations and educational institutions for users who need to access intranets and other internal services when they are outside of the internal network, for example, when they are travelling.

VPN connections can be set up in many ways, depending on the network. Some networks may require you to transfer and install a security certificate in your phone. See *Connecting your phone to a computer* on page 105 for more information on how to transfer content to your phone. For detailed information on how to set up a connection to your virtual private network, please contact the network administrator of your company or organisation.

To add a virtual private network

- 1 From the Home screen, tap .
- 2 Find and tap **Settings** > **Wireless & networks** > **VPN settings**.
- 3 Tap **Add VPN**.
- 4 Select the type of VPN to add.
- 5 Enter your VPN settings.
- 6 Press  and tap **Save**.

To connect to a virtual private network

- 1 From the Home screen, tap .
- 2 Find and tap **Settings** > **Wireless & networks** > **VPN settings**.
- 3 In the list of available networks, tap the VPN you want to connect to.
- 4 Enter the required information.
- 5 Tap **Connect**.

To disconnect from a virtual private network

- 1 Drag the status bar downwards.
- 2 Tap the notification for the VPN connection to turn it off.

Web browser







Use your web browser to view and navigate web pages, add pages as bookmarks, and create shortcuts to your Home screen. You can open several browser windows at the same time and use the zoom function when navigating a web page.

To open the web browser

- 1 From your Home screen, tap .
- 2 Find and tap .

Toolbar

The toolbar options make browsing easy:

| | |
|---|---|
|  | Open a new browser window |
|  | Add, open or edit a bookmark. View your most visited web pages or open web pages from the browser history |
|  | View open windows |
|  | Refresh the current web page |
|  | Go forward one page in the browsing history |
|  | Open a menu to see more options |

To open the toolbar

- From the browser, press .

Browsing the web

Search and address bar

Use the search and address bar to browse the web:



- 1 View the download progress of the current web page
- 2 Enter a search word to search for a web page, or enter a web page address to load a web page
- 3 Cancel the download of the current web page

- 💡 When a page has finished downloading, you can bookmark it by tapping the bookmark icon  next to the search and address bar.

To go to a web page

- 1 In your Browser, tap the text field in the search and address bar to activate the keypad.
- 2 Enter a web address.
- 3 Tap .

To search a web page

- 1 Tap the search and address text field to activate the keypad.
- 2 Enter a search word.
- 3 Tap .

To exit the web browser

- While browsing, press .
- 💡 When you open the browser again, the browser appears exactly as it did before you exited, that is, with the same number of windows, position and zoom levels.

Navigating web pages

To select a link



- To select a link in a web page, tap the link. The selected link is highlighted in orange, and the web page is loaded when you release your finger.
- 💡 If you select a link by mistake before releasing your finger, you can deselect it by dragging your finger away until the link is no longer highlighted.

To go to the previous page while browsing

- Press .

To zoom in or out on a web page

Use one of the following methods to zoom in or out on a web page:

- Touch an area of the page with two fingers at once and pinch them together to zoom out, or spread them apart to zoom in.
- Slide your finger on the screen to reveal the zoom control. Tap the  icon to zoom in, or tap  to zoom out.
- Double-tap to zoom in on the web page, or double-tap again to zoom out.

To reload the current web page

- 1 Press .
- 2 Tap **Refresh**

To add a web page shortcut to your Home screen

- 1 When viewing a web page, press .
- 2 Tap **Bookmarks > Add**.
- 3 If desired, you can edit the name and the web address. When you're done, tap **OK**.
- 4 Tap and hold the bookmark to open a menu.
- 5 Tap **Add shortcut to Home**.



To share a link to the current web page

- 1 While browsing, press .
- 2 Tap **More > Share page**.
- 3 Select an available transfer method, and follow the on-screen instructions.

Managing bookmarks

Bookmarks let you access your favourite and frequently visited web pages quickly. Depending on your network operator, some bookmarks may be pre-installed on your phone.

To bookmark a web page

- 1 While you are viewing a web page, press .
 - 2 Tap **Bookmarks > Add**.
 - 3 If desired, you can edit the name and the web address.
 - 4 When you're done, tap **OK**.
- 💡 To bookmark a web page, you can also tap the  icon to the right of the search and address field.

To open a bookmark

- 1 When the Browser is open, press .
- 2 Tap **Bookmarks**.
- 3 Tap the bookmark you want to open.



To edit a bookmark

- 1 When the Browser is open, press .
- 2 Tap **Bookmarks**.
- 3 Touch and hold a bookmark to open a menu.
- 4 Tap **Edit bookmark**.
- 5 Edit the name and the web address, as desired.
- 6 When you're done, tap **OK**.

To delete a bookmark



- 1 When the Browser is open, press .
- 2 Tap **Bookmarks**.
- 3 Touch and hold a bookmark to open a menu.
- 4 Tap **Delete bookmark** to delete the selected bookmark.

To bookmark a previously visited web page

- 1 When the Browser is open, press .
- 2 Tap **Bookmarks**.
- 3 Tap the **History** tab, or the **Most visited** tab, to view a list of previously visited web pages.
- 4 Tap the  icon to the right of the web page you want to add as a bookmark.

Managing text and images

To find text within a web page

- 1 When you are viewing a web page, press .
- 2 Tap **More > Find on page**.
- 3 Enter your search text. Matching characters appear highlighted in green.
- 4 Tap the left or right arrow to go to the previous or next matching item.
- 5 Tap  to close the search bar.

To copy text from a web page

- 1 Locate the text you want to copy.
- 2 Press .
- 3 Tap **More > Select text**.
- 4 Place your finger at the start of the text you want to select and then drag it to the desired end point. The text you select becomes highlighted.
- 5 Tap the selected text to copy it.
- 6 To paste text into an email, text message or multimedia message, touch and hold the text field in the relevant application and tap **Paste** in the menu that appears.

To save an image

- 1 Touch and hold the desired image until a menu appears.
- 2 Tap **Save image**.

Multiple windows

Your browser can run in up to eight different windows at the same time. You can, for example, log in to your webmail in one window and read today's news in another. You can easily switch from one window to another.

To open a new browser window

- 1 When the Browser is open, press .
- 2 Tap **New window**.

To open a link in a new browser window

- 1 Touch and hold a link until a menu appears.
- 2 Tap **Open in new window**.

To switch between browser windows

- 1 When the Browser is open, press .
- 2 Tap **Windows** to see a list of all open windows.
- 3 Tap the window you want to switch to.

Downloading from the web

You can download applications and content when you browse the web using the web browser in your phone. Usually you have to touch a download link for the desired file and the download then starts automatically.

To view your downloaded files

- 1 When the Browser is open, press .
- 2 Tap **More > Downloads**.

To cancel an ongoing download

- 1 When the Browser is open, press .
- 2 Tap **More > Downloads**.
- 3 Mark the checkbox beside the downloading file you want to delete.
- 4 Tap **Cancel**.

Browser settings

To change your browser settings

- 1 When the Browser is open, press .
- 2 Tap **More > Settings**.

Auto-fitting web pages

The auto-fit option makes it easier for you to read large websites with text and images, such as news sites. For example, if you zoom in on a web page when auto-fit is enabled, the text automatically adjusts to the new screen size. If auto-fit is disabled, you might need to scroll sideways to read a full sentence.

To auto-fit web pages

- 1 When the Browser is open, press .
- 2 Tap **More > Settings > Auto-fit pages**.

Music

Get the most out of your music player. Listen to and organise music, audio books and podcasts you have transferred to your memory card from a computer, or purchased and downloaded from online stores.

- 💡 Install the Media Go™ application on your computer and transfer content to and from the memory card in your phone. Media Go™ can be downloaded from www.sonyericsson.com/support. For more information, see *Connecting your phone to a computer* on page 105.

Copying media files to your memory card









Copy all your favourite media content from computer to phone and start using your phone's entertainment features to the full. It's easy to transfer music, photos, videos and other files. Just connect your phone to a computer with a USB cable and use one of the following methods:

- Use a file manager application, for example, Windows Explorer. See *To drag and drop content between phone and computer using USB cable* on page 105
- Use the Media Go™ computer application. See *Media Go™* on page 107

See *Connecting your phone to a computer* on page 105 for more general information about connecting your phone and transferring files.

Using the music player

To play audio content

- 1 From your Home screen screen, tap . If  does not appear on your Home screen, tap  then find and tap .
- 2 Tap  to open the music library.
- 3 Tap  to browse audio by artist. Tap  to browse by album. Tap  to browse by playlist. Tap  to browse audio by track.
- 4 To browse to a track, scroll up or down.
- 5 Tap a track to play it.

Music player overview

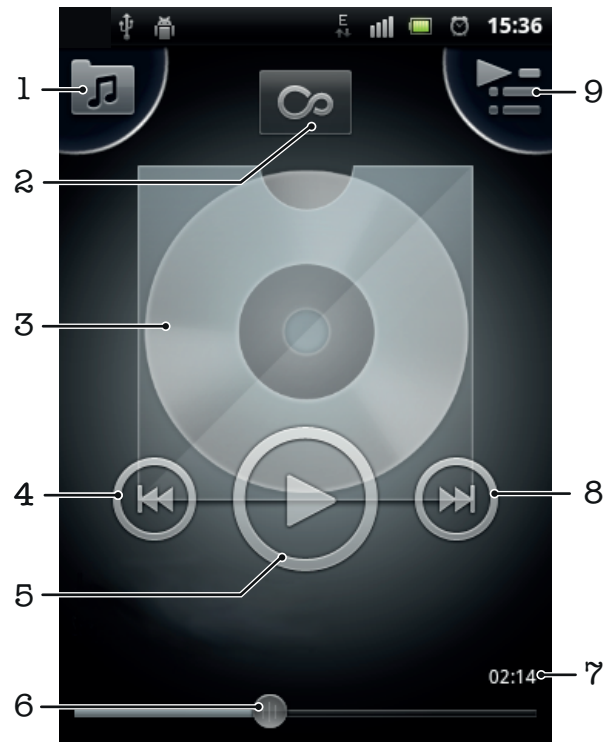

| | |
|---|---|
| 1 | Browse the music on your memory card |
| 2 | Tap the infinite button to find related information online |
| 3 | Cover art (if available) |
| 4 | Go to the previous track in the current play queue, or rewind |
| 5 | Play/Pause button |
| 6 | Progress indicator – drag or tap to fast forward and rewind |
| 7 | Elapsed time of current track |
| 8 | Go to the next track in the current play queue, or fast forward |
| 9 | View the current play queue |

To change tracks

- In the music player, tap or .

To pause a track

- In the music player, tap .

To fast forward and rewind music

- In the music player, touch and hold or .

You can also drag the progress indicator marker right or left.

To adjust the audio volume

- When the music player is playing a track, press the volume key.

To improve the sound with the equalizer

- 1 When the music player is open, press .
- 2 Tap **Equalizer**.
- 3 Select a music style.



To view a current play queue

- In the music player, tap .

To minimise the music player

- When the music player is playing, press  to go to the previous screen, or press  to go to the Home screen. The music player stays playing in the background.



To return to the music player when it is playing in the background

- 1 Drag the status bar downwards to open the Notification panel.
 - 2 Tap the track title to open the music player.
-  Alternatively, you can press and hold  and then tap  to return to the music player.

To delete a track

- 1 Open the music player library and browse to the track you want to delete.
 - 2 Touch and hold the track title, then tap **Delete**.
-  You can also delete albums this way.

To delete one or more tracks at the same time



- 1 In the music player, tap .
- 2 Press .
- 3 Tap **Delete several**.
- 4 Select one or more tracks that you want to delete.
- 5 Tap **Delete**.

To share a track

- 1 When browsing your tracks in the music player library, touch and hold a track title.
 - 2 Tap **Send**.
 - 3 Select an available transfer method, and follow the on-screen instructions.
-  You can also share albums and playlists this way.

-  You might not be able to copy, send or transfer copyright-protected items.

To share one or more tracks at the same time

- 1 When browsing your tracks in the music player library, press .
 - 2 Tap **Send several**.
 - 3 Tap one or more tracks that you want to share.
 - 4 Tap **Send**.
 - 5 Select an available transfer method, and follow the on-screen instructions.
-  You might not be able to copy, send or transfer copyright-protected items.

Music player widget

The music player widget is a miniature application that gives you direct access to the music player from your Home screen. You need to add this widget to your Home screen before you can use it.

To add the music player widget to your Home screen

- 1 From your Home screen, press .
- 2 Tap **Add > Widgets**.
- 3 Tap .

Discovering related audio content

In the music player you can discover audio content that is related to the artist you are listening to by tapping the Infinite button .





When browsing or listening to music, you can search for audio content related to a particular artist. Music player searches for and lists results from the following:

- Find music video on YouTube™
- Search artist info on Wikipedia
- Search for lyrics on Google
- Search karaoke videos on YouTube™

Playing music in random order

You can play tracks in playlists in random order. A playlist can be, for example, a playlist you have created yourself or an album.

To play tracks in random order

- 1 In the music player, tap .
- 2 Tap  and navigate to an album, or tap  and browse to a playlist.
- 3 Open the album or playlist by tapping its name.
- 4 Tap .



 You can also tap  and shuffle all tracks in the list.

Playlists



The music player automatically creates **Smart playlists** on the playlist tab  in the music player library. The music player also creates a playlist (called **Most played**) of the most played songs of each artist in your audio library. You can create your own playlists from the music on your memory card.

In addition, you can copy playlists from a computer to the memory card if you have the Media Go™ application installed on the computer. When you connect and mount your phone to the computer using a USB cable connection, your memory card appears in the Media Go™ application on the computer. For more information, see *Connecting your phone to a computer* on page 105.



To play smart playlists

- 1 In the music player, tap .
- 2 Tap .
- 3 Under **Smart playlists**, tap a playlist.
- 4 Tap a track to play it.

To play the most played songs of an artist

- 1 In the music player, tap .
- 2 Tap  and tap an artist.
- 3 Tap **Top tracks**. Up to ten tracks by the artist are displayed.
- 4 Tap a track to play it.



To create your own playlist

- 1 In the music player, tap .
- 2 To add an artist, album or a track to a playlist, touch and hold the name of the artist or the title of the album or track to open a menu.
- 3 Tap **Add to playlist >Create new playlist**.
- 4 Enter a name for the playlist and tap **OK**. You have now created a playlist and added an artist, an album or a track to that playlist. View your playlists by tapping  in the music player library.

To add tracks to a playlist

- 1 When browsing the music player library, touch and hold the name of the artist or the title of the album or track you want to add.
- 2 Tap **Add to playlist**.
- 3 Tap the name of the playlist to which you want to add the artist, album or track. The artist, album or track is added to the playlist.

To play your own playlists

- 1 In the music player, tap .
- 2 Tap .
- 3 Under **My playlists**, tap a playlist.
- 4 Tap a track to play it.

To remove a track from a playlist

- 1 In a playlist, touch and hold the title of the track you want to delete.
- 2 Tap **Delete from playlist**.

To delete a playlist



- 1 In the music player, tap , then select **Playlists**.
- 2 Touch and hold the playlist you want to delete.
- 3 Tap **Delete**.
- 4 Tap **Delete** again to confirm.

TrackID™ technology

Use the TrackID™ music recognition service to identify a music track you hear playing in your surroundings. Just record a short sample of the song and you'll get artist, title and album info within seconds. You can also purchase tracks identified by TrackID™. For best results, use TrackID™ technology in a quiet area. If you have problems using this application, see *I cannot use Internet-based services* on page 122.

- ! The TrackID™ application and the TrackID™ service are not supported in all countries/ regions, or by all networks and/or service providers in all areas.



To open the TrackID™ application

- 1 From the Home screen, tap .
- 2 Find and tap **TrackID™** .

To search for track information

- 1 When the **TrackID™** application is open, hold the phone towards the music source.
- 2 Tap **Record**. The results are shown as track info in the result screen.
- 3 To return to the **TrackID™** start screen, press .

To view charts in TrackID™

- 1 When the **TrackID™** application is open, tap the  tab. The first time you view a chart, it is set to your own region.
- 2 To see charts of the most popular searches in other regions, tap  > **Regions**.
- 3 Select a country or region.

Using TrackID™ technology results

Track information appears after a track is recognised by a TrackID™ search. You can choose to purchase the track, recommend it on Facebook™, find related content on the YouTube™ service, or get more information about the track's artist.

To buy a track using TrackID™ technology



- 1 When the **TrackID™** application is open, tap a track title.
- 2 In the track information screen, tap **Download**.
- 3 Follow the instructions in your phone to complete your purchase.

- ! The track purchase feature may not be supported in all countries/regions, or by all networks and/or service providers in all areas.

FM radio

You can browse and listen to FM radio stations, and save them as favourites. You can listen to the radio either through a portable handsfree or headphones, or through the speaker in the phone. You have to connect a portable handsfree or headphones, as they work as the antenna for the FM radio. When you open the FM radio, available channels appear automatically. If a channel has RDS information, it appears a few seconds after you start listening.

To start the FM radio

- 1 Connect a portable handsfree or a set of headphones to your phone.
 - 2 From your Home screen, tap .
 - 3 Find and tap **FM radio** . The available channels appear as you scroll through the frequency band.
- ! You have to connect a portable handsfree or headphones, which function as an antenna.

FM radio overview

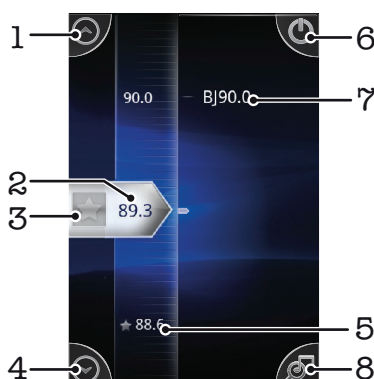

| | |
|---|--|
| 1 | Move upwards to the previous favourite (available when favourites are saved) |
| 2 | The tuned frequency |
| 3 | Save or remove a channel as a favourite |
| 4 | Move downwards to the next favourite (available when favourites are saved) |
| 5 | A saved favourite channel |
| 6 | Radio on/off key |
| 7 | RDS (Radio Data System) information – not available in all countries/regions |
| 8 | Open the TrackID™ application |

Moving between radio channels

You can move between radio channels along a frequency band by:

- Flicking up and down.
- Dragging.
- Tapping a channel or, if available, the RDS information (station identification).

Using your favourite radio channels

You can save the radio channels you most frequently listen to as favourites. By using favourites you can quickly return to a radio channel.



To save a channel as a favourite

- 1 When the radio is open, navigate to the channel that you want to save as a favourite.
- 2 Tap .

To remove a channel as a favourite

- 1 When the radio is open, navigate to the channel that you want to remove as a favourite.
- 2 Tap .

To move between favourite channels

- When the radio is open, tap  or .
- ! To move between favourites, you need to save at least two channels as favourites.

Making a new search for radio channels

If you have moved to a new location or the reception has improved in your current location, you can start a new scan for radio channels.

- ! Any favourites you have saved are not affected by a new scan.

To start a new search for radio channels

- 1 When the radio is open, press .
- 2 Tap **Search for channels**. The radio scans the whole frequency band, and all available channels are displayed.

Switching between the speaker and the handsfree

You can choose to listen to the radio either through the portable handsfree or headphones, or through the speaker in the phone.



To switch between the speaker and handsfree

- 1 When the radio is open, press .
- 2 Tap **Play in speaker**.
- 3 To play the sound through the portable handsfree or headphones again, press  and tap **Play in handsfree**.

Identifying radio tracks using TrackID™

Use TrackID™ technology to identify music tracks as they play on your phone's FM radio.

To identify a song on the FM radio using TrackID™

- 1 While the song is playing on your phone's FM radio, tap .
 - 2 A progress indicator appears while the TrackID™ application samples the song. If successful, you are presented with a track result, or a list of possible tracks.
 - 3 Press  to return the FM Radio.
- ! The TrackID™ application and the TrackID™ service are not supported in all countries/regions, or by all networks and/or service providers in all areas.

Taking photos and recording videos

Take a photo or record a video with the camera in your phone. You can hold the camera horizontally or vertically. All photos and videos are saved automatically on the memory card. Share a photo or a video with friends, or upload your photos and videos to a web service. Your camera is equipped with the highly sensitive Exmor R sensor, which enables sharp photos and videos even in low lighting conditions.

Camera controls

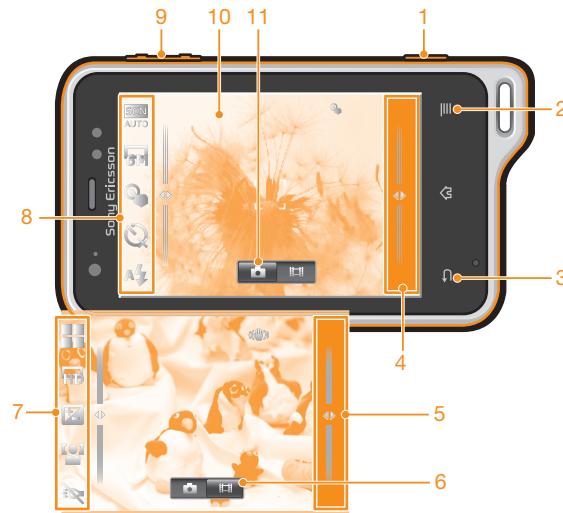

| | |
|----|---|
| 1 | Camera key. Activate the camera/Take photos/Record videos |
| 2 | Display all settings |
| 3 | Go back a step or exit the camera |
| 4 | View photos and videos (still camera) |
| 5 | View photos and videos (video camera) |
| 6 | Activate the video function |
| 7 | Settings bar (video camera) |
| 8 | Settings bar (still camera) |
| 9 | Zoom in or out |
| 10 | Main camera screen |
| 11 | Activate the still camera function |

To activate the camera



- Press and hold down the camera key.

To close the camera







- Press  from the main camera screen.

Using the still camera

To take a photo using the camera key

- 1 From your Home screen, tap , then find and tap .
- 2 If the still camera is not selected, tap .
- 3 Press the camera key halfway down to activate auto-focus.
- 4 When the focus frame or frames are green, press the camera key fully down.

To take a photo by tapping the screen

- 1 From your Home screen, tap , then find and tap .
 - 2 If the still camera is not selected, tap .
 - 3 To display all settings, press .
 - 4 Tap **Touch capture** and select **On** if it is not already selected.
 - 5 Tap a spot on the screen. The photo is taken as soon as you release your finger.
- ! Be careful not to touch ,  or other icons when tapping the screen to take a photo.

To use the zoom function

- When the camera is open, press the volume key up or down to zoom in or out.



To use the still camera flash

- 1 When the camera is open, press .
- 2 Tap **Flash**, and select your desired flash setting.
- 3 Take the photo.

To view your photos

- 1 When the camera is open, drag the thumbnail bar to the left. The thumbnail bar is located to the right on the screen.
- 2 Flick up or down to browse your photos and videos. Videos are identified by .
- 3 Tap the photo you want to view.
- 4 Flick left or right to browse other photos and videos.





To delete a photo

- 1 When the camera is open, drag the thumbnail bar to the left to display all photos and videos. The thumbnail bar is located on the right side of the screen.
- 2 Tap the photo you want to delete.
- 3 Press , and then tap .

Face detection

You can use face detection to bring an off-centre face into focus. The camera automatically detects up to five faces, indicated by white frames. A yellow frame shows which face has been selected for focus. Focus is set to the face closest to the camera. You can also tap one of the frames to select which face should be in focus.

To turn on face detection

- 1 From your Home screen, tap , then find and tap .
- 2 If the still camera is not selected, tap .
- 3 To display all settings, press .
- 4 Tap **Capturing mode > Normal**.
- 5 Tap **Focus mode > Face detection**.





To take a photo using face detection

- 1 When the camera is open and **Face detection** is set, point the camera at your subject. Up to five faces can be detected, and each detected face is framed.
- 2 Tap the frame you want to select for focus. Do not tap if you want the camera to select focus automatically.
- 3 Press the camera key halfway down. A green frame shows which face is in focus.
- 4 To take the photo, press the camera key fully down.

Smile detection

Smile detection allows you to capture a face just as it smiles. The camera detects up to five faces and selects one face for smile detection and auto focus. A green frame shows which face is selected. When the selected face smiles, the camera automatically takes a photo.

To turn on smile detection



- 1 From your Home screen, tap , then find and tap .
- 2 If the still camera is not selected, tap .
- 3 To display all settings, press .
- 4 Tap **Capturing mode** > **Smile detection**.
- 5 Tap **Smile level** and select a setting.

To take a photo using smile detection





- 1 When the camera is open and **Smile detection** is set, point the camera at your subject. Each detected face is framed (not more than five faces). The camera selects which face to focus on. A green frame shows the face in focus.
- 2 The camera automatically takes the photo when the subject in focus smiles.
- 3 If no smile is detected, press the camera key fully down to take the photo.

Adding the geographical position to your photos

Turn on geotagging to add the approximate geographical location (a geotag) to photos when you take them. The geographical location is determined either by wireless networks (mobile or Wi-Fi® networks) or GPS technology.





When  appears on the camera screen, geotagging is turned on but the geographical position has not been found. When  appears, geotagging is turned on and the geographical location is available, so your photo can get geotagged. When neither of these two symbols appears, geotagging is turned off.

To turn on geotagging



- 1 From your Home screen, tap , then find and tap .
- 2 Press , then tap **Geotagging**.
- 3 Tap **On**.
- 4 Tap **OK** to agree to enable GPS and/or wireless networks.
- 5 Check the options you want to select under **My Location**.
- 6 After you confirm your settings, press  to return to the camera screen.
- 7 Make sure your location has been found. When  appears on the camera screen, your location is available and your photo can get geotagged.

Using still camera settings

To select still camera settings

- 1 From your Home screen, tap , then find and tap .
- 2 If the still camera is not selected, tap .
- 3 To display all settings, press .
- 4 Tap the setting you want to select.

To customise the still camera settings panel

- 1 When the camera is open, press  to display all settings.
- 2 Touch and hold the setting you want to move and drag it to the desired position.
-  If you drag the setting outside of the settings panel, the change is cancelled.

Still camera settings overview

Capturing mode

Select the way you take a photo



Normal



Scene recognition

The camera determines which scene is most suitable. A scene icon and text appears when the scene is selected.



Smile detection

Capture a face just as it smiles. The camera detects up to five faces and selects one face for smile detection and auto focus. When the selected face smiles, the camera automatically takes a photo.

Focus mode

The focus function controls which part of a photo should be sharp. When continuous autofocus is on, the camera keeps adjusting focus so the area within the white focus frame stays sharp.



Single auto focus

The camera automatically focuses on the selected subject. Continuous autofocus is on. Touch and hold the camera screen, the white focus frame turns green when the focus is set. The photo is taken when you release your finger.



Multi auto focus

The focus is automatically set on several areas of the image. Touch and hold the camera screen, the white focus frame turns green when the focus is set. The photo is taken when you release your finger. Continuous autofocus is off.



Macro

Auto focus for extreme close-up photos. Continuous autofocus is on. Touch and hold the camera screen, the white focus frame turns green when the focus is set. The photo is taken when you release your finger.



Face detection

The camera automatically detects up to five human faces, indicated by frames on the camera screen. The camera automatically focuses on the nearest face. You can also select which face to focus on by tapping it on the screen. Touch and hold the camera screen, the white focus frame turns green when the focus is set. The photo is taken when you release your finger. Face detection cannot be used for all scene types. Continuous autofocus is on.



Infinity

Use when taking photos from a distance. Focus is set on subjects far away. Subjects close to the camera may be blurred. Continuous autofocus is off.



Touch focus

Touch a specific area on the camera screen to set the area of focus. Continuous autofocus is off. Touch and hold the camera screen, the white focus frame turns green when the focus is set. The photo is taken when you release your finger.

! This setting is only available in **Normal** capturing mode.

Exposure value



Determine the amount of light in the photo you want to take. A higher value indicates an increased amount of light.

! This setting is only available in **Normal** capturing mode.

Metering

This function automatically determines a well-balanced exposure by measuring the amount of light striking the image you want to capture.



Centre

Adjust the exposure to the centre of the image.



Average

Calculate the exposure based on the amount of light striking the whole image.



Spot

Adjust the exposure in a very small part of image you want to capture.

! This setting is only available in **Normal** capturing mode.

White balance

The white balance setting adjusts the colour balance according to the lighting conditions.



Auto

Adjust the colour balance automatically to the lighting conditions.



Incandescent

Adjusts the colour balance for warm lighting conditions, such as under light bulbs.



Fluorescent

Adjust the colour balance for fluorescent lighting.



Daylight

Adjust the colour balance for sunny outdoor conditions.



Cloudy

Adjust the colour balance for a cloudy sky.

! This setting is only available in **Normal** capturing mode.

Image stabiliser

When taking a photo, it can be difficult to hold the phone steady. The stabiliser helps you by compensating for small movements of the hand.



On

The image stabiliser is turned on. Captured images take longer to save when this function is on.



Off

Take a photo with the stabiliser turned off.

! This setting is only available in **Normal** capturing mode.

Scenes

Use the Scenes feature to quickly set up the camera for common situations using pre-programmed scenes. The camera determines a number of settings for you to fit the selected scene, ensuring the best possible photo.



Off

The Scenes feature is off and photos can be taken manually.



Portrait

Use for portrait photos. Settings are optimised to give slightly softer skin tones.



Landscape

Use for landscape photos. The camera focuses on distant objects. When **Landscape** is selected, focus mode is changed to **Infinity**.



Night scene

Use when taking photos at night or in poorly lit environments (without the flash). Due to long exposure time, the camera must be held still or placed on a stable surface. When **Night scene** is selected, focus mode is changed to **Infinity**.



Night portrait

Use for portrait photos at night or in poorly lit environments (with or without the flash). Due to long exposure time, the camera must be held still or placed on a stable surface.



Beach and snow

Use in bright environments to avoid underexposed photos.



Sports

Use for photos of fast-moving objects. Short exposure time minimises motion blurring.



Party

Use for indoor photos in poorly lit environments. This scene picks up indoor background lighting or candlelight. Due to long exposure time, the camera must be held still or placed on a stable surface.



Document

Use for photos of text or drawings. Gives the photo increased, sharper contrast.

! This setting is only available in **Normal** capturing mode.

Flash

Use the flash to take photos when lighting conditions are poor or when there is a backlight



Auto

The camera automatically determines if the lighting conditions require the use of a flash.



Fill flash

Use this setting when the background is brighter than the subject. This removes unwanted dark shadows.



Off

The flash is turned off. Sometimes photo quality can be better without the flash, even if lighting conditions are poor. Taking a good photo without using the flash requires a steady hand. Use the self-timer to avoid blurred photos.



Red-eye reduction

Reduces the red colour of eyes when taking a photo.

Resolution

Choose between several picture sizes and aspect ratios before taking a photo. A photo with a higher resolution requires more memory.



5MP 4:3

5 megapixel picture size with 4:3 aspect ratio. Suitable for photos you want to view on non-widescreen displays or print in high resolution.



3MP 16:9

3 megapixel picture size with 16:9 aspect ratio. A high resolution widescreen format. Has a higher resolution than full HD. Suitable for photos you want to view on widescreen displays.



2MP 4:3

2 megapixel picture size with 4:3 aspect ratio. Suitable for photos you want to view on non-widescreen displays.



2MP 16:9

2 megapixel picture size with 16:9 aspect ratio. Suitable for photos you want to view on widescreen displays.

Self-timer

With the self-timer you can take a photo without holding the phone. Use this function to take self-portraits, or group photos where everyone can be in the photo. You can also use the self-timer to avoid shaking the camera when taking photos



On (10 s.)

Set a 10-second delay from when you tap the camera screen until the photo is taken.



On (2 s.)

Set a 2-second delay from when you tap the camera screen until the photo is taken.



Off

The photo is taken as soon as you tap the camera screen.

Touch capture

Identify a particular focus area by touching the camera screen with your finger. The photo is taken as soon as you release your finger.



On

Tap an area of the screen to take a photo.



Off

You can only take a photo by pressing the camera key.

Smile level

Use the smile level function to determine what kind of smile the camera reacts to before taking a photo.



Big smile

Only take a photo when a big smile is detected.



Normal smile

Take a photo when an average smile is detected.



Faint smile

Take a photo when only a slight smile is detected.

Geotagging



Tag photos with details of where you took them



On

When geotagging is turned on, the approximate geographical location is added to photos when you take them. To use geotagging, you must enable location features from the **Settings** menu.

See *Location services* on page 108.

For geotags to be added to a photo, the location must be determined before you take the photo. Your location is determined when  appears on the camera screen. When the phone is searching for your position,  appears.



Off

When geotagging is turned off, you cannot view the location where you took a photo

Shutter sound

Select the sound that's heard when you tap the camera screen to take a photo.

Tips on using the camera

Rule of thirds

Don't place your subject in the middle of the frame. By placing it a third of the way in, you achieve a better result.

Hold it steady

Avoid blurry photos by holding the camera steady. Try to steady your hand by leaning it against a solid object.

Get closer

By getting as close as possible to your subject, you can fill the camera screen view with your subject.

Consider variety

Think about different angles, and move towards the subject. Take some vertical photos. Try different positions.

Use a plain background



A plain background helps highlight your subject.

Keep your lens clean





Mobile phones are used in all kinds of weather and places, and carried in pockets and bags. This results in the camera lens becoming dirty and covered with fingerprints. Use a soft cloth to clean the lens.

Using the video camera





To record a video using the camera key

- 1 From your Home screen, tap , then find and tap .
- 2 If the video camera is not selected, tap .
- 3 To start recording a video, press the camera key.
- 4 To stop recording, press the camera key again.

To record a video by tapping the screen



- 1 From your Home screen, tap , then find and tap .
- 2 If the video camera is not selected, tap .
- 3 To display all settings, press .
- 4 Tap **Touch capture** and select **On** if it is not already selected.
- 5 Tap the screen to start recording.
- 6 Tap the screen to stop recording.

To view your recorded videos

- 1 From your Home screen, tap , then find and tap .
- 2 Drag the thumbnail bar (on the right of the screen) to the left to view all photos and videos.
- 3 Flick up or down to browse your photos and videos. Videos are identified by .
- 4 Tap the video you want to view.
- 5 Tap  to play a video.





 When a video is paused, you can press  to view other photos and videos.

To delete a recorded video

- 1 When the camera is open, drag the thumbnail bar (on the right of the screen) to the left to display all photos and videos.
- 2 Tap the video you want to delete.
- 3 Press , and then tap .

Using video camera settings

To select video camera settings

- 1 From your Home screen, tap , then find and tap .
- 2 If the video camera is not selected, tap .
- 3 To display all settings, press .
- 4 Tap the setting you want to select.

To customise the video camera settings panel

- 1 When the video camera is open, press  to display all settings.
- 2 Touch and hold the setting you want to move and drag it to the desired position.

 If you drag the setting outside of the settings panel, the change is cancelled.

Video camera settings overview

Scenes

The Scenes feature helps you to quickly set up the camera for common situations using pre-programmed scenes. The camera determines a number of settings for you to fit the selected scene, ensuring the best possible video.



Off

The Scenes feature is off and you can shoot videos manually.



Portrait

Use for portrait videos. Settings are optimised to give slightly softer skin tones.



Landscape

Use for videos of landscapes. The camera focuses on distant objects. When **Landscape** is selected, focus mode is changed to **Infinity**.



Night mode

When turned on, light sensitivity is increased. Use in poorly lit environments. Videos of fast-moving objects may get blurred. Hold your hand steady, or use a support. Turn off night mode when lighting conditions are good, to improve the video quality.



Beach and snow

Use in bright environments to avoid underexposed videos.



Sports

Use for videos of fast-moving objects. Short exposure time minimises motion blurring.



Party

Use for indoor videos in poorly lit environments. This scene picks up indoor background lighting or candlelight. Videos of fast-moving objects may get blurred. Hold your hand steady, or use a support.

Photo light

Use the light to record videos when lighting conditions are poor or when there is a backlight



On



Off

Sometimes the video quality can be better without a light, even if lighting conditions are poor.

Focus mode

The focus setting controls which part of a photo should be sharp. When continuous autofocus is on, the camera keeps adjusting focus so that the area within the white focus frame stays sharp.



Single auto focus

The camera automatically focuses on the selected subject. Continuous autofocus is on.



Face detection

The camera automatically detects up to five human faces, indicated by frames on the screen. The camera automatically focuses on the nearest face. You can also select which face to focus on by tapping it on the screen. When you tap the camera screen, a green frame shows which face is selected and in focus. Face detection cannot be used for all scene types. Continuous autofocus is on.



Infinity

Use when recording videos from a distance. Focus is set on subjects far away. Subjects close to the camera may be blurred.

Video size

Adjust the video size for different formats



HD 720p

HD (High Definition) format with 16:9 aspect ratio. 1280x720 pixels.



Full Wide VGA

Full Wide VGA format with 16:9 aspect ratio. 864x480 pixels.



VGA

VGA format with 4:3 aspect ratio. 640x480 pixels.



QVGA

Quarter VGA format with 4:3 aspect ratio. 320x240 pixels.



Multimedia message

Record videos suitable for sending in multimedia messages. The recording time of this video format is limited to fit in a multimedia message.

Self-timer

With the self-timer you can record a video without holding the phone. Use it to record group videos where everyone can be in the video. You can also use the self-timer to avoid shaking the camera when recording videos.



On (10 s.)

Set a 10-second delay from when you tap the camera screen until the video begins to record.



On (2 s.)

Set a 2-second delay from when you tap the camera screen until the video begins to record.



Off

The video begins to record as soon as you tap the camera screen.

Exposure value



This setting allows you to determine the amount of light in the image you capture. A higher value indicates an increased amount of light.

White balance

The white balance setting adjusts the colour balance according to the lighting conditions



Auto

Adjust the colour balance automatically to the lighting conditions.



Incandescent

Adjusts the colour balance for warm lighting conditions, such as under light bulbs.



Fluorescent

Adjust the colour balance for fluorescent lighting.



Daylight

Adjust the colour balance for sunny outdoor conditions.



Cloudy

Adjust the colour balance for a cloudy sky.

Image stabiliser

When recording a video, it can be difficult to hold the phone steady. The stabiliser helps you by compensating for small movements of the hand



On

You can record a video with the stabiliser turned on.



Off

You can record a video with the stabiliser turned off.

Microphone

Select whether to pick up the surrounding sound when recording videos.



On



Off

Shutter sound



Select the sound that is heard when you tap the camera screen to record a video.

Viewing your photos and videos in Gallery

Use Gallery to view photos and play videos that you've taken with your phone camera, or to view similar content that you've downloaded or copied to the memory card. In Gallery, you can also view photos and videos you've uploaded to an online service, for example, to a Picasa™ web album or to the YouTube service. If you are a **Facebook™** user, you can view your **Facebook™** photos in Gallery.

From Gallery, you can also share your favorite photos and videos with friends, via Bluetooth™ wireless technology, email or messaging. And you can perform basic editing tasks on photos and set them as wallpaper or contact pictures. It is recommended to use the Media Go™ application to transfer content to and from the memory card in your phone. For more information, see *Connecting your phone to a computer* on page 105.

To open Gallery and view your albums

- 1 From your Home screen, tap .
 - 2 Find and tap **Gallery**. Photos and videos on your memory card, including those you've taken with the camera and those you downloaded from the web or other locations, appear in albums. If you have a Picasa™ account associated with a Google™ account that you've added to your phone, and if you have configured it to sync with Picasa™, Gallery also displays your Picasa™ web albums.
-  If the screen orientation does not change automatically when you turn the phone sideways, mark the **Auto-rotate screen** checkbox under **Settings > Display**.

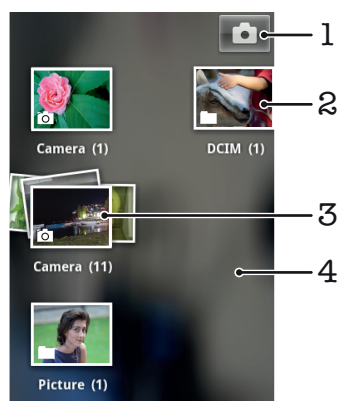

- | | |
|---|--|
| 1 | Tap to open the camera |
| 2 | An album of the photos and videos you shot using the camera |
| 3 | Peek into a stack by touching it with two fingers and spreading them apart |
| 4 | Flick left or right on the screen to view more albums |

Working with albums

Albums are groups of photos and videos in folders on your memory card or in Picasa™ web albums.

To open an album in Gallery

- 1 From your Home screen, tap .
- 2 Find and tap **Gallery**.
- 3 Tap the album you want to view. The album opens displaying its photo and video content in a chronologically ordered grid. The name of the album appears at the top of the screen.

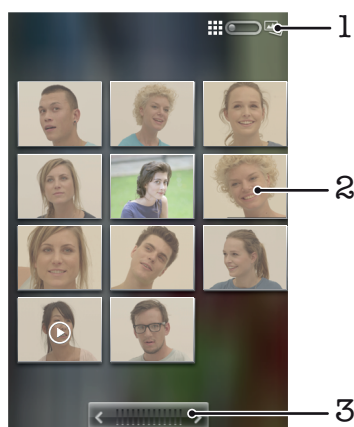



- | | |
|---|--|
| 1 | Tap to switch from grid to stack view |
| 2 | Tap a photo or video to view it |
| 3 | Tap an arrow to scroll a screen at a time. Drag left or right to scroll rapidly. |

To view photos and videos in Gallery



- 1 From your Home screen, tap .
- 2 Find and tap **Gallery**.
- 3 Tap an album.
- 4 Photos and videos are displayed in a chronologically ordered grid. Tap a photo or video to view it. Videos are indicated by .
- 5 In the photo viewer, flick left to view the next photo or video. Flick right to view the previous photo or video.

 If the screen orientation does not change automatically when you turn the phone sideways, mark the **Auto-rotate screen** checkbox under **Settings > Display**.

To view Facebook™ photos in Gallery

- 1 Make sure you are signed in to **Facebook™**.
- 2 From your Home screen, tap .
- 3 Find and tap **Gallery**.
- 4 Tap any album showing the  icon. The first time you tap a **Facebook™** album your **Facebook™** photos are copied to Gallery.
- 5 Photos are displayed in a chronologically ordered grid. Tap a photo to view it.
- 6 In the photo viewer, flick left to view the next photo or video. Flick right to view the previous photo or video.
- 7 Return to the main Gallery screen at any time by tapping  at the top left of the screen.



To change how the contents of an album are displayed in Gallery

- 1 When viewing an album in Gallery, drag the album view switch  to the right to view the contents of the album in stacks.
- 2 Drag the album view switch  to the left to view the album contents in a chronological grid.



Working with albums in Gallery

In addition to working with whole albums and with individual photos, you can select one or more photos or videos in an album to work on them in batches, for example, to send a few photos from an album to a friend.



To work with batches of photos or videos in Gallery

- 1 From your Home screen, tap .
- 2 Find and tap **Gallery**.
- 3 Open the album containing the content you want to work with.
- 4 Press  twice.
- 5 Check or uncheck the items you want to work with. You can uncheck all items you've checked by pressing  and tapping **Deselect All**.
- 6 Use the controls at the bottom of the screen to adjust the checked items. The controls available depend on the mix of items you've selected.

To share an album in Gallery

- 1 From the main Gallery screen, press  twice.
 - 2 Check the albums you want to share, then press .
 - 3 Tap **Share**.
 - 4 In the menu that opens, tap the application you want to use to share the selected albums. The application that you selected opens with the photos or videos from the selected albums or links attached to a new message.
- ! If you are sharing an album via Gmail™, do not delete the original of an attachment before the message is completely sent. Otherwise, the attachment will not be sent.

To delete an album in Gallery

- 1 From the main Gallery screen, press  twice.
- 2 Check or uncheck the albums you want to delete, then press .
- 3 Tap **Delete**. In the dialog that opens, tap **Delete**.

Working with photos

Use Gallery to view photos that you've taken with the camera, downloaded, copied to your memory card, or stored in online web albums. You can also edit the photos on your memory card and share them with friends.



To view photos in the album

- 1 From your Home screen, tap .
- 2 Find and tap **Gallery**.
- 3 Tap an album to open it, then tap a photo.
- 4 Flick left to view the next photo in the album. Flick right to view the previous photo.

To zoom a photo

- When you are viewing a photo in the photo viewer, double-tap a photo, or pinch two fingers together or spread them apart, to zoom in or out. Then drag the photo to view different parts of it.

To watch a slideshow of your photos

- 1 From your Home screen, tap .
- 2 Find and tap **Gallery**.
- 3 Tap an album to open it, then tap a photo and press .
- 4 In the toolbar at the bottom of the screen, tap **Slideshow**.
- 5 Tap a photo to end the slideshow.

To rotate a photo

- 1 When you are viewing a photo in the photo viewer, tap the photo to view the controls.
- 2 Press .
- 3 Tap **More**, then tap either **Rotate Left** or **Rotate Right**. The photo is saved in the new orientation.

To use a photo as a contact picture

- 1 When you are viewing a photo in the photo viewer, press .
- 2 In the toolbar at the bottom of the screen, tap **Set as > Contact picture**.
- 3 Select the contact you want to associate with the photo.
- 4 Crop the photo, if required.
- 5 Tap **Save**.

To use a photo as wallpaper

- 1 When you are viewing a photo in the photo viewer, press .
- 2 In the toolbar at the bottom of the screen, tap **Set as > Wallpaper**.
- 3 Crop the photo, if required.
- 4 Tap **Save**.

To crop a photo

- 1 When you are viewing a photo in the photo viewer, press .
- 2 In the toolbar at the bottom of the screen, tap **More > Crop**.
- 3 To adjust the crop frame, touch and hold the edge of the crop frame. When crop arrows appear, drag inward to or outward from the centre of the crop frame to resize it.
- 4 To resize all sides of the crop frame at the same time, touch and hold one of the four corners and then drag the frame.
- 5 To move the crop frame to another area of the photo, touch and hold inside the frame, then drag it to the desired position.
- 6 To save a copy of the photo as you cropped it, tap **Save**. The original uncropped version remains on your memory card.

To share a photo

- 1 When you are viewing a photo in the photo viewer, press  if no controls are displayed.
- 2 In the toolbar at the bottom of the screen, tap **Share**.
- 3 Select one of the available transfer methods.

To delete a photo

- 1 When you are viewing a photo in the photo viewer, press .
- 2 In the toolbar at the bottom of the screen, tap **Delete**.
- 3 In the dialog that opens, tap **Delete**.

Viewing your photos on a map

You can view on a map the location where a photo was taken. All you have to do is set your camera to add geographical location information. Show friends and family where you were, or find your way back to the location another time.

- ! To view a photo taken by the camera on a map, you must enable location detection (under location settings in the camera settings menu) before you take the photo. You must also enable location features under **Settings > Location & security**. See *Location services* on page 108 for more information.

To view your photos on a map

- 1 When you are viewing a photo in the photo viewer, press .
- 2 Tap **More > Show on map**.

Working with videos

Use Gallery to watch videos that you've taken with the camera, downloaded, or copied to your memory card. You can also share your videos with friends, or upload them to YouTube™.

To play a video



- 1 In Gallery, open an album and tap a video.
 - 2 Turn the phone to view the video in upright (portrait) or sideways (landscape) orientation.
 - 3 Tap the video to view the playback controls.
- 💡 If the screen orientation does not change automatically when you turn the phone sideways, mark the **Auto-rotate screen** checkbox under **Settings > Display**.

To pause a video

- 1 When a video is playing, tap the screen to display the controls.
- 2 Tap .

To fast forward and rewind a video



- 1 When a video is playing, tap the screen to display the controls.
- 2 Drag the progress bar marker left to rewind, or right to fast forward.

- 💡 Alternatively, you can tap  or .

To adjust the volume of a video



- Press the volume key.

To share a video

- 1 Open a Gallery album containing a video.
- 2 Press  twice.
- 3 Check the video or videos you want to share.
- 4 Press .
- 5 Tap **Share**.
- 6 In the menu that opens, tap the application you want to use to share the selected video.

- ! You might not be able to copy, send or transfer copyright-protected items. Also, some items may not send if the file size is too large.

To delete a video

- 1 Open a Gallery album containing a video.
- 2 Press  twice.
- 3 Check the video or videos you want to delete.
- 4 Press .
- 5 Tap **Delete**.
- 6 In the dialog that opens, tap **Delete**.

Bluetooth™ wireless technology

Use the Bluetooth™ function to send files to other Bluetooth™ compatible devices, or to connect to handsfree accessories. Turn on the Bluetooth™ function in your phone and create wireless connections to other Bluetooth™ compatible devices such as computers, handsfree accessories, and phones. Bluetooth™ connections work better within a 10 meter (33 foot) range, with no solid objects in between. In some cases you have to manually pair your phone with other Bluetooth™ devices. Remember to set your phone to "discoverable" if you want other Bluetooth™ devices to detect it.

! Interoperability and compatibility among Bluetooth™ devices can vary.

To turn on the Bluetooth™ function and make your phone visible

- 1 From your Home screen, tap .
- 2 Find and tap **Settings** > **Wireless & networks**.
- 3 Mark the **Bluetooth** checkbox.  appears in the status bar.
- 4 Tap **Bluetooth settings**.
- 5 Mark the **Discoverable** checkbox. The phone will now be visible to other devices for 120 seconds.

Phone name

You can give your phone a name. This name is shown to other devices after you have turned on the Bluetooth™ function and your phone is set to visible.

To give your phone a name

- 1 Make sure the Bluetooth™ function is turned on.
- 2 From your Home screen, tap .
- 3 Find and tap **Settings** > **Wireless & networks** > **Bluetooth settings** > **Device name**.
- 4 Enter a name for your phone.
- 5 Tap **OK**.

Pairing with another Bluetooth™ device

When you pair your phone with another device, you can, for example, connect your phone to a Bluetooth™ handsfree or a Bluetooth™ car kit and use these devices to make and receive calls.

Once you have paired your phone with a Bluetooth™ device the phone will remember this pairing. When pairing the phone with a Bluetooth™ device, you may need to enter a passcode. Your phone will automatically try the generic passcode 0000. If this does not work, refer to your Bluetooth™ device documentation for the device passcode. You do not need to re-enter the passcode the next time you connect to a paired Bluetooth™ device.

Some Bluetooth™ devices, for example, most Bluetooth™ headsets, require you to both pair and connect with the other device.

You can pair your phone with several Bluetooth™ devices, but you can only connect to one Bluetooth™ profile at the same time.

To pair your phone with another Bluetooth™ device

- 1 From the Home screen, tap .
 - 2 Find and tap **Settings** > **Wireless & networks** > **Bluetooth settings**.
 - 3 Tap **Scan for devices**. The Bluetooth™ devices found will be listed under **Bluetooth devices**.
 - 4 Tap the Bluetooth™ device that you want to pair with your phone.
 - 5 Enter a passcode, if required.
 - 6 The phone and the Bluetooth™ device are now paired. With some devices you also need to connect before you can start using them. The status of the pairing and connection is shown below the name of the Bluetooth™ device in the **Bluetooth devices** list.
- ! Make sure that the device you want to pair your phone with has the Bluetooth™ function activated and Bluetooth™ visibility turned on.

To connect your phone to another Bluetooth™ device

- ! Some Bluetooth™ devices, for example, most Bluetooth™ headsets, require you to first pair and then connect with other Bluetooth™ devices before a successful connection can be established.
- 1 From the Home screen, tap .
 - 2 Find and tap **Settings** > **Wireless & networks** > **Bluetooth settings**.
 - 3 In the **Bluetooth devices** list, tap the Bluetooth™ device to which you want to connect your phone.

To unpair a Bluetooth™ device

- 1 From the Home screen, tap .
- 2 Find and tap **Settings** > **Wireless & networks** > **Bluetooth settings**.
- 3 In the **Bluetooth devices** list, touch and hold the name of the paired but not connected Bluetooth™ device.
- 4 Tap **Unpair**.

Sending and receiving items using Bluetooth™ technology



Share items with other Bluetooth™ compatible devices such as phones or computers. You can send and receive several kinds of items using the Bluetooth™ function, such as:

- Photos and videos
- Music and other audio files
- Contacts
- Web pages

To send items using Bluetooth™

- 1 **Receiving device:** Make sure the Bluetooth™ device you want to send the item to has Bluetooth™ turned on and is in discoverable mode.
- 2 In your phone, open the application which contains the item you want to send and scroll to the item.
- 3 Depending on the application and the item you want to send, you may need to, for example, touch and hold the item, open the item or press . Other ways to send an item may exist.
- 4 Select a share or send menu item.
- 5 In the menu that appears, select **Bluetooth**.
- 6 Turn on Bluetooth™, if you are asked to do so.
- 7 Under **Bluetooth devices**, tap the name of the receiving device.
- 8 **Receiving device:** If asked, accept the connection.
- 9 If asked, enter the same passcode on both devices, or confirm the suggested passcode.
- 10 **Receiving device:** Accept the incoming item.

To receive items using Bluetooth™

- 1 From the Home screen, tap .
 - 2 Find and tap **Settings** > **Wireless & networks**.
 - 3 Mark the **Bluetooth** checkbox.  appears in the status bar.
 - 4 Tap **Bluetooth settings**.
 - 5 Mark the **Discoverable** checkbox. The phone will now be visible to other devices for 120 seconds.
 - 6 **Sending device:** Send one or more items to your phone using Bluetooth™.
 - 7 If asked, enter the same passcode on both devices, or confirm the suggested passcode.
 - 8 When you are notified of an incoming file to your phone, drag the status bar downwards and tap the notification to accept the file transfer.
 - 9 Tap **Accept** to start the file transfer.
 - 10 To view the progress of the transfer, drag the status bar downwards.
 - 11 To open a received item straight away, drag the status bar downwards and tap the relevant notification.
- ! Your phone must have a memory card inserted to be able to receive items using Bluetooth™ wireless technology.

Connecting your phone to a computer

Connect your phone to a computer and start transferring pictures, music and other file types. The easiest ways to connect are using a USB cable or Bluetooth wireless technology.

When you connect your phone to the computer using a USB cable, you are prompted to install the PC Companion application on your computer. PC Companion helps you access additional computer applications to transfer and organise media files, update your phone, synchronise phone content, and more.

- ! You might not be able to transfer some copyright-protected material between your phone and computer.

Transferring and handling content using a USB cable

Use a USB cable connection between a computer and your phone for easy transfer and management of your files. Once the two devices are connected, you can drag and drop content between them using the computer's file explorer. If you're transferring music, video, pictures or other media files to your phone, it's best to use the Media Go™ application on your computer. Media Go™ converts media files so that you can use them on your phone.

To drag and drop content between phone and computer using USB cable

- 1 Connect your phone to a computer using a USB cable.
- 2 **Phone: Connected in Media transf. mode** appears in the status bar.
- 3 **Computer:** Open Microsoft® Windows® Explorer from the desktop and wait until your phone's memory card appears as an external disk in Microsoft® Windows® Explorer.
- 4 **Computer:** Drag and drop the desired files between your phone and the computer.

USB connection modes

The two most common methods to share data between your phone and other devices using a USB cable are Media transfer protocol (MTP) mode and Mass storage (MSC) mode.

- **Media transfer mode (MTP)** – the most common protocol for communication with Windows computers. This mode is normally enabled by default.
- **Mass storage mode (MSC)** – the most common way to connect phones with media devices such as TVs, car kits, and Mac OS/Linux computers lacking MTP support.

To set Mass storage as the default USB connection mode

- 1 From your Home screen, tap .
- 2 Find and tap **Settings > Sony Ericsson > Connectivity > USB connection mode**.
- 3 Tap **Mass storage mode (MSC)**.
- 4 Tap **OK**.

- ! Media transfer protocol (MTP) is normally set as the default USB connection mode. When you set Mass Storage mode as the default USB connection mode, the **Auto connect in MSC** checkbox gets checked automatically. You do not need to activate it manually.

To connect your phone to a computer using Mass storage mode

- 1 Connect your phone to a computer using a USB cable.
- 2 Drag the status bar downwards.
- 3 Tap **Connect your phone > Connect phone mem. card**.

To disconnect the USB cable in Mass storage mode

- ! Do not disconnect the USB cable when transferring content as this may corrupt the content.

- 1 **Computer:** Use the *Safely Remove Hardware* feature to disable the USB cable connection.
 - 2 **Phone:** Drag the status bar downwards.
 - 3 Tap **Phone memory card connected**.
 - 4 Tap **Disconnect** in the screen that opens.
 - 5 Disconnect the USB cable from both devices.
- ! Computer instructions may vary depending on your operating system. See the documentation of your computer's operating system for more information.

Transferring files using Media transfer mode via Wi-Fi®

You can transfer files between your phone and other MTP compatible devices, such as a computer, using a Wi-Fi® connection. Before connecting, you first need to pair the two devices. If you're transferring music, video, pictures or other media files between your phone and a computer, it's best to use the Media Go™ application on the computer. Media Go™ converts media files so that you can use them on your phone.

- 💡 In order to use this feature, you need a Wi-Fi® enabled device that supports Media transfer, for example, a computer running Microsoft® Windows Vista® or Windows® 7.

To pair your phone wirelessly with a computer using Media transfer mode

- 1 Make sure Media transfer mode is enabled on your phone. It is normally enabled by default.
 - 2 Connect your phone to the computer using a USB cable.
 - 3 **Computer:** Once the phone name appears on the screen, click *Network configuration* and follow the instructions to pair the computer.
 - 4 When you are finished pairing, disconnect the USB cable from both devices.
- ! The above instructions only work if Windows® 7 is installed on your computer and the computer is connected to a Wi-Fi® Access Point via a network cable.

To connect paired devices wirelessly in Media transfer mode

- 1 Make sure Media transfer mode is enabled on your phone. It is normally enabled by default.
 - 2 From your Home screen, tap .
 - 3 Find and tap **Settings > Sony Ericsson > Connectivity**.
 - 4 Tap the paired device that you want to connect to under **Trusted devices for wireless media transf..**
 - 5 Tap **Connect**.
- ! Make sure your phone's Wi-Fi® function is turned on.

To disconnect a wirelessly paired device in Media transfer mode

- 1 From your Home screen, tap .
- 2 Find and tap **Settings > Sony Ericsson > Connectivity**.
- 3 Tap the paired device that you want to disconnect from under **Trusted devices for wireless media transf..**
- 4 Tap **Disconnect**.

To remove a pairing with another device

- 1 From your Home screen, tap .
- 2 Find and tap **Settings > Sony Ericsson > Connectivity**.
- 3 Tap the paired device that you want to remove.
- 4 Tap **Forget**.

PC Companion

PC Companion helps you to access and use additional features and services connected to your phone so that you can transfer music, video and pictures. You can also update your phone to get the latest software available.

You need a computer running one of the following operating systems to use the PC Companion application:

- Microsoft® Windows® 7
- Microsoft® Windows Vista®
- Microsoft® Windows® XP (Service Pack 3 or higher)

You need to connect your phone and computer using a USB cable to install and use PC Companion.

To install PC Companion on a computer

- 1 Connect your phone to a computer using a USB cable.
- 2 **Phone:** Tap **Install** in the PC Companion installation window.
- 3 **Computer:** PC Companion automatically starts after a few seconds. Follow the on-screen instructions to install PC Companion.

 The PC companion installer is enabled by default on your phone. You can disable this option in your phone settings.

To start PC Companion

- 1 Connect your phone to a computer using a USB cable. The message **Connected in Media transf. mode** appears on your phone.
- 2 A small pop-up window appears in the right corner of the computer screen. Follow the prompt to start PC Companion.

Media Go™

The Media Go™ computer application helps you transfer and manage media content in your phone and computer. Install the Media Go™ application from the PC Companion application. See *PC Companion* on page 107 for more information.

You need one of these operating systems to use the Media Go™ application:

- Microsoft® Windows® 7
- Microsoft® Windows Vista®
- Microsoft® Windows® XP, Service Pack 3 or higher

To be able to transfer files between Media Go™ and your phone, you must first connect your phone and computer using a USB cable. You must also enable your phone to connect to the computer. See *To drag and drop content between phone and computer using USB cable* on page 105 for more information.

 To learn more about how to use the Media Go™ application, see the help section in the main menu of the Media Go™ application.

To transfer content using the Media Go™ application

- 1 Connect your phone to a computer using a USB cable.
- 2 **Phone:** **Connected in Media transf. mode** appears in the status bar.
- 3 **Computer:** The PC Companion application launches automatically. In PC Companion, click *Media Go* to start the Media Go™ application. In some cases, you may have to wait for Media Go™ to install.
- 4 Drag and drop files between your computer and phone using the Media Go interface.

 Media Go™ can also be downloaded from www.sonyericsson.com/support.

Location services

Use your phone to find out where you are. There are two methods: GPS or wireless networks. It's best to enable the wireless networks option if you only need your approximate location, and want it fast. If you want a more exact position, and have a clear view of the sky, enable the GPS option. You can enable both options to ensure your location is found in situations where a network is weak.

- ! Sony Ericsson does not warrant the accuracy of any location services including but not limited to navigational services.

To enable GPS

- 1 From the Home screen, tap .
- 2 Tap **Settings** > **Location & security**.
- 3 Mark the **Use GPS satellites** checkbox.

To enable wireless networks

- 1 From your Home screen, tap .
- 2 Tap **Settings** > **Location & security**.
- 3 Mark the **Use wireless networks** checkbox.

Using GPS

Your phone has a global positioning system (GPS) receiver that uses satellite signals to calculate your location.

- ! When you use features that require the GPS receiver to find your location, make sure you have a clear view of the sky.

Getting the best performance

The first time you use the GPS it can take 5 to 10 minutes for your location to be found. To help the search, make sure you have a clear view of the sky. Stand still and don't cover the GPS antenna (the highlighted area in the image). The GPS signals can pass through clouds and plastic, but not through most solid objects such as buildings and mountains. If your location isn't found after a few minutes, move to another location.

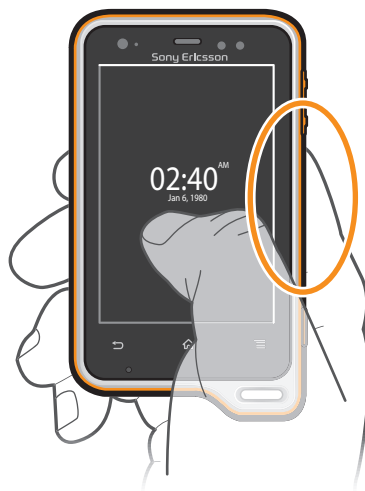

Google Maps™

Track your current location, view real-time traffic situations and receive detailed directions to your destination. Before taking trips, you can download and save maps to your memory card to avoid high roaming costs.

- ! The Google Maps™ application requires the use of an Internet connection. You may incur data connection charges when you connect to the Internet from your phone. Contact your network operator for more information. The Google Maps™ application may not be available in every market, country or region.

To use Google Maps™

- 1 From the Home screen, tap .
- 2 Find and tap **Maps**.

- ! If you want to use your location, enable at least one of the location methods available under **Settings > Location & security**.

To learn more about Google Maps™

- When you use **Maps**, press , then tap **More > Help**.

Viewing your friends' locations with Google Latitude™

Join Google Latitude™ to view your friends' locations on maps and share your location and other information with them.

Getting directions

Google Maps™ application can provide directions for travel by foot, public transportation, or car. You can add a shortcut to a destination to your Home screen, so that you can simply touch the shortcut to get directions to that location from wherever you are.

When you view a map, you make an Internet connection, and data is transferred to your phone. Before taking trips, you can download and save maps to your memory card to avoid high roaming costs.

- ! Sony Ericsson does not warrant the accuracy of any directional services.

Using the Navigation application

Get turn-by-turn instructions on how to get places. The directions are both spoken and displayed on the screen.

- ! Navigation may not be available in every market.

To start Navigation

- 1 From your Home screen, tap .
- 2 Find and tap **Navigation**.

Using the Wisepilot™ application

Get turn-by-turn voice instructions on how to get places. You can also manage your trips and share routes and locations with friends via SMS, Twitter™ or Facebook™.

- ! Wisepilot™ may not be available in every market. For more information, including a Wisepilot User manual, go to www.sonyericsson.wisepilot.com.

To start Wisepilot™

- 1 From the Home screen, tap .
- 2 Find and tap **Wisepilot**.

Locking and protecting your phone

IMEI number

Every phone has a unique IMEI (International Mobile Equipment Identity) number. You should keep a copy of this number. If your phone is stolen, your network provider can use your IMEI number to stop the phone from accessing the network in your country.

To view your IMEI number

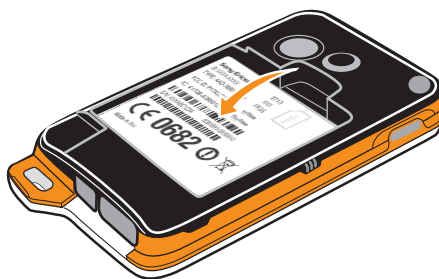

- 1 Turn off your phone, then remove the battery cover and battery.
- 2 Look for the 15- to 17-digit number on the label. The first 15 digits represent the IMEI number.

To view your IMEI number in the phone

- 1 From the Home screen, tap .
- 2 Find and tap **Settings** > **About phone** > **Status**.
- 3 Scroll to **IMEI** to view the **IMEI** number.

SIM card protection

The SIM card lock only protects your subscription. Your phone will still work with a new SIM card. If the SIM card lock is on, you have to enter a PIN (Personal Identity Number). If you enter your PIN incorrectly more times than the maximum number of attempts allowed, your SIM card will become blocked. You need to enter your PUK (Personal Unblocking Key) and then a new PIN. Your PIN, PIN2 and PUK are supplied by your network operator.

To enable the SIM card PIN lock

- 1 From the Home screen, tap .
- 2 Find and tap **Settings** > **Location & security** > **Set up SIM card lock** > **Lock SIM card**.
- 3 Enter the SIM card PIN and tap **OK**.

To change the SIM card PIN

- 1 From the Home screen, tap .
- 2 Find and tap **Settings** > **Location & security** > **Set up SIM card lock** > **Change SIM PIN**.
- 3 Enter the old SIM card PIN and tap **OK**.
- 4 Enter the new SIM card PIN and tap **OK**.
- 5 Re-type the new SIM card PIN and tap **OK**.

To change the SIM card PIN2

- 1 From the Home screen, tap .
- 2 Find and tap **Settings** > **Call settings** > **Fixed dialling numbers** > **Change PIN2**.
- 3 Enter the old SIM card PIN2 and tap **OK**.
- 4 Enter the new SIM card PIN2 and tap **OK**.
- 5 Confirm the new PIN2 and tap **OK**.

To unblock a locked SIM card

- 1 When **SIM card locked** appears, enter the PUK code and tap **OK**.
- 2 Enter a new PIN code and tap **OK**.
- 3 Reenter the new PIN code and tap **OK**.

! If you enter an incorrect PUK code too many times, the SIM card becomes blocked. If this happens, contact your service provider to get a new SIM card.

Setting a screen lock

To set a screen lock

- 1 From your Home screen, tap  > **Settings** > **Location & security** > **Set up screen lock**.
- 2 Select an option.

💡 It is very important that you remember your screen unlock pattern, PIN or password. If you forget this information, it may not be possible to restore important data such as contacts and messages. Refer to Sony Ericsson Customer support for more information.

To create a screen unlock pattern

- 1 From the Home screen, tap .
- 2 Find and tap **Settings** > **Location & security** > **Set up screen lock** > **Pattern**.
- 3 Follow the instructions in your phone. You are asked to select a security question that will be used to unlock the phone if you forget your screen unlock pattern.

To unlock the screen using a screen unlock pattern

- 1 Activate the screen.
- 2 Draw your screen unlock pattern.

! If the unlock pattern you draw on the screen is rejected five times in a row, you can select to either wait 30 seconds and then try again, or to answer the security question you have selected.

To change the screen unlock pattern

- 1 From the Home screen, tap .
- 2 Find and tap **Settings** > **Location & security** > **Change screen lock**.
- 3 Follow the instructions in your phone.

To disable the screen unlock pattern

- 1 From your Home screen, tap  > **Settings** > **Location & security** > **Change screen lock**.
- 2 Draw the screen unlock pattern.
- 3 Tap **None**.

To create a screen unlock PIN

- 1 From your Home screen, tap  > **Settings** > **Location & security** > **Set up screen lock** > **PIN**.
- 2 Enter a numeric PIN and tap **Continue**.
- 3 Confirm your PIN and tap **OK**.

To disable the screen unlock PIN

- 1 From your Home screen, tap  > **Settings** > **Location & security** > **Change screen lock**.
- 2 Enter your PIN and tap **Continue**.
- 3 Tap **None**.

To create a screen lock password

- 1 From your Home screen, tap  > **Settings** > **Location & security** > **Set up screen lock** > **Password**.
- 2 Enter a password. The password must contain at least one letter and must be at least four characters long.
- 3 Tap **Continue**.
- 4 Confirm your password and tap **OK**.

To disable the screen unlock password

- 1 From your Home screen, Tap  > **Settings** > **Location & security** > **Change screen lock**.
- 2 Enter your password and tap **Continue**.
- 3 Tap **None**.

Updating your phone

Update your phone to the most recent software version to get optimal performance and the latest enhancements. Use the Update center application to download updates directly to your phone. You can run updates automatically or manually over both 2G and 3G connections, or over a Wi-Fi® network.

You can also use the PC Companion application on a computer to run updates. Just connect your phone to the computer with a USB cable, and the PC Companion application guides you through the rest.



- ! You may incur data connection charges when you connect to the Internet with your phone. Contact your network operator for more information.
- ! Make sure you back up and save all data contained in your phone before you start updating the phone.

Updating your phone wirelessly

To download software updates manually

- 1 From your Home screen, tap .
 - 2 Find and tap **Update center**.
 - 3 Select your desired application or system update and click **Download**, or click **Update all** to download all application updates.
- ! Application updates launch automatically after download. System updates need to be installed manually after download

To activate automatic software updates

- 1 From your Home screen, tap .
 - 2 Find and tap **Update center**.
 - 3 Press , then tap **Settings**.
 - 4 Mark the **Automatic update** checkbox.
 - 5 Select whether to download updates via 3G and Wi-Fi® networks, or via Wi-Fi networks only. Application updates and system updates will be automatically downloaded.
- ! Application updates launch automatically after download. System updates need to be installed manually after download.
 - 💡 Once the **Automatic update** function is turned on, a notification appears in the status bar to inform you about application or system updates.

To install system updates

- 1 From your Home screen, tap .
- 2 Find and tap **Update center**.
- 3 Select a system update you want to install, then tap **Install**.

Updating your phone using a USB cable connection

Some updates are not available for wireless download. Notifications appear in the status bar to inform you of such updates. You need to use the PC Companion application on a computer to start this kind of software update. And you need to connect your phone to the computer with a USB cable. PC Companion can also be downloaded from www.sonyericsson.com.

To download the PC Companion application from your phone

- 1 Connect your phone to a computer using a USB cable.
- 2 When prompted, follow the instructions in the phone to launch the installation of PC Companion on the computer.

 PC Companion can also be downloaded at www.sonyericsson.com/support.

To download software updates using a USB cable connection

- 1 Make sure you have PC Companion installed on your computer.
- 2 Connect your phone to a computer using a USB cable.
- 3 **Computer:** Launch the PC Companion application. After a few moments, the phone is detected by PC Companion and PC Companion searches for new phone software.
- 4 When notifications appear in the status bar, follow the on-screen instructions to carry out the relevant software updates.

Phone settings overview

























Get to know the settings in your phone so that you can personalise them to your own requirements.

| | |
|---------------------------------|--|
| Wireless & networks | Manage your wireless connections and connection settings |
| Call settings | Configure settings for listening to and managing your voicemail, for example. |
| Sound | Configure how your phone rings, vibrates, or alerts you in other ways when you receive communications. You can also use these settings to set the volume for music or other media with audio, and some related settings. |
| Display | Select to switch orientation when you rotate your phone, or set the screen brightness |
| Location & security | Set navigation settings and protect your phone by setting up different locks and passwords |
| Applications | Manage and remove installed applications |
| Accounts & sync | Enable your applications to sync automatically and permit applications to synchronise data in the background, whether or not you are actively working in them |
| Privacy | Manage your personal information, restore your settings and other data when you install an application, and erase all of your personal data from internal phone storage |
| Storage | Check out the available space on your phone's internal storage and on the SD card. You can also erase the SD card, or unmount it for safe removal |
| Language & keyboard | Select phone language and adjust text input options |
| Voice input & output | Configure the voice input feature to enter text by speaking |
| Accessibility | Enable your installed accessibility applications and adjust related settings |
| Date & time | Set the time and date or choose to use the network-provided values. Select your preferred date and hour format |
| About phone | View information about your phone, such as model number, firmware version and battery status |

Icon overview

















Status icons

The following status icons may appear on your screen:



| | |
|---|--|
|  | Signal strength |
|  | No signal |
|  | Roaming |
|  | GPRS is available |
|  | EDGE is available |
|  | 3G is available |
|  | Sending and downloading GPRS data |
|  | Sending and downloading EDGE data |
|  | Sending and downloading 3G data |
|  | Battery status |
|  | The battery is charging |
|  | GPS is activated |
|  | Airplane mode is activated |
|  | The Bluetooth™ function is activated |
|  | Connected to another Bluetooth™ device |
|  | The SIM card is not inserted |
|  | The microphone is muted |
|  | The speakerphone is on |
|  | Silent mode |
|  | Vibrate mode |
|  | An alarm is set |
|  | Synchronisation is ongoing |
|  | Problem with sign-in or synchronisation |
|  | A Wi-Fi® connection is enabled and wireless networks are available |





Notification icons

The following notification icons may appear on your screen:

| | |
|---|--|
|  | New email message |
|  | New text message or multimedia message |
|  | New voicemail |
|  | An upcoming calendar event |
|  | A song is playing |
|  | The phone is connected to a computer via a USB cable |
|  | Warning message |
|  | Error message |
|  | Missed call |
|  | Call ongoing |
|  | Call on hold |
|  | Call forwarding on |
|  | Software updates available |
|  | Downloading data |
|  | Uploading data |
|  | More (undisplayed) notifications |

Application overview

| | | |
|---|--------------------------|--|
|  | Alarms | Set an alarm |
|  | Browser | Browse the web and download new programs and files |
|  | Calculator | Perform basic calculations |
|  | Calendar | Keep track of your appointments |
|  | Camera | Take photos and record video clips |
|  | Contacts | Keep track of your friends and colleagues |
|  | Data monitor | Track your data traffic |
|  | Downloads | Access your downloaded applications |
|  | Email | Send and receive emails |
|  | Facebook™ | Connect with your friends, family members and colleagues around the world |
|  | FM radio | Listen to the radio in your phone |
|  | Gallery | View your pictures and photos |
|  | Gmail™ | An email application that supports Gmail™ |
|  | Google Search | Find information in your phone and on the web |
|  | Latitude | View your friends' locations on Google™ maps and share your location and other information with them |
|  | Maps | View your current location, find other locations and calculate routes |
|  | Market | Go to Android Market™ to download free and paid applications for your phone |
|  | Connected devices | Share media files in your phone with other devices over a shared Wi-Fi® connection |
|  | Messaging | Send and receive text and multimedia messages |
|  | Music | Play music and playlists |
|  | Navigation | Navigate using spoken, turn-by-turn driving instructions |
|  | News and Weather | View news stories and weather forecasts |
|  | Phone | Make and receive calls, switch between calls, set up conference calling and view your call history |
|  | Places | Search for places. For example, you can search for restaurants. |
|  | Store | Download a variety of exciting content to your phone |
|  | Video | Rent and purchase videos |
|  | Settings | Tailor phone settings to your own liking |
|  | Setup guide | Explains basic phone functions and helps you enter essential settings |
|  | Sync | Synchronise your contacts, calendar and other information |

| | | |
|---|-------------------|---|
|  | Support | Find out more on how to use your phone |
|  | Talk | Chat online |
|  | TrackID™ | A music recognition service |
|  | Timescape™ | Keep track of all daily communication |
|  | YouTube™ | Share and view videos from around the world |

- ! Some applications are not supported by all networks and/or service providers in all areas.
- 💡 Applications you download appear automatically in the Application screen.

User support

Access user support directly in your phone through the Support application. For example, you can open a User guide with instructions on how to use your phone. You can also get troubleshooting and other help from the Sony Ericsson support zone, and from our Customer support service.

- **Support application features:**
 - Tools – enhance battery and software performance, and improve connectivity.
 - User guide in the phone – read and search an extended User guide.
 - Educate yourself – read tips and tricks, get the latest news, and watch how-to videos.
 - Email support – send an email to our support team.
 - **Support zone** – visit www.sonyericsson.com/support for comprehensive support to get the most for your phone.
 - **Troubleshooting** – find common problems and error messages at the end of our User guides and on the support zone.
 - **Customer support** – if all else fails. The relevant support numbers are listed in the supplied *Important information* leaflet.
- ! An extended User guide is also available at www.sonyericsson.com/support.

To access the support application

- 1 From your Application screen, find and tap .
- 2 Find and tap the required support item.

Troubleshooting

My phone is not working as expected

If you experience problems with your phone, check these tips before you try anything else:

- Restart your phone.
- Remove and re-insert the battery and SIM card. Then restart your phone.
- Update your phone. Updating your phone ensures optimal performance and provides the latest enhancements. See *Updating your phone* on page 113 for more information.
- Reset your phone.

 Be patient while resetting your phone. Restarting the phone during a reset procedure may damage the phone permanently.

To force close an application

- When a popup window tells you that an application is not responding, tap **Force close**.
-  If you do not want to force stop an application, you can wait for it to respond by tapping **Wait**.

Resetting the phone

You can reset your phone to its original settings, with or without deleting all of your personal data. It is possible to reset the phone to the state it was in before you first turned it on. But before you perform a reset, make sure to back up any important data saved on your phone.

To reset the phone

- 1 From your Home screen, tap .
- 2 Find and tap **Settings** > **Privacy**.
- 3 Tap **Factory data reset**.
- 4 To erase not only internal storage but also other user data such as pictures and music, mark the **Erase SD card** checkbox.
- 5 Tap **Reset phone**.
- 6 To confirm, tap **Erase everything**.

I cannot charge the phone

The charger is not properly connected or the battery connection is poor. Remove the battery and clean the connectors.

No battery charging icon appears when phone starts charging

It may take a few minutes before the battery icon appears on the screen.

The battery performance is low

Follow our smart tips on how to get more out of your battery. See *Battery performance* on page 30.

I cannot transfer content between my phone and the computer, when using a USB cable

The software or the USB drivers have not been properly installed. Go to www.sonyericsson.com/support for more detailed installation instructions and troubleshooting sections.

I cannot use Internet-based services

Make sure your subscription covers data downloads and that the Internet settings in your phone are correct. See *Internet and messaging settings* on page 32 for more information on how to enable data traffic, data roaming, and download Internet settings. Contact your network operator for more information about your subscription settings.

Error messages

No network coverage

- Your phone is in Airplane mode. Make sure Airplane mode is turned off.
- Your phone is not receiving any network signal, or the received signal is too weak. Contact your network operator and make sure that the network has coverage where you are.
- The SIM card is not working properly. Insert your SIM card in another phone. If this works, it is probably your phone that is causing the problem. In this case, contact the nearest Sony Ericsson service center.

Emergency calls only

You are within range of a network, but you are not allowed to use it. However, in an emergency, some network operators allow you to call the international emergency number 112. See *Emergency calls* on page 35 for more information.

SIM card is locked.

You have entered your PIN incorrectly 3 times in a row. To unlock the phone, you need the PUK provided by your operator.

SIM card is PUK-locked.

You have entered your PUK (Personal Unblocking Key) incorrectly 10 times in a row. Please contact your service provider.

Recycle your phone

Sony Ericsson recognizes the importance of recycling so that components and materials are reused. For information on how to recycle in your location, please visit www.sonyericsson.com/recycle/.

Legal information

Sony Ericsson ST17i/ST17a

This User guide is published by Sony Ericsson Mobile Communications AB or its local affiliated company, without any warranty. Improvements and changes to this User guide necessitated by typographical errors, inaccuracies of current information, or improvements to programs and/or equipment, may be made by Sony Ericsson Mobile Communications AB at any time and without notice. Such changes will, however, be incorporated into new editions of this User guide. All rights reserved.

©Sony Ericsson Mobile Communications AB, 2011

Publication number: 1253-3185.1

Your mobile phone has the capability to download, store and forward additional content, for example, ringtones. The use of such content may be restricted or prohibited by rights of third parties, including but not limited to restriction under applicable copyright laws. You, and not Sony Ericsson, are entirely responsible for additional content that you download to or forward from your mobile phone. Prior to your use of any additional content, please verify that your intended use is properly licensed or is otherwise authorized. Sony Ericsson does not guarantee the accuracy, integrity or quality of any additional content or any other third party content. Under no circumstances will Sony Ericsson be liable in any way for your improper use of additional content or other third party content.

This User guide may reference services or applications provided by third parties. Use of such programming or services may require separate registration with the third party provider and may be subject to additional terms of use. For applications accessed on or through a third-party website, please review such websites' terms of use and applicable privacy policy in advance. Sony Ericsson does not warrant or guarantee the availability or performance of any third-party websites or offered services.

Remove the battery to see regulatory information such as the CE mark.

All product and company names mentioned herein are the trademarks or registered trademarks of their respective owners. Any rights not expressly granted herein are reserved. All other trademarks are property of their respective owners.

Visit www.sonyericsson.com/cws/corporate/common/legal/disclaimer for more information.

All illustrations are for illustration purposes only and may not accurately depict the actual phone.

This product is protected by certain intellectual property rights of Microsoft. Use or distribution of such technology outside of this product is prohibited without a license from Microsoft.

Content owners use Windows Media digital rights management technology (WMDRM) to protect their intellectual property, including copyrights. This device uses WMDRM software to access WMDRM-protected content. If the WMDRM software fails to protect the content, content owners may ask Microsoft to revoke the software's ability to use WMDRM to play or copy protected content. Revocation does not affect unprotected content. When you download licenses for protected content, you agree that Microsoft may include a revocation list with the licenses. Content owners may require you to upgrade WMDRM to access their content. If you decline an upgrade, you will not be able to access content that requires the upgrade.

This product is licensed under the MPEG-4 visual and AVC patent portfolio licenses for the personal and non-commercial use of a consumer for (i) encoding video in compliance with the MPEG-4 visual standard ("MPEG-4 video") or the AVC standard ("AVC video") and/or (ii) decoding MPEG-4 or AVC video that was encoded by a consumer engaged in a personal and non-commercial activity and/or was obtained from a video provider licensed by MPEG LA to provide MPEG-4 and/or AVC video. No license is granted or shall be implied for any other use. Additional information including that relating to promotional, internal and commercial uses and licensing may be obtained from MPEG LA, L.L.C. See <http://www.mpegla.com>. MPEG Layer-3 audio decoding technology licensed from Fraunhofer IIS and Thomson.

End-user license agreement for Sun Java Platform, Micro Edition.

1. Restrictions: Software is confidential copyrighted information of Sun and title to all copies is retained by Sun and/or its licensors. Customer shall not modify, decompile, disassemble, decrypt, extract, or otherwise reverse engineer Software. Software may not be leased, assigned, or sublicensed, in whole or in part.

Index

| | |
|--|------------|
| A | |
| accounts | 13 |
| Exchange Active Sync® | 13 |
| Facebook™ | 13 |
| Google™ | 13 |
| Sony Ericsson | 13 |
| adjusting volume | 80 |
| airplane mode | 30 |
| alarm | 61 |
| albums | |
| deleting | 99 |
| Android Market™ | 55 |
| Android™ | 8 |
| animated wallpaper | 21 |
| answering service | 36 |
| applications | 8 |
| overview | 118 |
| screen | 21 |
| audio | |
| adjusting volume | 80 |
| playing | 79 |
| playing music in random order | 82 |
| audio books | 79 |
| B | |
| back | |
| cover | 9 |
| removing | 9 |
| back up | |
| contacts | 43 |
| battery | 15 |
| cover | 9 |
| removing | 9 |
| Bluetooth™ wireless technology | 102 |
| brightness | 29 |
| <i>browsing - See web browser</i> | |
| business cards | |
| sending | 42 |
| C | |
| calendar | 61 |
| create an event | 61 |
| calling | 32 |
| calls | 35, 38 |
| barring | 38 |
| diverting | 38 |
| emergency | 35 |
| forwarding | 38 |
| list | 36 |
| log | 36 |
| missed | 36 |
| multiple | 37 |
| recent | 36 |
| settings | 38 |
| waiting | 37 |
| camera | 87, 89 |
| camera screen | 87 |
| closing | 87 |
| continuous auto focus | 90, 94 |
| controls | 87 |
| face detection | 88 |
| geotagging | 89 |
| HD (High Definition) video | 94 |
| icons | 94 |
| overview | 87 |
| recording videos | 93, 94 |
| settings | 89, 90, 94 |
| smile detection | 89 |
| taking photos | 88, 89 |
| using flash | 88 |
| video | 93 |
| viewing photos | 88 |
| viewing videos | 94 |
| zoom | 88 |
| caps lock | 24 |
| changing tracks | 80 |
| charging | 15 |
| chat | 50 |
| conference calls | 37 |
| contacts | 39 |
| back up | 43 |
| copy | 43 |
| favourite | 42 |
| importing from SIM card | 39 |
| joining contact information | 41 |
| picture | 41, 100 |
| sending | 42 |
| sharing | 42 |
| corporate email, calendar and contacts | 67 |
| cropping | |
| photos | 100 |
| D | |
| date | |
| format | 28 |
| deleting | 99 |
| an alarm | 61 |
| photos | 100 |
| tracks | 81 |
| videos | 101 |
| download | |
| Internet settings | 32 |
| driving directions | 109 |
| E | |
| email | 46 |
| more than one account | 48 |
| emergency numbers | 35 |
| equalizer | 80 |
| events | |
| calendar | 61 |
| in Timescape™ | 52 |
| extensions | 19 |
| F | |
| face detection | 88 |
| Facebook™ | |
| logging in to | 53 |
| status update | 53 |
| Facebook™ synchronisation | 67 |
| favourites | |
| moving between in the radio | 86 |
| removing radio channels as | 86 |
| saving radio channels as | 86 |
| filter | |
| events in Timescape™ | 52 |
| fixed dialling | 38 |
| flash | |
| using when taking photos | 88 |
| FM radio | |
| favourites | 86 |
| G | |
| Gallery | 97 |
| changing views | 98 |
| opening | 97 |

| | | | |
|---|------------|--|----------------|
| opening albums | 97 | pausing a track | 80 |
| viewing Facebook™ photos | 98 | player overview | 80 |
| geotagging | | playing | 79 |
| of photos | 89 | playing in random order | 82 |
| Gmail™ | 48 | podcasts | 79 |
| Google Latitude™ | 109 | purchasing | 84 |
| Google Maps™ | 109 | searching using TrackID™ | 84 |
| Google Talk™ | 50 | sharing | 81 |
| Google™ account setup | 49 | using handsfree | 32 |
| Google™ synchronisation | 66 | using the equalizer | 80 |
| GPS | 108 | music | 81 |
| H | | music player | |
| handsfree | 32 | creating playlists | 82 |
| using | 32 | deleting tracks | 81 |
| HD (High Definition) video | 94 | equalizer | 80 |
| Home screen | 19 | minimising | 81 |
| customising | 20 | playlists | 82 |
| rearranging | 20 | smart playlists | 82 |
| I | | music player widget | 81 |
| icon | 116 | N | |
| icons | 116 | Navigation | 109 |
| in the camera | 94 | Navigation application | 109 |
| importing SIM contacts | 39 | NeoReader™ application | 64 |
| infinite button | 81 | notification | 23, 116 |
| in Timescape™ | 54 | panel | 23 |
| instant messaging | 50 | ringtone | 28 |
| Internet | | O | |
| settings | 32 | on-screen keyboard | 26 |
| web browser | 75 | overview | |
| K | | overall phone overview | 80 |
| keys | 15 | P | |
| L | | pausing a track | 80 |
| language | 29 | personal information | 39 |
| writing | 27 | phone | |
| Latitude | 109 | battery | 30 |
| LCD backlight control | 29 | performance | 30 |
| light | 23 | update | 113 |
| live wallpaper | 21 | phonebook | 39 |
| location | 89 | Phonepad | 24 |
| location services | 108 | settings | 27 |
| locks | | photo albums | 97 |
| activating the screen | 12 | deleting | 99 |
| locking the screen | 12 | viewing | 97 |
| screen lock | 12 | photos | 99, 100 |
| M | | adding the geographical position | 89 |
| <i>mail See email</i> | | associating with a contact | 41 |
| Maps | 109 | copying to/from a computer | 79 |
| media files | | cropping | 100 |
| copying to memory card | 79 | deleting | 100 |
| Media Go™ | 107 | photo viewer | 98 |
| messages | | rotating | 99 |
| settings | 32 | sharing | 99, 100 |
| Microsoft® Exchange synchronisation | 67 | slideshow | 99 |
| MMS | | taking | 88, 89 |
| settings | 32 | using as a contact picture | 100 |
| multimedia | | using as wallpaper | 100 |
| copying to memory card | 79 | viewing | 88, 97, 98, 99 |
| music | 32, 79, 85 | viewing on a map | 100 |
| adding tracks to playlists | 82 | viewing same location | 89 |
| adjusting volume | 80 | zooming | 99 |
| audio books | 79 | PIN | 110 |
| changing tracks | 80 | playing | |
| copying to memory card | 79 | music | 79 |
| copying to/from a computer | 79 | playlists | 82 |
| creating playlists | 82 | adding a track | 82 |
| deleting | 81 | creating | 82 |
| my playlists | 83 | deleting playlists | 83 |
| | | playing your own | 83 |
| | | removing tracks | 83 |

| | | | |
|---|---------|--|---------|
| smart (auto-generated) | 82 | exporting contacts to | 43 |
| top tracks | 82 | importing contacts from | 39 |
| power | 12 | inserting | 9 |
| presets | | slideshow | 99 |
| removing radio channels as | 86 | smart playlists | |
| saving radio channels as | 86 | playing | 82 |
| protective plastic sheet | 16 | smile detection | 89 |
| PUK | 110 | Sony Ericsson Sync | 68 |
| purchasing | | SOS <i>See emergency numbers</i> | |
| music | 84 | status | 23, 116 |
| Q | | still camera | 87, 88 |
| Qriocity™ | 59 | settings | 89, 90 |
| creating an account | 59 | using flash | 88 |
| menu overview | 59, 60 | store contacts | 68 |
| notifications | 59 | symbols | 24 |
| watching a video | 60 | synchronising | 66 |
| R | | calendar, bookmarks | 69 |
| radio | 85 | contacts | 68, 69 |
| favourites | 86 | Facebook™ contacts, calendar, albums | 67 |
| listening through the speaker | 86 | Google™ contacts, calendar, email | 66 |
| moving between channels | 85 | Microsoft® Exchange contacts, calendar, email | 67 |
| navigating | 85 | SyncML™ | 69 |
| opening | 85 | T | |
| overview | 85 | taking photos | 87 |
| searching for channels | 86 | by tapping | 88 |
| selecting channels | 85 | using face detection | 88 |
| receiving items using Bluetooth™ | 103 | using smile detection | 89 |
| recent calls | 36 | using the camera key | 88 |
| recently used applications window | 22 | <i>telephony See calls</i> | |
| recording videos | 87 | text input method | 24 |
| using the camera key | 93 | themes | 21 |
| related audio content | 81 | tiles | 51 |
| reset | 121 | time | 28 |
| resizing | | time management | 61 |
| photos | 100 | Timescape™ | 51 |
| ringtone | 61 | filter icons | 52 |
| rotating | | infinite button in | 54 |
| photos | 99 | screen overview | 51 |
| S | | settings | 54 |
| screen | 29 | widget | 51, 52 |
| cracked | 16 | top tracks | |
| glass | 16 | playing | 82 |
| warranty | 16 | TrackID™ | |
| screen unlock pattern | 110 | using the FM Radio | 86 |
| searching | | TrackID™ technology | 84 |
| music using TrackID™ | 84 | buying a track | 84 |
| track information | 84 | opening | 84 |
| sending | 99, 100 | searching for track information | 84 |
| business cards | 42 | using results | 84 |
| contacts | 42 | viewing charts | 84 |
| sending items using Bluetooth™ | 103 | troubleshooting | 121 |
| services | 13 | turning off | 12 |
| settings | 12 | turning on | 12 |
| call | 38 | Twitter™ | |
| camera | 89, 94 | logging in to | 53 |
| Internet | 32 | status update | 53 |
| messaging | 32 | U | |
| MMS | 32 | update | |
| still camera | 89 | status | 53 |
| Timescape™ | 54 | updating phone | 113 |
| video camera | 94 | usage info | 33 |
| setup guide | 12 | USB connection | 105 |
| sharing | | V | |
| music | 81 | vibration | 28, 61 |
| photos | 100 | video | 59 |
| photos and videos | 99 | video albums | 97, 99 |
| shuffle music | 82 | viewing | 97 |
| silent mode | 27 | video camera | 87, 93 |
| SIM card | 110 | | |

| | |
|--|----------------|
| continuous auto focus | 94 |
| HD (High Definition) video | 94 |
| recording videos | 94 |
| settings | 94 |
| video player | |
| pausing a video | 101 |
| videos | 100 |
| adjusting volume | 101 |
| buying | 59 |
| copying to/from a computer | 79 |
| deleting | 101 |
| fast forwarding and rewinding | 101 |
| pausing | 101 |
| playing | 101 |
| recording | 93, 94 |
| renting | 59 |
| sending | 101 |
| sharing | 101 |
| viewing | 94, 97, 98, 99 |
| viewing | |
| photos | 88 |
| videos recorded using the camera | 94 |
| voicemail | 36 |
| volume | |
| adjusting video | 101 |
| key | 27 |
| W | |
| wallpaper | 21 |
| using a photo as | 100 |
| web browser | 75 |
| managing bookmarks | 76 |
| settings | 78 |
| toolbar | 75 |
| Wi-Fi® | 70 |
| widget | |
| Timescape™ | 51, 52 |
| widgets | 19 |
| wireless networks | 108 |
| Wisepilot™ | 109 |
| Z | |
| zoom | 88 |
| zooming | |
| photos | 99 |