

# Contents

## Getting started ..... 6

Assembly ..... 6

Turning on the phone ..... 7

Help ..... 8

Charging the battery ..... 8

Phone overview ..... 9

Menu overview ..... 11

Navigation ..... 13

Phone language ..... 15

Entering text ..... 15

## Internet ..... 17

Internet security and certificates .... 19

Web feeds ..... 19

## GPS ..... 21

Using the GPS ..... 21

Google Maps™ for mobile..... 21

Driving directions ..... 21

More GPS features ..... 22

## Calling ..... 23

Making and receiving calls ..... 23

Contacts ..... 24

Call list ..... 28

Speed dial ..... 28

# Sony Ericsson Z780i

Voicemail ..... 28

Voice control ..... 29

More than one call ..... 30

Restricted dialling ..... 32

Call time and cost ..... 33

Showing or hiding your phone  
number ..... 33

## Messaging ..... 34

Text messages..... 34

Picture messages ..... 35

Message options ..... 36

Templates ..... 36

Voice messages ..... 37

Email ..... 37

My friends ..... 39

Area and cell information ..... 40

## Imaging ..... 41

Camera and video recorder ..... 41

Using the camera..... 41

Camera icons and settings ..... 42

Transferring pictures..... 43

Camera printing ..... 43

Pictures ..... 44

PhotoDJ™ and VideoDJ™ ..... 45

<b>Media player and music ...</b>	<b>46</b>	<b>More features .....</b>	<b>59</b>
Transferring content to and from a computer .....	46	Flight mode .....	59
Stereo portable handsfree .....	46	File manager .....	60
Music player .....	47	Alarms.....	61
PlayNow™ .....	48	Calendar .....	61
TrackID™ .....	48	Notes .....	63
Online music and video clips.....	49	Tasks .....	63
<b>Entertainment .....</b>	<b>49</b>	Profiles .....	63
Video player .....	49	Time and date.....	64
Radio .....	49	Theme.....	64
Ringtones and melodies .....	50	Main menu layout .....	64
MusicDJ™ .....	50	Locks .....	65
Sound recorder.....	51	<b>Troubleshooting .....</b>	<b>66</b>
Games .....	51	Common questions .....	66
Applications .....	51	Error messages.....	69
<b>Connectivity .....</b>	<b>52</b>	<b>Important information .....</b>	<b>70</b>
Settings .....	52	Guidelines for Safe and Efficient Use .....	72
Phone name.....	53	End User Licence Agreement.....	77
Bluetooth™ wireless technology ...	53	Limited Warranty .....	78
Using a USB cable.....	55	FCC Statement .....	80
Synchronizing .....	56	Declaration of Conformity for Z780i.....	81
Update service .....	58	<b>Index .....</b>	<b>82</b>

## Sony Ericsson Z780i

UMTS HSDPA 850/1900/2100 GSM EDGE 850/900/1800/1900

This User guide is published by Sony Ericsson Mobile Communications AB or its local affiliated company, without any warranty. Improvements and changes to this User guide necessitated by typographical errors, inaccuracies of current information, or improvements to programs and/or equipment, may be made by Sony Ericsson Mobile Communications AB at any time and without notice. Such changes will, however, be incorporated into new editions of this User guide. All rights reserved.

©Sony Ericsson Mobile Communications AB, 2007

Publication number: 1206-5892.1

Please note:

Some of the services in this User guide are not supported by all networks. *This also applies to the GSM International Emergency Number 112.*

Please contact your network operator or service provider if you are in doubt whether you can use a particular service or not.

Please read the *Guidelines for safe and efficient use* and the *Limited warranty* chapters before you use your mobile phone.

Your mobile phone has the capability to download, store and forward additional content, e.g. ringtones. The use of such content may be restricted or prohibited by rights of third parties, including but not limited to restriction under applicable copyright laws. You, and not Sony Ericsson, are entirely responsible for additional content that you download to or forward from your mobile phone. Prior to your use of any additional content, please verify that your intended use is properly licensed or is otherwise authorized. Sony Ericsson does not guarantee the accuracy, integrity or quality of any additional content or any other third party content. Under no

circumstances will Sony Ericsson be liable in any way for your improper use of additional content or other third party content.

Smart-Fit Rendering is a trademark or a registered trademark of ACCESS Co., Ltd.

Bluetooth is a trademark or a registered trademark of Bluetooth SIG Inc. and any use of such mark by Sony Ericsson is under license.

The Liquid Identity logo, PlayNow, MusicDJ, PhotoDJ, TrackID and VideoDJ are trademarks or registered trademarks of Sony Ericsson Mobile Communications AB.

TrackID™ is powered by Gracenote Mobile MusicID™. Gracenote and Gracenote Mobile MusicID are trademarks or registered trademarks of Gracenote, Inc.

Lotus Notes is a trademark or a registered trademark of International Business Machines Corporation.

Sony, Memory Stick Micro™ and M2™ are trademarks or registered trademarks of Sony Corporation.

Google™ and Google Maps™ are trademarks or registered trademarks of Google, Inc.

Wayfinder and Wayfinder Navigator are trademarks or registered trademarks of Wayfinder Systems AB.

SyncML is a trademark or registered trademark of Open Mobile Alliance LTD.

Ericsson is a trademark or registered trademark of Telefonaktiebolaget LM Ericsson.

Adobe Photoshop Album Starter Edition is a trademark or registered trademark of Adobe Systems Incorporated in the United States and/or other countries.

Microsoft, ActiveSync, Windows, Outlook, and Vista are registered trademarks or trademarks of Microsoft Corporation in the United States and/or other countries.

T9™ Text Input is a trademark or a registered trademark of Tegic Communications. T9™ Text Input is licensed under one or more of the following: U.S. Pat. Nos. 5,818,437, 5,953,541, 5,187,480, 5,945,928, and 6,011,554; Canadian Pat. No. 1,331,057, United Kingdom Pat. No. 2238414B; Hong Kong Standard Pat. No. HK0940329; Republic of Singapore Pat. No. 51383; Euro.Pat. No. 0 842 463(96927260.8) DE/DK, FI, FR, IT, NL, PT, ES, SE, GB; and additional patents are pending worldwide.

Java and all Java based trademarks and logos are trademarks or registered trademarks of Sun Microsystems, Inc. in the U.S. and other countries. End-user license agreement for Sun™ Java™ J2ME™.

This product is protected by certain intellectual property rights of Microsoft. Use or distribution of such technology outside of this product is prohibited without a license from Microsoft.

Content owners use Windows Media digital rights management technology (WMDRM) to protect their intellectual property, including copyrights. This device uses WMDRM software to access WMDRM protected content. If the WMDRM software fails to protect the content, content owners may ask Microsoft to revoke the software's ability to use WMDRM to play or copy protected content.

Revocation does not affect unprotected content. When you download licenses for protected content, you agree that Microsoft may include a revocation list with the licenses. Content owners may require you to upgrade WMDRM to access their content. If you decline an upgrade, you will not be able to access content that requires the upgrade.

With respect to a Licensee offering MPEG-4 Video Decoders and/or Encoders the following notice shall be given: This product is licensed under the MPEG-4 visual patent portfolio license for the personal and non-commercial use of a consumer for (i) encoding video in compliance with the MPEG-4 visual standard

("MPEG-4 video") and/or (ii) decoding MPEG-4 video that was encoded by a consumer engaged in a personal and noncommercial activity and/or was obtained from a video provider licensed by MPEG LA to provide MPEG-4 video. No license is granted or shall be implied for any other use. Additional information including that relating to promotional, internal and commercial uses and licensing may be obtained from MPEG LA, LLC. See <http://www.mpegla.com>.

Notice Required for the License Granted under Articles 2.1 and 2.6. As a condition to the licenses granted pursuant to Articles 2.1 and 2.6 hereof, Licensee agrees to provide to any party that receives from Licensee an AVC Royalty Product the following notice: This product is licensed under the AVC patent portfolio license for the personal and non-commercial use of a consumer to (i) encode video in compliance with the AVC standard ("AVC video") and/or (ii) decode AVC video that was encoded by a consumer engaged in a personal and non-commercial activity and/or was obtained from a video provider licensed to provide AVC video. No license is granted or shall be implied for any other use. Additional information may be obtained from MPEG LA, L.L.C. See <http://www.mpegla.com>.

MPEG Layer-3 audio decoding technology licensed from Fraunhofer IIS and Thomson.

Restrictions: Software is confidential copyrighted information of Sun and title to all copies is retained by Sun and/or its licensors. Customer shall not modify, decompile, disassemble, decrypt, extract, or otherwise reverse engineer Software. Software may not be leased, assigned, or sublicensed, in whole or in part.

Export Regulations: This product, including any software or technical data contained in or accompanying the product, may be subject to U.S. export control laws, including the U.S. Export Administration Act and its associated regulations and the U.S. sanctions programs administered by the U.S. Treasury Department's Office of Foreign

Assets Control, and may be additionally subject to export or import regulations in other countries. The user and any possessor of the product agrees to comply strictly with all such regulations and acknowledges that it is their responsibility to obtain any required licenses to export, re-export, or import this product. Without limitation this product, including any software contained therein, may not be downloaded, or otherwise exported or re-exported (i) into, or to a national or resident of, or an entity in, Cuba, Iraq, Iran, North Korea, Sudan, Syria (as such listing may be revised from time to time) or any country to which the U.S. has embargoed goods; or (ii) to any person or entity on the U.S. Treasury Department's list of Specially Designated Nationals or (iii) any person or entity on any other export prohibition list that may be maintained from time to time by the United States Government, including but not limited to the U.S. Commerce Department's Denied Persons List or Entity List, or the U.S. State Department's Nonproliferation Sanctions List.

Restricted Rights: Use, duplication or disclosure by the United States government is subject to the restrictions as set forth in the Rights in Technical Data and Computer Software Clauses in DFARS 252.227-7013(c) (1) (ii) and FAR 52.227-19(c) (2) as applicable.

Other product and company names mentioned herein may be the trademarks of their respective owners.  
Any rights not expressly granted herein are reserved.  
All illustrations are for illustration only and may not accurately depict the actual phone.

## Instruction symbols

These symbols may appear in the User guide.

 Note

 Tip

 Warning

 A service or function is network- or subscription-dependent. Contact your network operator for details.

> Use a selection or navigation key to scroll and select. See *Navigation* on page 13.

# Getting started

## Assembly

Before you start using your phone, you need to insert a SIM card and the battery.

### *To insert the SIM card*

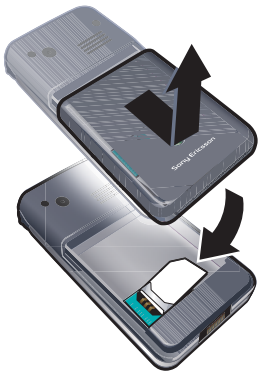

- 1 Remove the battery cover by pressing and sliding it as shown in the picture.
- 2 Slide the SIM card into its holder with the gold-coloured contacts facing down.

### *To insert the battery*

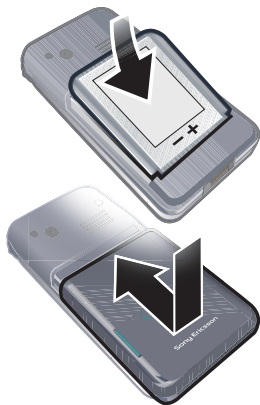

- 1 Insert the battery with the label side up and the connectors facing each other.
- 2 Slide the battery cover into place.

## Turning on the phone

### To turn on the phone



- 1 Press and hold down ①.
- 2 Enter your SIM card PIN, if requested and select **OK**.
- 3 Select a language.
- 4 Select **Yes** to use the setup wizard while settings are downloaded.

 *If you want to correct a mistake when you enter your PIN, press **C**.*

### SIM card

The SIM (Subscriber Identity Module) card, which you get from your network operator, contains information about

your subscription. Always turn off your phone and detach the charger before you insert or remove the SIM card.

 *You can save contacts on the SIM card before you remove it from your phone. See *To copy names and numbers to the SIM card* on page 26.*

### PIN

You may need a PIN (Personal Identification Number) to activate the services in your phone. Your PIN is supplied by your network operator. Each PIN digit appears as \*, unless it starts with emergency number digits, for example, 112 or 911. You can see and call an emergency number without entering a PIN.

 *If you enter the wrong PIN three times in a row, the SIM card is blocked. See *SIM card lock* on page 65.*

### Startup screen

The startup screen appears when you turn your phone on. See *Using pictures* on page 45.

### Standby

After you have turned your phone on and entered your PIN, the name of the network operator appears. This view is called standby.

## Help

In addition to this User guide, Getting started guides and more information are available at [www.sonyericsson.com/support](http://www.sonyericsson.com/support).

### Help in your phone

Help and information are available in your phone. See *Navigation* on page 13.

### To view tips and tricks

- 1 From standby select **Menu** > **Settings** > the **General** tab > **Setup wizard**.
- 2 Select **Tips and tricks**.

### To view information about functions

- Scroll to a function and select **Info**, if available. In some cases, **Info** appears under **Options**.

### To view the phone demonstration

- From standby select **Menu** > **Entertainment** > **Demo tour**.

### To view status information

- From standby press the volume key up.

## Charging the battery

The phone battery is partly charged when you buy it.

### To charge the battery

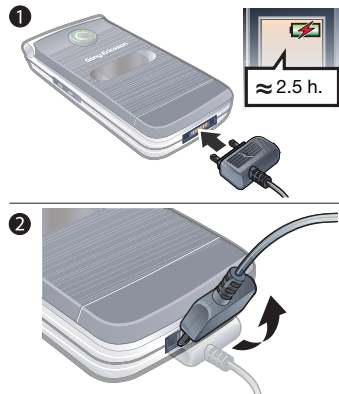

- 1 Connect the charger to the phone. It takes approximately 2.5 hours to fully charge the battery. Press a key to view the screen.
- 2 Remove the charger by tilting the plug upwards.

 You can use your phone while it is charging. You can charge the battery at any time and for more or less than 2.5 hours. You can interrupt the charging without damaging the battery.



## Phone overview

- 1 Ear speaker
- 2 Screen
- 3 Selection keys
- 4 Call key
- 5 Memory card slot
- 6 Activity menu key
- 7 Microphone
- 8 End key
- 9 C key (Clear)
- 10 Navigation key
- 11 Silent key
- 12 On/off key
- 13 Connector for charger, handsfree and USB cable

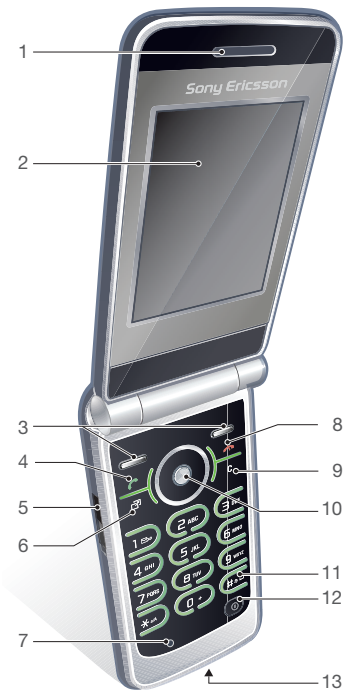

- 14 Strap holder
- 15 Volume keys
- 16 GPS antenna
- 17 External display
- 18 Camera lens
- 19 Speaker mesh



## Menu overview



PlayNow™\*



Internet\*



Entertainment

- Online services\*
- Radio
- TrackID™
- Games
- VideoDJ™
- PhotoDJ™
- MusicDJ™
- Remote control
- Record sound
- Demo tour



Camera



Messaging

- Write new
- Inbox
- Email
- Drafts
- Outbox
- Sent messages
- Saved messages
- My friends\*
- Call voicemail
- Templates
- Manage messages
- Settings



Media

- Photo
- Music
- Video
- Games
- TV\*
- Web feeds
- Settings



Location services

- Google Maps\*
- Navigation\*
- My favourites
- Status info
- Log
- Settings



Contacts

- Myself
- New contact



Alarms

 **Calls\*\*****All****Answered****Dialed****Missed** **Organizer**

File manager\*\*  
Applications  
Calendar  
Tasks  
Notes  
Synchronization  
Timer  
Stopwatch  
Calculator  
Code memo

 **Settings\*\*****General**

Profiles  
Time & date  
Language  
Update service  
Voice control  
New events  
Shortcuts  
Flight mode  
Security  
Setup wizard  
Accessibility\*  
Phone status  
Master reset

**Sounds & alerts**

Ring volume  
Ringtone  
Silent mode  
Increasing ring  
Vibrating alert  
Message alert  
Key sound

**Display**

Wallpaper  
Main menu layout  
Theme  
Startup screen  
Screen saver  
Clock size  
Brightness  
Edit line names\*

**Calls**

Speed dial  
Smart search  
Divert calls  
Switch to line 2\*  
Manage calls  
Time & cost\*  
Show/hide my no.  
Handsfree  
Open to answer

**Connectivity**

Bluetooth  
USB  
Phone name  
Network sharing  
Synchronization  
Device management  
Mobile networks  
Data communication\*  
Internet settings  
Streaming settings  
Message settings\*  
SIP settings  
Accessories

\* Some menus are operator-, network- and subscription-dependent.

\*\* You can use the navigation key to scroll between tabs in submenus. For more information, see Navigation on page 13.

## Navigation

The main menus are shown as icons. Some submenus include tabs.

### *To navigate the phone menus*

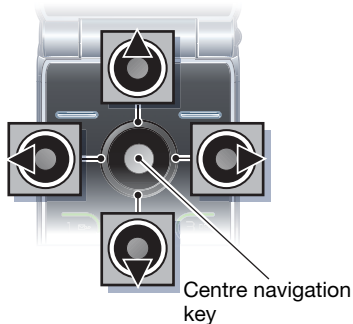

- 1 From standby select **Menu**.
- 2 Use the navigation key to move through the menus.

### *To select actions on the screen*

- Press the left or right selection key, or the centre navigation key.

### *To view options for an item*

- Select **Options** to, for example, edit.

### *To scroll between the tabs*

- Scroll to a tab by pressing the navigation key left or right.

### *To return to standby*

- Press .

### *To end a function*

- Press .

### *To navigate your media*

- 1 From standby select **Menu** > **Media**.
- 2 Scroll to a menu item and press the navigation key right.
- 3 To go back, press the navigation key left.

### *To delete items*

- Press  to delete items such as numbers, letters, pictures and sounds.

### *To send items*

- 1 Scroll to an item such as a contact, a picture or a sound.
- 2 Select **Options** > **Send**.
- 3 Select a transfer method.

- ! *Make sure the receiving device supports the transfer method you select.*

## Shortcuts

You can use keypad shortcuts to go directly to a menu. Menu numbering starts from the top left icon and moves across and then down row by row.

### To go directly to a main menu

- From standby select **Menu** and press **1** - **9**, **\*#** or **0+** or **#**.

- !** The *Main menu layout* must be set to *Grid*. See *To change the main menu layout on page 64*.

### To use navigation key shortcuts

- From standby press **⬅**, **⬇**, **⬅** or **➡** to go directly to a function.

### To edit a navigation key shortcut

- From standby select **Menu** > **Settings** > the **General** tab > **Shortcuts**.
- Scroll to an option and select **Edit**.
- Scroll to a menu option and select **Shortc.**

## Activity menu

The activity menu gives you quick access to certain functions.

### To open the activity menu

- Press **☰**.

### Activity menu tabs

- New events** – missed calls and new messages.
- Running apps** – applications that are running in the background.
- My shortcuts** – add your favourite functions to access them quickly.
- Internet** – quick access to the Internet.

## Memory card

- !** You may have to purchase a memory card separately.

Your phone supports Memory Stick Micro™ (M2™) memory card adding more storage space to your phone. It can also be used as a portable memory card with other compatible devices.

You can use the file manager to move files between the memory card and the phone memory. See *To move a file in the file manager* on page 60.

### To insert a memory card



- Open the cover and insert the memory card with the gold-coloured contacts facing up.

### To remove a memory card

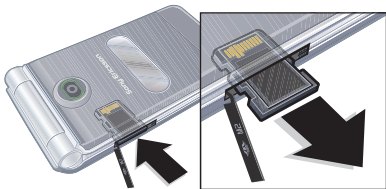

- Open the cover and press the edge of the memory card to release and remove it.

### To view memory card options

- 1 From standby select **Menu** > **Organizer** > **File manager** > the **On memory card** tab.
- 2 Select **Options**.

### Phone language

You can select a language to use in your phone.

### To change the phone language

- 1 From standby select **Menu** > **Settings** > the **General** tab > **Language** > **Phone language**.
- 2 Select an option.

### Entering text

You can use multitap text input or T9™ Text Input **T9** to enter text. The T9 Text Input method uses a built-in dictionary.

### To change text input method

- When you enter text, press and hold down **(\*/a/A)**.

### To shift between capitals and lower-case letters

- When you enter text, press **(\*/a/A)**.

### *To enter numbers*

- When you enter text, press and hold down **0+** – **9**.

### *To enter full stops and commas*

- When you enter text, press **1**.

### *To enter a symbol*

- 1 When you enter text, select **Options** > **Add symbol**.
- 2 Scroll to a symbol and select **Insert**.

### *To enter text using T9™ Text Input*

- 1 From standby select, for example, **Menu** > **Messaging** > **Write new** > **Text message**.
- 2 If **T9** is not displayed, press and hold down **\*a/A** to change to T9 Text Input.
- 3 Press each key only once, even if the letter you want is not the first letter on the key. For example, to write the word “Jane”, press **5**, **2**, **6**, **3**. Write the whole word before looking at the suggestions.
- 4 Use **⬆** or **⬇** to view suggestions.
- 5 Press **#↵** to accept a suggestion.

### *To enter text using multitap*

- 1 From standby select, for example, **Menu** > **Messaging** > **Write new** > **Text message**.
- 2 If **T9** is displayed, press and hold down **\*a/A** to change to multitap text input.
- 3 Press **2** – **9** repeatedly until the desired letter appears.
- 4 When a word is written, press **#↵** to add a space.

### *To add words to the built-in dictionary*

- 1 When you enter text using T9 Text Input, select **Options** > **Spell word**.
- 2 Write the word using multitap input and select **Insert**.



# Internet

## *To start browsing*

- 1 From standby select **Menu** > **Internet**.
- 2 Select **Options** > **Go to**.
- 3 Select an option.

! If your connection to the Internet does not work, see *Settings on page 52* or contact your operator.

## *To exit the browser*

- When you browse the Internet, select **Options** > **Exit browser**.

## Bookmarks

You can create and edit bookmarks as quick links to your favourite Web pages.

### *To create a bookmark*

- 1 When you browse the Internet, select **Options** > **Tools** > **Add bookmark**.
- 2 Enter a title and an address. Select **Save**.

### *To select a bookmark*

- 1 From standby select **Menu** > **Internet**.
- 2 Select **Options** > **Go to** > **Bookmarks**.
- 3 Scroll to a bookmark and select **Go to**.

## History pages

You can view Web pages you have browsed.

### *To view history pages*

- From standby select **Menu** > **Internet** > **Options** > **Go to** > **History**.

### *To use pan and zoom on a Web page*

- 1 When you browse the Internet, press **(#->?)**.
- 2 Use the navigation key to move the frame.
- 3 Press **Zoom**.
- 4 To switch back to pan, press **(#->?)**.





! To use pan and zoom, you need to turn off Smart-fit: **Options** > **Advanced** > **Smart-Fit** > **Off**.

## Internet keypad shortcuts

You can use the keypad to go directly to an Internet browser function.

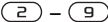
### **To select Internet keypad shortcuts**

- 1 From standby select **Menu** > **Internet**.
- 2 Select **Options** > **Advanced** > **Keypad mode** > **Shortcuts**.

Key	Shortcut
	<b>Bookmarks</b>
	Enter text to <b>Enter address</b> , <b>Search Internet</b> or search in <b>Bookmarks</b> .
	<b>Fullscreen</b> or <b>Landscape</b> or <b>Normal screen</b> .
	<b>Zoom</b>
	<b>Pan &amp; zoom</b> (when <b>Smart-Fit</b> is off).

### **To make a call while browsing**

- When you browse the Internet press .

### **To save a picture from a Web page**

- 1 When you browse the Internet, select **Options** > **Tools** > **Save picture**.
- 2 Select a picture.

### **To find text on a Web page**

- 1 When you browse the Internet, select **Options** > **Tools** > **Find on page**.
- 2 Enter text and press **Find**.

### **To send a link**

- 1 When you browse the Internet, select **Options** > **Tools** > **Send link**.
- 2 Select a transfer method.

 *Make sure the receiving device supports the transfer method you select.*

### **To copy and paste text while browsing**

- 1 When you browse the Internet, select **Options** > **Tools** > **Mark & Copy**.
- 2 Scroll to where you want to start copying and select **Mark**.
- 3 Scroll to mark text.
- 4 Select **Copy**.
- 5 Navigate to where you want to insert the text and select **Options** > **Copy & paste** > **Paste**.

### **To save a Web page**

- When you browse the Internet, select **Options** > **Tools** > **Save page**.

### **To view saved Web pages**

- 1 From standby select **Menu** > **Organizer** > **File manager** > **Web pages** > **Saved pages**.
- 2 Scroll to an item and select **View**.

## Internet security and certificates

Your phone supports secure browsing. Certain Internet services, such as banking, require certificates in your phone. Your phone may already contain certificates when you buy it or you can download new certificates.

### To view certificates in the phone

- From standby select **Menu** > **Settings** > the **General** tab > **Security** > **Certificates**.





## Web feeds

You can subscribe to and download frequently updated content, such as news, podcasts or photos, using Web feeds.

### To add new feeds for a Web page

- 1 When you browse a page on the Internet that has Web feeds, indicated by the  icon, select **Options** > **Web feeds**.
- 2 For each feed you want to add, scroll to the feed and select **Mark**.
- 3 Select **Options** > **Continue**.

### To download content via feeds

- 1 From standby select **Menu** > **Media** > **Web feeds**.
- 2 Scroll to a feed and select **View** or .
- 3 Select a heading to expand.
- 4 Select an icon depending on content,  to open a Web page,  to download an audio podcast,  to download a video podcast or  to download a photo.

 You can also subscribe to and download content to a computer via feeds using Sony Ericsson Media Manager. You can then transfer the content to your phone. See *Transferring content to and from a computer on page 46*.

### Updating Web feeds

You can manually update your feeds, or schedule updates. When there are updates,  appears on the screen.

### To schedule Web feed updates

- 1 From standby select **Menu** > **Media** > **Web feeds**.
- 2 Scroll to a feed and select **Options** > **Schedule update**.
- 3 Select an option.

 *Frequent updates may be costly.*

### ***To update Web feeds manually***

- 1 From standby select [Menu](#) > [Media](#) > [Web feeds](#).
- 2 Scroll to a feed and select [Options](#) > [Update](#).
- 3 Select an option.



### **Web feeds in standby**

You can show news updates on the standby screen.

### ***To show Web feeds in standby***

- From standby select [Menu](#) > [Media](#) > [Web feeds](#). Scroll to a feed and select [Options](#) > [Settings](#) > [Standby ticker](#) > [Show in standby](#).

### ***To access Web feeds from standby***

- 1 From standby select [Ticker](#).
- 2 To read more about a feed, press  or  to scroll to a headline and select [Go to](#).

### **Podcasts**

Podcasts are files, for example, radio programs or video content, that you can download and play. You subscribe to and download podcasts using Web feeds.

### ***To access audio podcasts***

- From standby select [Menu](#) > [Media](#) > [Music](#) > [Podcasts](#).

### ***To access video podcasts***

- From standby select [Menu](#) > [Media](#) > [Video](#) > [Podcasts](#).

### **Photo feeds**

You can subscribe to Photo feeds and download photos. To start using Photo feeds, see *Web feeds* on page 19.

### ***To access photo feeds***

- From standby select [Menu](#) > [Media](#) > [Photo](#) > [Photo feeds](#).

## GPS

Your phone is equipped with a GPS receiver that uses satellite signals to calculate your location.

! *Some GPS features use the Internet.*

### Using the GPS

Make sure you have a clear view of the sky when using features that require the GPS receiver to find your location. If your location is not found after a few minutes, move to another location. To facilitate the search, stand still and do not cover the GPS antenna.



### Assisted GPS

With Assisted GPS (A-GPS) it takes less time to calculate a location.

 *Contact your network operator for more information.*

### Google Maps™ for mobile

Google Maps™ lets you view maps and satellite imagery, find locations and calculate routes.

#### *To use Google Maps*

- From standby select [Menu > Location services > Google Maps](#).

#### *To view help about Google Maps*

- When you use Google Maps, select [Options > Help](#).

### Driving directions

Wayfinder Navigator™ guides you to your destination using voice instructions. A free three-month trial version of Wayfinder Navigator is included in the phone.

! *Sony Ericsson does not warrant the accuracy of any directional services including but not limited to turn-by-turn navigational services.*

### *To start Wayfinder Navigator*

- From standby select [Menu](#) > [Location services](#) > [Navigation](#).

## More GPS features

### **Save locations**

All saved locations are found in [My favourites](#).

### *To save your current location*

- 1 From standby select [Menu](#) > [Location services](#) > [My favourites](#) > [Add new place](#).
- 2 Select [Edit](#) and enter the title. Select [OK](#).
- 3 Scroll to [Description:](#) and select [Add](#). Enter the description and select [OK](#).
- 4 Scroll to [Position:](#) and select [Add](#) > [Current position](#).

### *To view a saved location*

- 1 From standby select [Menu](#) > [Location services](#) > [My favourites](#).
- 2 Scroll to a location and select [Go to](#).



*When you use Google Maps you can press  to access your favourites.*

### **Status information**

When your location is found you can view available satellites and get information about your current speed and altitude.

### *To view GPS status*

- 1 From standby select [Menu](#) > [Location services](#) > [Status info](#).
- 2 Scroll between the tabs.

### **Location requests**

External services may ask for your location.

### *To change permission for external services*

- 1 From standby select [Menu](#) > [Location services](#) > [Settings](#) > [Privacy](#).
- 2 Select an option.

### **Turn off the GPS**

The GPS receiver is automatically turned off when it is no longer used. You can also manually turn off the GPS receiver. This saves battery power when using features that do not require the GPS receiver to find your location.

### *To turn the GPS on or off manually*

- 1 From standby select [Menu](#) > [Location services](#) > [Settings](#).
- 2 Select an option.

# Calling

## Making and receiving calls

You need to turn on your phone and be within range of a network.

### To make a call



- 1 From standby enter a phone number (with international country code and area code, if applicable).
- 2 Press .

 You can call numbers from your contacts and call list. See *Contacts* on page 24, and *Call list* on page 28. You can also use your voice to make calls. See *Voice control* on page 29.

### To end a call

- Press .

### To make international calls

- 1 From standby press and hold down  until a “+” sign appears.
- 2 Enter the country code, area code (without the first zero) and phone number.
- 3 Press .

### To re-dial a number

- When **Retry?** appears select **Yes**.

 Do not hold your phone to your ear when waiting. When the call connects, your phone gives a loud signal.

### To answer a call

- Press .



### To reject a call

- Press .

### To change the ear speaker volume during a call

- Press the volume key up or down.

### To mute the microphone during a call

- 1 Press and hold down .
- 2 Press and hold down  again to resume.

### To turn the loudspeaker on during a call

- Select **SpkrOn**.

 Do not hold your phone to your ear when using the loudspeaker. This could damage your hearing.

### To view missed calls from standby

- Press  to open the call list.

## Networks

Your phone switches automatically between GSM and 3G (UMTS) networks depending on availability. Some network operators allow you to switch networks manually.

### *To switch networks manually*

- 1 From standby select [Menu](#) > [Settings](#) > the [Connectivity](#) tab > [Mobile networks](#) > [GSM/3G networks](#).
- 2 Select an option.

## Emergency calls

Your phone supports international emergency numbers, for example, 112 and 911. These numbers can normally be used to make emergency calls in any country, with or without the SIM card inserted, if a 3G (UMTS) or GSM network is within range.

- ! *In some countries, other emergency numbers may also be promoted. Your network operator may therefore have saved additional local emergency numbers on the SIM card.*

### *To make an emergency call*

- From standby enter 112 (the international emergency number) and press .

### *To view your local emergency numbers*

- 1 From standby select [Menu](#) > [Contacts](#).
- 2 Scroll to [New contact](#) and select [Options](#) > [Special numbers](#) > [Emergency nos.](#)

## Contacts

You can save names, phone numbers and personal information in [Contacts](#). Information can be saved in the phone memory or on the SIM card.

### Default contacts

You can choose which contact information is shown as default. If [Phone contacts](#) is selected as default, your contacts show all the information saved in [Contacts](#). If you select [SIM contacts](#) as default, your contacts show names and numbers saved on the SIM card.

### *To select default contacts*

- 1 From standby select [Menu](#) > [Contacts](#).
- 2 Scroll to [New contact](#) and select [Options](#) > [Advanced](#) > [Default contacts](#).
- 3 Select an option.



## Phone contacts

Phone contacts can contain names, phone numbers and personal information. They are saved in the phone memory.

### *To add a phone contact*



- 1 From standby select **Menu** > **Contacts**.
- 2 Scroll to **New contact** and select **Add**.
- 3 Enter the name and select **OK**.
- 4 Scroll to **New number:** and select **Add**.
- 5 Enter the number and select **OK**.
- 6 Select a number option.
- 7 Scroll between tabs and select the fields to add information.
- 8 Select **Save**.

## Calling contacts



### *To call a phone contact*

- 1 From standby select **Menu** > **Contacts**.
- 2 Scroll to a contact and press .

### *To go directly to the contacts list*

- From standby press and hold down  - .

### *To call with Smart search*

- 1 From standby press  -  to enter a contact name or a phone number. All entries which match the sequence of digits or letters are shown in a list.
- 2 Scroll to a contact or a phone number and press .

### *To turn Smart search on or off*

- 1 From standby select **Menu** > **Settings** > the **Calls** tab > **Smart search**.
- 2 Select an option.

## Editing contacts

### *To add information to a phone contact*

- 1 From standby select **Menu** > **Contacts**.
- 2 Scroll to a contact and select **Options** > **Edit contact**.
- 3 Scroll between the tabs and select **Add** or **Edit**.
- 4 Select an option and an item to add or edit.
- 5 Select **Save**.



*If your subscription supports Calling Line Identification (CLI) service, you can assign personal ringtones and pictures to contacts.*

### ***To copy names and numbers to phone contacts***

- 1 From standby select **Menu > Contacts**.
- 2 Scroll to **New contact** and select **Options > Advanced > Copy from SIM**.
- 3 Select an option.

### ***To copy names and numbers to the SIM card***

- 1 From standby select **Menu > Contacts**.
- 2 Scroll to **New contact** and select **Options > Advanced > Copy to SIM**.
- 3 Select an option.

**!** *When you copy all contacts from your phone to the SIM card, all existing SIM card information is replaced.*

### ***To automatically save names and phone numbers on the SIM card***

- 1 From standby select **Menu > Contacts**.
- 2 Scroll to **New contact** and select **Options > Advanced > Auto save on SIM**.
- 3 Select an option.

### ***To save contacts on a memory card***

- 1 From standby select **Menu > Contacts**.
- 2 Scroll to **New contact** and select **Options > Advanced > Back up to m. card**.

### **SIM contacts**

SIM contacts can contain names and numbers only. They are saved on the SIM card.

#### ***To add a SIM contact***

- 1 From standby select **Menu > Contacts**.
- 2 Scroll to **New contact** and select **Add**.
- 3 Enter the name and select **OK**.
- 4 Enter the number and select **OK**.
- 5 Select a number option and add more information, if available.
- 6 Select **Save**.

#### ***To call a SIM contact***

- 1 From standby select **Menu > Contacts**.
- 2 Scroll to a contact and press **↵**.

### **Deleting contacts**

#### ***To delete all contacts***

- 1 From standby select **Menu > Contacts**.
- 2 Scroll to **New contact** and select **Options > Advanced > Delete all contacts**.
- 3 Select an option.

### **Memory status**

The number of contacts you can save in your phone or on the SIM card depends on available memory.

### **To view memory status**

- 1 From standby select **Menu** > **Contacts**.
- 2 Scroll to **New contact** and select **Options** > **Advanced** > **Memory status**.

### **Synchronizing contacts**

The Sony Ericsson PC Suite is designed to work with the following programs:

- Windows Contact (Vista Contacts Manager)
  - Windows Calendar (Vista Calendar)
  - Microsoft Outlook 2007
  - Microsoft Outlook 2003
  - Microsoft Outlook 2002
  - Microsoft Outlook 2000
  - Lotus Notes™ 7
  - Lotus Notes 6.5
  - Lotus Notes 6
  - Lotus Notes 5
  - Windows Address Book (Outlook Express)
  - Sony Ericsson PC Suite proprietary contact & calendar manager.
- For more information see *Synchronizing* on page 56.

### **Myself**

You can enter information about yourself and, for example, send your business card.

### **To enter Myself information**

- 1 From standby select **Menu** > **Contacts**.
- 2 Scroll to **Myself** and select **Open**.
- 3 Scroll to an option and edit the information.
- 4 Select **Save**.

### **To add your own business card**

- 1 From standby select **Menu** > **Contacts**.
- 2 Scroll to **Myself** and select **Open**.
- 3 Scroll to **My contact info** and select **Add** > **Create new**.
- 4 Scroll between tabs and select the fields to add information.
- 5 Enter the information and select **Save**.

### **Groups**

You can create a group of phone numbers and email addresses from **Phone contacts** to send messages to. See *Messaging* on page 34. You can also use groups (with phone numbers) when you create accepted callers lists. See *Accept calls* on page 32.

### **To create a group of numbers and email addresses**



- 1 From standby select **Menu** > **Contacts**.
- 2 Scroll to **New contact** and select **Options** > **Groups**.
- 3 Scroll to **New group** and select **Add**.

- 4 Enter a name for the group and select **Continue**.
- 5 Scroll to **New** and select **Add**.
- 6 For each contact phone number or email address you want to mark, scroll to it and select **Mark**.
- 7 Select **Continue** > **Done**.

## Call list

You can view information about recent calls.

### *To call a number from the call list*

- 1 From standby press  and scroll to a tab.
- 2 Scroll to a name or a number and press .

### *To add a call list number to contacts*

- 1 From standby press  and scroll to a tab.
- 2 Scroll to the number and select **Save**.
- 3 Select **New contact** to create a new contact or select an existing contact to add the number to.

## Speed dial

Speed dialing lets you select nine contacts that you can dial quickly. The contacts can be saved in positions 1-9.

### *To add contacts to speed dial numbers*

- 1 From standby select **Menu** > **Contacts**.
- 2 Scroll to **New contact** and select **Options** > **Speed dial**.
- 3 Scroll to a position number and select **Add**.
- 4 Select a contact.

### *To speed dial*

- From standby enter the position number and press .



## Voicemail

If your subscription includes an answering service, callers can leave a voicemail message when you cannot answer a call.

### *To enter your voicemail number*

- 1 From standby select **Menu** > **Messaging** > **Settings** > **Voicemail number**.
- 2 Enter the number and select **OK**.

### *To call your voicemail service*

- From standby press and hold down .

## Voice control

By creating voice commands you can:

- Voice dial – call someone by saying their name
- Answer and reject calls when you use a handsfree

### *To record a voice command using voice dialling*

- 1 From standby select **Menu > Settings > the General tab > Voice control > Voice dialling > Activate**.
- 2 Select **Yes > New voice command** and select a contact. If the contact has more than one number, select the number to add the voice command to.
- 3 Record a voice command such as “John mobile”.
- 4 Follow the instructions that appear. Wait for the tone and say the command to record. The voice command is played back to you.
- 5 If the recording sounds OK, select **Yes**. If not, select **No** and repeat steps 3 and 4.

! *Voice commands are saved in the phone memory only. They cannot be used in another phone.*

## Voice dialling

You can hear your recorded contact name when you receive a call from that contact.

### *To voice dial*

- 1 From standby press and hold down a volume key.
- 2 Wait for the tone and say a recorded name, for example “John mobile”. The name is played back to you and the call is connected.

## Voice answering

When you use a handsfree, you can answer or reject incoming calls with your voice.

### *To activate voice answering and record voice answer commands*

- 1 From standby select **Menu > Settings > the General tab > Voice control > Voice answer > Activate**.
- 2 Follow the instructions that appear and select **Cont**. Wait for the tone and say “Answer”, or another word.
- 3 Select **Yes** to accept or **No** for a new recording.
- 4 Follow the instructions that appear and select **Cont**. Wait for the tone and say “Busy”, or another word.
- 5 Select **Yes** to accept or **No** for a new recording.

- 6 Follow the instructions that appear and select [Cont.](#)
- 7 Select where your voice answering is to be activated.

#### **To answer a call using voice commands**

- Say “Answer”.

#### **To reject a call using voice commands**

- Say “Busy”.

### **Diverting calls**

You can divert calls, for example, to an answering service.

- ! *When [Restrict calls](#) is used, some divert call options are not available. See [Restricted dialling on page 32](#).*

#### **To divert calls**

- 1 From standby select [Menu](#) > [Settings](#) > the [Calls](#) tab > [Divert calls](#).
- 2 Select a call type and a divert option.
- 3 Select [Activate](#).
- 4 Enter the number to divert calls to and select [OK](#).

### **More than one call**

You can handle more than one call at a time. For example, you can put an ongoing call on hold, while you make or answer a second call. You can also switch between the two calls. You cannot answer a third call without ending one of the first two calls.

#### **Call waiting**

When call waiting is used, you hear continuous beep if you receive a second call.

#### **To activate call waiting**

- From standby select [Menu](#) > [Settings](#) > the [Calls](#) tab > [Manage calls](#) > [Call waiting](#) > [Activate](#).

#### **To make a second call**

- 1 During the call, select [Options](#) > [Hold call](#). This puts the ongoing call on hold.
- 2 Select [Options](#) > [Add call](#).
- 3 Enter the number to call and press .

#### **To answer a second call**

- During the call, press . This puts the ongoing call on hold.

#### **To reject a second call**

- During the call, press  and continue with the ongoing call.

### *To end an ongoing call and answer a second call*

- During the call, select [Replace active call](#).

### **Handling two voice calls**

You can have calls ongoing and on hold at the same time.

### *To switch between two calls*

- During the call, press .

### *To join two calls*

- During the call, select [Options > Join calls](#).



### *To connect two calls*

- During the call, select [Options > Transfer call](#). You are disconnected from both calls.

### *To end an ongoing call and return to the call on hold*

- First press  and then .



### **Conference calls**

With a conference call, you can have a joint conversation with up to five people.

### *To add a new participant*

- 1 During the call, select [Options > Hold call](#). This puts the joined calls on hold.
- 2 Select [Options > Add call](#).
- 3 Enter the number to call and press .
- 4 Select [Options > Join calls](#) to add the new participant.
- 5 Repeat this task to add more participants.

### *To release a participant*

- 1 Select [Options > Release party](#).
- 2 Select the participant to release.

### *To have a private conversation*

- 1 During the call, select [Options > Talk to](#) and select the participant to talk to.
- 2 To resume the conference call, select [Options > Join calls](#).

### **My numbers**

You can view, add and edit your own phone numbers.

### *To check your phone numbers*

- 1 From standby select [Menu > Contacts](#).
- 2 Scroll to [New contact](#) and select [Options > Special numbers > My numbers](#).
- 3 Select an option.

## Accept calls

You can choose to receive calls from certain phone numbers only.

### *To add numbers to the accepted callers list*

- 1 From standby select **Menu** > **Settings** > the **Calls** tab > **Manage calls** > **Accept calls** > **Only from list**.
- 2 Scroll to **New** and select **Add**.
- 3 Select a contact or **Groups**.

 See *Groups* on page 27.

### *To accept all calls*

- From standby select **Menu** > **Settings** > the **Calls** tab > **Manage calls** > **Accept calls** > **All callers**.



## Restricted dialling

You can restrict outgoing and incoming calls. A password from your service provider is required.



*If you divert incoming calls, you cannot use some restrict calls options.*

## Restrict calls options

Standard options are:

- **All outgoing** – all outgoing calls
- **Outgoing intl** – all outgoing international calls
- **Outgoing intl roam.** – all outgoing international calls except to your home country
- **All incoming** – all incoming calls
- **Inc. when roaming** – all incoming calls when you are abroad

### *To restrict calls*

- 1 From standby select **Menu** > **Settings** > the **Calls** tab > **Manage calls** > **Restrict calls**.
- 2 Select an option.
- 3 Select **Activate**.
- 4 Enter your password and select **OK**.



## Fixed dialling

Fixed dialling allows calls to be made only to certain numbers saved on the SIM card. The fixed numbers are protected by your PIN2.

Partial numbers can be saved. For example, saving 0123456 allows calls to be made to all numbers starting with 0123456.



- ! When fixed dialling is used, you cannot view or manage any phone numbers saved on the SIM card, but you can still call the international emergency number, 112.

### **To use fixed dialling**

- 1 From standby select **Menu** > **Contacts**.
- 2 Scroll to **New contact** and select **Options** > **Special numbers** > **Fixed dialling** > **Activate**.
- 3 Enter your PIN2 and select **OK**.
- 4 Select **OK** again to confirm.

### **To save a fixed number**

- 1 From standby select **Menu** > **Contacts**.
- 2 Scroll to **New contact** and select **Options** > **Special numbers** > **Fixed dialling** > **Fixed numbers** > **New number**.
- 3 Enter the information and select **Save**.



## **Call time and cost**

During a call, the duration of the call is shown. You can check the duration of your last call, outgoing calls and the total time of your calls.

### **To check the call time**

- From standby select **Menu** > **Settings** > the **Calls** tab > **Time & cost** > **Call timers**.



## **Showing or hiding your phone number**

You can decide to show or hide your phone number when you make a call.

### **To hide your phone number**

- 1 From standby select **Menu** > **Settings** > the **Calls** tab > **Show/hide my no.**
- 2 Select **Hide number**.

# Messaging

## Receiving and saving messages

You are notified when you receive a message. Messages are automatically saved in the phone memory. When the phone memory is full, you can delete messages or save them on a memory card or on the SIM card.

### *To save a message on a memory card*

- From standby select **Menu** > **Messaging** > **Settings** > **General** > **Save to** > **Memory card**.

### *To save a message on the SIM card*

- 1 From standby select **Menu** > **Messaging** and select a folder.
- 2 Scroll to a message and select **Options** > **Save message**.

### *To view a message from the inbox*

- 1 From standby select **Menu** > **Messaging** > **Inbox**.
- 2 Scroll to the message and select **View**.

## Text messages

Text messages can contain simple pictures, sound effects, animations, and melodies.

## Before you use messaging

You must have a service centre number. The number is supplied by your service provider and is usually saved on the SIM card. If the number to your service centre is not saved on your SIM card, you must enter the number yourself.

### *To enter a service centre number*

- 1 From standby select **Menu** > **Messaging** > **Settings** > **Text message** and scroll to **Service centre**. The number is shown if it is saved on the SIM card.
- 2 If there is no number shown, select **Edit**.
- 3 Scroll to **New ServiceCentre** and select **Add**.
- 4 Enter the number, including the international “+” sign and country code.
- 5 Select **Save**.

### *To write and send a text message*

- 1 From standby select **Menu** > **Messaging** > **Write new** > **Text message**.
- 2 Write the message and select **Continue** > **Contacts look-up**.
- 3 Select a recipient and select **Send**.

! If you send a text message to a group, you will be charged for each member. See *Groups on page 27*.

### ***To copy and paste text in a text message***

- 1 When you write the message, select **Options > Copy & paste**.
- 2 Select **Copy all** or **Mark & copy**. Scroll to and mark text in the message.
- 3 Select **Options > Copy & paste > Paste**.

### ***To add an item to a text message***

- 1 When you write the message, select **Options > Add item**.
- 2 Select an option and then an item.

### ***To call a number in a text message***

- When you view the message, scroll to the phone number and press .

### ***To turn long messages on***

- 1 From standby select **Menu > Messaging > Settings > Text message**.
- 2 Select **Max. msg length > Max. available**.

## **Picture messages**

Picture messages can contain text, pictures, slides, sound recordings, video clips, signatures and attachments. You can send picture messages to a mobile phone or an email address.

### **Before you use picture messaging**

You must set an MMS profile and the address of your message server. If no MMS profile or message server exists, you can receive all the settings automatically from your network operator or at [www.sonyericsson.com/support](http://www.sonyericsson.com/support).



### ***To select an MMS profile***

- 1 From standby select **Menu > Messaging > Settings > Picture message > MMS profile**.
- 2 Select a profile.

### ***To set the message server address***

- 1 From standby select **Menu > Messaging > Settings > Picture message**.
- 2 Scroll to **MMS profile** and select **Edit**.
- 3 Select **Options > Edit**.
- 4 Scroll to **Message server** and select **Edit**.
- 5 Enter the address and select **OK > Save**.

### ***To create and send a picture message***

- 1 From standby select **Menu > Messaging > Write new > Picture msg**.
- 2 Enter text. To add items to the message, press , scroll  and select an item.
- 3 Select **Cont. > Contacts look-up**.
- 4 Select a recipient and select **Send**.

## Receiving picture messages

You can select how to download your picture messages. Standard options when you download picture messages are:

- **Always** – automatic download.
- **Ask in roaming** – ask to download when not in home network.
- **Not in roaming** – do not download when not in home network.
- **Always ask** – ask to download.
- **Off** – new messages appear in the **Inbox**.

### *To set automatic download*

- 1 From standby select **Menu** > **Messaging** > **Settings** > **Picture message** > **Auto download**.
- 2 Select an option.

## Message options

You can set standard options for all messages or choose specific settings each time you send a message.

### *To set text message options*

- 1 From standby select **Menu** > **Messaging** > **Settings** > **Text message**.
- 2 Scroll to an option and select **Edit**.

### *To set picture message options*

- 1 From standby select **Menu** > **Messaging** > **Settings** > **Picture message**.
- 2 Scroll to an option and select **Edit**.

### *To set message options for a specific message*

- 1 When the message is ready and a recipient is selected, select **Options** > **Advanced**.
- 2 Scroll to an option and select **Edit**.



## Templates

If you often use the same phrases and pictures in a message, you can save the message as a template.

### *To add a text message template*

- 1 From standby select **Menu** > **Messaging** > **Templates** > **New template** > **Text**.
- 2 Insert text or select **Options** to add items. Select **OK**.
- 3 Enter a title and select **OK**.

### *To add a picture message template*

- 1 From standby select **Menu** > **Messaging** > **Templates** > **New template** > **Picture msg**.
- 2 Enter text. To add items to the message, press , scroll  and select an item.
- 3 Select **Save**, enter a title and select **OK**.

### **To save a message as a template**

- 1 From standby select **Menu** > **Messaging** > **Inbox**.
- 2 Scroll to the message and select **View** > **Options** > **Save as template**.



### **Voice messages**

You can send and receive a sound recording as a voice message.



*The sender and recipient must have a subscription supporting picture messaging.*

### **To record and send a voice message**

- 1 From standby select **Menu** > **Messaging** > **Write new** > **Voice message**.
- 2 Record the message and select **Stop** > **Send** > **Contacts look-up**.
- 3 Select a recipient and select **Send**.



### **Email**

You can use standard email functions and your computer email address in your phone.

#### **Before you use email**

You can use the setup wizard to check if settings are available for your email account or you can enter them manually. You can also receive settings at [www.sonyericsson.com/support](http://www.sonyericsson.com/support).

### **To create an email account**

- 1 From standby select **Menu** > **Messaging** > **Email** > **Accounts**.
- 2 Scroll to **New account** and select **Add**.



*If you enter settings manually, you can contact your email provider for more information. An email provider could be the company that supplied your email address.*

### **To write and send an email message**

- 1 From standby select **Menu** > **Messaging** > **Email** > **Write new**.
- 2 Select **Add** > **Enter email address**. Enter the email address and select **OK**.
- 3 To add more recipients, scroll to **To:** and select **Edit**.
- 4 Scroll to an option and select **Add** > **Enter email address**. Enter the email address and select **OK**. When you are ready, select **Done**.
- 5 Select **Edit** and enter a subject. Select **OK**.
- 6 Select **Edit** and enter the text. Select **OK**.
- 7 Select **Add** and choose a file to attach.
- 8 Select **Cont.** > **Send**.

### ***To receive and read an email message***

- 1 From standby select **Menu** > **Messaging** > **Email** > **Inbox** > **Options** > **Check new email**.
- 2 Scroll to the message and select **View**.

### ***To save an email message***

- 1 From standby select **Menu** > **Messaging** > **Email** > **Inbox**.
- 2 Scroll to the message and select **View** > **Options** > **Save message**.

### ***To reply to an email message***

- 1 From standby select **Menu** > **Messaging** > **Email** > **Inbox**.
- 2 Scroll to the message and select **Options** > **Reply**.
- 3 Write the reply and select **OK**.
- 4 Select **Cont.** > **Send**.

### ***To view an attachment in an email message***

- When you view the message, select **Options** > **Attachments** > **Use** > **View**.

### ***To save an attachment in an email message***

- When you view the message, select **Options** > **Attachments** > **Use** > **Save**.

### **Synchronizing email**

Email can be synchronized with a Microsoft Exchange Server (Microsoft® Outlook®). For more information see *Synchronizing* on page 56.

### **Active email account**

If you have several email accounts, you can change which one is active.

### ***To change the active email account***

- 1 From standby select **Menu** > **Messaging** > **Email** > **Accounts**.
- 2 Select an account.

### **Push email**

You can receive notification in your phone from your email server that you have new email messages.

### ***To turn on push email notification***

- From standby select **Menu** > **Messaging** > **Email** > **Settings** > **Push email**.

## My friends

You can connect and log in to the My friends server to communicate online with chat messages.

### Before you use My friends

If no settings exist in your phone, you need to enter server settings. Your service provider can provide standard settings information such as:

- Username
- Password
- Server address
- Internet profile

### To enter My friends server settings

- 1 From standby select **Menu** > **Messaging** > **My friends** > **Configure**.
- 2 Scroll to a setting and select **Add**.

### To log in to the My friends server

- From standby select **Menu** > **Messaging** > **My friends** > **Log in**.

### To log out of the My friends server

- Select **Options** > **Log out**.

### To add a chat contact

- 1 From standby select **Menu** > **Messaging** > **My friends** > the **Contacts** tab.
- 2 Select **Options** > **Add contact**.

### To send a chat message

- 1 From standby select **Menu** > **Messaging** > **My friends** > the **Contacts** tab.
- 2 Scroll to a contact and select **Chat**.
- 3 Write the message and select **Send**.

### Status

You can show your status, for example, **Happy** or **Busy**, to your contacts only. You can also show your status to all users on the My friends server.

### To show my status

- 1 From standby select **Menu** > **Messaging** > **My friends** > **Options** > **Settings** > **Show my status**.
- 2 Select an option.

### To update your own status

- 1 From standby select **Menu** > **Messaging** > **My friends** > the **My status** tab.
- 2 Edit the information.
- 3 Select **Options** > **Save**.

### Chat group

A chat group can be started by your service provider, by an individual My friends user or by yourself. You can save chat groups by saving a chat invitation or by searching for a specific chat group.

### **To create a chat group**

- 1 From standby select **Menu** > **Messaging** > **My friends** > the **Chat groups** tab.
- 2 Select **Options** > **Add chat group** > **New chat group**.
- 3 Select who to invite from your contacts list and select **Cont.**
- 4 Enter a short invitation text and select **Cont.** > **Send**.

### **To add a chat group**

- 1 From standby select **Menu** > **Messaging** > **My friends** > the **Chat groups** tab > **Options** > **Add chat group**.
- 2 Select an option.

- ! *Conversation history is saved between log out and when you log in again to let you return to chat messages from previous conversations.*

### **To save a conversation**

- 1 From standby select **Menu** > **Messaging** > **My friends** > the **Conversations** tab.
- 2 Enter a conversation.
- 3 Select **Options** > **Advanced** > **Save conversation**.



## **Area and cell information**

Area and cell information are text messages, for example, local traffic reports that are sent to subscribers within a certain network area.

### **To turn area information on**

- 1 From standby select **Menu** > **Messaging** > **Settings** > **Area info**.
- 2 Scroll to **Reception** and select **Edit** > **On**.



# Imaging

## Camera and video recorder

You can take pictures and record video clips to view, save or send. You find your saved pictures and video clips in [Media > Photo > Camera album](#) and [File manager](#).

### Viewfinder and camera keys

- 
- |   |                            |
|---|----------------------------|
| 1 | Adjust brightness          |
| 2 | Take pictures/Record video |
- 



## Using the camera

### To activate the camera

- From standby select [Menu > Camera](#).

### To take a picture

- Activate the camera and press or to scroll to .
- Press the centre navigation key to take a picture.
- The picture is saved on the memory card, if a memory card is inserted. If not, the picture is saved in the phone memory.

Do not record with a strong light source in the background. Use a support or the self-timer to avoid a blurred picture.

### To record a video clip

- Activate the camera and press or to scroll to .
- Press the centre navigation key to start recording.

### To stop recording

- Press the centre navigation key.
- The video clip is saved on the memory card, if a memory card is inserted. If not, the video clip is saved in the phone memory.

### To use zoom

- Press  or  to zoom in or out.

- ! When taking a picture, zoom is available in VGA mode only.



### To adjust brightness

- Press the volume key up or down.

### To view pictures and video clips

- 1 Activate the camera.
- 2 Select [Options](#) > [View all pictures](#).
- 3 To view a video clip, press the centre navigation key.

### To improve a picture with Photo fix

- 1 Activate the camera and press  or  to scroll to .
- 2 Make sure [Review](#) is set to [On](#). Select [Options](#) and scroll to [Review](#) > [On](#).
- 3 Take a picture.
- 4 During review, select [Options](#) > [Photo fix](#).

- ! You can also use [Photo fix](#) on pictures taken previously. When viewing a picture, select [Options](#) > [Photo fix](#).

## Camera icons and settings

Icons on the screen inform what the current setting is. More camera settings are available in [Options](#).

- ! Use [Photo mate](#) to learn about camera functions. [Photo mate](#) is an interactive tutorial, included in your phone.

### To change settings

- Activate the camera and select [Options](#).





### Information

Additional information about settings is available when [Info](#) appears.

### To view information about settings

- Scroll to a setting and select .

### Camera shortcuts

Key	Shortcut
	Camera: <a href="#">Shoot mode</a> Video: <a href="#">Video length</a>
	<a href="#">Night mode</a>
	Self timer
	Camera key guide
	Camera: <a href="#">Flash</a> Video: <a href="#">AF light</a>

## Transferring pictures

### Transfer to and from your computer

You can use Bluetooth™ wireless technology and a USB cable to transfer pictures and video clips between your computer and phone. See *Bluetooth™ wireless technology* on page 53 and *Transferring content to and from a computer* on page 46 for more information.

You can view, enhance and organize your pictures and video clips on your computer by installing the *Adobe™ Photoshop™ Album Starter Edition*. It is available for download at [www.sonyericsson.com/support](http://www.sonyericsson.com/support).

### Picture and video blog

A blog is a personal Web page. If your subscription supports this service, you can send pictures or video clips to a blog.

 *Web services may require a separate license agreement between you and the service provider. Additional regulations and charges may apply. Contact your service provider.*

### To send camera pictures to a blog

- 1 From standby select **Menu** > **Media** and scroll to **Photo** > **Camera album**.

- 2 Scroll to a month and a picture. Select **View**.
- 3 Select **Options** > **Send** > **To blog**.
- 4 Enter a title and text and select **OK**.
- 5 Select **Publish**.

### To send video clips to a blog

- 1 From standby select **Menu** > **Media** and scroll to **Video**.
- 2 Scroll to a video clip.
- 3 Select **Options** > **Send** > **To blog**.
- 4 Enter a title and text and select **OK**.
- 5 Select **Publish**.

### To go to a blog address from contacts

- 1 From standby select **Menu** > **Contacts**.
- 2 Scroll to a contact and select a Web address.
- 3 Select **Go to**.

## Camera printing

You can print camera pictures using a USB cable connected to a compatible printer.

 You can also print using a Bluetooth compatible printer.

### ***To print camera pictures using a USB cable***

- 1 From standby select [Menu](#) > [Media](#) and scroll to [Photo](#) > [Camera album](#).
- 2 Scroll to a month and a picture.
- 3 Select [Options](#) > [Print](#).
- 4 Select an option.
- 5 Connect the USB cable to the phone.
- 6 Connect the USB cable to the printer.
- 7 Wait for feedback in the phone and select [OK](#).
- 8 Enter printer settings, if required and select [Print](#).

 You should disconnect and re-connect the USB cable if there is a printer error.

## **Pictures**

You can view and tag your pictures in [Media](#).

### ***To view pictures in a slide show***

- 1 From standby select [Menu](#) > [Media](#) and scroll to [Photo](#) > [Camera album](#).
- 2 Scroll to a month and a picture. Select [View](#).
- 3 Select [Options](#) > [Slide show](#).
- 4 Select a mood.

### **Viewing pictures on a map**

Location data  is included when you take pictures with the camera. This allows you to view the approximate location of where a picture was taken.

### ***To view pictures on a map***

- 1 From standby select [Menu](#) > [Media](#) and scroll to [Photo](#) > [Camera album](#).
- 2 Scroll to a month and a picture. Select [View](#).
- 3 Select [Options](#) > [View on map](#).



### ***To turn off location data for pictures***

- From standby select [Menu](#) > [Camera](#) >  > [Positioning](#) > [Off](#).

### **Photo tags**

You can tag pictures to categorize them. They are saved in [Photo tags](#).

### ***To tag pictures***

- 1 From standby select [Menu](#) > [Media](#) and scroll to [Photo](#) > [Camera album](#).
- 2 Scroll to a month and a picture. Select [View](#).
- 3 Press  and scroll to a tag.
- 4 Press the centre navigation key.
- 5 For each picture you want to tag, use  or  to scroll to the picture and press the centre navigation key.

### *To create a new photo tag*

- 1 From standby select **Menu** > **Media** and scroll to **Photo** > **Camera album**.
- 2 Scroll to a month and a picture. Select **View**.
- 3 Press **Ⓞ** and select **Options** > **New tag**.
- 4 Enter a name and select **OK**.
- 5 Select an icon.
- 6 Press the centre navigation key to tag the picture.

### *Using pictures*

You can add a picture to a contact, use it during phone startup, as a wallpaper in standby or as a screen saver.

### *To use pictures*

- 1 From standby select **Menu** > **Media** and scroll to **Photo** > **Camera album**.
- 2 Scroll to a month and a picture. Select **View**.
- 3 Select **Options** > **Use as**.
- 4 Select an option.

## **PhotoDJ™ and VideoDJ™**

You can edit pictures and video clips.

### *To edit and save a picture*

- 1 From standby select **Menu** > **Media** and scroll to **Photo** > **Camera album**.
- 2 Scroll to a month and a picture. Select **View**.
- 3 Select **Options** > **Edit in PhotoDJ™**.
- 4 Edit the picture.
- 5 Select **Options** > **Save picture**.

### *To edit and save a video clip*

- 1 From standby select **Menu** > **Organizer** > **File manager** > **Videos**.
- 2 Scroll to a video clip and select **Options** > **VideoDJ™**.
- 3 Edit the video clip.
- 4 Select **Options** > **Save**.

### *To trim a video clip*

- 1 From standby select **Menu** > **Organizer** > **File manager** > **Videos**.
- 2 Scroll to a video clip and select **Options** > **VideoDJ™** > **Edit** > **Trim**.
- 3 Select **Set** to set the starting point and select **Start**.
- 4 Select **Set** to set the ending point and select **End**.
- 5 Select **Trim** > **Options** > **Save**.

## Media player and music

You can listen to music, audio books and podcasts. Use *Sony Ericsson Media Manager* to transfer content to your phone.

- ! *Sony Ericsson Media Manager software is available for download at [www.sonyericsson.com/support](http://www.sonyericsson.com/support).*

### Transferring content to and from a computer

#### Required operating systems

You need one of these operating systems to use the software:

- Microsoft® Windows Vista™ 32 bit and 64 bit versions of: Ultimate, Enterprise, Business, Home Premium, Home Basic
- Microsoft® Windows XP (Pro or Home), Service Pack 2 or higher

#### *To transfer content using Media Manager*

- 1 Connect the phone to a computer with a USB cable supported by your phone.
- 2 **Computer:** *Start/Programs/Sony Ericsson/Media Manager.*

- 3 **Phone:** Select [Media transfer](#).

! *Do not remove the USB cable from your phone or computer during transfer, as this may corrupt the memory card or the phone memory.*

- 4 **Computer:** Wait until the phone appears in Media Manager.
- 5 Move files between your phone and the computer in Media Manager.

💡 *For details on transferring music, refer to [Media Manager Help](#). Click (?) in the top right corner of the Media Manager window.*

### Stereo portable handsfree

#### *To use a handsfree*

- Connect a portable handsfree. Music stops when you receive a call and resumes when the call has ended.

## Music player

### *To play music*

- 1 From standby select **Menu > Media > Music**.
- 2 Scroll to a title and select **Play**.

### *To stop playing music*

- Press the centre navigation key.

### *To fast forward and rewind*

- Press and hold down **⏩** or **⏪**.

### *To move between tracks*

- Press **⏴** or **⏵**.

### *To change the volume*

- Press the volume keys up or down.

### Browsing files

Music is saved and categorized.

- **Artists** – list music by artist.
- **Albums** – list music by album.
- **Tracks** – list all music tracks.
- **Playlists** – create own lists of tracks.
- **Audio books** – list audio books you have transferred from your computer.
- **Podcasts** – list all podcasts.

### Playlists

You can create playlists to organize music files. Files can be added to more than one playlist.

Deleting a playlist, or a file from a playlist, does not delete the file from the memory, just the reference to the file.

### *To create a playlist*

- 1 From standby select **Menu > Media** and scroll to **Music > Playlists**.
- 2 Scroll to **New playlist** and select **Add**.
- 3 Enter a name and select **OK**.
- 4 For each track you want to add, scroll to the track and select **Mark**.
- 5 Select **Add** to add the tracks to the playlist.

### *To add files to a playlist*

- 1 From standby select **Menu > Media** and scroll to **Music > Playlists**.
- 2 Select a playlist.
- 3 Scroll to **Add music** and select **Add**.
- 4 For each track you want to add, scroll to the track and select **Mark**.
- 5 Select **Add** to add the tracks to the playlist.

### **To remove tracks from a playlist**

- 1 From standby select [Menu](#) > [Media](#) and scroll to [Music](#) > [Playlists](#).
- 2 Select a playlist.
- 3 Scroll to the track and press [C](#).

### **To view information about a track**

- Scroll to a track and select [Options](#) > [Information](#).

### **Audio books**

You can listen to audio books that you have transferred to your phone from a computer using Media Manager.

- ! *It may take a few minutes before a transferred audio book appears in the list of available audio books.*

### **To play audio books**

- 1 From standby select [Menu](#) > [Media](#) > [Music](#) > [Audio books](#).
- 2 Select an audio book.
- 3 Scroll to a chapter and select [Play](#).

- ! *Audio books in other formats than M4B or audio books that do not have ID3v2 chapter tags can be found in the [Tracks](#) folder.*

## **PlayNow™**

You can connect to PlayNow™ to download ringtones, games, music, themes and wallpapers. You can preview or listen to content before you purchase and download it to your phone.

- ! *This service is not available in all countries.*

### **Before you use PlayNow™**

You must have the required Internet connection settings in your phone. See [Settings](#) on page 52.

### **To use PlayNow™**

- 1 From standby select [Menu](#) > [PlayNow™](#).
- 2 Scroll the PlayNow™ Web site and follow the instructions to preview and purchase content.

## **TrackID™**

TrackID™ is a music recognition service. You can search for song titles, artists and album names.

- ! *For cost information contact your service provider.*



### *To search for song information*

- When you hear a song through a loudspeaker, from standby select **Menu** > **Entertainment** > **TrackID™** > **Start**.
- When the radio is playing select **Options** > **TrackID™**.

### **Online music and video clips**

You can view video clips and listen to music by streaming them to your phone from the Internet. If settings are not already in your phone, see *Settings* on page 52. For more information, contact your network operator or go to [www.sonyericsson.com/support](http://www.sonyericsson.com/support).

### *To select a data account for streaming*

- 1 From standby select **Menu** > **Settings** > the **Connectivity** tab > **Streaming settings** > **Connect using**..
- 2 Select the data account to use.
- 3 Select **Save**.

### *To stream music and video clips*

- 1 From standby select **Menu** > **Internet**.
- 2 Select **Options** > **Go to** > **Bookmarks**.
- 3 Select a link to stream from.

## **Entertainment**

### **Video player**

#### *To play videos*

- 1 From standby select **Menu** > **Media** and scroll to **Video**.
- 2 Scroll to a title and select **Play**.

#### *To stop playing videos*

- Press the centre navigation key.

### **Radio**

- ! Do not use your phone as a radio in places where this is prohibited.

#### *To listen to the radio*

- 1 Connect a handsfree to the phone.
- 2 From standby select **Menu** > **Radio**.

#### *To change the volume*

- When the radio is playing, press the volume keys up or down.

#### *To automatically search for channels*

- When the radio is playing, select **Search**.

#### *To manually search for channels*

- When the radio is playing, press **⏪** or **⏩**.

## Saving channels

You can save up to 20 preset channels.



### To save channels

- 1 When you have found a radio channel select **Options** > **Save**.
- 2 Scroll to a position and select **Insert**.

### To select saved channels

- 1 From standby select **Menu** > **Radio** > **Options** > **Channels**.
- 2 Select a radio channel.

### To switch between saved channels



- When the radio is playing, press  or .

## Ringtones and melodies

### To set a ringtone

- 1 From standby select **Menu** > **Settings** > the **Sounds & alerts** tab > **Ringtone**.
- 2 Find and select a ringtone.

### To set the ringtone volume

- 1 From standby select **Menu** > **Settings** > the **Sounds & alerts** tab > **Ring volume**.
- 2 Press  or  to change the volume.
- 3 Select **Save**.

### To turn the ringtone off

- From standby press and hold down .

- ! All signals except the alarm signal are affected.





### To set the vibrating alert

- 1 From standby select **Menu** > **Settings** > the **Sounds & alerts** tab > **Vibrating alert**.
- 2 Select an option.

## MusicDJ™

You can compose and edit your own melodies to use as ringtones. A melody consists of four types of tracks – **Drums**, **Basses**, **Chords**, and **Accents**. A track contains a number of music blocks. The blocks consist of pre-arranged sounds with different characteristics. The blocks are grouped into **Intro**, **Verse**, **Chorus**, and **Break**. You compose a melody by adding music blocks to the tracks.

### To compose a melody

- 1 From standby select **Menu** > **Entertainment** > **MusicDJ™**.
- 2 Select to **Insert**, **Copy** or **Paste** blocks.
- 3 Use , ,  or  to scroll between the blocks.
- 4 Select **Options** > **Save melody**.

## Sound recorder

You can record a voice memo or a sound. Recorded sounds can also be set as ringtones.

### *To record a sound*

- From standby select [Menu](#) > [Entertainment](#) > [Record sound](#) > [Record](#).

### *To listen to a recording*

- 1 From standby select [Menu](#) > [Organizer](#) > [File manager](#).
- 2 Scroll to [Music](#) and select [Open](#).
- 3 Scroll to a recording and select [Play](#).

## Games

Your phone contains preloaded games. You can also download games. Help texts are available for most games.

### *To start a game*

- 1 From standby select [Menu](#) > [Media](#) > [Games](#).
- 2 Select a game.

### *To end a game*

- Press .

## Applications

You can download and run Java applications. You can also view information or set different permissions.

### **Before you use Java™ applications**

If settings are not already entered in your phone, see *Settings* on page 52.

### *To select a Java application*

- 1 From standby select [Menu](#) > [Organizer](#) > [Applications](#).
- 2 Select an application.

### *To view information about a Java application*

- 1 From standby select [Menu](#) > [Organizer](#) > [Applications](#).
- 2 Scroll to an application and select [Options](#) > [Information](#).

### *To set permissions for a Java application*

- 1 From standby select [Menu](#) > [Organizer](#) > [Applications](#).
- 2 Scroll to an application and select [Options](#) > [Permissions](#).
- 3 Set permissions.

## Java application screen size

Some Java applications are designed for a specific screen size. For more information, contact the application vendor.

### *To set the screen size for a Java application*

- 1 From standby select **Menu** > **Organizer** > **Applications**.
- 2 Scroll to an application and select **Options** > **Screen size**.
- 3 Select an option.

## Internet profiles for Java applications

Some Java applications need to connect to the Internet to receive information. Most Java applications use the same Internet settings as your Web browser.

# Connectivity

## Settings

Before you synchronize with an Internet service, use the Internet, PlayNow™, My friends, Java, picture messaging, email and picture blog you need to have settings in your phone.

If settings are not already entered, you can download settings using the setup wizard or by going to [www.sonyericsson.com/support](http://www.sonyericsson.com/support).

### *To download settings using the Setup wizard*

- 1 From standby select **Menu** > **Settings** > the **General** tab > **Setup wizard** > **Settings download**.
- 2 Follow the instructions that appear.



Contact your network operator or service provider for more information.

### *To download settings using a computer*

- 1 Go to [www.sonyericsson.com/support](http://www.sonyericsson.com/support).
- 2 Follow the instructions on the screen.

## Phone name

You can enter a name for your phone that is shown to other devices when using, for example, Bluetooth™ wireless technology.

### *To enter a phone name*

- 1 From standby select **Menu** > **Settings** > the **Connectivity** tab > **Phone name**.
- 2 Enter the phone name and select **OK**.

## Bluetooth™ wireless technology

The Bluetooth function makes wireless connection to other Bluetooth devices possible. You can, for example:

- Connect to handsfree devices.
- Connect to several devices at the same time.
- Connect to computers and access the Internet.
- Exchange items and play multiplayer games.



*We recommend a range within 10 metres (33 feet), with no solid objects in between, for Bluetooth communication.*

## Before you use Bluetooth wireless technology

You must turn on the Bluetooth function to communicate with other devices. You may also have to pair your phone with other Bluetooth devices.

### *To turn the Bluetooth function on*

- From standby select **Menu** > **Settings** > the **Connectivity** tab > **Bluetooth** > **Turn on**.



*Make sure that the device you want to pair your phone with has the Bluetooth function activated and Bluetooth visibility set to on.*

### *To receive an item*

- 1 From standby select **Menu** > **Settings** > the **Connectivity** tab > **Bluetooth** > **Turn on**.
- 2 When you receive an item, follow the instructions that appear.

### *To pair the phone with a device*

- 1 From standby select **Menu** > **Settings** > the **Connectivity** tab > **Bluetooth** > **My devices**.
- 2 Scroll to **New device** and select **Add** to search for available devices.
- 3 Select a device.
- 4 Enter a passcode, if required.

### ***To allow connection to the phone***

- 1 From standby select [Menu](#) > [Settings](#) > the [Connectivity](#) tab > [Bluetooth](#) > [My devices](#).
- 2 Select a device from the list.
- 3 Select [Options](#) > [Allow connection](#).
- 4 Select [Always ask](#) or [Always allow](#).

 *This is only possible with devices that require access to a secure service.*

### ***To pair the phone with a Bluetooth handsfree for the first time***

- 1 From standby select [Menu](#) > [Settings](#) > the [Connectivity](#) tab > [Bluetooth](#) > [Handsfree](#).
- 2 Scroll to a device and select [Yes](#).
- 3 Enter a passcode, if required.

### ***To pair the phone with more than one Bluetooth handsfree***

- 1 From standby select [Menu](#) > [Settings](#) > the [Connectivity](#) tab > [Bluetooth](#) > [Handsfree](#) > [My handsfree](#) > [New handsfree](#).
- 2 Select a device from the list.
- 3 Enter a passcode, if required.

### **Power saving**

You can save battery power with the Power save function. You can only connect with a single Bluetooth device. You must turn this function off if you want to connect with more than one Bluetooth device at the same time.

#### ***To turn powersave on***

- From standby select [Menu](#) > [Settings](#) > the [Connectivity](#) tab > [Bluetooth](#) > [Powersave](#) > [On](#).

#### **Transferring sound to and from a Bluetooth handsfree**

You can transfer the sound to and from a Bluetooth handsfree using a phone key or the handsfree key.

#### ***To transfer sound***

- 1 From standby select [Menu](#) > [Settings](#) > the [Connectivity](#) tab > [Bluetooth](#) > [Handsfree](#) > [Incoming call](#).
- 2 Select an option. [In phone](#) transfers sound to the phone. [In handsfree](#) transfers sound to the handsfree.

#### ***To transfer sound during a call***

- 1 During a call, select [Sound](#).
- 2 Select from the list.

## Using a USB cable

You can connect your phone to a computer with a USB cable to transfer files, synchronize and use your phone as a modem. For more information go to the Getting started section at [www.sonyericsson.com/support](http://www.sonyericsson.com/support).

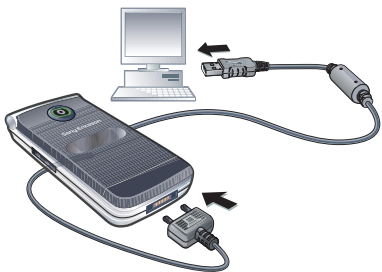

### Before you use a USB cable

See *Required operating systems* on page 46.

- ! *Only use a USB cable supported by your phone. Do not remove the USB cable from your phone or computer during file transfer as this may corrupt the phone memory or the memory card.*

### To disconnect a USB cable safely

- 1 Right-click the removable disk icon in *Windows Explorer*.
- 2 Select *Eject*.
- 3 Disconnect the USB cable when the following message is shown in the phone: **Mass storage session ended. It is now safe to remove the USB cable.**

### Drag and drop content

You can drag and drop content between your phone or memory card and a computer in *Microsoft Windows Explorer*.

### To drag and drop content

- 1 Connect your phone to a computer using the USB cable.
- 2 **Phone:** Select **Media transfer**. The phone will remain activated during file transfer.
- 3 **Computer:** Wait until an external device icon appears in *My Computer* and then double click to open. Phone memory and memory card will appear as external drives.
- 4 Drag and drop selected files between the phone and the computer.

## Synchronizing

You can synchronize in two different ways:

- You can use a USB cable or Bluetooth wireless technology to synchronize phone contacts, appointments, bookmarks, tasks and notes with a computer program such as Microsoft Outlook.
- You can synchronize with an Internet service using SyncML™ or a Microsoft® Exchange Server using Microsoft Exchange ActiveSync. For more information go to the Getting started section at [www.sonyericsson.com/support](http://www.sonyericsson.com/support).

 Use only one of the synchronization methods at a time with your phone.

### Synchronizing using a computer

Before synchronizing you need to install *the Sony Ericsson PC Suite*.

- ! *Sony Ericsson PC Suite software is available for download at [www.sonyericsson.com/support](http://www.sonyericsson.com/support).*

See *Required operating systems* on page 46.

### To synchronize using the PC Suite

- 1 **Computer:** Start *PC Suite* from *Start/Programs/Sony Ericsson/PC Suite*.
- 2 Follow the instructions in the *PC Suite* for how to connect.
- 3 **Phone:** Select [Phone mode](#).
- 4 **Computer:** When you are notified that *the Sony Ericsson PC Suite* has found your phone, you can start synchronizing.

 For usage details, see the *Sony Ericsson PC Suite Help* section once the software has been installed on your computer.

### Synchronizing using an Internet service

You can synchronize online using SyncML or Microsoft Exchange ActiveSync. If Internet settings are not in your phone, see *Settings* on page 52.

### SyncML

You can synchronize remote data and personal information using SyncML.



## Before you synchronize using SyncML

You must enter settings for SyncML synchronization and register a synchronization account online with a service provider. Settings that are required are:

- [Server address](#) – server URL
- [Database name](#) – database to synchronize with

### To enter settings for SyncML

- 1 From standby select [Menu](#) > [Organizer](#) > [Synchronization](#).
- 2 Scroll to [New account](#) and select [Add](#) > [SyncML](#).
- 3 Enter a name for the new account and select [Cont](#).
- 4 Select [Server address](#). Enter the required information and select [OK](#).
- 5 Enter [Username](#) and [Password](#), if required.
- 6 Scroll to the [Applications](#) tab and mark applications to synchronize.

- 7 Scroll to the [App. settings](#) tab and select an application.
- 8 Select [Database name](#) and enter the required information.
- 9 Scroll to the [Advanced](#) tab to enter additional settings for synchronizing and select [Save](#).

### To synchronize using SyncML

- 1 From standby select [Menu](#) > [Organizer](#) > [Synchronization](#).
- 2 Scroll to an account and select [Start](#).

### Microsoft® Exchange ActiveSync

You can access and synchronize corporate exchange information such as email, contacts and calendar entries using Microsoft® Exchange Server with Microsoft® Exchange ActiveSync.



*For more information on synchronization settings, contact your IT administrator.*

## Before you synchronize using Microsoft® Exchange ActiveSync

You must enter settings for Microsoft Exchange ActiveSync to access a Microsoft Exchange Server. Settings that are required are:

- [Server address](#) – server URL
- [Domain](#) – server domain
- [Username](#) – account username
- [Password](#) – account password

- ! *Before you start to synchronize with Exchange ActiveSync you must enter the correct time zone in your phone.*

## To enter settings for Microsoft® Exchange ActiveSync

- 1 From standby select [Menu](#) > [Organizer](#) > [Synchronization](#).
- 2 Scroll to [New account](#) and select [Add](#) > [Exchange ActiveSync](#).
- 3 Enter a name for the new account and select [Cont.](#)
- 4 Enter the required settings.
- 5 Scroll between the tabs to enter additional settings.
- 6 Select [Save](#).

## To synchronize using Microsoft® Exchange ActiveSync

- 1 From standby select [Menu](#) > [Organizer](#) > [Synchronization](#).
- 2 Scroll to an account and select [Start](#).



## Update service

You can update your phone with the latest software. You do not lose personal or phone information.

There are two ways to update your phone:

- Over the air using your phone
- Using a provided USB cable and an Internet-connected computer



*Update service requires data access such as GPRS, 3G or HSDPA.*

## Before you use the Update service

If settings are not in your phone see [Settings](#) on page 52.

## To change Internet settings

- From standby select [Menu](#) > [Settings](#) > the [General](#) tab > [Update service](#) > [Settings](#) > [Internet settings](#).

### *To view the current software in the phone*

- 1 From standby select **Menu** > **Settings** > the **General** tab > **Update service**.
- 2 Select **Software version**.

### *To use Update service using the phone*

- 1 From standby select **Menu** > **Settings** > the **General** tab > **Update service**.
- 2 Select **Search for update** and follow the instructions that appear.

### *To use Update service using a USB cable*

- 1 Go to [www.sonyericsson.com/support](http://www.sonyericsson.com/support) or click the **Sony Ericsson Update service in the PC Suite software** if installed on your computer.
- 2 Select a region and country.
- 3 Follow the instructions on the screen.

### *To set a reminder to use Update service*

- 1 From standby select **Menu** > **Settings** > the **General** tab > **Update service** > **Settings** > **Reminder**.
- 2 Select an option.

## More features

### Flight mode

In **Flight mode** the network and radio transceivers are turned off to prevent disturbance to sensitive equipment.

When the flight mode menu is activated you are asked to select a mode the next time you turn on your phone:

- **Normal mode** – full functionality
- **Flight mode** – limited functionality



You can use the Bluetooth™ function in **Flight mode**.

### *To activate the flight mode menu*

- From standby select **Menu** > **Settings** > the **General** tab > **Flight mode** > **Show at startup**.

### *To select flight mode*

- 1 When the flight mode menu is activated, turn off your phone.
- 2 Turn on your phone and select **Flight mode**.



## File manager

You can use the file manager to handle files saved in the phone memory or on a memory card.

### Handling files

You can move and copy files between your phone, a computer and a memory card. See *Transferring content to and from a computer* on page 46. Files are saved on the memory card first and then in the phone memory.

Unrecognized files are saved in the [Other](#) folder.

 *You are not allowed to exchange some copyright-protected material. A protected file has a  icon.*

You can create subfolders to move or copy files to. You can select more than one or all the files in a folder at the same time for all folders except [Games](#) and [Applications](#).

If the memory is full, delete some content to create space.

### File manager tabs

The file manager is divided into three tabs, and icons indicate where the files are saved.

#### *To view information about files*

- 1 From standby select [Menu](#) > [Organizer](#) > [File manager](#).
- 2 Find a file and select [Options](#) > [Information](#).

#### *To move a file in the file manager*

- 1 From standby select [Menu](#) > [Organizer](#) > [File manager](#).
- 2 Find a file and select [Options](#) > [Manage file](#) > [Move](#).
- 3 Select [Memory card](#) or [Phone](#).
- 4 Open a folder.
- 5 Select [Paste](#).

#### *To select more than one file in a folder*

- 1 From standby select [Menu](#) > [Organizer](#) > [File manager](#).
- 2 Scroll to a folder and select [Open](#).
- 3 Select [Options](#) > [Mark](#) > [Mark several](#).
- 4 For each file you want to mark, scroll to the file and select [Mark](#).

## Alarms

You can set a sound or the radio as an alarm signal. The alarm sounds even if the phone is turned off. When the alarm sounds you can silence it or turn it off.

### *To set the alarm*

- 1 From standby select [Menu](#) > [Alarms](#).
- 2 Scroll to an alarm and select [Edit](#).
- 3 Scroll to [Time](#): and select [Edit](#).
- 4 Enter a time and select [OK](#) > [Save](#).

### *To set the recurrent alarm*

- 1 From standby select [Menu](#) > [Alarms](#).
- 2 Scroll to an alarm and select [Edit](#).
- 3 Scroll to [Recurrent](#): and select [Edit](#).
- 4 Scroll to a day and select [Mark](#).
- 5 To select another day, scroll to the day and select [Mark](#).
- 6 Select [Done](#) > [Save](#).

### *To set the alarm signal*

- 1 From standby select [Menu](#) > [Alarms](#).
- 2 Scroll to an alarm and select [Edit](#).
- 3 Scroll to the  tab.
- 4 Scroll to [Alarm signal](#): and select [Edit](#).
- 5 Find and select an alarm signal. Select [Save](#).

### *To silence the alarm*

- When the alarm sounds, press any key.
- To repeat the alarm, select [Snooze](#).

### *To turn off the alarm*

- When the alarm sounds, press any key and select [Turn off](#).

### *To cancel the alarm*

- 1 From standby select [Menu](#) > [Alarms](#).
- 2 Scroll to an alarm and select [Turn off](#).

### *The alarm in silent mode*

You can set the alarm not to sound when the phone is in silent mode.

### *To set an alarm to sound or not in silent mode*

- 1 From standby select [Menu](#) > [Alarms](#).
- 2 Scroll to an alarm and select [Edit](#).
- 3 Scroll to the  tab.
- 4 Scroll to [Silent mode](#): and select [Edit](#).
- 5 Select an option.

## Calendar

The calendar can be synchronized with a computer calendar, with a calendar on the Web or with a Microsoft® Exchange Server (Microsoft® Outlook®).

For more information see *Synchronizing* on page 56.

## Default view

You can choose whether month, week or day view will appear first when you open the calendar.

### *To set default view*

- 1 From standby select **Menu** > **Organizer** > **Calendar**.
- 2 Select **Options** > **Advanced** > **Default view**.
- 3 Select an option.

## Appointments

You can add new appointments or reuse existing appointments.

### *To add an appointment*

- 1 From standby select **Menu** > **Organizer** > **Calendar**.
- 2 Select a date.
- 3 Scroll to **New appointment** and select **Add**.
- 4 Enter the information and confirm each entry.
- 5 Select **Save**.

### *To view an appointment*

- 1 From standby select **Menu** > **Organizer** > **Calendar**.
- 2 Select a date.
- 3 Scroll to an appointment and select **View**.

### *To edit an appointment*

- 1 From standby select **Menu** > **Organizer** > **Calendar**.
- 2 Select a date.
- 3 Scroll to an appointment and select **View**.
- 4 Select **Options** > **Edit**.
- 5 Edit the appointment and confirm each entry.
- 6 Select **Save**.

### *To view a calendar week*

- 1 From standby select **Menu** > **Organizer** > **Calendar**.
- 2 Select a date.
- 3 Select **Options** > **Change view to** > **Week**.

### *To set when reminders should sound*

- 1 From standby select **Menu** > **Organizer** > **Calendar**.
- 2 Select a date.
- 3 Select **Options** > **Advanced** > **Reminders**.
- 4 Select an option.

 A reminders option set in calendar affects a reminders option set in tasks.

## Notes

You can make notes and save them.  
You can also show a note in standby.

### *To add a note*

- 1 From standby select **Menu** > **Organizer** > **Notes**.
- 2 Scroll to **New note** and select **Add**.
- 3 Write a note and select **Save**.

### *To show a note in standby*

- 1 From standby select **Menu** > **Organizer** > **Notes**.
- 2 Scroll to a note and select **Options** > **Show in standby**.

### *To hide a note from standby*

- 1 From standby select **Menu** > **Organizer** > **Notes**.
- 2 Scroll to a note and select **Options** > **Hide in standby**.

## Tasks

You can add new tasks or reuse existing tasks.

### *To add a task*

- 1 From standby select **Menu** > **Organizer** > **Tasks**.
- 2 Select **New task** and select **Add**.
- 3 Select an option.
- 4 Enter details and confirm each entry.

### *To view a task*

- 1 From standby select **Menu** > **Organizer** > **Tasks**.
- 2 Scroll to a task and select **View**.

### *To set when reminders should sound*

- 1 From standby select **Menu** > **Organizer** > **Tasks**.
- 2 Scroll to a task and select **Options** > **Reminders**.
- 3 Select an option.



*A reminders option set in tasks affects a reminders option set in calendar.*

## Profiles

You can change settings such as the ring volume and vibrating alert to suit different locations. You can reset all profiles to the phone's original settings.

### *To select a profile*

- 1 From standby select **Menu** > **Settings** > the **General** tab > **Profiles**.
- 2 Select a profile.

### **To view and edit a profile**

- 1 From standby select **Menu** > **Settings** > the **General** tab > **Profiles**.
- 2 Scroll to a profile and select **Options** > **View and edit**.

 You cannot rename the Normal profile.

## **Time and date**

### **To set the time**

- 1 From standby select **Menu** > **Settings** > the **General** tab > **Time & date** > **Time**.
- 2 Enter the time and select **Save**.

### **To set the date**

- 1 From standby select **Menu** > **Settings** > the **General** tab > **Time & date** > **Date**.
- 2 Enter the date and select **Save**.

### **To set the time zone**

- 1 From standby select **Menu** > **Settings** > the **General** tab > **Time & date** > **My time zone**.
- 2 Select the time zone you are in.

 If you select a city, **My time zone** also updates the time when daylight saving time changes.

## **Theme**

You can change the appearance of the screen through items such as colours and wallpaper. You can also create new themes and download them. For more information, go to [www.sonyericsson.com/support](http://www.sonyericsson.com/support).

### **To set a theme**

- 1 From standby select **Menu** > **Settings** > the **Display** tab > **Theme**.
- 2 Scroll to a theme and select **Set**.

## **Main menu layout**

You can change the layout of the icons in the main menu.

### **To change the main menu layout**

- 1 From standby select **Menu** > **Options** > **Main menu layout**.
- 2 Select an option.



## Locks

### SIM card lock

This lock only protects your subscription. Your phone will work with a new SIM card. If the lock is on, you have to enter a PIN (Personal Identity Number).

If you enter your PIN incorrectly three times in a row, the SIM card is blocked and you need to enter your PUK (Personal Unblocking Key). Your PIN and PUK are supplied by your network operator.

#### *To unblock the SIM card*

- 1 When **PIN blocked** appears, enter your PUK and select **OK**.
- 2 Enter a new four-to-eight-digit PIN and select **OK**.
- 3 Re-enter the new PIN and select **OK**.

#### *To edit the PIN*

- 1 From standby select **Menu** > **Settings** > the **General** tab > **Security** > **Locks** > **SIM protection** > **Change PIN**.
- 2 Enter your PIN and select **OK**.
- 3 Enter a new four-to-eight-digit PIN and select **OK**.
- 4 Re-enter the new PIN and select **OK**.

- ! If **Codes do not match** appears, you entered the new PIN incorrectly.  
• If **Wrong PIN** appears, followed by **Old PIN**:, you entered your old PIN incorrectly.

#### *To use the SIM card lock*

- 1 From standby select **Menu** > **Settings** > the **General** tab > **Security** > **Locks** > **SIM protection** > **Protection**.
- 2 Select an option.
- 3 Enter your PIN and select **OK**.

### Phone lock

You can stop unauthorized use of your phone. Change the phone lock code (0000) to any four-to-eight-digit personal code.

- ! *It is important that you remember your new code. If you forget it, you have to take your phone to your local Sony Ericsson retailer.*

#### *To use the phone lock*

- 1 From standby select **Menu** > **Settings** > the **General** tab > **Security** > **Locks** > **Phone protection** > **Protection**.
- 2 Select an option.
- 3 Enter the phone lock code and select **OK**.

### *To unlock the phone*

- Enter your code and select **OK**.

### *To change the phone lock code*

- 1 From standby select **Menu** > **Settings** > the **General** tab > **Security** > **Locks** > **Phone protection** > **Change code**.
- 2 Enter the old code and select **OK**.
- 3 Enter the new code and select **OK**.
- 4 Repeat the code and select **OK**.

### **IMEI number**

Keep a copy of your IMEI (International Mobile Equipment Identity) number in case your phone is stolen.

### *To view your IMEI number*

- From standby press **(\*) 06/1/1**, **(#) 06/1/1**, **(0) +**, **(6)**, **(#) 06/1/1**.

## Troubleshooting

Some problems will require you to call your network operator.

For more support go to [www.sonyericsson.com/support](http://www.sonyericsson.com/support).

### Common questions

#### *I have problems with memory capacity or the phone is working slowly*

Restart your phone every day to free memory or do a **Master reset**.

#### **Master reset**

If you select **Reset settings**, the changes that you have made to settings will be deleted.

If you select **Reset all**, in addition to your changes to settings, all contacts, messages, personal data, and content that you have downloaded, received or edited will also be deleted.

#### *To reset the phone*

- 1 From standby select **Menu** > **Settings** > the **General** tab > **Master reset**.
- 2 Select an option.
- 3 Follow the instructions that appear.

***I cannot charge the phone or battery capacity is low***

The charger is not properly connected or the battery connection is poor. Remove the battery and clean the connectors.

The battery is worn out and needs to be replaced. See *Charging the battery* on page 8.

***No battery icon appears when I start charging the phone***

It may take a few minutes before the battery icon appears on the screen.

***Some menu options appear in grey***

A service is not activated. Contact your network operator.

***I cannot use SMS/text messages on my phone***

Settings are missing or incorrect. Contact your network operator to find out the correct SMS service centre setting. See *Text messages* on page 34.

***I cannot use picture messages on my phone***

Your subscription does not include data capability. Settings are missing or incorrect. Please contact your network operator.

See *Help in your phone* on page 8 or go to [www.sonyericsson.com/support](http://www.sonyericsson.com/support) to order settings and follow the instructions on the screen. See *Settings* on page 52.

***I cannot use the Internet***

Your subscription does not include data capability. Internet settings are missing or incorrect. Please contact your network operator.

See *Help in your phone* on page 8 or go to [www.sonyericsson.com/support](http://www.sonyericsson.com/support) to order Internet settings, and follow the instructions on the screen. See *Settings* on page 52.

***I cannot use keypad shortcuts while browsing***

Make sure your [Keypad mode](#) is set as [Shortcuts](#). See *To select Internet keypad shortcuts* on page 18.

***I have set Web feeds to show in standby, but no Web feeds appear in standby***

Check if a note is shown in standby. If so, hide it. See *To hide a note from standby* on page 63.

***The phone does not ring or rings too softly***

Make sure that [Silent mode](#) has not been set to [On](#). See *To turn the ringtone off* on page 50.

Check the ringtone volume. See *To set the ringtone volume* on page 50.

Check the profile. See *To select a profile* on page 63.

Check the divert call options. See *To divert calls* on page 30.

***The phone cannot be detected by other devices using Bluetooth wireless technology***

You have not turned the Bluetooth function on. Make sure that the visibility is set to show phone. See *To turn the Bluetooth function on* on page 53.

***I cannot synchronize or transfer data between my phone and my computer, when using a USB cable.***

The cable or software has not been properly installed. Go to [www.sonyericsson.com/support](http://www.sonyericsson.com/support) to read Getting started guides which contain detailed installation instructions and troubleshooting guides.

***I have forgotten my code memo passcode***

If you forget your passcode, you must reset the code memo. This means that all entries in the code memo are deleted. The next time you enter the code memo, you must proceed as if you are opening it for the first time.

***To reset code memo***

- 1 From standby select [Menu](#) > [Organizer](#) > [Code memo](#).
- 2 Enter any passcode to access the code memo. The checkword and codes that are then shown are incorrect.
- 3 Select [Options](#) > [Reset](#).
- 4 [Reset code memo?](#) appears.
- 5 Select [Yes](#).

**Where can I find the regulatory information such as my IMEI number if I cannot turn on my phone?**



## Error messages

### Insert SIM

There is no SIM card in your phone or you may have inserted it incorrectly.

See *Charging the battery* on page 8.

The SIM card connectors need cleaning. If the card is damaged, contact your network operator.

### Insert correct SIM card

Your phone is set to work only with certain SIM cards. Check if you are using the correct operator SIM card.

### Wrong PIN/Wrong PIN2

You have entered your PIN or PIN2 incorrectly.

Enter the correct PIN or PIN2 and select **Yes**. See *To insert the SIM card* on page 6.

### PIN blocked/PIN2 blocked

You have entered your PIN or PIN2 code incorrectly three times in a row.

To unblock, see *SIM card lock* on page 65.

### Codes do not match

Codes that you have entered do not match. When you want to change a security code, for example your PIN, you have to confirm the new code. See *SIM card lock* on page 65.

### No netw. coverage

Your phone is in flight mode. See *Flight mode* on page 59.

Your phone is not receiving any network signal, or the received signal is too weak. Contact your network operator and make sure that the network has coverage where you are.

The SIM card is not working properly. Insert your SIM card in another phone. If this works, it is probably your phone that is causing the problem. Please contact the nearest Sony Ericsson service location.

### Emerg. calls only

You are within range of a network, but you are not allowed to use it.

However, in an emergency, some network operators allow you to call the international emergency number 112. See *Emergency calls* on page 24.

### PUK blocked. Contact operator.

You entered your personal unblocking key code (PUK) incorrectly 10 times in a row.

## Important information

### Sony Ericsson Consumer Web site

On [www.sonyericsson.com/support](http://www.sonyericsson.com/support) is a support section where help and tips are only a few clicks away. Here you will find the latest computer software updates and tips on how to use your product more efficiently.

### Service and support

From now on you will have access to a portfolio of exclusive service advantages such as:

- Global and local Web sites providing support.
- A global network of Call Centers.
- An extensive network of Sony Ericsson service partners.
- A warranty period. Learn more about the warranty conditions in this User guide.

On [www.sonyericsson.com](http://www.sonyericsson.com), under the support section in the language of your choice, you will find the latest support tools and information, such as software updates, Knowledge base, phone setup and additional help when you require it.

For operator-specific services and features, please contact your network operator for more information. You can also contact our Call Centers. Use the phone number for the nearest Call Center in the list below. If your country/region is not represented in the list, please contact your local dealer. (The phone numbers below were correct at the time of going to print. On [www.sonyericsson.com](http://www.sonyericsson.com) you can always find the latest updates.)

In the unlikely event that your product needs service please contact the dealer from whom it was purchased, or one of our service partners. Save your original proof of purchase, you will need it if you need to claim warranty.

## Support

Argentina	800-333-7427
Australia	1-300650-600
Belgique/België	02-7451611
Brasil	4001-04444
Canada	1-866-766-9374
Central Africa	+27 112589023
Chile	123-0020-0656
Colombia	18009122135
Česká republika	844550 055
Danmark	33 31 28 28
Deutschland	0180 534 2020
Ελλάδα	801-11-810-810 210-89 91 919
España	902 180 576
France	0 825 383 383
Hong Kong/香港	8203 8863
Hrvatska	062 000 000
India/ भारत	39011111
Indonesia	021-2701388
Ireland	1850 545 888
Italia	06 48895206
Lietuva	8 70055030
Magyarország	+36 1 880 4747
Malaysia	1-800-889900
México	01 800 000 4722
Nederland	0900 899 8318
New Zealand	0800-100150
Norge	815 00 840
Österreich	0810 200245
Pakistan	111 22 55 73 (92-21) 111 22 55 73

You will be charged for a call to one of our Call Centers according to national rates, including local taxes, unless the phone number is a toll-free number.

questions.AR@support.sonyericsson.com  
questions.AU@support.sonyericsson.com  
questions.BE@support.sonyericsson.com  
questions.BR@support.sonyericsson.com  
questions.CA@support.sonyericsson.com  
questions.CF@support.sonyericsson.com  
questions.CL@support.sonyericsson.com  
questions.CO@support.sonyericsson.com  
questions.CZ@support.sonyericsson.com  
questions.DK@support.sonyericsson.com  
questions.DE@support.sonyericsson.com  
questions.GR@support.sonyericsson.com

questions.ES@support.sonyericsson.com  
questions.FR@support.sonyericsson.com  
questions.HK@support.sonyericsson.com  
questions.HR@support.sonyericsson.com  
questions.IN@support.sonyericsson.com  
questions.ID@support.sonyericsson.com  
questions.IE@support.sonyericsson.com  
questions.IT@support.sonyericsson.com  
questions.LT@support.sonyericsson.com  
questions.HU@support.sonyericsson.com  
questions.MY@support.sonyericsson.com  
questions.MX@support.sonyericsson.com  
questions.NL@support.sonyericsson.com  
questions.NZ@support.sonyericsson.com  
questions.NO@support.sonyericsson.com  
questions.AT@support.sonyericsson.com  
questions.PK@support.sonyericsson.com

Philippines/Pilipinas	02-6351860
Polska	0 (prefikis) 22 6916200
Portugal	808 204 466
România	(+4021) 401 0401
Россия	8 (495) 787 0986
Schweiz/Suisse/Svizzera	0848 824 040
Singapore	67440733
Slovensko	02-5443 6443
South Africa	0861 6322222
Suomi	09-299 2000
Sverige	013-24 45 00
Türkiye	0212 473 77 71
Україна	(+0380) 44 590 1515
United Kingdom	08705 23 7237
United States	1-866-7669347
Venezuela	0-800-100-2250
الإمارات العربية المتحدة	43 919880
中国	4008100000
台灣	02-25625511
ไทย	02-2483030

questions.PH@support.sonyericsson.com  
 questions.PL@support.sonyericsson.com  
 questions.PT@support.sonyericsson.com  
 questions.RO@support.sonyericsson.com  
 questions.RU@support.sonyericsson.com  
 questions.CH@support.sonyericsson.com  
 questions.SG@support.sonyericsson.com  
 questions.SK@support.sonyericsson.com  
 questions.ZA@support.sonyericsson.com  
 questions.FI@support.sonyericsson.com  
 questions.SE@support.sonyericsson.com  
 questions.TR@support.sonyericsson.com  
 questions.UA@support.sonyericsson.com  
 questions.GB@support.sonyericsson.com  
 questions.US@support.sonyericsson.com  
 questions.VE@support.sonyericsson.com  
 questions.AE@support.sonyericsson.com  
 questions.CN@support.sonyericsson.com  
 questions.TW@support.sonyericsson.com  
 questions.TH@support.sonyericsson.com

## Guidelines for Safe and Efficient Use

Please read this information before using your mobile phone.

These instructions are intended for your safety. Please follow these guidelines. If the product has been subject to any of the conditions listed below or you have any doubt as to its proper function make sure you have the product checked by a certified service partner before charging or using it. Failure to do so might entail a risk of product malfunction or even a potential hazard to your health.



## Recommendations for safe use of product (mobile phone, battery, charger and other accessories)

- Always treat your product with care and keep it in a clean and dust-free place.
- **Warning!** May explode if disposed of in fire.
- Do not expose your product to liquid or moisture or humidity.
- Do not expose your product to extreme high or low temperatures. Do not expose the battery to temperatures above +60°C (+140°F).
- Do not expose your product to open flames or lit tobacco products.
- Do not drop, throw or try to bend your product.





- Do not paint your product.
- Do not attempt to disassemble or modify your product. Only Sony Ericsson authorised personnel should perform service.
- Do not close your product with an object inserted between keypad and display if you have a clamshell phone; this may damage your product.
- Do not use your product near medical equipment without requesting permission from your treating physician or authorized medical staff.
- Do not use your product when in, or around aircraft, or areas showing the sign “turn off two-way radio”.
- Do not use your product in an area where a potentially explosive atmosphere exists.
- Do not place your product or install wireless equipment in the area above an air bag in your car.
- **Caution:** Cracked or broken displays may create sharp edges or splinters that could be harmful upon contact.



## CHILDREN

KEEP OUT OF CHILDREN'S REACH. DO NOT ALLOW CHILDREN TO PLAY WITH YOUR MOBILE PHONE OR ITS ACCESSORIES. THEY COULD HURT THEMSELVES OR OTHERS, OR COULD ACCIDENTALLY DAMAGE THE MOBILE PHONE OR ACCESSORY. YOUR MOBILE PHONE OR ITS ACCESSORY MAY CONTAIN SMALL PARTS THAT COULD BECOME DETACHED AND CREATE A CHOKING HAZARD.



## Power supply (Charger)

Connect the AC power adapter only to designated power sources as marked on the product. Make sure the cord is positioned so that it will not be subjected to damage or stress. To reduce risk of electric shock, unplug the unit from any power source before attempting to clean it. The AC power adapter must not be used outdoors or in damp areas. Never alter the cord or plug. If the plug does not fit into the outlet, have a proper outlet installed by a qualified electrician.

Use only Sony Ericsson branded original chargers intended for use with your mobile phone. Other chargers may not be designed to the same safety and performance standards.

## Battery

We recommend that you fully charge the battery before you use your mobile phone for the first time. A new battery or one that has not been used for a long time could have reduced capacity the first few times it is used. The battery should only be charged in temperatures between +5°C (+41°F) and +45°C (+113°F).

Use only Sony Ericsson branded original batteries intended for use with your mobile phone. Using other batteries and chargers could be dangerous.

Talk and standby times depend on several different conditions such as signal strength, operating temperature, application usage patterns, features selected and voice or data transmissions when the mobile phone is being used.

Turn off your mobile phone before removing the battery. Do not put the battery into your mouth. Battery electrolytes may be toxic if swallowed. Do not let the metal contacts on the battery touch another metal object. Doing this could short-circuit and damage the battery. Use the battery for the intended purpose only.

## Personal medical devices

Mobile phones may affect the operation of pacemakers and other implanted equipment. Please avoid placing the mobile phone over the pacemaker, e.g. in your breast pocket. When using the mobile phone, use it at the ear on the opposite side of the body to the pacemaker. If a minimum distance of 15 cm (6 inches) is kept between the mobile phone and the pacemaker, the risk of interference is limited. If you have any reason to suspect that interference is taking place, immediately turn off your mobile phone. Contact your cardiologist for more information.

For other medical devices, please consult your physician and the manufacturer of the device.

## Driving

Please check if local laws and regulations restrict the use of mobile phones while driving or require drivers to use handsfree solutions. We recommend that you use only Sony Ericsson handsfree solutions intended for use with your product.

Please note that because of possible interference to electronic equipment, some vehicle manufacturers forbid the use of mobile phones in their vehicles unless a handsfree kit with an external antenna has been installed.

Always pay full attention to driving and pull off the road and park before making or answering a call if driving conditions so require.

## GPS/Location based functions

Some products provide GPS/Location based functions. Location determining functionality is provided "AS IS" and "WITH ALL FAULTS". Sony Ericsson does not make any representation or warranty as to the accuracy of such location information.

Use of location-based information by the device may not be uninterrupted or error free and may additionally be dependent on network service

availability. Please note that functionality may be reduced or prevented in certain environments such as building interiors or areas adjacent to buildings. Caution: Do not use GPS functionality in a manner which causes distraction from driving.

## Emergency calls

Mobile phones operate using radio signals, which cannot guarantee connection in all conditions. You should therefore never rely solely upon any mobile phone for essential communications (e.g. medical emergencies).

Emergency calls may not be possible in all areas, on all cellular networks, or when certain network services and/or mobile phone features are in use. Check with your local service provider.

## Antenna

This phone contains a built-in antenna. Use of antenna devices not marketed by Sony Ericsson specifically for this model could damage your mobile phone, reduce performance, and produce SAR levels above the established limits (see below).

## Efficient use

Hold your mobile phone as you would any other phone. Do not cover the top of the phone when it is in use, as this affects call quality and may cause the phone to operate at a higher power level than needed, thus shortening talk and standby times.

## Radio frequency (RF) exposure and Specific Absorption Rate (SAR)

Your mobile phone is a low-power radio transmitter and receiver. When it is turned on, it emits low levels of radio frequency energy (also known as radio waves or radio frequency fields).

Governments around the world have adopted comprehensive international safety guidelines, developed by scientific organizations, e.g. ICNIRP

(International Commission on Non-ionizing Radiation Protection) and IEEE (The Institute of Electrical and Electronics Engineers Inc.), through periodic and thorough evaluation of scientific studies. These guidelines establish permitted levels of radio wave exposure for the general population. The levels include a safety margin designed to assure the safety of all persons, regardless of age and health, and to account for any variations in measurements.

Specific Absorption Rate (SAR) is the unit of measurement for the amount of radio frequency energy absorbed by the body when using a mobile phone. The SAR value is determined at the highest certified power level in laboratory conditions, but the actual SAR level of the mobile phone while it is operating can be well below this value. This is because the mobile phone is designed to use the minimum power required to reach the network.

Variations in SAR below the radio frequency exposure guidelines do not mean that there are variations in safety. While there may be differences in SAR levels among mobile phones, all Sony Ericsson mobile phone models are designed to meet radio frequency exposure guidelines.

For phones sold in the US, before a phone model is available for sale to the public, it must be tested and certified by the Federal Communications Commission (FCC) that it does not exceed the limit established by the government-adopted requirement for safe exposure. The tests are performed in positions and locations (that is, at the ear and worn on the body) as required by the FCC for each model. For body-worn operation, this phone has been tested and meets FCC RF exposure guidelines when the handset is positioned a minimum of 15 mm from the body without any metal parts in the vicinity of the phone or when used with the original Sony Ericsson accessory intended for this phone and worn on the body. Use of other accessories may not ensure compliance with FCC RF exposure guidelines.

A separate leaflet with SAR information about this mobile phone model is included with the material accompanying this mobile phone. This information can also be found, together with more information on radio frequency exposure and SAR, on: [www.sonyericsson.com/health](http://www.sonyericsson.com/health).

## Accessible Solutions/Special Needs

For phones sold in the US, you can use your TTY terminal with your Sony Ericsson mobile phone (with the necessary accessory). For information on Accessible Solutions for individuals with special needs call the Sony Ericsson Special Needs Center on 877 878 1996 (TTY) or 877 207 2056 (voice), or visit the Sony Ericsson Special Needs Center at [www.sonyericsson-snc.com](http://www.sonyericsson-snc.com).

## Disposal of old electrical and electronic equipment



This symbol indicates that all electrical and electronic equipment included shall not be treated as household waste. Instead it shall be left at the appropriate collection point for recycling of electrical and electronic equipment. By ensuring this product is disposed of correctly, you will help prevent potential negative consequences for the environment and human health, which could otherwise be caused by inappropriate waste handling of this product. The recycling of materials will help to conserve natural resources. For more detailed information about recycling this product, please contact your local city office, your household waste disposal service or the shop where you purchased the product.

## Disposing of the battery

Please check local regulations for disposal of batteries or call your local Sony Ericsson Call Center for information.



The battery should never be placed in municipal waste. Use a battery disposal facility if available.

## Memory card

If your product comes complete with a removable memory card, it is generally compatible with the handset purchased but may not be compatible with other devices or the capabilities of their memory cards. Check other devices for compatibility before purchase or use. If your product is equipped with a memory card reader, check memory card compatibility before purchase or use.

The memory card is formatted prior to shipping. To reformat the memory card, use a compatible device. Do not use the standard operating system format when formatting the memory card on a PC. For details, refer to the operating instructions of the device or contact customer support.

### WARNING:

If your device requires an adapter for insertion into the handset or another device, do not insert the card directly without the required adapter.

### Precautions on Memory Card Use

- Do not expose the memory card to moisture.
- Do not touch terminal connections with your hand or any metal object.
- Do not strike, bend, or drop the memory card.
- Do not attempt to disassemble or modify the memory card.
- Do not use or store the memory card in humid or corrosive locations or in excessive heat such as a closed car in summer, in direct sunlight or near a heater, etc.

- Do not press or bend the end of the memory card adapter with excessive force.
- Do not let dirt, dust, or foreign objects get into the insert port of any memory card adapter.
- Check you have inserted the memory card correctly.
- Insert the memory card as far as it will go into any memory card adapter needed. The memory card may not operate properly unless fully inserted.
- We recommend that you make a backup copy of important data. We are not responsible for any loss or damage to content you store on the memory card.
- Recorded data may be damaged or lost when you remove the memory card or memory card adapter, or turn off the power while formatting, reading or writing data, or when you use the memory card in locations subject to static electricity or high electrical field emissions.

### Protection of personal information

To safeguard your privacy and prevent information being accessible to a third party, you should erase all personal data before selling or disposing of the product. To delete personal data, perform a master reset, remove the memory card or format the media memory. **DELETION OF MATERIAL FROM THE PHONE AND MEDIA MEMORIES DOES NOT ENSURE THAT SAID INFORMATION CANNOT BE RECOVERED BY A SUBSEQUENT USER. SONY ERICSSON DOES NOT WARRANT AGAINST A SUBSEQUENT USER OF THE DEVICE ACCESSING YOUR INFORMATION AND DOES NOT ASSUME ANY RESPONSIBILITY FOR SUBSEQUENT DISCLOSURE OF SAID INFORMATION EVEN IF A MASTER RESET AND A MEDIA MEMORY FORMAT HAS BEEN PERFORMED.** If you are concerned about such potential disclosure retain your device or secure its permanent destruction.

## Malware

Malware (short for malicious software) is software that can harm your mobile phone or other computers. Malware or harmful applications can include viruses, worms, spyware, and other unwanted programs. While your device does employ security measures to resist such efforts, Sony Ericsson does not warrant or represent that your device will be impervious to introduction of malware. You can however reduce the risk of malware attacks by using care when downloading content or accepting applications, refraining from opening or responding to messages from unknown sources, using trustworthy services to access the Internet, and only downloading content to your mobile phone from known, reliable sources.

## Accessories

Sony Ericsson recommends use of Sony Ericsson original accessories for safe and efficient use of its products. Use of third-party accessories may decrease performance or pose a risk to your health or safety.

## LOUDNESS WARNING:

Please adjust the audio volume cautiously when using third-party audio accessories to avoid volume levels that may be harmful to your hearing. Sony Ericsson does not test use of third-party audio accessories with this mobile phone. Sony Ericsson recommends using only Sony Ericsson original audio accessories.

## End User Licence Agreement

This wireless device, including without limitation any media delivered with the device, ("Device") contains software owned by Sony Ericsson Mobile Communications AB and its affiliated companies ("Sony Ericsson") and its third party suppliers and licensors ("Software").

As user of this Device, Sony Ericsson grants you a non-exclusive, non-transferable, non-assignable license to use the Software solely in conjunction with the Device on which it is installed and/or delivered with. Nothing herein shall be construed as a sale of the Software to a user of this Device.

You shall not reproduce, modify, distribute, reverse engineer, decompile, otherwise alter or use any other means to discover the source code of the Software or any component of the Software. For avoidance of doubt, you are at all times entitled to transfer all rights and obligations to the Software to a third party, solely together with the Device with which you received the Software, provided always that such third party agrees in writing to be bound by these rules.

You are granted this license for a term of the useful life of this Device. You can terminate this license by transferring all your rights to the Device on which you have received the Software to a third party in writing. If you fail to comply with any of the terms and conditions set out in this license, it will terminate with immediate effect.

Sony Ericsson and its third party suppliers and licensors are the sole and exclusive owner of and retain all rights, title and interest in and to the Software. Sony Ericsson, and, to the extent that the Software contains material or code of a third party, such third party, shall be entitled third party beneficiaries of these terms.

The validity, construction and performance of this license shall be governed by the laws of Sweden. The foregoing shall apply to the full extent permitted by, when applicable, statutory consumer rights.

## Limited Warranty

Sony Ericsson Mobile Communications AB, SE-221 88 Lund, Sweden, (Sony Ericsson) or its local affiliated company, provides this Limited Warranty for your mobile phone, original accessory delivered with your mobile phone, and/or your mobile computing product (hereinafter referred to as "Product").

Should your Product need warranty service, please return it to the dealer from whom it was purchased, or contact your local Sony Ericsson Call Center (national rates may apply) or visit [www.sonyericsson.com](http://www.sonyericsson.com) to get further information.

### Our warranty

Subject to the conditions of this Limited Warranty, Sony Ericsson warrants this Product to be free from defects in design, material and workmanship at the time of its original purchase by a consumer. This Limited Warranty will last for a period of one (1) year as from the original date of purchase of the Product.

### What we will do

If, during the warranty period, this Product fails to operate under normal use and service, due to defects in design, materials or workmanship, Sony Ericsson authorized distributors or service partners, in the country\* where you purchased the Product, will, at their option, either repair or replace the Product in accordance with the terms and conditions stipulated herein.

Sony Ericsson and its service partners reserve the right to charge a handling fee if a returned Product is found not to be under warranty according to the conditions below.

Please note that some of your personal settings, downloads and other information may be lost when your Sony Ericsson Product is repaired or replaced. At present Sony Ericsson may be prevented by applicable law, other regulation or technical restrictions from making a backup copy of certain downloads. Sony Ericsson does not take any responsibility for any lost information of any kind and will not reimburse you for any such loss. You should always make backup copies of all the information stored on your Sony Ericsson Product such as downloads, calendar and contacts before handing in your Sony Ericsson Product for repair or replacement.

### Conditions

- 1 This Limited Warranty is valid only if the original proof of purchase for this Product issued by a Sony Ericsson authorized dealer specifying the date of purchase and serial number\*\*, is presented with the Product to be repaired or replaced. Sony Ericsson reserves the right to refuse warranty service if this information has been removed or changed after the original purchase of the Product from the dealer.
- 2 If Sony Ericsson repairs or replaces the Product, the repair for the defect concerned, or the replaced Product shall be warranted for the remaining time of the original warranty period or for ninety (90) days from the date of repair, whichever is longer. Repair or replacement may involve the use of functionally equivalent reconditioned units. Replaced parts or components will become the property of Sony Ericsson.

- 3 This warranty does not cover any failure of the Product due to normal tear and wear, or due to misuse, including but not limited to use in other than the normal and customary manner, in accordance with the Sony Ericsson instructions for use and maintenance of the Product. Nor does this warranty cover any failure of the Product due to accident, software or hardware modification or adjustment, acts of God or damage resulting from liquid.

A rechargeable battery can be charged and discharged more than a hundred times. However, it will eventually wear out – this is not a defect and corresponds to normal wear and tear. When the talk-time or standby time is noticeably shorter, it is time to replace your battery. Sony Ericsson recommends that you use only batteries and chargers approved by Sony Ericsson.

Minor variations in display brightness and colour may occur between the phones. There may be tiny bright or dark dots on the display. These are called defective pixels and occur when individual dots have malfunctioned and can not be adjusted. Two defective pixels are deemed acceptable.

Minor variations in camera image appearance may occur between phones. This is nothing uncommon and is not regarded as a defective camera module.

- 4 Since the cellular system on which the Product is to operate is provided by a carrier independent from Sony Ericsson, Sony Ericsson will not be responsible for the operation, availability, coverage, services or range of that system.

- 5 This warranty does not cover Product failures caused by installations, modifications, or repair or opening of the Product performed by a non-Sony Ericsson authorised person.
- 6 The warranty does not cover Product failures which have been caused by use of accessories or other peripheral devices which are not Sony Ericsson branded original accessories intended for use with the Product.
- 7 Tampering with any of the seals on the Product will void the warranty.
- 8 THERE ARE NO EXPRESS WARRANTIES, WHETHER WRITTEN OR ORAL, OTHER THAN THIS PRINTED LIMITED WARRANTY. ALL IMPLIED WARRANTIES, INCLUDING WITHOUT LIMITATION THE IMPLIED WARRANTIES OF MERCHANTABILITY OR FITNESS FOR A PARTICULAR PURPOSE, ARE LIMITED TO THE DURATION OF THIS LIMITED WARRANTY. IN NO EVENT SHALL SONY ERICSSON OR ITS LICENSORS BE LIABLE FOR INCIDENTAL OR CONSEQUENTIAL DAMAGES OF ANY NATURE WHATSOEVER, INCLUDING BUT NOT LIMITED TO LOST PROFITS OR COMMERCIAL LOSS; TO THE FULL EXTENT THOSE DAMAGES CAN BE DISCLAIMED BY LAW.

Some countries/states do not allow the exclusion or limitation of incidental or consequential damages, or limitation of the duration of implied warranties, so the preceding limitations or exclusions may not apply to you.

The warranty provided does not affect the consumer's statutory rights under applicable legislation in force, nor the consumer's rights against the dealer arising from their sales / purchase contract.

## \*Geographical scope of the warranty

If you have purchased your Product in a country member of the European Economic Area (EEA) or in Switzerland or the Republic of Turkey, and such Product was intended for sale in the EEA or in Switzerland or in Turkey, you can have your Product serviced in any EEA country or in Switzerland or in Turkey, under the warranty conditions prevailing in the country in which you require servicing, provided that an identical Product is sold in such country by an authorised Sony Ericsson distributor. To find out if your Product is sold in the country you are in, please call the local Sony Ericsson Call Center. Please observe that certain services may not be possible elsewhere than in the country of original purchase, for example due to the fact that your Product may have an interior or exterior which is different from equivalent models sold in other countries. Please note in addition that it may sometimes not be possible to repair SIM-locked Products.

\*\* In some countries/regions additional information (such as a valid warranty card) may be requested.

## FCC Statement

This device complies with Part 15 of the FCC rules. Operation is subject to the following two conditions:

- (1) This device may not cause harmful interference, and
- (2) This device must accept any interference received, including interference that may cause undesired operation.



Any change or modification not expressly approved by Sony Ericsson may void the user's authority to operate the equipment.

This equipment has been tested and found to comply with the limits for a Class B digital device, pursuant to Part 15 of the FCC Rules. These limits are designed to provide reasonable protection against harmful interference in a residential installation. This equipment generates, uses and can radiate radio frequency energy and, if not installed and used in accordance with the instructions, may cause harmful interference to radio communications. However, there is no guarantee that interference will not occur in a particular installation.

If this equipment does cause harmful interference to radio or television reception, which can be determined by turning the equipment off and on, the user is encouraged to try to correct the interference by one or more of the following measures:

- Reorient or relocate the receiving antenna.
- Increase the separation between the equipment and receiver.
- Connect the equipment into an outlet on a circuit different from that to which the receiver is connected.
- Consult the dealer or an experienced radio/TV technician for help.



## Industry Canada Statement

This device complies with RSS-210 of Industry Canada.

Operation is subject to the following two conditions:

(1) this device may not cause interference, and  
(2) this device must accept any interference, including interference that may cause undesired operation of the device.

This Class B digital apparatus complies with Canadian ICES-003.

Cet appareil numérique de la classe B est conforme à la norme NMB-003 du Canada.

## Declaration of Conformity for Z780i

We, **Sony Ericsson Mobile Communications AB** of Nya Vattentornet

SE-221 88 Lund, Sweden

declare under our sole responsibility that our product **Sony Ericsson type AAD-3252051-BV**

and in combination with our accessories, to which this declaration relates is in conformity with the appropriate standards EN 301 511:V9.0.2, EN 301 908-1:V2.2.1, EN 301 908-2:V2.2.1, EN 300 328:V1.7.1, EN 300 440-1:V1.7.1, EN 300 440-2:V1.1.2, EN 301 489-3:V1.4.1, EN 301 489-7:V1.3.1, EN 301 489-17:V1.2.1, EN 301 489-24:V1.3.1, EN 60 950-1:2006 following the provisions of, Radio Equipment and Telecommunication Terminal Equipment directive 1999/5/EC.

Lund, December 2007

**CE 0682**



*Shoji Nemoto,*  
*Head of Product Business Group GSM/UMTS*

We fulfil the requirements of the R&TTE Directive (1999/5/EC).

# Index

## A

activity menu .....	14
adding	
notes .....	63
alarms .....	61
answering service .....	28
applications .....	51
appointments .....	62
assembly .....	6
audio book .....	48

## B

battery	
charging .....	8
inserting .....	6
use and care .....	73
blog	
video .....	43
Bluetooth™	
visibility .....	53
Bluetooth™ wireless technology .....	53
bookmarks	
creating .....	17
select .....	17
browsing	
copy and paste .....	18
business cards .....	27

## C

calendar .....	61–62
call divert .....	30
call list .....	28
call numbers in message .....	35
call time .....	33
caller-specific ringtones .....	25
calls	
accepting .....	32
answering and rejecting .....	23
emergency .....	24
handling two calls .....	31
international .....	23
making and receiving .....	23
putting on hold .....	30
recording .....	51
camera	
settings .....	42
code memo .....	68
conference calls .....	31
contacts	
adding phone contacts .....	25
default contacts .....	24
groups .....	27
synchronizing .....	56
copy and paste	
while browsing .....	18

<b>D</b>		<b>I</b>	
date .....	64	IMEI number .....	66
declaration of conformity .....	81	Internet	
downloading music .....	48	bookmarks .....	17
		security and certificates .....	19
<b>E</b>		settings .....	52
email .....	37		
emergency numbers .....	24	<b>J</b>	
entering text .....	15	Java™ .....	51
<b>F</b>		<b>K</b>	
file manager .....	60	keys .....	9
fixed dialling .....	32		
flight mode .....	59	<b>L</b>	
		language .....	15
<b>G</b>		location services .....	21
games .....	51	lock	
Google Maps™ .....	21	phone .....	65
GPS .....	21		
groups .....	27	<b>M</b>	
		master reset .....	66
<b>H</b>		Media Manager .....	46
handsfree .....	29, 46	media transfer .....	46, 55
Bluetooth™ technology .....	54	memory card .....	14
help .....	8	memory status .....	26
hiding number .....	33	menu overview .....	11
history		menus .....	13
Web pages .....	17		

messages		photos	
area and cell information .....	40	improving .....	42
email .....	37	photo fix .....	42
picture .....	35	picture messages .....	35
text .....	34	pictures .....	44
voice .....	37	editing .....	45
microphone .....	23	improving .....	42
MMS See picture messages		photo fix .....	42
music player .....	47	PIN code	
MusicDJ™ .....	50	changing .....	65
My friends .....	39	unblocking .....	7
my numbers .....	31	playlists .....	47
<b>N</b>		PlayNow™ .....	48
navigating menus .....	13	podcasts .....	20
notes .....	63	profiles .....	63
adding .....	63	PUK .....	7, 65
showing in standby .....	63	push email .....	38
<b>P</b>		<b>R</b>	
pan and zoom		ringtones .....	50
Web pages .....	17	RSS feeds See Web feeds	
PC Suite		RSS ticker .....	20
synchronizing .....	56	<b>S</b>	
phone mode .....	56	safety guidelines .....	72
phone name .....	53	saved Web pages	
photo feeds .....	20	viewing .....	18
photo fix .....	42	saving	
photo tags .....	44	Web pages .....	18
PhotoDJ™ .....	45		

search		transfer method	
on Web pages .....	18	Bluetooth™ technology .....	53
selection keys .....	13	USB .....	55
settings		transferring	
Internet .....	52	camera pictures .....	43
Java™ .....	52	files .....	55
shortcuts .....	14	music .....	46
SIM card .....	65	sound .....	54
copying to/from .....	26	turning on/off	
locking .....	65	Bluetooth™ function .....	53
unblocking .....	65	phone lock .....	65
SMS See text messages		SIM lock protection .....	65
SOS See emergency numbers		<b>U</b>	
sound recorder .....	51	update	
speed dialling .....	28	Web feeds .....	19
standby .....	7	Update service .....	58
notes .....	63	<b>V</b>	
startup screen .....	7	video	
submenus .....	13	blog .....	43
synchronizing .....	56	editing .....	45
<b>T</b>		video player .....	49
T9™ Text Input .....	16	video recorder .....	41
tasks .....	63	VideoDJ™ .....	45
templates .....	36	viewing	
text messages .....	34	saved Web pages .....	18
theme .....	64	visibility .....	53
time .....	64	voice answering .....	29
time zone .....	64	voice commands .....	29

voice control .....	29
voice messages .....	37
voicemail .....	28
volume	
ear speaker .....	23
ringtone .....	50

## **W**

warranty .....	78
Web	
search .....	18
Web feeds .....	19
showing in standby .....	20
update .....	19
Web pages	
history .....	17
pan and zoom .....	17
saving .....	18

## **Z**

zoom .....	42
------------	----