

Contents

Getting started 4

Assemble the phone, SIM card, battery, make a call.

Getting to know your phone 8

Phone overview, use the menus, keys and navigation, enter letters, file manager.

Calling 18

Calls, video calls, contacts, voice control, call options.

Messaging 36

Text messaging, picture messaging, email, My friends.

Imaging 46

Camera, video recorder, pictures, wallpaper.

Entertainment 53

Media player, PlayNow™, ringtones, MusicDJ™, sound recorder, themes, games.

Sony Ericsson Z800i

Connectivity 61

Internet and email settings, synchronizing, Bluetooth, infrared, USB cable, update service.

More features 72

Time and date, alarm clock, calendar, tasks, Java™ applications, SIM card lock, etc.

Troubleshooting 80

Why doesn't the phone work the way I want?

Additional information 85

Sony Ericsson Consumer Web site, safe and efficient use, warranty, declaration of conformity.

Icons 93

Index 95

Sony Ericsson

UMTS-GSM 900/1800/1900

Second edition (February 2005)

This user guide is published by Sony Ericsson Mobile Communications AB, without any warranty. Improvements and changes to this user guide necessitated by typographical errors, inaccuracies of current information, or improvements to programs and/or equipment, may be made by Sony Ericsson Mobile Communications AB at any time and without notice. Such changes will, however, be incorporated into new editions of this user guide.

All rights reserved.

© **Sony Ericsson Mobile Communications AB, 2005**

Publication number: EN/LZT 108 7694 R2A

Please note:

Some of the services in this user guide are not supported by all networks. *This also applies to the GSM International Emergency Number 112.*

Please contact your network operator or service provider if you are in doubt whether you can use a particular service or not.

Please read the *Guidelines for safe and efficient use* and the *Limited warranty* chapters before you use your mobile phone.

Your mobile phone has the capability to download, store and forward additional content, e.g. ringtones. The use of such content may be restricted or prohibited by rights of third parties, including but not limited to restriction under applicable copyright laws. You, and not Sony Ericsson, are entirely responsible for additional content that you download to or forward from your mobile phone. Prior to your use of any additional content, please verify that your intended use is properly licensed or is otherwise authorized. Sony Ericsson does not guarantee the accuracy, integrity or quality of any additional content or any other third party content. Under no circumstances will Sony Ericsson be liable in any way for your improper use of additional content or other third party content.

The Bluetooth word mark and logos are owned by the Bluetooth SIG, Inc. and any use of such marks by Sony Ericsson is under license.

Memory Stick™ and Memory Stick Duo™ are trademarks or registered trademarks of Sony Corporation.

Motion Eye™ is a trademark or a registered trademark of Sony Corporation.

QuickShare™, PlayNow™ and MusicDJ™ are trademarks or registered trademarks of Sony Ericsson Mobile Communications AB.

Microsoft, Windows and PowerPoint are either registered trademarks or trademarks of Microsoft Corporation in the U.S and other countries.

Mac OS is a trademark of Apple Computer, Inc., registered in the U.S. and other countries.

T9™ Text Input is a trademark or a registered trademark of Tegic Communications.

T9™ Text Input is licensed under one or more of the following: U.S. Pat. Nos. 5,818,437, 5,953,541, 5,187,480, 5,945,928, and 6,011,554; Canadian Pat. No. 1,331,057, United Kingdom Pat. No. 2238414B; Hong Kong Standard Pat. No. HK0940329; Republic of Singapore Pat. No. 51383; Euro.Pat. No. 0 842 463(96927260.8) DE/DK, FI, FR, IT, NL, PT, ES, SE, GB; and additional patents are pending worldwide.

Java and all Java based trademarks and logos are trademarks or registered trademarks of Sun Microsystems, Inc. in the U.S. and other countries.

End-user license agreement for Sun™ Java™ J2ME™.

- 1** Restrictions: Software is confidential copyrighted information of Sun and title to all copies is retained by Sun and/or its licensors. Customer shall not modify, decompile, disassemble, decrypt, extract, or otherwise reverse engineer Software. Software may not be leased, assigned, or sublicensed, in whole or in part.
- 2** Export Regulations: Software, including technical data, is subject to U.S. export control laws,

including the U.S. Export Administration Act and its associated regulations, and may be subject to export or import regulations in other countries. Customer agrees to comply strictly with all such regulations and acknowledges that it has the responsibility to obtain licenses to export, re-export, or import Software. Software may not be downloaded, or otherwise exported or re-exported (i) into, or to a national or resident of, Cuba, Iraq, Iran, North Korea, Libya, Sudan, Syria (as such listing may be revised from time to time) or any country to which the U.S. has embargoed goods; or (ii) to anyone on the U.S. Treasury Department's list of Specially Designated Nations or the U.S. Commerce Department's Table of Denial Orders.

- 3** Restricted Rights: Use, duplication or disclosure by the United States government is subject to the restrictions as set forth in the Rights in Technical Data and Computer Software Clauses in DFARS 252.227-7013(c) (1) (ii) and FAR 52.227-19(c) (2) as applicable.

Part of the software in this product is copyright © SyncML initiative Ltd. (1999-2002). All rights reserved.

Other product and company names mentioned herein may be the trademarks of their respective owners. Any rights not expressly granted herein are reserved.

Getting started

Assemble the phone, SIM card, battery, make a call.

More information and downloads are available at www.SonyEricsson.com/support.

Instruction symbols

The following instruction symbols appear in this user guide:



Note



Indicates that a service or function is network- or subscription-dependent. Contact your network operator for details.



See also page ...



Use the selection keys or the navigation key to scroll and select.

➔ *11 Keys and navigation*



Press the navigation key centre.



Press the navigation key up.



Press the navigation key down.



Press the navigation key to the left.



Press the navigation key to the right.

Assembling the phone

Before you can use your phone you need to:

- Insert the SIM card.
- Attach and charge the battery.
- Insert the Memory Stick Duo.

SIM card

When you register as a subscriber with a network operator, you get a SIM (Subscriber Identity Module) card. The SIM card contains a computer chip that keeps track of your phone number, the services included in your subscription, and names and numbers in your contacts, among other things.



If you have been using a SIM card in another phone, make sure that your information is saved to the SIM card before you remove it from the other phone. For example, contacts may have been saved in the phone memory.

SIM card and battery information

Always turn off the phone and detach the charger before you insert or remove a SIM card.

 It may take up to 30 minutes before the battery icon appears when charging.

To insert the SIM card, the Memory Stick Duo and the battery

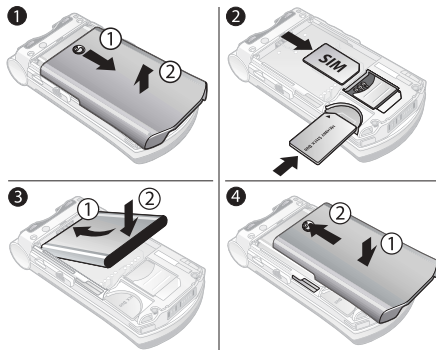

- 1** Remove the battery cover as shown in the picture.
- 2** Slide the SIM card into its slot under the silver holder. Insert the Memory Stick Duo in the slot.
- 3** Place the battery on the back of the phone with the label side up and the connectors facing each other.
- 4** Place the battery cover as shown in the picture and slide it into place.

Getting started

To charge the battery

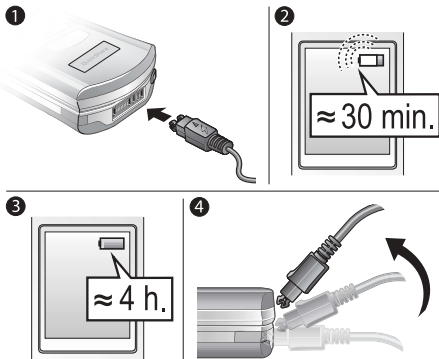

- 1 Connect the charger to the phone at the flash symbol. The flash symbol on the charger plug must face upwards.
- 2 It may take up to 30 minutes before the battery icon appears on the screen.
- 3 Wait approximately 4 hours or until the battery icon indicates that the battery is fully charged.

- 4 Remove the charger by tilting the plug upwards.



To remove the SIM card, you have to remove the battery first.

Memory Stick Duo™

The Memory Stick Duo™ gives you extra storage capacity for content such as pictures, music and video clips.

With the Memory Stick Duo you can share your saved information by moving or copying it to other Memory Stick Duo compatible devices. You can also use it as a portable memory for office documents, and move documents between the phone and a computer.

To insert and remove the Memory Stick Duo™

- 1 Insert the Memory Stick Duo in the slot as shown in ➔ 5 To insert the SIM card, the Memory Stick Duo and the battery.
- 2 Remove the battery cover and slide out the Memory Stick Duo to remove it.

For more information about Sony Memory Stick, visit www.memorystick.com.

PIN (Personal Identity Number)

You may need a PIN (Personal Identity Number) to activate the services in your phone. The PIN is associated with your SIM card, and not with the phone. Your PIN is provided by your network operator. When you enter your PIN, each digit appears as *, unless your PIN starts with the same digits as an emergency number, for example 112. This is so that you can see and call an emergency number without entering a PIN.

If you make a mistake while entering your PIN, delete the number by pressing .

 *If you enter the wrong PIN three times in a row, the SIM card is blocked and the message PIN blocked appears. To unblock it, you need to enter your PUK (Personal Unblocking Key), ➤ 77 SIM card lock.*

Turning on the phone and making calls

Make sure that the phone is charged and your SIM card is inserted before you turn it on. When you have turned the phone on, you can use the setup wizard to quickly and easily prepare your phone for use.

To turn on the phone

- 1 Open the phone, press and hold .
- 2 Enter your SIM card PIN, if you have one.
- 3 At first start-up, select the language you want for your phone menus.
- 4 ▶ Yes to let the setup wizard help you get started, and follow the instructions that appear. You can start the wizard from the menu system at any time, ▶ Settings ▶ the General tab ▶ Setup wizard.

To make a call

Enter the phone number (with international prefix and area code if applicable) ▶ Call to make the call, or press  to make a video call. ▶ End call to end the call.

To receive calls



When the phone rings, simply open the phone, or, if Open to answer is not activated, open the phone ▶ Yes, ➤ 19 To activate or deactivate open to answer.

Getting to know your phone

Phone overview, use the menus, keys and navigation, enter letters, file manager.

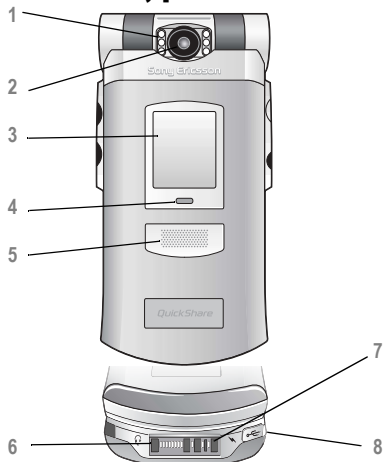
Overview, phone closed









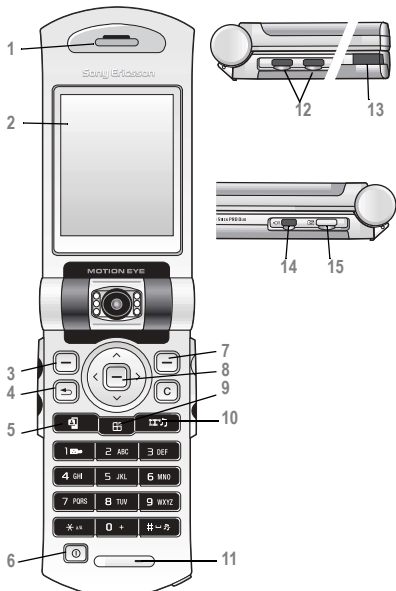

- 1 Light
- 2 Camera lens
- 3 External display
- 4 Network and battery indicator light
- 5 Loudspeaker
- 6  Stereo headset handsfree connector
- 7  Charger connector
- 8  USB port

For more information on keys and navigation,
➡ *11 Keys and navigation.*

Overview, phone open



- 1 Speaker
- 2 Screen
- 3, 7  Selection keys
- 4  Back key
- 5  Video call key
- 6  Power on/off
- 8 Navigation key
- 9  Main menu key
- 10  Media player key
- 11 Microphone
- 12 Volume buttons
- 13 Infrared port
- 14  Light button
- 15  Camera button

For more information on keys and navigation,
 ➔ *11 Keys and navigation.*

Overview, menu

1. PlayNow™*

2. Internet services*

3. Entertainment

- Games
- MusicDJ™
- Record sound

4. Camera

5. Messaging

- Write new
- Inbox
- My friends*
- Call voicemail
- Email
- Drafts
- Templates
- Outbox
- Sent messages
- Saved messages
- Settings

6. Media player

7. File manager

- Pictures
- Videos
- Sounds
- Themes
- Web pages
- Games
- Applications
- Other

8. Phonebook**

Contacts**

- Options:
- Speed dial
- My business card
- Groups**
- SIM numbers**
- Special numbers
- Advanced
- New contact

9. Video call

10. Calls*

11. Organizer

- Calendar
- Tasks
- Notes
- Applications
- Alarms
- Synchronization
- Timer
- Stopwatch
- Calculator
- Code memo

12. Settings

General

- Profiles
- Time & date
- Language
- Voice control
- Phone status
- Shortcuts
- Locks
- Setup wizard
- Power save
- Format Memory Stick
- Master reset

Sounds & alerts

- Ring volume
- Ringtone
- Silent mode
- Increasing ring
- Vibrating alert
- Message alert
- Key sound

Display

- Main wallpaper
- External wallpaper
- Themes
- Start-up screen
- Screen saver
- Sleep mode clock
- Brightness
- Edit line names*

Calls

- Divert calls
- Switch to line 2*
- Manage calls
- Time & cost
- Show or hide no.
- Open to answer
- Handsfree

Connectivity

- Online services*
- Bluetooth
- Infrared port
- Synchronization
- Mobile networks
- Data comm.
- Internet settings
- Streaming settings
- Settings for Java™
- Accessories



*Please note that some menus are operator-, network- and subscription-dependent.

**The menu depends on which phonebook application is selected as default.

Keys and navigation





Standby screen, main menu and status bar

The *standby screen* is displayed when you are not calling or using the menus. This is where you can see, for example, the name of your operator, the time and the date.

In standby, press  to enter the *main menu*, where the menus are shown as icons. Some submenus include tabs. Scroll to a tab using the navigation key,  and , and select an option.

The status bar at the top of the screen contains icons, which give information related to the phone and its activities, ➤ *93 Icons*.

Keys and buttons

	In standby, press to enter the main menu. Press to select highlighted items. During a call, press to view a list of options. Press to answer a call.
 	Move through menus and tabs.
 	



Press to select the options shown immediately above these keys on the screen.



Press to go back one level in the menus.
Press and hold to return to standby or end a function.



Press to delete items, such as pictures, sounds and contacts.
During a call, press and hold to mute the microphone.



Press to make a video call or to enter video call mode.



Press to go to the main menu.
Wherever you are in the phone, press to return to the main menu.



Press to open the media player.
Press again to minimize or close the media player.

Getting to know your phone



Press and hold to activate the camera and video recorder. Press to take a picture or to record a video clip.

1

In standby, press and hold to call your voicemail service.

2 - 9

In standby, press and hold any of these keys to reach a contact beginning with a specific letter.

1 - 9

In standby, press any of these keys and press **Call** to speed dial.

- *

In standby, press and hold to set the phone to silent. The alarm signal rings even if the phone is set to silent.
Press once to turn off the ringtone when receiving a call.



In standby, press to view status information.
To reject a call, quickly press twice when receiving a call.
Press once to turn off the ringtone when receiving a call.
During a call, press to increase the volume.
When using the media player (also when minimized), press to increase the volume. With closed phone, press and hold to go back one track.
When using the camera, press to increase brightness.
Press and hold to voice dial, alternatively say your magic word,
➡ *29 Voice dialling.*



Press to view the next calendar appointment in the external display (when phone is closed).

During a call, press to decrease the volume.

When using the media player (also when minimized), press to decrease the volume. With closed phone, press and hold to go forward one track.

When using the camera, press to decrease brightness.

► **Info**

Get more information, explanations or tips about selected features, menus or functions available in your phone. Scroll to a menu item ► **Info**.

► **More**

Enter a list of options. There are different alternatives in the list of options depending on where you are in the menus.

Phone language

Most SIM cards automatically set the language used in the menu to the language of the country where you bought your SIM card. If this is not the case, the predefined language is English.



You can always choose Automatic language (language according to SIM) by pressing 8888 in standby. You can always choose English by pressing 0000 in standby.

To change the phone language

- 1 ► Settings ► the General tab ► Language ► Phone language.
- 2 Select a language.

Shortcuts

A quicker way to move through the menus is to use shortcuts. You can use keypad shortcuts to quickly go to a menu, and you can use predefined navigation key shortcuts to quickly reach certain functions. You can edit the navigation key shortcuts to suit your own needs.

Getting to know your phone

Using keypad shortcuts

Enter the menus by pressing **(☰)** and then enter the number of the menu to which you want to go. For example, to reach the fifth menu item, press **(5)**. To reach the tenth, eleventh and twelfth menu items, press **(✳a/A)**, **(☐+)** and **(#↵)** respectively. To go back to standby, press and hold **(↶)**.

Using navigation key shortcuts

In standby, press **(⊙)** to go to a shortcuts menu, or **(📞)**, **(📧)** or **(📧)** to go directly to a function.

To edit a navigation key shortcut

In standby, press **(⊙)** ▶ **Edit shortcuts** and select which shortcut you want to edit ▶ **Edit**.

Entering letters

There are two ways of entering letters, for example, when writing a message or writing a name in the phonebook:

- Multitap text input

You press each key as many times as needed to show the letter you want.

- T9™ Text Input

The T9 Text Input method uses a built-in dictionary to recognize the most commonly used word for each sequence of key presses. This way, you press each key only once, even if the letter you want is not the first letter on the key.

Writing languages

Before you start entering letters, you need to select the languages that you want to use when writing.

When writing, you can switch to one of your selected languages by pressing and holding **(#↵)**.







To select writing language

- ▶ **Settings** ▶ the **General** tab ▶ **Language** ▶ **Writing language**.
- Scroll to each language that you want to use and mark it. ▶ **Save** to exit the menu.













To enter letters using multitap text input

- To enter text, you have to be in a function where text input is possible, for example ▶ **Messaging** ▶ **Write new** ▶ **Text message**.
- Press the appropriate key, **(1)** – **(9)**, **(☐+)** or **(#↵)**, repeatedly until the character you want appears on the screen. You can see which characters you can choose in the box in the top right corner of the screen.





Example:

- To enter an ‘A’, press  once.
- To enter a ‘B’, quickly press  twice.
- To shift between capital and lower-case letters, press , then enter the letter.
- You can use the volume buttons as a shortcut to certain letters. To enter a ‘B’, press and hold the  volume button and press . To enter a ‘C’, press and hold the  volume button and press .

To enter letters using T9™ Text Input

- 1 To enter text, you have to be in a function where text input is possible, for example **► Messaging ► Write new ► Text message**.
- 2 For example, if you want to write the word “Jane”, press , , , .
- 3 If the word shown is the one you want, press  to accept and add a space. To accept a word without adding a space, press . If the word shown is not the one you want, press  or  to view alternative words. Accept a word and add a space by pressing .
- 4 Continue writing your message. To enter a full stop or other punctuation marks, press  and then  or  repeatedly. Accept by pressing .





To add words to the T9 Text Input dictionary

- 1 While entering letters **► More ► Spell word**.
- 2 Edit the word by using multitap input. Navigate between the letters with  and . To delete a character, press . To delete the entire word, press and hold .
- 3 When you have edited the word **► Insert**. The word is added to the T9 Text Input dictionary. Next time you enter this word using T9 Text Input, it will appear as one of the alternative words.

To select another writing method

Before, or while entering letters, press and hold  to select another writing method.

Options when entering letters

- More** to view a list of options. The list may contain some or all of the following:
- **Add symbol** – symbols and punctuation marks such as ? and , are shown. Move between the symbols by using , ,  and .
 - **Add item** – pictures, melodies, sounds and animations.

Getting to know your phone

- **Spell word** – for T9 Text Input only. Edit the suggested word by using multitap text input.
- **Text format** – for Latin text input only. Change style, size and alignment or add a new paragraph.
- **Writing language** – a list of available languages is shown.
- **Writing method** – a list of methods available for the current language is shown.
- **Dictionary (T9)** – turn T9 Text Input dictionary on or off.
- **Word suggestions** – select to view, or not, word suggestions when writing a word.
- **My words** – manage the words that you have added to the dictionary.
- **National chars.** – turn off language-specific characters to save space. This option appears only for some writing languages.

File manager

Use the file manager to handle files (for example, pictures, video clips and sounds) saved in the phone memory and on the Memory Stick Duo. Items such as **Pictures**, **Videos**, **Sounds**, **Themes**, **Web pages**, **Games**, and **Applications** are saved

as files in folders. All files that the phone cannot recognize are saved in the **Other** folder. You can create your own subfolders in some predefined folders, to which you can move your saved files.

When handling files, you can select several or all files in a folder at the same time. You can move and copy files between the Memory Stick Duo and the phone. Icons indicate where the files are saved.

All files, except some copyright-protected files, are automatically saved on the Memory Stick Duo. If the Memory Stick Duo is full, you cannot save anything on it until you have deleted some of the content or moved the content to the phone memory. If the Memory Stick Duo is not inserted in the phone, files will be saved to the phone if there is enough memory left.

To use a file from the file manager

- 1 Highlight a file in the **Pictures** or **Sounds** folder.
- 2 ► **More** ► **Use**. Select what you want to use the file for.

To move a file to a folder

- 1 ▶ File manager and open a folder.
- 2 Scroll to a file, for example, a picture that you want to move ▶ More ▶ Manage files ▶ Move to folder.
- 3 Select the folder you want to move the file to, or select **New folder** and name the folder ▶ OK.

To create a subfolder

- 1 ▶ File manager and open a folder.
- 2 ▶ More ▶ New folder and enter a name for the folder.
- 3 ▶ OK to save the folder.

To select several files

- 1 ▶ File manager and select a file ▶ More ▶ Mark several.
- 2 Scroll and select more files by pressing **Mark** or **Unmark**.

To select all files in a folder

- ▶ File manager and select a file ▶ More press **Mark all**, or **Unmark all** to remove the selection.

To copy a file to the phone or the Memory Stick Duo

- 1 Scroll to the file, for example, a sound, that you want to copy ▶ More ▶ Manage files.
- 2 Select **Copy to phone** or **Copy to ext. mem.** Now you have two files with the same name, but different icons in front of them, telling you where the file is saved.

To move or copy files to a computer

➡ 70 *Transferring files using the USB cable.*

To delete a file from the Memory Stick Duo

Scroll to the file you want to delete from the Memory Stick Duo and press (C).

Formatting a Memory Stick Duo

You can format a Memory Stick Duo if you want to delete all information from it, or if it has been corrupted.

To format the Memory Stick Duo

- ▶ File manager and highlight a folder ▶ More ▶ Format ext. mem.

Calling

File information

Items that are downloaded, or received using one of the available transfer methods may be copyright-protected. If a file is protected, you may not be able to copy or send that file. Select the file, ► **More** ► **Information** to view information for the file.

Calling

Calls, video calls, contacts, voice control, call options.

Making calls

Before you can make or receive any calls, you must turn on the phone and be within range of a network.

► *7 Turning on the phone and making calls.*



To make a video call, you have to be within range of a 3G (UMTS) network. 3G (UMTS) service is available when the 3G icon appears in the status bar, ► *21 Video call.*

Networks

When you turn on the phone, it automatically selects your home network if this is within range. If it is not within range, you may use another network, provided your network operator has an agreement that allows you to do so. This is called roaming.



You can select the network you want to use, or you can add a network to your list of preferred networks. You can also change the order in which networks are selected during an automatic search. For all such options ► **Settings** ► the **Connectivity** tab ► **Mobile networks**.

To make a call



- 1 Enter the phone number (with country code and area code if applicable).
- 2 ▶ **Call** to make a voice call, or press  to make a video call. Press  to view options.
- 3 ▶ **End call** to end the call.

 You can call numbers from the call list and contacts, ➤ 27 Call list, and ➤ 23 Phonebook. You can also use your voice to make calls, ➤ 28 Voice control.

To change the ear speaker volume



Press  or  to increase or decrease the ear speaker volume during a call.

To use the loudspeaker during a voice call

- 1 Press  and select **Turn on speaker** to turn on the loudspeaker.
- 2 Press  and select **Turn off speaker** to turn off the loudspeaker.

 Do not hold the phone to your ear while using the loudspeaker. This could damage your hearing.

To turn off the microphone

Press and hold . To resume the conversation, press .

Receiving calls

When you receive a call, the phone rings and the caller's number is displayed (if your subscription includes the Calling Line Identification service and the caller's number is identified).

If the number is in your contacts, the name, number, and picture (if assigned) are displayed. If the number is a restricted number, **Withheld** is displayed.

You can answer a call by opening the phone or by using the keys. If you do not want to answer calls by opening the phone, you can deactivate this function.

To activate or deactivate open to answer

▶ **Settings** ▶ the **Calls** tab ▶ **Open to answer** and select **On** or **Off**.

Calling

To answer a call

Open the phone, press **Yes**, or simply open the phone if **Open to answer** is **On**.

To reject a call

- When the phone is open, press **No** or close the phone.
- When the phone is closed, quickly press a volume button twice.





Missed calls

If you have missed a call **Missed calls**: appears in standby, and in the external display if the phone is closed, indicating the number of missed calls.

To view the missed calls in the call list ► **Yes**.

If you want to view the missed calls later ► **No**.

To check your missed calls

- 1 From standby ► **Calls** and scroll to the missed calls tab. Use  or  to scroll between the tabs.
- 2 Use  or  to scroll to a number and ► **Call** to call a number.

Automatic redialling

To re-dial a number

If the connection of the call failed and **Retry?** is displayed ► **Yes**.



Do not hold the phone to your ear while waiting. When the call is connected, the phone gives a loud signal.

The phone redials the number up to ten times or until:

- The call is connected
- You press **Cancel**
- You receive a call

Automatic redialling is not available for data calls.

Making international calls

When you make an international call, the + sign replaces the international prefix number of the country from which you are calling. You can make a call from abroad, using another network, provided your network operator has an agreement with that network.

To make international calls

- 1 Press and hold  until a + sign appears on the screen.
- 2 Enter the country code, area code (without the leading zero) and phone number ► **Call**.

Emergency calls

Your phone supports the international emergency numbers, for example, 112 and 911. This means that these numbers can normally be used to make an emergency call in any country, with or without a SIM card inserted, if a 3G (UMTS) or GSM network is within range.

 *In some countries, other emergency numbers may also be promoted. Your network operator may therefore have saved additional local emergency numbers on the SIM card.*

To make an emergency call

Enter, for example, 112 (the international emergency number) ► **Call**.

To view your local emergency numbers

- Phonebook ► Options ► Special numbers
- Emergency numbers.



Video call

With video call, you can see the person you are talking to on your screen.

Video call demo mode

You can use the video call functions without making a call, if you, for example, want to prepare a view and check how it looks before calling. Press . Most video call functions are available in the demo mode.

To make a video call



- 1 Press  when 3G (UMTS) service is available.
- 2 Enter the phone number and press **Call**.
To retrieve a phone number from your contacts ► **Call...** ► **Contacts** and scroll to the phone number you want to call ► **Call** or press .
In a dimly lit environment, press and hold  to turn on the light.

To turn off or on the camera of the outgoing video



You can turn off and on the camera during a video call by pressing **Camera**.

Calling

To adjust the brightness of the outgoing video

Press  to decrease the brightness, or  to increase the brightness of the outgoing video picture.

To zoom the outgoing video in or out

Press  to zoom in the outgoing video and Press  to zoom out.

To accept an incoming video call

Press **Yes** or open the phone to accept the video call (if **Open to answer** is activated), ➔ 19 *To activate or deactivate open to answer.*

To end a video call

During an ongoing video call, press **End call**.

Video call options

Press  to view, and select from, the following options:

- **Turn off speaker/Turn on speaker** – turn off and on the incoming sound during a video call.
- **Mute microphone/Unmute mic.** – turn off and on the microphone during a video call (this option is available during calls).

- **Switch pictures** – choose between showing the incoming or the outgoing video in full size display.
- **Hide small pic./Show small pic.** – choose if you want to hide or show the small picture.
- **Night mode** – use when the lighting conditions are poor. This setting affects the outgoing video.
- **Advanced** – to view, and select, the following options:
 - **Answer mode** – choose whether the camera should be on or off when you answer a video call. If you answer with the camera turned off, you can easily turn on the camera by pressing **Camera**.
 - **Alternative pic.** – this picture will be shown to the other party when you have turned off the camera.
 - **Camera quality** – select what picture quality to use for the outgoing video. This setting will take effect at the next call – not during an ongoing call.
 - **Mirror image** – you will see a mirror image of the outgoing video. If you turn mirror image on, you will see yourself as you would in a mirror. The other party will see the picture non-mirrored. This setting only

affects the picture when the camera lens is pointing inwards.

- **Contacts** – select a contact to view during an ongoing call – useful, for example, when you want to check a number or an email address for a contact (this option is visible during calls).
- **Transfer sound** – transfer the sound to and from handsfree equipment using Bluetooth.
- **Demo clip** – turn demo clip on or off.

Phonebook

You can save your phonebook information in the phone memory as contacts, or on the SIM card as names and numbers. You can choose which phonebook – **Contacts** or **SIM numbers** – is shown as default.

For useful information and settings ► **Phonebook** ► **Options**.

Default phonebook





If you select **Contacts** as default phonebook, your phonebook will show all information saved in contacts. If you select **SIM numbers** as default phonebook, the phonebook will only show names and numbers saved on the SIM card.

To select default phonebook

► **Phonebook** ► **Options** ► **Advanced** ► **Default phonebook**. Select **Contacts** or **SIM numbers**.

Contacts

Contacts is like an address book, in which you can store names, phone numbers and email addresses. You can also add pictures, ringtones and personal information, such as email, Web and street addresses, to the contacts.

When you add information to a contact, the information is organized under five tabs. Use , ,  and  to scroll between the tabs and their information fields.

SIM numbers

On your SIM card, you can save entries as a name with a single number. The number of entries you can save depends on the amount of memory available on the SIM card, see **Phonebook** ► **Options** ► **Advanced** ► **Memory status**.



Contact your network operator for more information.

Calling

To add a contact

- 1 ► **Phonebook** ► **New contact** ► **Add**.
- 2 Enter the name directly or press **Add** and enter the name ► **OK**.
- 3 Enter the number directly or press **Add** and enter the number ► **OK**.
- 4 Select a number type.
- 5 Scroll between the tabs and select fields to enter more information. To enter symbols, for example, @ in an email address ► **Symbols** and select a symbol ► **Insert**.
- 6 When you have entered the information ► **Save**.





To add a SIM number

If SIM numbers is the default phonebook, follow the same steps as for adding a contact. You can add only a name and number to the SIM numbers phonebook.

Pictures and personal ringtones

You can add a picture and a personal ringtone to a phone contact. When that person calls, the picture is displayed (provided your subscription supports the Calling Line Identification service) and the ringtone is played.

To add a picture or a ringtone to a contact

- 1 ► **Phonebook** and select the contact you want to add a picture or ringtone to ► **More** ► **Edit contact**.
- 2 Use , ,  and  to scroll to the relevant tab. ► **Picture:** or **Ringtone:** ► **Add**.
- 3 Select a picture or sound. ► **Save** to save the contact.



Calling contacts

You can call one of the numbers saved for one of your contacts, or a number on your SIM card.

If contacts are set as default phonebook, you can choose to call from contacts or from the SIM card.

If SIM numbers are set as default, you can only call the numbers on the SIM card.

To call a contact

- 1 ► **Phonebook**. Scroll to, or enter the first letter or letters of the contact you want to call.
- 2 When the contact is highlighted, press  or  to select a number ► **Call**. To make a video call, press  when the contact is highlighted.

To call a SIM number

- 1 ▶ **Phonebook**. If SIM numbers are set as default phonebook, select the name and number you want to call from the list ▶ **Call**.
- 2 If contacts are set as default phonebook ▶ **Phonebook** ▶ **Options** ▶ **SIM numbers** and select the name and number you want to call from the list ▶ **Call**.

Ask to save

When you end a call or receive a message, the phone can prompt you to add a phone number or email address to your contacts.





To activate ask to save

- ▶ **Phonebook** ▶ **Options** ▶ **Advanced** ▶ **Ask to save** ▶ **On**.

Updating the phonebook

You can easily update and edit any information in your phonebook.

To edit a contact

- 1 ▶ **Phonebook** and select a contact ▶ **More** ▶ **Edit contact**.
- 2 Use , ,  and  to scroll to the relevant tab and edit the information you want to edit ▶ **Save**.

To edit SIM numbers

- 1 If SIM numbers are set as default phonebook ▶ **Phonebook** and select the name and number you want to edit. If contacts are set as default ▶ **Phonebook** ▶ **Options** ▶ **SIM numbers**. Select the name and number you want to edit.
- 2 ▶ **More** ▶ **Edit** and edit the name and number.

To delete a contact or a SIM number

▶ **Phonebook** and scroll to the contact or SIM number you want to delete, press .

To delete all contacts

- 1 ▶ **Phonebook** ▶ **Options** ▶ **Advanced** ▶ **Delete all contacts**.
- 2 ▶ **Yes** and enter the phone lock code ▶ **OK**. The default phone lock code is 0000. Names and numbers that are saved on the SIM card are not deleted.

Default items for contacts

A default item is displayed in the first position for a contact, and is therefore quicker to access. You can set the default item – a phone number, email address or a Web address – to be displayed first for each contact. If you do not set your own default item, the mobile phone number is the default item.

Calling

To set the default item for a contact

- 1 ▶ Phonebook and scroll to a contact ▶ More ▶ Default number.
- 2 Select the phone number, email address or Web address that you want as default item.

Copying contacts

You can copy names and numbers to and from your contacts and the SIM card. Choose if you want to copy all numbers, or a single number.



When you select to copy all contacts from the phone to the SIM card, all existing information on the SIM card will be replaced.

You can also set the phone to save entries automatically to the SIM card. With this setting, names and phone numbers that you add to or edit in your contacts in the phone memory are also saved on the SIM card. The number of phone numbers that can be saved depends on the type of SIM card.

To copy names and numbers to the SIM card

- 1 ▶ Phonebook ▶ Options ▶ Advanced ▶ Copy to SIM.
- 2 Select **Copy all** or **Copy a number**.

To copy names and numbers to Contacts

- 1 ▶ Phonebook ▶ Options ▶ Advanced ▶ Copy from SIM.
- 2 Select **Copy all** or **Copy a number**.

To automatically save names and phone numbers to the SIM card

- 1 ▶ Phonebook ▶ Options ▶ Advanced ▶ Auto save on SIM.
- 2 Select **On**.

Sending contacts

You can send contacts using one of the available transfer methods.

To send a contact

- ▶ Phonebook and select a contact ▶ More
- ▶ Send contact and select a transfer method.

To send all contacts

- ▶ Phonebook ▶ Options ▶ Advanced
- ▶ Send all contacts and select a transfer method.

Checking the memory

With the memory status function, you can check how many positions you have left in the phone memory and SIM memory.

To check the memory

- ▶ Phonebook ▶ Options ▶ Advanced
- ▶ Memory status.

**Synchronizing contacts**

You can back up and synchronize your contacts with a contacts application on the Web. For more information, please contact your service provider. You can also synchronize your contacts with a computer application, ➤ 65 *Synchronizing*.





To synchronize contacts

- 1 ▶ Phonebook ▶ Options ▶ Sync. contacts.
- 2 If you have more than one account, select which account to use ▶ **Select**. If you do not have an account in the phone, ➤ 66 *To enter the remote synchronization settings*.

Call list

The numbers of the most recent calls are saved in the call list. Dialed, answered and missed calls are listed under separate tabs.

To call a number from the call list

- 1 ▶ **Calls** in standby and select a tab.
- 2 Use , ,  and  to scroll to the name or number you want to call ▶ **Call**, or  to make a video call.

To add a number from the call list to the phonebook

- 1 ▶ **Calls** in standby and select a tab.
- 2 Scroll to the number you want to add ▶ **More** ▶ **Save number**.
- 3 ▶ **New contact** to create a new contact, or select an existing contact to add the number to.

To clear the call list

- ▶ **Calls** and scroll to the tab with all calls ▶ **More** ▶ **Delete all**.

Speed dialling

You can save the phone numbers that you want to reach easily in positions 1-9 in your phone.

To speed dial

- From standby, enter the position number and ▶ **Call**.

To set or replace speed dialling numbers

- 1 ▶ Phonebook ▶ Options ▶ Speed dial.
- 2 Scroll to a position in the list ▶ **Add or Replace**. Select a phone number.

Vocicemail

If your subscription includes an answering service, callers can leave a voicemail message when you cannot answer a call.

Calling your voicemail service

You can easily call your voicemail service by pressing and holding **1**. If you have not set your voicemail number, you will be asked if you want to enter the number. ► **Yes** to enter the number. You get the number from your network operator.

To enter your voicemail number

► **Messaging** ► **Settings** ► **Vocicemail number**.

Voice control

With your phone, you can use your voice to:

- Voice dial – call someone by saying the name.
- Activate voice control by saying a “magic word”.
- Answer and reject calls when using a handsfree kit.

Voice commands can only be saved in the internal phone memory, not on the SIM card. When recording, make sure that you are in a quiet environment and try to use names that are distinct from each other, ► *30 Tips when recording and using voice commands*.

Before voice dialling

You must first activate the voice dialling function and record your voice commands. An icon appears next to a phone number that has a voice command.



*Turn the media player off before recording voice commands. Press **⏸** and then **⏪** to turn off.*

To activate voice dialling and record names

- 1 ► **Settings** ► the **General** tab ► **Voice control** ► **Voice dialling** ► **Activate** ► **Yes** ► **New voice** and select a contact.
- 2 If the contact has more than one number, use **⦿** and **⦿** to view the numbers. Select the phone number to which you want to add the voice command. Now you are going to record a voice command such as “John mobile” for the phone number you selected.
- 3 Instructions appear. Wait for the tone and say the command that you want to record. The voice command is played back to you.
- 4 If the recording sounds ok ► **Yes**. If not ► **No** and repeat step 3.
- 5 To record another voice command for a contact ► **New voice** ► **Add** again and repeat steps 2-4 above.

Caller name

You can choose whether you want to hear the recorded contact name when you receive a call from that contact.

To turn the caller name on or off

- ▶ Settings ▶ the General tab ▶ Voice control
- ▶ Play caller name.

Voice dialling

You can voice dial by saying a pre-recorded voice command. Start voice dialling from standby using the phone, a portable handsfree, a Bluetooth headset or by saying your magic word.

To make a call from the phone

- 1 From standby, press and hold one of the volume buttons.
- 2 Wait for the tone and say the name you recorded earlier, for example “John mobile”. The name is played back to you and the call is connected.

To make a call with a handsfree

From standby, press the handsfree button, or the Bluetooth headset button.

The magic word

You can record a magic word and use it as a voice command to allow totally handsfree access to voice dialling. Instead of pressing and holding a volume button to voice dial, you say the magic word and then one of your recorded voice commands. The magic word is especially suitable when using a car handsfree kit.



Choose a long, unusual word or phrase that can easily be distinguished from ordinary background speech.

To activate and record the magic word

- 1 ▶ Settings ▶ the General tab ▶ Voice control ▶ Magic word ▶ Activate.
- 2 Instructions appear. ▶ Continue. Wait for the tone and say the magic word.
- 3 Instructions appear. ▶ Continue and select the environments in which you want your magic word to be activated. You can select several alternatives.

Calling

Voice answering

You can answer or reject incoming calls by using your voice, when using a portable or car handsfree kit.



You can only use a MIDI, WAV, EMY or IMY file as a ringtone with voice answering.

To activate voice answering and record voice answer commands

- ▶ Settings ▶ the General tab ▶ Voice control ▶ Voice answer ▶ Activate.
- Instructions appear. ▶ Continue. Wait for the tone and say “Answer”, or another word. If the recording sounds ok ▶ Yes. If not ▶ No and repeat step 2.
- Say “Busy”, or another word ▶ Yes.
- Instructions appear. ▶ Continue and select the environments in which you want voice answering to be activated. You can select several alternatives.

To answer a call using voice commands

When the phone rings, say “Answer” and the call is connected.

To reject a call using voice commands

When the phone rings, say “Busy”. The call is rejected. The caller is diverted to voicemail, if activated, or hears a busy tone.

Editing your voice commands

You can edit all your voice commands saved in Phonebook. Select the contact you want to edit a voice command for ▶ More ▶ Edit contact. Scroll to the relevant tab and edit your voice command.

To re-record a voice command

- ▶ Settings ▶ the General tab ▶ Voice control ▶ Voice dialling ▶ Edit names.
- Select a voice command ▶ More ▶ Replace voice.
- Wait for the tone and say the command.

Tips when recording and using voice commands

If your phone cannot detect your voice command, one of the following might have happened:

- You spoke too softly – try speaking louder.
- You held the phone too far away – hold it as you do during a call.

- The voice command was too short – it should be around one second long and more than one syllable.
- You spoke too late or too soon – speak immediately after the tone.
- You did not record the voice command when the handsfree was attached – for voice control with a handsfree kit, record when the handsfree is attached.
- You used another intonation – use the same intonation as in the recorded voice command.



Diverting calls

If you cannot answer incoming calls, you can divert them to another number, for example, your answering service.



When the Restrict calls function is activated, some Divert calls options are not available.

You can choose between the following divert options:

- **Divert always** – divert all calls.
- **When busy** – divert calls if you are already on the phone.
- **Not reachable** – divert calls if your phone is turned off or if you are unreachable.
- **No reply** – divert calls that you do not answer within a specified time limit.

To activate a call divert

- 1 ▶ Settings ▶ the Calls tab ▶ Divert calls.
- 2 Select a call type and then one of the divert options ▶ Activate.
- 3 Enter the phone number to which you want your calls to be diverted, or press Look up to find the contact ▶ OK.

To deactivate a call divert

Scroll to the divert option ▶ Deactivate.

To check all divert options

▶ Settings ▶ the Calls tab ▶ Divert calls ▶ Check all.

More than one call

You can handle more than one call simultaneously.

Call waiting service

When the service is activated, you hear a beep if you receive a second call.

To activate or deactivate the call waiting service

- ▶ Settings ▶ the Calls tab ▶ Manage calls
- ▶ Call waiting.

Calling

To make a second call

- 1 ▶ **Hold** to put the ongoing call on hold.
- 2 Enter the number you want to call ▶ **Call**.

Receiving a second voice call



When you receive a second call, you can do the following:

- ▶ **Answer** and put the ongoing call on hold.
- ▶ **Busy** to reject the second call and continue the ongoing call.
- ▶ **Replace active call** to answer the second call and end the ongoing call.



Handling two voice calls

When you have one ongoing call and one call on hold, you can do the following:

- ▶ **Switch** to switch between the two calls.
- Press  ▶ **Join calls** to join the two calls into a conference call.
- Press  ▶ **Transfer call**, to connect the two calls. You are disconnected from both calls.
- ▶ **End call** to end the ongoing call, then press **Yes** to retrieve the held call.
- ▶ **End call** ▶ **No** to end both calls.

You cannot answer a third call without ending one of the first two calls or joining them into a conference call.

Conference calls

In a conference call, you can have a joint conversation with up to five other people. You can also put a conference call on hold and make another call.





There may be additional charges for calls involving multiple parties, contact your network operator for more information.

To join the two calls into a conference call

Press  ▶ **Join calls**.



To add a new participant

- 1 ▶ **Hold** to put the joined calls on hold.
- 2 Press  ▶ **Add call** and call the next person you want to include in the conference call.
- 3 Press  ▶ **Join calls**.
- 4 Repeat steps 1-3 to include more participants.

To release a participant

Press  ► **Release part** and select the participant that you want to release from the conference call.

To have a private conversation

- 1 Press  ► **Talk to** and select the participant that you want to talk to.
- 2 Press  ► **Join calls** to resume the conference call.

**Two voice lines**

If you have a subscription that supports an alternate line service, your phone may have two voice lines with different phone numbers.

To select a line for outgoing calls

► **Settings** ► the **Calls** tab and select line 1 or 2.

To change the name of a line

► **Settings** ► the **Display** tab ► **Edit line names** and select one of the lines to edit the name.

My numbers

View, add and edit your own phone numbers.

To check your phone numbers

► **Phonebook** ► **Options** ► **Special numbers**
 ► **My numbers** and select one of the options.

Accept calls

With the accept calls service, you can choose to receive calls only from certain phone numbers. Other calls are automatically rejected by a busy tone. If the call divert option **When busy** is activated, calls are diverted instead of rejected by a busy tone. The phone numbers of calls you have rejected are saved in the call list.

To add numbers to the accepted callers list

- 1 ► **Settings** ► the **Calls** tab ► **Manage calls**
 ► **Accept calls** ► **Only from list** ► **Edit** ► **New**
 ► **Add**. Select a contact.
- 2 To add a group of contacts to the accepted callers list ► **Groups** (requires that you have created groups, ➔ *35 Groups*).

To accept all calls

► **Settings** ► the **Calls** tab ► **Manage calls**
 ► **Accept calls** ► **All callers**.



Restricted dialling

You can use the restrict calls service to restrict outgoing and incoming calls. You need a password which you get from your service provider.



If you divert incoming calls, you cannot activate some Restrict calls options.

The following calls can be restricted:

- **All outgoing** – All outgoing calls.
- **Outgoing intl** – All outgoing international calls.
- **Outgoing intl roam.** – All outgoing international calls except to your home country.
- **All incoming** – All incoming calls.
- **Inc. when roaming** – All incoming calls when you are abroad (when roaming).

To activate or deactivate a call restriction

- 1 ▶ **Settings** ▶ the **Calls** tab ▶ **Manage calls** ▶ **Restrict calls** and select an option.
- 2 Select **Activate** or **Deactivate**, enter your password ▶ **OK**.



Fixed dialling

The fixed dialling function allows calls to be made only to certain numbers saved on the SIM card. The fixed numbers are protected by your PIN2.



You can still call the international emergency number, 112, even when the fixed dialling function is activated.

Partial numbers can be saved. For example, saving 0123456 allows calls to be made to all numbers starting with 0123456.



When fixed dialling is activated, you cannot view or manage any phone numbers that are saved on the SIM card.

To activate or deactivate fixed dialling

- 1 ▶ **Phonebook** ▶ **Options** ▶ **Special numbers** ▶ **Fixed dialling** and select **Activate** or **Deactivate**.
- 2 Enter your PIN2 ▶ **OK** and then ▶ **OK** again to confirm.

To save a fixed number

- ▶ **Phonebook** ▶ **Options** ▶ **Special numbers** ▶ **Fixed dialling** ▶ **Fixed numbers** ▶ **New number** and enter the information.



Call time and cost

During a call, the duration of the call is shown on the screen. You can check the duration of your last call, outgoing calls and the total time.

To check the call time

- ▶ Settings ▶ the Calls tab ▶ Time & cost
- ▶ Call timers.

Additional calling functions

Tone signals

You can use telephone banking services or control an answering machine by sending tone signals during a call.

- To send the tones, press the keys **(0 +)** - **(9)**, **(* a/A)** or **(# ↵)**.
- To clear the screen after the call is finished, press **(C)**.
- To turn the tones off during the call press **(⊙)**
▶ Turn off tones.

Notepad

You can use the phone to make a note of a phone number during a call. When you press the number keys, the person you are talking to hears tone

signals. When you end the call, the number remains on the screen. ▶ Call to call the number. ▶ More ▶ Save number and select a contact to save the number. If you want to create a new contact and save the number ▶ New contact.

Showing or hiding your number

If your subscription supports the Calling Line Identification Restriction (CLIR) service, you can hide your phone number when making a call.

To always show or hide your phone number



- 1 ▶ Settings ▶ the Calls tab ▶ Show or hide no.
- 2 Select Show number, Hide number or Network default.

Groups

You can create a group of numbers and email addresses, if you have selected **Contacts** as default phonebook. By doing so, you can send messages to several recipients at the same time, ➤ 36 *Messaging*. You can also use groups (with numbers) when you create accepted callers lists, ➤ 33 *Accept calls*.

Messaging

To create a group of numbers and email addresses

- 1 ▶ Phonebook ▶ Options ▶ Groups ▶ New group ▶ Add.
- 2 Enter a name for the group ▶ Continue.
- 3 ▶ New ▶ Add to find a contact.
- 4 ▶ Select to select a contact.
- 5 Select a number or an email address from the contact. If the contact has more than one item, use  and  to view the items.
- 6 Repeat steps 3-4 to add more numbers or email addresses. ▶ Done to save the group.

Business cards

You can add your own business card as a contact.

To add your own business card

- ▶ Phonebook ▶ Options ▶ My business card and add information for your business card ▶ Save.

To send your business card

- ▶ Phonebook ▶ Options ▶ My business card ▶ Send my card and select a transfer method.

Messaging

Text messaging, picture messaging, email, My friends.



Your phone supports various messaging services. Please contact your service provider about the services you can use or for more information, visit www.SonyEricsson.com/support.

Text messaging (SMS)

Text messages can contain simple pictures, animations, melodies and sound effects.



If you send a text message to a group, you are charged for each member of that group.

Before you start

First make sure that the number of your service centre is set. The number is supplied by your service provider and is usually saved on the SIM card.

To set the service centre number

- 1 ▶ Messaging ▶ Settings ▶ Text message ▶ Service centre. If the service centre number is saved on the SIM card, it is shown in the list.
- 2 If there is no number in the list ▶ Add and enter the number, including the international “+” sign and country code ▶ Save.

 *To send a message to an email address, you need to set an email gateway number; ▶ Messaging ▶ Settings ▶ Text message ▶ Email gateway. The number is supplied by your service provider.*

Sending text messages

For information about entering letters,
 14 Entering letters.

 *Some language-specific characters use more space. For some languages you can deactivate National chars. to save space.*

To write and send a text message

- 1 ▶ Messaging ▶ Write new ▶ Text message.
- 2 Write your message ▶ Continue. If you want to save the message for later, press .
 ▶ Yes to save it in Drafts.

- 3 ▶ Enter phone no. and enter the recipient's phone number, or ▶ Phonebook look-up to retrieve a number or a group from Phonebook. To enter an email address ▶ Enter email address. A list below the send options shows the last used recipients. You can also select a recipient from this list. ▶ Send.

To insert an item in a text message

- 1 While writing your message ▶ More ▶ Add item.
- 2 Select an item type and then an item.

Formatting text

You can change the style, size and alignment of the text, and create new paragraphs.

 *Text formatting only applies when Latin characters are used.*

To format the text in a text message

- 1 ▶ Messaging ▶ Write new ▶ Text message.
- 2 While writing your message ▶ More ▶ Text format. Then select Text size, Text style, Alignment or New paragraph.
- 3 Select a text format.

Messaging

Receiving text messages

When you receive a text message, a message alert sounds. ▶ **Yes** to read the text message, or ▶ **No** if you want to read the message later.

When you have read the text message ▶ **More** to view a list of options. Press  to close the text message.

To call a number in a text message

Select the phone number ▶ **Call**.

Saving and deleting text messages

Text messages are saved in the phone memory. When the phone memory is full, you must delete messages or move them to the SIM card to be able to receive new messages. Messages that you have saved on the SIM card remain there until you delete them.

To save a message to the SIM card

- ▶ **Messaging** ▶ **Inbox** ▶ **More** ▶ **Save message**
- ▶ **Saved messages**.

To save an item from a text message

- 1 Select the phone number, Web address, picture or sound that you want to save in the message
▶ **More**.
- 2 If you have selected to save a phone number
▶ **Use** ▶ **Save number**. If you have selected a Web address ▶ **Save bookmark**, a picture
▶ **Save picture**, a melody ▶ **Save sound**.

To save or delete several messages

- 1 ▶ **Messaging** and select a folder.
- 2 Select a message ▶ **More** ▶ **Mark several**.
- 3 Scroll and select more messages by pressing **Mark** or **Unmark**.
- 4 ▶ **More** ▶ **Save messages** or ▶ **More**
▶ **Delete messages** or ▶ **Delete all msgs**.

To delete a message

- 1 ▶ **Messaging** and select a folder.
- 2 Select the message that you want to delete and press .

Long messages

The number of characters that a text message can contain depends on the language you are writing in. You can send a longer message by linking two or more messages. You are charged for each of the messages linked in a long message. You may not receive all parts of a long message at the same time.



Check with your service provider for the maximum number of messages that can be linked.

To turn long messages on

- ▶ Messaging ▶ Settings ▶ Text message
- ▶ Max. msg length ▶ Max. available.

Templates

If you have messages that you send often, you can save these as templates. You can create your own templates.

To create a template

- 1 ▶ Messaging ▶ Templates ▶ New template
▶ Add ▶ Text.
- 2 Write the message ▶ OK.
- 3 Enter a title for the message ▶ OK.

Message options

You can set a default value for several message options or choose the settings each time you send a message.

To set a default text message option

▶ Messaging ▶ Settings ▶ Text message and select an option.

To set a message option for a specific message

- 1 When you have selected a recipient to send your text message to ▶ More ▶ Advanced.
- 2 Select the option that you want to change
▶ Edit and select a new setting.
- 3 ▶ Done when you have changed the options.

Picture messages (MMS)

Picture messages can contain text, pictures, video clips, camera pictures, sound recordings, and business cards. You must have a subscription that supports picture messaging, and the receiver of the picture message must also have support for picture messaging. You can send picture messages to a mobile phone or an email address.

Messaging

Before you start

Before sending a picture message, make sure that:

- 1 The address of your message server is set
 - ▶ **Messaging** ▶ **Settings** ▶ **Picture msg**
 - ▶ **Message server**.
- 2 You have entered the correct settings
 - ▶ **Messaging** ▶ **Settings** ▶ **Picture msg**
 - ▶ **Internet profile**. If no Internet profile exists
 - ▶ **New profile** and enter the required settings.You can also automatically receive all the settings in a message from your network operator or from www.SonyEricsson.com/support.

Creating and sending picture messages

When composing a picture message, you select from different items such as: **Camera**, **Picture**, **Text**, **Sound**, **Video**, and **Sound recording**.

Before sending a picture message, you can select from different options to adjust and enhance your message.

To create and send a picture message

- 1 ▶ **Messaging** ▶ **Write new** ▶ **Picture msg** ▶ **Add** to view a list of items to add to your message. Select an item.
- 2 ▶ **Add** to add more items to the message. You can view and select options to enhance the message by highlighting items in the message and pressing the left selection key.
- 3 When you have finished composing your message ▶ **More** ▶ **Send**.
- 4 ▶ **Enter phone no.** and enter the recipient's phone number, or ▶ **Phonebook look-up** to retrieve a number or a group from **Phonebook**. To enter an email address ▶ **Enter email address**. A list below shows the last 10 recipients. You can also select a recipient from this list. ▶ **Send**.

To make a call while creating a picture message

- 1 While writing your message ▶ **More**.
- 2 ▶ **Make a call** and enter or retrieve a phone number ▶ **Call**. You return to the message.
- 3 To end the call ▶ **More** ▶ **End call**.

To set a default message option

► **Messaging** ► **Settings** ► **Picture msg** and select one of the options.

Additional send options

You can request a delivery report, a read report, and set a validity period for a specific message. You can also add more recipients to the message.

To select additional send options

- 1 When you have entered the recipient's phone number ► **More**.
- 2 Select **Add recipient** to add another recipient, **Recipients** to add or edit any recipients, **Add attachment**, or **Advanced** to select additional send options.

Receiving picture messages

When you receive an automatically downloaded picture message, a message alert sounds. ► **Yes** to read or play the message. ► **Stop** to stop the message. When you have read the message press **Reply** to reply immediately or press **More** to view a list of options. Press  to close the message.

To save items from a picture message

When you have viewed a picture message ► **More** ► **Save items** and select an item from the list that appears.

Delete picture messages

Picture messages are saved in the phone memory. When the phone memory is full, you must delete messages to be able to receive new messages, ► **38 To save or delete several messages** and ► **38 To delete a message**.

Templates

You can base your message on one of the templates. You can also create your own templates.

To use a template for a picture message

- 1 ► **Messaging** ► **Templates** and select a template ► **Use**.
- 2 ► **Add** to add new items or highlight individual items in the message and press the left selection key to edit them.
- 3 ► **More** ► **Send** to send the message.

Messaging

To create a new template for a picture message

- 1 ▶ Messaging ▶ Templates ▶ New template
▶ Add ▶ Picture msg.
- 2 ▶ Add to add new items.
- 3 ▶ More ▶ Save template ▶ Select to save the template.
- 4 Edit the name of the template ▶ OK.

Automatic download

You can select how you want your picture messages to be downloaded.

- ▶ Messaging ▶ Settings ▶ Picture msg
- ▶ Auto download to view the following:
 - **Always** – your phone automatically downloads messages to your phone as soon as they come to your network operator's server. This is default.
 - **Ask in roaming** – you will be asked if you want to download messages sent from a network other than your home network.
 - **Never in roam.** – the messages are never downloaded when they are sent from a network other than your home network.
 - **Always ask** – you will always be asked if you want to download messages, regardless of network used.
 - **Off** – new messages appear in the inbox as icons. Select the message ▶ View to download.

Email

You can use your phone to send and receive email messages. You can use the same email settings in your phone as in your computer email program. For more information, contact your network operator or service provider.

Before you start

First make sure that:

- Settings are in your phone, if not, ➡ 61 Settings.
- You have set up and selected an email account. To download the email account settings visit www.SonyEricsson.com/support. Have your email account details at hand.

Default email account

If you have both an office and a home email account, you can set one of them as default:

- ▶ Messaging ▶ Email ▶ Settings and select an account.

To write and send an email message

- 1 ▶ Messaging ▶ Email ▶ Write new.
- 2 Write the subject for your message ▶ Continue and then write the text ▶ Continue.

- 3 ▶ Enter email address to enter an email address or ▶ Phonebook look-up to retrieve an address from Phonebook.
- 4 ▶ Send to send your email message or ▶ More to view a list of options for your message.

To send, receive and read email messages

- 1 ▶ Messaging ▶ Email ▶ Inbox ▶ Send&rec (when inbox is empty) or ▶ Messaging ▶ Email ▶ Inbox ▶ More ▶ Send & receive to send or download new messages.
- 2 Select a message ▶ View to read it.

To reply to an email message

- 1 Open the email message ▶ Reply.
- 2 ▶ Include message to include the original message in your reply or ▶ Write new to exclude the original message. Write your message. ▶ More to view options for the message.
- 3 ▶ Send to send the message or ▶ More to view a list of options for your message.

To save an email address or a phone number in an email message

- 1 Select the email address or phone number that you want to save ▶ More.
- 2 To save an email address ▶ Save email. To save a phone number ▶ Use ▶ Save number.

To save an email message

- 1 Open the email message ▶ More ▶ Save message ▶ Saved email.
- 2 The message is saved in Saved email in the Email menu.



The number of email messages that can be saved depends on how much memory there is left in the phone. All email messages are also saved on your email server, and you can view both older and newer messages on the server.

To save several email messages

- 1 ▶ Messaging ▶ Email ▶ Inbox.
- 2 Select a message ▶ More ▶ Mark several.
- 3 Scroll and select more messages by pressing Mark or Unmark.
- 4 ▶ More ▶ Save messages.

Messaging

To delete an email message (POP3 users)

- 1 ▶ **Messaging** ▶ **Email** ▶ **Inbox** and select the message ▶ **More**.
- 2 ▶ **Mark for deletion**. The message is deleted the next time you connect to your email server. If you want to delete several messages ▶ **Mark several**. Scroll and select more messages by pressing **Mark** or **Unmark**.
▶ **More** ▶ **Mark for deletion**.

To delete an email message (IMAP4 users)

- 1 ▶ **Messaging** ▶ **Email** ▶ **Inbox** and select the message ▶ **More**.
- 2 ▶ **Mark for deletion**. The message is marked for deletion on the server. If you want to delete several messages ▶ **Mark several**. Scroll and select more messages by pressing **Mark** or **Unmark**. ▶ **More** ▶ **Mark for deletion**.
- 3 ▶ **More** ▶ **Clear inbox** and press **With send & rec.** or **No send & rec.** to delete messages.

My friends

Connect to the My friends server to communicate online with your favourite contacts. If your subscription supports instant messaging services, you can see contact status if they are online, and send and receive instant messages.

For more information, contact your service provider or see www.SonyEricsson.com/support.

Logging in to the My friends server

Select to log in each time when sending or receiving instant messages, or log in automatically when turning on the phone.

To log in to your My friends server

▶ **Messaging** ▶ **My friends** ▶ **Myself** ▶ **Log in**.

List of contacts

You can create a list of contacts, people you want to send messages to on a regular basis. You can add contacts from your phonebook or from your My friends server.

To add a contact from a network server

- ▶ Messaging ▶ My friends ▶ More ▶ Add contact
- ▶ From server and follow the instructions that appear.

Status

View the status of your contacts and choose to show your own status to others using the following options:

- **Picture** – select or take a new picture.
- **About me:** – write a short text about yourself.
- **Availability:** – select if you are available or not.
- **Mood:** – select a mood from the list.
- **Show my status:** – select to show your status.
- **Alias:** – write the name you want to be associated with.
- **Username:** – view your username.

To change your own status

- ▶ Messaging ▶ My friends ▶ Myself ▶ Change.

Chatroom

A chatroom can be started by your service provider, by an individual My friends user or by yourself. You can save chatrooms either by saving a chat invitation or by searching for a specific chatroom.

To start a chatroom

- 1 ▶ Messaging ▶ My friends ▶ More ▶ Start chatroom.
- 2 Select contacts to invite to the chatroom from your list of contacts ▶ **Continue**.
- 3 Enter a short invitation text ▶ **Continue** ▶ **Send**.



Area information

Area information is a type of text message that is sent to all subscribers within a certain network area. When you receive an area information message, the message automatically appears on the screen. Press **Save** to save the message in your inbox, or **Discard** to delete the message.

To turn area information on or off

- ▶ Messaging ▶ Settings ▶ Area info ▶ Reception.



Cell information

The cell information channel is used by some network operators to send messages about a certain network area to their subscribers within that area.

To turn on cell information

- ▶ Messaging ▶ Settings ▶ Area info ▶ Cell information.

Imaging

Camera, video recorder, pictures, wallpaper.

Camera and video recorder

Your phone has a digital Motion Eye™ camera which also works as a video recorder. The camera lens can be rotated to point inwards towards you, or outwards, away from you.

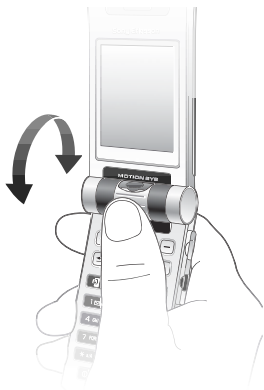



You can take pictures, record video clips, save and view them and send them as email attachments or in picture messages via MMS.

Before you start

The phone that you are sending the picture or video clip to needs to support data transmission and picture messaging in order to receive and show the picture or video clip.

- Before you send a picture or video clip using picture messaging make sure that you have set the address of your message server for picture messaging, ➤ *39 Picture messages (MMS)*, and that Internet settings are entered in your phone, ➤ *61 Settings*.
- Before you send a picture or video clip using email make sure that you have entered settings for a data account and for an email account in your phone, ➤ *42 Email*.

Light





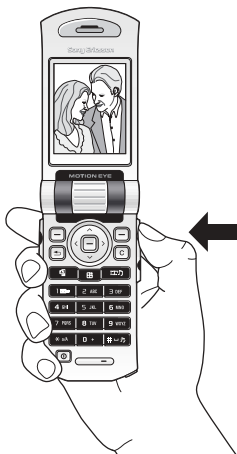

Your phone has a light which is placed around the lens. To take pictures or record video clips in a dimly lit environment, press and hold  to turn on the camera light. To turn off the camera light, press . If you do not turn the light off, it will be deactivated after a while, in order to save battery. To enhance lighting conditions further, you can select **More** ▶ **Night mode**.

 Do not look directly at the camera light diodes of the phone using a magnification device. Failure to comply with this warning may damage your eyes.



To take pictures and record video clips with the phone open

Press and hold  to activate the camera.



- Press  to switch to camera if video recorder is activated. ► **Capture** to take a picture. When the lens is turned outwards the picture is automatically adjusted to the correct orientation: heads up, feet down. In the top right corner of the screen, a counter shows the number of pictures you can still save (when less than 1000). The smaller the picture size, the more pictures you can save. To delete a picture you have taken, press . To save the picture and return to the viewfinder, press . Camera pictures are saved in **File manager ► Pictures ► Camera pictures**.
- Press  to switch to video recorder if the camera is activated. ► **Record** to start the recording. You record video clips with the phone held in a vertical position. ► **Pause** if you want to pause during the recording. To delete a video clip you have recorded, press . To save the video clip and return to the viewfinder, press . Camera video clips are saved in **File manager ► Videos ► Cam. video clips**.

To use the zoom

Press  to zoom in on a subject. Press  to zoom out.

Imaging

To adjust brightness

Press **(+)** or **(-)** to increase or decrease brightness.



Taking pictures with the phone closed

You can take pictures in two ways: either with the phone closed, or open. With the phone closed, the external display works as a viewfinder.

The camera (when used with the phone closed) is deactivated 15 seconds after you last press a button.

 *You cannot change any settings when taking pictures with the phone closed, except for the adjusting of brightness.*



To take pictures with the phone closed

- 1 Press and hold  to activate the camera.
- 2 Press  to take a picture. The picture is displayed and saved in **File manager** ► **Pictures** ► **Camera pictures**.
- 3 Press  again to return to the viewfinder mode.

 *If you open the phone while using the camera, the viewfinder automatically switches to the screen.*

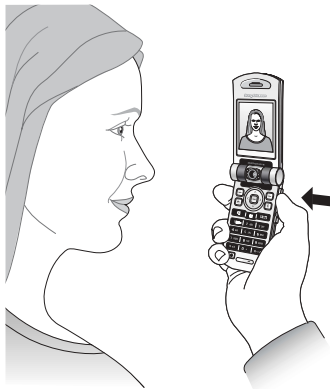
To take a self-portrait



- 1 Hold the phone with the viewfinder turned towards you.
- 2 Press and hold  on the side of the phone to activate the camera.
- 3 Make sure that you have selected the camera, and not the video recorder. Press  again to take the picture.

Camera options

When the camera is activated press **More** to view more options.



All phones that support pictures can receive the picture size 160x120. Some phones that support pictures cannot receive the picture sizes 640x480 and 1280x1024. The best picture size to view on a computer is 1280x1024.

Options with “*” are only available when Memory Stick Duo is inserted in your phone.

- **View all pictures** – view all your pictures.
- **Picture size** – choose between 160x120, 640x480 and 1280x1024 pixels.
- **Night mode** – enhance picture quality with longer exposure time.
- **Effects** – select different effects for your picture.
- **Frames** – add a frame to your picture.
- **Panorama** – you can create a panorama picture by taking a series of three pictures that are merged into one picture. For best result, make sure that the pictures you take overlap.
- **Picture quality** – select quality for your picture. The higher the quality, the more memory capacity is required.
- **Self-timer** – the picture is taken a few seconds later.

- **Reset file no.*** – reset the numbering of the pictures taken with the camera, which are saved on the Memory Stick Duo.
- **Save to*** – select where to save pictures taken with the camera.

Video options

When the video recorder is activated press **More** to view more options. Options with “*” are only available when Memory Stick Duo is inserted in your phone:

- **View all clips** – view all your video clips.
- **Video size** – choose between 176x144 and 128x96 pixels.
- **Night mode** – enhance video clip quality with longer exposure time.
- **Effects** – select different effects for your video clip.
- **Shoot mode** – choose between **For picture msg**, to fit the video clip in a picture message, or **High quality video**.
- **Save to*** – select where to save video clips recorded with the video recorder.

Imaging



Saving pictures and video clips

When you have taken a picture or recorded a video clip, the phone automatically saves it. Pictures that you take are saved in the **Camera pictures** subfolder, and clips you record are saved in the **Cam. video clips** subfolder. If the Memory Stick Duo is full, you cannot save any more pictures or video clips on it until you have deleted an item from it.



Sending pictures and video clips

When you have taken a picture or recorded a video clip, you can send them instantly in a picture message. To exchange pictures and video clips using other transfer methods ➔ *52 Exchanging pictures*.

To take and send a picture

- 1 Press and hold  to activate the camera. Press  to switch to the camera if the video recorder is activated.
- 2 Take a picture by pressing **Capture**.
- 3 ▶ **Send** and create your picture message.

To record and send video clips

- 1 Press and hold  to activate the camera. Press  to switch to the video recorder if the camera is activated.
- 2 ▶ **Record** to start the video recording. ▶ **Stop** to end the recording.
- 3 When you have finished the recording, select **Play** to view the video clip or **Send** and create your picture message to send the video clip. If you want to delete the recording, press .

Pictures

Your phone comes with a number of pictures and animations. You can delete the pictures that come with your phone if you, for example, want to free memory. All pictures are saved in **File manager** ▶ **Pictures**. You can:

- Have a picture as wallpaper and as screen saver, ➔ *51 Using pictures*.
- Assign a picture to a contact in the phonebook, ➔ *51 Using pictures*.
- Exchange pictures using one of the available transfer methods, ➔ *52 Exchanging pictures*.

Handling pictures

You can add, edit, or delete pictures in **File manager**. The number of pictures that you can save depends on the size of the pictures. File types supported are GIF, JPEG, WBMP, PNG, SVG and BMP.

To view your pictures

- 1 ▶ **File manager** ▶ **Pictures**.
- 2 The pictures are shown in thumbnail view.
To get a full view ▶ **View**.

To display pictures in a slide show

- 1 ▶ **File manager** ▶ **Pictures** and scroll to a picture.
- 2 ▶ **View** ▶ **More** ▶ **Slide show**.

To view information about a picture or a video clip

- 1 ▶ **File manager** ▶ **Pictures** or **Videos**, select the picture or video clip.
- 2 ▶ **More** ▶ **Information**.

To download a picture

- 1 ▶ **File manager** ▶ **Pictures** ▶ **Sony Ericsson**.
- 2 Follow the instructions on the screen.

Using pictures





You can use a picture for several purposes, for example, add it to a contact, use it in the start-up screen, or use it as a screen saver. The screen saver is activated automatically when the phone has been in idle mode for a few seconds. After a few more seconds, the screen saver changes to sleep mode, to save power. Press any key on the keypad and the screen turns on again. If you have a picture as wallpaper, this picture is shown in standby mode. You can select wallpaper both for the screen, and for the external display.













To use a picture

- 1 ▶ **File manager** ▶ **Pictures** and scroll to the picture you want to use ▶ **More** ▶ **Use**.
- 2 Select what you want to use the picture for.

Imaging

Editing pictures

When editing pictures, press , ,  or , or use the keys as follows:

Key	Function	Key	Function
	Activate tool		Left
	Select tool		Left up
	Select colour		Left down
	Exit the picture editor		Right
	Undo		Right up
	Up		Right down
	Down		

To edit and save a picture

- ▶ **File manager** ▶ **Pictures** and scroll to the picture you want ▶ **View** ▶ **More** ▶ **Edit**. You can now start to edit the picture. To edit pictures taken with the camera, you must select 160 x 120 as picture size.
- ▶ **More** ▶ **Save picture** to save the picture.

Exchanging pictures

You can exchange pictures using one of the available transfer methods. Please note that you are not allowed to exchange copyright-protected material. For more information on sending pictures in messages, ▶ *39 Picture messages (MMS)*. To use the USB cable, ▶ *70 Transferring files using the USB cable*.

To send a picture

- ▶ **File manager** ▶ **Pictures** and scroll to the picture you want ▶ **More** ▶ **Send**.
- Select a transfer method.

To receive and save a picture

- Open the message you received the picture in, or turn on Bluetooth or the infrared port if these transfer methods are being used to send the picture.
- If you received the picture in a message ▶ **More** ▶ **Save items**. If you received the picture via Bluetooth or the infrared port, follow the instructions that appear on the screen.

Remote screen

You can view your pictures on a remote screen, for example, a TV, when using a compatible Bluetooth adaptor. The adaptor is an accessory, and not included in the box. Please refer to the adaptor user guide for information on how to connect your phone and the remote screen.

To connect to a remote screen

- ▶ **File manager** ▶ **Pictures** and scroll to the picture you want ▶ **View** ▶ **More** ▶ **Remote screen**.
- The phone searches for other Bluetooth devices and a list of available devices is displayed. Select the device you want to use. For more information about connecting using Bluetooth, ➡ *66 Bluetooth™ wireless technology*.

Entertainment

Media player, PlayNow™, ringtones, MusicDJ™, sound recorder, themes, games.

Media player

The media player works as a music player and video player all in one. You can play music and video clips that you receive in a picture message, or that you download to your phone. The following file types are supported by the media player: MP3, MP4, 3GP and WAV (with 16 kHz as maximum sample rate).

You can also stream music and videos from Web sites. When streaming, links have to be 3GPP compatible.

Playlists

To organize the media files that are stored in the **File Manager** you can create playlists. A playlist can contain music as well as video clips. Files in a playlist can be sorted by artist, title or by the order in which the files were added to the playlist. You can add a file to more than one playlist.

Entertainment

The playlists **All music** and **All videos** are automatically generated and contain all music and video files that are saved in the phone memory and on the Memory Stick Duo. You cannot delete or rename these playlists.

To create a playlist

- 1 ▶ **Media Player** ▶ **More** ▶ **New playlist** ▶ enter the name of the playlist ▶ **OK**.
- 2 Select among the files that are available in the **File Manager**. You can add several files at a time and you can search folders. You can also add folders. All files in the selected folders will be added to the playlist.

To add files to a playlist

- 1 ▶ **Media Player**, select a playlist ▶ **Open** ▶ **More** ▶ **Add media**.
- 2 Select among the files that are available in the **File Manager**. You can add several files at a time and you can search folders. You can also add folders. All files in the selected folders will be added to the playlist.

To remove files from a playlist

- 1 ▶ **Media Player**, select a playlist ▶ **Open**.
- 2 Select the file and press **C**.



When you remove a file from the playlist, it is not deleted permanently from the phone memory. You can add the file to another playlist.

To delete playlists

- ▶ **Media Player**, select a playlist and press **C**.



When you delete a playlist, you do not delete any of the files in the playlist. You can add those files to another playlist.

Music and video clips

To play music and videos











- ▶ **Media Player** and select a playlist ▶ **Open** ▶ **Play**. The playlist keeps on playing until you press **Pause** or **Stop**.

To change play mode

- 1 ▶ **Media Player** ▶ **More** ▶ **Play mode**.
- 2 Select **Shuffle on** to play the playlist files in random order, or **Loop on** to restart the playlist when the last file has been played.

 You can also change the play mode from within the playlists.

Media player control

- ▶ **Pause** to pause the playback. With phone closed, press  to pause or resume playback.
- Press  or  to go forward or back to the next music track or video clip.
- Press and hold  or  to fast forward or rewind.
- Press  and  to scroll through the playlist during playback. Files that are highlighted will not be selected until you ▶ **Stop** ▶ **Play**.
- When a video clip is playing, press  to play the video in slow motion. To resume normal playback, press .
- When a video clip is paused, press  to play the video one frame at a time.

Media player options

- ▶ **More** to view the following options:
 - **New playlist** – create a new playlist.
 - **Play mode** – change the playback order of songs and videos. Select **Loop** or **Shuffle**.
 - **Equalizer** – change the settings of the treble and bass when playing music.
 - **Rename** – rename the playlist. You can only rename user-created playlists.
 - **Delete playlist** – delete the playlist. Only the playlist is deleted; the files are still listed in the **File Manager**. You can only delete user-created playlists.

Media options

- When you have opened a playlist, ▶ **More** to view the following options:
- **Information** – view information about the current track or video.
 - **Add media** – add files or folders to the playlist.
 - **Minimize** – minimize the media player and return to standby. The music continues to play and you can use other applications and functions in the phone.
 - **Play mode** – change the playback order of songs and videos.

Entertainment

- **Equalizer** – change the settings of the treble and bass when playing music.
- **Sort** – sort the playlist by artist, title or by the order in which files were added to the playlist.
- **Send** – send a sound or video file.
- **Remove** – remove the file from the playlist.

Online music and videos

You can view videos and listen to music that you find on a Web site by streaming them to your phone. When browsing and when you have found a link for streaming, the media player will open automatically when the link is selected.

In order to stream you must have a data account. Your phone may be pre-configured with a data account. If it is not, please contact your network operator, visit www.SonyEricsson.com/support or ► *61 Settings*.

To select a data account

- 1 ► **Settings** ► **Connectivity** ► **Streaming settings**.
- 2 Select the data account you want to use.

To stream video and audio

- 1 ► **Internet services** ► **More** ► **Enter address** or ► **Internet services** ► **More** ► **Bookmarks**.
- 2 Enter or choose the address to a site and select a link to stream from.

To stream saved music and videos

- 1 ► **Internet services** ► **More** ► **Bookmarks**.
- 2 Select a link to stream. The media player will open and play the streamed music or video.

PlayNow™



This function is network- or operator-dependent. Please contact your network operator for information about your subscription and PlayNow™.

With the PlayNow™ service, you can listen to music tones before you decide to purchase and download them into your phone. Each music tone is part of an original song and is optimized for your Sony Ericsson mobile phone.

Before you start

First make sure that:

- You have a phone subscription that supports GPRS data transmission.
- You have entered the correct settings in your phone, ► *61 Settings*.
- You may also have to register as a WAP user with your service provider or network operator.
- You have free memory in your phone.

Accessing the PlayNow™ music tone list

By selecting the PlayNow™ icon, you download the PlayNow™ music tone list to your phone. You can now listen to a music tone in the list.

To listen to a music tone

► PlayNow™ and select a music tone that you want to listen to.

Downloading a music tone from the PlayNow™ list

The total price for the download is the price appearing on the screen when you select to download and save a music tone. Your phone bill or prepay phone card will be charged by your network operator after you have purchased the music tone.

To download a music tone

- 1 When you have listened to a music tone that you want to download, first verify the purchase details above, then read the terms and conditions provided in the phone kit. By agreeing to purchase in the phone, you also agree to accept these conditions.
- 2 ► **Yes** to download the music tone. You will receive a text message that confirms that the music tone is paid for and made available. The music tone is automatically saved in **File manager** ► **Sounds**.



The service may not always be available in all countries or when you are using a network other than your network operator's – a message will appear to inform you about this when selecting the PlayNow™ icon.

Ringtones and melodies

Your phone comes with a number of standard and polyphonic melodies that can be used as ringtones. You can exchange melodies using one of the available transfer methods. Please note that you are not allowed to exchange copyright-protected material.

 *If you select an MP3 file as a ringtone, you cannot use voice answering, ➤ 30 Voice answering.*



To select a ringtone

▶ Settings ▶ the Sounds & alerts tab ▶ Ringtone.

To turn the ringtone on or off

Press and hold  from standby. All signals except the alarm signal are turned on or off.

To set the ringtone volume

- ▶ Settings ▶ the Sounds & alerts tab
▶ Ring volume and press  or 
to decrease or increase the volume.
- ▶ Save to save the setting.

Caller-specific ringtones

If your subscription includes the Calling Line Identification (CLI) service, you can assign a personal ringtone to callers, ➤ 24 To add a picture or a ringtone to a contact.

Vibrating alert

You can choose to be notified of an incoming call by the buzzing of the vibrating alert. You can set:

- On – all the time.
- On if in Silent – on when the ring volume is turned off or when you have set the phone to silent.
- Off – all the time.

To set the vibrating alert

▶ Settings ▶ the Sounds & alerts tab ▶ Vibrating alert and select the setting you want.

Sounds and alerts options





From Settings ▶ the Sounds & alerts tab, you can set:

- Message alert – select how you want to be notified of an incoming message.
- Key sound – select what sound you want the keys to make when you press them.

MusicDJ™

You can compose and edit melodies to use as ringtones using the MusicDJ™. A melody consists of four types of blocks – **Drums**, **Basses**, **Chords** and **Accents**. A track contains a number of music blocks. The blocks consist of pre-arranged sounds with different characteristics. The blocks are grouped into **Intro**, **Verse**, **Chorus**, and **Break**. You compose a melody by adding music blocks to the tracks.

To compose a melody

- 1 ▶ Entertainment ▶ MusicDJ™.
- 2 Choose to **Insert**, **Copy** and **Paste** blocks to compose your melody. Use , ,  or  to move between the blocks. Press  to delete a block. ▶ **More** to view more options.

To edit a previously created melody

- ▶ **File manager** ▶ **Sounds** and select the melody
- ▶ **More** ▶ **Edit**.

Sending and receiving

You can send and receive melodies using one of the available transfer methods. Please note that you are not allowed to exchange copyright-protected material.



You cannot send a polyphonic melody or an MP3 file in a text message.

To send a melody

- 1 ▶ **File manager** ▶ **Sounds** and select a melody.
- 2 ▶ **More** ▶ **Send** and select a transfer method.

To receive a melody

- 1 Open the message you received the melody in, or turn on the infrared port or Bluetooth, if one of these transfer methods is being used to send the melody.
- 2 If you received the melody in a message ▶ **More** ▶ **Save items**. If you received the melody via Bluetooth or the infrared port, follow the instructions that appear on the screen.

Sound recorder



With the sound recorder, you can record either your own memos or calls. Recorded sounds can also be set as ringtones. Recording of a conversation is stopped if a participant ends the call. Recording of all sounds stops automatically if you receive a call. Recordings are automatically saved on the Memory Stick Duo if it is inserted in the phone. If the recordings are saved in the phone (or on the Memory Stick Duo), they can be accessed even if you change your SIM card.

 *In some countries or states it is required by law that you inform the other person before recording the call.*

To start a sound recording

- 1 ▶ Entertainment ▶ Record sound.
- 2 Wait until you hear a tone. When the recording starts, **Recording** is displayed together with the time of the current recording (increasing).
- 3 ▶ **Save** to end the recording, and ▶ **Play** to listen to the recording. ▶ **More** to view the following options: **Record new**, **Send**, **Rename**, **Delete**, **Recorded sounds**.

To listen to your recordings

- 1 ▶ File manager ▶ **Sounds** and select the recording you want to hear.
- 2 ▶ **Play** to listen to the recording. Press  or  to go to the previous or next recording.
▶ **Stop** to stop playback.

Themes

You can change the appearance of the screen, for example, the colours and wallpaper, by using themes. Your phone comes with some predefined themes. You cannot delete these, but you can create new themes and download them to your phone. For more information, visit www.SonyEricsson.com/support.

To select or change a theme

- ▶ File manager ▶ **Themes** and select a theme.

Exchanging themes

You can exchange themes using one of the available transfer methods.

To send a theme

- 1 ▶ File manager ▶ **Themes** and select a theme.
- 2 ▶ **More** ▶ **Send** and select a transfer method.

To receive and save a theme

- 1 Open the message you received the theme in, or turn on the infrared port or Bluetooth, if one of these transfer methods is being used to send the theme.
- 2 If you received the theme in a message ► **More** ► **Save items**. If you received the theme via Bluetooth or the infrared port, follow the instructions that appear on the screen.

To download a theme

► File manager ► Themes ► Sony Ericsson.

Games

Your phone has several entertaining games. You can also download games and applications directly to the folders in your phone. Help texts are available for most games.

To start and end a game

- 1 ► Entertainment ► Games and select a game ► Start.
- 2 Press and hold  to end the game.

To download a game

► Entertainment ► Games ► Sony Ericsson.

Connectivity

Internet and email settings, synchronizing, Bluetooth, infrared, USB cable, update service.

Settings

Before you start using Internet, messaging, My friends or PlayNow™, settings are required in your phone.

Settings may already be entered when you buy your phone. If not, contact your network operator or service provider for more information. Settings are also available at www.SonyEricsson.com/support.

In order to use the Internet, and send and receive picture and email messages, you need the following:

- A phone subscription that supports data transmission.
- Settings entered in your phone.
- You may also have to register as an Internet and email user with your network operator or service provider.

Connectivity

Entering Internet and email settings

If the settings are not already entered in your phone, you can:

- You can receive settings from your network operator or service provider. Settings are also available at www.SonyEricsson.com/support.
- You can enter or edit settings manually.

Using Internet

Your phone has a browser that uses WAP (Wireless Application Protocol) or HTTP (Hyper Text Transfer Protocol) to access the Internet.

To select an Internet profile

- ▶ Settings ▶ the Connectivity tab ▶ Internet settings
- ▶ Internet profiles and select the profile you want to use.

To start browsing

- ▶ Internet services and select a service
- or ▶ Internet services ▶ More and select an option.

To stop browsing

- ▶ More ▶ Exit browser.

Options when browsing

- ▶ More to view different browsing options.

The options may vary depending on which site you are visiting.



If you select an email address when browsing a Web site, you can send a text message to that address.

The options menu always contains the following:

- **Exit browser** – disconnect and go to standby.
- Go to the homepage set for the current Internet profile, for example, **Sony Ericsson**.
- **Bookmarks** – add the site you are currently browsing to your list of bookmarks, or view the list of bookmarks. Select to stream music or videos.
- **Enter address** – enter the Web page address of a site you want to visit. ▶ **New address** to enter a new Web page address or select one of the 10 last entered addresses. When you enter a Web page address, the normal `http://` prefix is not needed.
- **History** – list of previously visited sites.
- **Refresh page** – refresh the contents of the Web page.
- **Save** – select to save the Web page or a Picture on page.

- **Send link** – send a link to the current site to another phone.
- **Status** – display current status information, for example, profile, access type, security, and address.
- **Appearance** – select to play the sounds or show the pictures on visited pages.
- **Make a call** – if your subscription supports it, you can make a call while browsing the Internet.
 - ▶ **More** ▶ **End call** to end the call and continue browsing.

Using bookmarks

You use bookmarks in your mobile phone just as you do with a computer Internet browser. You can create and edit bookmarks.

To work with bookmarks

- 1 ▶ **Internet services** ▶ **More** ▶ **Bookmarks** and select a bookmark ▶ **More**.
- 2 Select an option.

Downloading

You can download, for example, pictures, themes, games and ringtones, from Web sites directly to your phone.



Contact your network operator or service provider for more information if menu options are not available.

To download from **wap.sonyericsson.com**

- 1 ▶ **Internet services** ▶ **More** ▶ **Bookmarks** ▶ **Sony Ericsson**.
- 2 Select what you want to download and follow the instructions that appear.

Stored information

When browsing, you can save information in your phone.



It is advisable to clear any sensitive information about previously visited Internet services. This is to avoid a security risk if your phone is misplaced, lost or stolen.

The following information can be saved:

- **Cookies** – improve site access efficiency.
- **Passwords** – improve server access efficiency.

Connectivity

To allow or clear cookies in your phone

- ▶ Settings ▶ the Connectivity tab ▶ Internet settings
- ▶ Cookies and select an option and confirm.

To clear the password list

- ▶ Settings ▶ the Connectivity tab ▶ Internet settings
- ▶ Clear passwords and ▶ Yes to confirm.

Internet profile for Java™ applications

Some Java™ applications need to connect to the Internet to receive information, for example, games that download new levels from a game server.

You need an HTTP Internet profile to allow Java™ applications to connect to the Internet. Please contact your network operator or service provider for the correct settings.

To select a profile for Java™

- ▶ Settings ▶ the Connectivity tab ▶ Settings for Java™ ▶ Internet profiles.
- Select the HTTP profile you want to use.

Internet security

Your phone has support for both WAP and HTTP secure browsing. To activate a secure connection to the WAP gateway, you need to turn on security in your Internet profile. If your Internet profile is an HTTP profile, the connection will be secure if the URL starts with https://.



Security for a connection between a WAP gateway and a WAP service provider is the responsibility of the WAP service provider.

To turn on a secure connection (WAP)

- ▶ Settings ▶ the Connectivity tab
▶ Internet settings ▶ Internet profiles
and select a profile ▶ More ▶ Settings.
- Turn on security ▶ Save.

Trusted certificates

To establish a secure connection when using certain Internet services, for example, banking, you need certificates in your phone.

Trusted certificates are used to verify the WAP gateway or the HTTP server that you are connecting to. Your phone may already contain trusted certificates when you buy it. You can also download new certificates using the browser.

To check the certificates in your phone

- ▶ Settings ▶ the Connectivity tab ▶ Internet settings
- ▶ Security ▶ Trusted cert.

Synchronizing

You can synchronize your phone contacts, appointments, tasks and notes with similar programs in, for example, a computer or mobile phone using Bluetooth wireless technology, the infrared port or the USB cable (synchronization with nearby devices). Synchronization software for your computer is available on the CD that comes with the phone.

You can also synchronize with programs on the Internet using WAP or HTTP (remote synchronization with Internet services).



When using USB, make sure you only use the USB cable that comes with the phone.

To select sync order for names

- ▶ Phonebook ▶ Options ▶ Advanced ▶ Sync. order
- to select the order in which first and last name appear in the phone when you synchronize contacts.

Synchronization with nearby devices

Install the synchronization software from the CD that comes with your phone. For detailed information, please refer to the synchronization software help, or download Getting started guides from www.SonyEricsson.com/support, where you also find the latest synchronization software.

Remote synchronization with Internet programs

Contact your network operator for more information about the programs on the Internet with which you can synchronize, and to receive username, password and addresses for the different programs. You must also have an Internet profile set in your mobile phone, ➡ 61 Settings.

To enter the remote synchronization settings

- 1 ▶ **Organizer** ▶ **Synchronization** ▶ **New account**.
If you do not have an account, you will be asked if you want to create an account.
▶ **Yes** to create a new account.
- 2 Enter a name for the new account ▶ **Continue**.
A list of options to enter will appear. Add the server address of the synchronization server, a server username and a server password. ▶ **OK** when you have entered each setting.
- 3 ▶ **Connection** and select the WAP or HTTP profile that you want to use for the synchronization.
- 4 ▶ **Remote initiation** to set whether to allow the synchronization server or other device to initiate a synchronization or not. You can also choose to always be asked.
- 5 ▶ **Sync. interval** to set how often you want the phone to automatically connect to the server and start a synchronization.
- 6 ▶ **Applications** and select the applications that you want to synchronize, for example, **Phonebook** ▶ **Mark** ▶ **OK**.

- 7 ▶ **Application settings** and select application.
Enter the name of the database and, if required, your username and password ▶ **OK**.
- 8 Press  ▶ **Save** to save your new account.

To start the remote synchronization

- ▶ **Organizer** ▶ **Synchronization** and select a remote account ▶ **Start**.

Bluetooth™ wireless technology

Your phone has built-in Bluetooth wireless technology which makes it possible for you to connect your phone wirelessly to other Bluetooth devices.

You can automatically synchronize information in your phone and your computer and use the remote control functionality to control applications on your computer. You can also exchange, for example, business cards, calendar items and pictures.



We recommend that your phone and the Bluetooth device you are communicating with are within a range of 10 metres. The connection may be improved if there are no solid objects between your phone and the other Bluetooth device.

Before you start

To communicate with another Bluetooth device, you first need to turn Bluetooth on and add the device to the list of devices in your phone. You can exchange items, use a remote screen and play games without adding the device to the list. To synchronize with your computer and browse the Internet, you also need to install software on your computer from the CD that comes with your phone, or download it from www.SonyEricsson.com/support.

 Please check if local laws or regulations restrict the use of Bluetooth wireless technology. If Bluetooth is not allowed, you must ensure that the Bluetooth function is turned off. The maximum allowed Bluetooth radio output power in the phone is automatically adjusted according to possible local restrictions. This means that the range may vary.

To turn Bluetooth on

In standby, ► **More** ► **Turn on Bluetooth**.

To add a device to your phone

- 1** ► **Settings** ► the **Connectivity** tab ► **Bluetooth** ► **My devices**. Highlight **New device**.
- 2** ► **More** if you want to select a specific type of device to search for, or ► **Add** and your phone will search for all types of available Bluetooth devices. The Bluetooth function of the other device must also be on and not hidden.
- 3** The phone searches for Bluetooth devices. A list of available devices is displayed. Select a device.
- 4** If the device you are adding to your phone has its own passcode, enter this passcode in your phone. If not, create a passcode of digits yourself and enter it in both devices.

To organize your list of devices

- 1** ► **Settings** ► the **Connectivity** tab ► **Bluetooth** ► **My devices** and select a device from the list.
- 2** ► **More** to view a list of options.

Connectivity

Phone name

Choose a unique name for your phone. This name is shown in other devices when your phone is found.

To enter a phone name

- ▶ Settings ▶ the Connectivity tab ▶ Bluetooth
- ▶ Phone name.

Visibility

In order for your phone to be found when searched for by other Bluetooth devices, you must make sure that Bluetooth is turned on and your phone is visible to other devices.

To hide or show your phone when using Bluetooth

- ▶ Settings ▶ the Connectivity tab ▶ Bluetooth
 - ▶ Visibility.
- ▶ Show phone or Hide phone.

Sending and receiving

To send or receive an item using Bluetooth, you need to make sure that the devices are within range.

After you select Bluetooth as the transfer method for sending, a list of possible receiving devices is presented. The phone also searches for other devices that are shown in the list.

To send an item (example: a contact)

- ▶ Phonebook and select a contact, when Contacts is default phonebook.
- ▶ More ▶ Send contact ▶ Via Bluetooth. The phone searches for devices.
- Select the device you want to send the item to ▶ Select.

To receive an item

In standby, ▶ More ▶ Turn on Bluetooth. Make sure that your phone is visible to other devices. When you receive the item, follow the instructions that appear on the screen.

To add a Bluetooth handsfree to your phone

- ▶ Settings ▶ the Connectivity tab ▶ Bluetooth
 - ▶ Handsfree.
- The first time you add a handsfree, Add a handsfree device to use with the phone? is displayed ▶ Yes.

- 3** If you already have a handsfree in your list of devices, ► **Settings** ► the **Connectivity** tab ► **Bluetooth** ► **Handsfree** ► **My handsfree** ► **New handsfree** ► **Add**. You should ensure that your Bluetooth handsfree is in pairing mode.

Transferring sound

When you are using a Bluetooth handsfree with your phone, you can choose where the sound should be transferred during a call. You can also select where the sound should be handled when answering an incoming call with the keypad.

To transfer sound when using a handsfree

During a call, press  ► **Transfer sound**. Select to transfer sound either to the phone or to other handsfree devices that have been added to your phone.

Directing sound

You can select where the sound should be handled when answering an incoming call with the keypad on the phone. If you use the button on the handsfree, the sound will always be in the handsfree.

To direct sound when answering a call with a handsfree

- **Settings** ► the **Connectivity** tab ► **Bluetooth** ► **Handsfree** ► **Incoming call**.
- **In phone** if you always want to have the sound in the phone or ► **In handsfree** if you want to direct the sound to the handsfree.

Remote control

You can use your phone as a remote control device to control computer applications such as a media player or Microsoft® PowerPoint® presentations. Your computer must support Bluetooth HID Profile.

To select remote control

- **Settings** ► the **Connectivity** tab ► **Bluetooth** ► **Remote control**.
- Select the application you want to use and the computer you want to connect to.

File transfer

You can use a computer to view and transfer content in the **File manager**. You can use the drag-and-drop function of your computer to:

- Transfer files between your phone and the computer.
- Delete files from the phone.

Connectivity

Infrared port

You can use the infrared port to establish contact between your phone and a computer or another device equipped with an infrared port. You can, for example, synchronize calendar items, ➤ *65 Synchronizing*, and send items such as pictures and contacts.

 *If you are connecting to a computer, please refer to its user documentation. Make sure that the infrared speed in the computer is set to 115200 bps.*

To turn the infrared port on

▶ Settings ▶ the Connectivity tab ▶ Infrared port
▶ On or ▶ 10 minutes to turn on infrared for 10 minutes only.

To connect two devices



- 1 Turn on the infrared port of both devices.
- 2 Make sure that the infrared port on your phone faces the infrared port on the other device.
- 3 Your phone now establishes contact with the other device.

To send an item using the infrared port (example: a contact)

- 1 Make sure that the infrared ports of both devices are on and aligned.
- 2 ▶ Phonebook and select a contact, when Contacts is default phonebook.
- 3 ▶ More ▶ Send contact ▶ Via infrared.

Transferring files using the USB cable

When you connect your phone to a computer using the USB cable, the Memory Stick appears as a drive on the computer. Your phone has to be turned on. You can install the USB cable drivers using the CD that comes with your phone. You can also synchronize your phone and computer using the USB cable, ➤ *65 Synchronizing*.

 *Make sure you use only the USB cable that comes with the phone.*

You can use the drag-and-drop functionality in your computer to:

- Transfer files between your phone and the computer.
- Move and organize files on the Memory Stick Duo.
- Delete files from the Memory Stick Duo.

 *Your computer needs to have one of the following operating systems to be able use this feature: Windows® 2000, Windows ME, Windows XP and Mac OS X.*

Update Service

With Sony Ericsson Update Service you can keep your phone updated with the latest software. When a new software version is available, you can download and install it using the provided USB cable and an Internet-connected computer (preferably via broadband).

To update the phone software

- 1** Connect the USB cable to the computer and the phone.
- 2** Visit www.SonyEricsson.com/support.

- 3** Select Sony Ericsson Update Service and follow the instructions on how to proceed with the update sequence. Answer Yes when you are asked if you want to install the Sony Ericsson Update Service program.

 *User data can be lost when the software is updated. Always back up the phone before updating.*

More features

Time and date, alarm clock, calendar, tasks, Java™ applications, SIM card lock, etc.

Time and date

The time is always displayed in standby.

- To set the time ► **Settings** ► the **General** tab ► **Time & date** ► **Time**. Enter the time ► **Save**.
- To set the time format ► **Format** and select an option.
- To set the date and date format ► **Settings** ► the **General** tab ► **Time & date** ► **Date**.

Alarm clock

The alarm can be set to ring at a specific time within 24 hours, or recurrently at a specific time on several days. You can have both these alarms set at the same time. The alarm signal rings even if the phone is set to silent or turned off.

To set an alarm

- **Organizer** ► **Alarms** ► **Alarm** and enter the time
- **Save**.

Using the alarm

- To change the alarm time ► **Organizer** ► **Alarms** ► **Alarm** and enter a new time.
- To turn the alarm signal off when it rings, press any key. If you do not want the alarm to be repeated ► **Turn off**.
- To cancel the alarm ► **Organizer** ► **Alarms** ► **Alarm** ► **Turn off**.
- To set a recurrent alarm ► **Organizer** ► **Alarms** ► **Recurrent alarm**. Enter the time ► **Continue** and select the days that you want the alarm to recur on by scrolling and pressing **Mark**. ► **Done** to exit the menu.
- To select an alarm signal ► **Organizer** ► **Alarms** ► **Alarm signal**.

Calendar

You can use the calendar to keep track of important meetings. The calendar can be synchronized with a computer calendar or with a calendar on the Web, ► *65 Synchronizing*.

Appointments

You can choose to add a new appointment or use an old one as a template by copying and editing it. You can also set reminders for appointments.

To add a new appointment

- ▶ **Organizer** ▶ **Calendar** and highlight the date for the appointment ▶ **Select** ▶ **New appointment** ▶ **Add**.
- Enter details and confirm each entry.

To view an appointment

- Organizer** ▶ **Calendar** and select a day on which you have an appointment (marked in bold).
- Scroll to the appointment ▶ **View**.

To view your calendar content

- ▶ **Organizer** ▶ **Calendar**. Days on which you have appointments are marked in bold. ▶ **More** ▶ **View week** to view a certain week.

To set when reminders should sound

- ▶ **Organizer** ▶ **Calendar** ▶ **More** ▶ **Advanced** ▶ **Reminders**.
- ▶ **Always** if you want the reminder to sound even though the phone is turned off. When the reminder sounds ▶ **Yes** to read the appointment. ▶ **No** to turn off the reminder. A reminders option set in the calendar affects a reminders option set in tasks.

Navigating in your calendar

Use the navigation key to move between days or weeks. In the monthly and weekly views, you can also use the keypad as follows.

- | | |
|------------------------------|----------------------------|
| 1 <i>Back a week</i> | 3 <i>Next week</i> |
| 4 <i>Back a month</i> | 6 <i>Next month</i> |
| 7 <i>Back a year</i> | 9 <i>Next year</i> |
| C <i>Today's date</i> | |

Calendar settings

▶ **Organizer** ▶ **Calendar** ▶ **More** and select an option.

- **View week** – select, add, edit or delete appointments.
- **New appointment** – add a new appointment.
- **Change date** – change the date of your calendar.
- **Advanced** – for options to find, delete all, set reminders or select a start day for the week.

Exchanging appointments

You can send and receive appointments using one of the available transfer methods.

More features

To send an appointment

In the list of appointments for a certain day, select the item you want to send ► **More** ► **Send** and select a transfer method.

Tasks

You can keep track of phone calls you need to make or tasks that you need to do. You can choose to add a new task or use an old one as a template by copying and editing it. You can also set a reminder for a task.

To add a new task

- 1 ► **Organizer** ► **Tasks** ► **New task** ► **Add**.
- 2 Select a category. If the category is a phone call, enter the phone number ► **Continue**.
- 3 Enter a subject ► **Continue**.
- 4 If you want to set a reminder for your task ► **Yes**.

To view a task

► **Organizer** ► **Tasks** and select a task ► **View**.

To set when reminders should sound

- 1 ► **Organizer** ► **Tasks** and select a task ► **More** ► **Reminders**.
- 2 ► **Always** if you want the reminder to sound even though the phone is turned off. When the reminder sounds ► **Yes** to read the task, or to call the phone number in a phone task. ► **No** to turn off the reminder. A reminders option set in tasks affects a reminders option set in the calendar.

Exchanging tasks

You can send and receive tasks using one of the available transfer methods. You can also synchronize tasks with a computer,

► *65 Synchronizing*.

To send a task

- 1 In the list of tasks for a certain day, select the item you want to send ► **More** ► **Send**.
- 2 Select a transfer method.

Notes

If you need to remember something, you can make a note of it in your phone.

To add a note

► Organizer ► Notes ► New note ► Add and enter the note ► Save.

To handle the notes

- Organizer ► Notes and a list of notes appears.
- Select the note that you want to handle. ► More to edit, show a note in standby (or hide it), send or delete a note.

Exchanging notes

You can send and receive notes using one of the available transfer methods. You can also synchronize notes with a computer,

➡ 65 *Synchronizing*.

To send a note

► Organizer ► Notes and select the note that you want to send ► More ► Send and select a transfer method.

Profiles

Your phone has a number of predefined profiles to suit a certain environment. For example, the ringtone is turned off in the **Meeting** profile.

You can reset all profile settings to the way they were set when you bought your phone.

To select a profile

► Settings ► the General tab ► Profiles
► Select profile.

To change a profile setting

► Settings ► the General tab ► Profiles ► Edit profile and select the setting that you want to change.

To rename a profile

► Settings ► the General tab ► Profiles ► Edit profile
► Profile name. You cannot rename the normal profile.

To reset all profile settings

► Settings ► the General tab ► Profiles
► Reset profiles.

Stopwatch

Your phone has a stopwatch that can save several laps. The stopwatch continues to run when you answer an incoming call.

To use the stopwatch

- Organizer ► Stopwatch ► Start.
- Stop or ► New lap if you want a lap time.
- To reset the stopwatch ► Reset.

More features

Timer

To set the timer

► **Organizer** ► **Timer** and enter the hours, minutes and seconds after which you want the timer to go off. When the signal rings, press any key to turn it off.

Power save

Turn on power save if you do not want to use battery consuming features, such as Bluetooth, infrared, key sound and the sleep mode clock. Also, screen light will be dimmed and a **Power save** theme will be used. You can turn on the functions above individually in the **Settings** menu.

To save power

► **Settings** ► the **General** tab ► **Power save**.

Brightness

You can adjust the brightness of the screen.

To set the brightness

► **Settings** ► the **Display** tab ► **Brightness**.



Start-up screen

When you turn your phone on or off, the start-up screen appears. You can also set your own start-up screen.

To select a start-up screen

► **Settings** ► the **Display** tab ► **Start-up screen** and select an option for the start-up screen.

Calculator

The calculator can add, subtract, divide and multiply.

To use the calculator

► **Organizer** ► **Calculator**.

- Press or to select \div \times $-$ $+$ $.$ $\%$ $=$
- Press to delete the figure.
- Press to enter a decimal point.

Java™ applications

You can run Java™ applications on your phone. Games and other Java applications can be downloaded to your phone from the Internet. To open an application, ► **File manager** ► **Applications** or ► **Games**.

Java application security

Java applications are automatically installed as “Trusted” or “Untrusted”. Trusted applications are allowed to, for example, connect to networks, send messages or use the camera without asking for permission. Untrusted applications, however, must always confirm such actions with you first. You can set different permission levels for your Java applications.

To set permissions for a Java application

- 1 ▶ File manager ▶ Applications or ▶ Games.
- 2 Select an application or a game ▶ More ▶ Permissions.
- 3 ▶ Internet access, Messaging or Multimedia.
- 4 ▶ No, Always ask or Ask once to set the permission level you want for the application.

Java application screen size

Some Java applications are designed for a specific screen size. In some cases, applications may not be able to start because the phone cannot adapt the application to the screen. Contact the application vendor to find out what screen size the application is designed for, and change the screen settings for the application in the phone.

To set the screen size for a Java application

- 1 ▶ File manager ▶ Applications or ▶ Games.
- 2 Select an application or a game ▶ More ▶ Screen size.
- 3 Select one of the listed options. If you selected **User defined**, edit the **Width:** and **Height:** values.

SIM card lock

The SIM card lock protects your subscription, but not your phone itself, from unauthorized use. If you change SIM cards, your phone still works with the new SIM card.

Most SIM cards are locked at the time of purchase. If the SIM card lock is on, you have to enter a PIN (Personal Identity Number) every time you turn on your phone.

If you enter your PIN incorrectly three times in a row, the SIM card is blocked. This is indicated by the message **PIN blocked**. To unblock it, you need to enter your PUK (Personal Unblocking Key).

More features

Your PIN and PUK are supplied by your network operator. You can edit your PIN and select a new four- to eight-digit PIN.

 *If the message **Codes do not match** appears when you edit your PIN, you entered the new PIN incorrectly. If the message **Wrong PIN** appears, followed by **Old PIN**, you entered your old PIN incorrectly.*

To unblock your SIM card

- 1 When **PIN blocked** is displayed, enter your PUK ► **OK**.
- 2 Enter a new four- to eight-digit PIN ► **OK**.
- 3 Re-enter the new PIN to confirm ► **OK**.

To edit your PIN

- 4 ► **Settings** ► the **General** tab ► **Locks** ► **SIM lock** ► **Change PIN**.
- 5 Enter your PIN ► **OK**.
- 6 Enter a new four- to eight-digit PIN ► **OK**.
- 7 Re-enter the new PIN to confirm ► **OK**.

To turn the SIM card lock on or off

- 1 ► **Settings** ► the **General** tab ► **Locks** ► **SIM lock** ► **Protection** and select **On** or **Off**.
- 2 Enter your PIN ► **OK**.

Phone lock

The phone lock protects your phone against unauthorized use if it is stolen and the SIM card is exchanged. You can change the phone lock code (0000) to any four- to eight-digit personal code.

Automatic phone lock

If the phone lock is set to automatic, you do not need to enter your phone lock code until a different SIM card is inserted in the phone.

 *It is important that you remember your new code. If you should forget it, you have to hand in your phone to your local Sony Ericsson retailer.*

To set the phone lock

- 1 ► **Settings** ► the **General** tab ► **Locks** ► **Phone lock** ► **Protection** and select an alternative.
- 2 Enter the phone lock code ► **OK**.

To unlock the phone

If the phone lock is on, enter your code ► **OK**.

To edit your phone lock code

- **Settings** ► the **General** tab ► **Locks** ► **Phone lock** ► **Change code**.

Code memo

Instead of having to remember security codes for credit cards, for example, you can save them in the code memo in your phone. All you need to remember is the passcode to open the code memo.

Checkword and security

To confirm that you have entered the correct passcode for the code memo and to prevent unauthorized access to your codes, you must enter a checkword.

When you enter your passcode to open the code memo, the checkword is shown for a short time. If the passcode is correct, the correct codes are shown. If you enter the incorrect passcode, the checkword and the codes that are shown are also incorrect.

To open code memo for the first time

- 1 ▶ **Organizer** ▶ **Code memo**. A message with instructions is displayed ▶ **Continue**.
- 2 Enter a four-digit passcode to open code memo ▶ **Continue**.
- 3 Re-enter the new passcode to confirm.

- 4 Enter a checkword (maximum 15 characters) ▶ **Done**. The checkword can consist of both letters and numbers.

To add a new code

- 1 ▶ **Organizer** ▶ **Code memo** and enter your passcode ▶ **New code** ▶ **Add**.
- 2 Enter a name associated with the code ▶ **Continue**.
- 3 Enter the code ▶ **Done**.

To change the passcode

- 1 Open code memo as described above ▶ **More** ▶ **Change passcode**.
- 2 Enter your new passcode ▶ **Continue**.
- 3 Re-enter the new passcode ▶ **Continue**.
- 4 Enter a checkword ▶ **Done**.

Forgot your passcode?

If you forget your passcode, you must reset the code memo.

To reset code memo

- 1 ▶ **Organizer** ▶ **Code memo** and enter any passcode to access the code memo function.
- 2 ▶ **More** ▶ **Reset**.



Troubleshooting

- 3** Reset code memo? is displayed ► **Yes**. The code memo is reset and all entries are cleared. The next time you enter the code memo, you must start by opening the code memo for the first time.

Torch light

You can use the light on the Motion Eye™ camera without using the camera or video recorder.

To turn the light on and off

Press and hold  on the side of the phone to turn the light on. Press  to turn it off.

Troubleshooting

Why doesn't the phone work the way I want?

This chapter lists some problems that you might encounter while using your phone. Some problems require that you call your network operator, but most of the problems you can easily correct yourself.

However, if you need to hand in your phone for repair, please note that you may lose information and content that you have saved in your phone. You are advised to make a copy of such information before handing your phone in for repair.

For more support go to www.SonyEricsson.com/support.

I have problems with memory capacity or the phone working slowly

Possible cause: The phone memory is full or the memory contents are not properly organized.

Solution: Restart your phone every day to free memory and increase the capacity of your phone.

You also have the option to do a **Master reset**. Some of your personal data and settings you have made will be lost when doing this. ► **83 Master reset**.

No battery icon appears when I start charging the phone

Possible cause: The battery is empty or has not been used for a long time.

Solution: It may take up to 30 minutes before the battery icon appears on the screen.

Some menu options appear in grey

Possible cause: Grey text indicates a function that is temporarily unavailable. A service is not activated, or your subscription does not support the function.

Solution: Contact your network operator.

Possible cause: Since you cannot send themes, pictures and sounds that are copyright-protected, the **Send** menu is sometimes unavailable.

I do not understand the language in menus

Possible cause: The wrong language is set in the phone.

Solution: Change the language. ➡ [13 Phone language](#).

I cannot turn on the phone

Possible cause: The battery is discharged.

Solution: Recharge the battery. ➡ [6 To charge the battery](#).

Solution: Make sure you attached the charger correctly. Turn the phone on with the charger attached. If the phone starts, restart the phone with no charger attached.

I cannot charge the phone or battery capacity is low

Possible cause: The charger is not properly connected to the phone.

Solution: Make sure that the charger connector clicks properly into place when connected. The battery icon flashes when charging is in progress, and stops when the battery is fully charged.

➡ [6 To charge the battery](#).

Possible cause: The battery connection is bad.

Solution: Remove the battery and clean the connectors. You can use a soft brush, cloth or q-tip, soaked with alcohol. Make sure that the battery is completely dry before you put it back. Check that the battery connectors in the phone are undamaged.

Possible cause: The battery is worn out and needs to be replaced.

Solution: Try another battery and charger for the same phone model, or visit your retailer and ask them to verify if the battery and charger are working properly.

Troubleshooting

The phone turns itself off

Possible cause: The battery connection is bad.

Solution: Make sure the battery is inserted correctly. ➡ 6 To charge the battery.

I cannot use SMS/text messaging on my phone

Possible cause: Settings are missing or incorrect.

Solution: Contact your network operator to find out the correct SMS service centre setting. ➡ 36 Text messaging (SMS).

I cannot use MMS/picture messaging on my phone

Possible cause: Your subscription does not include data capability.

Solution: Please contact your network operator.

Possible cause: Settings are missing or incorrect.

Solution: Go to www.SonyEricsson.com/support, choose your phone model, then choose “Phone setup – MMS” and follow the instructions. ➡ 61 Settings.

I cannot use the Internet/WAP

Possible cause: Your subscription does not include data capability.

Solution: Please contact your network operator.

Possible cause: Internet settings are missing or incorrect.

Solution: Go to www.SonyEricsson.com/support, choose your phone model, then choose “Phone setup – WAP” and follow the instructions. ➡ 61 Settings.

The phone cannot be detected by other users via Bluetooth

Possible cause: You have not turned Bluetooth on.

Solution: Make sure that Bluetooth is turned on and that your phone is visible to other users. ➡ 68 To hide or show your phone when using Bluetooth.

I have problems synchronizing or transferring data between my phone and my computer, when using the USB cable that came with the phone

Possible cause: The cable has not been properly detected and installed on your computer. The software that came with your phone has not been properly installed on the computer.

Solution: Go to www.SonyEricsson.com/support, choose your phone model, then choose “Product information” - “Getting started”. The guide “Synchronizing the phone with a computer” contains installation instructions and a troubleshooting guide, that may assist you in solving the problem.

Master reset

The changes that you have made to settings and the content that you have added or edited, will be deleted.

- If you select **Reset settings**, the changes that you have made to settings will be deleted.
- If you select **Reset all**, in addition to your changes to settings, all contacts, messages, personal data, and content that you have downloaded, received or edited will also be deleted.

To reset the phone

- 1 ▶ Settings ▶ the General tab ▶ Master reset.
- 2 ▶ Reset settings or ▶ Reset all.
- 3 ▶ Yes to continue.
- 4 Enter the phone lock code (0000 or the new code if you have changed it) ▶ OK.

 If you select **Reset all**, content such as melodies and pictures that you have downloaded, received or edited are also deleted.

Error messages

Insert SIM

Possible cause: There is no SIM card in the phone or you may have inserted it incorrectly.

Solution: Insert a SIM card. ➡ 5 To insert the SIM card, the Memory Stick Duo and the battery.

Possible cause: The SIM card connectors need cleaning.

Solution: Remove the SIM card and clean it. Also check that the card is not damaged in a way that may prevent connection to the phone connectors. In that case, contact your network operator for a new SIM card.

Insert correct SIM card

Possible cause: The phone is set to work only with certain SIM cards.

Solution: Check if you are using the correct operator SIM card for your phone.

Wrong PIN/Wrong PIN2

Possible cause: You have entered your PIN or PIN2 incorrectly.

Solution: Enter the correct PIN or PIN2. ➡ 77 SIM card lock.

Troubleshooting

PIN blocked/PIN2 blocked

Possible cause: You have entered your PIN or PIN2 code incorrectly three times in a row.

Solution: To unblock, ➡ 77 SIM card lock.

Codes do not match

Possible cause: The two codes that you have entered do not match.

Solution: When you want to change a security code (for example your PIN) you have to confirm the new code by entering exactly the same code again.

➡ 77 SIM card lock.

No network

Possible cause: Your phone is not receiving any radio signal, or the received signal is too weak.

Solution: Contact your network operator and make sure that the network has coverage where you are. If so, try to do a new search.

Possible cause: The SIM card is not working properly.

Solution: Insert your SIM card in another phone. If you still get the same or a similar message, please contact your network operator.

Possible cause: The phone is not working properly.

Solution: Insert your SIM card in another phone. If this works, it is probably the phone that is causing the problem. Please contact the nearest Sony Ericsson service location.

Emergency calls only

Possible cause: You are within range of a network, but you are not allowed to use it. However, in an emergency, some network operators allow you to call the international emergency number 112.

Solution: You have to move to get a signal that is strong enough. Contact your network operator and make sure your subscription is ok.

➡ 21 Emergency calls.

Phone locked

Possible cause: The phone is locked.

Solution: To unlock the phone, ➡ 78 Phone lock.

Phone lock code:

Possible cause: The phone lock code is required.

Solution: Enter the phone lock code. Your phone comes with the default phone lock code 0000. You can change it to any four- to eight-digit code.

➡ 78 Phone lock.

PUK blocked

Possible cause: You entered your personal unblocking key code (PUK) incorrectly 10 times in a row.

Solution: Contact your network operator.

Charging, alien battery

Possible cause: The battery that you are using is not a Sony Ericsson battery.

Solution: ➔ 88 *Battery use and care.*

Additional information

Sony Ericsson Consumer Web site, safe and efficient use, warranty, declaration of conformity.

Sony Ericsson Consumer Web site

On www.SonyEricsson.com/support there is a support section where help and tips are only a few clicks away. Here you find the latest computer software updates and tips on how to use your product more efficiently.

Guidelines for Safe and Efficient Use

Please read this information before using your mobile phone.



Recommendations

- Always treat your product with care and keep it in a clean and dust-free place.
- Do not expose your product to liquid or moisture or humidity.
- Do not expose your product to extreme high or low temperatures.
- Do not expose your product to open flames or lit tobacco products.
- Do not drop, throw or try to bend your product.



Additional information

- Do not close your product with an object inserted between keypad and display; this may damage your product.
- Do not paint your product.
- Do not use your product near medical equipment without requesting permission.
- Do not use your product when in, or around aircraft, or areas posted “turn off two-way radio”.
- Do not use your product in an area where a potentially explosive atmosphere exists.
- Do not place your product or install wireless equipment in the area above your car’s air bag.
- Do not attempt to disassemble your product. Only Sony Ericsson authorised personnel should perform service.



Antenna

Only use an antenna that has been specifically designed by Sony Ericsson for your mobile phone. Use of unauthorised or modified antennas could damage your mobile phone and may violate regulations, causing loss of performance and SAR levels above the recommended limits (see below).

Efficient use

Hold your mobile phone as you would any other phone. Do not cover the top of the phone when

in use, as this affects call quality and may cause the phone to operate at a higher power level than needed, thus shortening talk and standby times.

Radio frequency (RF) exposure and SAR

Your mobile phone is a low-power radio transmitter and receiver. When it is turned on, it emits low levels of radio frequency energy (also known as radio waves or radio frequency fields).

Governments around the world have adopted comprehensive international safety guidelines, developed by scientific organizations, e.g. ICNIRP (International Commission on Non-Ionizing Radiation Protection) and IEEE (The Institute of Electrical and Electronics Engineers Inc.), through periodic and thorough evaluation of scientific studies. These guidelines establish permitted levels of radio wave exposure for the general population. The levels include a safety margin designed to assure the safety of all persons, regardless of age and health, and to account for any variations in measurements.

Specific Absorption Rate (SAR) is the unit of measurement for the amount of radio frequency energy absorbed by the body when using a mobile phone. The SAR value is determined at the highest certified power level in laboratory conditions, but the actual SAR level of the mobile phone while operating can be well below this value.

This is because the mobile phone is designed to use the minimum power required to reach the network.

Variations in SAR below the radio frequency exposure guidelines do not mean that there are variations in safety. While there may be differences in SAR levels among mobile phones, all Sony Ericsson mobile phone models are designed to meet radio frequency exposure guidelines.

A separate leaflet with SAR information for this mobile phone model is included with the material that comes with this mobile phone. This information can also be found, together with more information on radio frequency exposure and SAR, on: www.sonyericsson.com.

Driving

Please check if local laws and regulations restrict the use of mobile phones while driving or require drivers to use handsfree solutions. We recommend that you use only Sony Ericsson handsfree solutions intended for use with your product. Please note that because of possible interference to electronic equipment, some vehicle manufacturers forbid the use of mobile phones in their vehicles unless a handsfree kit with an external antenna supports the installation.

Always give full attention to driving and pull off the road and park before making or answering a call if driving conditions so require.

Personal medical devices

Mobile phones may affect the operation of cardiac pacemakers and other implanted equipment. Please avoid placing the mobile phone over the pacemaker, e.g. in your breast pocket. When using the mobile phone, place it at the ear opposite the pacemaker. If a minimum distance of 15 cm (6 inches) is kept between the mobile phone and the pacemaker, the risk of interference is limited. If you have any reason to suspect that interference is taking place, immediately turn off your mobile phone. Contact your cardiologist for more information.

For other medical devices, please consult the manufacturer of the device.

CHILDREN

DO NOT ALLOW CHILDREN TO PLAY WITH YOUR MOBILE PHONE OR ITS ACCESSORIES. THEY COULD HURT THEMSELVES OR OTHERS, OR COULD ACCIDENTALLY DAMAGE THE MOBILE PHONE OR ACCESSORY. YOUR MOBILE PHONE OR ITS ACCESSORY MAY CONTAIN SMALL PARTS THAT COULD BE DETACHED AND CREATE A CHOKING HAZARD.



Disposal of Old Electrical & Electronic Equipment

This symbol on the product or on its packaging indicates that this product shall not be treated as household waste. Instead it shall be handed over to the applicable collection point for the recycling of electrical and electronic equipment. By ensuring this product is disposed of correctly, you will help prevent potential negative consequences for the environment and human health, which could otherwise be caused by inappropriate waste handling of this product. The recycling of materials will help to conserve natural resources. For more detailed information about recycling of this product, please contact your local city office, your household waste disposal service or the shop where you purchased the product



Power supply

Connect the AC power adapter only to designated power sources as marked on the product. Make sure the cord is positioned so that it will not be subjected to damage or stress. To reduce risk of electric shock, unplug the unit from any power source before attempting to clean it. The AC power adapter must not be used outdoors or in damp areas. Never alter the cord or plug. If the plug will not fit into the outlet, have a proper outlet installed by a qualified electrician.

Emergency calls

Mobile phones operate using radio signals, which cannot guarantee connection under all conditions. Therefore you should never rely solely upon any mobile phone for essential communications (e.g. medical emergencies).

Emergency calls may not be possible on all cellular networks or when certain network services and/or mobile phone features are in use. Check with your local service provider.

Battery use and care

We recommend that you fully charge the battery before you use your mobile phone for the first time. The battery can only be charged in temperatures between +5°C (+41°F) and +45°C (+113°F).

A new battery or one that has not been used for a long time could have reduced capacity the first few times it is used.

The talk and standby times depend on the actual transmission conditions when using the mobile phone. If the mobile phone is used near a base station, less power is required and talk and standby times are prolonged.

- **Warning!** May explode if disposed of in fire.
- Use only Sony Ericsson branded original batteries and chargers intended for use with your mobile phone. Other chargers may not charge sufficiently or

may produce excessive heat. Using other batteries and chargers could be dangerous.

- Do not expose the battery to liquid.
- Do not let the metal contacts on the battery touch another metal object. This could short-circuit and damage the battery.
- Do not disassemble or modify the battery.
- Do not expose the battery to extreme temperatures, never above +60°C (+140°F). For maximum battery capacity, use the battery in room temperature.
- Turn off your mobile phone before removing the battery.
- Keep out of children's reach.
- Use the battery for the intended purpose only.
- Do not allow the battery to be put into the mouth. Battery electrolytes may be toxic if swallowed.



Disposing of the battery

Please check local regulations for disposal of batteries or call your local Sony Ericsson Call Center for information.

The battery should never be placed in municipal waste. Use a battery disposal facility if available.

Limited Warranty

Sony Ericsson Mobile Communications AB, S-221 88 Lund, Sweden, (Sony Ericsson), provides this Limited Warranty for your mobile phone and original accessory delivered with your mobile phone (hereinafter referred to as "Product").

Should your Product need warranty service, please return it to the dealer from whom it was purchased, or contact your local Sony Ericsson Call Center (national rates may apply) or visit www.SonyEricsson.com to get further information.

Our warranty

Subject to the conditions of this Limited Warranty, Sony Ericsson warrants this Product to be free from defects in design, material and workmanship at the time of its original purchase by a consumer, and for a subsequent period of one (1) year.

What we will do

If, during the warranty period, this Product fails to operate under normal use and service, due to defects in design, materials or workmanship, Sony Ericsson authorised distributors or service partners, in the country/region* where you purchased the Product, will, at their option, either repair or replace the Product in accordance with the terms and conditions stipulated herein.

Additional information

Sony Ericsson and its service partners reserve the right to charge a handling fee if a returned Product is found not to be under warranty according to the conditions below.

Please note that some of your personal settings, downloads or other information may be lost when your Sony Ericsson Product is repaired or replaced. At present Sony Ericsson may be prevented by applicable law, other regulation or technical restrictions from making a backup copy of certain downloads. Sony Ericsson does not take any responsibility for any lost information of any kind and will not reimburse you for any such loss. You should always make backup copies of all the information stored on your Sony Ericsson Product such as downloads, calendar and contacts before handing in your Sony Ericsson Product for repair or replacement.

Conditions

- 1 The warranty is valid only if the original proof of purchase issued to the original purchaser by an, for this Product, Sony Ericsson authorised dealer, specifying the date of purchase and serial number**, is presented with the Product to be repaired or replaced. Sony Ericsson reserves the right to refuse warranty service if this information has been removed or changed after the original purchase of the Product from the dealer.
- 2 If Sony Ericsson repairs or replaces the Product, the repaired or replaced Product shall be warranted for the remaining time of the original warranty period or for ninety (90) days from the date of repair, whichever is longer. Repair or replacement may involve the use of functionally equivalent reconditioned units. Replaced parts or components will become the property of Sony Ericsson.
- 3 This warranty does not cover any failure of the Product due to normal wear and tear, or due to misuse, including but not limited to use in other than the normal and customary manner, in accordance with the Sony Ericsson instructions for use and maintenance of the Product. Nor does this warranty cover any failure of the Product due to accident, software or hardware modification or adjustment, acts of God or damage resulting from liquid. A rechargeable battery can be charged and discharged hundreds of times. However, it will eventually wear out – this is not a defect. When the talk-time or standby time is noticeably shorter, it is time to replace your battery. Sony Ericsson recommends that you use only batteries and chargers approved by Sony Ericsson. Minor variations in display brightness and color may occur between phones. There may be tiny bright or dark dots on the display. These are called defective pixels and occur when individual dots have malfunctioned and can not be adjusted.

Two defective pixels are deemed acceptable. Minor variations in camera image appearance may occur between phones. This is nothing uncommon and is not regarded as a defective camera module.

- 4 Since the cellular system on which the Product is to operate is provided by a carrier independent from Sony Ericsson, Sony Ericsson will not be responsible for the operation, availability, coverage, services or range of that system.
- 5 This warranty does not cover Product failures caused by installations, modifications, or repair or opening of the Product performed by a non-Sony Ericsson authorised person.
- 6 The warranty does not cover Product failures which have been caused by use of accessories or other peripheral devices which are not Sony Ericsson branded original accessories intended for use with the Product.
- 7 Tampering with any of the seals on the Product will void the warranty.
- 8 **THERE ARE NO EXPRESS WARRANTIES, WHETHER WRITTEN OR ORAL, OTHER THAN THIS PRINTED LIMITED WARRANTY. ALL IMPLIED WARRANTIES, INCLUDING WITHOUT LIMITATION THE IMPLIED WARRANTIES OF MERCHANTABILITY OR FITNESS FOR A PARTICULAR PURPOSE, ARE LIMITED TO THE DURATION OF THIS LIMITED WARRANTY. IN NO EVENT SHALL SONY ERICSSON OR ITS**

LICENSORS BE LIABLE FOR INCIDENTAL OR CONSEQUENTIAL DAMAGES OF ANY NATURE WHATSOEVER, INCLUDING BUT NOT LIMITED TO LOST PROFITS OR COMMERCIAL LOSS; TO THE FULL EXTENT THOSE DAMAGES CAN BE DISCLAIMED BY LAW.

Some countries/states do not allow the exclusion or limitation of incidental or consequential damages, or limitation of the duration of implied warranties, so the preceding limitations or exclusions may not apply to you.

The warranty provided does not affect the consumer's statutory rights under applicable legislation in force, nor the consumer's rights against the dealer arising from their sales / purchase contract.

*EUROPEAN UNION (EU)

If you have purchased your Product in an EU country you can have your Product serviced, under the conditions set out above, within the warranty period in any EU country where an identical Product is sold by an authorised Sony Ericsson distributor. To find out if your Product is sold in the EU country you are in, please call the local Sony Ericsson Call Center. Please observe that certain services may not be possible elsewhere than in the country of original purchase, for example due to the fact that your Product may have an interior or exterior which is different from equivalent models sold in other EU countries. It may not be possible to repair SIM-locked Products.

Additional information

** In some countries/regions additional information is requested. If so, this is clearly shown on the valid proof of purchase.

FCC Statement

This device complies with Part 15 of the FCC rules. Operation is subject to the following two conditions: (1) This device may not cause harmful interference, and (2) This device must accept any interference received, including interference that may cause undesired operation.



Declaration of Conformity

We, **Sony Ericsson Mobile Communications AB** of Nya Vattentorget

S-221 88 Lund, Sweden

declare under our sole responsibility that our product

Sony Ericsson type AAD-3021011-BV

and in combination with our accessories, to which this declaration relates is in conformity with the appropriate standards 3GPP TS 51.010-1, 3GPP TS 34.121 EN 301489-7, EN 301489-24, EN 300328, EN 301489-17 and EN 60950, following the provisions of, Radio Equipment and Telecommunication Terminal Equipment directive **99/5/EC** with requirements covering EMC directive **89/336/EEC**, and Low Voltage directive **73/23/EEC**.

Lund, February 2005

CE 0682

A handwritten signature in black ink, which appears to read 'Hiroshi Yoshioka', is written over a horizontal line.











*Hiroshi Yoshioka, Head
of Product Business Unit GSM/UMTS*

We fulfil the requirements of the R&TTE Directive (**99/5/EC**).











Icons

The table below describes some of the icons which appear in the status bar.

Icon Description











	Press  to go to the main menu
	The 3G (UMTS) network is available
	Tells you the strength of the GSM network signal
	GPRS is within range
	GPRS is within range and can be used
	A GPRS session is in progress
	You are within your home zone
	You are in a premium charge zone
	Tells you the status of the battery

Icon Description

	An ongoing voice call
	An ongoing video call
	You cannot receive any incoming calls
	You have missed an incoming call
	All incoming calls are diverted to a defined number
	All signals are off, except the alarm
	The alarm clock has been set and is on
	The timer has been set and is on
	The stopwatch is working in the background
	A profile other than Normal has been chosen
	The magic word is activated

Icons

Icon Description

	Speakerphone is activated
	The card lock or phone lock is on A secure Internet connection is established
	You have received a text message
	You have received an email message
	Your phone is receiving a picture message
	Your phone is sending a picture message
	You have received a picture message
	You have received a WAP push message
	The infrared port is on
	Infrared communication is in progress
	Bluetooth is turned on and your phone is visible

Icon Description

	Bluetooth headset is connected to your phone
	Data is being downloaded to the phone
	Data is being uploaded from the phone
	My friends status icon
	Line 1 is in use for outgoing calls
	Line 2 is in use for outgoing calls
	Ciphering is currently not being provided by the network
	The media player is running
	A Java™ application is running

Index

A

- accept calls 33
- account settings, email 42
- alarm clock 72
- alerts 58
- animations 50
- answering
 - calls 19
 - using voice control 30
- answering service 28
- appointments 72–74
- area information 45
- ask to save 25
- assembling, phone 5
- automatic redialling 20

B

- battery
 - charging 6
 - inserting 5
 - saving power 76
 - use and care 88

- Bluetooth 66–69
- bookmarks
 - Internet 63
- bookmarks, Internet 62
- brightness
 - display 76
- business cards 36
- buttons 8, 9

C

- calculator 76
- calendar 72–74
- call list 27
- call time 35
- call waiting 31
- caller-specific ringtones 58
- calling
 - from call list 27
 - from contacts 24
 - numbers in message 38
 - using voice dialling 29

calls

- accepting 33
- answering 20
- automatic redialling 20
- diverting 31
- emergency 21
- fixed dialling 34
- handling two calls 32
- international 20
- making 7, 19
- making notes during 35
- missed 20
- putting on hold 31
- receiving 7, 19
- recording 60
- rejecting 20
- restricting 34
- speed dialling 27
- video 21
- camera 46–50
- camera light 46

Index

cell information 45
certificates, Internet security 64
charging
 battery 6
code memo 79
codes
 PIN 7
 PUK 7, 85
conference calls 32
connectors 8, 9
contacts 23
 as default phonebook 23
 checking memory 26
 groups of 35
 synchronizing 65
cookies 64
copying
 to/from Memory Stick Duo 17
 to/from SIM card 26

D

date, setting 72
declaration of conformity 92

96

display
 brightness 76
 icons 93
diverting calls 31

E

editing pictures 52
email
 using 42–44
emergency calls 21

F

file manager 16
file types
 pictures 51
fixed dialling 34
formatting text, in messages 37

G

games 61
groups 35

H

handsfree 68, 69
help texts, in phone 13
hiding number 35

I

icons, in display 93
infrared port 70
instant messaging *See My Friends* 44
international calls 20
Internet
 bookmarks 63
 cookies 63
 security 64–65
 settings 61

J

Java™ applications 76
Java™, settings 64

K

key sound 58
keys 8, 9
keys and navigation 11–13

L

language
 changing 13
 in phone 13, 81

letters
 entering 14–15

light
 camera 46
 screen 76
 using as torch 80

locks
 phone lock 78, 84
 SIM card 77

long messages 39

M

magic word 29

main menu 11

media player 53–56

melodies 58

Memory Stick Duo™ 6

menu language 13

message alert 58

messages
 area information 45
 cell information 45
 email 42

 instant 44
 picture 39
 text 36

microphone, turning off/on 19

missed calls 20

MMS *See* picture messages 39

multitap text input
 entering 14

music, playing 54

MusicDJ™ 59

My friends 44–45

N

navigating menus 11

networks, selecting 18

notepad 35

notes 74–75

number
 hiding 35
 my own 33

O

on if silent 58

open to answer 19

P

passcodes
 Bluetooth 67
 code memo 79

passwords, Internet 64

phone language 13

phone lock 78, 84

phone overview 8, 9

phonebook 23
 adding contacts 24
 default phonebook 23
 synchronizing 65

picture messages 39–42

picture size
 camera 49

pictures 50–52
 file types 51
 screen saver 51
 wallpaper 51

PIN code
 changing 78
 entering 7

PlayNow™ 56

Index

power save 76
profiles 75
PUK 77, 78

R

recording
 calls 60
 sounds 60
 video clips 47
 voice commands 28–30

redialling 20
remote control 69
remote screen 53
resetting phone 83
restricted dialling 34
ringtones 58
roaming 18

S

safety guidelines 85
saving
 from picture messages 41
 from text messages 38
screen 76

screen light 76
screen saver 51
security
 code memo 79
 Internet 64–65
 phone lock 78
 SIM card lock 77
selection key 9, 11
self-portrait 48
sending
 appointments 74
 business cards 36
 contacts 26
 melodies and ringtones 59
 notes 75
 pictures 50
 tasks 74
 themes 60
 video clips 50
settings 61
settings for Java™ 64
setup wizard 7
shortcuts 13

SIM card

 copying to/from 26
 lock 77
 unblocking 77, 78
SIM numbers 23–25
slide show 51
SMS *See* text messages 36
SOS numbers *See* emergency
 calls 21
 sound recorder 60
 speaker volume 19
 speed dialling 27
 standby screen 11
 start-up screen 51, 76
 status bar 11
 stopwatch 75
 streaming media 56
 synchronizing 65–66

T

T9™ Text Input
 entering letters 15
tasks 74

templates
 for picture messages 41
 for text messages 39
text messages 36–39
themes 60–61
time, setting 72
timer 76
torch light 80
turning on/off
 Bluetooth 67
 infrared port 70
 key sound 58
 phone 7
 phone lock 78
 ringtones, melodies 58
 SIM lock protection 78
two voice lines 33

U
unblocking
 PIN 7
 SIM card 77, 78
Update Service 71

V
vibrating alert 58
video calls 21–23
video clips 53
video recorder 46–50
video size
 video recorder 49
voice answering 30
voice control 28–31
voice dialling 29
voicemail 28
volume
 changing 19
 setting ringtone 58
 vibrating alert 58

W
wallpaper 51
WAP *See* Internet 61
warranty 89
wizard
 setup 7

writing
 using multitap input 14
 using T9™ Text Input 15
writing languages 14

Z
zoom 47