

ZTE-RACER

User Manual

LEGAL INFORMATION

Copyright © 2010 ZTE CORPORATION.

All rights reserved.

No part of this publication may be excerpted, reproduced, translated or utilized in any form or by any means, electronic or mechanical, including photocopying and microfilm, without the prior written permission of ZTE Corporation.

The manual is published by ZTE Corporation. We reserve the right to make modifications on print errors or update specifications without prior notice.

Version No. : R1.0

Edition Time : 20100601

Manual No. : 079584501617

Contents

For Your Safety	11
Product Safety Information	11
RF Exposure	12
General Statement on RF Energy	12
Specific Absorption Rate (SAR)	12
Body Worn Operation	13
Limiting Exposure to Radio Frequency (RF) Fields	13
Regulatory Information	13
Distraction	14
Driving	14
Operating Machinery	14
Product Handling	14
General Statement on Handling and Use	14
Small Children	15
Demagnetization	15
Electrostatic Discharge (ESD)	15
Antenna	16
Normal Use Position	16
Air Bags	17
Seizures/ Blackouts	17
Repetitive Motion Injuries	17
Emergency Calls	18
Loud Noise	18
Bright Light	18

Phone Heating	18
Electrical Safety.....	18
Accessories.....	18
Connection to a Car	19
Faulty and Damaged Products	19
Interference	19
General Statement on Interface.....	19
Pacemakers	19
Hearing Aids	19
Medical Devices.....	20
Hospitals	20
Aircraft.....	20
Interference in Cars	20
Explosive Environments	21
Petrol Stations and Explosive Atmospheres	21
Blasting Caps and Areas	21
Getting Started.....	22
Overview	22
Key Definition	24
Starting Up	25
Installing the SIM/microSD Card and Battery	25
Removing the Battery and SIM/microSD Card	27
Charging the Battery	28
Powering On/Off Your Phone.....	29
Switching Your Phone to Sleep Mode	29

Waking Up Your Phone from Sleep Mode	30
Getting Around Your Phone.....	30
Using Finger Gestures	30
Home Screen	31
Phone Status and Notifications	33
Applications and Settings Preview	36
Phone Calls	41
Making a Call	41
Making a Call from Dialer	41
Making a Call from Contacts	41
Making a Call from Call History	42
Making a Call from a Text Message.....	42
Making a Conference Call	42
Making an Emergency Call	43
Making an International Call.....	43
Receiving a Call.....	44
Answering an Incoming Call.....	44
Rejecting an Incoming Call.....	44
Muting a Call	45
Putting a Call on Hold.....	45
Turning the Speaker On/Off	45
Ending a Call	45
Call Settings.....	46
Contacts	47
Starting to use Contacts	47

Contacts Screen	47
Managing Contacts	47
Importing/Exporting Contacts.....	47
Creating a Contact.....	48
Adding a Contact to Favorites.....	49
Searching for a Contact	49
Editing a Contact.....	50
Deleting a Contact	50
Entering Text.....	51
Using the On-screen Keyboard	51
Touch Input Settings	54
Messaging	56
Exchanging Messages	56
Composing an SMS	56
Composing an MMS	56
Managing Messages and Message Threads.....	57
Message Settings	58
Using Email	59
Creating an Email Account	59
Composing an Email.....	62
Reply to or Forward an Email	62
Email Settings.....	63
Getting Connected.....	64
Connecting to the Internet.....	64

Ways of Connecting to the Internet	64
GPRS/3G/EDGE	64
Wi-Fi	65
Using Browser.....	67
Opening Browser.....	67
Opening Web Pages	67
Favourites.....	67
Planet 3	68
Skype™	69
Windows Live™ Messenger.....	69
Browsing Options	70
Using Bookmarks	73
Browser Settings	74
Bluetooth.....	76
Turn on/off Bluetooth.....	76
Make your device visible	76
Change your device name	77
Pair with another Bluetooth device.....	77
Experiencing Multimedia	78
Camera	78
Opening Camera	78
Taking Pictures.....	78
Camera Settings.....	78
Video Recorder.....	79
Opening Video Recorder.....	79



















Shooting Videos.....	80
Video Settings.....	80
FM Radio.....	80
Opening FM Radio.....	81
Listening to FM Radio.....	81
Music.....	82
Opening Music.....	82
Playing Music.....	82
Creating Playlists.....	83
Managing Your Playlists.....	83
Setting a Song as Ringtone.....	83
Videos.....	84
Opening Videos.....	84
Playing Videos.....	84
Gallery.....	85
Sound Recorder.....	86
Opening Sound Recorder.....	86
Recording Your Memo.....	87
Google Applications.....	88
Signing In to Your Google Account.....	88
Using Gmail.....	88
Opening Gmail.....	88
Creating and Sending a Gmail Message.....	88
Using Google Calendar.....	89
Using Google Talk.....	89

Opening Google Talk	89
Adding a New Friend.....	89
Viewing and Accepting an Invitation.....	90
Changing Your Online Status.....	90
Starting a chat	90
Phone Settings.....	91
Basic Settings	91
Setting the Time and Date.....	91
Display Settings.....	91
Sound Settings.....	93
Language Settings	95
Mobile Network Services.....	96
Security Settings.....	97
Protecting Your Phone with a Screen Lock.....	97
Protecting Your SIM Card with a PIN.....	99
Setting up Credential Storage	100
Managing Memory	100
Managing Your Memory Card	100
Managing Internal Phone Storage.....	101
Application Settings	101
Managing Applications	101
Other Settings.....	103
Search Settings	103
Speech Synthesis Settings.....	103

Other Applications	104
Docs To Go	104
Note pad	104
Calculator	104
SIM Toolkit	104
Task Manager	105
Timer	105
Specifications	106
Index	107
Declaration of RoHS Compliance	109
Disposal of Your Old Appliance	110
EC DECLARATION OF CONFORMITY	111

For Your Safety

Product Safety Information

	Read the Safety Information section of this user guide on this page		Do not use while re-fuelling
	Do not use hand-held while driving		This device may produce a bright or flashing light
	For body-worn operation maintain a separation of 15 mm		Do not dispose of it in a fire
	Small parts may cause a choking hazard		Avoid contact with magnetic media
	This device may produce a loud sound		Avoid Extreme Temperatures
	Keep away from pacemakers and other personal medical devices		Avoid any contact with liquid, keep it dry
	Switch off when instructed in hospitals and medical facilities		Do not attempt to disassemble
	Switch off when instructed in aircrafts and airports		Do not rely on this device for emergency communications
	Switch off in explosive environments		Only use approved accessories

RF Exposure

General Statement on RF Energy

Your phone contains a transmitter and a receiver. When it is ON, it receives and transmits RF energy. When you communicate with your phone, the system handling your call controls the power level at which your phone transmits.

Specific Absorption Rate (SAR)

Your mobile device is a radio transmitter and receiver. It is designed not to exceed the limits for exposure to radio waves recommended by international guidelines. These guidelines were developed by the independent scientific organization ICNIRP and include safety margins designed to assure the protection of all persons, regardless of age and health.

The guidelines use a unit of measurement known as Specific Absorption Rate, or SAR. The SAR limit for mobile devices is 2 W/kg and the highest SAR value for this device when tested at the ear was 1.58 W/kg*. As mobile devices offer a range of functions, they can be used in other positions, such as on the body as described in this user guide**.

As SAR is measured utilizing the device's highest transmitting power, the actual SAR of this device while operating is typically below that indicated above. This is due to automatic changes to the power level of the device to ensure it only uses the minimum power required to communicate with the network.

* The tests are carried out in accordance with IEC standard PT62209-1.

** Please see body worn operation.

Body Worn Operation

Important safety information regarding radio frequency radiation (RF) exposure:

To ensure compliance with RF exposure guidelines the phone must be used with a minimum of 15 mm separation from the body.

Failure to observe these instructions could result in your RF exposure exceeding the relevant guideline limits.

Limiting Exposure to Radio Frequency (RF) Fields

For individuals concerned about limiting their exposure to RF fields, the World Health Organization (WHO) provides the following advice:

Precautionary measures: Present scientific information does not indicate the need for any special precautions for the use of mobile phones. If individuals are concerned, they might choose to limit their own or their children's RF exposure by limiting the length of calls, or using 'hands-free' devices to keep mobile phones away from the head and body.

Further information on this subject can be obtained from the WHO home page <http://www.who.int/peh-emf> WHO Fact sheet 193: June 2000.

Regulatory Information

The following approvals and notices apply in specific regions as noted.

Please find the section Declaration of RoHS Compliance and CE DOC in the end of this manual.

Distraction

Driving

Full attention must be given to driving at all times in order to reduce the risk of an accident. Using a phone while driving (even with a hands free kit) can cause distraction and lead to an accident. You must comply with local laws and regulations restricting the use of wireless devices while driving.

Operating Machinery

Full attention must be given to operating the machinery in order to reduce the risk of an accident.

Product Handling

General Statement on Handling and Use

You alone are responsible for how you use your phone and any consequences of its use.

You must always switch off your phone wherever the use of a phone is prohibited. Use of your phone is subject to safety measures designed to protect users and their environment.

- Always treat your phone and its accessories with care and keep it in a clean and dust-free place.
- Do not expose your phone or its accessories to open flames or lit tobacco products.
- Do not expose your phone or its accessories to liquid, moisture or high humidity.
- Do not drop, throw or try to bend your phone or its accessories.

- Do not use harsh chemicals, cleaning solvents, or aerosols to clean the device or its accessories.
- Do not paint your phone or its accessories.
- Do not attempt to disassemble your phone or its accessories, only authorized personnel must do so.
- Do not expose your phone or its accessories to extreme temperatures, minimum - [5] and maximum + [50] degrees Celsius.
- Please check local regulations for disposal of electronic products.
- Do not carry your phone in your back pocket as it could break when you sit down.

Small Children

Do not leave your phone and its accessories within the reach of small children or allow them to play with it.

They could hurt themselves or others, or could accidentally damage the phone.

Your phone contains small parts with sharp edges that may cause an injury or may become detached and create a choking hazard.

Demagnetization

To avoid the risk of demagnetization, do not allow electronic devices or magnetic media close to your phone for a long time.

Electrostatic Discharge (ESD)

Do not touch the SIM card's metal connectors.

Antenna

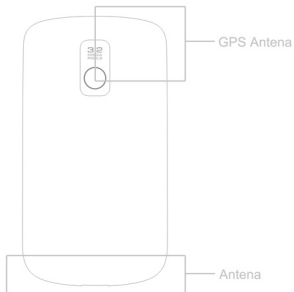

Do not touch the antenna unnecessarily.

Normal Use Position

When placing or receiving a phone call, hold your phone to your ear, with the bottom towards your mouth.

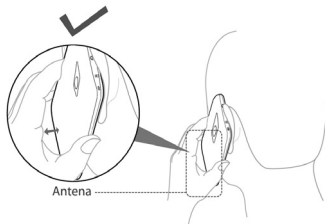
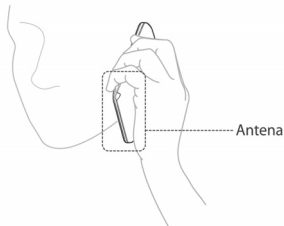

Air Bags

Do not place a phone in the area over an air bag or in the air bag deployment area. Store the phone safely before driving your vehicle.

Seizures/ Blackouts

The phone can produce a bright or flashing light.

Repetitive Motion Injuries

To minimize the risk of RSI when texting or playing games with your phone:

- Do not grip the phone too tightly.
- Press the buttons lightly.
- Use the special features which are designed to minimize the times of pressing buttons, such as Message Templates and Predictive Text.
- Take lots of breaks to stretch and relax.

Emergency Calls

This phone, like any wireless phone, operates using radio signals, which cannot guarantee connection in all conditions. Therefore, you must never rely solely on any wireless phone for emergency communications.

Loud Noise

This phone is capable of producing loud noises, which may damage your hearing. Turn down the volume before using headphones, Bluetooth stereo headsets or other audio devices.

Bright Light

The phone can produce a flashing light, so it can be used as a torch. However, do not use it too close to the eyes.

Phone Heating

Your phone may become warm during charging and during normal use.

Electrical Safety

Accessories

Use only approved accessories.

Do not connect with incompatible products or accessories.

Take care not to touch or allow metal objects, such as coins or key rings, to contact or short-circuit in the battery terminals.

Connection to a Car

Seek professional advice when connecting a phone interface to the vehicle electrical system.

Faulty and Damaged Products

Do not attempt to disassemble the phone or its accessory.

Only qualified personnel must service or repair the phone or its accessory.

If your phone or its accessory has been submerged in water, punctured, or subjected to a severe fall, do not use it until you have taken it to be checked at an authorized service centre.

Interference

General Statement on Interface

Care must be taken when using the phone in close proximity to personal medical devices, such as pacemakers and hearing aids.

Pacemakers

Pacemaker manufacturers recommend that a minimum separation of 15 cm be maintained between a mobile phone and a pacemaker to avoid potential interference with the pacemaker. To achieve this, use the phone on the opposite ear to your pacemaker and do not carry it in a breast pocket.

Hearing Aids

People with hearing aids or other cochlear implants may experience interfering noises when using wireless devices or when one is nearby.

The level of interference will depend on the type of hearing device and the distance from the interference source, increasing the separation between them may reduce the interference. You may also consult your hearing aid manufacturer to discuss alternatives.

Medical Devices

Please consult your doctor and the device manufacturer to determine if operation of your phone may interfere with the operation of your medical device.

Hospitals

Switch off your wireless device when requested to do so in hospitals, clinics or health care facilities. These requests are designed to prevent possible interference with sensitive medical equipment.

Aircraft

Switch off your wireless device whenever you are instructed to do so by airport or airline staff. Consult the airline staff about the use of wireless devices on board the aircraft, if your device offers a 'flight mode' this must be enabled prior to boarding an aircraft.

Interference in Cars

Please note that because of possible interference to electronic equipment, some vehicle manufacturers forbid the use of mobile phones in their vehicles unless a hands-free kit with an external antenna is included in the installation.

Explosive Environments

Petrol Stations and Explosive Atmospheres

In locations with potentially explosive atmospheres, obey all posted signs to turn off wireless devices such as your phone or other radio equipment.

Areas with potentially explosive atmospheres include fuelling areas, below decks on boats, fuel or chemical transfer or storage facilities, areas where the air contains chemicals or particles, such as grain, dust, or metal powders.

Blasting Caps and Areas

Power off your mobile phone or wireless device when in a blasting area or in areas posted power off “two-way radios” or “electronic devices” to avoid interfering with blasting operations.

Getting Started

Overview

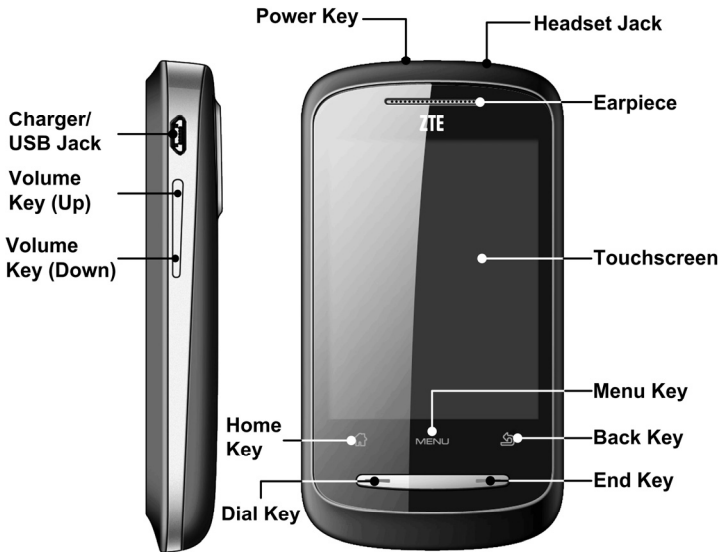



Key Definition

Key	Function
Power Key	<ul style="list-style-type: none">• Press to power on your phone.• Hold to get the phone options. You can select Silent mode, Vibration mode, Airplane mode or to power off your phone.• Press to switch your phone to sleep mode or wake it up.
Home Key	<ul style="list-style-type: none">• Tap to return to the Home Screen from any application or screen.• Hold to see the recently-used applications.
Menu Key	Tap to get the options on the current screen.
Back Key	Tap to go to the previous screen.
Dial Key	<ul style="list-style-type: none">• Press to open Dialer.• Press to answer a call.
End Key	<ul style="list-style-type: none">• Press to end a call.• Hold the key to get the same options as holding Power Key.
Volume Keys	<ul style="list-style-type: none">• Press Volume Key (Up) to turn the volume up.• Press Volume Key (Down) to turn the volume down.

Starting Up

Installing the SIM/microSD Card and Battery

Power off your phone before installing or replacing the battery, SIM card, or memory card.

1. Remove the battery cover.

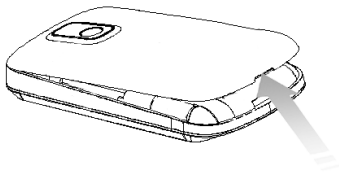
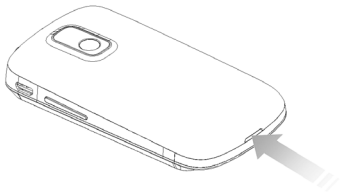

2. Hold your SIM card with the cut corner oriented as shown below and then insert it into the card holder properly.

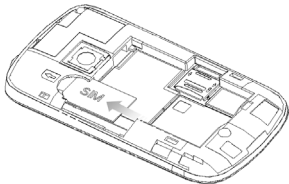

3. Open the microSD card holder. Hold your microSD card with the cut corner oriented as shown in the following picture and then insert it into the card holder properly.

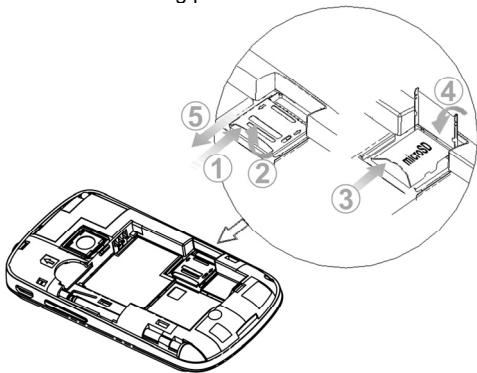

Notes:

microSD logo is a trade mark of SD Card Association.

4. Insert the battery by aligning the gold contacts on the battery with the gold contacts in the battery compartment on the phone. Push down the battery until it clicks into place.

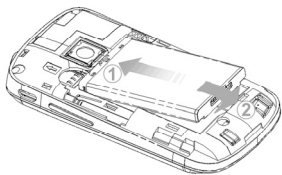

5. Replace the battery cover and press it gently until you hear a click.

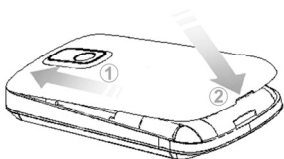

Removing the Battery and SIM/microSD Card

1. Make sure that your mobile phone is powered off.
2. Remove the battery cover.
3. Pull the battery up and remove it from the mobile phone.

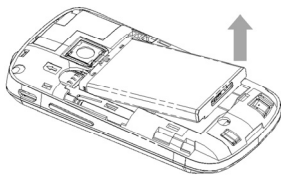

4. Pull the SIM card out and remove it from the mobile phone.
5. Open the microSD card holder, slide down gently and remove the microSD card from the holder.

Charging the Battery

The new battery is not fully charged. To charge the battery, you need to:

1. Connect the adapter to the charger jack.



2. Connect the charger to a standard AC wall outlet.

Notes:

- If the battery is low, there will be a pop-up message on the screen and the indicator light will be red.
- When you charge your phone, the indicator light will change according to the battery level:

Indicator color	Battery level
Red	Less than 10% of the total battery level
Orange	More then 10%, but less than 90% of the total battery level
Green	More than 90% of the total battery level

3. Disconnect the charger when the battery is fully charged.

Powering On/Off Your Phone

1. Make sure that your SIM card is installed and the battery is charged.
2. Press **Power Key** to power on your phone.

To power off your phone, hold **Power Key/ End Key** to get the phone options. Select **Power off**, and then tap **OK**.

Switching Your Phone to Sleep Mode

Press **Power Key**.

Sleep Mode suspends your device to a low power consumption state by turning off the display to save battery power. Your device also goes into Sleep Mode automatically when you leave it idle after a certain period of time.

Waking Up Your Phone from Sleep Mode

1. Press **Power Key** to activate your screen display.
2. Tap **Menu Key**, or drag  icon to the right.



Notes:

If you have set an unlock pattern for your phone (see *Phone Settings - Security Settings - Protecting Your Phone with a Screen Lock - Set the screen unlock pattern*), you need to draw the pattern to unlock your screen.

Getting Around Your Phone

Using Finger Gestures

You can use finger gestures to control your phone. The controls on your touch screen change dynamically depending on the tasks you are performing.

1. Tap the buttons, icons, or applications to select items or to open applications.
2. Hold a certain item to get available options.
3. Flick the screen to scroll up, down, left or right.
4. Drag a certain item to move it or to do some other corresponding operations.

Tips:

Besides using finger gestures to control your phone, you can also switch your phone screens (such as text input screen, gallery screen, etc.) between portrait or landscape mode by holding the phone upright or sideways.

Home Screen

You can add or remove shortcuts in your Home Screen.

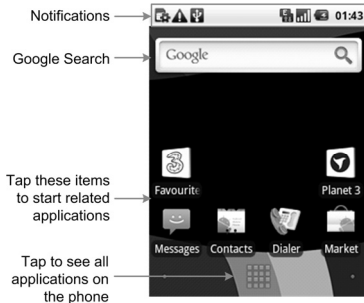

Extended Home Screen

The Home Screen extends left and right beyond the display. Flick left or right to get the extended Home Screens. You can add items to the extended Home Screens, too.

Customize the Home Screen Wallpaper

1. Tap **Home Key** to return to Home Screen.
2. Tap **Menu Key** and select **Wallpaper**.
3. Select the wallpaper you want to use from **Gallery** or **Wallpapers**.
4. Tap **Save** or **Set wallpaper**.



Add Home Screen Items

1. Tap **Home Key** to return to Home Screen.
2. If you want to add the item to an extended Home Screen, flick left or right.
3. Tap **Menu Key** and select **Add**.

You can also tap and hold the blank area of the screen to get the **Add to Home screen** menu.

4. Select the category and the item you want.





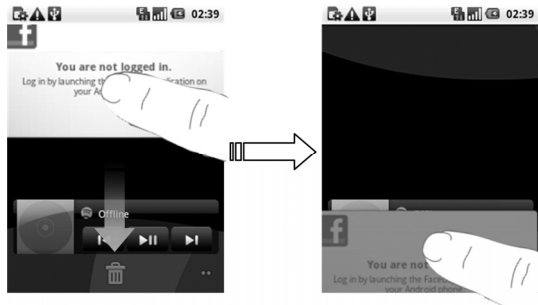







Delete Home Screen Items















1. Tap **Home Key**. If necessary, flick left or right to go to an extended Home Screen.
2. Hold the item you want to delete until the  icon changes to .
3. Drag the item to , as shown below.













Phone Status and Notifications







Phone Status

	GPRS connected		No signal
	GPRS in use		Signal strength
	EDGE connected		Roaming
	EDGE in use		Phone speaker is mute
	3G connected		Phone microphone is mute
	3G in use		No SIM card installed

	HSPA connected		GPS is connected
	HSPA in use		USB is connected
	Battery is very low		Connected to a Wi-Fi network
	Battery is low		Alarm is set
	Battery is full		Wired microphone headset
	Battery is charging		Bluetooth is on
	Vibrate mode		Speaker is on
	Airplane mode		

Notifications

	New Email		New Gmail message
	New SMS/MMS		New instant message
	New voicemail		Upcoming event
	Missed call		Song is playing
	Call in progress		Downloading data

	Call on hold		Content downloaded
	Call forwarding on		Uploading data
	Problem with SMS/MMS delivery		More (not displayed) notifications

Open the Notification Panel

From the Notifications Panel, you can get the information of calendar events, new messages, and ongoing settings such as call forwarding or the current call status. You can open the message, reminder, event notification, etc., from the Notification Panel.

1. Hold the notifications bar until  appears on the top of the Screen.
2. Drag the  downwards.



Tips:

You can also open the Notifications Panel from the Home Screen by tapping **Menu Key > Notifications**.

Applications and Settings Preview

Programs Preview

Your ZTE-RACER has lots of functions. Tap  to get the following programs that are pre-installed on your device.

Applications	Description
Alarms	Enables you to set alarms.
Browser	Enables you to browse the Internet.
Calc.	Enables you to perform the basic calculation, such as addition, subtraction, multiplication, division, and so on.
Calendar	Enables you to schedule appointments, including meetings and other events.
Camera	Enables you to enter the camera screen directly and use the camera features.
Contacts	Enables you to manage the information of your friends and colleagues.
Dialer	Enables you to dial a number to call.
Docs To Go	Enables you to view your documents.
Email	Enables you to enter the Email screen, where you can set up Email, send or receive Emails.

Applications	Description
Facebook	Enables you to use Facebook services on the go.
Favourites	Enables you to use popular websites and internet communications services via 3's gateway.
Files	Enables you to browse and manage your files on your microSD card.
FMRadio	Enables you to search for radio channels, listen to them, and save them on your device.
Gallery	Enables you to browse and manage your multimedia files.
Google Mail	Enables you to access your Gmail account and check your Email on your mobile phone.
Maps	Enables you to track your current location, view real-time traffic situations, and receive detailed directions to your destination.
Market	Enables you to access to useful applications and fun games which you can download and install on your phone.
Messages	Enables you to enter the Messages screen, where you can send and receive SMS and MMS messages.
Music	Enables you to browse your audio files and listen to them in the Music player.
Note pad	Enables you to create text notes.
Planet 3	Enables you to use 3's portal, a gateway and guide to the best of the mobile web.

Applications	Description
Settings	Enables you to adjust the device settings.
SIM Toolkit	Appears on the screen only if your SIM card provides this function. services. Please contact with your service provider for detailed information.
Sound Recorder	Enables you to record audio clips.
Spotify	Enables you to use Spotify's music service on your phone.
Talk	Enables you to send and receive instant messaging and voice over internet protocol (VOIP), offered by Google Inc.
Task Manager	Enables you to view and manage all the running programs on your device.
Timer	Enables you to measure the exact time it takes to do something.
Video Recorder	Enables you to shoot the video clips you like.
Videos	Enables you to browse your video files and watch them in the Videos player.
Yell	Enables you to use the yellow page service from Yell.com
YouTube	Enables you to view videos that have been uploaded by YouTube members.

Settings Preview

You can adjust the device settings. Tap **Home Key** >  > **Settings** to view all the settings on your device.

Tips:

You can also tap **Menu Key > Settings** from the Home Screen.

Wireless & networks	Enables you to configure and manage your phone's wireless connections, such as Wi-Fi, Bluetooth, mobile networks, and Virtual Private Networks. You can also enable the Airplane mode.
Call settings	Enables you to set up voicemail, call forwarding, call waiting, and caller ID, etc.
Sound & display	Enables you to set sound settings, such as ringtone, volume, and display settings such as screen brightness and so on.
Location & security	Enables you to set the screen unlock pattern, enable the SIM card lock, or manage the phone's credential storage. You can also select the sources to use when determining locations from My Location .
Applications	Enables you to manage applications and installation of new programs.
USB Settings	Enables you to configure the PC connection and USB Charging settings.
Accounts & sync	Enables you to manage your account and configure general sync settings.
Privacy	Enables you to configure privacy settings, such as Location, backup Settings, and Personal data.
SD card, USB Mass Storage & phone storage	Enables you to check the available memory card and phone memory.

Search	Enables you to set the search options.
Language & keyboard	Enables you to set the locale (system language and region) and text input options.
Accessibility	Enables you to manage accessibility options.
Text-to-speech	Enables you to configure the text-to-speech settings if you have installed a text-to-speech (voice data) application.
Date & time	Enables you to set the date, time, time zone, and date or time format. You can also use the network-provided values.
About phone	Enables you to view the phone status, battery use, and legal information.

Open recently used applications

1. Hold **Home Key** from any screen until the following recently used applications interface appears.

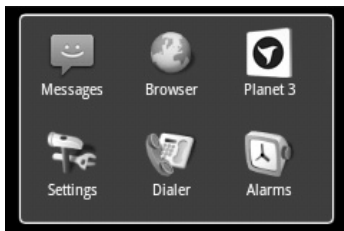

2. Tap the application you want to open.

Phone Calls





Making a Call

Making a Call from Dialer

1. Press **Dial Key** to open **Dialer**.

Tips:

You can also use the following methods to open **Dialer**:

- Tap **Dialer** from Home Screen.
 - Tap  > **Dialer** from Home Screen.
2. Enter the phone number or the contact name you want to call.
Tap  to erase wrong entry; hold this key to clear all digits. Your phone automatically lists the matching contacts. You can tap  to hide the keypad and to see if there are more matching numbers or contacts.
 3. Press **Dial Key** or tap .

Making a Call from Contacts

1. Tap **Home Key** >  > **Contacts**.
2. Slide your finger to scroll the contacts list and select the contact you want to call.

Tips:

You can search for a contact by tapping **Menu Key** > **Search**.

3. Press **Dial Key**.

Making a Call from Call History

1. Press **Dial Key** to open **Dialer**.
2. Tap  to open Call History.

Tips:

You can also open Call History by tapping the **Call log** tab from Contacts Screen.

3. Tap a recently dialed or received call from the list. You can scroll down the list to see more call history.
4. Tap **Call again/ Return call / Call back**, or press **Dial Key**.

Making a Call from a Text Message

If a text message contains a phone number that you want to call, you can make the call while viewing the text message.

1. Tap **Messages** from Home Screen and tap the message that contains the phone number you want to call.
2. Tap the message again and, if there are several numbers in the message, select the number you need.
3. Press **Dial Key** or tap .

Making a Conference Call

You can create a phone session between yourself and two or more other parties.

Notes:

This function is subject to your service operator and the network status.

1. Call the first number.

2. While you are connected to the first number, tap **Menu Key > Add call**.
3. Call the second number.
4. Tap **Menu Key > Merge calls**.
5. To add another party, tap **Menu Key > Add call**. Dial the number, and when connected, tap **Menu Key > Merge calls**.

Making an Emergency Call

1. Enter the emergency number for your location from **Dialer**.
2. Press **Dial Key**.

Notes:

It is possible to dial emergency numbers when the SIM card is not inserted.

Your SIM card may store other emergency numbers. Contact your service operator if you need more information.

Making an International Call

Notes:

This function is subject to your service operator and the network status.

1. Hold  from the Dialer to enter “+”.
2. Enter the full phone number.

For example: +49-123-12345678 in the following format: + country code-area code-phone number.

3. Tap  or press **Dial Key**.

Receiving a Call

Answering an Incoming Call

When there is an incoming call, the phone will display the information on the screen.

Press **Dial Key**, or drag  to the right, to answer the call.



Rejecting an Incoming Call

Press **End Key**, or drag  to the left, to reject an incoming call.

Muting a Call

During a call, you can mute your microphone so that the person with whom you are speaking cannot hear you, but you can still hear him or her.

Tap **Menu Key > Mute**.

When the microphone is turned off, the mute icon  appears in the indication area.

Putting a Call on Hold

During a call, you can use the following methods to put the call on hold.

1. Tap **Menu Key > Hold**.
2. Press **Dial Key**.

The  icon will be displayed if a call is on hold.

If you are already on a call and accepted the new call, the first call will be put on hold automatically. You can choose to switch between the two callers by tapping **Menu Key > Swap calls**.

Turning the Speaker On/Off

Tap **Menu Key > Speaker** during a call.

The speakerphone icon () appears in the status bar when the speakerphone is on.

Ending a Call

During a call, you can press **End Key** or tap **Menu Key > End call** to end it.

Call Settings

You can adjust the call settings of your phone. To open the call settings menu, press **Menu Key > Settings > Call settings** from Home Screen.

Fixed Dialing Numbers	Enables you to restrict outgoing calls to a fixed set of numbers. To enable this feature you must know your SIM card's PIN2 code.	
Voicemail service	Enables you to select a voicemail service provider.	
Voicemail settings	Enables you to specify a voicemail number.	
DTMF Tones	Enables you to set the length of DTMF tones.	
GSM/WCDMA call settings	Call forwarding	Enables you to forward incoming calls to a different number. You can select when to forward: Always forward, Forward when busy, Forward when unanswered, or Forward when unreachable.
	Caller ID	Enables you to choose whether to display your number in outgoing calls.
	Call waiting	Enables you to choose whether to be notified of new incoming calls while you are already on a call.

Contacts

Starting to use Contacts

You can add new contacts along with their information. Setting up communication information for the contact will allow you to call the person quickly or browse the contact's information. Contacts are saved in the phone memory or in the SIM card. If you store the information in the SIM card, you can fill the name and a number. If you store the information in the phone memory, you can also fill out each information field including Email, IM, address, pictures, etc.

Tap **Contacts** from Home Screen to enter the Contacts Screen.

Contacts Screen

There are three tabs in the Contacts Screen: **Call log**, **Contacts** and **Favorites**.

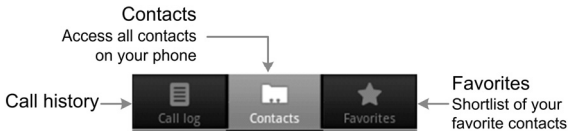

Managing Contacts

Importing/Exporting Contacts

You can import/export contacts from/to you SIM card or microSD card.

Import contacts from the SIM card or export to the card

1. Tap **Menu Key** > **Import/Export** from Contacts Screen.

2. Select to import or export contacts.
Your ZTE-RACER will automatically read the contacts.
3. Tap the contacts you want to import/export.

Tips:

Tap **Menu Key > Import all** to import all contacts from your SIM card.

Tap **Menu Key > Select all** to export all your phone contacts to the SIM card.

4. Tap **Done** if needed.

Import contact list from the memory card or export to the card

1. Tap **Menu Key > Import/Export** from Contacts Screen.
2. Select to import or export.

If you want to import contact list from microSD card, you should have vCard files saved in the microSD card. If there is more than one vCard file, you need to select the vCard file.

3. Tap **OK**.

Creating a Contact

1. Tap **Menu Key > New contact** from Contacts Screen.
2. Select the save location for the new contact.
3. Enter the name and numbers. You can also set Email addresses, IM accounts, postal addresses, organizations, notes, etc., if needed.
4. Tap **Done** to save the contact.

Adding a Contact to Favorites

1. Hold the contact from Contacts Screen until a pop-up menu appears.

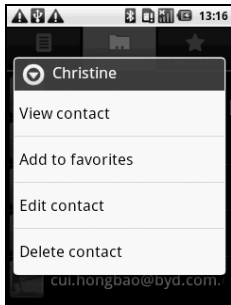

2. Tap **Add to favorites**.

Searching for a Contact

1. Tap **Menu Key > Search** from Contacts Screen.
2. Input the contact name you want to search for.
The matching contacts will be listed as you type.

Editing a Contact

1. Select the contact you want to edit from Contacts Screen.
2. Tap **Menu Key > Edit contact**.

Tips:

You can also edit a contact by holding it in Contacts Screen and selecting **Edit contact** from the pop-up menu.

3. Edit the contact and tap **Done**.

Deleting a Contact

1. Select the contact you want to delete from Contacts Screen.
2. Tap **Menu Key > Delete contact**.

Tips:

You can also delete a contact by holding it in Contacts Screen and selecting **Delete contact** from the pop-up menu.

3. Tap **OK**.

Entering Text

Using the On-screen Keyboard

When you enter a field that needs text or numbers, hold the input box and select **Input method** from the pop-up menu to change input method. With TouchPad input method, it is also possible to change the on-screen keyboard layouts.

QWERTY Keyboard

QWERTY Keyboard is a keyboard layout similar to a desktop computer keyboard. You can choose to use the landscape orientation of the on-screen keyboard, by turning the phone sideways.

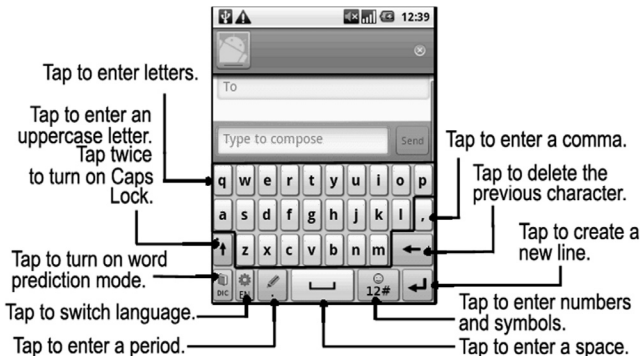

Tips:

- If you want to use the landscape QWERTY keyboard, you need to select the **Orientation** check box in **Settings > Sound & display**.
- The landscape QWERTY keyboard is not supported in all applications.

CooTek T+

CooTek T+ Combines two letters or symbols on each button of a QWERTY keyboard-based layout.



Tap to enter the left letter on the key; tap and flick right to enter the right letter/ symbol on the key

12-Key PhonePad

12-Key PhonePad is a keyboard layout similar to a common phone keypad. You can choose to use the landscape orientation of the on-screen keypad, by turning the phone sideways.



Tap a key repeatedly until the desired letter appears

Smart Dialer Keyboard

Smart Dialer Keyboard is on-screen keyboard layout similar to a mobile phone keyboard.

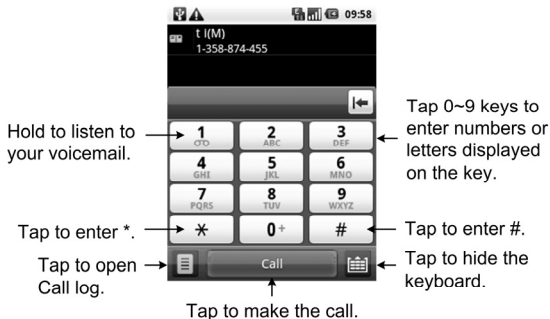

Touch Input Settings

You can configure the touch input settings by tapping **Menu Key > Settings > Language & keyboard** from Home Screen.

Android keyboard

- **Vibrate on keypress/Sound on keypress:** Enables vibration/sound feedback as you touch on the screen.
- **Auto-capitalization:** Select the check box to capitalize the first letter of each sentence automatically.

TouchPal

- Basic settings
 - **Word prediction:** Enables the word prediction function.
 - **Key press sound:** Enables the sound feedback as you touch on the screen.
 - **Key press vibration:** Enables the vibration feedback as you touch on the screen.
 - **Mixed language input:** Enables the language auto-detection if no more than 3 languages are selected.
 - **Select languages:** Select the languages that you may use.
 - **Swipe to switch layout:** Swipe horizontally over the keyboard to switch its layout.
 - **Layout in portrait/landscape mode:** Select the default keyboard layout in portrait and landscape mode using TouchPal input method.
- Prediction & Gestures
 - **Predict next word:** Enables your ZTE-RACER to predict the next word.
 - **Correct mistyping:** Enables your ZTE-RACER to correct your mistyping.

- **Slide-down symbols:** Enables you to input symbols and numbers by sliding down on keys.
- **Relevant words:** Enables you to input relevant words by sliding on candidates.
- **Help:** Get the online English user manual for using TouchPal.

User dictionary

You can add words to your dictionary by tapping **Menu Key > Add**.

Messaging

Messages is where all of your SMS and MMS accounts are located.

To access your message accounts, tap **Messages** from Home Screen or Programs Screen.

Exchanging Messages

From Messages, you can receive and send an SMS or MMS.

When you receive a new message, you can open it from the Notifications Panel, or from Messages Screen. Simply tap on the new message to read it.

The device will alert you for the unread message(s) with the icon  on the notifications bar.

Composing an SMS

1. Tap **Messages** from Home Screen.
2. Tap **New message**.
3. Tap **To** field and enter the recipient's number. You can also enter the first letters of the recipient's name to display a list of matching names stored in **Contacts**, and then select a recipient from the list.
4. Tap **Type to compose** field and enter the content of your SMS.
5. Tap **Send** to send your SMS.

Composing an MMS

1. Tap **Messages** from Home Screen.
2. Tap **New message**.
3. Tap **To** field and enter the recipient's number. You can also enter the first letters of the

recipient's name to display a list of matching names stored in **Contacts**, and then select a recipient from the list.

4. Tap **Menu Key > Add subject** to enter the subject of your MMS.
5. Tap **Type to compose** field and enter the contents of your MMS.
6. Tap **Menu Key > Attach** to add an attachment to your MMS:
 - ◆ **Pictures**: Select a picture to add to your MMS.
 - ◆ **Capture picture**: Take a photo and add to your MMS.
 - ◆ **Videos**: Select a video clip to attach to your MMS.
 - ◆ **Capture video**: Shoot a video clip and add to your MMS.
 - ◆ **Audio**: Select an audio file to add to your MMS.
 - ◆ **Record audio**: Record an audio file and add to your MMS.
 - ◆ **Slideshow**: Edit a sildeshow and add to your MMS.
7. Tap **Send** to send your MMS.

Tips:

- If you add a subject or an attachment to your SMS, the SMS will be converted to an MMS automatically.
- If you remove the subject and attachments of your MMS, the MMS will be converted to an SMS automatically.

Managing Messages and Message Threads

SMS and MMS messages which are sent to and received from a contact (or a number) are grouped into message threads in the Messages screen. Threaded messages show you exchanged messages (similar to a chat program) with a specific contact on the screen. Message threads are sorted by the time when you received them, with the latest one on the top.

Reply to a message

1. Tap the message you want to reply to from Messages Screen.
2. Tap **Type to compose** and enter the content of your message.
3. Tap **Send**.

Delete a message (thread)

1. Tap **Menu Key > Delete threads** from Messages Screen.
2. Select the threads you want to delete.
If you want to delete all threads, tap **Menu Key > Delete threads**.
3. Tap **Delete**.

Notes:

You can also delete a thread by opening it from Messages Screen and tapping **Menu > More > Delete thread**. To delete a message, hold the message and select **Delete message** from the pop-up menu.

Message Settings

Tap **Menu Key > Settings** from Messages Screen. You can configure your message settings.

Storage settings

- **Delete old messages:** Delete old messages automatically when the memory limits are reached.
- **Multimedia/Text message limit:** Set the maximum number of multimedia/text messages saved in a single conversation thread.

SMS settings

- **Delivery reports:** Request a delivery report for each SMS message you send.
- **Manage SIM card messages:** Manage the messages saved in your SIM card.

MMS settings

- **Delivery reports:** Request a delivery report for each MMS message you send.
- **Read reports:** Request a read report for each MMS message you send.
- **Auto-retrieve:** Select to retrieve messages automatically.
- **Roaming auto-retrieve:** Select to retrieve messages automatically when you are roaming.

Notification settings

- **Notifications:** Select to display message notifications in status bar.
- **Select ringtone:** Select a ringtone for your incoming messages.
- **Vibrate:** Select to make your phone vibrate when receiving a new message.

Using Email

Tap  > **Email** from Home Screen. You can enter Email Screen to setup your Email account and exchange Emails.

Creating an Email Account

1. Enter your Email address and password, and then tap **Next**.



2. Select the type of your account (**POP3/IMAP/Exchange**). Edit the incoming server settings, and then tap **Next**.

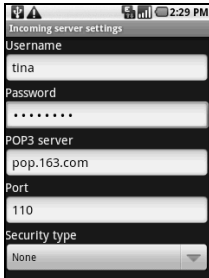

Your phone will check the incoming server settings and finish the setup automatically. If you are notified that setup could not be finished, you might need to correct some settings to finish it.

3. Edit the outgoing server settings and tap **Next**.



Your phone will check the outgoing server settings and finish the setup automatically.

4. Set the Email checking frequency; select whether to use this account by default or be notified when Email arrives, and then tap **Next**.
5. Give your account a name and set a name displayed on outgoing message, and then tap **Done**.

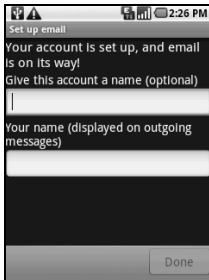

Composing an Email

After creating an Email account, you can compose and send Email messages.

1. Tap **Menu Key > Compose** from Email Screen.
2. Tap the **To** field and enter the recipient's address.

When you enter the address, the matching addresses saved in your Contacts will be displayed. You can tap the recipient from the list.

3. Enter the subject and the content of your Email.
4. Tap **Send**.

Reply to or Forward an Email

1. Tap the Email account from Email Screen to open the Email inbox.
2. Tap the Email you want.

3. Tap **Reply /Reply all** to reply to the Email, or tap **Menu Key > Forward** to forward the Email.

Email Settings

Tap the account you want to set from Email Screen and tap **Menu Key > Account settings**. You can get the following Email settings.

General settings

- **Account name:** Set your account name.
- **Your name:** Set the name displayed on outgoing message.
- **Email check frequency:** Set the Email checking frequency.
- **Power-saving mode:** Select the check box to enable automatic adjustment of E-mail synchronization time in order to save power.
- **Default account:** Select the check box to send Email from this account by default.

Notification settings

- **Email notifications:** Select to be notified in status bar when Email arrives.
- **Select ringtone:** Select the ringtone for incoming Email notification.
- **Vibrate:** Select to be notified by vibration with ringtones when Email arrives.

Server settings

- **Incoming settings:** Set the incoming server settings.
- **Outgoing settings:** Set the outgoing server settings.

Getting Connected

Connecting to the Internet

Your phone's networking capabilities allow you to access the Internet or your corporate network.

Ways of Connecting to the Internet

You can use the default connection settings to connect to the Internet through your mobile network (GPRS/3G/EDGE), or Wi-Fi.

GPRS/3G/EDGE

Use **GPRS/3G/EDGE** to connect to the Internet and to send and receive MMS/Email messages on your phone. You will need a data plan to use your wireless service operator's GPRS/3G/EDGE network. Check with your operator for GPRS/3G/EDGE rates. If the GPRS/3G/EDGE settings are not pre-configured on your phone, contact your operator for the parameters. Do not change the settings as this may cause services to stop working.

Add a new GPRS/3G/EDGE connection

Before you begin, get the following information from your network service operator:

- Access Point Name (APN)
 - Your user name and password if needed.
 - Server IP and the port number if the network uses a proxy server.
 - Server type (HTTP, WAP, Secure WAP, Socks) if the network uses a proxy server.
1. Tap **Wireless & networks > Mobile networks > GSM/UMTS Options > Access Point Names** from Settings Screen.

2. Tap **Menu Key > New APN**.
3. Tap **Name** to enter you APN name displayed in the APN list (You can name it as you like).
4. Tap **APN** to enter the APN you want to add.
5. Tap **Proxy** and **Port** to enter the Server IP and port if the network uses a proxy server.
6. Tap and enter **Username** and **Password**. (If there is no Username and Password, leave them blank.)
7. Tap and enter **APN type** if needed.
8. Tap **Menu Key > Save** to complete.

Notes:

If you want to set the APNs to default settings, tap **Menu Key > Reset to default**.

Wi-Fi

Wi-Fi provides wireless Internet access over distances of up to 300 feet (100 meters).

Turn on Wi-Fi

1. Tap  > **Settings > Wireless & networks**.
2. Select the **Wi-Fi** check box to turn Wi-Fi on.

Add a Wi-Fi network

1. Tap  > **Settings > Wireless & networks > Wi-Fi settings**.



The Wi-Fi network names and security settings (**Open network** or **Secured network**) of detected Wi-Fi networks are displayed in the Wi-Fi networks section.

2. Tap a network to connect.

- If you selected an open network, you will be automatically connected to the network.
- If you selected a secured network, you will need to input the correct password.

Check the Wi-Fi network status

You can check the Wi-Fi network status from the status bar and wireless controls.

1. Open the Notifications panel (see *Getting Started - Getting around Your Phone - Phone Status and Notifications - Open the Notification Panel*) and check the  icon to view the Wi-Fi network status.
2. Tap  > **Settings > Wireless & networks > Wi-Fi settings**, then tap the wireless network that the phone is currently connected to.

You can check the network status from the pop-up window.

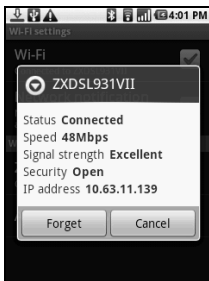

Using Browser

You can use your Browser to browse most websites. Some web pages may not be displayed properly as some specific web page technologies, such as Flash, are not supported by the phone. Your phone will automatically create an EDGE or GPRS/3G connection for you via the APNs you set while browsing web pages.

Opening Browser

When you use EDGE or GPRS/3G mobile network to browse web pages, the phone will automatically make data connections.

Tap  > **Browser** from Home Screen to start this function.

Opening Web Pages

In **Browser**, you can open web pages through the following ways.

1. Tap the address box to enter the web address you want to visit, and tap **Go** to connect to the page.
2. Tap **Menu Key** > **Bookmarks**. Select an item from **Bookmarks**, or tap **Most visited/History** tab to select an item to open.

Favourites

Favourites gives you quick access to the most popular mobile websites like Facebook[®], Google[™], Skype[™], MySpace[™], Bebo, YouTube[™], Twitter, BBC, as well as taking you to your My3 account.

To go to your favourites just select the **Favourites** icon displayed on Home Screen. Then tap on your chosen icon.



Planet 3

This is Three's gateway and guide to the best of the mobile internet. In Planet 3 you'll find these three sections:

- ◆ Today – gives you the best websites and apps, the latest stories, and great offers.
- ◆ Services – an easy menu that helps you navigate the best of the mobile internet.
- ◆ My3 account – this is where you can access your account information. See how many minutes and texts you've got left, pay your bill and even buy a top-up.

It's free to click on Planet 3 but usual internet data charges apply when you click on a web link or download an application. Three will tell you if they are going to charge you before you do.

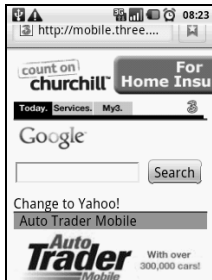

Skype™

You can stay in touch with free Skype™-to-Skype calls and instant messaging to millions of others using Skype™ in the UK and worldwide.

To go to Skype™ from Home Screen tap **Planet 3** and you will find a Skype link in Top Sites. Once in Skype™ you'll need to set up a Skype™ account. Just use your email address to sign up, or if you've already signed up on your existing computer, you can use your existing Skype™ ID. For more information go to **Three.co.uk/skype**



Windows Live™ Messenger

With Three you can send free instant messages with Windows Live™ Messenger.

To go to Windows Live™ Messenger from Home Screen tap the **Planet 3** icon and you will find a Windows Live Messenger link in Top Sites. You'll need to set up an ID and password if you haven't already got one. For more information go to **Three.co.uk/messenger**

Browsing Options

When browsing web pages, you can do some operations.

1. Flick the web page to display the zoom buttons. Tap  to zoom in and tap  to zoom out. You can also double tap the page to zoom in or zoom out.



2. Tap **Menu Key > Refresh** to refresh the page.
3. Tap **Menu Key > More > Forward** to go to the next page.
4. Tap **Menu Key > More > Find on page** to search for text keywords in the page.
5. Tap **Menu Key > More > Select text** and slide your finger on the page to select the text you want to copy.

Your phone automatically copies the selected text to the clipboard.

6. Tap **Menu Key > More > Share page** to send the page link via Gmail, Email, messages or Facebook.
7. Tap **Menu Key > More > Page info/Downloads** to view the page or download information.

8. Rotate your phone sideways to view the landscape Browser Screen if you select the **Orientation** check box in **Settings > Sound & display**.



Open a new browser window

1. Tap **Menu Key > New window** to open a new browser window.
2. Tap the address bar to enter the website you want to browse.

Switch between different browser windows

If you have opened several browser windows, you can switch between them.

1. Tap **Menu Key > Windows** to view all the windows you opened.
2. Tap the window you want to browse.

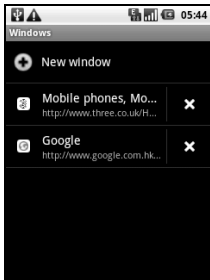
**Tips:**

You can also tap  to close each window.

Open links in web pages

Tap a link to open the page.

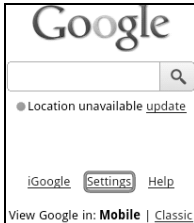

You can also hold on the link to open the shortcut menu:

- **Open:** Open the web page.
- **Open in new window:** Open the web page in a new window.
- **Bookmark link:** Save the link to your **Bookmarks**.
- **Save link:** Download the linked web page to your phone.
- **Share link:** Send the link via Email, Gmail, messages, or share it on your Facebook.
- **Copy link URL:** Copy the link to the clipboard.

Download files from web pages

Tap the link that directs to the file you need or hold the link and select **Save link** to download the file to your phone.

Notes:

Downloaded files are saved in your microSD card.

Using Bookmarks

You can save your frequently-used pages as bookmarks on your phone.

Add a new bookmark

1. Open a web page.
2. Tap **Menu Key > Bookmarks**.
3. Tap **Add**.
4. Enter a name of the bookmark and tap **OK**.

Edit a bookmark

1. Open a browser window.
2. Tap **Menu Key > Bookmarks**.
3. Select an item you want to edit and hold it until the shortcut menu pops up.
4. Select **Edit bookmark**.
5. Edit the name or link, and then tap **OK** to save it.

Delete a bookmark

1. Open a browser window.
2. Tap **Menu Key > Bookmarks**.
3. Hold the item you want to delete until the shortcut menu pops up.
4. Select **Delete bookmark** and tap **OK** to confirm the deletion.

Browser Settings

You can set the text size, home page etc., by tapping **Menu Key > More > Settings** from a browser window.

Page content settings

- **Text size:** Adjust the browser text size.
- **Default zoom:** Set the browser default zoom.
- **Open pages in overview:** Select to show overview of newly opened pages.
- **Text encoding:** Select a text encoding type.
- **Block pop-up windows:** Select the check box to block pop-up windows.
- **Load images:** Select the check box to show the images on web pages.

- **Auto-fit pages:** Select the check box to format the web pages to fit the screen.
- **Landscape-only display:** Display the web pages only in landscape screen orientation.
- **Enable JavaScript:** Select the check box to enable JavaScript.
- **Enable plug-ins:** Select to enable plug-ins.
- **Open in background:** Select the check box to open new windows behind the current one.
- **Set home page:** Select to edit the home page web site.

Privacy settings

- **Clear cache:** Delete all the cached page contents.
- **Clear history:** Clear the browser navigation history.
- **Accept cookies:** Select the check box to allow sites to save and read cookies.
- **Clear all cookie data:** Clear the browser cookies.
- **Remember form data:** Select the check box to remember the data you type in forms for later use.
- **Clear form data:** Clear the saved form data.
- **Enable location:** Select to allow sites to request access to your location.
- **Clear location access:** Select to clear access for all websites.

Security settings

- **Remember passwords:** Select the check box to save usernames and passwords for websites.
- **Clear passwords:** Clear saved passwords.
- **Show security warnings:** Select the check box to show warnings if there is a problem with a site's security.

Advanced settings

- **Website settings:** View advanced settings for individual websites. Only available for some websites.
- **Reset to default:** Clear all browser data and reset all settings to default.

Bluetooth

Bluetooth is a short-range wireless communication technology. Phones with Bluetooth capabilities can exchange information within a distance of about 10 meters without any physical connection. The Bluetooth devices must be paired before the communication is performed.

Turn on/off Bluetooth

1. Tap  > **Settings > Wireless & networks.**
2. Select the **Bluetooth** check box to turn Bluetooth on.

The  icon will be displayed in the status bar. If you want to turn Bluetooth off, clear the **Bluetooth** check box.

Notes:

By default, Bluetooth is turned off. If you turn it on, and then turn off your device, Bluetooth is also turned off. When you turn on your device again, Bluetooth turns on automatically.

Make your device visible

Other devices with Bluetooth capabilities can detect your phone, establish a partnership, or use a Bluetooth service.

1. Tap  > **Settings** > **Wireless & networks** > **Bluetooth settings**.
2. Select the **Bluetooth** check box if needed.
3. Select the **Discoverable** check box to make your device visible.

Change your device name

1. Tap  > **Settings** > **Wireless & networks** > **Bluetooth settings**.
2. Select the **Bluetooth** check box if needed.
3. Tap **Device name**.
4. Enter the name and tap **OK**.

Pair with another Bluetooth device

You can pair your device with another device that has Bluetooth capabilities. Once you do this, the two devices must have Bluetooth turned on but do not need to be visible for you to exchange information between them.

1. Tap  > **Settings** > **Wireless & networks** > **Bluetooth settings**.
2. Tap **Scan for devices**.
Your phone will display all reachable Bluetooth devices in the **Bluetooth devices** section.
3. Tap the device you want to pair with.
4. If necessary, type your PIN to pair and tap **OK**.

Tips:

The same PIN should be entered on the other device.

Experiencing Multimedia

Camera

Your phone comes with a 3.2 megapixel camera that lets you capture sharp pictures.

Opening Camera

Tap  > **Camera** to open the camera.

Notes:

You can switch from the camera to the video recorder quickly:

Drag the  switch up.

Taking Pictures

Aim the camera at the subject and then tap  to take the shot.

- Tap the picture in the upper-right corner of the screen to view the picture just captured.
- Tap **Menu Key** > **Gallery** to view all of your pictures.

Camera Settings

By tapping **Menu Key** > **Settings** from Camera Screen, you can adjust the camera settings.

Camera settings

- **White balance:** Tap to adjust the white balance. White balance enables the camera to capture colors more accurately by adjusting to the current lighting environment.
- **Anti Banding:** Select to adjust preview images automatically or for specified AC frequencies, in order to avoid striate previews caused by interference.

- **Color effect:** Tap to select the picture effect.
- **Store location:** Select to record location in picture data.
- **Select ISO:** Tap to set the ISO level to 100, 200, 400, or 800, or set it back to Auto. Higher ISO numbers are better for taking pictures in low light conditions.
- **Picture size:** Tap to select the size of your captured pictures.
- **Picture quality:** Tap to adjust the picture quality.
- **Focus mode:** Select to turn on/off autofocus.
- **Sharpness:** Tap to adjust picture sharpness.
- **Contrast:** Tap to adjust the contrast. Higher contrast ratio enables you to easily see the sharp colors of blue, red or green against any black color.
- **Saturation:** Tap to adjust the saturation.

Restore to default settings

Tap **Restore to default settings** to reset the camera settings.

Video Recorder

Video Recorder enables you to shoot video clips.

Opening Video Recorder



Tap  > **Video Recorder**.

Notes:

You can switch from the video recorder to the camera quickly:

Drag the  switch down.

Shooting Videos

1. Tap  to start shooting.
2. Tap  to stop shooting.

Notes:

- Tap the picture in the upper-right corner of your Video Recorder Screen to view the video clip just shot.
- Tap **Menu Key > Gallery** to view all of your video clips.

Video Settings

Tap **Menu Key > Settings** from Video Recorder Screen to adjust the video settings.

Camcorder settings

- **Video quality:** Select video quality.
- **Video Encoder:** Select the video encoder type.
- **Audio Encoder:** Select the audio encoder type.
- **Video duration:** Tap to set the video duration.

Restore to default settings

Tap **Restore to default settings** to reset the camcorder settings above.

FM Radio

With the FM Radio, you can search for radio channels, listen to them, and save them on your device. Note that the quality of the radio broadcast depends on the coverage of the radio station in that particular area. The wired headset works as an antenna, so always connect the headset when using the radio. When you receive an incoming call while listening to the radio, the radio will be turned off temporarily.



Opening FM Radio

You need to insert a headset to your phone before opening the FM radio.

Tap  > **FMRadio** to open the application.

The radio is turned on automatically, and you will see the  icon in the status bar.

Listening to FM Radio

1. Tap  or  to scan for the previous or next channel.
2. Tap **Menu Key** > **Adjust**, and then tap  to fine tune the frequency by +/-0.1 MHz manually.
3. Hold on a channel frequency until a red box appears on the screen, and then drag the frequency to the box to save the channel.

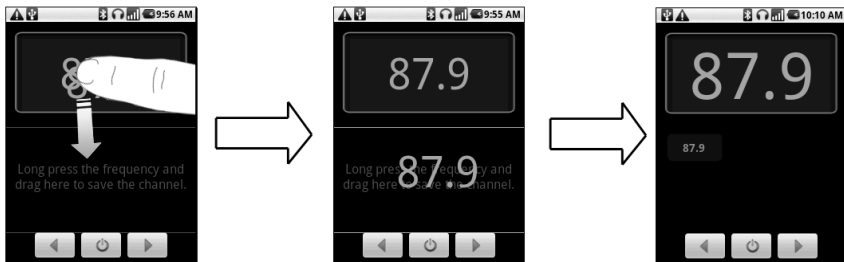

4. Press **Volume Keys** to adjust the volume.
5. Tap **Menu Key** > **Sleep** to set the FM radio sleep timer.
6. Tap  to turn off the FM radio.

Music

You can play digital audio files from your phone's memory card in Music.

Opening Music

You need to copy the audio files you want to play to your memory card first.

Tap  > **Music** to open Music player.

Playing Music

1. Tap Artists/Albums/Songs/Playlists to get the songs you want to play.
2. Tap a song from the list to start playing.

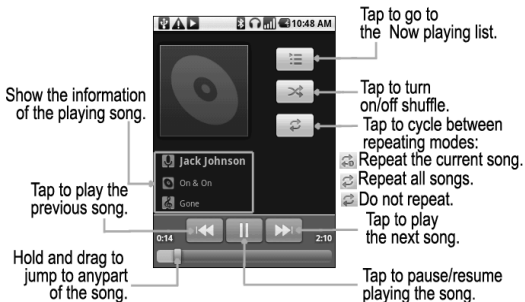

Creating Playlists

You can create some playlists to organize your music files.

1. Select a music file you want to add to a new playlist.
2. Tap and hold on the file until a shortcut menu pops up.
3. Tap **Add to playlist**.
4. Tap **New**.
5. Enter the playlist name and tap **Save**.

The playlist is created and the file you selected is added to the playlist.

Managing Your Playlists

1. Tap **Playlists** from the Music Screen to view all playlists.
2. Hold on the playlist you want to play or edit until a shortcut menu pops up. You can play, delete or rename the playlist.

Add songs to your playlist

1. Open the folder where the song is.
2. Hold on the song until a shortcut menu pops up.
3. Select **Add to playlist**.
4. Select a playlist from the subsequent list.

Setting a Song as Ringtone

1. Open the folder where the song is.
2. Hold on the song until a shortcut menu pops up.
3. Select **Use as phone ringtone**.

Tips:

You can also set a song as ringtone when you are playing it by tapping **Menu Key > Use as ringtone**.

Videos

You can use **Videos** to play your video files.

Opening Videos

Tap  > **Videos** to open the video player.

Your phone will show you all video files saved on your memory card.

Playing Videos

Copy the video file to your memory card before playing it.

1. Tap the video file you want to play from Videos Screen.
2. Tap on the screen to show or hide the control bar.

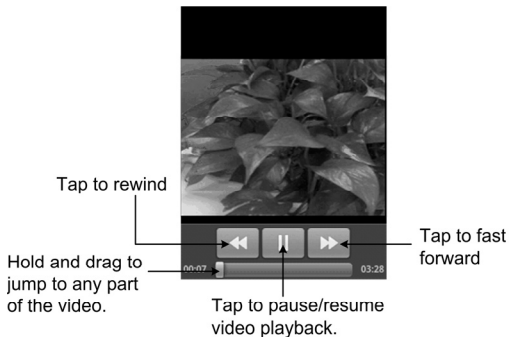

Gallery

Galley helps you view pictures and play back videos. For pictures, you can also do some basic editing tasks. For instance, set them as your wallpaper or contact icon, and share with your friends.

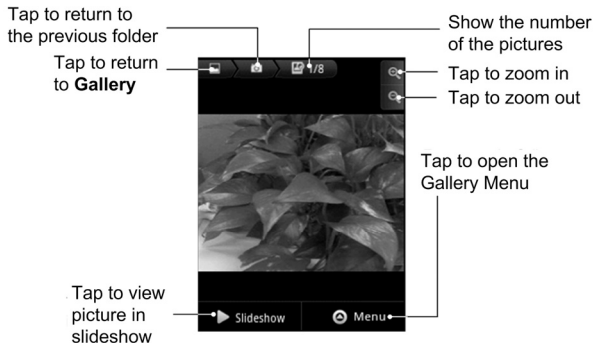

Sound Recorder

Sound Recorder enables you to record your voice memos that you can set as ringtone.



Opening Sound Recorder

Tap  > **Sound Recorder**.

Notes:

You need to install a memory card to use **Sound Recorder**.

Recording Your Memo

1. Get the microphone near the speaker.
2. Tap  to start recording.
3. Tap  to stop recording.
4. Tap  to play back the voice recording.
5. Tap **Use this recording** to save the voice recording, or tap **Discard** to discard the recording.

Notes:

You can find your recordings in  > **Music** > **Playlists** > **My recordings**. If you want to set a recording as ringtone, hold the recording and select **Use as phone ringtone** from the subsequent pop-up menu.

Google Applications

Signing In to Your Google Account

Signing in to your Google Account enables you to synchronise Gmail, Calendar, and contacts between your phone and the web.

1. Tap a Google application, such as **Talk**.
2. Read the instructions and tap **Next**.
3. Tap **Sign in** if you have a Google account. Enter your username and password, and then tap **Sign in**.

Tap **Create** if you do not have a Google account.

Using Gmail

Gmail is Google's web-based email service. Gmail is configured when you sign in to your Google account. Depending on your synchronisation settings, Gmail on your phone can automatically synchronise with your Gmail account on the web.

Opening Gmail

Tap  > **Google Mail**.

Creating and Sending a Gmail Message

1. In the Inbox, press **Menu Key** > **Compose**.
2. Enter the message recipient's Email address in the **To** field. If you are sending the Email to several recipients, separate each Email address with a comma. You can add as many

recipients as you want.

3. Enter the Email subject, and then compose your Email.
4. After composing your Email, tap **Send**.

Using Google Calendar

Tap **Home Key** >  > **Calendar** to use Google Calendar, Google's time management application. You can use the calendar to schedule appointments, including meetings and other events. Your appointments will be displayed on the screen as are scheduled. All your appointments are synchronised to your Google account, which enables you to share your schedule, get your entire calendar on the go, and receive Email reminder for your upcoming events.

Using Google Talk

Google Talk is Google's instant messaging program, which enables you to communicate with other people that also use Google Talk.

Opening Google Talk

Tap  > **Talk**.

Adding a New Friend

You can only add people who have a Google Account.

1. In the Friends list, press **Menu Key** > **Add friend**.
2. Enter the Google Talk ID or Email address of the friend you want to add.

Viewing and Accepting an Invitation

1. In the Friends list, press **Menu Key > Invites**.
All chat invitations you have sent or received are listed on the pending invitations screen.
2. Tap a pending invitation that you received, and then tap **Accept** or **Decline**.

Changing Your Online Status

1. Tap the online status icon beside your status message, and then select the status you want on the menu.
2. Tap the status message box and then enter your personalised status message using the on-screen keyboard.

Starting a chat

1. Tap a friend in the Friends list.
2. Chat with your friend by entering text using the on-screen keyboard.
3. After entering your message, tap **Send**.

Phone Settings

Basic Settings

Setting the Time and Date

1. Tap **Menu Key > Settings > Date & time** from Home Screen.
2. Clear the **Automatic** check box if you want to set time and date by yourself.
3. Configure the time and date settings:
 - Tap **Set date**. Adjust the date, and tap **Set** to save it.
 - Tap **Select time zone** and tap the area where you are.
 - Tap **Set time**. Adjust the time, and tap **Set** to save it.
 - Tap the check box behind **Use 24-hour format** to change the time format.
 - Tap **Select date format** and select the type you like.

Setting Alarms

1. Tap  > **Alarms**.
2. Tap the default alarm set to configure it or tap **Menu Key > Add alarm** to create a new alarm.
3. Select the **Alarm** check box and edit the items needed, such as Name, Time, Repeat, Snooze, Duration, Vibrate, Ringtone, Volume, Volume crescendo, and Delay.

Display Settings

By tapping **Menu Key > Settings > Sound & display** from Home Screen, you can configure the display settings, such as orientation, animation, brightness, screen timeout, and calibration.

Adjust the Screen Brightness

1. Select **Brightness** from the Display settings.
2. Adjust the brightness and tap **OK**.

Adjust the Delay before the Screen Turns off

1. Tap **Screen timeout** from the Display settings.
2. Select the time from the list.

Calibrate the Screen

Calibrating the touch screen involves tapping the center of a cross as it moves around the screen. This process ensures that when you tap the screen, the tapped item is activated.

If your phone does not accurately respond to screen taps, follow these steps to recalibrate it:

1. Tap **Calibration** from the Display settings screen.
2. Follow the on-screen instructions to complete the calibration.

Switch the Screen Orientation Automatically

You can select to switch your screen orientation to landscape or portrait automatically when rotating your phone.

Select the **Orientation** check box from the Display settings.

If you want to disable this function, clear the **Orientation** check box.

Show Animation when Opening/Closing Windows

You can select to show an animation when opening or closing windows.

1. Tap **Animation** in the Display settings.
2. Select the animation type you'd like to use.

If you want to disable this function, select **No animations**.

Sound Settings

By tapping **Menu Key > Settings > Sound & display** from Home Screen, you can configure the sound settings, such as ringtones and notifications.

Set the Ringtone

1. Tap **Phone ringtone** from Sound settings.
2. Select the ringtone you want to use from the pop-up list.

Tips:

You can also set an audio file as the ringtone while browsing the music list.

1. Open the songs list by tapping  > **Music > Songs**.
2. Hold the song you like until the shortcut menu pops up.
3. Select **Use as phone ringtone**.

Set the Default Notification Ringtone

1. Select **Notification ringtone** from the Sound & display settings.
2. Scroll the ringtone list and select one to set as the default notification ringtone.
3. Tap **OK** to save.

Switch Your Phone to Silent Mode

Select the **Silent mode** check box from the Sound & display settings.

You can also switch to silent mode by holding **Volume Key (Down)** or, when the screen is locked, by dragging the **Sound off** bar to the left, as shown below.



The silent icon  will appear in the status bar.

Switch Your Phone to Vibration Mode

Select the **Phone vibrate** check box from the Sound & display settings.

If the phone is already in silent mode, the vibration icon  will appear in the status bar.

Adjust the Ringer Volume

If you want to set the ringer volume, make sure your phone is not in silent mode.

1. Select **Ringer volume** from the Sound & display settings.
2. Adjust the ringer volume and tap **OK** to save.

Tips:

You can adjust the ringer volume quickly by pressing **Volume Keys** from any screen.

Notes:

If you want to adjust the notification volume together with ringer volume, select the **Use incoming call volume for notifications** check box.

Adjust the Media Volume

You can adjust the media volume for **Music** and **Videos** players.

1. Select **Media volume** from the Sound & display settings.
2. Adjust the media volume and tap **OK** to save.

Enable the Touch Tones

You can set your phone to play tones when touching the keys of Dialer.

Select the **Audible touch tones** check box from the Sound & display settings.

Enable the Screen Selection Tones

You can set your phone to play sound while making a selection by touching the screen.

Select the **Audible selection** check box from the Sound & display settings.

Enable the SD Card Notifications

You can set your phone to play sound for microSD card notifications.

Select the **SD card notifications** check box from the Sound & display settings.

Language Settings

You can change the system language of your phone.

Change the Language of Your Operating System

1. Tap  > **Settings** > **Language & keyboard** > **Select locale**.
2. Select a language from the locale list to set it as the system language.

Mobile Network Services

Your phone supports both GSM and WCDMA services. You can configure the network settings according to your phone service.

Enable Data Roaming

1. Tap  > **Settings > Wireless & networks > Mobile networks**.
2. Tap **Data roaming** to choose data roaming mode.

Switch the Network Mode

1. Tap  > **Settings > Wireless & networks > Mobile networks > Network Mode**.
2. Select **GSM/WCDMA auto** or **WCDMA only** to switch the network mode.

Switch the Network Operators

1. Tap  > **Settings > Wireless & networks > Mobile networks > GSM/UMTS Options > Network operators**.
2. Tap **Search networks** to set the network operator manually, or tap **Select automatically** to set the network operator automatically.

Set the Access Point Names

If you want to add a new APN, please contact your network operator to get detailed information.

1. Tap  > **Settings > Wireless & networks > Mobile networks > GSM/UMTS Options > Access Point Names**.
2. Tap **Menu Key > New APN**.
3. Set the necessary parameters (see *Getting Connected - Connecting to the Internet - GPRS/3G/EDGE - Add a new GPRS/3G/EDGE connection.*)
4. Tap **Menu Key > Save**.

Security Settings

You can protect your device and the SIM card from unauthorised use.

Protecting Your Phone with a Screen Lock

Set the Screen Unlock Pattern

You can protect your phone from unauthorised use by creating a personal screen unlock pattern.

1. Tap  > **Settings** > **Location & security** > **Set unlock pattern**.
2. Read the instructions and tap **Next**.
3. Watch the sample pattern and tap **Next**.
4. Draw your own pattern and tap **Continue**.

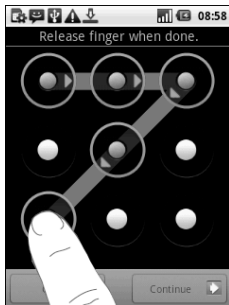

5. Draw your pattern again and tap **Confirm**.

Lock the Screen

Press **Power Key** to lock the screen.

Unlock the Screen with a Pattern

1. Press **Power Key**.
2. Draw the pattern you set to unlock the screen.

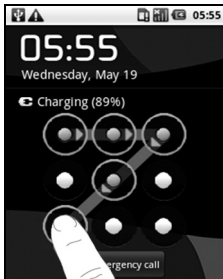

Try again if you make a mistake.

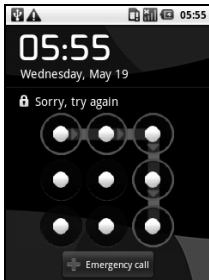

Protecting Your SIM Card with a PIN

You can set the PIN password to prevent others from using the SIM functions. The initial PIN code is provided by your service operator.

1. Tap  > **Settings** > **Location & security** > **Set up SIM/RUIM card lock**.
2. Select the **Lock SIM/RUIM card** check box.
3. Enter the PIN and tap **OK**.

Change SIM PIN

Before changing the PIN, you need to enable it.

1. Tap  > **Settings** > **Location & security** > **Set up SIM/RUIM card lock**.
2. Tap **Change SIM/RUIM PIN**.
3. Enter the old PIN and tap **OK**.

4. Enter the new PIN and tap **OK**.
5. Reenter the new PIN and tap **OK**.

Setting up Credential Storage

You can select to allow applications to access secure certificates and other credentials.

Enable Secure Credentials

1. Tap  > **Settings** > **Location & security**.
2. Tap **Set password** and create a password for the credential storage.
3. Select the **Use secure credentials** check box.

Delete Credentials

1. Tap  > **Settings** > **Location & security**.
2. Tap **Clear storage** to clear credentials.

Managing Memory

Managing Your Memory Card

View the Space Information

Tap  > **Settings** > **SD card, USB Mass Storage & phone storage**.

You can view the space information from **Total space/Available space** in the **SD card** section.

Unmount Your Memory Card

1. Tap  > **Settings** > **SD card, USB Mass Storage & phone storage**.
2. Tap **Unmount SD card**.

The  icon will appear in the status bar.

Format Your Memory Card

1. Unmount your memory card.
2. Tap **Format SD card**.
3. Tap **Format SD card** to confirm.

Managing Internal Phone Storage

View the Phone Space Information

1. Tap  > **Settings** > **SD card, USB Mass Storage & phone storage**.
2. Scroll down to view **Available space** in the **Internal phone storage** section.

Reset to Factory Settings

1. Tap  > **Settings** > **Privacy**.
2. Tap **Factory data reset**.
3. Tap **Reset phone**.

Application Settings

Managing Applications

You can view and manage the applications installed in your phone.

View the Applications Installed in Your Phone

Tap  > **Settings** > **Applications** > **Manage applications**.

Your phone will show you the applications in a list.

Allow the Installation of Non-Market Applications

1. Tap  > **Settings** > **Applications**.
2. Select the **Unknown sources** check box.

Install an Application

You can install an application from the Android Market by selecting the item you want to download and tap **Install**.

You can also install a non-Marketing application if you have allowed the installation of it. Make sure that you select an application developed for your phone and processor type before installing it.

1. Tap **Home Key** >  > **Files**, and open the folder where the application is.
2. Tap the application to start installation.
3. Read the installation instructions that come with the application and follow it to complete the setup.

Remove an Application

1. Tap  > **Settings** > **Applications** > **Manage applications**.
2. Tap on the application you want to remove.
3. Tap **Uninstall**, and tap **OK** to confirm.

If the application is downloaded from the Market, you can also go to the **Downloads** page, tap the application and then tap **Uninstall** to remove it from your phone.

Other Settings

Search Settings

You can manage search settings and history by tapping **Home Key** >  > **Settings** > **Search**.

Google Search Settings

- **Show web suggestions:** Select to show suggestions from Google as you type.
- **Search history:** Select to show personalised search history for your Google account.
- **Manage search history:** Manage your personalised search history for your Google account.

Searchable Item Settings

Tap  > **Settings** > **Search** > **Searchable items**.

When you search for an item on your phone, only the selected items will be searched.

Speech Synthesis Settings

You can set the text-to-speech options by tapping **Home Key** >  > **Settings** > **Text-to-speech**. Before you use this function, you should install the voice data.

Other Applications

Docs To Go

You can use this application suite to open word, excel, powerpoint, or PDF files.

Read the on-screen instructions for detailed information.

Note pad

Note pad is used to write text memos. Press **Menu Key** to add or delete notes. Hold an existing note to edit it, delete it or change its title.

Calculator

Tap  > Calc.

Tips:

Tap **Menu Key** > **Advanced panel** to use scientific calculation.

SIM Toolkit

SIM Toolkit appears on the screen only if your SIM card provides this function. To use the SIM card services, insert your SIM card into the phone first.

Tap **Home Key** >  > **SIM Toolkit**.

Task Manager

You can use **Task Manager** to view and stop running applications.

Timer

1. Tap  > **Timer**.
2. Tap **Start** to start timing. You can pause or resume.
3. Tap **Reset** to reset the timer.

Specifications

Dimension	Approx. 102.96 mm × 54.99 mm × 15.35 mm
Weight	Approx. 98.75g (with battery)
Bearer	GSM/WCDMA support
Main Display dimension, resolution, color space	2.8 320*240, 65K color
Back Camera	Sensor Type: CMOS
	Still Image Capture Resolution: 3.2M Pixels
Total internal memory	512MB
Free user memory	About 200MB (depending on the installed language packages)
Removable memory card	Support microSD card
Maximum capacity of memory card	8GB
Battery	Capacity: 1100mAh
	Standby time: approx. 165 hours (subject to network condition)
	Voice talk time: approx. 240 minutes (subject to network condition)
WAP browser version	WAP 2.0

Index

Access Point, 64, 96

Alarm

Setting Alarms, 91

Applications

Install an Applications, 102

Managing Applications, 101

Removing an Applications, 102

Battery

Charging the Battery, 28

Installing the SIM/microSD Card and
Battery, 25

Removing the Battery and SIM/microSD
Card, 27

Bluetooth, 34, 76, 77

Brightness

Adjust the Screen Brightness, 92

Browser

Browsing Options, 70

Download files from web pages, 73

Open a new browser window, 71

Open links in web pages, 72

Opening Browser, 67

Opening Web Pages, 67

Switch between different browser windows,
71

Using Browser, 67

Calendar, 89

Call

Call Settings, 46

Conference Call, 42

Making a Call, 41

Receiving a Call, 44

Camera, 78

Contacts, 41, 47, 48, 49, 50

Email

Composing an Email, 62

Creating an Email Account, 59

Email Settings, 63

Reply to or Forward an Email, 62

Emergency Calls, 18, 43

Extended Home Screen, 32

Favorites

- Adding a Contact to Favorites, 49
- Favourites, 67
- Gmail, 88
- Google Talk, 89, 90
- Home Screen, 31, 32
- Keyboard
 - Touch Input Settings, 54
 - Using the On-screen Keyboard, 51
- Market, 102
- Memory Card
 - Format Your Memory Card, 101
 - Installing the SIM/microSD Card and Battery, 25
 - Removing the SIM/microSD Card and Battery, 27
 - Managing Your Memory Card, 100
 - Unmount Your Memory Card, 100
 - View the Space Information, 100
- MMS
 - Composing an MMS, 56
 - MMS settings, 59
- Notification
 - Enable the SD card notifications, 95
 - Notification settings, 59, 63
 - Open the Notification Panel, 35
 - Phone Status and Notifications, 33
 - Set the default notification ringtone, 93
- Planet 3, 68
- Playlist
 - Add songs to your playlist, 83
 - Creating Playlists, 83
 - Managing Your Playlists, 83
- Ringer
 - Adjust the Ringer Volume, 94
- Ringtone
 - Setting a Song as Ringtone, 83
- Screen Unlock Pattern, 97, 98
- Skype, 69
- SMS
 - Composing an SMS, 56
 - SMS settings, 59
- Video Recorder, 79, 80
- Wi-Fi, 34, 64, 65, 66

Declaration of RoHS Compliance

To minimize the environmental impacts and take more responsibilities to the earth we live on, this document shall serve as a formal declaration that the ZTE-RACER manufactured by ZTE CORPORATION is in compliance with the Directive 2002/95/EC of the European Parliament - RoHS (Restriction of Hazardous Substances) with respect to the following substances:

1. Lead (Pb)
2. Mercury (Hg)
3. Cadmium (Cd)
4. Hexavalent Chromium (Cr (VI))
5. Polybrominated biphenyls (PBBs)
6. Polybrominated diphenyl ethers (PBDEs)

The ZTE-RACER manufactured by ZTE CORPORATION, meets the requirements of EU 2002/95/EC.

Disposal of Your Old Appliance



1. When this crossed-out wheeled bin symbol is attached to a product, it means the product is covered by the European Directive 2002/96/EC.
2. All electrical and electronic products should be disposed of separately from the municipal waste stream via designated collection facilities appointed by the government or the local authorities.
3. The correct disposal of your old appliance will help prevent potential negative consequences for the environment and human health.

For this product's Recycling Manual based on WEEE directive, please send an e-mail to weee@zte.com.cn, or visit the website below to download the document:

<http://ensupport.zte.com.cn>

EC DECLARATION OF CONFORMITY 

It is hereby declared that following designated product:

Product Type: WCDMA/GSM (GPRS) Dual-Mode Digital Mobile Phone

Model No: ZTE-RACER

Complies with the essential protection requirements of the Radio and Telecommunication Terminal Equipment Directive (EC Directive 1999/5/EC) and the Electromagnetic Compatibility Directive (2004/108/EC)

This declaration applies to all specimens manufactured identical to the samples submitted for testing/evaluation.

Assessment of compliance of the product with the requirements relating to the Radio and Telecommunication Terminal Equipment Directive (EC Directive 1999/5/EC) was performed by American TCB (Notified Body No.1588), based on the following standards:

Safety	EN60950-1:2006		
EMC	EN 301 489-1 V1.8.1; EN 301 489-17 V1.3.2; EN 301 489-24 V 1.4.1;	EN 301 489-7 V1.3.1; EN 301 489-19 V 1.2.1; EN 55013:2001 A2:2006;	EN 55020:2007;
Radio	EN 301 511 V9.0.2; EN 301 908-2 V3.2.1;	EN 301 908-1 V3.2.1; EN300 328 V1.7.1;	ETS 300 487 June 1996
Health	EN 50360:2001; EN 50332-1:2000;	EN 62209-1:2006; EN 50332-2:2003	IEC 62209-2:2008;

