

FOR CAR USE ONLY/NUR FÜR AUTOMOBIL GEBRAUCH/POUR APPLICATION AUTOMOBILE UNIQUEMENT/
PARA USO EN AUTOMÓVILES/SOLO PER L'UTILIZZO IN AUTOMOBILE/ENDAST FÖR BILBRUK



RDS MP3 CD Receiver

CDE-9848RB/CDE-9846R/ CDE-9846RM

MP3



- **OWNER'S MANUAL**
Please read before using this equipment.
- **BEDIENUNGSANLEITUNG**
Lesen Sie diese Bedienungsanleitung bitte vor Gebrauch des Gerätes.
- **MODE D'EMPLOI**
Veuillez lire avant d'utiliser cet appareil.
- **MANUAL DE OPERACIÓN**
Léalo antes de utilizar este equipo.
- **ISTRUZIONI PER L'USO**
Si prega di leggere prima di utilizzare il attrezzatura.
- **ANVÄNDARHANDLEDNING**
Innan du använder utrustningen bör du läsa igenom denna användarhandledning.

ALPINE ELECTRONICS MARKETING, INC.

1-1-8 Nishi Gotanda,
Shinagawa-ku,
Tokyo 141-0031, Japan
Phone 03-5496-8231

ALPINE ELECTRONICS OF AMERICA, INC.

19145 Gramercy Place, Torrance,
California 90501, U.S.A.
Phone 1-800-ALPINE-1 (1-800-257-4631)

ALPINE ELECTRONICS OF CANADA, INC.

777 Supertest Road, Toronto,
Ontario M3J 2M9, Canada
Phone 1-800-ALPINE-1 (1-800-257-4631)

ALPINE ELECTRONICS OF AUSTRALIA PTY. LTD.

161-165 Princes Highway, Hallam
Victoria 3803, Australia
Phone 03-8787-1200

ALPINE ELECTRONICS GmbH

Frankfurter Ring 117, 80807 München, Germany
Phone 089-32 42 640

ALPINE ELECTRONICS OF U.K. LTD.

Alpine House
Fletchamstead Highway, Coventry CV4 9TW, U.K.
Phone 0870-33 33 763

ALPINE ELECTRONICS FRANCE S.A.R.L.

(RCS PONTOISE B 338 101 280)
98, Rue de la Belle Etoile, Z.I. Paris Nord II,
B.P. 50016, 95945 Roissy Charles de Gaulle
Cedex, France
Phone 01-48638989

ALPINE ITALIA S.p.A.

Viale C. Colombo 8, 20090 Trezzano
Sul Naviglio (MI), Italy
Phone 02-484781

ALPINE ELECTRONICS DE ESPAÑA, S.A.

Portal de Gamarra 36, Pabellón, 32
01013 Vitoria (Alava)-APDO 133, Spain
Phone 945-283588

ALPINE ELECTRONICS (BENELUX) GmbH

Leuvensesteenweg 510-B6,
1930 Zaventem, Belgium
Phone 02-725-13 15

EN

DE

FR

ES

IT

SE

Contents

Operating Instructions

WARNING

WARNING	2
CAUTION	2
PRECAUTIONS	2

Getting Started

Turning Power On and Off	5
Detaching and Attaching the Front Panel	5
Initial System Start-Up	5
Adjusting Volume	5

Radio

Listening to Radio	6
Manual Storing of Station Presets	6
Automatic Memory of Station Presets	6
Tuning to Preset Stations	6

RDS

Setting RDS Reception Mode and Receiving RDS Stations	7
Recalling Preset RDS Stations	7
Receiving RDS Regional (Local) Stations	7
PI SEEK Setting	8
Receiving Traffic Information	8
PTY (Programme Type) Tuning	8
Receiving Traffic Information While Playing CD or Radio	9
Priority News	9
Displaying Radio Text	9

CD/MP3

Playback	10
Repeat Play	11
M.I.X. (Random Play)	11
Scanning Programmes	11
Searching from CD Text	11
File/Folder Name Search (concerning MP3)	11
Quick Search (CDE-9848RB only)	12
About MP3	12

Sound Setting

Adjusting Bass/Treble/Balance (Between Left and Right)/Fader (Between Front and Rear)/ Defeat	13
Setting the Bass Control	14
Setting the Treble Control	14
Turning Loudness On/Off	14

Other Functions

Displaying the Title/Text	15
Titling Discs	16
Erasing Disc Title	16

SETUP

Sound Customizing

Adjusting Source Signal Levels	17
Subwoofer On and Off	17

Visual Customizing

Dimmer Control (CDE-9848RB only)	17
Scroll Setting	17
Scroll Type Setting	17

MP3

Playing MP3 Data	17
------------------------	----

External Device

Setting the AUX Mode (CDE-9848RB only)	17
Connecting to an External Amplifier	17

Information

In Case of Difficulty	18
Specifications	19

Installation and Connections

Warning	20
Caution	20
Precautions	20
Installation	21
Connections	22

Operating Instructions

WARNING

WARNING

This symbol means important instructions. Failure to heed them can result in serious injury or death.

DO NOT OPERATE ANY FUNCTION THAT TAKES YOUR ATTENTION AWAY FROM SAFELY DRIVING YOUR VEHICLE.

Any function that requires your prolonged attention should only be performed after coming to a complete stop. Always stop the vehicle in a safe location before performing these functions. Failure to do so may result in an accident.

KEEP THE VOLUME AT A LEVEL WHERE YOU CAN STILL HEAR OUTSIDE NOISE WHILE DRIVING.

Failure to do so may result in an accident.

DO NOT DISASSEMBLE OR ALTER.

Doing so may result in an accident, fire or electric shock.

USE ONLY IN CARS WITH A 12 VOLT NEGATIVE GROUND.

(Check with your dealer if you are not sure.) Failure to do so may result in fire, etc.

KEEP SMALL OBJECTS SUCH AS BATTERIES OUT OF THE REACH OF CHILDREN.

Swallowing them may result in serious injury. If swallowed, consult a physician immediately.

USE THE CORRECT AMPERE RATING WHEN REPLACING FUSES.

Failure to do so may result in fire or electric shock.

DO NOT BLOCK VENTS OR RADIATOR PANELS.

Doing so may cause heat to build up inside and may result in fire.

USE THIS PRODUCT FOR MOBILE 12V APPLICATIONS.

Use for other than its designed application may result in fire, electric shock or other injury.

DO NOT PLACE HANDS, FINGERS OR FOREIGN OBJECTS IN INSERTION SLOTS OR GAPS.

Doing so may result in personal injury or damage to the product.

CAUTION

This symbol means important instructions. Failure to heed them can result in injury or material property damage.

HALT USE IMMEDIATELY IF A PROBLEM APPEARS.

Failure to do so may cause personal injury or damage to the product. Return it to your authorized Alpine dealer or the nearest Alpine Service Centre for repairing.

PRECAUTIONS

Product Cleaning

Use a soft dry cloth for periodic cleaning of the product. For more severe stains, please dampen the cloth with water only. Anything else has the chance of dissolving the paint or damaging the plastic.

Temperature

Be sure the temperature inside the vehicle is between +60°C (+140°F) and -10°C (+14°F) before turning your unit on.

Moisture Condensation

You may notice the CD playback sound wavering due to condensation. If this happens, remove the disc from the player and wait about an hour for the moisture to evaporate.

Damaged Disc

Do not attempt to play cracked, warped, or damaged discs. Playing a bad disc could severely damage the playback mechanism.

Maintenance

If you have problems, do not attempt to repair the unit yourself. Return it to your Alpine dealer or the nearest Alpine Service Station for servicing.

PRECAUTIONS

Never Attempt the Following

Do not grip or pull out the disc while it is being pulled back into the player by the automatic reloading mechanism.

Do not attempt to insert a disc into the unit when the unit power is off.

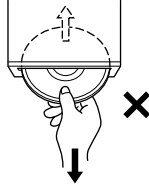

Inserting Discs

Your player accepts only one disc at a time for playback. Do not attempt to load more than one disc.

Make sure the label side is facing up when you insert the disc. "ERROR" will be displayed on your player if you insert a disc incorrectly. If "ERROR" continues to be displayed even though the disc has been inserted correctly, push the RESET switch with a pointed object such as a ballpoint pen.

Playing a disc while driving on a very bumpy road may result in skips, but this will not scratch the disc or damage the player.

New Discs

As a protective measure to prevent the CD from jamming, "ERROR" will be displayed if discs with irregular surface are inserted or inserted incorrectly. When a new disc is inserted into the player and ejected after initial loading, using your finger, feel around the inside of the centre hole and outside edge of the disc. If you feel any small bumps or irregularities, this could inhibit proper loading of the disc. To remove the bumps, rub the inside edge of the hole and outside edge of the disc with a ballpoint pen or other such instrument, then insert the disc again.

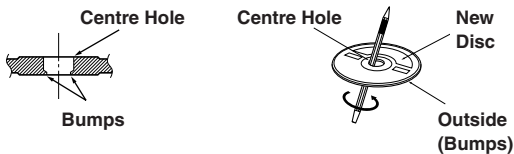

Irregular Shaped Discs

Be sure to use round shape discs only for this unit and never use any special shape discs.

Use of special shape discs may cause damage to the mechanism.

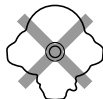

Installation Location

Make sure the CDE-9848RB/CDE-9846R/CDE-9846RM will not be installed in a location subjected to:

- Direct sun and heat
- High humidity and water
- Excessive dust
- Excessive vibrations

Correct Handling

Do not drop the disc while handling. Hold the disc so you will not leave fingerprints on the surface. Do not affix tape, paper, or gummed labels to the disc. Do not write on the disc.

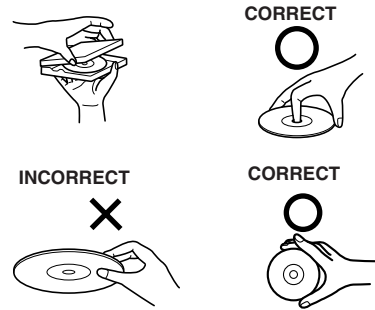

Disc Cleaning

Fingerprints, dust, or soil on the surface of the disc could cause the CD player to skip. For routine cleaning, wipe the playing surface with a clean, soft cloth from the centre of the disc to the outer edge. If the surface is heavily soiled, dampen a clean, soft cloth in a solution of mild neutral detergent before cleaning the disc.



Disc Accessories

There are various accessories available on the market for protecting the disc surface and improving sound quality. However, most of them will influence the thickness and/or diameter of the disc. Using such accessories can cause the disc to be out of standard specifications and may create operational problems. We recommend not using these accessories on discs played in Alpine CD players.

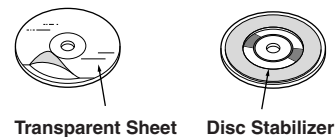

Continued

On handling Compact Discs (CD/CD-R/CD-RW)

- Do not touch the surface.
- Do not expose the disc to direct sunlight.
- Do not affix stickers or labels.
- Clean the disc when it is dusty.
- Make sure that there are no bumps around the disc.
- Do not use commercially available disc accessories.

Do not leave the disc in the car or the unit for a long time. Never expose the disc to direct sunlight. Heat and humidity may damage the CD and you may not be able to play it again.

To customers using CD-R/CD-RW

- If a CD-R/CD-RW cannot be played back, make sure the last recording session was closed (finalized).
- Finalize the CD-R/CD-RW if necessary, and attempt playback again.

About media that can be played.

Use only compact discs with the label side showing the CD logo marks below.



If you use unspecified compact discs, correct performance cannot be guaranteed.

You can play CD-Rs (CD-Recordable)/CD-RWs (CD-ReWritable) which have been recorded only on audio devices. You can also play CD-Rs/CD-RWs containing MP3 formatted audio files.

- Some of the following CDs may not play on this unit:
Flawed CDs, CDs with fingerprints, CDs exposed to extreme temperatures or sunlight (e.g., left in the car or this unit), CDs recorded under unstable conditions, CDs on which a recording failed or a re-recording was attempted, copy-protected CDs which do not conform to the audio CD industry standard.
- Use discs with MP3 files written in a format compatible with this unit. For details, see pages 12-13.

-
- *“MPEG Layer-3 audio coding technology licensed from Fraunhofer IIS and Thomson”*
 - *“Supply of this product only conveys a license for private, non-commercial use and does not convey a license nor imply any right to use this product in any commercial (i.e. revenue-generation) real time broadcasting (terrestrial, satellite, cable and/or any other media), broadcasting/streaming via internet, intranets and/or other networks or in other electronic content distribution systems, such as pay-audio or audio-on-demand applications. An independent license for such use is required. For details, please visit <http://www.mp3licensing.com>.”*

Getting Started

CDE-9848RB

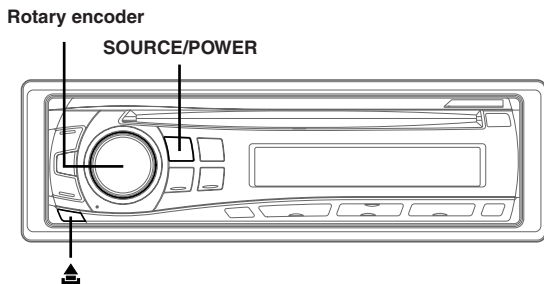

CDE-9846R/CDE-9846RM

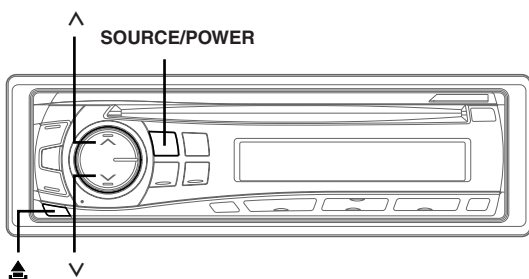

Turning Power On and Off

Press **SOURCE/POWER** to turn on the unit.

- The unit can be turned on by pressing any other button except eject .

Press and hold **SOURCE/POWER** for at least 2 seconds to turn off the unit.

- The first time power is turned on, the volume will start from level 12.

Detaching and Attaching the Front Panel

Detaching

- 1 Turn off the unit power.
- 2 Press  (Release) at the lower left side until the front panel pops out.
- 3 Grasp the left side of the front panel and pull it out.

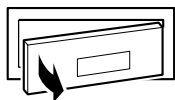

- The front panel may become hot in normal usage (especially the connector terminals on the back of the front panel). This is not a malfunction.
- To protect the front panel, place it in the supplied carrying case.

Attaching

- 1 Insert the right side of the front panel into the main unit. Align the groove on the front panel with the projections on the main unit.
- 2 Push the left side of the front panel until it locks firmly into the main unit.

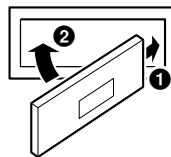

- Before attaching the front panel, make sure that there is no dirt or dust on the connector terminals and no foreign object between the front panel and the main unit.
- Attach the front panel carefully, holding the sides of the front panel to avoid pushing buttons by mistake.

Initial System Start-Up

Be sure to press the RESET switch when using the unit for the first time, after changing the car battery, etc.

- 1 Turn off the unit power.
- 2 Remove the detachable front panel.
- 3 Press **RESET** with a ballpoint pen or similar pointed object.

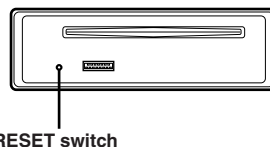

Adjusting Volume

Turn the **Rotary encoder** (CDE-9848RB only) or press **A** and **V** (CDE-9846R/CDE-9846RM only) until the desired sound is obtained.

Connectable to Steering Remote Control Interface Box

You can operate this unit from the vehicle's control unit when an Alpine Steering Remote Control Interface Box (optional) is connected. For details, contact your Alpine dealer.

Radio

CDE-9848RB

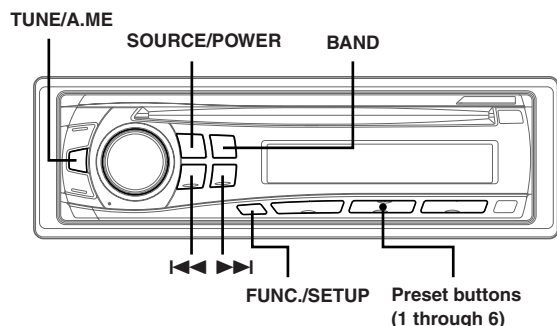

CDE-9846R/CDE-9846RM

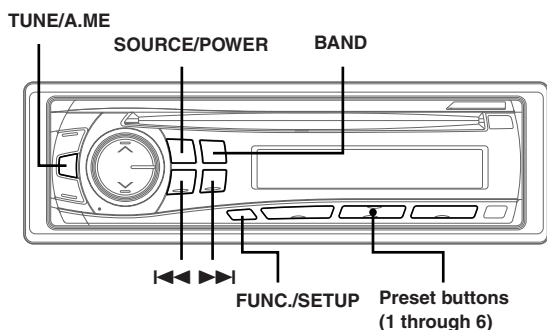

Listening to Radio

1 Press **SOURCE/POWER** until a radio frequency appears in the display.

2 Press **BAND** repeatedly until the desired radio band is displayed.

F1 (FM1) → F2 (FM2) → F3 (FM3) → MW → LW → F1 (FM1)

3 Press **TUNE/A.ME** to select the tuning mode.

DX SEEK (Distance mode) → SEEK (Local mode) → OFF (Manual mode) → DX SEEK

• The initial mode is Distance mode.

Distance mode:

Both strong and weak stations will be automatically tuned in (Automatic Seek Tuning).

Local mode:

Only strong stations will be automatically tuned in (Automatic Seek Tuning).

Manual mode:

The frequency is manually tuned in steps (Manual tuning).

4 Press **◀◀** or **▶▶** to tune in the desired station. Holding down **◀◀** or **▶▶** will change the frequency continuously.

• The **ST** indicator appears on the display when a stereo FM station is tuned in.

Manual Storing of Station Presets

1 Select the radio band and tune in a desired radio station you wish to store in the preset memory.

2 Press and hold, for at least 2 seconds, any one of the **preset buttons (1 through 6)** that you want to store the station on.

The selected station is stored.

The display shows the band, preset number and station frequency memorized.

- A total of 30 stations can be stored in the preset memory (6 stations for each band: FM1, FM2, FM3, MW and LW).
- If you store a station in a preset memory which already has a station, the current station will be cleared and replaced with the new station.
- If the "F" indicator is illuminated, turn off the indicator by pressing **FUNC./SETUP**, then you can perform the operation.

Automatic Memory of Station Presets

1 Press **BAND** repeatedly until the desired radio band is displayed.

2 Press and hold **TUNE/A.ME** for at least 2 seconds.

The frequency on the display continues to change while the automatic memory is in progress. The tuner will automatically seek and store 6 strong stations in the selected band. They will be stored into buttons 1 to 6 in order of signal strength.

When the automatic memory has been completed, the tuner goes to the station stored in preset location No. 1.

- If no stations are stored, the tuner will return to the original station you were listening to before the auto memory procedure began.

Tuning to Preset Stations

1 Press **BAND** repeatedly until the desired band is displayed.

2 Press any one of the **station preset buttons (1 through 6)** that has your desired radio station in memory.

The display shows the band, preset number and frequency of the station selected.

- If the "F" indicator is illuminated, turn off the indicator by pressing **FUNC./SETUP**, then you can perform the operation.

RDS

CDE-9848RB

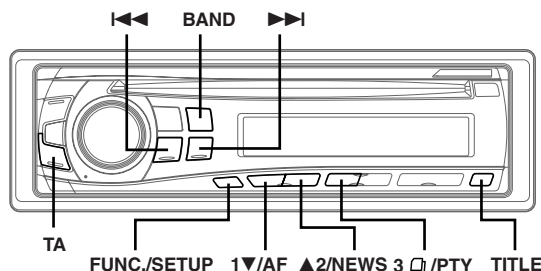

CDE-9846R/CDE-9846RM

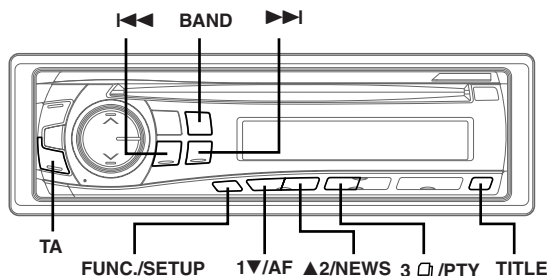

Setting RDS Reception Mode and Receiving RDS Stations

The RDS (Radio Data System) is a radio information system using the 57 kHz subcarrier of regular FM broadcast. The RDS allows you to receive a variety of information such as traffic information, station names, and to automatically re-tune to a stronger transmitter that is broadcasting the same programme.

- 1 Press **FUNC./SETUP** so that the “F” indicator lights up.
- 2 Press **1▼/AF** to activate the RDS mode.
- 3 Press **◀◀** or **▶▶** to tune in the desired RDS station.
- 4 Press **1▼/AF** again to deactivate the RDS mode.
- 5 Press **FUNC./SETUP** to activate the normal mode. The “F” indicator goes out.

The RDS digital data includes the following:

PI	Programme Identification
PS	Programme Service Name
AF	List of Alternative Frequencies
TP	Traffic Programme
TA	Traffic Announcement
PTY	Programme Type
EON	Enhanced Other Networks

Recalling Preset RDS Stations

- 1 Press **FUNC./SETUP** so that the “F” indicator lights up.
- 2 Press **1▼/AF** to activate the RDS mode.
- 3 Press **FUNC./SETUP** to activate the normal mode. The “F” indicator goes out.
- 4 Make sure that the “F” indicator light goes out, then press the preset button in which your desired RDS station is preset.

If the preset station's signal is weak, the unit automatically searches and tunes to a stronger station in the AF (Alternative Frequencies) list.

- 5 If the preset station and the stations in the AF list cannot be received:

When the PI SEEK setting is on (refer to “PI SEEK Setting” on page 8), the unit searches again for a station in the PI (Programme Identification) list.

If there are still no stations receivable in the area, the unit displays the frequency of the preset station and the preset no. disappears.

If the signal level of the Regional (Local) station being tuned becomes too weak to receive, press the same preset button to tune in a Regional station in other district.

- For presetting the RDS stations, refer to the Radio Operation section. The RDS stations can be preset in the F1, F2 and F3 bands only.

Receiving RDS Regional (Local) Stations

- 1 Press and hold **FUNC./SETUP** for at least 2 seconds to activate the setting mode.
- 2 Press **◀◀** or **▶▶** to select “REG”.
- 3 Press **BAND** to toggle the mode between “ON” and “OFF”.
- 4 Press **FUNC./SETUP** to deactivate the setting mode.

- Operate the unit while the “F” indicator lights up. If no operation is performed within 10 seconds, the “F” indicator goes out.

Receiving Traffic Information While Playing CD or Radio

- 1 Press **TA** so that the “**TA**” indicator lights up.
- 2 Press **◀◀** or **▶▶** to select a traffic information station if necessary.

When a traffic information broadcast starts, the unit automatically mutes the CD player or the regular FM broadcast.

When the traffic information broadcast finishes, the unit automatically returns to the original source play before the traffic information broadcast began.

When traffic information stations cannot be received:

In the tuner mode:

When the TP signal can no longer be received for over 1 minute, the “TA” indicator blinks.

In the CD mode:

When the TP signal can no longer be received, the traffic information station of another frequency will be selected automatically.

- *The receiver is equipped with the EON (Enhanced Other Networks) function in order to keep track of additional alternate frequencies to the AF list. The “EON” indicator lights up while an RDS EON station is being received. If the station being received does not broadcast the traffic information, the receiver automatically tunes in the related station that broadcasts the traffic information when it occurs.*

- 3 Press **TA** to deactivate the Traffic Information mode.

The “TA” indicator goes out.

Priority News

This function allows you to preset to give priority to the News programme. You will never miss the News programme as the unit automatically gives priority to the News programme whenever it begins broadcasting, and interrupts the programme you are currently listening. This feature is functional when your unit is set to a mode other than the LW and MW modes.

- 1 Press **FUNC./SETUP** so that the “**F**” indicator lights up while the unit is in Radio (FM receiving) mode.

- 2 Press **▲2/NEWS** to activate the PRIORITY NEWS mode.

The “NEWS” indicator appears in the display.

To disable the PRIORITY NEWS function, press **▲2/NEWS**.

- *In the PRIORITY NEWS function, unlike in the TA function, the volume does not increase automatically.*

- 3 Press **FUNC./SETUP** to activate the normal mode. The “F” indicator light goes out.

- *Operate the unit while the “F” indicator lights up. If no operation is performed within 10 seconds, the “F” indicator goes out.*

Displaying Radio Text

Text messages from a radio station can be displayed.

Press **TITLE** while receiving FM in the radio mode to select the Radio Text display.

The display will change every time the button is pressed.

PS (Programme Service Name) → Radio Text → FREQUENCY
→ PS (Programme Service Name)

The display shows “WAITING” for a few seconds, then starts scrolling the text message.

- *If there is no receivable text message or the unit cannot receive a text message properly, the display shows “NO TEXT.”*

CD/MP3

CDE-9848RB

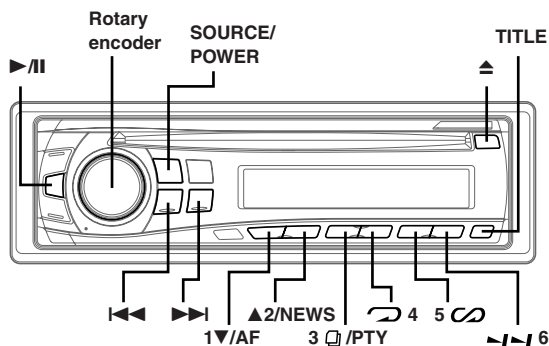

CDE-9846R/CDE-9846RM

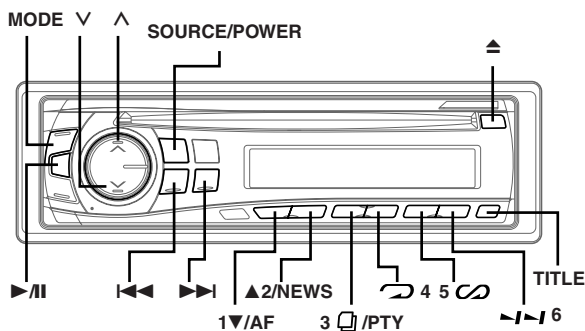

3 Press **I◀◀** or **▶▶I** to select the desired track (file).

Returning to the beginning of the current track (file):
Press **I◀◀**.

Fast backward:
Press and hold **I◀◀**.

Advancing to the beginning of the next track (file):
Press **▶▶I**.

Fast forward:
Press and hold **▶▶I**.

4 To pause playback, press **▶||**.
Pressing **▶||** again will resume playback.

5 To eject the disc, press **▲**.

- Do not remove a CD during its eject cycle. Do not load more than one disc at a time. A malfunction may result from doing either.
- If the CD does not eject, press and hold **▲** for at least 2 seconds.
- The CD-player can play discs containing audio data and MP3 data.
- "MP3" is displayed during MP3 playback.
- The track display for MP3 data playback is the file numbers recorded on the disc.

MP3 Play Display

The folder number and file number will be displayed as described below.

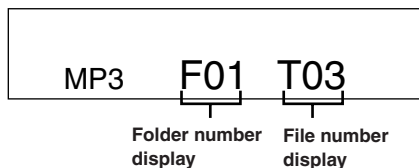

Playback

1 Insert a disc with the label side facing up.
The disc will be pulled into the unit automatically.

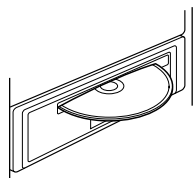

When a disc is already inserted, press **SOURCE/POWER** to switch to the CD mode.

The mode will change every time the button is pressed.

TUNER → CD → TUNER

2 While playing back MP3, press **1▼/AF** or **▲2/NEWS** to select the desired folder.

Pressing and holding **1▼/AF** or **▲2/NEWS** will change folders continuously.

- If the folder number or file number are three digits, "F" or "T" is not displayed.
- Press **TITLE** to switch the display. Please see "Displaying the Title/Text" (page 15) for information about display switching.

Repeat Play

- 1 Press **↻** 4 to play back repeatedly the track being played.

The track (file) will be played repeatedly.

Press **↻** 4 again and select OFF to deactivate repeat play.

CD mode:

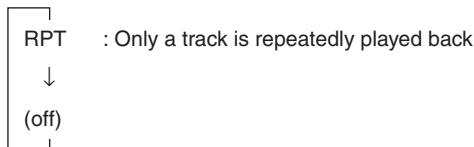

MP3 mode:

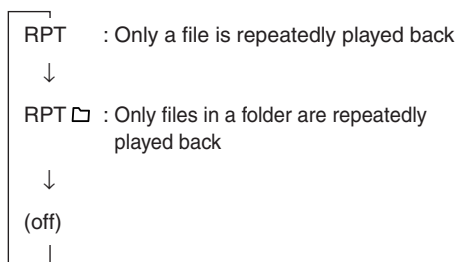

M.I.X. (Random Play)

- 1 Press **∞** 5 in the play or pause mode.

The tracks (files) on the disc will be played back in random sequence.

To cancel M.I.X. play, press **∞** 5 again.

CD mode:

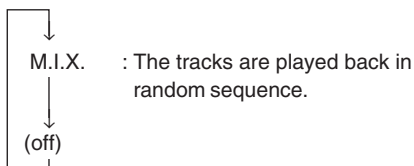

MP3 mode:

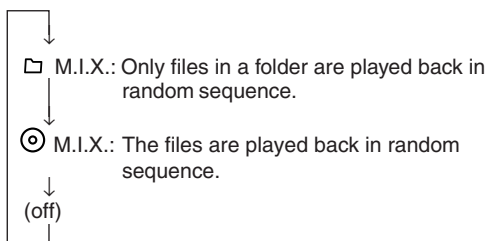

Scanning Programmes

- 1 Press **↻** 6 to activate the Scan mode in the play mode.

The first 10 seconds of each track (file) will be played back in succession.

To stop scanning, press **↻** 6 again and deactivate the Scan mode.

Searching from CD Text

Tracks can be searched and played by using the CD text on the disc. In the case of discs that do not support text, searches can be made by using the track numbers.

- 1 Press **3** /PTY in the play mode.
This will set the search mode.
- 2 Turn the **Rotary encoder (CDE-9848RB)** or press **▲** and **▼** (CDE-9846R/CDE-9846RM) to select the desired track, then press the **Rotary encoder (CDE-9848RB)** or **MODE (CDE-9846R/CDE-9846RM)**.
This will play the selected track.

- Press and hold **3** /PTY for at least 2 seconds in the search mode to cancel. Or, the search mode will be cancelled when an operation has not been performed in 10 seconds.
- CD text search cannot be made during M.I.X. play.

File/Folder Name Search (concerning MP3)

You can display and search for the folder and file name while listening to the file currently being played back.

- 1 Press **3** /PTY to select File Name Search mode or Folder Name Search mode in MP3 mode.

Folder Name Search mode

- 2 Turn the **Rotary encoder (CDE-9848RB)** or press **▲** and **▼** (CDE-9846R/CDE-9846RM) within 10 seconds to select the desired folder.
- 3 Press the **Rotary encoder (CDE-9848RB)** or **MODE (CDE-9846R/CDE-9846RM)** to play back the first file in the selected folder.

- Search mode is cancelled by pressing and holding **3** /PTY for at least 2 seconds in Folder Name Search mode.
- While in Folder Name Search mode, press **3** /PTY to switch to File Name Search mode.
- "NO FILE" is displayed for 2 seconds if the folder that is selected by the Folder Name Search mode contains no files.
- "ROOT" is displayed for a folder that does not have a folder name.
- Folder Name search cannot be made during M.I.X. play.

Continued

File Name Search mode

- 2 Press **1**▼/AF or **▲**2/NEWS to select another Folder.
- 3 Select the desired file by turning the **Rotary encoder (CDE-9848RB)** or press **▲** and **▼** (CDE-9846R/CDE-9846RM) within 10 seconds.
- 4 Press the **Rotary encoder (CDE-9848RB)** or **MODE (CDE-9846R/CDE-9846RM)** to play back the selected file.

- File Name Search mode is cancelled by pressing and holding **3** □/PTY for at least 2 seconds.
- While in File Name Search mode, press **3** □/PTY to switch to Folder Name Search mode.
- File Name search cannot be made during M.I.X. play.

Quick Search (CDE-9848RB only)

You can search for tracks (files).

- 1 Press and hold **3** □/PTY for at least 2 seconds in the CD/MP3 mode to activate Quick Search mode.
 - 2 Turn the **Rotary encoder** within 10 seconds to select a desired track (file).
The selected track is played back immediately.
- Search mode is cancelled by pressing and holding **3** □/PTY for at least 2 seconds in Quick Search mode.

About MP3

CAUTION

Except for private use, duplicating audio data (including MP3 data) or distributing, transferring, or copying it, whether for free or for a fee, without permission of the copyright holder is strictly prohibited by the Copyright Act and by international treaty.

What is MP3?

MP3, whose official name is "MPEG-1 Audio Layer 3," is a compression standard prescribed by the ISO, the International Standardization Organization and MPEG which is a joint activity institution of the IEC.

MP3 files contain compressed audio data. MP3 encoding is capable of compressing audio data at extremely high ratios, reducing the size of music files to as much as one-tenth their original size. This is achieved while still maintaining near CD quality. The MP3 format realizes such high compression ratios by eliminating the sounds that are either inaudible to the human ear or masked by other sounds.

Method for creating MP3 files

Audio data is compressed by using MP3 specified software. For details on creating MP3 files, refer to the user's manual for that software.

MP3 files that can be played back by this device have the file extension "mp3". Files with no extension cannot be played back.

Supported playback sampling rates and bit rates

MP3

Sampling rates: 48 kHz, 44.1 kHz, 32 kHz, 24 kHz, 22.05 kHz, 16 kHz, 12 kHz, 11.025 kHz, 8 kHz
Bit rates: 8 - 320 kbps

Note that for sampling rates, this device's frame display (page 15) may not display correctly.
This device may not play back correctly depending on sampling rates.

ID3 tags

This device supports ID3 tag v1 and v2.
If tag data is in an MP3 file, this device can display the title (track title), artist name, and album name ID3 tag data.

This device can only display single-byte alphanumeric characters (up to 30 for ID3 tags) and the underscore. For non-supported characters, "NO SUPRT" is displayed.
The tag information may not be correctly displayed, depending on the contents.

Producing MP3 discs

MP3 files are prepared, then written to a CD-R or CD-RW using CD-R writing software. A disc can hold up to 510 files/folders (including Root Folders). However, the maximum number of folders is 255.

Media supported

The media that this device can play back are CD-ROMs, CD-Rs, and CD-RWs.

Corresponding File Systems

This device supports discs formatted with ISO9660 Level 1 or Level 2.

Under the ISO9660 standard, there are some restrictions to remember.

The maximum nested folder depth is 8 (including the root directory). The number of characters for a folder/file name is limited.

Valid characters for folder/file names are letters A-Z (all caps), numbers 0-9, and '_' (underscore).

This device also can play back discs in Joliet, Romeo, etc., and other standards that conform to ISO9660. However, sometimes the file names, folder names, etc., are not displayed correctly.

Formats supported

This device supports CD-ROM XA, Mixed Mode CD, Enhanced CD (CD-Extra) and Multi-Session.

This device cannot correctly play back discs recorded with Track At Once or packet writing.

Order of files

The unit plays the files in the order that the writing software writes them. Therefore, the playing order may not be the same as the order you input. The playback order of the folders and files is as follows. However, the folder and file playback order differs from the folder and file number indicated on the display.

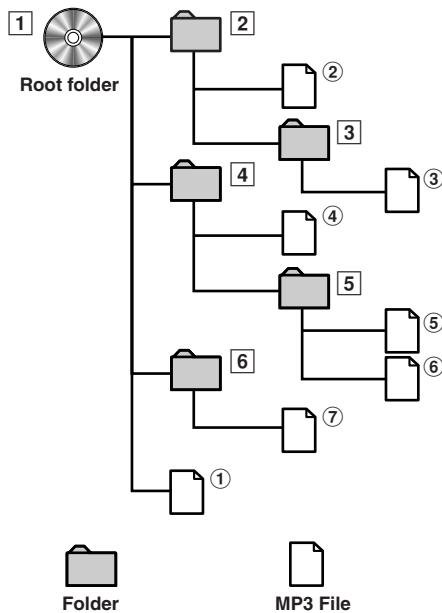

Terminology

Bit rate

This is the "sound" compression rate specified for encoding. The higher the bit rate, the higher the sound quality, but also the larger the files.

Sampling rate

This value shows how many times per second the data is sampled (recorded). For example, music CDs use a sampling rate of 44.1 kHz, so the sound is sampled (recorded) 44,100 times per second. The higher the sampling rate, the higher the sound quality, but also the larger the volume of data.

Encoding

Converting music CDs, WAVE (AIFF) files, and other sound files into the specified audio compression format.

Tag

Song information such as track titles, artist names, album names, etc., written into MP3 files.

MP3: ID3 tag

Root folder

The root folder is found at the top of the file system. The root folder contains all folders and files.

Sound Setting

CDE-9848RB

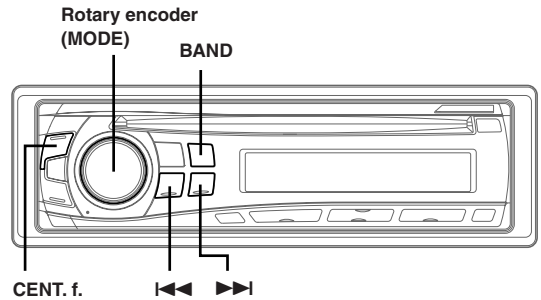

CDE-9846R/CDE-9846RM

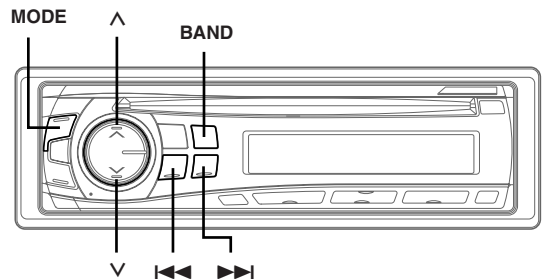

Adjusting Bass/Treble/Balance (Between Left and Right)/Fader (Between Front and Rear)/Defeat

1 Press Rotary encoder (MODE) (CDE-9848RB) or MODE (CDE-9846R/CDE-9846RM) repeatedly to choose the desired mode.

Each press changes the mode as follows:

BASS LV → TRE LV → SUBW*¹ → BALANCE → FADER → DEFT → VOLUME → BASS LV

Bass level: -7 ~ +10

Treble level: -7 ~ +7

Subwoofer : 0 ~ +15

Balance : L15 ~ R15

Fader : R15 ~ F15

Defeat : ON/OFF

Volume : 0 ~ 35

- If the **Rotary encoder (MODE)** or **MODE** is not pressed within 5 seconds after selecting the **BASS LV**, **TRE LV**, **BALANCE**, **FADER**, **DEFT** or **SUBW** mode, the unit automatically returns to normal mode.

CDE-9848RB:

- If the **Rotary encoder (MODE)** is not pressed within 5 seconds after selecting the **BASS LV** or **TRE LV** mode, the unit automatically returns to normal mode.

CDE-9846R/CDE-9846RM:

- If the **MODE** is not pressed within 15 seconds after selecting the **BASS LV** or **TRE LV** mode, the unit automatically returns to normal mode.

*¹ When the subwoofer mode is set to OFF, its level cannot be adjusted.

Continued

2 Turn the **Rotary encoder (MODE)** (CDE-9848RB) or press **Λ** and **∇** (CDE-9846R/CDE-9846RM) until the desired sound is obtained in each mode.

By setting Defeat ON, previously adjusted settings of BASS LV and TRE LV will return to the factory defaults.

Setting the Bass Control

You can change the bass frequency emphasis to create your own tonal preference.

1 CDE-9848RB: Press **CENT. f.** to select the Bass Control mode.

BASS LV → TRE LV → normal mode → BASS LV

CDE-9846R/CDE-9846RM:

Press **MODE** to select the Bass Control mode.

BASS LV → TRE LV → SUBW → BALANCE → FADER → DEFT → VOLUME → BASS LV

2-1 Setting the bass centre frequency: Press **◀◀** or **▶▶** to select the desired bass centre frequency.

60Hz ↔ 80Hz ↔ 100Hz ↔ 120Hz ↔ 60Hz

The displayed bass frequency is emphasized.

2-2 Setting the bass band width (Q-Factor): Press **BAND** to select the desired bass band width.

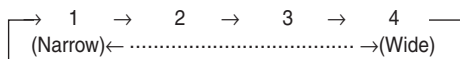

Change the boosted bass band width to wide or narrow. A wide setting will boost a wide range of frequencies above and below the centre frequency. A narrower setting will boost only frequencies near the centre frequency.

2-3^{*2} Setting the bass level: Turn the **Rotary encoder (CDE-9848RB)** or press **Λ** and **∇** (CDE-9846R/CDE-9846RM) to select the desired bass level (-7~+10).

You can emphasize or weaken the bass level.

- If no operation is performed within 15 seconds, the bass control setting will be turned off automatically.
- The bass level settings will be individually memorized for each source (FM, MW (LW), CD, etc.) until the setting is changed. The bass frequency and bass band width settings adjusted for one source are effective for all other sources (FM, MW (LW), CD etc.).
- This function is inoperable when DEFT is set to ON.

^{*2} CDE-9848RB:

The adjustment can also be made by pressing the **Rotary encoder (MODE)**. Refer to "Adjusting Bass/Treble/Balance (Between Left and Right)/Fader (Between Front and Rear)/Defeat" (page 13).

Setting the Treble Control

You can change the Treble Frequency emphasis to create your own tonal preference.

1 CDE-9848RB: Press **CENT. f.** to select the Treble Control mode.

BASS LV → TRE LV → normal mode → BASS LV

CDE-9846R/CDE-9846RM:

Press **MODE** to select the Treble Control mode.

BASS LV → TRE LV → SUBW → BALANCE → FADER → DEFT → VOLUME → BASS LV

2-1 Setting the treble Centre frequency: Press **◀◀** or **▶▶** to select the desired treble centre frequency.

7.5kHz ↔ 10.0kHz ↔ 12.5kHz ↔ 15.0kHz ↔ 7.5kHz

The displayed Treble frequency is emphasized.

2-2^{*2} Setting the treble level: Turn the **Rotary encoder (CDE-9848RB)** or press **Λ** and **∇** (CDE-9846R/CDE-9846RM) to select the desired treble level (-7~+7).

You can emphasize the treble level.

- If no operation is performed within 15 seconds, the treble control setting will be turned off automatically.
- The treble level settings will be individually memorized for each source (FM, MW (LW), CD, etc.) until the setting is changed. The Treble frequency settings adjusted for one source are effective for all other sources (FM, MW (LW), CD, etc.).
- This function is inoperable when DEFT is set to ON.

^{*2} CDE-9848RB:

The adjustment can also be made by pressing the **Rotary encoder (MODE)**. Refer to "Adjusting Bass/Treble/Balance (Between Left and Right)/Fader (Between Front and Rear)/Defeat" (page 13).

Turning Loudness On/Off

Loudness introduces a special low- and high-frequency emphasis at low listening levels. This compensates for the ear's decreased sensitivity to bass and treble sound.

Press and hold **Rotary encoder (MODE)** (CDE-9848RB) or **MODE** (CDE-9846R/CDE-9846RM) for at least 2 seconds to activate or deactivate the loudness mode.

The display shows "LOUD ON" and the "LD" indicator blinks when the loudness mode is activated.

Other Functions

CDE-9848RB

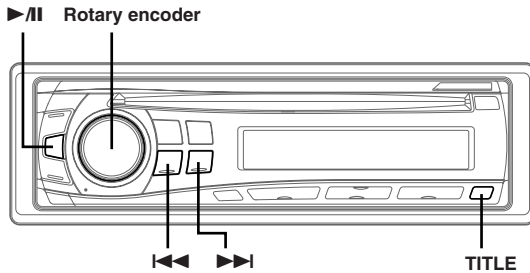

CDE-9846R/CDE-9846RM

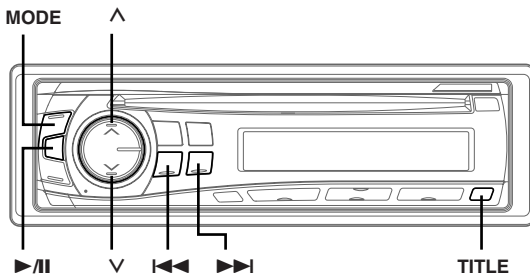

Displaying the Title/Text

It is possible to display the CD title if the title has been previously inputted (“Titling Discs” page 16). Text information, such as the disc name and the track name, will be displayed if playing a CD text compatible disc. It is also possible to display the folder name, the file name, and the tag, etc., while playing MP3 files.

Press **TITLE**.

The display will change every time the button is pressed.

The display in Radio mode:

PS (Programme Service Name) → Radio Text →
FREQUENCY → PS (Programme Service Name)

The display in CD mode:

TRACK NO./ELAPSED TIME → TEXT (DISC NAME)*¹ → TEXT
(TRACK NAME)*¹ → TITLE → TRACK NO./ELAPSED TIME

The display in MP3 mode:

FILE NO./ELAPSED TIME → FOLDER NO./FILE NO. →
FOLDER NAME*² → FILE NAME → ARTIST NAME*³ →
ALBUM NAME*³ → TRACK NAME*³ → FRAME*⁴ → FILE NO./
ELAPSED TIME

- *¹ Displayed during playback of a disc with CD Text.
“NO TEXT” will be displayed when the CD contains no Text data.
- *² “ROOT ” is displayed for a folder that does not have a folder name.
- *³ ID3 tag
If an MP3 file contains ID3 tag information, the ID3 tag information is displayed (track name, artist name, and album name). All other tag data is ignored.
“NO DATA” will be displayed when an MP3 file contains no ID3 tag information.
- *⁴ The recording sampling rate and bit rate of the MP3 file are displayed.

About the indicator display

When displaying Title/Text, the following indicators are lit according to the mode.



Indicator/ Mode	CD Mode	MP3 Mode
	While displaying Title	—
	—	While displaying Folder Name
	—	While displaying File Name
	—	While displaying Artist Name* ¹
	While displaying Text (Disc Name)	While displaying Album Name* ¹
	While displaying Text (Track Name)	While displaying Track Name* ¹

*Tag information

About “Title” and “Text”

Title:

With this device, it is possible to input the CD name (page 16). This inputted name is referred to as a “title.”
You cannot input or display titles on radio station or MP3 discs.

Text:

Text compatible CDs contain text information such as the disc name and track name. Such text information is referred to as “text.”

- Some characters may not be displayed correctly with this device, depending on the character type.
- When the Scroll Setting (page 17) is set to “MANU,” press and hold **TITLE** for at least 2 seconds to scroll the Text information only once (TEXT DISPLAY, FOLDER NAME DISPLAY, FILE NAME DISPLAY or TAG DISPLAY mode).
- “NO SUPRT” is displayed when the desired text information cannot be displayed on this unit.
- If the title was not previously input, “NO TITLE” is displayed.
- The text or tag information may not be correctly displayed, depending on the contents.

Titling Discs

It is possible to title your favourite CDs.
You cannot input titles on radio station or MP3 discs.

- 1 Press TITLE and select the Title Display.**
For details, see "Displaying the Title/Text" (page 15).
- 2 Press and hold TITLE for at least 2 seconds. The first character will blink.**
- 3 Turn the Rotary encoder (CDE-9848RB) or press \wedge and \vee (CDE-9846R/CDE-9846RM) to select the desired letter/numeral/symbol available for naming.**
- 4 Press Rotary encoder (CDE-9848RB) or MODE (CDE-9846R/CDE-9846RM) to store the first character.**
The first character will stop blinking and the display will automatically advance to the next character. When that character begins to blink, you may choose the next letter or symbol of your title.
- 5 Repeat steps 3 and 4 above to complete the titling.**
Pressing the Rotary encoder (CDE-9848RB) or MODE (CDE-9846R/CDE-9846RM) after entering the 8th character automatically stores the title into memory.

When entering a title of less than 8 characters (for example, 3 character title):

After entering 3 characters, the 4th character space will be blinking. Go to step 6 to complete the title.

- 6 Press TITLE to record the title.**

- If you cancel while entering a title, selected characters are not written.
- You can enter 18 CD titles on this unit. If you try to store beyond the limit, the display will show "FULL DATA." At this point, no more titles can be stored. To input a new title, one of the previously inputted titles must first be deleted.
- When you want to erase a title, enter the " " symbol into all spaces.
- The operations described in steps 3 to 5 must be made within 10 seconds. The input mode will be cancelled if no action is taken for over 10 seconds.

Erasing Disc Title

- 1 Press TITLE to select the Title Display. Then, press again and hold for at least 2 seconds.**
- 2 Press and hold \blacktriangleright /II for at least 2 seconds.**
The title in the display will blink.
- 3 Press \blacktriangleleft or \blacktriangleright repeatedly until the title you want to erase is displayed.**
- 4 Press and hold \blacktriangleright /II for at least 2 seconds to erase the title displayed.**
- 5 Press TITLE to cancel the title erasing mode.**

- You cannot erase CD-TEXT.
- "NO DATA" is displayed for 2 seconds if the title is not input in step 2, or if the title is erased in step 4.

SETUP

You can flexibly customize the unit to suit your own preferences and usage. From the SETUP menu, choose from Sound Customizing, Visual Customizing, etc., to make your desired settings.

CDE-9848RB

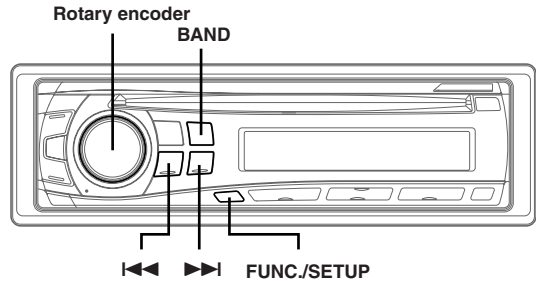

CDE-9846R/CDE-9846RM

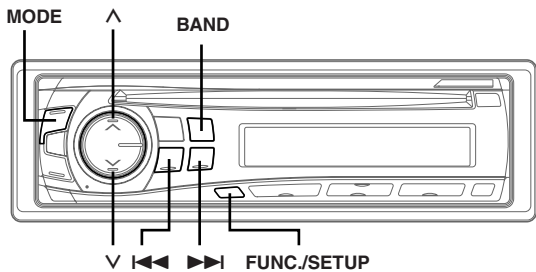

A typical SETUP procedure is shown in steps 1 to 4 as follows. See below for further information about each SETUP menu.

- 1 Press and hold FUNC./SETUP for at least 2 seconds.**
SETUP mode is activated.
- 2 Press \blacktriangleleft or \blacktriangleright to select the desired SETUP menu.**
(e.g. Select SUBW)

FM-LV \leftrightarrow REG^{*1} \leftrightarrow PISK^{*2} \leftrightarrow DIM^{*3} \leftrightarrow SUBW \leftrightarrow
CD-DA/CDDA/MP3 \leftrightarrow TYPE1/TYP2 \leftrightarrow SCR \leftrightarrow AUX^{*3} \leftrightarrow
(AUX NAME)^{*3} \leftrightarrow PWR \leftrightarrow FM-LV
- 3 Press BAND to change the setting.**
(e.g. Select SUBW ON or SUBW OFF.)
- 4 Press FUNC./SETUP again.**
The display returns to normal mode.

^{*1} Refer to "Receiving RDS Regional (Local) Stations" (page 7)

^{*2} Refer to "PI SEEK Setting" (page 8)

^{*3} CDE-9848RB only

^{*4} Displayed only when AUX is ON

Sound Customizing

Adjusting Source Signal Levels

FM-LV HI (Initial setting) / FM-LV LO

If the difference in volume level between the CD player and FM radio is too great, adjust the FM signal level.

Subwoofer On and Off

SUBW ON (Initial setting) / SUBW OFF

When the subwoofer is on, perform the steps below to adjust the subwoofer output level.

- 1 Press the **Rotary encoder** (CDE-9848RB) or **MODE** (CDE-9846R/CDE-9846RM) repeatedly to select the SUBW mode.

BASS LV → TRE LV → SUBW* → BALANCE → FADER → DEFT → VOLUME → BASS LV
- 2 To adjust the level, turn the **Rotary encoder** (CDE-9848RB) or press **▲** and **▼** (CDE-9846R/CDE-9846RM).

* When the subwoofer mode is set to OFF, its level cannot be adjusted.

Visual Customizing

Dimmer Control (CDE-9848RB only)

DIM AUTO (Initial setting) / DIM MANU

Set the DIM control to AUTO / decrease the illumination brightness of the unit with the head lights of the vehicle ON. This mode is useful if you feel the unit's button lighting is too bright at night.

- If your vehicle should have a dimmer control for the dashboard lights, never connect the DIMMER cable (orange) of the radio to this dimmer control.

Scroll Setting

SCR AUTO / SCR MANU (Initial setting)

This CD player can scroll the disc and track names recorded on CD-TEXT discs, as well as the text information of MP3 files, folder names, and tags.

SCR AUTO : The CD text information, the text information of folder and file names, and the tags are scrolled automatically.

SCR MANU : The display is scrolled only when a disc is loaded or when a track is changed, etc.

- The unit scrolls CD text names, folder names, file names or tag display. The disc titles input manually (page 16) cannot be scrolled.

Scroll Type Setting

TYPE1 (Initial setting) / TYPE2

Choose from two scrolling methods.

Select the type you prefer.

TYPE1 : The characters scroll sequentially, appearing from the right side of the display.

TYPE2 : The characters are displayed one by one, and disappear one by one from the left side of the display after the screen is filled up with the characters.

MP3

Playing MP3 Data

CD-DA (Initial setting) / CDDA/MP3

This product can playback CDs containing both CD and MP3 data. However, in some situations (some enhanced CDs), playback may be difficult. For these special cases, you can select playback of CD data only. When a disc contains both CD or the MP3 data, playback starts from the CD data portion of the disc.

CD-DA : Only CD data can be played back.

CDDA/MP3 : Both CD data and MP3 file tracks can be played back.

- Perform this setting before inserting a disc. If a disc has already been inserted, perform the setting after you remove the disc.

External Device

Setting the AUX Mode (CDE-9848RB only)

AUX ON / AUX OFF (Initial setting)

You can input the audio of a connected external device (such as a portable player) to the AUX input terminal of this unit, using a commercially-available RCA cable.

You can change the AUX name display when AUX ON is set. Select the AUX name by pressing **◀◀** or **▶▶**.

Connecting to an External Amplifier

PWR ON (Initial setting) / PWR OFF

When an external amplifier is connected, sound quality can be improved by stopping the power supply of the built-in amplifier.

PWR OFF : Use this mode when the front pre-amplifier of the unit is used to drive an external amplifier connected to the speakers. In this setting, the head unit's internal amplifier has no output to drive speakers.

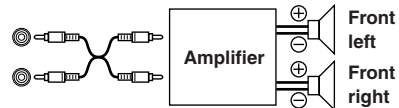

PWR ON : The speakers are driven by the built-in amplifier.

Speakers

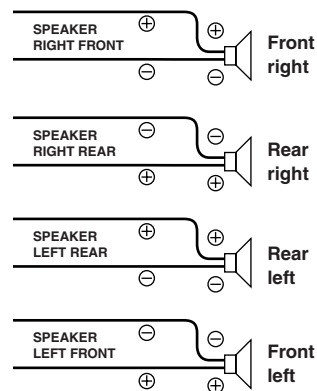

- No sound is produced by the system when the power output is set to OFF.

Information

In Case of Difficulty

If you encounter a problem, please turn the power off, then on again. If the unit is still not functioning normally, please review the items in the following checklist. This guide will help you isolate the problem if the unit is at fault. Otherwise, make sure the rest of your system is properly connected or consult your authorized Alpine dealer.

Basic

No function or display.

- Vehicle's ignition is off.
 - If connected following instructions, the unit will not operate with the vehicle's ignition off.
- Improper power lead (Red) and battery lead (Yellow) connections.
 - Check power lead and battery lead connections.
- Blown fuse.
 - Check the fuse of the unit; replace with the proper value if necessary.
- Internal micro-computer malfunctioned due to interference noise etc.
 - Press the RESET switch with a ballpoint pen or other pointed article.

Radio

Unable to receive stations.

- No antenna or open connection in cable.
 - Make sure the antenna is properly connected; replace the antenna or cable if necessary.

Unable to tune stations in the seek mode.

- You are in a weak signal area.
 - Make sure the tuner is in the DX mode.
- If the area you are in is a primary signal area, the antenna may not be grounded and connected properly.
 - Check your antenna connections; make sure the antenna is properly grounded at its mounting location.
- The antenna may not be the proper length.
 - Make sure the antenna is fully extended; if broken, replace the antenna with a new one.

Broadcast is noisy.

- The antenna is not the proper length.
 - Extend the antenna fully; replace it if it is broken.
- The antenna is poorly grounded.
 - Make sure the antenna is grounded properly at its mounting location.

CD

CD Player not functioning.

- Out of operating temperature range +50°C (+120°F) for CD.
 - Allow the vehicle's interior (or trunk) temperature to cool.

CD playback sound is wavering.

- Moisture condensation in the CD Module.
 - Allow enough time for the condensation to evaporate (about 1 hour).

CD insertion not possible.

- A CD is already in the CD player.
 - Eject the CD and remove it.
- The CD is being improperly inserted.
 - Make sure the CD is being inserted following instructions in the CD Player Operation section.

Unable to fast forward or backward the CD.

- The CD has been damaged.
 - Eject the CD and discard it; using a damaged CD in your unit can cause damage to the mechanism.

CD playback sound skips due to vibration.

- Improper mounting of the unit.
 - Securely re-mount the unit.
- The disc is very dirty.
 - Clean the disc.
- The disc has scratches.
 - Change the disc.
- The pick-up lens is dirty.
 - Do not use a commercial available lens cleaner disc. Consult your nearest Alpine dealer.

CD playback sound skips without vibration.

- The disc is dirty or scratched.
 - Clean the disc; damaged disc should be replaced.

Error displays (built-in CD player only)

- Mechanical error
 - Press ▲. After the error indication disappears, insert the disc again. If the above-mentioned solution does not solve the problem, consult your nearest Alpine dealer.

CD-R/CD-RW playback not possible

- Close session (finalization) has not been performed.
 - Perform finalization and attempt playback again.

MP3

MP3 is not played back.

- Writing error occurred. The CD format is not compatible.
 - Make sure the CD has been written in a supported format. Refer to "About MP3" (pages 12-13), then rewrite in the format supported by this device.

Audio

The sound is not output from the speakers.

- Unit has no output signal of the internal amplifier.
 - PWR is switched to "ON" (page 17).

Indication for CD Player

HI TEMP

- Protective circuit is activated due to high temperature.
 - The indicator will disappear when the temperature returns to normal operating range.

NO DISC

- No CD is inserted.
 - Insert a CD.
- Although a disc is inserted, "NO DISC" is displayed and the unit does not start to play or eject the disc.
 - Remove the disc by following these steps:
 - Press the **▲** button again for at least 2 seconds.
 - If the disc still does not eject, consult your Alpine dealer.

ERROR

- Mechanism error.
 - 1) Press the **▲** button and eject the CD.
 - If not ejecting, consult your Alpine dealer.
 - 2) When the error indication remains after ejecting, press the **▲** button again.
 - If the error indication still does not turn off after pressing the **▲** button for a few times, consult your Alpine dealer.
- When "ERROR" is displayed:
 - If that the disc cannot be ejected by pressing **▲**, press the RESET switch (refer to page 5) and press **▲** again.
 - If the disc still cannot be ejected, consult your Alpine dealer.
- A disc that is not compatible with the unit is inserted.
 - Insert a disc that is compatible with the unit.

UNSUPPORT

- The disc is not written in a MP3 supported format.
 - Use a disc written at the MP3 supported format.

Specifications

FM TUNER SECTION

Tuning Range	87.5 – 108.0 MHz
Mono Usable Sensitivity	0.7 μ V
Alternate Channel Selectivity	80 dB
Signal-to-Noise Ratio	65 dB
Stereo Separation	35 dB
Capture Ratio	2.0 dB

MW TUNER SECTION

Tuning Range	531 – 1,602 kHz
Sensitivity (IEC Standard)	25.1 μ V/28 dB

LW TUNER SECTION

Tuning Range	153 – 281 kHz
Sensitivity (IEC Standard)	31.6 μ V/30 dB

CD SECTION

Frequency Response	5 – 20,000 Hz (\pm 1 dB)
Wow & Flutter (% WRMS)	Below measurable limits
Total Harmonic Distortion	0.008% (at 1 kHz)
Dynamic Range	95 dB (at 1 kHz)
Signal-to-Noise Ratio	105 dB
Channel Separation	85 dB (at 1 kHz)

PICKUP

Wave length	795 nm
Laser power	CLASS I

GENERAL

Power Requirement	14.4 V DC (11–16 V allowable)
Maximum Power Output	45 W \times 4
Maximum Pre-Output Voltage	2 V/10k ohms
Bass	+20/-14 dB at 60 Hz
Treble	\pm 14 dB at 10 kHz
Weight	1.6 kg (3 lbs. 8 oz)

CHASSIS SIZE

Width	178 mm (7")
Height	50 mm (2")
Depth	160 mm (6-1/4")

NOSEPIECE SIZE

Width	170 mm (6-3/4")
Height	46 mm (1-13/16")
Depth	18 mm (11/16")

- Due to continuous product improvement, specifications and design are subject to change without notice.

CAUTION

**CLASS 1
LASER PRODUCT**

(Bottom side of player)

Installation and Connections

Before installing or connecting the unit, please read the following and pages 2 to 4 of this manual thoroughly for proper use.

Warning

MAKE THE CORRECT CONNECTIONS.

Failure to make the proper connections may result in fire or product damage.

USE ONLY IN CARS WITH A 12 VOLT NEGATIVE GROUND.

(Check with your dealer if you are not sure.) Failure to do so may result in fire, etc.

BEFORE WIRING, DISCONNECT THE CABLE FROM THE NEGATIVE BATTERY TERMINAL.

Failure to do so may result in electric shock or injury due to electrical shorts.

DO NOT SPLICE INTO ELECTRICAL CABLES.

Never cut away cable insulation to supply power to other equipment. Doing so will exceed the current carrying capacity of the wire and result in fire or electric shock.

DO NOT DAMAGE PIPE OR WIRING WHEN DRILLING HOLES.

When drilling holes in the chassis for installation, take precautions so as not to contact, damage or obstruct pipes, fuel lines, tanks or electrical wiring. Failure to take such precautions may result in fire.

DO NOT USE BOLTS OR NUTS IN THE BRAKE OR STEERING SYSTEMS TO MAKE GROUND CONNECTIONS.

Bolts or nuts used for the brake or steering systems (or any other safety-related system), or tanks should NEVER be used for installations or ground connections. Using such parts could disable control of the vehicle and cause fire etc.

KEEP SMALL OBJECTS SUCH AS BATTERIES OUT OF THE REACH OF CHILDREN.

Swallowing them may result in serious injury. If swallowed, consult a physician immediately.

DO NOT INSTALL IN LOCATIONS WHICH MIGHT HINDER VEHICLE OPERATION, SUCH AS THE STEERING WHEEL OR GEARSHIFT.

Doing so may obstruct forward vision or hamper movement etc. and results in serious accident.

Caution

HAVE THE WIRING AND INSTALLATION DONE BY EXPERTS.

The wiring and installation of this unit requires special technical skill and experience. To ensure safety, always contact the dealer where you purchased this product to have the work done.

USE SPECIFIED ACCESSORY PARTS AND INSTALL THEM SECURELY.

Be sure to use only the specified accessory parts. Use of other than designated parts may damage this unit internally or may not securely install the unit in place. This may cause parts to become loose resulting in hazards or product failure.

ARRANGE THE WIRING SO IT IS NOT CRIMPED OR PINCHED BY A SHARP METAL EDGE.

Route the cables and wiring away from moving parts (like the seat rails) or sharp or pointed edges. This will prevent crimping and damage to the wiring. If wiring passes through a hole in metal, use a rubber grommet to prevent the wire's insulation from being cut by the metal edge of the hole.

DO NOT INSTALL IN LOCATIONS WITH HIGH MOISTURE OR DUST.

Avoid installing the unit in locations with high incidence of moisture or dust. Moisture or dust that penetrates into this unit may result in product failure.

Precautions

- Be sure to disconnect the cable from the (-) battery post before installing your CDE-9848RB/CDE-9846R/CDE-9846RM. This will reduce any chance of damage to the unit in case of a short-circuit.
- Be sure to connect the colour coded leads according to the diagram. Incorrect connections may cause the unit to malfunction or damage to the vehicle's electrical system.
- When making connections to the vehicle's electrical system, be aware of the factory installed components (e.g. on-board computer). Do not tap into these leads to provide power for this unit. When connecting the CDE-9848RB/CDE-9846R/CDE-9846RM to the fuse box, make sure the fuse for the intended circuit of the CDE-9848RB/CDE-9846R/CDE-9846RM has the appropriate amperage. Failure to do so may result in damage to the unit and/or the vehicle. When in doubt, consult your Alpine dealer.
- The CDE-9848RB/CDE-9846R/CDE-9846RM uses female RCA-type jacks for connection to other units (e.g. amplifier) having RCA connectors. You may need an adaptor to connect other units. If so, please contact your authorized Alpine dealer for assistance.
- Be sure to connect the speaker (-) leads to the speaker (-) terminal. Never connect left and right channel speaker cables to each other or to the vehicle body.

IMPORTANT

Please record the serial number of your unit in the space provided below and keep it as a permanent record. The serial number or the engraved serial number is located on the bottom of the unit.

SERIAL NUMBER: _____
INSTALLATION DATE: _____
INSTALLATION TECHNICIAN: _____
PLACE OF PURCHASE: _____

Installation

Accessory List

- Head unit 1
- Power cable 1
- Mounting sleeve 1
- Carrying case 1
- Rubber Cap 1
- Hex Bolt 1
- Screw (M5 × 8) 4
- Owner's Manual 1 set

Note:

The main unit must be mounted within 35 degrees of the horizontal plane, back to front.

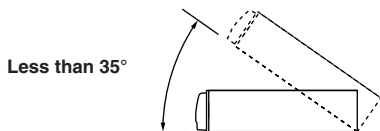

1

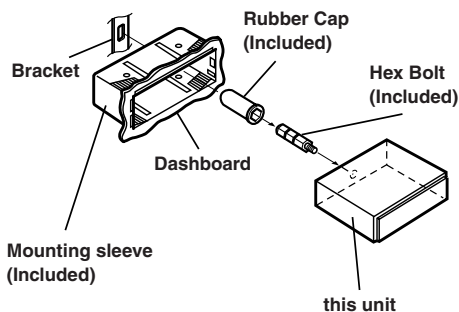

Slide mounting sleeve from main unit (see "Removal" on this page). Slide the mounting sleeve into the dashboard and fix it with the metal shackles.

2

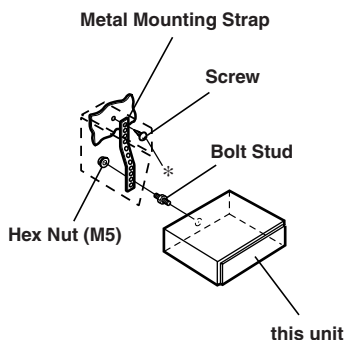

When your vehicle has the Bracket, mount the long hex bolt onto the rear panel of the CDE-9848RB/CDE-9846R/CDE-9846RM and put the Rubber Cap on the hex bolt. If your vehicle does not have the Mounting Support, reinforce the head unit with the metal mounting strap (not supplied). Connect all the leads of the CDE-9848RB/CDE-9846R/CDE-9846RM according to details described in the CONNECTION section.

- For the screw *, provide a proper screw to the chassis installing location.

- 3 Slide the CDE-9848RB/CDE-9846R/CDE-9846RM into the dashboard. When the unit is in place, make sure the locking pins are fully seated in the down position. This can be done by pressing firmly in on the unit while pushing the locking pin down with a small screwdriver. This ensures that the unit is properly locked and will not accidentally come out from the dashboard. Install the Detachable Front Panel.

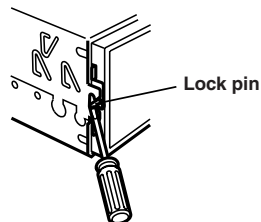

Removal

- 1 Remove the detachable front panel.
- 2 Use a small screwdriver (or similar tool) to push the locking pins to the "up" position (see above drawing). As each pin is unlocked, gently pull out on the unit to make sure it does not re-lock before unlocking the second pin.
- 3 Pull the unit out, keeping it unlocked as you do so.

<JAPANESE CAR>

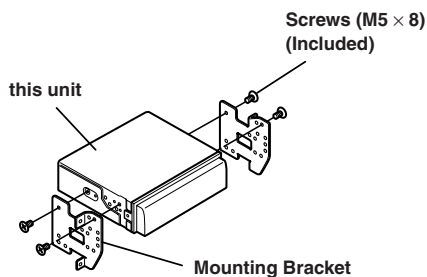
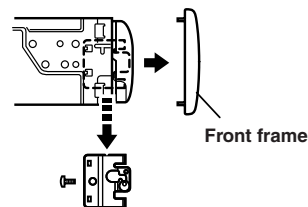

- ① Antenna Receptacle
- ② Audio Interrupt In Lead (Pink/Black)
Connect this lead to the Audio Interface output of a cellular phone which provides ground shorting when a call is received.
- ③ Remote Turn-On Lead (Blue/White)
Connect this lead to the remote turn-on lead of your amplifier or signal processor.
- ④ Dimmer Lead (Orange) (CDE-9848RB only)
This lead may be connected to the vehicle's instrument cluster illumination lead. This will enable the vehicle's dimmer control to dim the backlighting of the unit.
- ⑤ Switched Power Lead (Ignition) (Red)
Connect this lead to an open terminal on the vehicle's fuse box or another unused power source which provides (+) 12V only when the ignition is turned on or in the accessory position.
- ⑥ Ground Lead (Black)
Connect this lead to a good chassis ground on the vehicle. Make sure the connection is made to bare metal and is securely fastened using the sheet metal screw provided.
- ⑦ Power Antenna Lead (Blue)
Connect this lead to the +B terminal of your power antenna, if applicable.
- *This lead should be used only for controlling the vehicle's power antenna. Do not use this lead to turn on an amplifier or a signal processor, etc.*
- ⑧ Battery Lead (Yellow)
Connect this lead to the positive (+) post of the vehicle's battery.
- ⑨ ISO Power Supply Connector
- ⑩ Fuse Holder (10A)
- ⑪ Steering Remote Control Interface Connector
To steering remote control interface box.
- ⑫ Front/Subwoofer* Output RCA Connectors
* *When Subwoofer is set to OFF: Output is from front speakers.
When Subwoofer is set to ON: Output is from Subwoofer.*
- ⑬ Power Supply Connector
- ⑭ Left Rear (+) Speaker Output Lead (Green)
- ⑮ Left Rear (-) Speaker Output Lead (Green/Black)
- ⑯ Left Front (+) Speaker Output Lead (White)
- ⑰ Left Front (-) Speaker Output Lead (White/Black)
- ⑱ Right Front (-) Speaker Output Lead (Grey/Black)
- ⑲ Right Front (+) Speaker Output Lead (Grey)
- ⑳ Right Rear (-) Speaker Output Lead (Violet/Black)
- ㉑ Right Rear (+) Speaker Output Lead (Violet)
- ㉒ ISO Connector (Speaker Output)
- ㉓ RCA Extension Cable (sold separately)
- ㉔ ISO/JASO Antenna Adapter (sold separately)
An ISO/JASO antenna adapter may be required, depending on the vehicle.
- ㉕ AUX Input RCA Connector (CDE-9848RB only)
This connector allows for input of audio from an external device (such as a portable player), using a commercially available RCA cable.

To prevent external noise from entering the audio system.

- Locate the unit and route the leads at least 10cm away from the car harness.
- Keep the battery power leads as far away from other leads as possible.
- Connect the ground lead securely to a bare metal spot (remove any paint, dirt or grease if necessary) of the car chassis.
- If you add an optional noise suppressor, connect it as far away from the unit as possible. Your Alpine dealer carries various noise suppressors, contact them for further information.
- Your Alpine dealer knows best about noise prevention measures so consult your dealer for further information.

Appendix

Product Information Card

Produkt-Informationskarte

Carte d'informations sur le produit

Tarjeta de información del producto

English

Filling in this Product Information Card is voluntary. If you fill in this card and send it to Alpine, your data will be tabulated into reference data for future Alpine product development. In addition, in the future you may receive information about new products or Survey Mail requesting additional opinions about Alpine products or services. If you agree to the above term, please sign your name in the indicated space and return the card. Any additional comments or inquiries may be sent to: Person in charge of Customer Service department Alpine Electronics (Europe) GmbH.
Frankfurter Ring 117, 80807 München, Germany
Phone: +49-(0)89-32 42 640

Deutsch

Das Ausfüllen dieser Produktinformations-Karte ist freiwillig. Sollten Sie diese Karte vervollständigen, so werden die Daten für zukünftige Produktentwicklungen von Alpine als Referenzdaten herangezogen. Ebenso können Sie in der Zukunft Informationen über neue Alpine Produkte erhalten oder uns auch Ihre Meinung über Alpine Produkte und Dienstleistungen im Rahmen von Kunden-Befragungen mitteilen. Stimmen Sie dem Kontakt durch Alpine zu, so würden wir Sie bitten, in dem dafür vorgesehenen Feld zu unterschreiben und die Karte kostenfrei an uns zurückzuschicken. Zusätzliche Kommentare und Meinungen können Sie gerne an den zuständigen Kontakt im Kundendienst Alpine Electronics (Europe) GmbH senden.
Frankfurter Ring 117, 80807 München, Germany
Phone: 089-32 42 640

Français

En remplissant volontairement cette fiche, et en l'envoyant à Alpine, vous acceptez que ces informations soient utilisées par Alpine, dans le cadre de développement de nouveaux produits. Par ailleurs, vous autorisez Alpine à solliciter votre opinion par mailing sur de nouveaux produits ou services. Si vous acceptez les termes ci-dessus, veuillez signer cette carte à l'endroit indiqué, et nous la retourner. Tout autre commentaire ou demande doit être adressé à l'attention de: Responsable du service consommateur Alpine Electronics (Europe) GmbH.
Frankfurter Ring 117, 80807 München, Germany
Phone: +49-(0)89-32 42 640

Español

El envío de la información solicitada es voluntario. Si Vd. nos la remite, será utilizada de modo confidencial para el desarrollo de futuros productos Alpine. Si Vd. desea recibir información sobre nuevos productos de nuestra gama, indique su nombre en el espacio designado y remitanos la tarjeta. Cualquier solicitud adicional puede ser enviada a: Persona responsable del Servicio de Atención al Cliente de Alpine Electronics (Europe) GmbH.
Frankfurter Ring 117, 80807 München, Germany
Phone: +49-(0)89-32 42 640

Q1. PRODUCT PURCHASED

1. Cassette Player
2. CD Player
3. MD Player
4. DVD Player
5. CD Changer
6. Amplifier
7. Speaker
8. Subwoofer
9. Monitor Controller
10. Video Monitor
11. Navigation
12. Processor/Equalizer
13. CD/Video CD Changer
14. Other _____

Q2. MODEL NUMBER: _____

Q3. DATE OF PURCHASE:

Month: _____ Year: _____

Q4. If navigation system, which monitor?

1. Alpine → (Model No.) _____
2. Other → (Brand Name) _____

Q5. STORE TYPE WHERE PURCHASED:

1. Car Audio Specialist
2. Audio/Video Store
3. Electronics/Appliance Store
4. Car Accessories Shop
5. Other _____

Q6. Type of vehicle in which this unit is installed:

Make: _____ Model: _____
Purchased Model _____
Year: _____ Year: _____

Q7. How was this vehicle purchased?

1. Purchase
2. Lease

Q8. Purpose of buying this unit?

1. Addition
2. Replacement

- ↓
- Previous brand replaced?

1. Factory installed
2. Alpine
3. Other → (Brand Name) _____

Q9. Have you purchased Alpine products before?

1. First time
2. Two or More times

Q10. When you purchased this Alpine unit, did you compare it with other brand?

1. Yes → (Brand Name) _____
2. No

Q11. GENDER

1. Male
2. Female

Q12. AGE _____

Q13. MARITAL STATUS

1. Single
2. Married

Q14. OCCUPATION

1. Company Owner/Self-employed/
Freelance
2. Manager
3. Company Employee
4. Civil Servant
5. Educator
6. Student
7. Other _____

Q15. Comments _____

Q1. gekauftes Gerät

1. Kassetten-Spieler
2. CD-Spieler
3. MD-Spieler
4. DVD-Spieler
5. CD-Wechsler
6. Verstärker
7. Lautsprecher
8. Subwoofer
9. Monitor-Controller
10. Video-Monitor
11. Navigationssystem
12. Prozessor/Equalizer
13. CD/Video-CD-Wechsler
14. andere _____

Q2. Modellnummer: _____

Q3. Kaufdatum:

Monat: _____ Jahr: _____

Q4. Falls Navigationssystem: Welcher Monitor?

1. Alpine → (Modellnr.) _____
2. Anderer Hersteller →
(Herstellername) _____

Q5. Art des Geschäfts, in dem Sie das Gerät gekauft haben:

1. Spezialist für Auto-Audioanlagen
2. Audio/Video-Geschäft
3. Elektro-Geschäft
4. Autozubehör-Geschäft
5. Anderer Hersteller _____

Q6. Art des Fahrzeugs, in dem das Gerät installiert wurde:

Marke: _____ Modell: _____
gekauft im _____
Jahr: _____ Baujahr: _____

Q7. Wie haben Sie das Fahrzeug gekauft?

1. Kauf
2. Leasing

Q8. Zweck des Kaufs dieses Geräts?

1. Zusätzlich
2. Austausch

- ↓
- Marke des ausgetauschten Geräts?

1. Serienmäßige Ausstattung
2. Alpine
3. Anderer Hersteller →
(Herstellername) _____

Q9. War dies das erste Mal, dass Sie ein Alpine-Gerät gekauft haben?

1. Erstes Mal
2. Zweites Mal oder öfter

Q10. Haben Sie dieses Alpine-Gerät vor dem Kauf mit Geräten anderer Hersteller verglichen?

1. Ja → (Herstellername) _____
2. Nein

Q11. Geschlecht

1. Männlich
2. Weiblich

Q12. Alter _____

Q13. Familienstand

1. Ledig
2. Verheiratet

Q14. Beruf

1. Selbständige/Firmeninhaber/treiberberuflich
Tätige
2. Leitende Angestellte
3. Sonstige Angestellte
4. Beamte
5. Schulbildung
6. Studium
7. Sonstige _____

Q15. Kommentar: _____

Q1. PRODUIT ACHETE

1. Lecteur de cassette
2. Lecteur de CD
3. Lecteur MD
4. Lecteur DVD
5. Changeur de CD
6. Amplificateur
7. Haut-parleur
8. Haut-parleur de graves
9. Station Multimedia
10. Moniteur Vidéo
11. Navigation
12. Processeur/Egaliseur
13. Changeur de CD/CD Vidéo
14. Autre _____

Q2. NUMERO DU MODELE: _____

Q3. DATE D'ACHAT:

Mois: _____ Année: _____

Q4. Si c'est un système de navigation, quel moniteur?

1. Alpine → (N° du modèle) _____
2. Autre → (Marque) _____

Q5. TYPE DE MAGASIN OU VOUS AVEZ ACHETE LE PRODUIT:

1. Spécialiste autoradio
2. Magasin audio/vidéo
3. Magasin d'électronique/appareils
4. Magasin d'accessoires automobiles
5. Autre _____

Q6. Type de véhicule dans lequel cet appareil est installé:

Marque: _____ Modèle: _____
Année _____ Année du
d'achat: _____ modèle: _____

Q7. Comment avez-vous acheté ce véhicule?

1. Achat
2. Location-bail

Q8. Pourquoi avez-vous acheté cet appareil?

1. Addition
2. Remplacement

- ↓
- Marque précédente remplacée?

1. Installée en usine
2. Alpine
3. Autre → (Marque) _____

Q9. Aviez-vous déjà acheté des produits Alpine?

1. Première fois
2. Deux fois ou plus

Q10. Lorsque vous avez acheté ce produit Alpine, l'avez-vous comparé à une autre marque?

1. Oui → (Marque) _____
2. Non

Q11. SEXE

1. Masculin
2. Féminin

Q12. AGE _____

Q13. SITUATION DE FAMILLE

1. Célibataire
2. Marié

Q14. PROFESSION

1. Entrepreneur/Travailleur indépendant/
Free-lance
2. Directeur
3. Employé de bureau
4. Fonctionnaire
5. Educateur
6. Etudiant
7. Autre _____

Q15. Commentaires _____

Q1. Producto Comprado

1. Radio/Cassette
2. Radio/CD
3. Reproductor de MD
4. Reproductor de DVD
5. Cambiador de CD
6. Amplificador
7. Altavoz
8. Subwoofer
9. Monitor de control
10. Monitor de video
11. Sistema de navegación
12. Procesador/Equalizador
13. Cambiador de CD/Video CD
14. Otros _____

Q2. Número de modelo: _____

Q3. Fecha de compra:

Mes: _____ Año: _____

Q4. En caso de sistema de navegación, ¿qué monitor?

1. Alpine → (N° de modelo) _____
2. Otro → (Nombre de marca) _____

Q5. TIPO DE TIENDA DONDE COMPRÓ:

1. Especialista en audio de automóviles
2. Tienda de audio/video
3. Tienda de electrónica/electrodomésticos
4. Tienda de accesorios automovilísticos
5. Otros _____

Q6. Tipo de vehículo en que la unidad está instalada:

Marca: _____ Modelo: _____
Año de _____ Año del
compra: _____ modelo: _____

Q7. ¿Cómo fue comprado este vehículo?

1. compra
2. Leasing

Q8. ¿Propósito de comprar esta unidad?

1. Mejora del sistema
2. Sustitución

- ↓
- ¿Sustitución de marca anterior?

1. Instalada en fábrica
2. Alpine
3. Otros → (Nombre de marca) _____

Q9. ¿Ha comprado Vd. productos Alpine anteriormente?

1. Primera vez
2. Dos o más veces

Q10. Cuando usted compró esta unidad Alpine, ¿la comparó con otros fabricantes?

1. Si → (Nombre de marca) _____
2. No

Q11. SEXO

1. Masculino
2. Femenino

Q12. Edad _____

Q13. Estado civil

1. Soltero
2. Casado

Q14. Ocupación

1. Propietario de empresa/Autónomo/
Profesional independiente
2. Gerente
3. Empleado de compañía
4. Empleado público
5. Profesor
6. Estudiante
7. Otros _____

Q15. Comentarios _____

Scheda informazioni prodotto

Italiano

La compilazione di questa formulario è volontaria. Se compilate questo formulario, ritornandolo ad Alpine, i Vostri dati saranno raccolti in un file di riferimento per lo sviluppo dei nuovi prodotti Alpine. In aggiunta Voi potrete ricevere in futuro informazioni riguardanti i nuovi prodotti o la richiesta di una Vostra opinione circa i prodotti o i servizi forniti da Alpine. Se siete d'accordo, Vi preghiamo di ritornarci il formulario compilato negli appositi spazi con i Vostri dati. In caso desideriate fornire altri commenti o richiedere informazioni aggiuntive, potete indirizzare il tutto a : Responsabile dipartimento Servizio Clienti Alpine Electronics (Europe) GmbH.
Frankfurter Ring 117, 80807 München, Germany
Phone: +49-(0)89-32 42 640

Q1. PRODOTTO ACQUISTATO

1. Lettore di cassette
2. Lettore CD
3. Lettore MD
4. Lettore DVD
5. CD Changer
6. Amplificatore
7. Altoparlante
8. Subwoofer
9. Radio Monitor
10. Monitor video
11. Sistema di navigazione
12. Processore/equalizzatore
13. Cambia CD/Video CD
14. Altro _____

Q2. NUMERO MODELLO: _____

Q3. DATA DI ACQUISTO:

Mese: _____ Anno: _____

Q4. In caso di acquisto di un sistema di navigazione, quale monitor possiede?

1. Alpine → (No. Modello) _____
2. Altro → Nome marca _____

Q5. NEGOZIO DI ACQUISTO:

1. Specialista Car Stereo
2. Negozio di audio/video
3. Negozio di elettronica/elettrodomestici
4. Negozio accessori automobile
5. Altro _____

Q6. Tipo di veicolo posseduto:

Marca: _____ Modello: _____
Anno _____ Anno _____
acquisto: _____ modello: _____

Q7. Modalità acquisto

1. Acquisto
2. Leasing

Q8. Scopo acquisto

1. Aggiunta
2. Sostituzione
- ↓
- Marca sostituita
1. Installato di fabbrica
2. Alpine
3. Altro → (Nome marca) _____

Q9. Avevate già acquistato prodotti Alpine?

1. No
2. Due o tre volte

Q10. Nell'acquistarlo, avete paragonato questo prodotto ad un'altra marca?

1. Sì → (Nome marca) _____
2. No

Q11. SESSO

1. Maschile
2. Femminile

Q12. ETÀ _____

Q13. STATO CIVILE

1. Celibe/nubile
2. Coniugato/coniugata

Q14. LAVORO

1. Proprietario di azienda/artigiano/libero professionista
2. Manager
3. Impiegato
4. Impiegato statale
5. Insegnante
6. Studente
7. Altro _____

Q15. Commenti _____

- ◆ I agree to the above stated terms of the Alpine Product Information Card.
- ◆ Ich stimme dem Kontakt durch Alpine für Informations- und Befragungszwecke zu.
- ◆ J'accepte les termes de cette carte d'information produit Alpine.
- ◆ Estoy conforme con los términos de la tarjeta de información sobre producto de Alpine.
- ◆ Accetto i termini della scheda informazioni prodotti Alpine.

_____ (Date/Datum/Date/Fecha/Data)

_____ (Signature/Unterschrift/Signature/Firma)

Name/Nom/Nombre/Nome

(First Name/Vorname/Prénom/Primer nombre/Nome)

(Surname/Familiennome/Nom de famille/Apellido/Cognome)

Home Address/Privatanschrift/Adresse/Dirección/Indirizzo

(Street/Straße/Rue/Calle/Via) (Post Code/Postleitzahl/Code postal/Código postal/Codice postale)

(Town/City/Stadt/Ville/Ciudad/Città) (Country/Land/Pays/Pais/Paese)

Telephone Number: _____

E-Mail/Correo electrónico: _____

Q1 NO. Other	Q2
-----------------	----

Q3 Month	Year	Q4 NO.1. Model No.
NO.2. Brand Name		

Q5 NO. Other	Q6 Make:	Model:
	Purchased Year:	Model Year:

Q7 NO.	Q8 NO. 1	Previous brand replaced.	Brand Name
	2	1. 2. 3.	→

Q9 NO.	Q10 1 → Brand Name	Q11 NO.
	NO. 2	

Q12 years old	Q13 NO.	Q14 NO. Other
---------------------	---------	------------------

Q15 Comments _____

LUFTPORT
PAR AVION
PRIORITAIRE

NE PAS AFFRANCHIR

NICHT FREIMACHEN
NO STAMP REQUIRED

REPONSE PAYEE/ WERBEANTWORT
ALLEMAGNE

ALPINE ELECTRONICS (EUROPE) GmbH
Frankfurter Ring 117, 80807 München,
Germany