

FOR CAR USE ONLY/NUR FÜR AUTOMOBIL GEBRAUCH/POUR APPLICATION AUTOMOBILE UNIQUEMENT/  
PARA USO EN AUTOMÓVILES/SOLO PER L'UTILIZZO IN AUTOMOBILE/ENDAST FÖR BILBRUK



RDS DVD-AUDIO/VIDEO Receiver

DVA-9861Ri

MP3



- OWNER'S MANUAL  
Please read before using this equipment.
- BEDIENUNGSANLEITUNG  
Lesen Sie diese Bedienungsanleitung bitte vor  
Gebrauch des Gerätes.
- MODE D'EMPLOI  
Veuillez lire avant d'utiliser cet appareil.
- MANUAL DE OPERACIÓN  
Léalo antes de utilizar este equipo.
- ISTRUZIONI PER L'USO  
Si prega di leggere prima di utilizzare il  
attrezzatura.
- ANVÄNDARHANDLEDNING  
Innan du använder utrustningen bör du läsa igenom  
denna användarhandledning.

ALPINE ELECTRONICS MARKETING, INC.  
1-1-8 Nishi Gotanda,  
Shinagawa-ku,  
Tokyo 141-0031, Japan  
Phone 03-5496-8231

ALPINE ELECTRONICS OF AMERICA, INC.  
19145 Gramercy Place, Torrance,  
California 90501, U.S.A.  
Phone 1-800-ALPINE-1 (1-800-257-4631)

ALPINE ELECTRONICS OF CANADA, INC.  
777 Superstest Road, Toronto,  
Ontario M3J 2M9, Canada  
Phone 1-800-ALPINE-1 (1-800-257-4631)

ALPINE ELECTRONICS OF AUSTRALIA PTY. LTD.  
161-165 Princes Highway, Hallam  
Victoria 3803, Australia  
Phone 03-8787-1200

ALPINE ELECTRONICS GmbH  
Frankfurter Ring 117, 80807 München, Germany  
Phone 089-32 42 640

ALPINE ELECTRONICS OF U.K. LTD.  
Alpine House  
Fletchamstead Highway, Coventry CV4 9TW, U.K.  
Phone 0870-33 33 763

ALPINE ELECTRONICS FRANCE S.A.R.L.  
(RCS PONTOISE B 338 101 280)  
98, Rue de la Belle Etoile, Z.I. Paris Nord II,  
B.P. 50016, 95945 Roissy Charles de Gaulle  
Cedex, France  
Phone 01-48638989

ALPINE ITALIA S.p.A.  
Viale C. Colombo 8, 20090 Trezzano  
Sul Naviglio (MI), Italy  
Phone 02-484781

ALPINE ELECTRONICS DE ESPAÑA, S.A.  
Portal de Gamarra 36, Pabellón, 32  
01013 Vitoria (Alava)-APDO 133, Spain  
Phone 945-283588

ALPINE ELECTRONICS (BENELUX) GmbH  
Leuvensesteenweg 510-B6,  
1930 Zaventem, Belgium  
Phone 02-725-13 15

EN

DE

FR

ES

IT

SE

# Contents

## Operating Instructions

### WARNING

<b>WARNING</b> .....	<b>4</b>
<b>CAUTION</b> .....	<b>4</b>
<b>PRECAUTIONS</b> .....	<b>4</b>
<b>Discs playable on this unit</b> .....	<b>6</b>

### Getting Started

Turning Power On and Off .....	8
Detaching and Attaching the Front Panel .....	8
Initial System Start-Up .....	9
Adjusting Volume .....	9
Setting Time .....	9

### Radio

Listening to Radio .....	9
Manual Storing of Station Presets .....	10
Automatic Memory of Station Presets .....	10
Tuning to Preset Stations .....	10
Frequency Search Function .....	10

### RDS

Setting RDS Reception Mode and Receiving RDS Stations .....	11
Recalling Preset RDS Stations .....	11
Receiving RDS Regional (Local) Stations .....	11
PI SEEK Setting .....	12
Setting PTY31 (Emergency Broadcast) reception .....	12
Setting the Time to automatically Adjust .....	12
Receiving Traffic Information .....	12
PTY (Programme Type) Tuning .....	13
Receiving Traffic Information While Playing CD or Radio .....	13
Priority News .....	13
Displaying Radio Text .....	14

### CD/MP3/WMA

Playback .....	14
Repeat Play .....	15
M.I.X. (Random Play) .....	16
Searching from CD Text .....	16
File/Folder Name Search (concerning MP3/WMA) .....	16
About MP3/WMA .....	17

### DVD/Video CD

Playing a Disc .....	19
Searching by Programme .....	19
Searching by Playlist .....	19
Stopping Playback (PRE-STOP) .....	20
Stopping Playback .....	20
Fast-forwarding/Fast-reversing .....	20
Finding the Beginning of Chapters or Tracks .....	20
Selecting Programme/Playlist .....	21
Playing Still Frames (pausing) .....	21
Forward/reverse frame-by-frame Playback .....	21
Slow Motion Playback .....	21
Searching by Title Number .....	21
Searching by Group Number .....	21
Searching by Programme or Playlist Number .....	21
Searching Directly by Chapter or Track Number .....	22
Repeat Playback .....	22
Switching the Audio Tracks .....	23
Switching the Angle .....	23
Switching the Subtitles (subtitle language) .....	23
Displaying the Disc Status .....	24
Scroll to Move the Page Forward or Back .....	24

## Sound Setting

Adjusting Bass/Treble/Balance (Between Left and Right)/Fader (Between Front and Rear)/Defeat .....	25
Setting the Bass Control .....	25
Setting the Treble Control .....	26
Turning Loudness On/Off .....	26

## Other Functions

Displaying the Text .....	27
Displaying Time .....	28
Blackout Mode On and Off .....	28
Setting the Wallpaper .....	28

## SETUP

### Sound Customizing

Adjusting Source Signal Levels .....	29
Subwoofer On and Off .....	29
Setting the Subwoofer System .....	29

### Visual Customizing

Changing Lighting Colour .....	29
Dimmer Control .....	29
Scroll Type Setting .....	29
Scroll Setting (TEXT SCROLL) .....	29
Demonstration .....	29

### External Device

Connecting an MP3 Changer (PLAY MODE) .....	29
Turning Mute Mode On/Off (INT MUTE) .....	29
Setting the AUX Mode (V-Link) .....	29
Connecting to an External Amplifier .....	30
Setting the Digital Output .....	30

## DVD Setup

DVD Setup Operation .....	30
Setting the language .....	31
Setting the TV Screen .....	31
Setting the Country Code .....	31
Setting the Rating Level (Parental Lock) .....	32

## Audio Setup

Audio Setup Operation .....	33
Setting the Digital Output .....	33
Setting the Downmix Mode .....	34

## Custom Setup

Custom Setup Operation .....	35
Setting the DVD Audio Playback Mode .....	35
Setting the CD Play Mode .....	35
Setting the Video CD Play Mode .....	35
Playing the Bonus Group .....	35

## External Audio Processor (Optional)

Adjustment Procedure for Dolby Surround ....	36
Setting the Speakers .....	37
Set MX Mode of the External Audio Processor .....	37
X-OVER Adjustment .....	37
Performing Time Correction Manually (TCR)/ Phase Switching .....	38
Calculating the Time Correction .....	38
Inputting the Time Correction .....	38
Switching the Phase .....	39
Graphic Equalizer Adjustments .....	39
Parametric Equalizer Adjustments .....	40
Setting Bass Compressor .....	40
Setting Bass Focus .....	41
Speaker Setup .....	41
Setting of Dolby Digital .....	41
Adjusting the speaker levels .....	41
Mixing bass sound to the rear channel .....	42
Adjusting the acoustic image .....	42
Achieving powerful high volume sound ....	43
Adjusting the DVD Level .....	43
Using the Pro Logic II Mode .....	43
Linear PCM Setting .....	44
Storing Settings in the Memory .....	44
Recalling the Preset Memory .....	44
Confirming the current Preset No./EQ mode .....	44
Remote Control Operation .....	45

## iPod™ (Optional)

Playback .....	46
Searching for a desired Song .....	46
Searching by Playlist .....	46
Searching by artist name .....	46
Searching by album name .....	47
Searching by song name .....	47
Direct Search Function .....	47
Select Playlist/Artist/Album .....	48
Quick Search .....	48
Random Play Shuffle (M.I.X.) .....	48
Repeat Play .....	48
Displaying the Text .....	48

## Changer (Optional)

Controlling CD Changer (Optional) .....	49
Quick Search .....	49
Playing MP3 Files with the CD Changer (Optional) .....	49
Multi-Changer Selection (Optional) .....	49

## Remote Control

Controls on Remote Control .....	50
When Using the Remote Control .....	51
Battery Replacement .....	51

## Information

About DVDs .....	52
Terminology .....	53
List of Language Codes .....	54
List of Country Codes .....	55
In Case of Difficulty .....	57
Specifications .....	61

---

# Installation and Connections

<b>Warning</b> .....	<b>62</b>
<b>Caution</b> .....	<b>62</b>
<b>Precautions</b> .....	<b>62</b>
Installation .....	63
Connections .....	65
System Example .....	67

---

---

# Operating Instructions

## WARNING



### WARNING

This symbol means important instructions. Failure to heed them can result in serious injury or death.

---

#### DO NOT OPERATE ANY FUNCTION THAT TAKES YOUR ATTENTION AWAY FROM SAFELY DRIVING YOUR VEHICLE.

Any function that requires your prolonged attention should only be performed after coming to a complete stop. Always stop the vehicle in a safe location before performing these functions. Failure to do so may result in an accident.

---

#### KEEP THE VOLUME AT A LEVEL WHERE YOU CAN STILL HEAR OUTSIDE NOISE WHILE DRIVING.

Failure to do so may result in an accident.

---

#### DO NOT DISASSEMBLE OR ALTER.

Doing so may result in an accident, fire or electric shock.

---

#### USE ONLY IN CARS WITH A 12 VOLT NEGATIVE GROUND.

(Check with your dealer if you are not sure.) Failure to do so may result in fire, etc.

---

#### KEEP SMALL OBJECTS SUCH AS BATTERIES OUT OF THE REACH OF CHILDREN.

Swallowing them may result in serious injury. If swallowed, consult a physician immediately.

---

#### USE THE CORRECT AMPERE RATING WHEN REPLACING FUSES.

Failure to do so may result in fire or electric shock.

---

#### DO NOT BLOCK VENTS OR RADIATOR PANELS.

Doing so may cause heat to build up inside and may result in fire.

---

#### USE THIS PRODUCT FOR MOBILE 12V APPLICATIONS.

Use for other than its designed application may result in fire, electric shock or other injury.

---

#### DO NOT PLACE HANDS, FINGERS OR FOREIGN OBJECTS IN INSERTION SLOTS OR GAPS.

Doing so may result in personal injury or damage to the product.



### CAUTION

This symbol means important instructions. Failure to heed them can result in injury or material property damage.

---

#### HALT USE IMMEDIATELY IF A PROBLEM APPEARS.

Failure to do so may cause personal injury or damage to the product. Return it to your authorized Alpine dealer or the nearest Alpine Service Centre for repairing.

---

#### DO NOT MIX NEW BATTERIES WITH OLD BATTERIES. INSERT WITH THE CORRECT BATTERY POLARITY.

When inserting the batteries, be sure to observe proper polarity (+ and -) as instructed. Rupture or chemical leakage from the battery may cause fire or personal injury.



### PRECAUTIONS

---

#### Product Cleaning

Use a soft dry cloth for periodic cleaning of the product. For more severe stains, please dampen the cloth with water only. Anything else has the chance of dissolving the paint or damaging the plastic.

---

#### Temperature

Be sure the temperature inside the vehicle is between +60°C (+140°F) and -10°C (+14°F) before turning your unit on.

---

#### Moisture Condensation

You may notice the CD playback sound wavering due to condensation. If this happens, remove the disc from the player and wait about an hour for the moisture to evaporate.

---

#### Damaged Disc

Do not attempt to play cracked, warped, or damaged discs. Playing a bad disc could severely damage the playback mechanism.

---

#### Maintenance

If you have problems, do not attempt to repair the unit yourself. Return it to your Alpine dealer or the nearest Alpine Service Station for servicing.

---

## Never Attempt the Following

Do not grip or pull out the disc while it is being pulled back into the player by the automatic reloading mechanism.

Do not attempt to insert a disc into the unit when the unit power is off.

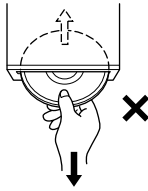

---

## Inserting Discs

Your player accepts only one disc at a time for playback. Do not attempt to load more than one disc.

Make sure the label side is facing up when you insert the disc. "ERROR" will be displayed on your player if you insert a disc incorrectly. If "ERROR" continues to be displayed even though the disc has been inserted correctly, push the RESET switch with a pointed object such as a ballpoint pen.

Playing a disc while driving on a very bumpy road may result in skips, but this will not scratch the disc or damage the player.

---

## New Discs

As a protective measure to prevent the CD from jamming, the CD player will automatically eject discs with irregular surfaces or inserted incorrectly. When a new disc is inserted into the player and ejected after initial loading, using your finger, feel around the inside of the centre hole and outside edge of the disc. If you feel any small bumps or irregularities, this could inhibit proper loading of the disc. To remove the bumps, rub the inside edge of the hole and outside edge of the disc with a ballpoint pen or other such instrument, then insert the disc again.

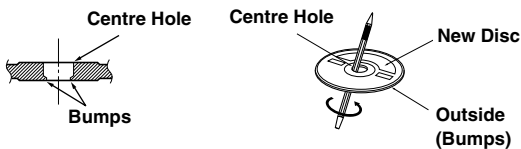

---

## Irregular Shaped Discs

Be sure to use round shape discs only for this unit and never use any special shape discs.

Use of special shape discs may cause damage to the mechanism.

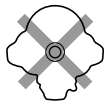

---

## Installation Location

Make sure the DVA-9861Ri will not be installed in a location subjected to:

- Direct sun and heat
- High humidity and water
- Excessive dust
- Excessive vibrations

---

## Correct Handling

Do not drop the disc while handling. Hold the disc so you will not leave fingerprints on the surface. Do not affix tape, paper, or gummed labels to the disc. Do not write on the disc.

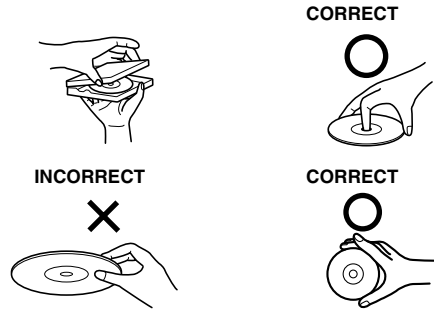

---

## Disc Cleaning

Fingerprints, dust, or soil on the surface of the disc could cause the CD player to skip. For routine cleaning, wipe the playing surface with a clean, soft cloth from the centre of the disc to the outer edge. If the surface is heavily soiled, dampen a clean, soft cloth in a solution of mild neutral detergent before cleaning the disc.



---

## Disc Accessories

There are various accessories available on the market for protecting the disc surface and improving sound quality. However, most of them will influence the thickness and/or diameter of the disc. Using such accessories can cause the disc to be out of standard specifications and may create operational problems. We recommend not using these accessories on discs played in Alpine CD players.



Transparent Sheet

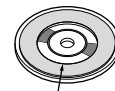

Disc Stabilizer

# Discs playable on this unit

## Playable Discs

The discs listed below can be played on this unit.

	Mark (logo)	Recorded Content	Disc size
DVD Audio		Audio + Video	12 cm*
			8 cm
DVD Video		Audio + Video	12 cm*
			8 cm
Video CD	 	Audio + Video	12 cm
			8 cm
Music CD	 	Audio	12 cm
			8 cm (CD single)

\* Two-layer DVD disc compatible

## Discs that cannot be played

DVD-ROMs, DVD-RAMs, CD-ROMs (excluding MP3/WMA files), photo CDs, etc.

## DVD region number (playable region number)

This DVD player will play back any disc whose region number is 2 (or All). DVDs with a region number other than those listed below, cannot be played on this DVD player.



## Video CDs

This DVD head unit is compatible with playback control (PBC) compatible video CDs (version 2.0). "PBC" is a function by which you can use menu screens recorded on the disc to find the scene you want to watch and view various types of information in dialogue style.

## Using compact discs (CD/CD-R/CD-RW)

If you use unspecified compact discs, correct performance cannot be guaranteed.

You can play CD-Rs (CD-Recordable)/CD-RWs (CD-ReWritable) which have been recorded only on audio devices. You can also play CD-Rs/CD-RWs containing MP3/WMA formatted audio files.

- Some of the following discs may not play on this unit: Flawed discs, discs with fingerprints, discs exposed to extreme temperatures or sunlight (e.g., left in the car or this unit), discs recorded under unstable conditions, discs on which a recording failed or a re-recording was attempted, copy-protected CDs which do not conform to the audio CD industry standard.
- Use discs with MP3/WMA files written in a format compliant with ISO9660 level 1 or level 2. For details, see pages 17 and 18.

To customers using CD-R/CD-RW

- If a CD-R/CD-RW cannot be played back, make sure the last recording session was closed (finalized).
- Finalize the CD-R/CD-RW if necessary, and attempt playback again.

## Tips for making your own CDs

The DVA-9861Ri plays DVD Audio, DVD Video, Video CD, Audio CD and has a built in MP3/WMA decoder.

The following information is designed to help you create your own music CDs (either Audio CD or MP3/WMA encoded CD-R/RW files).

### What is the difference between an Audio and MP3/WMA CD?

An Audio CD is the same format as the commercial CDs you buy in the store (also known as CD-DA). MP3 (MPEG-1 Audio Layer 3)/WMA (Windows Media Audio) is a data file that uses a compression scheme to reduce the size of the music file.\*

### Hybrid Audio CD and Data (MP3/WMA) CD-R/RW discs:

The DVA-9861Ri can read either sector on the disc. Choose CD-DA to play the CD audio section or MP3/WMA to play the MP3/WMA section.\*

### Multisession CD-R/RW:

Once a recording has been stopped, this is considered one session. If the disc is not closed (finalized), additional data may be added. Once this additional data has been recorded, this becomes a "multisession" CD. The DVA-9861Ri can only read multisession DATA Formatted discs (MP3/WMA files - Not Audio CD files).

### Properly formatted MP3/WMA Discs:

Use ISO9660 formatting to insure proper playback. You may use standard ISO naming Level 1 (8.3 DOS standard), Level 2 (32 characters) or Joliet (Windows or Macintosh long filenames) file naming conventions\*.

\*Please consult the Owner's manual for additional information.

### On handling compact discs (CD/CD-R/CD-RW)

- Do not touch the surface.
- Do not expose the disc to direct sunlight.
- Do not affix stickers or labels.
- Clean the disc when it is dusty.
- Make sure that the disc is smooth and flat.
- Do not use commercially available disc accessories.

**Do not leave the disc in the car or the unit for a long time.  
Never expose the disc to direct sunlight.**

Heat and humidity may damage the disc and you may not be able to play it again.

### Using DVD-Rs/DVD-RWs/DVD+Rs/DVD+RWs

- This unit is compatible with discs recorded in the DVD-Video and DVD-VR mode.
- Note that discs not finalized (processed to enable to play on playback-only DVD players) cannot be played on this DVD player.
- Some discs may not play back, depending on the recording device and disc format. (Discs or files utilizing copy protection, may not be playable. Some recording systems may not properly format copied files to enable proper playback.)
- In the following cases, the disc may not play on this unit: discs recorded by certain DVD recorders, certain irregular discs, flawed discs, dirty discs, when the pickup lens of this DVD player is dirty, or when moisture condensation has occurred inside the unit.
- Be sure to follow all cautions included with your DVD-Rs/DVD-RWs/DVD+Rs/DVD+RWs discs.
- Do not put stickers, seals, or tape on the label side of DVD-Rs/DVD-RWs/DVD+Rs/DVD+RWs.
- Compared to the regular discs, DVD-Rs/DVD-RWs/DVD+Rs/DVD+RWs are more affected by heat, moisture, and direct sunlight. If left in a car, etc., damage may occur and it might not play on this unit.
- The operable temperature range for disc playback is as follows:  
DVD-R/DVD-RW: -25 ~ +70°C  
DVD+R/DVD+RW: +5 ~ +55°C

### Disc terminology

#### Title

If titles are programmed for the DVD, these are the largest units of division of the information recorded on the disc.

#### Chapter

Each Title may also be divided into smaller divisions, called chapters. These can be specific scenes or musical selections.

- *This product incorporates copyright protection technology that is protected by U.S. patents and other intellectual property rights. Use of this copyright protection technology must be authorized by Macrovision, and is intended for home and other limited viewing uses only unless otherwise authorized by Macrovision. Reverse engineering or disassembly is prohibited.*
- *Manufactured under license from Dolby Laboratories. "Dolby," "Pro Logic" and the double-D symbol are trademarks of Dolby Laboratories.*
- *"DTS" and "DTS2.0 + Digital Out" are trademarks of Digital Theater Systems, inc.*
- *Windows Media and the Windows logo are trademarks, or registered trademarks of Microsoft Corporation in the United States and/or other countries.*
- *Apple, the Apple logo and iPod are trademarks of Apple Computer, Inc., registered in the U.S. and other countries.*
- *"MPEG Layer-3 audio coding technology licensed from Fraunhofer IIS and Thomson"*
- *"Supply of this product only conveys a license for private, non-commercial use and does not convey a license nor imply any right to use this product in any commercial (i.e. revenue-generation) real time broadcasting (terrestrial, satellite, cable and/or any other media), broadcasting/streaming via internet, intranets and/or other networks or in other electronic content distribution systems, such as pay-audio or audio-on-demand applications. An independent license for such use is required. For details, please visit <http://www.mp3licensing.com>."*



# Getting Started

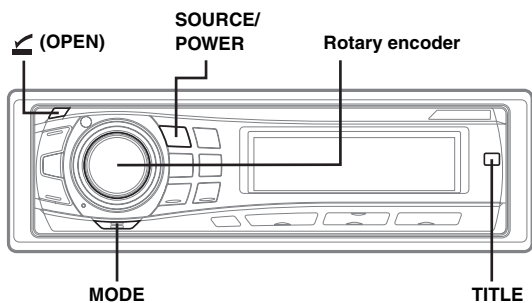

## Turning Power On and Off

Press **SOURCE/POWER** to turn on the unit.

- The unit can be turned on by pressing any other button except **TITLE**, **Rotary encoder** and **(OPEN)**.

Press and hold **SOURCE/POWER** for at least 2 seconds to turn off the unit.

- The first time power is turned on, the volume will start from level 12.

## Detaching and Attaching the Front Panel

Be sure to push the **Rotary encoder** inside the unit before opening the front panel so that the front panel will open completely, otherwise it may be damaged.

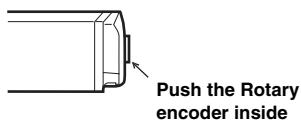

When you push the **Rotary encoder** again, it pops back out.

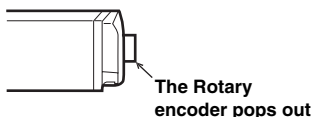

### Detaching

- 1 Turn off the unit power.
- 2 Press **(OPEN)** to open the front panel.

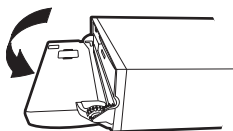

To close the front panel, press the left side until it locks as shown in the figure below.

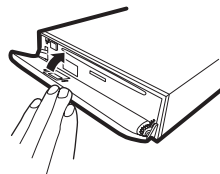

- 3 Grasp the front panel firmly, slide to the left **1**, then pull **2** to remove.

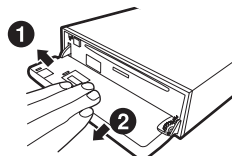

- The front panel may become hot in normal usage (especially the connector terminals on the back of the front panel.) This is not a malfunction.
- To protect the front panel, place it in the supplied carrying case.
- When detaching the front panel, do not apply excessive force as it may result in malfunction.
- Do not leave the front panel open, or drive the car with the panel open as it may result in accident or malfunction.

### Attaching

- 1 Insert the right side of the front panel into the main unit. Align the groove on the front panel with the projections on the main unit.
- 2 Push the left side of the front panel until it locks firmly into the main unit.

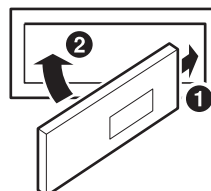

- Before attaching the front panel, make sure that there is no dirt or dust on the connector terminals and no foreign object between the front panel and the main unit.
- Attach the front panel carefully, holding the sides of the front panel to avoid pushing buttons by mistake.

## Initial System Start-Up

Be sure to press the RESET switch when using the unit for the first time, after changing the car battery, etc.

- 1 Turn off the unit power.
- 2 Press **OPEN** to open the front panel, then remove it.
- 3 Press **RESET** with a ballpoint pen or similar pointed object.



RESET switch

## Adjusting Volume

Turn the **Rotary encoder** until the desired sound is obtained.

## Setting Time

- 1 Press **TITLE** repeatedly until the time is displayed. For details, see "Displaying the Text" (page 27).
  - 2 Press and hold **TITLE** for at least 2 seconds while the time is displayed. The time indication will blink.
  - 3 Turn the **Rotary encoder** to adjust the hours while the time indication is blinking.
  - 4 When the hour has been adjusted, press **MODE**.
  - 5 Turn the **Rotary encoder** to adjust the minutes while the time indication is blinking. The time is automatically set 5 seconds after the minute adjustment. The time can also be manually set by pressing **TITLE**.
- To synchronize the clock to another clock/watch or radio time announcement, press and hold **MODE** for at least 2 seconds after setting the "hour." Minutes will reset to 00. If the display shows over "30" minutes when you do this, the time will advance one hour.

## Radio

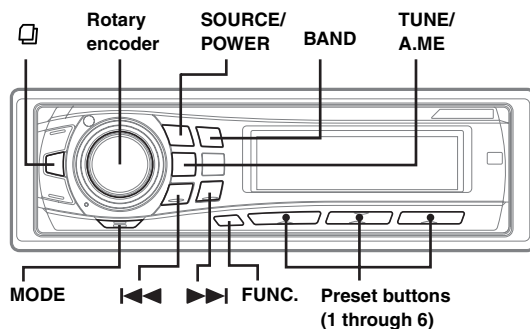

## Listening to Radio

- 1 Press **SOURCE/POWER** until a radio frequency appears in the display.
  - 2 Press **BAND** repeatedly until the desired radio band is displayed.  
F1 (FM1) → F2 (FM2) → F3 (FM3) → MW → LW → F1 (FM1)
  - 3 Press **TUNE/A.ME** to select the tuning mode.  
DX SEEK (Distance mode) → SEEK (Local mode) → OFF (Manual mode) → DX SEEK
    - The initial mode is Distance mode.
- Distance mode:**  
Both strong and weak stations will be automatically tuned in (Automatic Seek Tuning).
- Local mode:**  
Only strong stations will be automatically tuned in (Automatic Seek Tuning).
- Manual mode:**  
The frequency is manually tuned in steps (Manual tuning).
- 4 Press **Fast Forward** or **Fast Reverse** to tune in the desired station. Holding down **Fast Forward** or **Fast Reverse** will change the frequency continuously.

---

## Manual Storing of Station Presets

---

- 1 Select the radio band and tune in a desired radio station you wish to store in the preset memory.**
- 2 Press and hold, for at least 2 seconds, any one of the preset buttons (1 through 6) into which you wish to store the station.**

The selected station is stored.

The display shows the band, preset no. and station frequency memorized.

- A total of 30 stations can be stored in the preset memory (6 stations for each band; FM1, FM2, FM3, MW and LW).
- If you store a station in a preset memory which already has a station, the current station will be cleared and replaced with the new station.
- If the "FUNC" indicator is illuminated, turn off the indicator by pressing **FUNC.**, then you can perform the operation.

---

## Automatic Memory of Station Presets

---

- 1 Press BAND repeatedly until the desired radio band is displayed.**
- 2 Press and hold TUNE/A.ME for at least 2 seconds.**

The frequency on the display continues to change while the automatic memory is in progress. The tuner will automatically seek and store 6 strong stations in the selected band. They will be stored into buttons 1 to 6 in order of signal strength.

When the automatic memory has been completed, the tuner goes to the station stored in preset location no. 1.

- If no stations are stored, the tuner will return to the original station you were listening to before the auto memory procedure began.

---

## Tuning to Preset Stations

---

- 1 Press BAND repeatedly until the desired band is displayed.**
- 2 Press any one of the station preset buttons (1 through 6) that has your desired radio station in memory.**

The display shows the band, preset number and frequency of the station selected.

- If the "FUNC" indicator is illuminated, turn off the indicator by pressing **FUNC.**, then you can perform the operation.

---

## Frequency Search Function

---

You can search for a radio station by its frequency.

- 1 Press and hold  for at least 2 seconds in Radio mode to activate Frequency Search mode.**

- 2 Turn the Rotary encoder to select the desired frequency.**

- 3 Press MODE to receive the selected frequency.**

- Press and hold  for at least 2 seconds in the search mode to cancel. Or the search mode will be cancelled when an operation has not been performed in 10 seconds.

# RDS

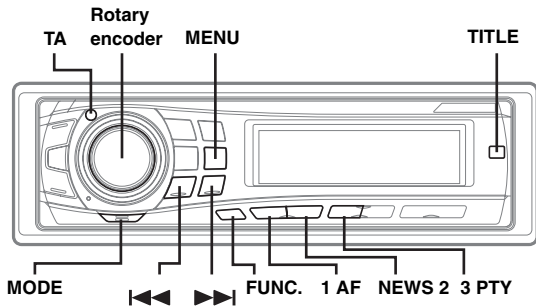

## Setting RDS Reception Mode and Receiving RDS Stations

The RDS (Radio Data System) is a radio information system using the 57 kHz subcarrier of regular FM broadcast. The RDS allows you to receive a variety of information such as traffic information, station names, and to automatically re-tune to a stronger transmitter that is broadcasting the same programme.

- 1 Press **FUNC.** so that the “FUNC” indicator lights up.
- 2 Press **1 AF** to activate the RDS mode.
- 3 Press **◀◀** or **▶▶** to tune in the desired RDS station.
- 4 Press **1 AF** again to deactivate the RDS mode.
- 5 Press **FUNC.** to activate the normal mode. The “FUNC” indicator goes out.

- When the “Setting PTY31 (Emergency Broadcast) reception” (refer to page 12) is set to on, if the unit receives the PTY31 (Emergency Broadcast) signal, the unit will show “ALARM” in the display automatically.

The RDS digital data includes the following:

PI	Programme Identification
PS	Programme Service Name
AF	List of Alternative Frequencies
TP	Traffic Programme
TA	Traffic Announcement
PTY	Programme Type
EON	Enhanced Other Networks

## Recalling Preset RDS Stations

- 1 Press **FUNC.** so that the “FUNC” indicator lights up.
- 2 Press **1 AF** to activate the RDS mode.
- 3 Press **FUNC.** to activate the normal mode. The “FUNC” indicator goes out.
- 4 Make sure that the “FUNC” indicator light goes out, then press the preset button in which your desired RDS station is preset.

If the preset station's signal is weak, the unit automatically searches and tunes to a stronger station in the AF (Alternative Frequencies) list.

- 5 If the preset station and the stations in the AF list cannot be received:

When the PI SEEK setting is on (refer to “PI SEEK Setting” on page 12), the unit searches again for a station in the PI (Programme Identification) list.

If there are still no stations receivable in the area, the unit displays the frequency of the preset station and the preset no. disappears.

If the signal level of the Regional (Local) station being tuned becomes too weak to receive, press the same preset button to tune in a Regional station in other district.

- For presetting the RDS stations, refer to the Radio Operation section. The RDS stations can be preset in the F1, F2 and F3 bands only.

## Receiving RDS Regional (Local) Stations

- 1 Press **MENU** to select the **SETUP** mode, then press **MODE**.  
SETUP mode is activated.  
BASS ENGINE → SETUP → RETURN (OFF) → BASS ENGINE
- 2 Press **◀◀** or **▶▶** to select the **RDS REGIONAL** mode, then press **MODE**.
- 3 Turn the **Rotary encoder** to select **ON** or **OFF**.  
In the OFF mode, the unit automatically keeps receiving the related local RDS station.
- 4 Press **MENU** to select **RETURN**.  
After 2 seconds, the unit returns to normal mode. Pressing and holding **MENU** for at least 2 seconds will return to normal mode.

---

## PI SEEK Setting

---

- 1 Press MENU to select the SETUP mode, then press MODE.**  
SETUP mode is activated.  
BASS ENGINE → SETUP → RETURN (OFF) → BASS ENGINE
- 2 Press ◀◀ or ▶▶ to select the PI SEEK, then press MODE.**
- 3 Turn the Rotary encoder to select ON or OFF.**
- 4 Press MENU to select RETURN.**  
After 2 seconds, the unit returns to normal mode.  
Pressing and holding MENU for at least 2 seconds will return to normal mode.

---

## Setting PTY31 (Emergency Broadcast) reception

---

Turn PTY31 (Emergency Broadcast) reception ON/OFF.

- 1 Press MENU to select SETUP mode, then press MODE.**  
The SETUP mode is activated.  
BASS ENGINE → SETUP → RETURN (OFF) → BASS ENGINE
- 2 Press ◀◀ or ▶▶ to select ALERT PTY31 mode, then press MODE.**
- 3 Turn the Rotary encoder to select ON or OFF.**  
If you set to ON, emergency broadcasts are received regardless of source.  
"ALARM" is displayed during reception.
- 4 Press MENU to select RETURN.**  
After 2 seconds, the unit returns to normal mode.  
Pressing and holding MENU for at least 2 seconds will return to normal mode.  
When an emergency broadcast is received, the volume level will be automatically changed to the memorized level in the traffic information mode.  
For details, refer to "Receiving Traffic Information" on page 12.

---

## Setting the Time to automatically Adjust

---

If you set to ON, the time will be automatically adjusted by RDS data.

- 1 Press MENU to select the SETUP mode, then press MODE.**  
SETUP mode is activated.  
BASS ENGINE → SETUP → RETURN (OFF) → BASS ENGINE
- 2 Press ◀◀ or ▶▶ to select the AUTO CLOCK mode, then press MODE.**
- 3 Turn the Rotary encoder to select ON or OFF.**
- 4 Press MENU to select RETURN.**  
After 2 seconds, the unit returns to normal mode.  
Pressing and holding MENU for at least 2 seconds will return to normal mode.

---

## Receiving Traffic Information

---

- 1 Press TA so that the "TA" indicator lights up.**
- 2 Press ◀◀ or ▶▶ to select your desired traffic information station.**  
When a traffic information station is tuned in, the "TP" indicator lights up.  
Traffic information is heard only when it is being broadcast. If traffic information is not being broadcast, the unit is set in the standby mode. When a traffic information broadcast begins, the unit automatically receives it and the display shows "TRF-INFO" for 5 seconds.  
When the traffic information broadcast is over, the unit will automatically set in the standby mode.
  - *If the traffic information broadcast signal falls below a certain level, the unit remains in the receiving mode for 1 minute. If the signal remains below a certain level for over 1 minute, the "TA" indicator blinks.*
  - *If you do not want to listen to the traffic information being received, lightly press TA to skip that traffic information message. The TA mode will remain in the ON position to receive the next traffic information message.*
  - *If the volume level is changed while receiving traffic information, the changed volume level will be memorized. When traffic information is received next time, the volume level will be automatically adjusted to the level memorized.*
  - *In the TA mode, the SEEK tuning selects only the TP stations.*

---

## PTY (Programme Type) Tuning

---

**1 Press FUNC.** so that the “FUNC” indicator lights up.

**2 Press 3 PTY** to activate the PTY mode, while the unit is in Radio (FM receiving) mode.

The Programme Type of the station being currently received will be displayed for 10 seconds.

If there is no receivable PTY broadcast, “NO PTY” will be displayed for 10 seconds.

If no RDS station can be received, the display shows “NO PTY.”

- If no operation is performed within 10 seconds after pressing 3 PTY, the PTY mode will be automatically cancelled.

**3 Press ◀◀ and ▶▶ within 10 seconds after activating the PTY mode to choose the desired programme type while the PTY (programme type) is being displayed.**

Each press scrolls the programme type by one.

┌ - LIGHT M ↔ CLASSICS ↔ OTHER M - ┐  
└──────────────────────────────────┘

**4 Press 3 PTY within 10 seconds after selecting the programme type to start searching for a station in the selected programme type.**

The chosen programme type display blinks during searching and lights when a station is found.

If no PTY station is found, “NO PTY” will be displayed for 10 seconds.

**5 Press FUNC.** to activate the normal mode. The “FUNC” indicator goes out.

- Operate the unit while the “FUNC” indicator lights up. If no operation is performed within 10 seconds, the “FUNC” indicator goes out.

---

## Receiving Traffic Information While Playing CD or Radio

---

**1 Press TA** so that the “TA” indicator lights up.

**2 Press ◀◀ and ▶▶ to select a traffic information station if necessary.**

When a traffic information broadcast starts, the unit automatically mutes the CD player/changer or the regular FM broadcast.

When the traffic information broadcast finishes, the unit automatically returns to the original source play before the traffic information broadcast began.

**When traffic information stations cannot be received:**

In the tuner mode:

When the TP signal can no longer be received for over 1 minute, the “TA” indicator blinks.

In the CD mode:

When the TP signal can no longer be received, the traffic information station of another frequency will be selected automatically.

- The receiver is equipped with the EON (Enhanced Other Networks) function in order to keep track of additional alternate frequencies to the AF list. The “EON” indicator lights up while an RDS EON station is being received. If the station being received does not broadcast the traffic information, the receiver automatically tunes in the related station that broadcasts the traffic information when it occurs.

**3 Press TA** to deactivate the Traffic Information mode. The “TA” indicator goes out.

---

## Priority News

---

This function allows you to give priority to the News programme. You will never miss the News programme as the unit automatically gives priority to the News programme whenever it begins broadcasting, and interrupts the programme you are currently listening. This feature is functional when your unit is set to a mode other than the LW and MW modes.

**1 Press FUNC.** so that the “FUNC” indicator lights up while the unit is in Radio (FM receiving) mode.

**2 Press NEWS 2** to activate the PRIORITY NEWS mode.

The “NEWS” indicator appears in the display.

To disable the PRIORITY NEWS function, press NEWS 2.

- In the PRIORITY NEWS function, unlike in the TA function, the volume does not increase automatically.

**3 Press FUNC.** to activate the normal mode, while the unit is in Radio (FM receiving) mode.

The “FUNC” indicator light goes out.

## Displaying Radio Text

Text messages from a radio station can be displayed.

Press **TITLE** while receiving FM in the radio mode to select the Radio Text display.

The display will change every time the button is pressed.

### If there is PS (Programme Service NAME)

PS (Programme Service Name)\* → Clock → Radio Text → PS (Programme Service Name)

\* Press and hold **TITLE** for at least 2 seconds if PS is displayed in the radio mode, frequency will be displayed for 5 seconds.

### If there is no PS (Programme Service Name)

FREQUENCY → Clock → Radio Text → FREQUENCY

The display shows "WAITING" for a few seconds, then starts scrolling the text message.

- If there is no receivable text message or the unit cannot receive a text message properly, the display shows "NO TEXT."

## CD/MP3/WMA

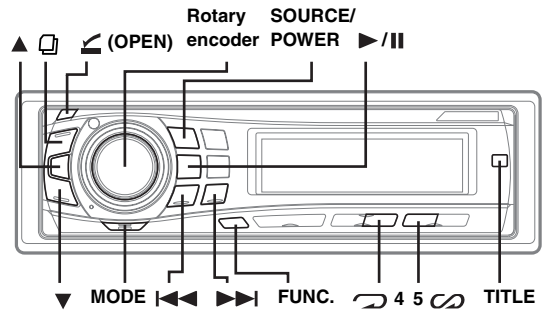

## Playback

- 1 Press (OPEN).**  
The front panel will open.
- 2 Insert a disc with the label side facing up.**  
The disc will be pulled into the unit automatically.

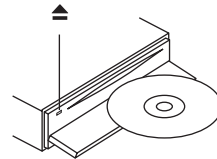

Close the front panel manually.

When a disc is already inserted, press **SOURCE/POWER** to switch to the DISC mode.

The mode will change every time the button is pressed.

TUNER → DISC → IPOD\*<sup>1</sup> → CHANGER\*<sup>2</sup> → TUNER

\*<sup>1</sup> Only when the iPod is connected.

\*<sup>2</sup> Only when the CD changer is connected

- 3 While playing back MP3/WMA, press ▲ or ▼ to select the desired folder.**  
Pressing and holding ▲ or ▼ will change folders continuously.
- 4 Press ◀◀ or ▶▶ to select the desired track (file).**  
**Returning to the beginning of the current track (file):**  
Press ◀◀.  
**Fast backward:**  
Press and hold ◀◀.  
**Advancing to the beginning of the next track (file):**  
Press ▶▶.  
**Fast forward:**  
Press and hold ▶▶.

**5 To pause playback, press ►/|| .**  
Pressing ►/|| again will resume playback.

**6 To eject the disc, press ▲, after pressing ⏏ (OPEN) to open the front panel.**

- Do not remove a CD during its eject cycle. Do not load more than one disc at a time. A malfunction may result from doing either.
- If the CD does not eject, press and hold ▲ for at least 2 seconds.
- The CD-player can play discs containing audio data, MP3 data and WMA data.
- A WMA format file that is protected by DRM (Digital Rights Management) cannot be played back on this unit.
- The track display for MP3/WMA data playback is the file numbers recorded on the disc.
- The playback time may not be correctly displayed when a VBR (Variable Bit Rate) recorded file is played back.
- If ▲ is pressed during M.I.X. DISC playback, new file will be played back in a random sequence. If ▼ is pressed, the beginning of the current file will be played back.

### MP3/WMA Play Display

The folder number and file number will be displayed as described below.

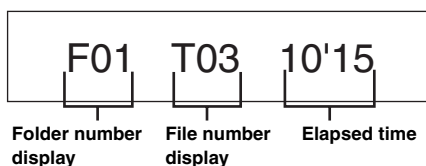

- Press **TITLE** to switch the display. Please see “Displaying the Text” (page 27) for information about display switching.
- If the folder number or file number is three digits, F or T becomes numbers of hundred rank.

## Repeat Play

Press **↶4** to play back repeatedly the track being played.

The track (file) will be played repeatedly.

Press **↶4** again and select RPT  to deactivate repeat play.

CD mode :

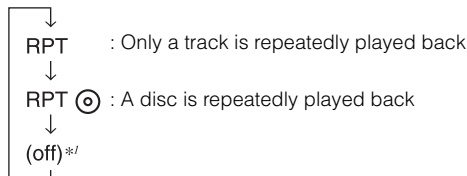

\*1 When a CD changer is connected

- If REPEAT is set to ON during M.I.X. (M.I.X. ONE) play in CD changer mode, M.I.X. will apply to the current disc only.

MP3/WMA mode :

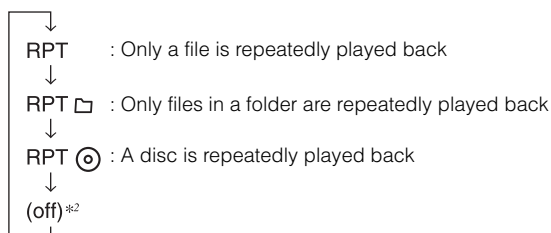

\*2 When an MP3 compatible CD changer is connected

- If a 6-disc CD changer or an MP3 compatible CD changer is connected:  
In CD changer mode, press **FUNC.** to illuminate the “FUNC” indicator, and go to the step above within 10 seconds.
- If a 12-disc CD changer is connected:  
In CD changer mode, press **FUNC.** twice to illuminate the “FUNC” indicator, and go to the step above within 10 seconds.



## M.I.X. (Random Play)

### Press 5 in the play or pause mode.

The tracks (files) on the disc will be played back in random sequence.

To cancel M.I.X. play, press 5  again.

Internal CD mode :

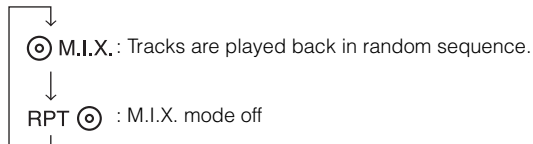

CD Changer mode :

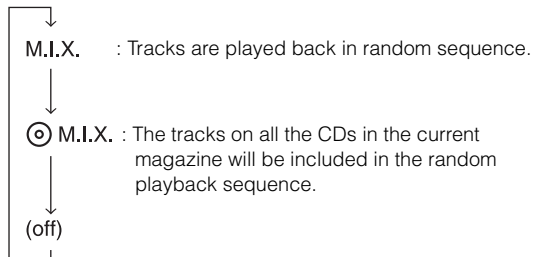

- If M.I.X. is set to ON during RPT  (REPEAT ALL) play in CD changer mode, M.I.X. will apply to the current disc only.

MP3/WMA mode :

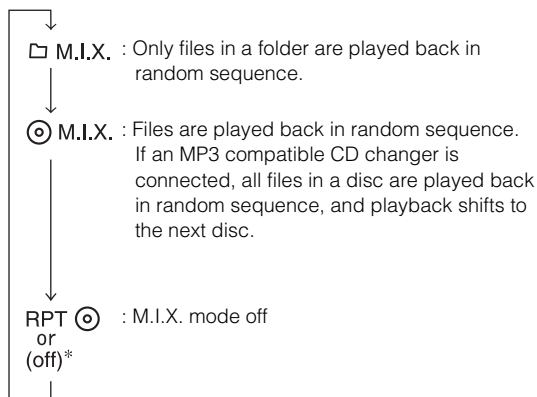

\* When an MP3 compatible CD changer is connected

- If a 6-disc CD changer or an MP3 compatible CD changer is connected:  
In CD changer mode, press **FUNC.** to illuminate the "FUNC" indicator, and go to the step above within 10 seconds.
- If a 12-disc CD changer is connected:  
In CD changer mode, press **FUNC.** twice to illuminate the "FUNC" indicator, and go to the step above within 10 seconds.

## Searching from CD Text

Tracks can be searched and played using the CD text on the disc. In the case of discs and changers that do not support text, searches can be made using the track numbers.

### 1 Press during play.

This will set the search mode.

### 2 Turn the **Rotary encoder** to select the desired track, then press **MODE**.

This will play the selected track.

- Press and hold  for at least 2 seconds in the search mode to cancel. Or, the search mode will be cancelled when an operation has not been performed in 10 seconds.
- CD text search cannot be made during M.I.X. play.

## File/Folder Name Search (concerning MP3/WMA)

You can display and search for the folder and file name while listening to the file currently being played back.

### Main Unit Operation



### 1 During MP3/WMA playback, press to activate the search mode.

### 2 Turn the **Rotary encoder** to select Folder Name Search mode or File Name Search mode, then press .

### Folder Name Search mode

### 3 Turn the **Rotary encoder** within 10 seconds to select the desired folder.

### 4 Press to play back the first file in the selected folder.

- Press and hold  for at least 2 seconds in the search mode to cancel. Or, the search mode will be cancelled when an operation has not been performed in 10 seconds.
- While in Folder Name Search mode, press  to switch to File Name Search mode.
- While in Folder Name Search mode, press **FUNC.** to return to the selecting search mode.
- If a disc contains only the root folder, Folder Name Search cannot be made.
- "ROOT" is displayed for the root folder which does not have folder name.
- Folder Name search cannot be made during M.I.X. play.

## File Name Search mode

- 3 Press ▲ or ▼ to select another Folder.
  - 4 Select the desired file by turning the Rotary encoder within 10 seconds.
  - 5 Press **MODE** to play back the selected file.
- Press and hold □ for at least 2 seconds in the search mode to cancel. Or, the search mode will be cancelled when an operation has not been performed in 10 seconds.
  - While in the File Name Search mode, press **FUNC.** to switch to the previous mode (Folder Search mode or the selecting search mode).
  - File Name search cannot be made during M.I.X. play.

## Remote Control Operation

- 1 Press and hold ►/||/SEARCH for at least 2 seconds during playback.  
The Folder Name list is displayed on the optional monitor screen.
  - 2 Press ▲ or ▼ to select a folder name, then press **ENT.**  
The File Name list of the selected folder is displayed.
  - 3 Press ▲ or ▼ to select a file name, then press **ENT.**  
The selected file is played back.
- When there are 8 or more names on the list, press ◀ or ▶ to change the page.
  - Press **RETURN** to deactivate the Search mode during the Folder Name Search mode.
  - While in File Name Search mode, press **RETURN** to switch to Folder Name Search mode.
  - While in Folder Name Search/File Name Search mode, press and hold ►/||/SEARCH for at least 2 seconds to cancel the Folder Name Search/File Name Search mode.

## About MP3/WMA

### CAUTION

Except for private use, duplicating audio data (including MP3/WMA data) or distributing, transferring, or copying it, whether for free or for a fee, without permission of the copyright holder is strictly prohibited by the Copyright Act and by international treaty.

### What is MP3?

MP3, whose official name is "MPEG-1 Audio Layer 3," is a compression standard prescribed by the ISO, the International Standardization Organization and MPEG which is a joint activity institution of the IEC.

MP3 files contain compressed audio data. MP3 encoding is capable of compressing audio data at extremely high ratios, reducing the size of music files to as much as one-tenth their original size. This is achieved while still maintaining near CD quality. The MP3 format realizes such high compression ratios by eliminating the sounds that are either inaudible to the human ear or masked by other sounds.

### What is WMA?

WMA, or "Windows Media™ Audio," is compressed audio data. WMA is similar to MP3 audio data and can achieve CD quality sound with small file sizes.

### Method for creating MP3/WMA files

Audio data is compressed by using MP3/WMA specified software. For details on creating MP3/WMA files, refer to the user's manual for that software.  
MP3/WMA files that can be played back by this device have the file extension "mp3" / "wma". Files with no extension cannot be played back. (WMA ver. 7.1, 8 and 9 are supported)

### Supported playback sampling rates and bit rates

#### MP3

Sampling rates: 32 kHz - 48 kHz  
Bit rates: 32 - 320 kbps

#### WMA

Sampling rates: 32 kHz - 48 kHz  
Bit rates: 32 - 320 kbps

Note that for sampling rates, this device's frame display (page 27) may not display correctly.  
This device may not play back correctly depending on sampling rates.

### ID3 tags/WMA tags

If tag data is in an MP3/WMA file, this device can display the title (track title), artist name, and album name ID3 tag/WMA tag data.

This device can only display single-byte alphanumeric characters and the underscore. For non-supported characters, "NO SUPPORT" is displayed.  
The number of characters may be limited, or not correctly displayed, depending on the tag information.

### Producing MP3/WMA discs

MP3/WMA files are prepared, then written to a CD-R or CD-RW (DVD-R/DVD-RW) using CD-R writing software. A disc can hold up to 1024 files/256 folders (including Root Folders).

### Media supported

The media that this device can play back are CD-ROMs, CD-Rs, and CD-RWs.

### Corresponding File Systems

This device supports discs formatted with ISO9660 Level 1 or Level 2.

Under the ISO9660 standard, there are some restrictions to remember.  
The maximum nested folder depth is 8 (including the root directory). The number of characters for a folder/file name is limited.  
Valid characters for folder/file names are letters A-Z (all caps), numbers 0-9, and '\_' (underscore).

This device also can play back discs in Joliet, Romeo, etc., and other standards that conform to ISO9660. However, sometimes the file names, folder names, etc., are not displayed correctly.

## Formats supported

This device supports CD-ROM, CD-ROM XA, Mixed Mode CD, Enhanced CD (CD-Extra) and Multi-Session.

This device cannot correctly play back discs recorded with Track At Once or packet writing.

## Order of files

The unit plays the files in the order that the writing software writes them. Therefore, the playing order may not be the same as the order you input. The playback order of the folders and files is as follows. However, the folder and file playback order differs from the folder no. and file no. indicated on the display.

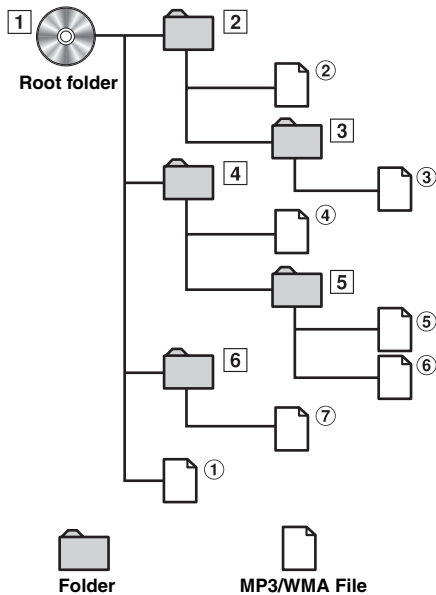

# DVD/Video CD

In this section, both remote control and main unit operation are described.

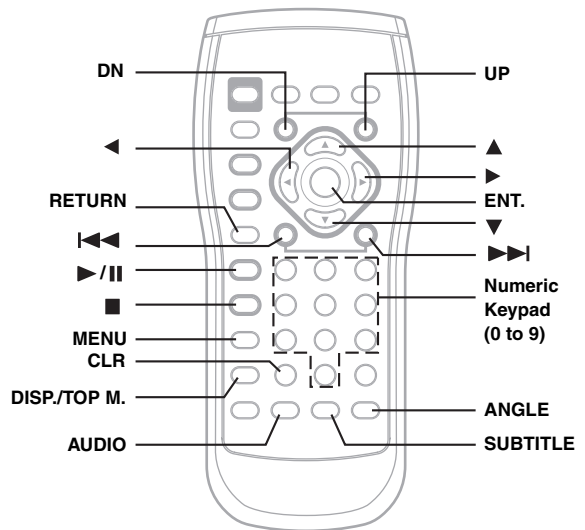
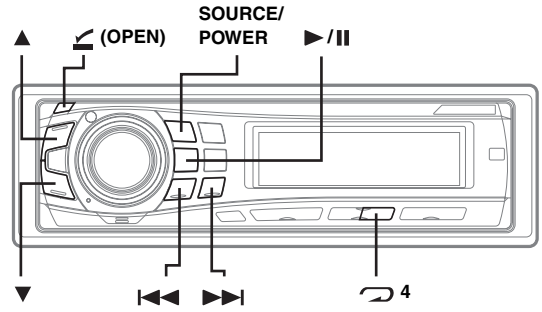

## Terminology

### Bit rate

This is the "sound" compression rate specified for encoding. The higher the bit rate, the higher the sound quality, but also the larger the files.

### Sampling rate

This value shows how many times per second the data is sampled (recorded). For example, music CDs use a sampling rate of 44.1 kHz, so the sound is sampled (recorded) 44,100 times per second. The higher the sampling rate, the higher the sound quality, but also the larger the volume of data.

### Encoding

Converting music CDs, WAVE (AIFF) files, and other sound files into the specified audio compression format.

### Tag

Song information such as track titles, artist names, album names, etc., written into MP3/WMA files.

MP3: ID3 tag

WMA: WMA tag

### Root folder

The root folder is found at the top of the file system. The root folder contains all folders and files.

- DVD/Video CD operations can be performed from both the remote control and the main unit. In this section, both remote control and main unit operations are described.
- To view DVD/Video CD, the optional TV monitor is required.
- DVA-9861Ri automatically changes the video output signal (NTSC or PAL), according to the disc. To set NTSC or PAL on the connected monitor, refer to the Owner's Manual of the monitor.

**Disc types that can be used for each heading are represented by the following marks.**

- DVD Commercial Audio discs can be used.
- DVD Commercial Video discs (used for the distribution of movies, etc.) or a DVD-R/DVD-RW/DVD+R/DVD+RW recorded in a video mode can be used.
- DVD-R/DVD-RW discs recorded in DVD-VR mode can be used.
- Video CD discs can be used.

## Playing a Disc DVD-A DVD-V DVD-VR VCD

### Caution

- Not all functions will operate for every DVD. See the individual DVD's instructions for details on the features supported.
- Fingerprints on a disc may adversely affect playback. If a problem occurs, remove the disc and check for fingerprints on the playback side. Clean the disc if necessary.
- When using the remote control, be careful to press only one button at a time. Pressing multiple buttons at the same time may cause erroneous operation.
- If you try to perform an invalid operation (based on the type of disc being played), the following mark is displayed on the monitor screen: 

### Play Position Memory Function

Even if you turn power off or switch the Ignition Key to OFF during playback or change the source, playback will continue from the point where playback stopped when the power is turned ON again.

#### 1 Press (OPEN).

The front panel will open.

#### 2 Insert a disc with the label side facing up.

The disc will be pulled into the unit automatically.

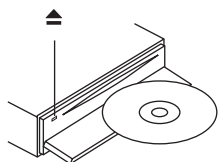

Close the front panel manually.

When a disc is already inserted, press SOURCE/POWER on the main unit to switch to the DISC mode.

The mode will change every time the button is pressed.

TUNER → DISC → IPOD\*<sup>1</sup> → CHANGER\*<sup>2</sup> → TUNER

\*<sup>1</sup> Only when the iPod is connected

\*<sup>2</sup> Only when the CD changer is connected

#### 3 To eject the disc, press , after pressing (OPEN) to open the front panel.





- Do not remove a disc during its eject cycle. Do not load more than one disc at a time. A malfunction may result from doing either.
- If the disc does not eject, press and hold  for at least 2 seconds.
- The reverse side of a double-sided DVD will not be played automatically. Remove the disc, turn it over, and reinsert it.
- Never insert map discs for navigation purposes as they could damage the equipment.
- Refer also to "DVD Setup" (pages 30 to 32).

## If a menu screen appears

On DVDs and video CDs with playback control (PBC), menu screens may appear automatically. If this happens, perform the operation described below to start playback.

- This operation is controlled using the remote control unit.
- For many discs, the menu screen can also be displayed by pressing **MENU**.

### DVD menu DVD-A DVD-V

Press , ,  or  to select the desired item, then press **ENT**.

- For some discs it is possible to select items directly from the menu screen using the **number keys** ("0" to "9").
- If the DVD-Audio disc is set to "VCAP", operation can be performed. (Refer to "Setting the DVD Audio Playback Mode" on page 35.)

### Video CD menu VCD

Use the **numeric keypad** ("0" to "9") to select the desired number, then press **ENT**.

- The menu screen does not appear when the PBC function is turned off. In this case, set VCD PLAY MODE to turn on the PBC function. For details, refer to "Setting the Video CD Play Mode" (page 35).

## Searching by Programme DVD-VR

- This operation is performed by the remote control unit.

#### 1 Press and hold **DISP./TOP M.** for at least 2 seconds while playing a DVD-VR disc.

The programme search list screen is displayed.

#### 2 Press or to select the desired programme, then press **ENT**.

The selected programme is played back.

- If **PLAY LIST** is selected, the playlist search list screen is displayed.

## Searching by Playlist DVD-VR

- This operation is performed by the remote control unit.

#### 1 Press **MENU** while playing DVD-VR disc.

The playlist search list screen is displayed.

#### 2 Press or to select the desired playlist, then press **ENT**.

The selected playlist is played back.

- Only discs containing a playlist can be used.
- If **PROGRAM LIST** is selected, the programme search list screen is displayed.

---

## Stopping Playback (PRE-STOP)

DVD-A DVD-V DVD-VR VCD

---

Press **■** during playback to stop playback. That position is stored in memory.

**1 During playback, press **■** on the remote control unit.**  
"PRE-STOP" is displayed.

**2 Press **▶/||** in the PRE-STOP mode.**  
Playback starts from the position at which it was stopped.

- For some discs, the position at which playback was stopped may not be accurate.
- When "VOFF" is set, PRE-STOP function is not available for the DVD Audio disc. (Refer to "Setting the DVD Audio Playback Mode" on page 35.)

---

## Stopping Playback

DVD-A DVD-V DVD-VR VCD

---

**During playback, press **■** twice on the remote control unit.**

"STOP" is displayed, and playback stops.

- Playback stops also when **■** is pressed for more than 2 seconds.
- Playback starts from the beginning when **▶/||** is pressed while playback is stopped.
- When VOFF is set, press **■** once to stop DVD audio playback (STOP). Refer to "Setting the DVD Audio Playback Mode" (page 35).

---

## Fast-forwarding/Fast-reversing

DVD-A DVD-V DVD-VR VCD

---

**DVD Audio (VCAP mode)\* / DVD Video / Video CD**

**1 During playback, press and hold **◀◀** (fast-reverse) or **▶▶** (fast-forward).**

When pressed for more than 1 second, the disc is forwarded/reversed at double speed.  
When held in 5 more seconds, the disc is forwarded/reversed at 8 times the normal speed.  
When held in 10 more seconds, the disc is forwarded/reversed at 21 times the normal speed.

**2 Release **◀◀** or **▶▶** to return to normal playback.**

**DVD Audio (VOFF mode)\***

**1 During playback or pause, press and hold **◀◀** (fast-reverse) or **▶▶** (fast-forward).**

When pressed for more than 1 second, the disc is forwarded/reversed at 21 times the normal speed.

**2 Release **◀◀** or **▶▶** to return to normal playback.**

\* Set "VCAP" (Video Capable Audio Player) or "VOFF" (Video OFF) in Custom Setup. For details, refer to "Setting the DVD Audio Playback Mode" (page 35).

- No sound is played during fast-forwarding/fast-reversing.
- Fast-forwarding/fast-reversing of only a track being played back can be made on the Video CD equipped with PBC (play back control).
- For DVDs and video CDs with playback control (PBC), the menu screen may reappear during fast-forwarding/fast-reversing.

---

## Finding the Beginning of Chapters or Tracks

DVD-A DVD-V DVD-VR VCD

---

**During playback, press **◀◀** or **▶▶**.**

The chapter/track switches each time the button is pressed, and playback of the selected chapter/track starts.

**▶▶**: Press this to start playback from the beginning of the following chapter or track.

**◀◀**: Press this to start playback from the beginning of the current chapter or track.

- Some DVDs do not have chapters.
- The beginning of a track may not be found on the Video CD equipped with PBC (playback control). Set VCD PLAY MODE to turn the PBC function off. Refer to "Setting the Video CD Play Mode" (page 35).
- During pause, operation can be performed for DVD Audio.

### Supplementary explanations

"Chapters" are divisions of movies or musical selections on DVDs.

"Tracks" are divisions of movies or musical selections on video and music CDs.

"Groups" associate a track (one song) with other tracks stored on a DVD-Audio.

Group playback differs, depending on the disc.

"Playlists" specify a range of images and their playback order.

- Only discs containing a playlist can be used.

## Selecting Programme/Playlist

During playback or pause, press **▲**, **▼** on the unit or **UP**, **DN** on the remote control to select the previous or next programme/playlist.

The programme/playlist switches each time the button is pressed, and playback of the selected programme/playlist starts.

- ▲**, **UP**: Press this to start playback from the beginning of the following programme or playlist.
- ▼**, **DN**: Press this to start playback from the beginning of the previous programme or playlist.

- Only when a playlist is managed on the disc, playlist can be selected and operation can be performed.

## Playing Still Frames (pausing)

**1** During playback, press **▶/II**.

**2** Press **▶/II** to resume playback.

- No sound is played during the still mode.
- The image or sound may stop temporarily when playback starts from the pause mode. This is not a malfunction.

## Forward/reverse frame-by-frame Playback

**1** In the pause mode, press **◀◀** or **▶▶**.

The picture advances or reverses by one frame each time the button is pressed.

**2** Press **▶/II** to resume normal playback.

- No sound is output during forward/reverse frame-by-frame playback.
- For DVD-VR and video CD, reverse frame-by-frame playback is not available.

## Slow Motion Playback

**1** When **◀◀** or **▶▶** is pressed and held in while in the pause mode, the 1/8th speed slow motion playback mode is set.

When held in for 5 more seconds, the slow motion speed switches to 1/2 the normal speed.

**2** Release **◀◀** or **▶▶** to pause, and press **▶/II** to playback.

- No sound is played during slow motion playback.
- Slow playback is not available when playing back a slide show.
- 1/2 and 1/8 are approximate speeds. The actual speed differs from disc to disc.
- For DVD-VR and video CD, reverse slow motion playback is not available.

## Searching by Title Number

Use this function to easily find positions on the DVD using the DVD's title.

- This operation is performed by the remote control unit.

**1** When playback stops, input the number of the title you want to play using the numeric keypad ("0" to "9").

**2** Press **ENT**.

Playback starts from the selected title number.

- While in PRE-STOP, this function finds the beginning of the chapter by its number.
- This function cannot be used on discs on which no title numbers are recorded.
- Press **CLR** to delete the last digit in the title number. Press and hold **CLR** for at least 2 seconds to cancel the input mode.
- The playback starts automatically for two digit title numbers even if **ENT** in procedure 2 is not pressed.

## Searching by Group Number

A group number on a DVD identifies various audio sections similar to chapters for video. Use this function to easily find positions on the DVD using its group number.

- This operation is performed by the remote control unit.

When playback stops, input the number of the group you want to play using the numeric keypad ("0" to "9").

Playback starts from the selected group number.

- While in PRE-STOP, this function finds the beginning of the track by its number. For operation, refer to "Searching Directly by Chapter or Track Number" (page 22).
- This function cannot be used on discs on which no group numbers are recorded.

## Searching by Programme or Playlist Number

Use this function to easily find positions on the DVD using the DVD's programmes/playlists.

- This operation is performed by the remote control unit.

**1** When playback stops, input the number of the programme or playlist you want to play using the numeric keypad ("0" to "9").

**2** Press **ENT**.

Playback starts from the selected programme or playlist number.

- While in PRE-STOP, this function finds the beginning of the chapter by its number.
- This function cannot be used on discs on which no programme or playlist numbers are recorded.
- Press **CLR** to delete the last digit in the programme/playlist number. Press and hold **CLR** for at least 2 seconds to cancel the input mode.
- Depending on the number of digits input, playback may start automatically even if **ENT** is not pressed in step 2.

## Searching Directly by Chapter or Track Number

(DVD-A) (DVD-V) (DVD-VR) (VCD)

Use this function to easily move to the beginning of the chapters or tracks on the disc.

- This operation is performed by the remote control unit.

**1** During playback, pre-stop or pause, input the chapter or track number you want using the numeric keypad (“0” to “9”).

**2** Press **ENT**.

Playback starts from the selected chapter or track.

- This function cannot be used on discs on which no chapter numbers are recorded.
- During stop, search can be made for Video CD.
- The beginning of a track number cannot be directly found on the Video CD equipped with PBC (playback control). Set VCD PLAY MODE to turn the PBC function off. Refer to “Setting the Video CD Play Mode” (page 35).
- Depending on the number of digits input, playback may start automatically even if **ENT** is not pressed in step 2.
- Press **CLR** to delete the last digit in the chapter/track number. Press and hold **CLR** for at least 2 seconds to cancel the input mode.

## Repeat Playback

(DVD-A) (DVD-V) (DVD-VR) (VCD)

Use this function to play the disc’s titles, chapters, tracks, etc., repeatedly.

During playback, press **↻** 4 on the main unit.

The repeat mode switches each time the button is pressed.

### DVD Audio (VCAP mode)\*<sup>1</sup>

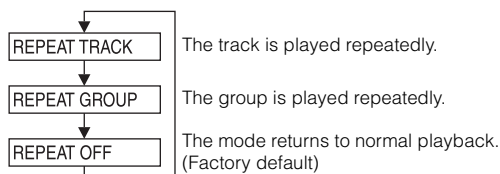

### DVD Audio (VOFF mode)\*<sup>1</sup>

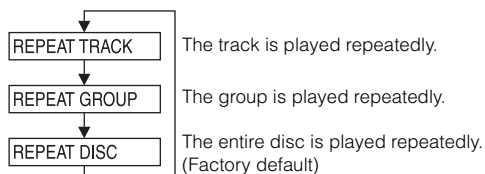

### DVD Video

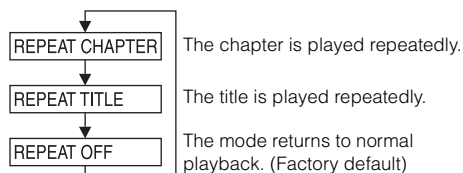

### DVD-VR (while playing back programme)

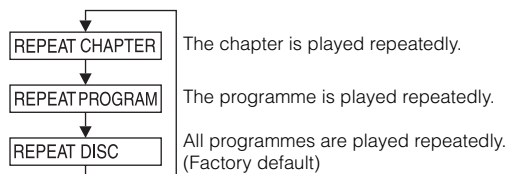

### DVD-VR (while playing back Playlist)

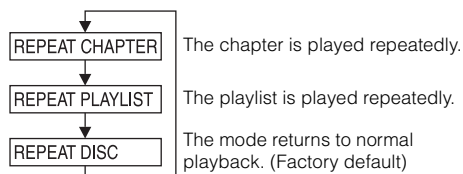

### VIDEO CD

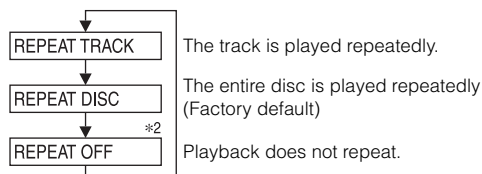

\*<sup>1</sup> Set “VCAP” or “VOFF” in Custom Setup. For detail, refer to “Setting the DVD Audio Playback Mode” (page 35).

\*<sup>2</sup> Displayed only in the changer mode.

- The track/disc repeat modes cannot be used on video CDs with playback control (PBC). Set VCD PLAY MODE to turn the PBC function off. Refer to “Setting the Video CD Play Mode” (page 35).
- For some discs it is not possible to switch the repeat mode.
- During DVD Video playback, pressing and holding **↻** 4 for at least 2 seconds will change the unit to REPEAT OFF.



## Switching the Audio Tracks

DVD-A DVD-V DVD-VR VCD

For discs with multiple audio or audio languages, you can switch the audio language temporarily during playback.

- This operation is performed by the remote control unit.

### During playback, press **AUDIO**.

The sound switches between the alternate audio tracks recorded on the disc each time the button is pressed.

- The selected audio track becomes the default setting every time the power is turned on or the disc is replaced. If a disc does not include the language you selected for the default audio track, the disc's default language is selected instead. Refer to "Setting the language" (page 31).
- Not all discs will allow changing the alternate audio tracks during playback. In these cases, select audio tracks from the DVDs menu.
- There may be a delay before the selected alternate track begins to play.

## DVD-VR/Video CDs with multiplex audio

### DVD-VR

#### During playback, press and hold **AUDIO** for at least 2 seconds.

The left and right channels will be output as shown below, each time the button is pressed.

LR → LL → RR → LR

### Video CD

#### During playback, press **AUDIO**.

The left and right channels will be output as shown below, each time the button is pressed.

LR → LL → RR → LR

## Switching the Angle

DVD-A DVD-V

On DVDs in which scenes have been filmed from multiple angles, the angle can be switched during playback.

- This operation is performed by the remote control unit.

### During playback, press **ANGLE**.

The angle switches between the angles recorded on the disc each time the button is pressed.

- Some time may be required for the angle to change.
- Depending on the disc, the angle may switch in one of two ways.
  - Seamless: The angle switches smoothly.
  - Non-seamless: When the angle is switched, a still picture is displayed first, after which the angle switches.
- If the DVD-Audio disc is set to "VCAP", operation can be performed. (Refer to "Setting the DVD Audio Playback Mode" on page 35.)

## Switching the Subtitles (subtitle language)

DVD-A DVD-V DVD-VR

With multiple subtitle language DVDs, the subtitle language can be switched during playback, or subtitles can be hidden.

- This operation is performed by the remote control unit.

### During playback, press **SUBTITLE**.

The subtitle switches between the languages recorded on the disc and OFF each time the button is pressed.

During DVD-VR playback, the display of the subtitle is set to ON or OFF.

- There may be a delay before the selected subtitle appears.
- Not all discs will allow changing the subtitles during playback. In these cases, select subtitles from the DVD's menu.
- The selected subtitle language becomes the default setting every time the power is turned on or the disc is replaced. If a disc does not include that language, the disc's default language is selected instead. Refer to "Setting the language" (page 31).
- For some discs, the subtitles will be displayed even when this is set to off.
- If the DVD-Audio disc is set to "VCAP", operation can be performed. (Refer to "Setting the DVD Audio Playback Mode" on page 35.)

### Tips

#### Switching from the disc menu.

For some discs, the audio language, angle and subtitles can be switched from the disc menu.

### DVD Video

1. Press MENU, select the item, then press ENT.
2. Press ▲, ▼, ◀ or ▶ to select the language or angle, then press ENT.  
(For some discs, they can be selected using the numeric keypad "0" to "9" while the language or the angle menu is displayed.)

### DVD Audio

1. Press and hold DISP/TOP M., select the item, then press ENT.
  2. Press ▲, ▼, ◀ or ▶ to select the language or angle, then press ENT.  
(For some discs, they can be selected using the numeric keypad "0" to "9" while the language or the angle menu is displayed.)
- If the DVD-Audio disc is set to "VCAP", operation can be performed. (Refer to "Setting the DVD Audio Playback Mode" on page 35.)



## Displaying the Disc Status

DVD-A DVD-V DVD-VR VCD

Use the procedure described below to display the status (title number, chapter number, etc.) of the currently playing DVD on the monitor screen.

- This operation is performed by the remote control unit.

### During playback, press **DISP./TOP M.**

The playback status is displayed.

The playback status display closes when **DISP./TOP M.** is pressed again.

### DVD Audio display example

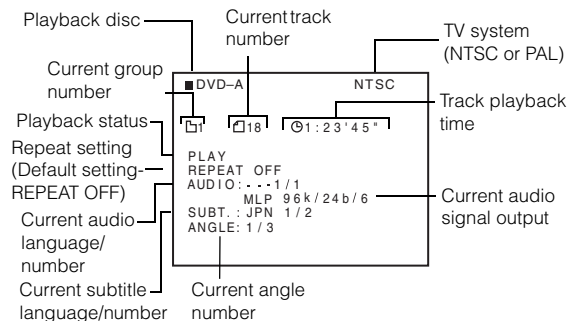

- If the DVD-Audio disc is set to "VCAP", operation can be performed. (Refer to "Setting the DVD Audio Playback Mode" on page 35.)

### DVD Video display example

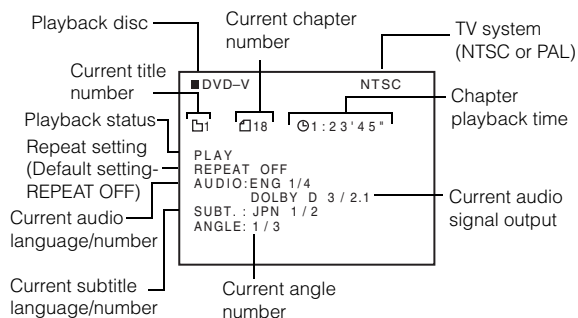

### DVD-VR display example

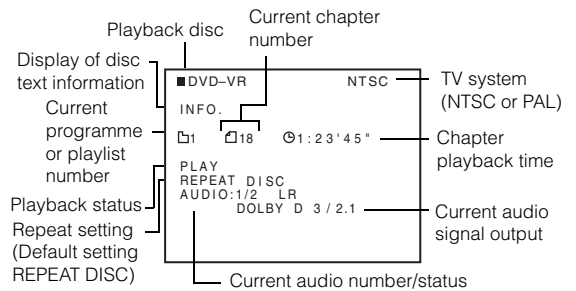

### Video CD display example

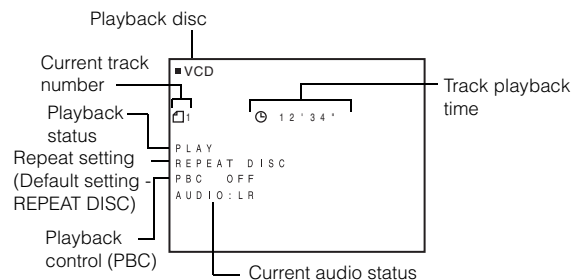

- When PBC is set to ON, the current track number and track playback time is not displayed.

## Scroll to Move the Page Forward or Back

DVD-A

"Page" is still image stored on a DVD-Audio disc.

- This operation is performed by the remote control unit.

**During playback, press and hold 1 for at least 2 seconds to display the previous still image. Pressing and holding 2 for at least 2 seconds will display the next still image. Pressing and holding 3 for at least 2 seconds will display the home page.**

- For DVD-Audio discs without Pages, depending on the DVD-Audio disc, the "Page" function may not be operable if images are in slide show form.
- If the DVD-Audio disc is set to "VCAP", operation can be performed. (Refer to "Setting the DVD Audio Playback Mode" on page 35.)

# Sound Setting

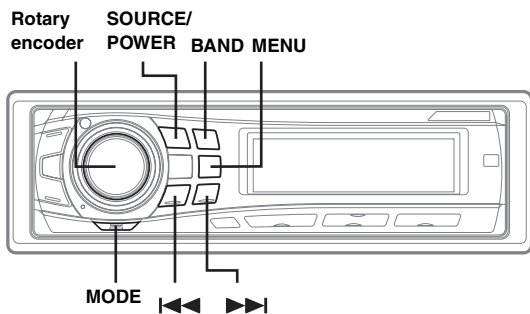

## Adjusting Bass/Treble/Balance (Between Left and Right)/Fader (Between Front and Rear)/Deaf

- 1 Press **MODE** repeatedly to choose the desired mode.

Each press changes the modes as follows:

BASS → TREBLE → SUBW\* → BALANCE → FADER → DEFEAT → VOLUME → BASS

Bass Level: -7 ~ +10

Treble Level: -7 ~ +7

Subwoofer : 0 ~ +15

Balance : L15 ~ R15

Fader : R15 ~ F15

Deaf : ON/OFF

Volume : 0 ~ 35

- If **MODE** is not pressed within 5 seconds after selecting the **BASS**, **TREBLE**, **BALANCE**, **FADER**, **DEFEAT** or **SUBW** mode, the unit automatically returns to normal mode.

\* When the subwoofer mode is set to **OFF**, its level cannot be adjusted.

- 2 Turn the **Rotary encoder** until the desired sound is obtained in each mode.

By setting Deaf ON, previously adjusted settings of **BASS** and **TREBLE** will return to the factory defaults.

- Depending on the connected devices, some functions and display indications do not work.

## Setting the Bass Control

You can change the Bass Frequency emphasis to create your own tonal preference.

- 1 Press **MENU** to select the **BASS ENGINE** mode, then press **MODE**.

BASS ENGINE → SETUP → RETURN (OFF) → BASS ENGINE

- 2 Press **◀** or **▶** to select the **BASS** (bass Centre frequency) control mode.

BASS ↔ TREBLE

## Setting the Bass Centre Frequency

- 3-1 Press **SOURCE/POWER** to select the desired bass centre frequency.

80Hz → 100Hz → 120Hz → 60Hz → 80Hz

Emphasizes the displayed bass frequency ranges.

## Setting the Bass Bandwidth

- 3-2 Press **BAND** to select the desired bass bandwidth.

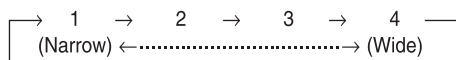

Changes the boosted bass bandwidth to wide or narrow. A wide setting will boost a wide range of frequencies above and below the centre frequency. A narrower setting will boost only frequencies near the centre frequency.

## Setting the Bass Level

### 3-3\* Turn the **Rotary encoder** to select the desired bass level (-7~+10).

You can emphasize or weaken the bass level.

### 4 Press **MENU** to select **RETURN**.

After 2 seconds, the unit returns to normal mode.

Pressing and holding **MENU** for at least 2 seconds will return to normal mode.

- If no operation is performed within 60 seconds, the bass control setting will be turned off automatically.
- The bass level settings will be individually memorized for each source (FM, MW (LW), CD, etc.) until the setting is changed. The bass frequency and bass band width settings adjusted for one source are effective for all other sources (FM, MW (LW), CD etc.).
- Depending on the connected devices, some functions and display indications do not work. However, Bass Level is still adjustable if an audio processor with the Bass function is connected.
- This function is inoperable when **DEFEAT** is set to **ON**.
- While in the bass adjusting mode, **TREBLE CONTROL** adjusting mode can be recalled by pressing **◀◀** or **▶▶**.

\* The adjustment can also be made by pressing **MODE**. Refer to "Adjusting Bass/Treble/Balance (Between Left and Right)/Fader (Between Front and Rear)/Defeat" (page 25).

### Bass level indicator's display

Bass level is usually displayed.

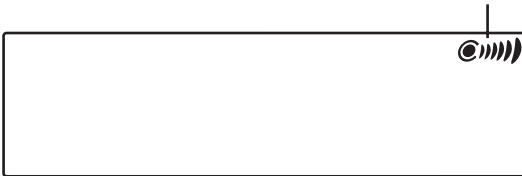

## Setting the Treble Control

You can change the Treble Frequency emphasis to create your own tonal preference.

### 1 Press **MENU** to select the **BASS ENGINE** mode, then press **MODE**.

BASS ENGINE → SETUP → RETURN (OFF) → BASS ENGINE

### 2 Press **◀◀** or **▶▶** to select the **TREBLE** (treble Center frequency) control mode.

BASS ↔ TREBLE

## Setting the Treble Centre Frequency

### 3-1 Press **SOURCE/POWER** to select the desired treble Centre frequency.

10.0kHz → 12.5kHz → 15.0kHz → 7.5kHz → 10.0kHz  
Emphasizes the displayed Treble frequency ranges.

## Setting the Treble Level

### 3-2\* Turn the **Rotary encoder** to select the desired treble level (-7~+7).

You can emphasize the treble level.

### 4 Press **MENU** to select **RETURN**.

After 2 seconds, the unit returns to normal mode.

Pressing and holding **MENU** for at least 2 seconds will return to normal mode.

- If no operation is performed within 60 seconds, the treble control setting will be turned off automatically.
- The treble level settings will be individually memorized for each source (FM, MW (LW), CD, etc.) until the setting is changed. The Treble frequency settings adjusted for one source are effective for all other sources (FM, MW (LW), CD, etc.).
- Depending on the connected devices, some functions and display indications do not work. However, Treble Level is still adjustable if an audio processor with the Treble function is connected.
- This function is inoperable when **DEFEAT** is set to **ON**.
- While in the treble adjusting mode, **BASS CONTROL** adjusting mode can be recalled by pressing **◀◀** or **▶▶**.

\* The adjustment can also be made by pressing **MODE**. Refer to "Adjusting Bass/Treble/Balance (Between Left and Right)/Fader (Between Front and Rear)/Defeat" (page 25).

## Turning Loudness On/Off

Loudness introduces a special low- and high-frequency emphasis at low listening levels. This compensates for the ear's decreased sensitivity to bass and treble sound.

**Press and hold the **MODE** for at least 2 seconds to activate or deactivate the loudness mode.**

"LD" indicator lights.

# Other Functions

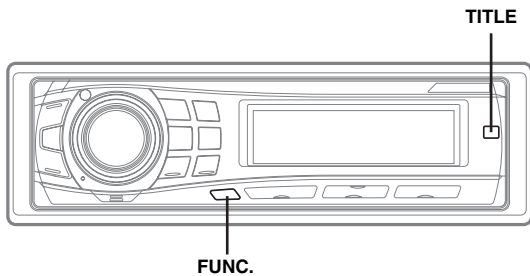

## Displaying the Text

Text information, such as the disc name and the track name, will be displayed if playing a CD text compatible disc. It is also possible to display the folder name, the file name, and the tag, etc., while playing MP3/WMA files.

### Press **TITLE**.

The display will change every time the button is pressed.

#### The display in Radio mode:

##### **If there is PS (Programme Service NAME)**

PS (Programme Service Name)\*<sup>1</sup> → Clock → Radio Text → PS (Programme Service Name)

##### **If there is no PS (Programme Service Name)**

FREQUENCY → Clock → Radio Text → FREQUENCY

#### The display in CD mode:

TRACK NO./ELAPSED TIME → TRACK NO./CLOCK → TEXT (DISC NAME)\*<sup>2</sup> → TEXT (TRACK NAME)\*<sup>2</sup> → TRACK NO./ELAPSED TIME

#### The display in MP3/WMA mode:

FOLDER NO./FILE NO./ELAPSED TIME → FOLDER NO./FILE NO./CLOCK → FOLDER NAME\*<sup>3</sup> → FILE NAME\*<sup>3</sup> → ARTIST NAME\*<sup>4</sup> → ALBUM NAME\*<sup>4</sup> → SONG NAME\*<sup>4</sup> → FRAME\*<sup>5</sup> → FOLDER NO./FILE NO./ELAPSED TIME

\*<sup>1</sup> Pressing and holding **TITLE** for at least 2 seconds in the PS display mode, "FREQUENCY" will be displayed for 5 seconds.

\*<sup>2</sup> Displayed during playback of a disc with CD Text.

If there is no Text (Disc Name or Track Name), "DISC TEXT"/"TRACK TEXT" is displayed. If there is a changer, "D TEXT"/"T TEXT" is displayed.

\*<sup>3</sup> "ROOT" is displayed for the folder name of the root folder which does not have folder name.

If there is no folder name or file name, "FOLDER"/"FILE" is displayed.

\*<sup>4</sup> ID3 tag/WMA tag

If an MP3/WMA file contains ID3 tag/WMA tag information, the ID3 tag/WMA tag information is displayed (song name, artist name, and album name). All other tag data is ignored.

If there is no tag information, "ARTIST"/"ALBUM"/"SONG" will be displayed.

If "SCROLL AUTO" is set in "Scroll Setting (TEXT SCROLL)" (page 29), tag information will automatically be scrolled.

\*<sup>5</sup> The recording sampling rate and bit rate of the MP3/WMA file are displayed. A WMA file of variable bit rate displays the average bit rate.

• You cannot display title or text information for DVD or video CD.

## About the indication display

When displaying Text, the following indicators are lit according to the mode.

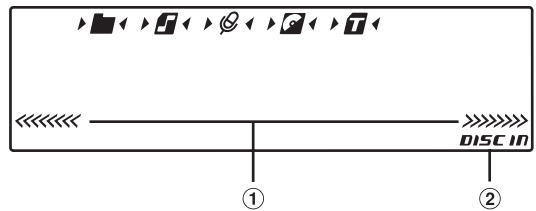

① The position of a song being played back is shown lit in the total number of songs shown. The display example is as shown below. Also lights when operation, such as fast forward, etc., is performed.

② Lights up when a disc is inserted

## Song position display example



• For example, when the 5th of 10 songs in the disc is played back, "◀◀◀ ▶▶▶" is displayed.

Indicator/ Mode	CD Mode	MP3/WMA Mode	iPod Mode
	—	While displaying Folder Name	—
	—	While displaying File Name	—
	—	While displaying Artist Name*	While displaying Artist Name*
	While displaying Text (Disc Name)	While displaying Album Name*	While displaying Album Name*
	While displaying Text (Track Name)	While displaying Song Name*	While displaying Song Name*

\*Tag information

## About "Text"

### Text:

Text compatible CDs contain text information such as the disc name and track name. Such text information is referred to as "text."

- Some characters may not be displayed correctly with this device, depending on the character type.
- The CD changer must also be CD Text compatible for the Text information to be displayed.

- When the Scroll Setting (page 29) is set to “SCROLL MANU,” press and hold **TITLE** for at least 2 seconds to scroll the Text information only once (TEXT DISPLAY, FOLDER NAME DISPLAY, FILE NAME DISPLAY or TAG DISPLAY mode).
- “NO SUPPORT” is displayed when the desired text information cannot be displayed on this unit.
- The text or tag information may not be correctly displayed, depending on the contents.

## Displaying Time

Press **TITLE** repeatedly until the time is displayed.

Each press changes the display.  
For details, see “Displaying the Text” (page 27).

- Selecting any tuner or CD function while in the clock priority mode will interrupt the time display momentarily. The function selected will be displayed for about 5 seconds before the time returns to the display.
- When the power is off but the ignition key is on, press **TITLE** to display the time.

## Blackout Mode On and Off

When Blackout mode is turned on, the display and button illumination will turn off to reduce power consumption. This additional power enhances the sound quality.

Press and hold **FUNC.** for at least 2 seconds to activate the blackout mode.

The display and button illumination will turn off.

- If any button on the unit is pressed during the blackout mode, the function will be displayed for 5 seconds to show the operation before returning to Blackout mode.

To cancel Blackout mode, press and hold **FUNC.** for at least 2 seconds

## Setting the Wallpaper

A data file downloaded from the ALPINE Owner’s website is written to a CD-R/CD-RW disc, and automatically uploaded when the disc is inserted into the DVA-9861Ri.

The wallpaper file can be saved and displayed as long as a disc is not inserted, or while playing a CD/MP3/WMA audio, or if a DVD disc is stopped.

- If several files are stored in a disc, only the first file will be stored on the unit.

Insert a CD-R/CD-RW disc containing data.

After sensing the disc, the data file is updated.

- Up to 2 files can be stored on this unit. If a third file is downloaded, the first file is overwritten and new one memorized.
- To change the wallpaper, press and hold **ENT.** on the remote control unit for at least 2 seconds while disc is not inserted, or while **PRE-STOP** or **STOP** is set in disc mode.
- Even if the battery power cable is removed, the downloaded data is not cleared.

# SETUP

You can flexibly customize the unit to suit your own preferences and usage. Choose the SETUP menu from Sound Customizing, Visual Customizing, etc., to select your desired setting.

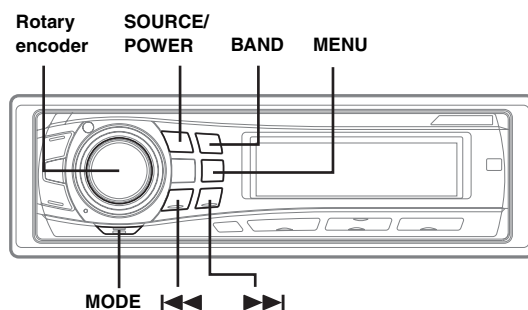

A typical SETUP procedure is shown in steps 1 to 4 as follows. See below for further information about each SETUP menu.

- 1 Press **MENU** to select the SETUP mode, then press **MODE**.

BASS ENGINE → SETUP → RETURN (OFF) → BASS ENGINE  
SETUP mode is activated.

- 2 Press **◀◀** or **▶▶** to select the desired SETUP menu, then press **MODE**.  
(e.g. Select SUBWOOFER)

FM LEVEL ↔ RDS REGIONAL\*<sup>1</sup> ↔ PI SEEK\*<sup>2</sup> ↔ ALERT PTY31\*<sup>3</sup> ↔ AUTO CLOCK\*<sup>4</sup> ↔ ILLUMINATION ↔ DIMMER ↔ SUBWOOFER ↔ (SUBW SYSTEM)\*<sup>5</sup> ↔ PLAY MODE ↔ SCROLL TYPE ↔ TEXT SCROLL ↔ INT MUTE ↔ AUX IN ↔ (AUX NAME)\*<sup>6</sup> ↔ POWER IC ↔ OPT OUTPUT ↔ DEMO ↔ FM LEVEL

\*<sup>1</sup> Refer to “Receiving RDS Regional (Local) Stations” (page 11).

\*<sup>2</sup> Refer to “PI SEEK Setting” (page 12).

\*<sup>3</sup> Refer to “Setting PTY31 (Emergency Broadcast) reception” (page 12).

\*<sup>4</sup> Refer to “Setting the Time to automatically Adjust” (page 12).

\*<sup>5</sup> Displayed only when SUBW is ON.

\*<sup>6</sup> Displayed only when AUX is ON.

- 3 Turn the **Rotary encoder** to change the setting.  
(e.g. Select SUBW ON or SUBW OFF.)

- 4 Press **MENU** to select RETURN.

After 2 seconds, the unit returns to normal mode.

Pressing and holding **MENU** for at least 2 seconds will return to normal mode.

## Sound Customizing

### Adjusting Source Signal Levels

#### **FM-LEVEL HI (Initial setting) / FM-LEVEL LOW**

If the difference in volume level between the CD player and FM radio is too great, adjust the FM signal level.

### Subwoofer On and Off

#### **SUBW ON (Initial setting) / SUBW OFF**

When the subwoofer is on, perform the steps below to adjust the subwoofer output level.

- 1 Press **MODE** repeatedly to select the SUBW mode.  
BASS → TREBLE → SUBW → BALANCE → FADER → DEFEAT → VOLUME → BASS
- 2 Adjust the level by turning the Rotary encoder.

### Setting the Subwoofer System

#### **SUBW SYS1 (Initial setting) / SUBW SYS2**

Select either SYS1 or SYS2 for the desired subwoofer effect.

- SUBW SYS1: Subwoofer level changes according to the main volume setting.
- SUBW SYS2: Subwoofer level change is different from the main volume setting. For example, even at low volume settings, the subwoofer is still audible.

## Visual Customizing

### Changing Lighting Colour

#### **ILLUMI BLUE (Initial setting) / GREEN / AMBER / RED**

You can change the lighting colour of the following six buttons: SOURCE/POWER, BAND, ►/||/TUNE/A.ME, MENU, ◀◀ and ▶▶.

BLUE ↔ GREEN ↔ AMBER ↔ RED

- According to the lighting colour of the above six buttons, the colour of the other buttons also changes.  
When the colour of the six buttons is BLUE/AMBER/RED, the colour of the others is RED. When the colour of the six buttons is GREEN, the others are also GREEN.

### Dimmer Control

#### **DIMMER AUTO (Initial setting) / DIMMER MANU**

Set the DIMMER control to AUTO to decrease the illumination brightness of the unit with the head lights of the vehicle ON. This mode is useful if you feel the unit's backlighting is too bright at night.

- If your vehicle should have a dimmer control for the dashboard lights, never connect the DIMMER cable (orange) of the radio to this dimmer control.

### Scroll Type Setting

#### **SCROLL TYPE1 / SCROLL TYPE2 (Initial setting)**

Choose from two scrolling methods.  
Select the type you prefer.

- SCROLL TYPE1: The characters scroll sequentially, appearing from the right side of the display.
- SCROLL TYPE2: The characters are displayed one by one, and disappear one by one from the left side of the display after the screen is filled up with the characters.

### Scroll Setting (TEXT SCROLL)

#### **SCROLL AUTO / SCROLL MANU (Initial setting)**

This CD player can scroll the disc and track names recorded on CD-TEXT discs, as well as the text information of MP3/WMA files, folder names, and tags.

- SCROLL AUTO: The CD text information, the text information of folder and file names, and the tags are scrolled automatically.
- SCROLL MANU: The display is scrolled when a disc is loaded or when a track is changed, etc.

- The unit scrolls CD text names, folder names, file names or tag display.

### Demonstration

#### **DEMO ON / DEMO OFF (Initial setting)**

This unit has a demonstration feature for the display.

- To quit Demo mode, set to DEMO OFF.

## External Device

### Connecting an MP3 Changer (PLAY MODE)

#### **CDDA (Initial setting) / CDDA/MP3**

Perform this setting when connecting MP3 changer. MP3 changer can playback CDs containing both CD and MP3 data. However, in some situations (some enhanced CDs), playback may be difficult. For these special cases, you can select playback of CD data only. When a disc contains both CD or the MP3 data, playback starts from the CD data portion of the disc.

- CDDA : Only CD data can be played back.
- CDDA/MP3 : Both CD data and MP3 file tracks can be played back.

- Change discs after performing this setting.

### Turning Mute Mode On/Off (INT MUTE)

#### **MUTE ON (Initial setting) / MUTE OFF**

If a device having the interrupt feature is connected, audio will be automatically muted whenever the interrupt signal is received from the device.

### Setting the AUX Mode (V-Link)

#### **AUX IN ON / AUX IN OFF (Initial setting)**

You can input TV/video sound by connecting an optional Ai-NET/RCA Interface cable (KCA-121B) or Versatile Link Terminal (KCA-410C) to this component.

You can change the AUX name display when AUX IN ON is set. Select the AUX name by pressing ◀◀ or ▶▶, then press **MODE**. Then turn the **Rotary encoder**.

If the KCA-410C is connected, it is possible to select two AUX names.

- Via KCA-410C, up to 2 external devices with RCA output can be connected. In this case, press **SOURCE/POWER** to select AUX mode and then press **BAND** to select your desired device.

## Connecting to an External Amplifier

### POWER IC ON (Initial setting) / POWER IC OFF

When an external amplifier is connected, sound quality can be improved by stopping the power supply of the built-in amplifier.

**POWER IC OFF** : Use this mode when the front and rear pre-amplifier of the unit are used to drive an external amplifier connected to the speakers. In this setting, the head unit's internal amplifier has no output to drive speakers.

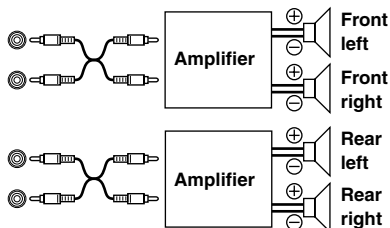

**POWER IC ON** : The speakers are driven by the built-in amplifier.

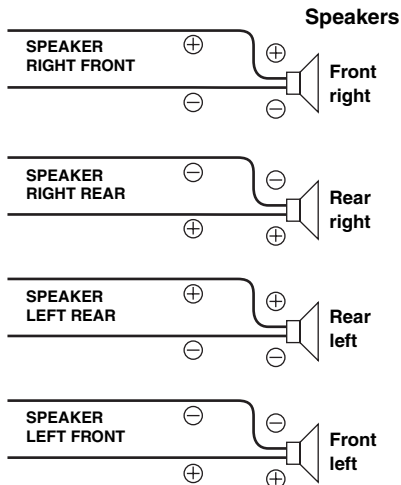

- No sound is produced by the system when the power output is set to OFF.
- If an external amplifier only for the subwoofer is connected, set to ON.

## Setting the Digital Output

### OPT OUT ON / OPT OUT OFF (Initial setting)

To connect to a digitally to an audio processor, the optical digital output must be turned ON.

- If DVD Audio is used, sound is output via Ai-NET regardless of this setting.

# DVD Setup

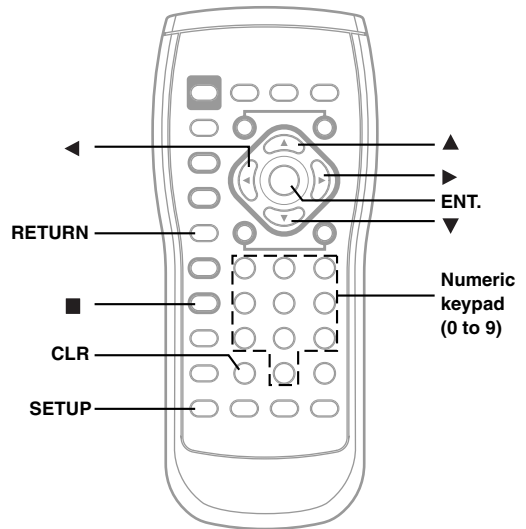

## DVD Setup Operation

- DVD Setup Operation is performed by the remote control unit.

The following 4 steps are common to each of the DVD settings. Refer to the specific section for details.

- 1 Press SETUP before inserting a disc, or when in stop mode.**

The setup menu appears on the monitor.

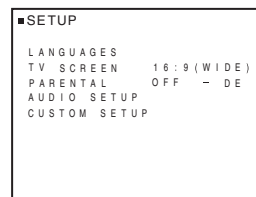

- 2 Press ▲ or ▼ to select your desired setting item, then press ENT.**

Further items will be displayed.

### Setting items:

LANGUAGES / TV SCREEN / PARENTAL / AUDIO SETUP\*<sup>1</sup> / CUSTOM SETUP\*<sup>2</sup>

\*<sup>1</sup> Refer to "Audio Setup" on page 33.

\*<sup>2</sup> Refer to "Custom Setup" on page 35.

- 3 Press ▲, ▼, ◀ or ▶ to change the setting, then press ENT.**

- 4 When the setting is complete, press SETUP.**

The setup returns to normal mode.



- When settings are changed, old settings are overwritten. Make a note of the current settings before making changes. If the vehicle's battery is disconnected, the settings will be cleared and will return to the factory settings.

## Setting the language

The audio language, subtitle language and menu language can be set according to your preferences. Once set, this becomes the default language. This function is convenient when you always want to listen in English. (Not all discs allow changing the default language. If not, the factory default language applies.)

### Setting item: LANGUAGES

Further setting items: AUDIO / SUBTITLE / MENU

#### AUDIO:

Set the audio track language.

#### SUBTITLE:

Set the language of the subtitles displayed on the screen.

#### MENU:

Set the language used for the menus (title menu, etc.).

■ SETUP	
LANGUAGES	
AUDIO	AUTO
SUBTITLE	AUTO
MENU	AUTO

### Setting contents:

#### AUDIO mode / MENU mode:

**AUTO** \*<sup>1</sup> / ENGLISH / JAPANESE / GERMAN / SPANISH / FRENCH / ITALIAN / SWEDISH / CHINESE / OTHERS \*<sup>2</sup>

#### SUBTITLE mode:

**AUTO** \*<sup>1</sup> / ENGLISH / JAPANESE / GERMAN / SPANISH / OFF / FRENCH / ITALIAN / SWEDISH / CHINESE / OTHERS \*<sup>2</sup>

Press ▲, ▼, ◀ or ▶ to select your desired language, then press ENT.

#### \*1 AUTO:

The disc is played with the audio language or subtitle language set as the priority language for the disc.

#### \*2 OTHERS:

Set this to play the disc with a language other than one of the languages displayed. Press ENT. then use the numeric keypad "0" to "9" to input the 4-digit language code. Then press ENT. again. For the language codes, refer to "List of Language Codes" (page 54).

- If you change the language setting when the disc is inside, the setting is decided with one of the following operations.
  - Turn OFF the main unit
  - Switch the source on the head unit.
- To temporarily change the language of the current disc, either do so from the DVD menu or using the operation described in the section "Switching the Audio Tracks" (page 23).
- If the disc does not include the selected language, the disc's default language is set.
- Languages set upon shipment from the factory:  
 Audio language : AUTO  
 Subtitle language : AUTO  
 Menu language : AUTO
- Press RETURN to return to the previous display.

## Setting the TV Screen

Use the procedure described below to set the output screen according to the type of TV monitor being used.

### Setting item: TV SCREEN

Setting contents: 16:9 (WIDE) / 4:3 (LETTER BOX) / 4:3 (PAN SCAN)

- For some discs, the picture may not be set to the selected screen size. (For details, refer to the explanation on the disc's jacket.)
- Press RETURN to return to the previous screen.

#### 16:9 (WIDE)

Select this when connected to a wide screen TV. This is selected upon shipment from the factory.



#### 4:3 (LETTER BOX)

Select this when connected to a conventional 4:3 size (normal TV aspect ratio) monitor. There may be black bands visible at the top and bottom of the screen (when playing a 16 : 9 size movie). The width of these stripes will depend upon the original aspect ratio of the theatre release of the movie.



#### 4:3 (PAN SCAN)

Select this when connected to a conventional 4:3 size monitor. The picture will fill the entire TV screen. However, due to the mismatch in aspect ratio, parts of the movie at the extreme left and right sides will not be visible (when playing a 16 : 9 size movie).



## Setting the Country Code

Set the country code of which you want to set the rating level (Parental lock).

### Setting item: PARENTAL

Further setting item: COUNTRY CODE

Setting contents: CODE

- 1 Press ▲ or ▼ to select "PARENTAL," then press ENT. The password input mode is activated.
- 2 Use the numeric keypad "0" to "9" to input the 4-digit password, then press ENT.

#### PASSWORD \* \* \* \*

Input numbers are displayed as "\*"."

The default password is 1111 upon shipment from the factory.

The PARENTAL display appears.

- Can be erased one digit at a time each time CLR is pressed. Press CLR for at least 2 seconds to delete all digits.
- Press RETURN to return to the previous screen.
- If the password is wrong, the unit returns to the password input display, after displaying "PASSWORD ERROR" for 3 seconds.



- 3 Press ▲ or ▼ to select "COUNTRY CODE," then press ENT.
- 4 Press ▲ or ▼ to select AUTO or OTHERS.  
If AUTO is selected, press ENT.  
AUTO: The primary country code among those recorded is played.  
OTHERS: The setting content changes to "OTHER" if the desired country code is input.  
If AUTO is selected, go to step 6. If OTHERS is selected, go to step 5.
- 5 Use the numeric keypad "0" to "9" to input the 4-digit country code, then press ENT.  
Example: Germany "6869" is input
- 6 When the setting is complete, press SETUP.  
The setup returns to normal mode.

- If you want to change the password, select "CHANGE PASSWORD" in step 3. Input the new password (4 digits) and press ENT.
- Write down the password on a piece of paper and store the piece of paper somewhere in case you forget it.
- If the input code is wrong, the unit returns to the country code input display, after displaying "CODE ERROR" for 3 seconds.
- For the country codes, refer to "List of Country Codes" (pages 55 and 56).
- Can be erased one digit at a time each time CLR is pressed. Press CLR for at least 2 seconds to delete all digits.
- Press RETURN to return to the previous screen.

### Setting the Rating Level (Parental Lock)

Use this function to restrict the viewing of movies to children of appropriate age levels only.

**Setting item: PARENTAL**

**Further setting item: PARENTAL LEVEL**

- 1 Press ▲ or ▼ to select "PARENTAL," then press ENT.  
The password input mode is activated.
- 2 Use the numeric keypad "0" to "9" to input the 4-digit password, then press ENT.

**PASSWORD \* \* \* \***

Input numbers are displayed as "\*."

The default password is 1111 upon shipment from the factory.

The restriction level (PARENTAL LEVEL) input display appears.

- Can be erased one digit at a time each time CLR is pressed. Press CLR for at least 2 seconds to delete all digits.
- Press RETURN to return to the previous screen.
- If the password is wrong, the unit returns to the password input display, after displaying "PASSWORD ERROR" for 3 seconds.

- 3 Press ▲ or ▼ to select "PARENTAL LEVEL," then press ENT.
- 4 Press ▲, ▼, ◀ or ▶ to select the restriction level (1 to 8), then press ENT.

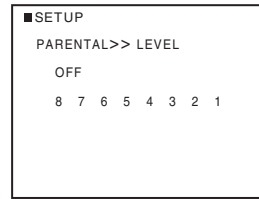

Select "OFF" to cancel the parental lock or if you do not want to set a rating level.

The lower the number, the higher the rating level.

- Press RETURN to return to the previous display.
- 5 When the setting is complete, press SETUP.  
The setup returns to normal mode.
- If you want to change the password, select "CHANGE PASSWORD" in step 3. Input the new password (4 digits) and press ENT.
- Write down the password on a piece of paper and store the piece of paper somewhere in case you forget it.
- On unrated DVDs, playback will not be restricted even if the rating level is set.
- Once set, this rating level remains in memory until changed. To enable the play of discs of higher rating levels or to cancel the parental lock, the setting must be changed.
- Not all DVDs provide a Parental Lock feature. If you are unsure about a DVD, play it first to confirm. Do not leave DVDs accessible to young children for whom you deem them inappropriate.

#### Tips

- **Changing the rating level temporarily**  
Some discs may request that you change the rating level set in the default settings during playback. In this case, the message appears on the monitor screen "PARENTAL LEVEL CHANGE OK?"
- **To change parental level and play, press ENT.**  
The password input mode is displayed. Input the 4-digit password you set in "Setting the Rating Level (Parental Lock)", then press ENT.
- **To play without changing the parental level, press ■.**  
(When ■ is pressed, playback will be at the parental level set with "Setting the Rating Level (Parental Lock).")

# Audio Setup

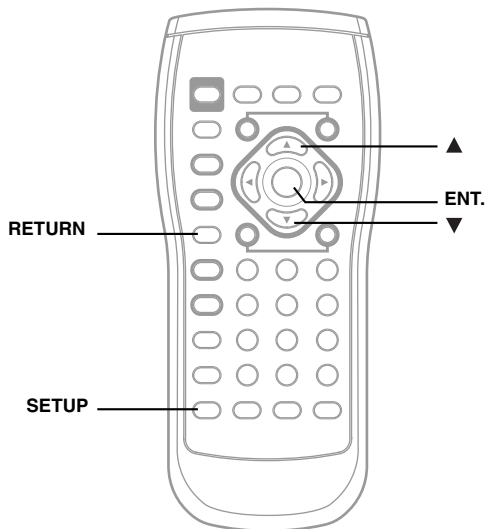

## Audio Setup Operation

- *Audio Setup Operation is performed by the remote control unit.*

The following 5 steps are common to each of the Audio Setup settings. Refer to the specific section for details.

### 1 Press **SETUP** before inserting a disc, or when in stop mode.

The setup menu appears on the monitor.

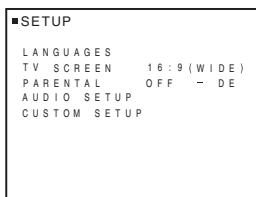

### 2 Press **▲** or **▼** to select "AUDIO SETUP," then press **ENT.**

### 3 Press **▲** or **▼** to select your desired setting item, then press **ENT.**

**AUDIO SETUP items:**  
DIGITAL OUT/ DOWNMIX MODE

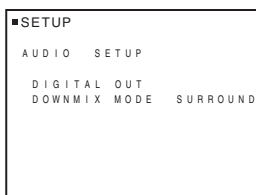

### 4 Press **▲** or **▼** to change the setting, then press **ENT.**

### 5 When the setting is complete, press **SETUP.**

The setup returns to normal mode.

- *When settings are changed, old settings are overwritten. Make a note of the current settings before making changes. If the vehicle's battery is disconnected, the settings will be cleared and will return to the factory settings.*

### Setting the Digital Output

Use the following procedure to set the digital audio signal output from the DVA-9861Ri.

#### Setting item: **DIGITAL OUT**

Further setting items: **DOLBY D / DTS**

Press **▲** or **▼** to select your desired setting item, then press **ENT.**

**DOLBY D:** Sets Dolby Digital output.  
The initial setting is BITSTREAM.

**DTS:** Sets DTS output.  
The initial setting is BITSTREAM.

#### Setting contents: **BITSTREAM / LPCM**

Press **▲** or **▼** to select BITSTREAM or LPCM, then press **ENT.**

**BITSTREAM:** The digital output is switched automatically according to the type of audio signal being played.

Be sure to select "BITSTREAM" when you want to connect a digital audio processor and play Dolby Digital audio. "BITSTREAM" is selected upon shipment from the factory.

**LPCM:** The audio signal recorded on the disc is converted to 48 kHz/16 bit (for DVDs) or 44.1 kHz (for video CDs and CDs) linear PCM audio signals for output.

- *Press **RETURN** to return to the previous screen.*

## Audio output/Optical digital audio output

Disc	Audio recording format		Digital output setting (DVD SETUP)	Optical digital audio output	Analog audio output (Ai-NET, RCA output)
	Format	Fs			
LPCM (CD-DA, DVD-V, DVD- A, DVD-VR)	44.1/176.4kHz	16/20/24bit	BITSTREAM or LPCM	44.1kHz, 16bit, LPCM 2ch (2ch Downmix)*	OK
	48/96/192kHz	16/20/24bit	BITSTREAM or LPCM	48kHz, 16bit, LPCM 2ch (2ch Downmix)*	OK
PPCM (DVD-A)	44.1/88.2/ 176.4kHz	16/20/24bit	BITSTREAM or LPCM	Not output	OK
	48/96/192kHz	16/20/24bit			
Dolby Digital (-EX) (DVD-V, DVD- A, DVD-VR)	48kHz	16/18/20bit	LPCM	48kHz, 16bit, Decoded 2ch (2chDownmix)*	OK
			BITSTREAM	Bit stream (Max 7.1ch)*	OK
DTS (-ES) (CD-DA, DVD-V, DVD- A)	44.1kHz	16/20/24bit	LPCM	44.1kHz, 16bit Decoded 2ch (2chDownmix)*	OK
			BITSTREAM	Bit stream (Max 6.1ch)*	OK
	48/96kHz	16/20/24bit	LPCM	48kHz, 16bit, Decoded 2ch (2chDownmix)*	OK
			BITSTREAM	Bit stream (Max 6.1ch)*	OK
MPEG1Layer II (VCD, DVD-V, DVD-A, DVD- VR)	44.1kHz	16bit	LPCM	44.1kHz, 16bit, Decoded 2ch*	OK
			BITSTREAM	Bit stream*	OK
	48kHz	16bit	LPCM	48kHz, 16bit, Decoded 2ch (2chDownmix)*	OK
			BITSTREAM	Bit stream (Max 5.1ch)*	OK
MPEG2Layer II (DVD-V, DVD- A, DVD-VR)	44.1kHz	16bit	LPCM	44.1kHz, 16bit, Decoded 2ch*	OK
			BITSTREAM	Bit stream*	OK
	48kHz	16bit	LPCM	48kHz, 16bit, Decoded 2ch (2chDownmix)*	OK
			BITSTREAM	Bit stream (Max 5.1ch)*	OK
MPEG1/2/ 2.5Layer III (MP3, WMA)	32kHz	16bit	BITSTREAM or LPCM	32kHz, 16bit, Decoded 2ch	OK
	44.1kHz	16bit	BITSTREAM or LPCM	44.1kHz, 16bit, Decoded 2ch	OK
	48kHz	16bit	BITSTREAM or LPCM	48kHz, 16bit, Decoded 2ch	OK

\* Not output when playing back a DVD-Audio.

### Setting the Downmix Mode

This function applies to Dolby Digital, DTS stream sound.

#### Setting item: DOWNMIX MODE

Setting contents: STEREO/SURROUND ENCODED

**STEREO:** Stereo Downmix

**SURROUND ENCODED:** Surround compatible Downmix

The initial setting at the factory is SURROUND ENCODED.

# Custom Setup

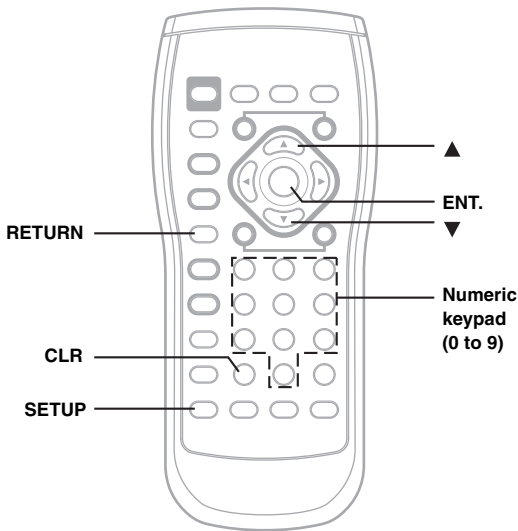

## Custom Setup Operation

- Custom Setup Operation is performed by the remote control unit.

The following 5 steps are common to each of the Custom Setup settings. Refer to the specific section for details.

### 1 Press **SETUP** before inserting a disc, or when in stop mode.

The setup menu appears on the monitor.

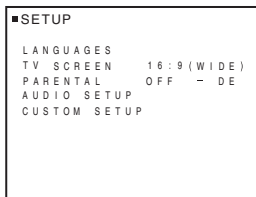

### 2 Press **▲** or **▼** to select "CUSTOM SETUP," then press **ENT.**

### 3 Press **▲** or **▼** to select your desired setting item, then press **ENT.**

#### CUSTOM SETUP items:

DVD-A PLAY MODE / CD PLAY MODE / VCD PLAY MODE / BONUS CODE

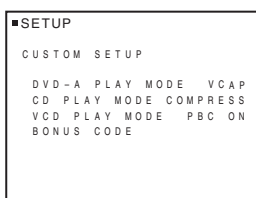

### 4 Press **▲** or **▼** to change the setting, then press **ENT.**

### 5 When the setting is complete, press **SETUP.**

The setup returns to normal mode.

- When settings are changed, old settings are overwritten. Make a note of the current settings before making changes. If the vehicle's battery is disconnected, the settings will be cleared and will return to the factory settings.

#### Setting the DVD Audio Playback Mode

To playback the DVD Audio Disc, you have a choice of 3 different settings. If the disc containing DVD Video and Audio, set VCAP (Video Capable Audio Player) or VOFF (Video OFF) to playback the DVD Audio.

#### Setting item: DVD-A PLAY MODE

#### Setting contents: VIDEO/VCAP/VOFF

**VIDEO:** Only DVD Video is played back if the disc contains DVD Video and Audio.

**VCAP:** DVD Audio is played back with Video.

**VOFF:** DVD Audio is played back without Video.

The initial setting at the factory is VCAP.

- Perform this setting before inserting a disc. If a disc has already been inserted, perform the setting after you remove the disc.

#### Setting the CD Play Mode

The unit can be set to play only the audio data or only the MP3/WMA files on discs containing both audio data and MP3/WMA data.

#### Setting item: CD PLAY MODE

#### Setting contents: CD-DA/COMPRESSED

**CD-DA:** Only CD data can be played back.

**COMPRESSED:** Only MP3/WMA data can be played back.

The initial setting at the factory is CD-DA.

- If a disc has already been inserted, perform the setting after you remove the disc.

#### Setting the Video CD Play Mode

When playing a Playback Control (PBC) enabled video CD, you can choose to set PBC ON or OFF.

#### Setting item: VCD PLAY MODE

#### Setting contents: PBC ON/PBC OFF

**PBC ON:** The PBC menu is displayed.

**PBC OFF:** The PBC menu is not displayed.

The initial setting at the factory is PBC ON.

#### Playing the Bonus Group

In addition to the usual group, DVD Audio also includes an addition Bonus Group. When the Bonus Group is selected, although the password input screen is displayed, you can pre-input a 4-digit password.

#### Setting item: BONUS CODE

#### Setting contents: CODE

1 Press **▲** or **▼** to select "BONUS CODE", then press ENT.

2 Use the numeric keypad "0" to "9" to input 4-digit password, then press ENT.

- Can be erased one digit at a time each time CLR is pressed. Press CLR for at least 2 seconds to delete all digits.
- Press RETURN to return to the previous screen.

3 When the setting is complete, press SETUP.  
The setup returns to normal mode.

- If the Bonus Group password differs from the password in the section you set, the input screen is automatically displayed.

# External Audio Processor Processor (Optional)

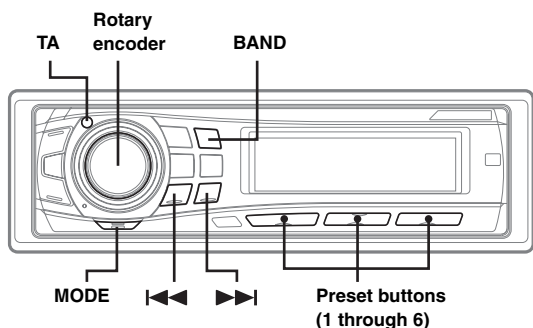

When an external audio processor is connected to this unit, you can operate it from this unit. Some audio processors may not be operated. When PXA-H900 is connected, some of the operations may not be performed from this unit. In this case, operate them in the connected product. Explanations below is the case when PXA-H700 or PXA-H701 is connected for example.

Refer also to the operating instructions of the connected audio processor.

- The adjustments or settings performed on the connected audio processor cannot be operated properly from this unit.
- The setting "Setting the Speakers", "Setting Bass Sound Control", and "Graphic Equalizer Adjustments" are not available if the MRA-D550 is connected. Additionally, if the MRA-F350 is connected, the following setting "Setting the MX mode" is not available. Also, the setting content differs between the PXA-H700 and PXA-H701.
- This unit cannot be connected to the PXA-H510.
- If no operation is performed for approximately 15 seconds when setting the external audio processor, the audio processor control mode is cancelled, and the normal mode returns.

## Adjustment Procedure for Dolby Surround

Make the adjustments described below in order to reproduce Dolby Digital and DTS sound with greater accuracy.

### Adjustment procedure

- 1 Speaker Setup (page 41)**  
(Turning the speakers to be used on and off and setting their response)
- 2 Adjusting the speaker levels (page 41)**  
(Adjusting the signal output level to the various speakers)
- 3 Mixing bass sound to the rear channel (page 42)**  
(Achieving smooth sound in the rear seat by mixing the front audio signals with the rear speaker signals)
- 4 Adjusting the acoustic image (page 42)**  
(Adjusting the acoustic image to achieve a sound as if the centre speaker were directly in front of the listener)
- 5 Achieving powerful high volume sound (page 43)**  
(Achieving energetic sound with even greater power, like the sound in a movie theatre)
- 6 Adjusting the DVD Level (page 43)**  
(Adjust the volume (signal level) in the Dolby Digital, Pro Logic II, DTS and PCM modes.)
- 7 Storing Settings in the Memory (page 44)**  
(Storing all the settings and adjustments made on the DVA-9861Ri (not only the above settings/adjusts) in the memory)

**In case of combining the Automatic adjustments etc.**

We recommend to make the Automatic adjustments before the Dolby Surround adjustments.

---

## Setting the Speakers

---

- 1 **Check that Defeat mode is off (page 25).**
- 2 **Press and hold TA for at least 2 seconds.**  
The audio processor control mode is activated.
- 3 **Select the SP SELECT mode by pressing TA repeatedly.**
- 4 **Press MODE to select the speaker.**
- 5 **Select any kind of speaker or set speaker to ON/OFF by turning the Rotary encoder.**

FRONT1:	OFF/TW (Tweeter)/FULL (Full Range)
FRONT2:	OFF/ON
REAR:	OFF/ON
CENTER:	OFF/ON
SUBWOOFER:	OFF/MONO/STEREO

- 6 **Repeat steps 4 and 5 to set all the speakers.**
- 7 **When the setting is complete, press and hold TA for at least 2 seconds.**  
The unit returns to the normal mode.

- Set the speaker which is not connected to OFF.
- Settings above can be carried out even when the speaker is set to OFF in "Speaker Setup" (page 41).
- To use the subwoofer in MONO with PXA-H700 or PXA-H701 connected, connect the subwoofer to the subwoofer output terminal of PXA-H700 or PXA-H701.

---

## Set MX Mode of the External Audio Processor

---

Before performing the operations below, set MX (Media Xpander) mode of the PXA-H700 to "AUTO" when the PXA-H700 is connected.

- 1 **Check that Defeat mode is off (page 25).**
  - 2 **Press and hold TA for at least 2 seconds.**  
The MX mode of the audio processor control mode is activated.
  - 3 **Select ON/OFF of MX by pressing |◀◀ or ▶▶|.**  
If ON is selected, press MODE.  
OFF: Turns off the MX effect of every music source.  
ON: Turns on the specified MX mode.
  - 4 **After setting to ON, select the desired MX level by turning the Rotary encoder.**
- Music source (such as radio broadcasts and CDs, excluding MW, LW radio) level can be set.

### MX CD (OFF, CD MX 1 to 3)

CD mode processes a large quantity of data. This data is used to reproduce the sound cleanly by making use of the data quantity.

### MX COMPRESS MEDIA (OFF, CMPM MX 1 to 3)

This corrects information that was omitted at the time of compression. This reproduces a well-balanced sound close to the original.

### MX FM (OFF, FM MX 1 to 3)

The medium to high frequencies become more clear, and produces well balanced sound in all the bands.

### MX DVD (OFF, MOVIE MX 1 to 2)

The dialog portion of the video is reproduced more clearly.

### (DVD MUSIC)

This disk contains a large quantity of data such as music clip. MX uses this data to reproduce the sound accurately.

### MX AUX 1 to 3 (OFF, CMPM MX, MOVIE MX, MUSIC MX)

Choose the MX mode (CMPM, MOVIE, or MUSIC) that corresponds to the media connected.

- 5 **When the setting is complete, press and hold TA for at least 2 seconds.**

The unit returns to the normal mode.

- The contents of MX set here is reflected to PXA-H700 or PXA-H701.
- When OFF is selected, MX effect of each MX mode will be OFF.
- Each music source, such as radio, CD, and MP3 can have its own MX setting.
- There is no MX mode for MW, LW radio.
- MX COMPRESS MEDIA is applied for MP3/WMA, MMD.

---

## X-OVER Adjustment

---

- 1 **Check that Defeat mode is off (page 25).**
  - 2 **Press and hold TA for at least 2 seconds.**  
The audio processor control mode is activated.
  - 3 **Select the X-OVER mode by pressing TA repeatedly.**
  - 4 **Select L+R or L/R by pressing and holding BAND for at least 2 seconds.**  
L+R: Sets the same adjustment values for the left and right channels.  
L/R: Different adjustment values can be set for the left and right channels.
  - 5 **Select the desired channel by pressing |◀◀ or ▶▶|, then press MODE.**  
When L+R is selected :  
FRONT 1 → FRONT 2 → REAR → CENTER → SUBWOOFER → FRONT 1  
When L/R is selected :  
FRONT 1L → FRONT 1R → FRONT 2L → FRONT 2R → REAR L → REAR R → CENTER → SUBWOOFER → FRONT 1L
- The speakers display differs, depending on the connected speakers.

- 6 Adjust the cut-off frequency of H.P.F. (HP FREQ) by turning the Rotary encoder, then press MODE.**  
The adjustable frequency range differs depending on the channels (speakers).
- 7 Adjust the slope of H.P.F. (HP SLOPE) by turning the Rotary encoder, then press MODE.**
- 8 Adjust L.P.F. by performing steps 6 and 7.**
- 9 Adjust the level (LEVEL) by turning the Rotary encoder, then press MODE.**  
Press the MODE to return to step 6.
- 10 To adjust other channels, repeat steps 5 to 9.**
- 11 When the setting is complete, press and hold TA for at least 2 seconds.**

The unit returns to the normal mode.

- When the speaker is set to the "OFF" mode, the X-OVER for that speaker cannot be set. Refer to "Setting the Speakers" (page 37).
- Check the playback frequencies of the connected speakers before adjusting.
- In order to protect the speakers, there is no OFF setting for the subwoofer low pass filter (the slope remains the same).
- The H.P.F. filter cannot be set to OFF (slope OFF) if Tweeter is selected for FRONT1. Or, if subwoofer is set to STEREO, CENTER adjustment is affected by the subwoofer setting.
- When the setting is complete, it is recommended to store the setting contents. For storing, refer to page 44.

## Performing Time Correction Manually (TCR)/ Phase Switching

Because of the particular conditions inside the vehicle, there can be major differences in the distances between the various speakers and the listening position. It is possible to calculate the optimum correction values and eliminate the time error at the listening position yourself using this function.

### Calculating the Time Correction

- 1 Sit in the listening position (the driver's seat, for example) and measure the distance (in meters) between your head and the various speakers.**
- 2 Calculate the difference in distance between the farthest speaker and the other speakers.**  

$$L = (\text{distance of farthest speaker}) - (\text{distance of other speakers})$$
- 3 Divide the distances calculated for the different speakers by the speed of sound (343 m/s temperature 20°C).**  
This value is the time correction value for the various speakers.

### Concrete examples

Calculating the time correction value for the front left speaker on the diagram below.

Conditions:

Distance between farthest speaker and listening position:  
2.25 m (88-3/4")

Distance between front left speaker and listening position:  
0.5 m (20")

Calculation:

$$L = 2.25 \text{ m (88-3/4")} - 0.5 \text{ m (20")} = 1.75 \text{ m (68-3/4")}$$

$$\text{Compensation time} = 1.75 \div 343 \times 1000 = 5.1 \text{ (ms)}$$

In other words, setting the time correction value for the front left speaker to 5.1 (ms) sets a virtual distance matching the distance to the farthest speaker.

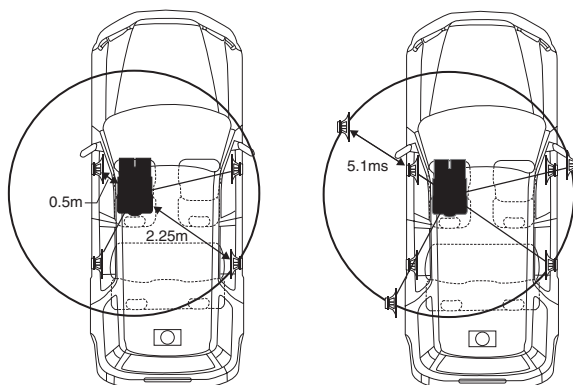

The sound is uneven because the distance between the listening position and the different speakers is different. The difference in the distance between the front left and rear right speakers is 1.75 meters (68-3/4").

Time correction eliminates the difference between the time required for the sound from the different speakers to reach the listening position. Setting the time correction of the front left speaker to 5.1 ms makes it possible to coordinate the distance from the listening position to the speaker.

### Inputting the Time Correction

- 4 Check that Defeat mode is off (page 25).**
- 5 Press and hold TA for at least 2 seconds.**  
The audio processor control mode is activated.
- 6 Select the TCR/PHASE mode by pressing TA repeatedly.**
- 7 Select L+R or L/R by pressing and holding BAND for at least 2 seconds.**  
 L+R: Sets the same adjustment values for the left and right channels.  
 L/R: Different adjustment values can be set for the left and right channels.

## 8 Select the desired channel by pressing **◀◀** or **▶▶**, then press **MODE**.

When L+R is selected :

FRONT 1L → FRONT 2L → REAR → CENTER →  
SUBWOOFER → FRONT 1

When L/R is selected :

FRONT 1L → FRONT 1R → FRONT 2L → FRONT 2R →  
REAR L → REAR R → CENTER → SUBWOOFER →  
FRONT 1L

- The speakers display differs, depending on the connected speakers.

## 9 Adjust the calculated time correction value (0.00 to 20.00ms) by turning the **Rotary encoder**, then press **MODE**.

### Switching the Phase

## 10 Switch the phase (PHASE 0° or 180°) by turning the **Rotary encoder**, then press **MODE**.

## 11 To adjust other channels, repeat steps 8 to 10.

## 12 When the setting is complete, press and hold **TA** for at least 2 seconds.

The unit returns to the normal mode.

- When the speaker is set to the "OFF" mode, the TCR for that speaker cannot be set. Refer to "Setting the Speakers" (page 37).
- The adjustment value for FRONT2 (Speakers) which is adjusted in time correction, is also applied to the front speakers in "Setting Bass Focus" (page 41).
- The adjustment (AUTO TCR) cannot be automatically set on this unit.
- When the setting is complete, it is recommended to store the setting contents. For storing, refer to page 44.

## Graphic Equalizer Adjustments

The graphic equalizer allows you to modify the sound using 31 bands each for the front (left and right), rear (left and right) and centre speakers. An additional 10 bands are available for the subwoofer. This allows you to customize the sound to suit your taste.

## 1 Check that Defeat mode is off (page 25).

## 2 Press and hold **TA** for at least 2 seconds.

The audio processor control mode is activated.

## 3 Select the G-EQ mode by pressing **TA** repeatedly.

## 4 Select L+R or L/R by pressing and holding **BAND** for at least 2 seconds.

L+R: Sets the same adjustment values for the left and right channels.

L/R: Different adjustment values can be set for the left and right channels.

When parametric EQ is adjusted, this setting will be turned off.

## 5 Select the desired channel by pressing **◀◀** or **▶▶**, then press **MODE**.

When L+R is selected :

FRONT → REAR → CENTER → SUBWOOFER → FRONT

When L/R is selected :

FRONT L → FRONT R → REAR L → REAR R → CENTER  
→ SUBWOOFER → FRONT L

- The speakers display differs, depending on the connected speakers.

## 6 Select the frequency by turning the **Rotary encoder**, then press **MODE**.

Adjustable frequency:

FRONT/REAR/CENTER: 20Hz - 20kHz (in 1/3 octave steps)

SUBWOOFER: 20Hz - 160Hz (in 1/3 octave steps)

## 7 Adjust the level (LEVEL) (±9dB 1dB step) by turning the **Rotary encoder**, then press **MODE**.

## 8 To adjust other frequencies, repeat steps 6 and 7.

## 9 To adjust other channels, repeat steps 5 to 8.

## 10 When the setting is complete, press and hold **TA** for at least 2 seconds.

The unit returns to the normal mode.

- When the speaker is set to the "OFF" mode, the level of the graphic equalizer for that speaker cannot be adjusted. Refer to "Setting the Speakers" (page 37).
- Check the playable frequency ranges of the connected speakers before making the equalizer adjustments. If the speaker's playable frequency range is 55 Hz to 30 kHz, for example, adjusting the 40 Hz or 20 Hz band has no effect. Additionally, you may overload and damage the speakers.
- When graphic EQ is adjusted, the adjustment for parametric EQ becomes ineffective.
- When the setting is complete, it is recommended to store the setting contents. For storing, refer to page 44.



---

## Parametric Equalizer Adjustments

---

The frequency bands of the graphic equalizer are fixed. This makes it very difficult to correct for undesired peaks and dips at specific frequencies. The parametric equalizer's centre frequency can be tuned to these specific frequencies. Then, the bandwidth (Q) and level are fine-tuned, independently, to make the necessary corrections. The parametric equalizer function is an advanced tool for serious audiophiles.

- 1 Check that Defeat mode is off (page 25).**
- 2 Press and hold TA for at least 2 seconds.**  
The audio processor control mode is activated.
- 3 Select the P-EQ mode by pressing TA repeatedly.**
- 4 Select L+R or L/R by pressing and holding BAND for at least 2 seconds.**

L+R: Sets the same adjustment values for the left and right channels.

L/R: Different adjustment values can be set for the left and right channels.

When graphic EQ is adjusted, this setting will be turned off.

- 5 Select the desired channel by pressing ◀◀ or ▶▶, then press MODE.**

When L+R is selected :

FRONT → REAR → CENTER → SUBWOOFER → FRONT

When L/R is selected :

FRONT L → FRONT R → REAR L → REAR R → CENTER  
→ SUBWOOFER → FRONT L

- The speakers display differs, depending on the connected speakers.

- 6 Press BAND to select the band.**

Adjustable bands:

FRONT/REAR/CENTER: 5 bands

SUBWOOFER: 2 bands

- 7 Select the frequency by turning and then pressing the Rotary encoder, then press MODE.**

The adjustable frequency changes according the band.

- 8 Adjust the band width (Q) by turning the Rotary encoder, then press MODE.**

The band width is adjustable in 6 steps: 0.5/1/2/3/4/5

- 9 Adjust the level (LEVEL) (±9dB 1dB step) by turning the Rotary encoder, then press MODE.**

- 10 To adjust other bands, repeat steps 6 to 9.**

- 11 To adjust other channels, repeat steps 5 to 10.**

- 12 When the setting is complete, press and hold TA for at least 2 seconds.**

The unit returns to the normal mode.

- When the speaker is set to the "OFF" mode, the parametric equalizer for that speaker cannot be set. Refer to "Setting the Speakers" (page 37).
- It is not possible to adjust the frequencies of adjacent bands within 7 steps.
- Check the playable frequency ranges of the connected speakers before making the equalizer adjustments. If the speaker's playable frequency range is 55 Hz to 30 kHz, for example, adjusting the 40 Hz or 20 Hz band has no effect. Additionally, you may overload and damage the speakers.
- When the parametric EQ is adjusted, the adjustment for graphic EQ becomes ineffective.
- When the setting is complete, it is recommended to store the setting contents. For storing, refer to page 44.

---

## Setting Bass Compressor

---

You can adjust the sound of low frequencies as desired.

- 1 Check that Defeat mode is off (page 25).**

- 2 Press and hold TA for at least 2 seconds.**

The audio processor control mode is activated.

- 3 Select the BASS SOUND mode by pressing TA.**

- 4 Select BASS COMP. by pressing ◀◀ or ▶▶, then press MODE.**

- 5 Select the desired mode by turning the Rotary encoder.**

Bass sound is emphasized more as the mode is sequentially switched as COMP1 → 2 → 3, offering you vivid low frequencies.

Select OFF when the setting is not necessary.

- 6 When the setting is complete, press and hold TA for at least 2 seconds.**

The unit returns to the normal mode.

---

## Setting Bass Focus

---

Using the previously specified delay number (time difference) allows you to set a time difference between the front-rear/left-right speakers. Namely, it enables a time correction based on your preference. With an initial delay of 0.05 ms for each of the 0 to 400 steps, audible time correction can be achieved.

- 1 Check that Defeat mode is off (page 25).**
  - 2 Press and hold TA for at least 2 seconds.**  
The audio processor control mode is activated.
  - 3 Select the BASS SOUND mode by pressing TA.**
  - 4 Select BASS FOCUS by pressing ◀◀ or ▶▶, then press MODE.**
  - 5 Press MODE to select the front/rear/left/right speaker.**
  - 6 Turn the Rotary encoder to set the front/rear and left/right speakers.**
  - 7 To set other channels (speakers), repeat steps 5 and 6.**
  - 8 When the setting is complete, press and hold TA for at least 2 seconds.**  
The unit returns to the normal mode.
- Any setting in Bass Focus is applied in time correction, too.
  - When the setting is complete, it is recommended to store the setting contents. For storing, refer to page 44.

---

## Speaker Setup

---

The PXA-H700 or PXA-H701 can be set according to the playable frequency range of your speakers.

Check the playable frequency range of the speakers (not including the subwoofer) before performing this operation to verify whether the speakers can play low frequencies (of about 80 Hz or less).

- Avoid stopping, pausing, switching the disc, cueing, fast-forwarding or switching the audio channel of this unit while making this adjustment. The setting is cancelled if Decode mode is switched.

- 1 Check that Defeat mode is off (page 25).**
- 2 Press and hold TA for at least 2 seconds.**  
The audio processor control mode is activated.
- 3 Select the SP SETUP mode by pressing TA repeatedly.**
- 4 Select the speaker by pressing the MODE.**

- 5 Select the speaker characteristic by turning the Rotary encoder.**

OFF\*<sup>1</sup>: When no speaker is connected.

SMALL: When a speaker that cannot play low frequencies (80 Hz or less) is connected.

LARGE\*<sup>2</sup>: When a speaker that can play low frequencies (80 Hz or less) is connected.

(Subwoofer is set to ON/OFF only)

\*<sup>1</sup> It is not possible to set the front speakers to "OFF".

\*<sup>2</sup> If the front speakers are set to "SMALL", the rear and centre speakers cannot be set to "LARGE".

- 6 Repeat steps 4 and 5 to set each speaker.**

- 7 When the setting is complete, press and hold TA for at least 2 seconds.**

The unit returns to the normal mode.

- If the centre speaker is turned "OFF," the centre channel's audio signals are added to the audio signals output from the front speakers.
- If you set the speaker response to "OFF," also set the speaker setting to "OFF" (page 37)
- Perform the setup for all the speakers ("Front," "Center," "Rear" and "Subwoofer"). If not, the sound may not be balanced.
- When centre is set to "OFF", the setting is ineffective even if centre is set with this function.
- Through changing the settings on each speaker, a change in the output of the other speakers may occur due to the setting requirements.
- When using the PRO LOGIC II, if the rear speaker is set to "LARGE", then there will be no output from the subwoofer.
- When the setting is complete, it is recommended to store the setting contents. For storing, refer to page 44.

---

## Setting of Dolby Digital

---

### Adjusting the speaker levels

The test tones help to make the volume adjustments of the different speakers. When levels are equal, a strong sense of presence can be heard from the different speakers at the listening position.

- Avoid stopping, pausing, switching the disc, cueing, fast-forwarding or switching the audio channel of this unit while making this adjustment. The setting is cancelled if the decode mode is switched.

- 1 Check that Defeat mode is off (page 25).**
- 2 Press and hold TA for at least 2 seconds.**  
The audio processor control mode is activated.
- 3 Select the MULTI CH SETUP mode by pressing TA repeatedly.**
- 4 Select OUTPUT LEVEL by pressing ◀◀ or ▶▶, then press MODE.**

**5 Press MODE to select the speaker to be adjusted.**  
The test tone is produced by the selected speaker.

**6 Adjust the output level by turning the Rotary encoder.**

**7 Adjust each volume level for optimum balance by repeating steps 5 and 6.**

- The adjustment range for the different speakers is  $-10\text{ dB} - +10\text{ dB}$ .
- Adjust based on the front speakers.

**8 When the setting is complete, press and hold TA for at least 2 seconds.**

The unit returns to the normal mode.

- If a speaker is set to off mode, that speaker's level adjustment cannot be made. Refer to "Speaker Setup" (page 41).
- When the setting is complete, it is recommended to store the setting contents. For storing, refer to page 44.

### Mixing bass sound to the rear channel

This function mixes the front channel audio signals to the audio signals output from the rear speakers, improving the sound in the vehicle's rear seat.

- Avoid stopping, pausing, switching the disc, cueing, fast-forwarding or switching the audio channel of this unit while making this adjustment. The setting is cancelled if the Decode mode is switched.

**1 Check that Defeat mode is off (page 25).**

**2 Press and hold TA for at least 2 seconds.**  
The audio processor control mode is activated.

**3 Select the MULTI CH SETUP mode by pressing TA repeatedly.**

**4 Select REAR MIX by pressing  $\text{I} \lll$  or  $\text{I} \ggg$ , then press MODE.**

**5 Select REAR MIX ON/OFF by turning the Rotary encoder.**

If ON is selected, press MODE.

If ON is set, the audio signal which is output from the rear speaker is mixed to the front audio signal.

**6 After setting to ON, turn the Rotary encoder to adjust the level (LEVEL).**

The level can be adjusted in five steps:  $-6$ ,  $-3$ ,  $0$ ,  $+3$  and  $+6$ . The higher the level, the more bass is output from the rear speakers. (The effect differs according to the software (DVD, etc..))

**7 When the setting is complete, press and hold TA for at least 2 seconds.**

The unit returns to the normal mode.

- This adjustment is ineffective when the rear speaker setup setting is set to "OFF."
- For linear PCM signals, the voice is output from the rear speaker regardless of the REAR FILL and REAR MIX setting.
- When the setting is complete, it is recommended to store the setting contents. For storing, refer to page 44.

### Adjusting the acoustic image

In most installations, the centre speaker must be placed directly between the front passenger and driver. Using this function, the centre channel information is distributed to the left and right speakers. This creates an acoustic image simulating a centre speaker directly in front of each listener. Adjusting the centre width in PL II MUSIC (see "Using the Pro Logic II Mode" page 43), makes this function ineffective.

- Avoid stopping, pausing, switching the disc, cueing, fast-forwarding or switching the audio channel of this unit while making this adjustment. The setting is cancelled if the Decode mode is switched.

**1 Check that Defeat mode is off (page 25).**

**2 Press and hold TA for at least 2 seconds.**  
The audio processor control mode is activated.

**3 Select the MULTI CH SETUP mode by pressing TA repeatedly.**

**4 Select BI-PHANTOM by pressing  $\text{I} \lll$  or  $\text{I} \ggg$ , then press MODE.**

**5 Select BI-PHANTOM ON/OFF by turning the Rotary encoder.**

If ON is selected, press MODE.

If ON is set, the soundstage created is as if you are positioned directly in front of the centre speaker by distributing the centre speaker sound left and right.

**6 After setting to ON, turn the Rotary encoder to adjust the level (LEVEL).**

The level can be adjusted within the range of  $-5$  to  $+5$ . The higher the level, the more the position of the centre speaker is shifted to the sides.

**7 When the setting is complete, press and hold TA for at least 2 seconds.**

The unit returns to the normal mode.

- This adjustment is effective when the setting of the centre speaker to SMALL or LARGE in the speaker setup settings.
- This adjustment is ineffective when the speaker is set to CENTER "OFF" in "Setting the Speakers" (page 37).
- When the setting is complete, it is recommended to store the setting contents. For storing, refer to page 44.

## Achieving powerful high volume sound

With Dolby Digital, the dynamic range is compressed so that powerful sound can be achieved at regular volume levels. This compression can be cancelled to achieve an energetic sound with even greater power, like the sound in a movie theatre.

This function works only in the Dolby Digital mode.

- 1 Check that Defeat mode is off (page 25).**
- 2 Press and hold TA for at least 2 seconds.**  
The audio processor control mode is activated.
- 3 Select the MULTI CH SETUP mode by pressing TA repeatedly.**
- 4 Select LISTEN MODE by pressing |◀◀ or ▶▶|, then press MODE.**
- 5 Select STANDARD or MAXIMUM by turning the Rotary encoder.**  
STANDARD: For powerful sound at regular volume levels  
MAXIMUM: For powerful sound at high volumes
- 6 When the setting is complete, press and hold TA for at least 2 seconds.**  
The unit returns to the normal mode.
  - Keep the volume to a level at which sounds outside the vehicle can still be heard.
  - When the setting is complete, it is recommended to store the setting contents. For storing, refer to page 44.

## Adjusting the DVD Level

The volume (signal level) for Dolby Digital, Dolby PL II, DTS and PCM modes can be set.

- Avoid stopping, pausing, switching the disc, cueing, fast-forwarding or switching the audio channel of this unit while making this adjustment. The setting is cancelled if the Decode mode is switched.

- 1 Check that Defeat mode is off (page 25).**
- 2 Press and hold TA for at least 2 seconds.**  
The audio processor control mode is activated.
- 3 Select the DVD LEVEL mode by pressing TA repeatedly.**
- 4 Press MODE to select the mode to be adjusted.**  
DOLBY D → PL II → DTS → PCM → DOLBY D

- 5 Adjust the level (LEVEL) by turning the Rotary encoder.**  
The level can be adjusted in the range of -5 to +5.

- 6 Repeat steps 4 and 5 to set each level.**

- 7 When the setting is complete, press and hold TA for at least 2 seconds.**  
The unit returns to the normal mode.

- When the setting is complete, it is recommended to store the setting contents. For storing, refer to page 44.

## Using the Pro Logic II Mode

Pro Logic processing can be conducted on the music signals recorded on two channels to achieve Dolby Pro Logic II surround sound. For two-channel Dolby Digital and DTS signals, there is also a "REAR FILL" function for outputting the signals of the front channel to the rear channel.

- 1 Check that Defeat mode is off (page 25).**
- 2 Press and hold TA for at least 2 seconds.**  
The audio processor control mode is activated.
- 3 Select the D PL II/REAR mode by pressing TA repeatedly.**
- 4 Select the desired mode by pressing |◀◀ or ▶▶|.**  
MOVIE MODE:  
Suits the stereo TV shows and all programs encoded in Dolby Surround. It improves the sound field directivity to near that of discrete 5.1-channel sound.  
MUSIC MODE:  
Can be used for all stereo music recordings, and provides a wide, deep sound field.  
REAR FILL ON:  
Depending on the input signals, the sound may only be output from the front speakers. In this case, the "REAR FILL" function can be used to output signals from the rear speakers as well.  
OFF: Turns D PLII/REAR function to OFF.

**If MUSIC MODE is selected, the centre width can be adjusted with following operations.**

This function offers the optimum vocal position by adjusting the centre channel position between the centre speaker and the L/R speaker. (The adjustments established in "Adjusting the acoustic image" (page 42) are ineffective while this function is activated.)

- After pressing MODE, select MUSIC MODE and turn the Rotary encoder to select CTW CONT ON/OFF.  
If ON is selected, press MODE.  
If ON is set, you can enjoy the optimum vocal position by distributing the centre channel sound between the centre speaker and L/R speaker.
- After setting to ON, turn the Rotary encoder to adjust the level (LEVEL).

The level can be adjusted between 0 to 7. When the level increases, the centre channel position moves from the centre speaker position to both sides.

## 5 When the setting is complete, press and hold TA for at least 2 seconds.

The unit returns to the normal mode.

- This adjustment is effective when the setting of the centre speaker is SMALL or LARGE in the speaker setup settings.
- Avoid stopping, pausing, switching the disc, cueing, fast-forwarding or switching the audio channel of this unit while making this adjustment. The setting is cancelled if the Decode mode is switched.
- This adjustment is ineffective when the speaker is set to CENTER “OFF” in “Setting the Speakers” (page 37).
- This function only works with two-channel signals. This operation is ineffective when 5.1-channel DTS or Dolby Digital signals are input.
- If the setting of REAR FILL is made when REAR MIX is ON, sound is unchanged in the rear fill setting because REAR MIX is given priority during 2 channel decoder other than linear PCM.
- For linear PCM signals, the voice is output from the rear speaker regardless of the REAR FILL and REAR MIX setting.
- When the setting is complete, it is recommended to store the setting contents. For storing, refer to page 44.

## Linear PCM Setting

The output when playing discs recorded in linear PCM can be set to 2 or 3 channels.

- 1 Check that Defeat mode is off (page 25).
- 2 Press and hold TA for at least 2 seconds.  
The audio processor control mode is activated.
- 3 Select PCM MODE by pressing TA repeatedly.
- 4 Select 2 CH or 3 CH by turning the Rotary encoder.  
2CH: 2ch output (L/R)  
3CH: 3ch output (L/R/CENTER)
- 5 When the setting is complete, press and hold TA for at least 2 seconds.  
The unit returns to the normal mode.

- This adjustment is ineffective when the speaker is set to CENTER “OFF” in “Setting the Speakers” (page 37).

## Storing Settings in the Memory

Up to 6 set and adjusted contents can be stored on the unit. All that are setting and adjusting items described below are stored in one preset memory.

Setting/adjusting items	Refer to page
Setting the Speakers	37
Setting Time Correction/Switching Phase/ Setting the Bass Focus	38, 39, 41
Adjusting EQ	39, 40
Adjusting X-OVER	37
Setting MX	37
Setting BASS COMP.	40
Setting PRO LOGIC II/Adjusting the Centre Width*	43
Adjusting Dolby Surround*	41, 42, 43
Linear PCM Setting*	44

\* Depending on the input signal, sound effect may not be obtained.

- 1 Adjust and set the value to be stored.
- 2 Press and hold for at least 2 seconds any one of the preset buttons (1 through 6) into which you want to store the set/adjusted value as preset memory (MEMORY 1 through MEMORY 6).

- This function is operable only when Defeat is set to OFF.
- The stored contents will not be deleted even when battery power cord is detached.

## Recalling the Preset Memory

- 1 Check that Defeat mode is off (page 25).
- 2 Press and hold TA for at least 2 seconds.  
The audio processor control mode is activated.
- 3 Press any one of the buttons to select the preset memory (MEMORY 1 through MEMORY 6) you want to recall.  
It takes a few moment to get out the preset memory.

## Confirming the current Preset No./EQ mode

- 1 Press and hold TA for at least 2 seconds.  
The audio processor control mode is activated.
- 2 Press TA repeatedly to select PRESET INFO.  
The current preset number and EQ mode appear in the display.

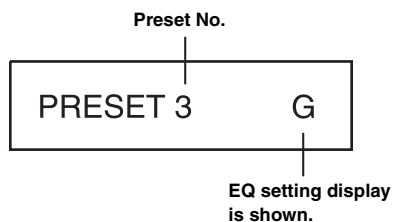

Displays which EQ, graphic EQ or parametric EQ is currently set.

G: Graphic EQ

P: Parametric EQ

- 3 Press and hold TA for at least 2 seconds to complete confirmation.  
The unit returns to normal mode.

## Remote Control Operation

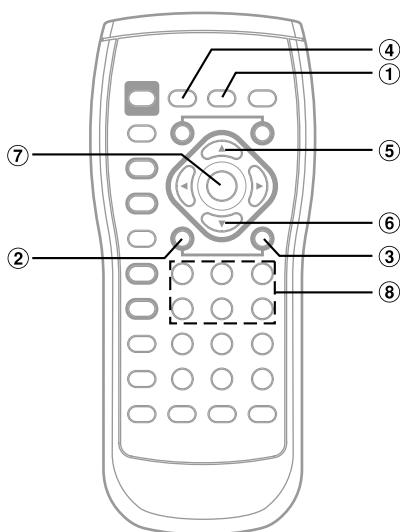

	Remote Control Button Name	Function	Unit Button
①	A.PROC.	Recalls the audio processor mode	TA (more than 2 seconds)
		Switches the audio processor mode	TA
		Cancels the audio processor mode	TA (more than 2 seconds)
②	◀◀	Changes the adjusting item	◀◀
③	▶▶	Changes the adjusting item	▶▶
④	BAND (more than 2 seconds)	Switches L+R or L/R	BAND (more than 2 seconds)
⑤	▲	Adjusts the selected setting item and changes the set contents	Rotary encoder (Turn)
⑥	▼	Adjusts the selected setting item and changes the set contents	Rotary encoder (Turn)
⑦	ENT.	Changes the setting item in the selected setting item	MODE
⑧	Numeric Keypad (1 to 6)	Stores/Recalls setting value	Preset buttons (1 to 6)

# iPod™ (Optional)

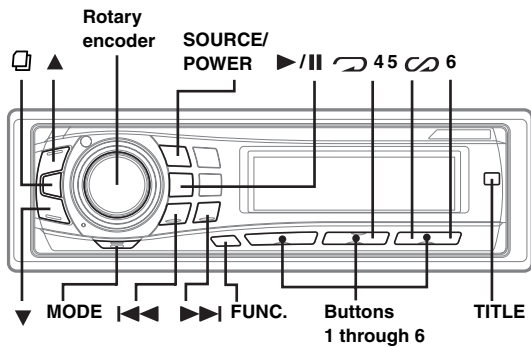

An iPod™ can be connected to the DVA-9861Ri by using the proprietary ALPINE FULL SPEED™ Connection Cable (supplied). When the DVA-9861Ri is connected by using the cable, the controls on the iPod™ are not functional.

## About iPod™ usable with this unit

The unit can be used with third generation and above iPod™, iPod™ photo, iPod™ mini or iPod™ nano. iPod™ Shuffle cannot be used, however.

- Touch wheel or scroll wheel type iPods without the dock connector cannot be connected to the unit.
- The unit can be used with the following iPod versions. Correct function of earlier versions cannot be guaranteed.

Third generation iPod: Ver. 2.3  
Fourth generation iPod: Ver 3.0.2  
iPod photo: Ver. 1.1  
iPod mini: Ver. 1.3  
iPod nano: Ver. 1.0

- The unit cannot be used with the software versions earlier than 2005-02-22. For details about "iPod Software Update," refer to the iPod Instruction Manual.

## Playback

- 1 Press **SOURCE/POWER** to switch to the IPOD mode.

- 2 Press **◀◀** or **▶▶** to select the desired song.

**Return to the beginning of the current song:**

Press **◀◀**.

**Fast backward:**

Press and hold **◀◀**.

**Advance to the beginning of the next song:**

Press **▶▶**.

**Fast forward:**

Press and hold **▶▶**.

- 3 To pause playback, press **▶/||**.

Pressing **▶/||** again will resume playback.

- If a song is playing on the iPod when it is connected to the DVA-9861Ri, it will continue playing after the connection.

## Searching for a desired Song

An iPod can contain hundreds of songs. By keeping these songs organized in playlists, the DVA-9861Ri can use these to ease song searches.

### Searching by Playlist

- 1 Press **□** to activate the search selection mode.
- 2 Turn the **Rotary encoder** to select the **PLAYLIST** search mode, then press **□**.  
PLAYLIST ↔ ARTIST ↔ ALBUM ↔ SONG ↔ PLAYLIST
- 3\*1 Turn the **Rotary encoder** to select the desired **Playlist**.
- 4 Press **▶/||**.  
The selected Playlist is played back.

### To search for a song in the selected playlist



- 1 After selecting the playlist in step 3\*1, press **□** to change to the song search mode of the selected playlist.
  - 2 Turn the **Rotary encoder** to select a song and press **MODE**.  
The selected song is played back.
- While in the search mode, if you press and hold **□** for at least 2 seconds, or no operation is performed for 10 seconds, the search mode is cancelled.
  - While in the search mode, pressing **FUNC.** will return to the previous mode.
  - All songs in the iPod are played back by selecting the stored "iPod name" in step 3\*1.
  - Playlist search cannot be made during M.I.X. play.
  - In the search mode, you can jump to an assigned position by pressing any one of buttons 1 through 6 for quick search purposes. For details, refer to "Direct Search Function" (page 47).
  - "NO SONG" will be displayed if there are no songs in the selected playlist in the **PLAYLIST** search mode.

### Searching by artist name







- 1 Press **□** to activate the search selection mode.
- 2 Turn the **Rotary encoder** to select the **ARTIST** search mode, then press **□**.  
PLAYLIST ↔ ARTIST ↔ ALBUM ↔ SONG ↔ PLAYLIST
- 3\*2 Turn the **Rotary encoder** to select the desired **Artist**.
- 4 Press **▶/||**.  
The selected Artist song is played back.





## To search for an album of the selected artist

- 1 After selecting the artist in step 3\*<sup>2</sup>, press  to change to the album search mode of the selected artist.
- 2\*<sup>1</sup> Turn the Rotary encoder to select an album.
- 3 Press  to play back all songs of the selected album.





## To search for a song of the selected album

- 1 After selecting the album in step 2\*<sup>1</sup>, press  to change to the song search mode of the selected album.
  - 2 Turn the Rotary encoder to select a song and press **MODE**.  
The selected song is played back.
- While in the search mode, if you press and hold  for at least 2 seconds, or no operation is performed for 10 seconds, the search mode is cancelled.
  - While in the search mode, pressing **FUNC.** will return to the previous mode.
  - If you choose **ALL** in step 3\*<sup>2</sup>, and you press , all songs in iPod are played back. If you choose **ALL**, and you press , the **ALBUM** search mode for all artists is activated.
  - If you choose **ALL** in step 2\*<sup>1</sup>, and you press , all songs of the selected artist are played back. If you choose **ALL**, and you press , the **SONG** search mode for the selected artist is activated.
  - Artist name search cannot be made during **M.I.X.** play.
  - In the search mode, you can jump to an assigned position by pressing any one of buttons 1 through 6 for quick search purposes. For details, refer to “Direct Search Function” (page 47).



## Searching by album name

- 1 Press  to activate the search selection mode.
  - 2 Turn the Rotary encoder to select the **ALBUM** search mode, then press .
- PLAYLIST ↔ ARTIST ↔ ALBUM ↔ SONG ↔ PLAYLIST
- 3\*<sup>3</sup> Turn the Rotary encoder to select the desired **Album**.
  - 4 Press  to play back.
- The selected Album is played back.

## To search for a song of the selected album

- 1 After selecting the album in step 3\*<sup>3</sup>, press  to change to the song search mode of the selected album.
  - 2 Turn the Rotary encoder to select a song and press **MODE**.  
The selected song is played back.
- While in the search mode, if you press and hold  for at least 2 seconds, or no operation is performed for 10 seconds, the search mode is cancelled.
  - While in the search mode, pressing **FUNC.** will return to the previous mode.
  - If you choose **ALL** in step 3\*<sup>3</sup>, and you press , all songs in the iPod will be played back. If you choose **ALL**, and you press , the **SONG** search mode for all albums is activated.
  - Album name search cannot be made during **M.I.X.** play.
  - In the search mode, you can jump to an assigned position by pressing any one of buttons 1 through 6 for quick search purposes. For details, refer to “Direct Search Function” (page 47).

## Searching by song name

- 1 Press  to activate the search selection mode.
  - 2 Turn the Rotary encoder to select the **SONG** search mode, then press .
- PLAYLIST ↔ ARTIST ↔ ALBUM ↔ SONG ↔ PLAYLIST
- 3 Turn the Rotary encoder to select the desired **Song**.
  - 4 Press **MODE**.  
The selected song is played back.
- While in the search mode, if you press and hold  for at least 2 seconds, or no operation is performed for 10 seconds, the search mode is cancelled.
  - While in the search mode, pressing **FUNC.** will return to the previous mode.
  - Song name search cannot be made during **M.I.X.** play.
  - In the search mode, you can jump to an assigned position by pressing any one of buttons 1 through 6 for quick search purposes. For details, refer to “Direct Search Function” (page 47).

## Direct Search Function

The unit's direct search function can be used to search for an album, song, etc., more efficiently. In **PLAYLIST/ARTIST/ALBUM/SONG** mode, you can quickly target any song.

- 1 In the search mode, press any one of the buttons **1 through 6** to quickly jump skip over a designated percent of your song content.

SONG search example:

If there are 100 songs in your iPod, they are divided into 6 groups using percentages (shown below). These groups are assigned to buttons 1 through 6 on the unit.

Example 1:

Suppose the song you are searching for is located at around the middle (50%) of your library: press button 4 to jump to the 50<sup>th</sup> song and turn the Rotary encoder to find the song you desire.

Example 2:

Suppose the song you are searching for is located near the end (83%) of your library: press button 6 to jump to the 83<sup>rd</sup> song and turn the Rotary encoder to find song you desire.

		All 100 songs (100%)					
		0%	17%	33%	50%	67%	83%
Preset buttons		1	2	3	4	5	6
Songs		First song	17th song	33rd song	50th song	67th song	83rd song



---

## Select Playlist/Artist/Album

---

Playlist/Artist/Album can be easily changed.

For example, if you listen to a song from a selected album, the album can be changed.

### 1 Press ▲ or ▼ to select the desired Playlist/Artist/Album.

- If search selection mode is not activated, only SONG is searched, this operation is not possible.
- If an album is selected from an artist search, the album can be searched.
- During shuffle (M.I.X.) playback, this operation is not possible.

---

## Quick Search

---

You can search for songs.

### 1 Press and hold for at least 2 seconds to activate Quick Search mode.

### 2 Turn the Rotary encoder to select a desired song.

The selected song is played back immediately.

- While in the search mode, if you press and hold  for at least 2 seconds, or no operation is performed for 10 seconds, the search mode is cancelled.
- If there are many songs in iPod, it may take time to search for songs.

---

## Random Play Shuffle (M.I.X.)

---

The Shuffle function of the iPod is displayed as M.I.X. on the DVA-9861Ri.

### Shuffle Albums:

Album shuffle playback plays back all songs in order, then randomly selects the next album. All songs of that album are played back in order, and so on. Any one album is played just once.

### Shuffle Songs:

Song shuffle randomly plays back certain selected songs. Any one song plays back just once until all songs have been played back.

### 1 Press 5 .

The songs will be played back in random sequence.

 M.I.X. → M.I.X. → (off) →  M.I.X.  
(Shuffle Albums) (Shuffle Songs)

### 2 To cancel M.I.X. play, select (off) with the above procedure.

- For details of the search mode, refer to “Searching for a desired Song” (page 46).
- If a song is selected in the album search mode before selecting Shuffle (M.I.X.), the songs will not play back randomly even when Shuffle album is selected.

### Shuffle All:

Shuffle ALL plays all songs in the iPod randomly. Any one song does not play back again until all songs have been played back.

### 1 Press 6.

The songs will be played back in random sequence.

M.I.X. → (off) → M.I.X.  
(Shuffle ALL)

### 2 To cancel M.I.X. play, select (off) with the above procedure.

- If Shuffle All is selected, the selected songs which are being played back in the search mode are cancelled.

---

## Repeat Play

---

Only Repeat One is available for the iPod.



Repeat One: A single song is repeatedly played back.

### 1 Press 4.

The file will be played repeatedly.

RPT → (off) → RPT  
(Repeat One)

### 2 To cancel repeat play, select (off) with the above procedure.

- During repeat playback, no other songs are selectable by pressing  or .

---

## Displaying the Text

---

You can display the tag information of a song in the iPod.

### Press TITLE.

Each press changes the display.

TRACK No./ELAPSED TIME → TRACK No. / CLOCK →  
ARTIST NAME\* → ALBUM NAME\* → SONG TITLE\* →  
TRACK No./ELAPSED TIME

#### \* TAG information

If the Scroll setting (page 29) is set to “SCROLL AUTO,” the tag information will scroll automatically.

- \* “ARTIST”/“ALBUM”/“SONG” is displayed if there is no tag information.

- When the Scroll Setting (page 29) is set to “SCROLL MANU,” press and hold **TITLE** for at least 2 seconds to scroll the tag information only once.
- If the artist, album or song name, created in iTunes, has too many characters, songs may not be played back when connected to the adapter. Therefore, a maximum of 250 characters is recommended. The maximum number of characters for the head unit is 128 (128 byte).
- Some characters may not be correctly displayed.
- “NO SUPPORT” is displayed when text information is not compatible with the DVA-9861Ri.

# Changer (Optional)

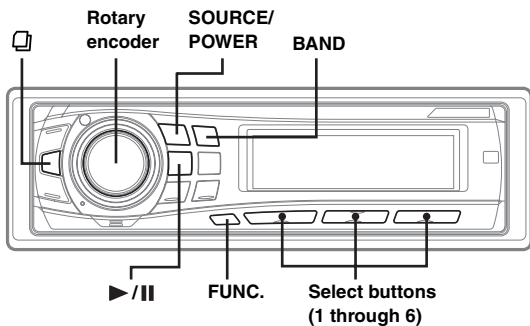

## Controlling CD Changer (Optional)

An optional 6-disc or 12-disc CD Changer may be connected to this unit if it is Ai-NET compatible. With a CD Changer connected to the Ai-NET input of this unit, the CD Changer will be controllable from this unit.

Using the KCA-400C (Multi-Changer Switching device) or the KCA-410C (Versatile Link Terminal) multiple changers can be controlled by this unit.

See "Multi-Changer Selection" on page 49 for selecting the CD Changers.

- The controls on this unit for CD Changer operation are operative only when a CD Changer is connected.
- The DVD changer (optional) is controllable from this unit as well as the CD changer.

### 1 Press SOURCE/POWER to activate the CHANGER mode.

The display shows the disc number and track number.

- The source indicator varies depending on the connected source.
- Press BAND to switch the Disc mode in the Changer mode.

### 2 Press the disc select buttons (1 through 6) corresponding to one of the discs loaded in the CD Changer.

The selected disc number appears in the display and CD playback starts.

- After selecting the desired disc, you can operate in the same way as for the CD player of this unit.  
For details, please see the CD/MP3/WMA section.
- If the "FUNC" indicator is illuminated, the disc select buttons become nonfunctional.

#### When a 12-disc CD Changer is connected:

To select discs numbered from 1 to 6, the procedure is the same as for the 6-disc CD Changer. To select discs numbered from 7 to 12, first press FUNC. to choose the disc select mode (7 to 12). This changes the "D" indicator to "d". Then press the desired select button. The select buttons 1 to 6 will represent discs 7 to 12 respectively.

## Quick Search

You can search for tracks (files).

### 1 Press and hold for at least 2 seconds in the Changer mode to activate Quick Search mode.

### 2 Turn the Rotary encoder within 10 seconds to select a desired track (file).

The selected track is played back immediately.

- Quick Search mode is canceled by pressing and holding  for at least 2 seconds.

## Playing MP3 Files with the CD Changer (Optional)

If you connect a changer compatible with MP3, you can play CD-ROMs, CD-Rs, and CD-RWs containing MP3 files on this unit.

### 1 Press SOURCE/POWER to switch to the MP3 Changer mode.

### 2 Press any one of the disc select buttons (1 through 6) corresponding to one of the discs loaded in the CD Changer.

### 3 To pause playback, press >/II.

Pressing >/II again will resume playback.

- The unit can play discs containing both audio data and MP3 data.
- For operating MP3 with an MP3 compatible CD Changer, refer to "CD/MP3/WMA" pages 14 to 18.

## Multi-Changer Selection (Optional)

Alpine's Ai-NET system will support up to 6 CD Changers. When operating two or more changers, the KCA-400C (Multi-Changer Switching device) must be used. If you use 1 Switching device, you can connect up to 4 CD Changers. If you use 2 Switching devices, you can connect up to 6 CD Changers. When using KCA-410C (Versatile Link Terminal), you can connect two changers and two external outputs (AUX).

### 1 Press SOURCE/POWER on this unit to activate the CD Changer mode.

### 2 Press BAND to activate the CD Changer Selection mode.

The CD Changer Selection mode remains active for several seconds.

### 3 Press BAND until the desired CD Changer indicator appears on the display.

- If the selected CD Changer is not connected, the display will show "NO CHGR-No."
- To operate the selected changer, see "CD/MP3/WMA" (page 14-18).
- For further details about the external input (AUX) when using KCA-410C, see "Setting the AUX Mode (V-Link)" on page 29.

# Remote Control

## Controls on Remote Control

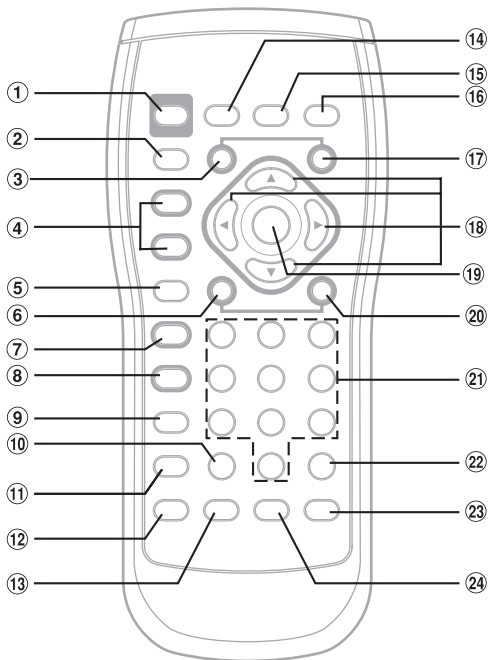

- ① **PWR Button**  
Turns the power ON and OFF.
- ② **SRC Button**  
Selects the audio source.
- ③ **DN Button**  
Radio mode: Selects, in descending order, stations programmed into the radio's presets.  
MP3/WMA mode:  
Folder Select (DN) Button selects the folder.  
DVD mode: Selects programme or playlist, in descending order (DVD-VR only).  
Changer mode:  
DISC Select (DN) Button selects a disc in descending order.  
MP3 compatible CD changer mode:  
Pressing and holding the DISC Select (DN) button will select a disc in descending order.  
iPod mode: Selects playlist/artist/album in descending order.
- ④ **VOLUME ▲ / ▼ Button**  
Increase or decreases the volume level.
- ⑤ **RETURN Button**  
DVD/Video CD (PBC ON) mode: Returns to the previous display. (Does not return in some discs.)

- ⑥ **◀◀ Button**  
Radio mode: SEEK (DN) button  
CD /Changer mode:  
Press the button to go back to the beginning of the current track. Press and hold to fast reverse.  
MP3/WMA/iPod mode:  
Press the button to go back to the beginning of the current file. Press and hold to fast reverse.  
DVD/Video CD:
  - Move to the desired position on the disc.
  - During playback, press and hold for more than 1 second to reverse the disc at double speed. Hold for more than 5 seconds to reverse the disc at 8 times the normal speed. Hold for more than 10 seconds to reverse the disc at 21 times the normal speed. However, during playback or pause, pressing and holding for at least 1 second will fast reverse the disc at 21 times the normal speed (DVD Audio (VOFF mode)only).
  - When pressed and held in while in the pause mode, the disc is played in reverse slow motion at 1/8th the normal speed. When held in for 5 more seconds, the reverse slow motion speed switches to 1/2 the normal speed (only DVD Video).
  - During pause, each time press once is played back frame by frame (only DVD Video).
- ⑦ **▶/|| Button**  
Switches between play and pause.  
**SEARCH Button**  
MP3/WMA mode: Pressing more than 2 seconds, activates the Folder/File Name Search mode.
- ⑧ **■ Button**  
Performs stop.  
DVD/Video CD: Pressing once sets the PRE- STOP; Pressing twice sets stop.
- ⑨ **MENU Button**  
DVD mode:
  - Shows the menu display (DVD Video, DVD Audio only).
  - Shows the playlist search list screen (DVD-VR only).
- ⑩ **CLR Button**  
Removes numbers (one character at a time) that have been selected and input.  
Press and hold for 2 seconds. All the characters which were selected and input are erased, or the input mode is cancelled.
- ⑪ **DISP./TOP M. Button**  
DVD/Video CD/MP3/WMA mode:  
Shows playback status.  
DVD mode:
  - By pressing more than 2 seconds, shows the menu display (DVD Video, DVD Audio only).
  - By pressing more than 2 seconds, shows the programme search list screen (DVD-VR only).
- ⑫ **SETUP Button**  
DVD SETUP list display appears.
- ⑬ **AUDIO Button**  
DVD/Video CD mode: Switches audio.

#### 14 BAND Button

Radio mode: Changes the band.  
CD/MP3/WMA/Changer mode:  
Switches the disc mode.

#### 15 A.PROC. Button

Press the button to call the audio processor list.

#### 16 MUTE Button

Lowers the volume by 20 dB instantly. Press the button again to cancel.

#### 17 UP Button

Radio mode: Selects, in ascending order, stations programmed into the radio's presets.  
MP3/WMA mode:  
Folder Select (UP) Button to select the folder.  
DVD-mode: Selects programme or playlist, in ascending order (DVD-VR only).  
Changer mode:  
DISC Select (UP) Button selects a disc in ascending order.  
MP3 compatible CD changer mode:  
Pressing and holding the DISC Select (UP) button will select a disc in ascending order.  
iPod mode: Selects a playlist/artist/album in ascending order.

#### 18 ▲, ▼, ◀, ▶

Selects an item displayed in the screen.

#### 19 ENT. Button

Enters the selected item.

#### 20 ►►| Button

Radio mode: SEEK (UP) button  
CD/Changer mode:  
Press the button to advance to the beginning of the next track. Press and hold to fast forward.  
MP3/WMA/iPod mode:  
Press the button to advance to the beginning of the next file. Press and hold to fast forward.

DVD/Video CD:

- Move to the desired position on the disc.
- During playback, press and hold for more than 1 second to forward the disc at double speed. Hold for more than 5 seconds to forward the disc at 8 times the normal speed. Hold for more than 10 seconds to forward the disc at 21 times the normal speed. However, during playback or pause, pressing and holding for at least 1 second will fast forward the disc at 21 times the normal speed (DVD Audio (VOFF mode) only).
- When pressed and held in while in the pause mode, the disc is played in slow motion at 1/8th the normal speed. When held in for 5 more seconds, the slow motion speed switches to 1/2 the normal speed (DVD-Video, DVD-VR, Video CD only).
- The picture is forwarded by one frame each time the button is pressed in the pause mode (DVD-Video, DVD-VR, Video CD only).

#### 21 Numeric Keypad

Inputs numbers.

#### 22 MONITOR Button

Not used.

#### 23 ANGLE Button

DVD mode: Switches the angle of the picture.

#### 24 SUBTITLE Button

DVD mode: Switches the subtitle.

## When Using the Remote Control

- Point the remote control at the remote sensor within about 2 meters.
- It may not be possible to operate the remote control if the remote control sensor is exposed to direct sunlight.
- The remote control is a small, lightweight precision device. To avoid damage, short battery life, operational errors and poor response, observe the following.
  - Do not subject the remote control to excessive shock.
  - Do not put in a trouser pocket.
  - Keep away from food, moisture and dirt.
  - Do not place in direct sunshine.

## Battery Replacement

Battery type: CR2025 battery or equivalent.

### 1 Opening the battery case

Slide out the battery cover while firmly pressing in the direction of the arrow.

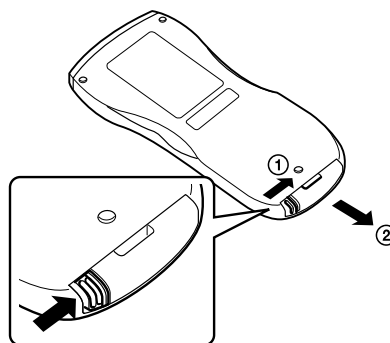

### 2 Replacing the battery

Put the battery in the case with the (+) indication upward as shown in the illustration.

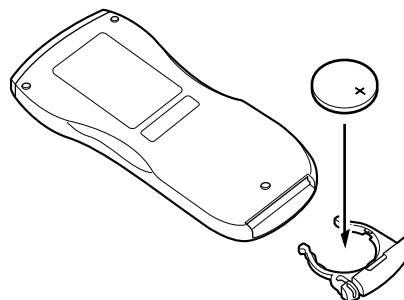

- Placing a battery in backwards way may cause a malfunction.

### 3 Closing the cover

Slide the cover as illustrated until a click is heard.

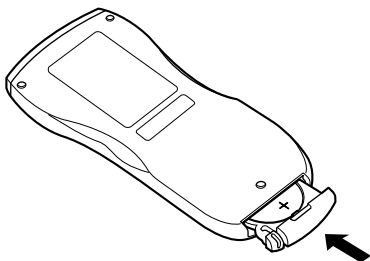

#### Warning

**DO NOT OPERATE ANY FUNCTION THAT TAKES YOUR ATTENTION AWAY FROM SAFELY DRIVING YOUR VEHICLE.**

Any function that requires your prolonged attention should only be performed after coming to a complete stop. Always stop the vehicle in a safe location before performing these functions. Failure to do so may result in an accident.

#### **Controllable With Remote Control**

Point the remote control transmitter at the remote control sensor.

Remote control sensor

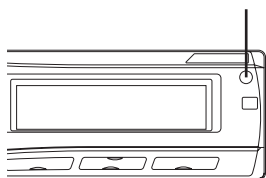

#### **Connectable to Remote Control Interface Box**

You can operate this unit from the vehicle's control unit when an Alpine Remote Control Interface Box (optional) is connected. For details, contact your Alpine dealer.

## Information

### About DVDs

Music CDs and DVDs have grooves (tracks) in which the digital data is recorded. The data is represented as microscopic pits recorded into the track these pits are read by a laser beam to play the disc. On DVDs, the density of the tracks and pits is twice that of CDs, so DVDs can contain more data in less space.

#### CDs

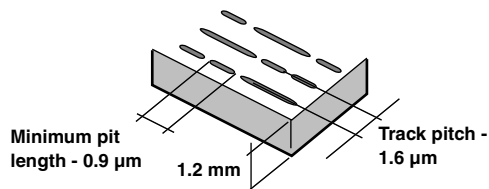

#### DVDs

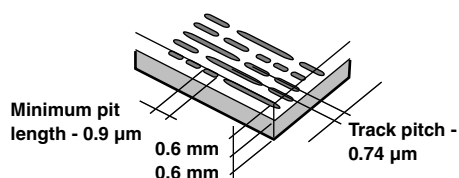

A 12 cm disc can contain one movie or about four hours of music. In addition, DVDs provide sharp picture quality with vivid colours thanks to a horizontal resolution of over 500 lines (compared to less than 300 for VHS tape). With the addition of an optional, digital audio processor (PXA-H900, PXA-H701, etc.), you can recreate the power and presence of a movie theatre with Dolby Digital 5.1-channel Surround.

#### In addition, DVDs offer a variety of functions.

- **Multiple audio\*** (page 23)  
Movies can be recorded in up to eight languages. The desired language can be selected from the remote control.
- **Subtitles function\*** (page 23)  
Movies can include subtitles in up to 32 languages. The desired subtitle language can be selected from the remote control.
- **Multi angle function\*** (page 23)  
When the DVD contains a movie shot from multiple angles, the desired angle can be selected from the remote control.
- **Multi story function\***  
With this function, a single movie includes various story lines. You can select different story lines to view various versions of the same movie.  
Operation differs from disc to disc. Story line selection screens including instructions appear during the movie. Just follow the instructions.

\* The functions, audio languages, subtitle languages, angles, etc., differ from disc to disc. For details, refer to the disc's instructions.

## Terminology

### Dolby Digital

Dolby Digital is a digital audio compression technology developed by Dolby Laboratories that allows large quantities of audio data to be efficiently recorded on discs. It is compatible with audio signals from mono (1 channel) all the way up to 5.1-channel surround sound. The signals for the different channels are completely independent, and since the sound is high quality digital there is no loss of sound quality.

\* *The separately sold digital audio processor (PXA-H900, PXA-H701, etc.) is required to enjoy full 5.1-channel surround sound.*

The DVA-9861Ri performs Dolby Digital decoding when it outputs analog audio signals; 2-channel audio, not 5.1-channel.

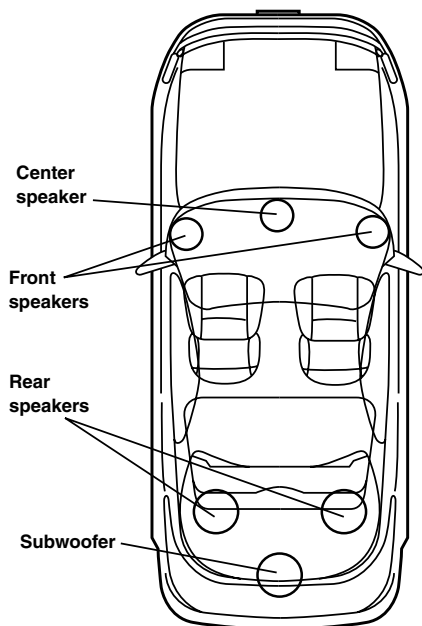

**Speaker layout for enjoying  
Dolby Digital sound/DTS sound**

### DTS

This is a home-use digital sound format of the DTS Sound System. This is a high quality sound system, developed by Digital Theater Systems, Inc. for use in movie theatres.

DTS has six independent sound tracks. The theatre presentation is fully realized in the home, etc. DTS is the abbreviation for Digital Theater System.

\* *To enjoy DTS surround sound you need the separately sold DTS digital audio processor (PXA-H900, PXA-H701, etc.). The DVD video software must also have a DTS sound track.*

The DVA-9861Ri has a built-in DTS 2-channel audio decoder. Analog audio outputs are available.

### Dolby Pro Logic

Dolby Pro Logic is the technology used to decode programs encoded in Dolby Surround. Pro logic decoding will provide you with four channels of sound (front left/right, centre and monaural rear surround) from a 2-channel (stereo) source.

\* *The separately sold digital audio processor (PXA-H900) is required to enjoy Dolby Pro Logic surround sound.*

### Dolby Pro Logic II

Dolby Pro Logic II plays 2-channel sources in 5 channels over the entire frequency range.

This is done with an advanced, high sound quality matrix surround decoder which draws out the spatial properties of the original recording without adding any sounds to or changing the sound of the source.

\* *The separately sold digital audio processor (PXA-H701, etc.) is required to enjoy Dolby Pro Logic II surround sound.*

### Linear PCM audio (LPCM)

LPCM is a signal recording format used for music CDs. Whereas music CDs are recorded at 44.1 kHz/16 bits, DVDs are recorded at 48 kHz/16 bits to 96 kHz/24 bits, thereby achieving higher sound quality than music CDs.

### Rating levels (parental lock)

This is a DVD function for restricting the viewing age as stipulated by censorship laws in different countries. The way in which viewing is restricted differs from DVD to DVD. Sometimes the DVD cannot be played at all, other times certain scenes are skipped, and other times certain scenes are replaced with other scenes.

## List of Language Codes

(For details, see page 31.)

Abbreviation	Code	Language	Abbreviation	Code	Language	Abbreviation	Code	Language
AA	6565	Afar	IE	7369	Interlingue	RN	8278	Kirundi
AB	6566	Abkhazian	IK	7375	Inupiak	RO	8279	Romanian
AF	6570	Afrikaans	IN	7378	Indonesian	RU	8285	Russian
AM	6577	Amharic	IS	7383	Icelandic	RW	8287	Kinyarwanda
AR	6582	Arabic	IT	7384	Italian	SA	8365	Sanskrit
AS	6583	Assamese	IW	7387	Hebrew	SD	8368	Sindhi
AY	6589	Aymara	JA	7465	Japanese	SG	8371	Sangho
AZ	6590	Azerbaijani	JL	7473	Yiddish	SH	8372	Serbo-Croatian
BA	6665	Bashkir	JW	7487	Javanese	SI	8373	Singhalese
BE	6669	Byelorussian	KA	7565	Georgian	SK	8375	Slovak
BG	6671	Bulgarian	KK	7575	Kazakh	SL	8376	Slovenian
BH	6672	Bihari	KL	7576	Greenlandic	SM	8377	Samoan
BI	6673	Bislama	KM	7577	Cambodian	SN	8378	Shona
BN	6678	Bengali, Bangla	KN	7578	Kannada	SO	8379	Somali
BO	6679	Tibetan	KO	7579	Korean	SQ	8381	Albanian
BR	6682	Breton	KS	7583	Kashmiri	SR	8382	Serbian
CA	6765	Catalan	KU	7585	Kurdish	SS	8383	Siswati
CO	6779	Corsican	KY	7589	Kirghiz	ST	8384	Sesotho
CS	6783	Czech	LA	7665	Latin	SU	8385	Sundanese
CY	6789	Welsh	LN	7678	Lingala	SV	8386	Swedish
DA	6865	Danish	LO	7679	Laothian	SW	8387	Swahili
DE	6869	German	LT	7684	Lithuanian	TA	8465	Tamil
DZ	6890	Bhutani	LV	7686	Latvian, Lettish	TE	8469	Telugu
EL	6976	Greek	MG	7771	Malagasy	TG	8471	Tajik
EN	6978	English	MI	7773	Maori	TH	8472	Thai
EO	6979	Esperanto	MK	7775	Macedonian	TI	8473	Tigrinya
ES	6983	Spanish	ML	7776	Malayalam	TK	8475	Turkmen
ET	6984	Estonian	MN	7778	Mongolian	TL	8476	Tagalog
EU	6985	Basque	MO	7779	Moldavian	TN	8478	Setswana
FA	7065	Persian	MR	7782	Marathi	TO	8479	Tonga
FI	7073	Finnish	MS	7783	Malay	TR	8482	Turkish
FJ	7074	Fiji	MT	7784	Maltese	TS	8483	Tsonga
FO	7079	Faroese	MY	7789	Burmese	TT	8484	Tatar
FR	7082	French	NA	7865	Nauru	TW	8487	Twi
FY	7089	Frisian	NE	7869	Nepali	UK	8575	Ukrainian
GA	7165	Irish	NL	7876	Dutch	UR	8582	Urdu
GD	7168	Scots Gaelic	NO	7879	Norwegian	UZ	8590	Uzbek
GL	7176	Galician	OC	7967	Occitan	VI	8673	Vietnamese
GN	7178	Guarani	OM	7977	(Afan) Oromo	VO	8679	Volapuk
GU	7185	Gujarati	OR	7982	Oriya	WO	8779	Wolof
HA	7265	Hausa	PA	8065	Punjabi	XH	8872	Xhosa
HI	7273	Hindi	PL	8076	Polish	YO	8979	Yoruba
HR	7282	Croatian	PS	8083	Pashto, Pushto	ZH	9072	Chinese
HU	7285	Hungarian	PT	8084	Portuguese	ZU	9085	Zulu
HY	7289	Armenian	QU	8185	Quechua			
IA	7365	Interlingua	RM	8277	Rhaeto-Romance			



## List of Country Codes

(For details, see page 31.)

Abbreviation	Code	Country	Abbreviation	Code	Country	Abbreviation	Code	Country
AD	6568	Andorra	DM	6877	Dominica	KI	7573	Kiribati
AE	6569	United Arab Emirates	DO	6879	Dominican Republic	KM	7577	Comoros
AF	6570	Afghanistan	DZ	6890	Algeria	KN	7578	Saint Kitts and Nevis
AG	6571	Antigua and Barbuda	EC	6967	Ecuador	KP	7580	Korea, Democratic People's Republic of
AI	6573	Anguilla	EE	6969	Estonia			
AL	6576	Albania	EG	6971	Egypt	KR	7582	Korea, Republic of
AM	6577	Armenia	EH	6972	Western Sahara	KW	7587	Kuwait
AN	6578	Netherlands Antilles	ER	6982	Eritrea	KY	7589	Cayman Islands
AO	6579	Angola	ES	6983	Spain	KZ	7590	Kazakhstan
AQ	6581	Antarctica	ET	6984	Ethiopia	LA	7665	Lao People's Democratic Republic
AR	6582	Argentina	FI	7073	Finland			
AS	6583	American Samoa	FJ	7074	Fiji	LB	7666	Lebanon
AT	6584	Austria	FK	7075	Falkland Islands	LC	7667	Saint Lucia
AU	6585	Australia	FM	7077	Micronesia, Federated States of	LI	7673	Liechtenstein
AW	6587	Aruba	FO	7079	Faroe Islands	LK	7675	Sri Lanka
AZ	6590	Azerbaijan	FR	7082	France	LR	7682	Liberia
BA	6665	Bosnia and Herzegovina	GA	7165	Gabon	LS	7683	Lesotho
BB	6666	Barbados	GB	7166	United Kingdom	LT	7684	Lithuania
BD	6668	Bangladesh	GD	7168	Grenada	LU	7685	Luxembourg
BE	6669	Belgium	GE	7169	Georgia	LV	7686	Latvia
BF	6670	Burkina Faso	GF	7170	French Guiana	LY	7689	Libyan Arab Jamahiriya
BG	6671	Bulgaria	GH	7172	Ghana	MA	7765	Morocco
BH	6672	Bahrain	GI	7173	Gibraltar	MC	7767	Monaco
BI	6673	Burundi	GL	7176	Greenland	MD	7768	Moldova, Republic of
BJ	6674	Benin	GM	7177	Gambia	MG	7771	Madagascar
BM	6677	Bermuda	GN	7178	Guinea	MH	7772	Marshall Islands
BN	6678	Brunei Darussalam	GP	7180	Guadeloupe	MK	7775	Macedonia, The former Yugoslav Republic of
BO	6679	Bolivia	GQ	7181	Equatorial Guinea			
BR	6682	Brazil	GR	7182	Greece	ML	7776	Mali
BS	6683	Bahamas	GS	7183	South Georgia and the South Sandwich Islands	MM	7777	Myanmar
BT	6684	Bhutan				MN	7778	Mongolia
BV	6686	Bouvet Island	GT	7184	Guatemala	MO	7779	Macau
BW	6687	Botswana	GU	7185	Guam	MP	7780	Northern Mariana Islands
BY	6689	Belarus	GW	7187	Guinea-Bissau	MQ	7781	Martinique
BZ	6690	Belize	GY	7189	Guyana	MR	7782	Mauritania
CA	6765	Canada	HK	7275	Hong Kong	MS	7783	Montserrat
CC	6767	Cocos (Keeling) Islands	HM	7277	Heard Island and McDonald Islands	MT	7784	Malta
CD	6768	Congo, the Democratic Republic of the	HN	7278	Honduras	MU	7785	Mauritius
CF	6770	Central African Republic	HR	7282	Croatia	MV	7786	Maldives
CG	6771	Congo	HT	7284	Haiti	MW	7787	Malawi
CH	6772	Switzerland	HU	7285	Hungary	MX	7788	Mexico
CI	6773	Cote d'Ivoire	ID	7368	Indonesia	MY	7789	Malaysia
CK	6775	Cook Islands	IE	7369	Ireland	MZ	7790	Mozambique
CL	6776	Chile	IL	7376	Israel	NA	7865	Namibia
CM	6777	Cameroon	IN	7378	India	NC	7867	New Caledonia
CN	6778	China	IO	7379	British Indian Ocean Territory	NE	7869	Niger
CO	6779	Colombia	IQ	7381	Iraq	NF	7870	Norfolk Island
CR	6782	Costa Rica	IR	7382	Iran, Islamic Republic of	NG	7871	Nigeria
CU	6785	Cuba	IS	7383	Iceland	NI	7873	Nicaragua
CV	6786	Cape Verde	IT	7384	Italy	NL	7876	Netherlands
CX	6788	Christmas Island	JM	7477	Jamaica	NO	7879	Norway
CY	6789	Cyprus	JO	7479	Jordan	NP	7880	Nepal
CZ	6790	Czech Republic	JP	7480	Japan	NR	7882	Nauru
DE	6869	Germany	KE	7569	Kenya	NU	7885	Niue
DJ	6874	Djibouti	KG	7571	Kyrgyzstan	NZ	7890	New Zealand
DK	6875	Denmark	KH	7572	Cambodia	OM	7977	Oman
						PA	8065	Panama



Abbreviation	Code	Country	Abbreviation	Code	Country	Abbreviation	Code	Country
PE	8069	Peru	SJ	8374	Svalbard and Jan Mayen	TW	8487	Taiwan, Province of China
PF	8070	French Polynesia	SK	8375	Slovakia	TZ	8490	Tanzania, United Republic of
PG	8071	Papua New Guinea	SL	8376	Sierra Leone	UA	8565	Ukraine
PH	8072	Philippines	SM	8377	San Marino	UG	8571	Uganda
PK	8075	Pakistan	SN	8378	Senegal	UM	8577	United States Minor Outlying Islands
PL	8076	Poland	SO	8379	Somalia	US	8583	United States
PM	8077	Saint Pierre and Miquelon	SR	8382	Suriname	UY	8589	Uruguay
PN	8078	Pitcairn	ST	8384	Sao Tome and Principe	UZ	8590	Uzbekistan
PR	8082	Puerto Rico	SV	8386	El Salvador	VA	8665	Holy See (Vatican City State)
PT	8084	Portugal	SY	8389	Syrian Arab Republic	VC	8667	Saint Vincent and the Grenadines
PW	8087	Palau	SZ	8390	Swaziland	VE	8669	Venezuela
PY	8089	Paraguay	TC	8467	Turks and Caicos Islands	VG	8671	Virgin Island, British
QA	8165	Qatar	TD	8468	Chad	VI	8673	Virgin Islands, U.S
RE	8269	Reunion	TF	8470	French Southern Territories	VN	8678	Viet Nam
RO	8279	Romania	TG	8471	Togo	VU	8685	Vanuatu
RU	8285	Russian Federation	TH	8472	Thailand	WF	8770	Wallis and Futuna
RW	8287	Rwanda	TJ	8474	Tajikistan	WS	8783	Samoa
SA	8365	Saudi Arabia	TK	8475	Tokelau	YE	8969	Yemen
SB	8366	Solomon Islands	TM	8477	Turkmenistan	YT	8984	Mayotte
SC	8367	Seychelles	TN	8478	Tunisia	YU	8985	Yugoslavia
SD	8368	Sudan	TO	8479	Tonga	ZA	9065	South Africa
SE	8369	Sweden	TP	8480	East Timor	ZM	9077	Zambia
SG	8371	Singapore	TR	8482	Turkey	ZW	9087	Zimbabwe
SH	8372	Saint Helena	TT	8484	Trinidad and Tobago			
SI	8373	Slovenia	TV	8486	Tuvalu			

## In Case of Difficulty

If you encounter a problem, please turn the power off, then on again. If the unit is still not functioning normally, please review the items in the following checklist. This guide will help you isolate the problem if the unit is at fault. Otherwise, make sure the rest of your system is properly connected or consult your authorized Alpine dealer.

### Basic

#### No function or display.

- Vehicle's ignition is off.
  - If connected following instructions, the unit will not operate with the vehicle's ignition off.
- Improper power lead (Red) and battery lead (Yellow) connections.
  - Check power lead and battery lead connections.
- Blown fuse.
  - Check the fuse of the unit; replace with the proper value if necessary.
- Internal micro-computer malfunctioned due to interference noise etc.
  - Press the RESET switch with a ballpoint pen or other pointed article.

#### Unit does not operate.

- Monitor's power is not turned on.
  - Turn on the monitor's power.
- Condensation.
  - Wait a while (about 1 hour) for the condensation to dry.

#### No picture is produced.

- Monitor's mode is not switched to the mode you want to see.
  - Switch to the mode you want to see.
- Monitor's parking brake wire is not connected.
  - Connect the monitor's parking brake wire and set the parking brake. (For details, refer to the monitor's instructions.)

#### Picture is unclear or noisy.

- Disc is being fast-forwarded or fast-reversed.
  - The picture may be unclear, but this is normal.
- Vehicle's battery power is weak.
  - Check the battery power and wiring.  
(The unit may malfunction if the battery power is under 11 volts with a load applied.)
- Monitor's fluorescent tube is worn out.
  - Replace the monitor's fluorescent tube.

## Radio

#### Unable to receive stations.

- No antenna or open connection in cable.
  - Make sure the antenna is properly connected; replace the antenna or cable if necessary.

#### Unable to tune stations in the seek mode.

- You are in a weak signal area.
  - Make sure the tuner is in the DX mode.
- If the area you are in is a primary signal area, the antenna may not be grounded and connected properly.
  - Check your antenna connections; make sure the antenna is properly grounded at its mounting location.
- The antenna may not be the proper length.
  - Make sure the antenna is fully extended; if broken, replace the antenna with a new one.

#### Broadcast is noisy.

- The antenna is not the proper length.
  - Extend the antenna fully; replace it if it is broken.
- The antenna is poorly grounded.
  - Make sure the antenna is grounded properly at its mounting location.

## CD/MP3/WMA/DVD/Video CD

#### Disc Player not functioning.

- Out of operating temperature range +50°C (+120°F) for CD.
  - Allow the vehicle's interior (or trunk) temperature to cool.

#### Disc playback sound is wavering.

- Moisture condensation in the disc unit.
  - Allow enough time for the condensation to evaporate (about 1 hour).

#### Disc insertion not possible.

- A disc is already in the DVD player.
  - Eject the disc and remove it.
- The disc is being improperly inserted.
  - Re-insert the disc following the instructions in the "loading and unloading discs" section.

#### Unable to fast forward or reverse the disc.

- The disc has been damaged.
  - Eject the disc and discard it; using a damaged disc in your unit can cause damage to the mechanism.

#### Disc playback sound skips due to vibration.

- Improper mounting of the unit.
  - Securely re-mount the unit.
- The disc is very dirty.
  - Clean the disc.
- The disc has scratches.
  - Change the disc.
- The pick-up lens is dirty.
  - Do not use a commercial available lens cleaner disc.  
Consult your nearest ALPINE dealer.

### Disc playback sound skips without vibration.

- The disc is dirty or scratched.
  - Clean the disc; damaged disc should be replaced.

### CD-R/CD-RW playback not possible.

- Close session (finalization) has not been performed.
  - Perform finalization and attempt playback again.

### Error displays

- Mechanical error
  - Press **▲**. After the error indication disappears, insert the disc again. If the above-mentioned solution does not solve the problem, consult your nearest ALPINE dealer.

### MP3 is not played back.

- Writing error occurred. The CD format is not compatible.
  - Make sure the CD has been written in a supported format. Refer to "About MP3/WMA" on pages 17-18, then rewrite in the format supported by this device.

### Playback does not start.

- Disc is loaded upside-down.
  - Check the disc and load it with the labeled side facing upward.
- Disc is dirty.
  - Clean the disc.
- A disc not able to playback with this unit is loaded.
  - Check if the disc is able to be played back.
- Parental lock is set.
  - Cancel the parental lock or change the rating level.

### Image stops sometimes.

- Disc is scratched.
  - Replace with a non-scratched disc.

## Audio

### The sound is not output from the speakers.

- Unit has no output signal of the internal amplifier.
  - POWER IC is switched to "ON" (page 30).

## Indication for CD Player

### HI TEMP

- Protective circuit is activated due to high temperature.
  - The indicator will disappear when the temperature returns to within operation range.

### NO DISC

- No CD is inserted.
  - Insert a CD.
- Although a disc is inserted, "NO DISC" is displayed and the unit does not start to play or eject the disc.
  - Remove the disc by following these steps:
    - Press the **▲** button again for at least 2 seconds.
    - If the disc still does not eject, consult your Alpine dealer.

### ERROR

- Mechanism error.
  - 1) Press the **▲** button and eject the CD.
    - If not ejecting, consult your Alpine dealer.
  - 2) When the error indication remains after ejecting, press the **▲** button again.
    - If the error indication still does not turn off after pressing the **▲** button for a few times, consult your Alpine dealer.
- When "ERROR" is displayed:
  - If that the disc cannot be ejected by pressing **▲**, press the RESET switch (refer to page 9) and press **▲** again.
  - If the disc still cannot be ejected, consult your Alpine dealer.

### PROTECT

- A copy-protected WMA file was played back.
  - You can only play back non-copy-protected files.

### UNSUPPORTED

- The disc is not written in a MP3/WMA supported format.
  - Use a disc written at the MP3/WMA supported format.





## Indication for DVD/Video CD Player

DISC ERROR

(Monitor display)

ERROR

(Audio display)

- Mechanism error.
  - 1) Press  and eject the disc.  
If the disc does not eject, press  again for at least 2 seconds and eject the disc.  
If the disc still does not eject, consult your Alpine dealer.
  - 2) When the error indication remains after ejecting, press  again.  
If the error indication still does not turn off after pressing  a few times, consult your Alpine dealer.

NO DISC

(Monitor display)

NO DISC

(Audio display)

- No disc is inserted.
  - Insert a disc.
- Although a disc is inserted, "NO DISC" is displayed and the unit does not start to play or eject the disc.
  - Remove the disc by following step:  
Press  again for at least 2 seconds.



(Monitor display)

- Remote control operation is not possible.
  - For some discs or playing modes, certain operations are not possible. This is not a malfunction.

REGIONAL CODE  
VIOLATION

(Monitor display)

ERROR

(Audio display)

- Disc does not match regional code number.
  - Load a disc that matches the regional code number.

HI-TEMP

(Monitor display)

HI TEMP

(Audio display)

- Protective circuit is activated due to high temperature.
  - The indicator will disappear when the temperature returns to within operation range.
  - Leave the power OFF until the temperature decreases and then turn the power ON again.





LOADING ERROR

ERROR

(Audio display)

EJECT ERROR

(Monitor display)

- Mechanism error.
  - 1) Press  and eject the disc.  
If the disc does not eject, press  again for at least 2 seconds and eject the disc.  
If the disc still does not eject, consult your Alpine dealer.
  - 2) When the error indication remains after ejecting, press  again.  
If the error indication still does not turn off after pressing  a few times, consult your Alpine dealer.

## Indication for Changer

### HI TEMP

- Protective circuit is activated due to high temperature.
    - The indicator will disappear when the temperature returns to within operation range.
- 

### ERROR-01

- Malfunction in the Changer.
    - Consult your Alpine dealer. Press the magazine eject button and pull out the magazine.  
Check the indication. Insert the magazine again.  
If the magazine cannot be pulled out, consult your Alpine dealer.
  - Magazine ejection not possible.
    - Press the magazine eject button. If the magazine does not eject, consult your Alpine dealer.
- 

### ERROR-02

- A disc is left inside the Changer.
    - Press the eject button to activate the eject function. When the Changer finishes the eject function, insert an empty magazine into the Changer to receive the disc left inside the Changer.
- 

### NO MAGZN

- No magazine is loaded into the Changer.
    - Insert a magazine.
- 

### NO DISC

- No indicated disc.
    - Choose another disc.
- 

## Indication for iPod Mode

### NO IPOD

- The iPod is not connected.
    - Make sure the iPod is correctly connected (refer to “Connections”).  
Make sure the cable is not bent excessively.
  - The iPod’s battery remains low.
    - Refer to the iPod’s documentation and charge the battery.
- 

### NO SONG

- There are no songs in the iPod.
    - Download songs to the iPod and connect to the adapter.
- 

### ERROR-01

- Communication error
    - Turn the ignition key off, and then set to ON again.
    - Check the display by reconnecting between the iPod and the adapter, using the iPod connection cable.
- 

### ERROR-02

- Caused by the iPod Software Version not being compatible with this unit.
    - Update the iPod Software Version to be compatible with this unit.
-

# Specifications

## FM TUNER SECTION

Tuning Range	87.5 – 108.0 MHz
Mono Usable Sensitivity	0.7 $\mu$ V
Alternate Channel Selectivity	80 dB
Signal-to-Noise Ratio	65 dB
Stereo Separation	35 dB
Capture Ratio	2.0 dB

## MW TUNER SECTION

Tuning Range	531 – 1,602 kHz
Sensitivity (IEC Standard)	25.1 $\mu$ V/28 dB

## LW TUNER SECTION

Tuning Range	153 – 281 kHz
Sensitivity (IEC Standard)	31.6 $\mu$ V/30 dB

## CD/DVD SECTION

Frequency Response	5 – 20,000 Hz ( $\pm$ 1 dB)
Wow & Flutter (% WRMS)	Below measurable limits
Total Harmonic Distortion	0.008% (at 1 kHz)
Dynamic Range	95 dB (at 1 kHz)
Channel Separation	85 dB (at 1 kHz)
Signal system	NTSC/PAL
Horizontal resolution	500 lines or greater
Video output level	1Vp-p (75 ohms)
Video S/N ratio	DVD: 60 dB
Audio S/N ratio	105 dB

## PICKUP

Wave length	DVD: 665 nm CD: 785 nm
Laser power	CLASS II

## REMOTE CONTROL

Battery Type	CR2025 battery
Width	51 mm (2")
Height	119 mm (4-11/16")
Depth	13 mm (1/2")
Weight	50 g (1.75 oz) (battery excluded)

## GENERAL

Power Requirement	14.4 V DC (11 – 16 V allowable)
Maximum Power Output	50 W $\times$ 4
Maximum Pre-Output Voltage	4 V/10k ohms
Bass	+20/-14 dB at 60 Hz
Treble	$\pm$ 14 dB at 10 kHz
Weight	1.6 kg (3 lbs. 8 oz)

## CHASSIS SIZE

Width	178 mm (7")
Height	50 mm (2")
Depth	166 mm (6-9/16")

## NOSEPIECE SIZE

Width	170 mm (6-3/4")
Height	46 mm (1-13/16")
Depth	18 mm (11/16")

- *Due to continuous product improvement, specifications and design are subject to change without notice.*

## CAUTION



(Bottom side of player)

CAUTION-Laser radiation when open, DO NOT STARE INTO BEAM

(Bottom side of player)

---

---

# Installation and Connections

Before installing or connecting the unit, please read the following and pages 4 and 5 of this manual thoroughly for proper use.

## Warning

---

### MAKE THE CORRECT CONNECTIONS.

Failure to make the proper connections may result in fire or product damage.

---

### USE ONLY IN CARS WITH A 12 VOLT NEGATIVE GROUND.

(Check with your dealer if you are not sure.) Failure to do so may result in fire, etc.

---

### BEFORE WIRING, DISCONNECT THE CABLE FROM THE NEGATIVE BATTERY TERMINAL.

Failure to do so may result in electric shock or injury due to electrical shorts.

---

### DO NOT SPLICE INTO ELECTRICAL CABLES.

Never cut away cable insulation to supply power to other equipment. Doing so will exceed the current carrying capacity of the wire and result in fire or electric shock.

---

### DO NOT DAMAGE PIPE OR WIRING WHEN DRILLING HOLES.

When drilling holes in the chassis for installation, take precautions so as not to contact, damage or obstruct pipes, fuel lines, tanks or electrical wiring. Failure to take such precautions may result in fire.

---

### DO NOT USE BOLTS OR NUTS IN THE BRAKE OR STEERING SYSTEMS TO MAKE GROUND CONNECTIONS.

Bolts or nuts used for the brake or steering systems (or any other safety-related system), or tanks should NEVER be used for installations or ground connections. Using such parts could disable control of the vehicle and cause fire etc.

---

### KEEP SMALL OBJECTS SUCH AS BATTERY OUT OF THE REACH OF CHILDREN.

Swallowing them may result in serious injury. If swallowed, consult a physician immediately.

---

### DO NOT INSTALL IN LOCATIONS WHICH MIGHT HINDER VEHICLE OPERATION, SUCH AS THE STEERING WHEEL OR SHIFT LEVER.

Doing so may obstruct forward vision or hamper movement etc. and results in serious accident.

## Caution

---

### HAVE THE WIRING AND INSTALLATION DONE BY EXPERTS.

The wiring and installation of this unit requires special technical skill and experience. To ensure safety, always contact the dealer where you purchased this product to have the work done.

---

### USE SPECIFIED ACCESSORY PARTS AND INSTALL THEM SECURELY.

Be sure to use only the specified accessory parts. Use of other than designated parts may damage this unit internally or may not securely install the unit in place. This may cause parts to become loose resulting in hazards or product failure.

---

### ARRANGE THE WIRING SO IT IS NOT CRIMPED OR PINCHED BY A SHARP METAL EDGE.

Route the cables and wiring away from moving parts (like the seat rails) or sharp or pointed edges. This will prevent crimping and damage to the wiring. If wiring passes through a hole in metal, use a rubber grommet to prevent the wire's insulation from being cut by the metal edge of the hole.

---

### DO NOT INSTALL IN LOCATIONS WITH HIGH MOISTURE OR DUST.

Avoid installing the unit in locations with high incidence of moisture or dust. Moisture or dust that penetrates into this unit may result in product failure.

---

## Precautions

- Be sure to disconnect the cable from the (–) battery post before installing your DVA-9861Ri. This will reduce any chance of damage to the unit in case of a short-circuit.
- Be sure to connect the colour coded leads according to the diagram. Incorrect connections may cause the unit to malfunction or damage to the vehicle's electrical system.
- When making connections to the vehicle's electrical system, be aware of the factory installed components (e.g. on-board computer). Do not tap into these leads to provide power for this unit. When connecting the DVA-9861Ri to the fuse box, make sure the fuse for the intended circuit of the DVA-9861Ri has the appropriate amperage. Failure to do so may result in damage to the unit and/or the vehicle. When in doubt, consult your ALPINE dealer.
- The DVA-9861Ri uses female RCA-type jacks for connection to other units (e.g. amplifier) having RCA connectors. You may need an adaptor to connect other units. If so, please contact your authorized ALPINE dealer for assistance.
- Be sure to connect the speaker (–) leads to the speaker (–) terminal. Never connect left and right channel speaker cables to each other or to the vehicle body.

---

#### IMPORTANT

Please record the serial number of your unit in the space provided below and keep it as a permanent record. The serial number or the engraved serial number is located on the bottom of the unit.

SERIAL NUMBER: \_\_\_\_\_

INSTALLATION DATE: \_\_\_\_\_

INSTALLATION TECHNICIAN: \_\_\_\_\_

PLACE OF PURCHASE: \_\_\_\_\_

# Installation

## Caution

Do not block the unit's fan or heat sink, thus preventing air circulation. If blocked, heat will accumulate inside the unit and may cause a fire.

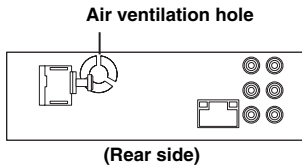

## Accessory List

- Head unit ..... 1
- Power cable ..... 1
- FULL SPEED™ Connection Cable ..... 1
- Mounting sleeve ..... 1
- Carrying case ..... 1
- Rubber Cap ..... 1
- Hex Bolt ..... 1
- Screw (M5x8) ..... 4
- RCA extension cable (Video) (2m) ..... 1
- Remote control ..... 1
- Battery (CR2025) ..... 1
- Owner's Manual ..... 1 set

• The main unit must be mounted within 35 degrees of the horizontal plane, back to front.

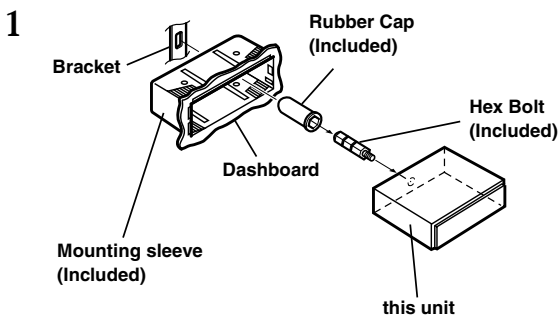
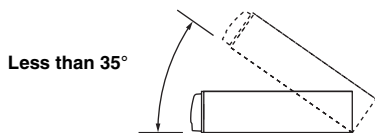

Slide mounting sleeve from main unit (see "Removal" on page 64). Slide the mounting sleeve into the dashboard and fix it with the metal shackles.

2

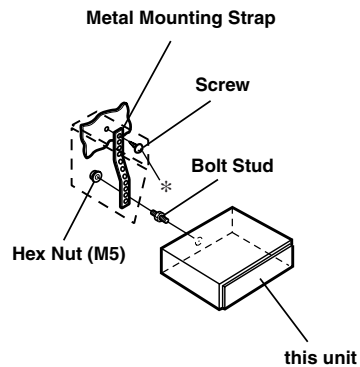

When your vehicle has the Bracket, mount the long hex bolt onto the rear panel of the DVA-9861Ri and put the Rubber Cap on the hex bolt. If your vehicle does not have the Mounting Support, reinforce the head unit with the metal mounting strap (not supplied). Connect all the leads of the DVA-9861Ri according to details described in the "Connections" section.

- For the screw\*, provide a proper screw to the chassis installing location.

3

Slide the DVA-9861Ri into the dashboard. When the unit is in place, make sure the locking pin is fully seated in the down position. This can be done by pressing firmly in on the unit while pushing the locking pin down with a small screwdriver. This ensures that the unit is properly locked and will not accidentally come out from the dashboard. Install the Detachable Front Panel.

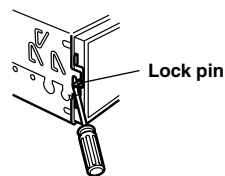



## **Removal**

1. Remove the detachable front panel.
2. Use a small screwdriver (or similar tool) to push the locking pin to the "up" position (see above drawing). As each pin is unlocked, gently pull out on the unit to make sure it does not re-lock before unlocking the second pin.
3. Pull the unit out, keeping it unlocked as you do so.

### **<JAPANESE CAR>**

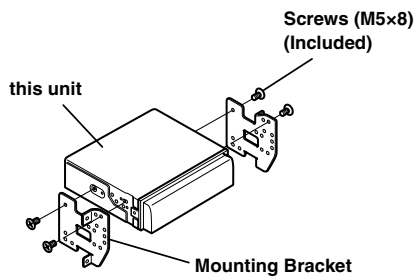
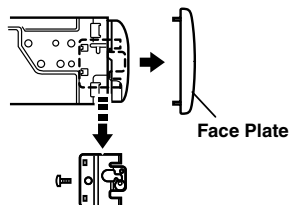

# Connections

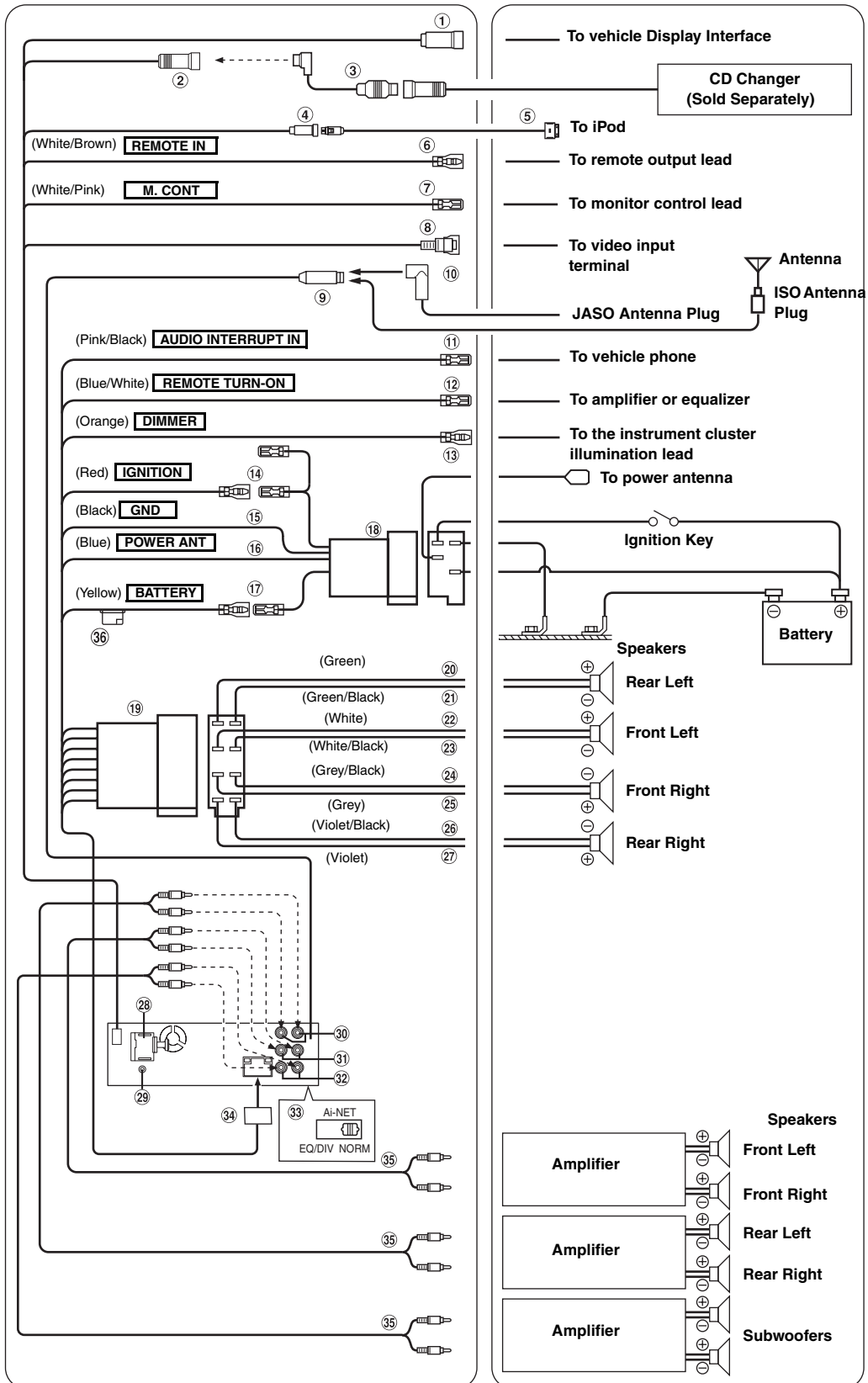

- ① **Vehicle Display Interface Connector**  
Outputs Vehicle Display Interface control signals. Connect this to the optional Vehicle Display Interface box. For details about connections, consult your nearest Alpine dealer.
- ② **Ai-NET Connector**  
Connect this to the output or input connector of other product (CD changer, Equalizer, etc.) equipped with Ai-NET.
- ③ **Ai-NET Cable (Included with CD Changer)**
- ④ **iPod Direct Connector**  
Control iPod signals.  
Connect this to an iPod, using the FULL SPEED™ Connection Cable (included).
- ⑤ **FULL SPEED™ Connection Cable (included)**
- ⑥ **Remote Control Input Lead (White/Brown)**  
Connect the external Alpine product to the remote control output lead.
- ⑦ **Monitor Control Lead (White/Pink)**  
Connect this to the Monitor Control Lead of the touch panel-compatible monitor.
- ⑧ **Video Output Connector**  
This connector is used in combination with the video inputs of another video product. (Touch panel compatible monitor, etc.)
- ⑨ **Antenna Receptacle**
- ⑩ **ISO/JASO Antenna Adapter (sold separately)**  
ISO/JASO Antenna Adaptor may be required, depending on the vehicle.
- ⑪ **Audio Interrupt In Lead (Pink/Black)**  
Connect this lead to the Audio Interface output of a cellular phone which provides ground shorting when a call is received.
- ⑫ **Remote Turn-On Lead (Blue/White)**  
Connect this lead to the remote turn-on lead of your amplifier or signal processor.
- ⑬ **Dimmer Lead (Orange)**  
This lead may be connected to the vehicle's instrument cluster illumination lead. This will enable the vehicle's dimmer control to dim the backlighting of the unit.
- ⑭ **Switched Power Lead (Ignition) (Red)**  
Connect this lead to an open terminal on the vehicle's fuse box or another unused power source which provides (+) 12V only when the ignition is turned on or in the accessory position.
- ⑮ **Ground Lead (Black)**  
Connect this lead to a good chassis ground on the vehicle. Make sure the connection is made to bare metal and is securely fastened using the sheet metal screw provided.
- ⑯ **Power Antenna Lead (Blue)**  
Connect this lead to the +B terminal of your power antenna, if applicable.
  - *This lead should be used only for controlling the vehicle's power antenna. Do not use this lead to turn on an amplifier or a signal processor, etc.*
- ⑰ **Battery Lead (Yellow)**  
Connect this lead to the positive (+) post of the vehicle's battery.
- ⑱ **ISO Power Supply Connector**
- ⑲ **ISO Connector (Speaker Output)**
- ⑳ **Left Rear (+) Speaker Output Lead (Green)**
- ㉑ **Left Rear (-) Speaker Output Lead (Green/Black)**
- ㉒ **Left Front (+) Speaker Output Lead (White)**
- ㉓ **Left Front (-) Speaker Output Lead (White/Black)**
- ㉔ **Right Front (-) Speaker Output Lead (Grey/Black)**
- ㉕ **Right Front (+) Speaker Output Lead (Grey)**
- ㉖ **Right Rear (-) Speaker Output Lead (Violet/Black)**
- ㉗ **Right Rear (+) Speaker Output Lead (Violet)**
- ㉘ **Digital Output Terminal (Optical)**  
Use when combining optical digital input compatible products.
- ㉙ **Steering Remote Control Interface Connector**  
To steering remote control interface box.
  - *Use a steering remote control extension cable if necessary.*
- ㉚ **Rear Output RCA Connectors**  
RED is right and WHITE is left.
- ㉛ **Front Output RCA Connectors**  
RED is right and WHITE is left.
- ㉜ **Subwoofer Output RCA Connectors**  
RED is right and WHITE is left.
- ㉝ **System Switch**  
When connecting a processor using Ai-NET, place this switch in the EQ/DIV position. When no device is connected, leave the switch in the NORM position.
  - *Be sure to turn the power off to the unit before changing the switch position.*
- ㉞ **Power Supply Connector**
- ㉟ **RCA Extension Cable (sold separately)**
- ㊱ **Fuse Holder (10A)**

# System Example

Connect the Ai-NET compatible digital audio processor (Fiber optic compatible) and touch panel compatible monitor/changer.

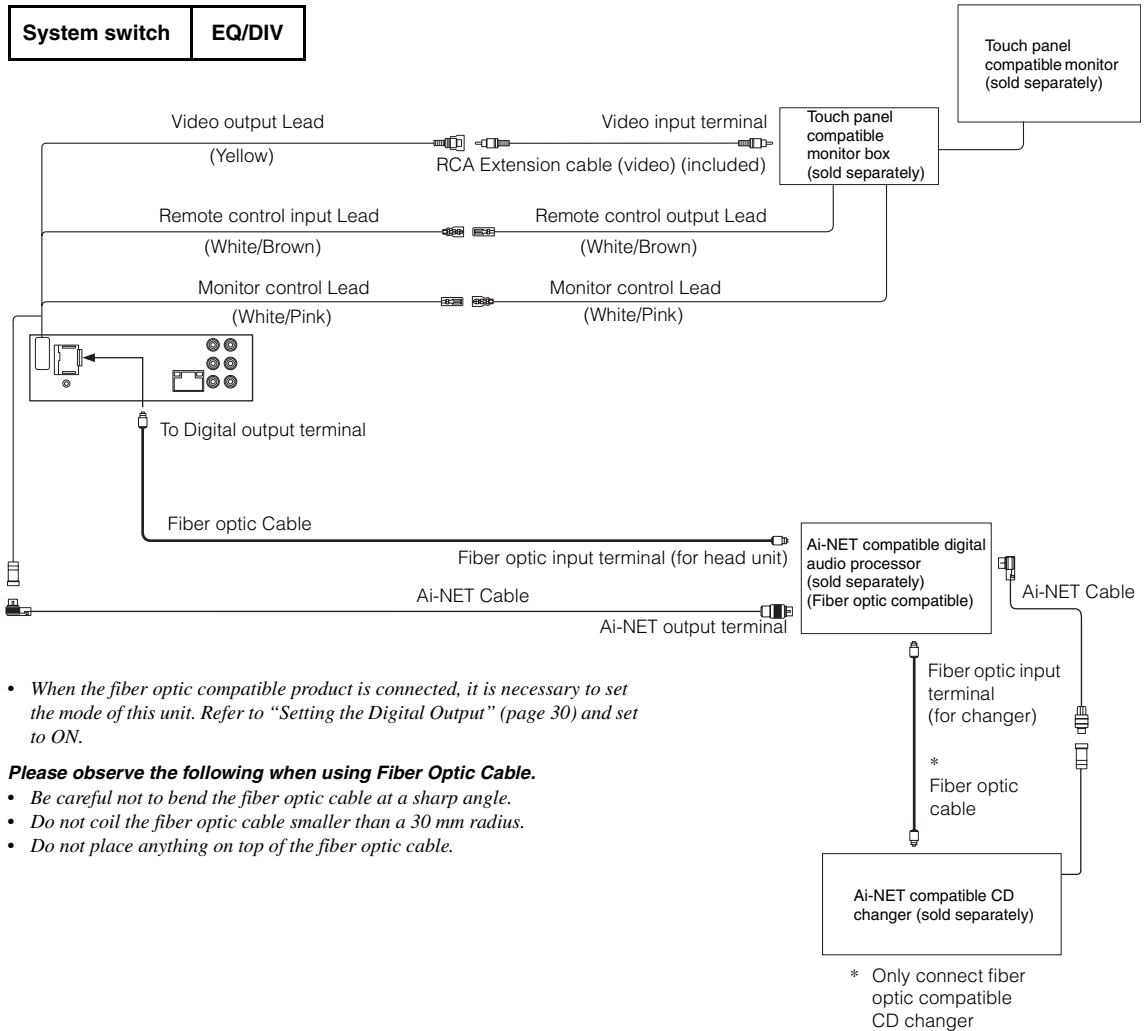

- When the fiber optic compatible product is connected, it is necessary to set the mode of this unit. Refer to "Setting the Digital Output" (page 30) and set to ON.

**Please observe the following when using Fiber Optic Cable.**

- Be careful not to bend the fiber optic cable at a sharp angle.
- Do not coil the fiber optic cable smaller than a 30 mm radius.
- Do not place anything on top of the fiber optic cable.

**To prevent external noise from entering the audio system.**

- Locate the unit and route the leads at least 10 cm away from the car harness.
- Keep the battery power leads as far away from other leads as possible.
- Connect the ground lead securely to a bare metal spot (remove any paint, dirt or grease if necessary) of the car chassis.
- If you add an optional noise suppressor, connect it as far away from the unit as possible. Your Alpine dealer carries various noise suppressors, contact them for further information.
- Your Alpine dealer knows best about noise prevention measures so consult your dealer for further information.

**To customers/Hinweis an Kunden/  
A l'attention de l'utilisateur/Información para  
los clientes/Informazioni per i clienti/Till kunder**



Note the following errors and supplementary information regarding the Owner's Manual.

Beachten Sie die folgenden Fehler und Zusatzinformationen, die sich auf die Bedienungsanleitung beziehen.

Prenez note des erreurs suivantes et des informations supplémentaires relatives au Mode d'emploi.

**English**

<Supplementary information>

**DualDisc**

This unit is not compatible with DualDisc. Using a DualDisc may cause unit malfunction, and may cause disc damage when the disc is inserted/ejected.

<Correction>

- Page 35, "Setting the DVD Audio Playback Mode"

Incorrect	Correct
<p><b>Setting item: DVD-A PLAY MODE</b>  <b>Setting contents: VIDEO/VCAP/VOFF</b></p> <p><b>VIDEO:</b> Only DVD Video is played back if the disc contains DVD Video and Audio.  <b>VCAP:</b> DVD Audio is played back with Video.  <b>VOFF:</b> DVD Audio is played back without Video.                      The initial setting at the factory is VCAP.</p>	<p><b>Setting item: DVD-A PLAY MODE</b>  <b>Setting contents: VIDEO/VCAP/VOFF</b></p> <p><b>VIDEO:</b> When both DVD-Video data and DVD-Audio data are recorded on one disc, the DVD-Video data has priority.  <b>VCAP:</b> The sound and the images are output, as well as the DVD-Video.  <b>VOFF:</b> Only the sound data is output; images are not.                      The initial setting at the factory is VIDEO.</p>

**Deutsch**

<Zusatzinformationen>

**DualDisc**

Dieses Gerät ist nicht mit DualDisc kompatibel. Die Verwendung einer DualDisc kann zu einer Fehlfunktion des Geräts führen und die Disc beschädigen, wenn sie eingelegt/ausgeworfen wird.

<Korrektur>

- Seite 35, „Einstellen des DVD-Audio-Wiedergabemodus“

Falsch	Richtig
<p><b>Einstelloption: DVD-A PLAY MODE</b>  <b>Einstellungen: VIDEO/VCAP/VOFF</b></p> <p><b>VIDEO:</b> Bei Discs mit DVD-Video- und -Audiodaten werden nur die DVD-Videodaten wiedergegeben.  <b>VCAP:</b> DVD-Audiodaten werden mit Videoinformation wiedergegeben.  <b>VOFF:</b> DVD-Audiodaten werden ohne Videoinformation wiedergegeben.                      Die werkseitige Einstellung ist VCAP.</p>	<p><b>Einstelloption: DVD-A PLAY MODE</b>  <b>Einstellungen: VIDEO/VCAP/VOFF</b></p> <p><b>VIDEO:</b> Wenn auf einer Disc sowohl DVD-Video- als auch DVD-Audio-Daten aufgezeichnet sind, haben die DVD-Video-Daten Vorrang.  <b>VCAP:</b> Der Ton und die Bilder werden ausgegeben sowie auch das DVD-Video-Material.  <b>VOFF:</b> Es werden lediglich Audiodaten ausgegeben, Bilder jedoch nicht.                      Die werkseitige Einstellung ist VIDEO.</p>

**Français**

<Informations supplémentaires>

**DualDisc**

Cet appareil n'est pas compatible avec les DualDisc. Si vous utilisez un DualDisc, vous risquer d'endommager l'appareil ainsi que le disque lors de l'insertion ou de l'éjection.

<Correction>

- Page 35, « Réglage du mode de lecture du DVD audio »

Incorrect	Correct
<p><b>Désignation du réglage: DVD-A PLAY MODE</b>  <b>Désignations du réglage: VIDEO/VCAP/VOFF</b></p> <p><b>VIDEO :</b> Seul les données vidéo sont lues si le disque contient des données vidéo et audio.  <b>VCAP :</b> Les données audio ainsi que les données vidéo sont lues.  <b>VOFF :</b> Seules les données audio sont lues.                      Le réglage par défaut est VCAP.</p>	<p><b>Désignation du réglage: DVD-A PLAY MODE</b>  <b>Désignations du réglage: VIDEO/VCAP/VOFF</b></p> <p><b>VIDEO :</b> Lorsque vous enregistrez sur le DVD des données vidéo et audio, les données vidéo ont la priorité.  <b>VCAP :</b> Le son et les images sont reproduits, ainsi que le DVD vidéo.  <b>VOFF :</b> Seul le son est reproduit, les images ne le sont pas.                      Le réglage par défaut est VIDEO.</p>

**お客様へ/To customers/Hinweis an Kunden/**

**A l'attention de l'utilisateur/Información para los clientes/**

**Informazioni per i clienti/Till kunder/致客户/致客户**



取扱説明書を補足致します。/Please note following additional information of the Owner's Manual./Bitte beachten Sie folgende zusätzliche Informationen zur Bedienungsanleitung./ Veuillez noter les ajouts suivants au mode d'emploi./Tenga en cuenta la información adicional contenida en el Manual de operación./ Tenere presente le seguenti informazioni supplementari d'istruzioni per l'uso./ Se följande tillägg till användarhandledning./ 請注意以下使用手冊的附加資訊。/ 請注意以下用戶說明書的附加信息。

### 和文

- アルパインシアターアンプに接続した場合は、アンプ/プロセッサーを含むサラウンドモードのレベル設定ができます。その際、スピーカーレベル (OUTPUT LEVEL) 設定の最大値および最小値が、本機ディスプレイでは正しく表示されません。最大値「+10」は「+0」、最小値「-10」は「-0」と表示されます。これは多くのセットアップ機能が、モニターディスプレイに表示するように設計されているためであり、故障ではありません。サラウンドモードのレベル設定などについては、モニターディスプレイを見て設定することをお勧めします。

### English

- When connected to an Alpine Theater Amp, it is possible to make individual level adjustments of the various surround modes included with the amplifier/processor. Since most of the setup function displays were designed with a video display in mind, this small unit display does not show the complete data display at both the Maximum and Minimum settings for the speaker levels (OUTPUT LEVEL). For example, the actual display at either extreme should read +10 or -10 for each mode. Instead, the display will show +0 or -0, respectively.

### Deutsch

- Wenn das Gerät an einen Alpine Theater Amp angeschlossen ist, können die Pegel der verschiedenen Surround-Modi, die beim Verstärker/Prozessor verfügbar sind, einzeln angepasst werden. Da die meisten Anzeigen der Setup-Funktion für eine Videoanzeige entwickelt wurden, zeigt diese kleine Geräteanzeige nicht die vollständige Datenanzeige der Maximum- und Minimum-Einstellungen für die Lautsprecherpegel (OUTPUT LEVEL) an. Zum Beispiel würde die tatsächliche Anzeige der Extremwerte für jeden Modus +10 oder -10 lauten. Stattdessen zeigt die Anzeige +0 bzw. -0 an.

### Français

- Si vous raccordez un Home Cinéma Alpine, vous pouvez effectuer le réglage individuel des niveaux des différents modes surround de l'amplificateur/ processeur. La plupart des écrans de fonction de configuration ayant été conçus sur la base d'un écran vidéo, l'écran de cette petite unité n'affiche pas toutes les données des réglages Maximum et Minimum du niveau des enceintes (OUTPUT LEVEL). Par exemple, l'écran actuel des deux réglages extrêmes devrait afficher +10 ou -10 pour chaque mode. Cependant, l'écran affiche respectivement +0 et -0.

## Español

- Al conectarse a un amplificador de home cinema de Alpine, es posible realizar ajustes individuales de los niveles de los distintos modos de sonido envolvente incluidos con el amplificador/procesador. Dado que la mayoría de las pantallas de funciones de configuración se han diseñado teniendo en mente una pantalla de vídeo, la pantalla de esta pequeña unidad no muestra todos los datos en los ajustes máximo y mínimo del nivel de los altavoces (OUTPUT LEVEL). Por ejemplo, la pantalla real en cualquiera de los dos ajustes extremos debería mostrar +10 o -10 para cada modo. Sin embargo, la pantalla mostrará +0 o -0, respectivamente.

## Italiano

- Se è collegato un Theater Amp Alpine, è possibile eseguire delle regolazioni di livello individuali per le varie modalità surround comprese con l'amplificatore/processore. Poiché gran parte delle schermate delle funzioni di configurazione sono state progettate per un dispositivo dotato di display video, il display di questa piccola unità non mostra i dati completi relativi alle impostazioni Massimo e Minimo per i livelli degli altoparlanti (OUTPUT LEVEL). Ad esempio, a ciascun estremo la visualizzazione reale dovrebbe essere +10 o -10 per ogni modalità. Il display mostra invece +0 e -0 rispettivamente.

## Svenska

- När enheten är ansluten till en Alpine Theater-förstärkare, kan man göra individuella nivåjusteringar för de olika surroundlägena som förstärkaren/processorn har. Eftersom de flesta inställningsfunktionerna har konstruerats för en bildskärm, kanske inte denna lilla display kan visa hela inställningsfunktionen vid både max- och min-inställningarna för högtalarnivåerna (OUTPUT LEVEL). Exempelvis visar den faktiska inställningsfunktionen +10 eller -10 i ytterlägena för varje läge. Istället visar displayen +0 respektive -0.

## 中文（繁体字）

- 當連接至 Alpine 影院功放時，可以對功放/處理器的各種環繞音效模式進行單獨的音量水平調整。由於大部分的設定功能顯示是由已儲存的視頻顯示所設計的，本小型裝置不會顯示揚聲器音量水平（OUTPUT LEVEL）最大和最小設定的完整顯示資料。例如，每個模式中任一音量極限的真實顯示應讀作 +10 或 -10，而實際的顯示將分別為 +0 或 -0。

## 中文（简体字）

- 当连接至 Alpine 影院放大器时，可以对放大器/处理器的各种环绕音效模式进行单独的音量水平调整。由于大部分的设定功能显示是由已储存的视频显示所设计的，本小型装置不会显示 扬声器音量水平（OUTPUT LEVEL）最大和最小设定的完整显示数据。例如，每个模式中任一音量极限的真实显示应读作+10或-10，而实际的显示将分别为+0或-0。

Tenga en cuenta los siguientes errores e información complementaria acerca del Manual de usuario. Prestare gli errori e le informazioni supplementari riguardanti il Manuale utente e riportati di seguito. Observera följande fel och tilläggsinformation beträffande användarhandboken.

## Español

### <Información complementaria>

#### DualDisc

Esta unidad es compatible con la tecnología DualDisc. La utilización de la tecnología DualDisc puede causar un mal funcionamiento y provocar daños en el disco al insertarlo o extraerlo.

### <Corrección>

- Página 35, "Configuración del modo de reproducción de discos DVD de audio"

Incorrecto	Correcto
<p><b>Elemento de configuración: DVD-A PLAY MODE</b>  <b>Opciones de configuración: VIDEO/VCAP/OFF</b></p> <p><b>VIDEO:</b> sólo se reproduce el DVD de vídeo si el disco contiene tanto vídeo como audio.</p> <p><b>VCAP:</b> se reproduce el DVD de audio junto con el vídeo.</p> <p><b>VOFF:</b> se reproduce el DVD de audio sin el vídeo.  El ajuste inicial de fábrica es VCAP.</p>	<p><b>Elemento de configuración: DVD-A PLAY MODE</b>  <b>Opciones de configuración: VIDEO/VCAP/OFF</b></p> <p><b>VIDEO:</b> si el disco contiene datos grabados de DVD de vídeo y de DVD de audio, los datos de DVD de vídeo tiene prioridad.</p> <p><b>VCAP:</b> se reproduce el sonido y las imágenes, tal como ocurre en los discos DVD de vídeo.</p> <p><b>VOFF:</b> sólo se reproducen los datos de sonido, no las imágenes.  El ajuste inicial de fábrica es VIDEO.</p>

## Italiano

### <Informazioni supplementari>

#### DualDisc

Questo apparecchio non è compatibile con DualDisc. L'utilizzo di DualDisc può causare problemi di funzionamento e danneggiare il disco durante l'inserimento/espulsione.

### <Correzione>

- Pagina 35, "Impostazione del modo di riproduzione di DVD audio"

Errato	Corretto
<p><b>Voce selezionata: DVD-A PLAY MODE</b>  <b>Contenuto dell'impostazione: VIDEO/VCAP/OFF</b></p> <p><b>VIDEO:</b> Il DVD video viene riprodotto solo se il disco contiene audio e video DVD.</p> <p><b>VCAP:</b> L'audio DVD viene riprodotto insieme al video.</p> <p><b>VOFF:</b> L'audio DVD viene riprodotto senza il video.  L'impostazione predefinita è VCAP.</p>	<p><b>Voce selezionata: DVD-A PLAY MODE</b>  <b>Contenuto dell'impostazione: VIDEO/VCAP/OFF</b></p> <p><b>VIDEO:</b> Quando dati DVD video e DVD audio vengono entrambi registrati su disco, i dati del DVD video hanno priorità.</p> <p><b>VCAP:</b> Vengono riprodotti sia immagini e suoni che i DVD video.</p> <p><b>VOFF:</b> Vengono riprodotti solo i suoni; non le immagini.  L'impostazione predefinita è VIDEO.</p>

## Svenska

### <Tilläggsinformation>

#### DualDisc

Den här enheten är inte kompatibel med DualDisc. Om man använder en DualDisc kan detta leda till att enheten inte fungerar som den ska när skivan sätts i eller matas ut..

### <Rättelse>

- Sidan 35, "Ställa in uppspelningsläget för DVD-ljud"

Fel	Rätt
<p><b>Inställning: DVD-A PLAY MODE</b>  <b>Inställningsalternativ: VIDEO/VCAP/OFF</b></p> <p><b>VIDEO:</b> Endast DVD Video spelas upp om skivan innehåller DVD Video och Audio.</p> <p><b>VCAP:</b> DVD Audio spelas upp med Video.</p> <p><b>VOFF:</b> DVD Audio spelas upp utan Video.  Den ursprungliga fabriksinställningen är VCAP.</p>	<p><b>Inställning: DVD-A PLAY MODE</b>  <b>Inställningsalternativ: VIDEO/VCAP/OFF</b></p> <p><b>VIDEO:</b> Om både DVD-videodata och DVD-ljuddata spelas in på en skiva har DVD-videodata prioritet.</p> <p><b>VCAP:</b> Ljudet och bilderna avges samt även DVD-video.</p> <p><b>VOFF:</b> Endast ljuddata avges, inte bilder.  Den ursprungliga fabriksinställningen är VIDEO.</p>



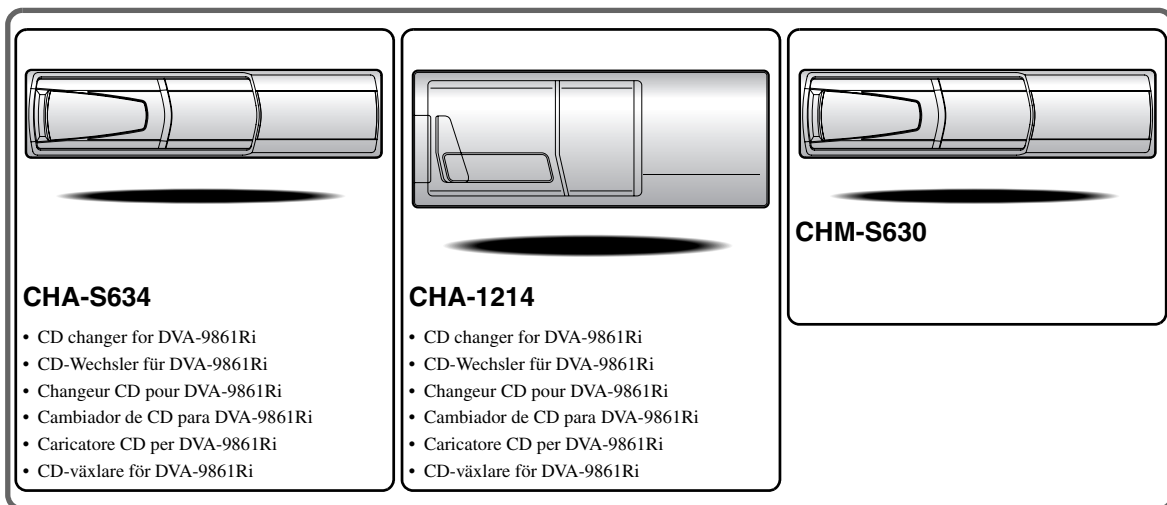

### **CHA-S634**

- CD changer for DVA-9861Ri
- CD-Wechsler für DVA-9861Ri
- Changeur CD pour DVA-9861Ri
- Cambiador de CD para DVA-9861Ri
- Caricatore CD per DVA-9861Ri
- CD-växlare för DVA-9861Ri

### **CHA-1214**

- CD changer for DVA-9861Ri
- CD-Wechsler für DVA-9861Ri
- Changeur CD pour DVA-9861Ri
- Cambiador de CD para DVA-9861Ri
- Caricatore CD per DVA-9861Ri
- CD-växlare för DVA-9861Ri

### **CHM-S630**

## **Alpine CD Changers Give You More!**

***More musical selections, more versatility, more convenience.***

The CHA-S634 is a high-performance 6-disc changer with a new M DAC, CD-R/RW PLAY BACK, MP3 PLAY BACK and CD TEXT. The CHA-1214 Ai-NET model holds 12 discs, and the CHM-S630 M-Bus model is a super-compact 6-disc changer with a CD-R/RW PLAY BACK.

## **Von Alpine CD-Wechslern haben Sie mehr!**

***Mehr Musikauswahl, mehr Vielseitigkeit, mehr Komfort.***

Der CHA-S634 ist ein Hochleistungs-Wechsler für 6 CDs mit dem neuen M-DAC, mit CD-R/RW- und MP3-Wiedergabefunktion und mit CD-TEXT. Der CHA-1214 ist ein Ai-NET-Modell für 12 CDs. Der M-Bus-kompatible CHM-S630 ist ein superkompakter Wechsler für 6 CDs mit CD-R/RW-Wiedergabefunktion.

## **Changeurs de CD Alpine : vous avez le choix!**

***Plus de sélections musicales, plus de souplesse, plus de confort.***

Le modèle CHA-S634 est un changeur 6 disques ultra performant équipé des nouvelles fonctions M DAC, CD-R/RW PLAY BACK, MP3 PLAY BACK et CD TEXT. Le modèle CHA-1214 Ai-NET contient 12 disques. Le modèle CHM-S630 M-Bus est un changeur 6 disques super compact doté de la fonction CD-R/RW PLAY BACK.

## **¡Los cambiadores Alpine de CD le ofrecen más!**

***Más selecciones musicales, más versatilidad y más ventajas.***

CHA-S634 es un cambiador de seis discos de alto rendimiento con nuevo M DAC, CD-R/RW PLAY BACK, MP3 PLAY BACK y CD TEXT. El modelo CHA-1214 Ai-NET alberga 12 discos y el modelo CHM-S630 M-Bus es un cambiador de seis discos de tamaño reducido con un CD-R/RW PLAY BACK.

## **I caricatori CD Alpine danno di più!**

***Più scelta, più versatilità, più comodità.***

Il modello CHA-S634 è un caricatore a 6 dischi ad elevate prestazioni dotato di un nuovo M DAC, CD-R/RW PLAY BACK, MP3 PLAY BACK e CD TEXT. Il modello CHA-1214 Ai-NET è in grado di contenere 12 dischi, il modello CHM-S630 M-Bus è un caricatore a 6 dischi ultra compatto dotato di un CD-R/RW PLAY BACK.

## **Alpines CD-växlare ger mer!**

***Fler musikval, mer variation, större bekvämlighet.***

CHA-S634 är en växlare för 6 skivor med mycket höga prestanda och en ny M D/A-omvandlare samt uppspelning av CD-R/RW, MP3 och CD TEXT. CHA-1214 Ai-NET rymmer 12 skivor. CHM-S630 M-Bus är en mycket kompakt växlare med kapaciteten 6 skivor med uppspelning av CD-R/RW PLAY BACK.

# Appendix

## Product Information Card

## Produkt-Informationskarte

## Carte d'informations sur le produit

## Tarjeta de información del producto

### English

Filling in this Product Information Card is voluntary. If you fill in this card and send it to Alpine, your data will be tabulated into reference data for future Alpine product development. In addition, in the future you may receive information about new products or Survey Mail requesting additional opinions about Alpine products or services. If you agree to the above term, please sign your name in the indicated space and return the card. Any additional comments or inquiries may be sent to: Person in charge of Customer Service department Alpine Electronics (Europe) GmbH.  
Frankfurter Ring 117, 80807 München, Germany  
Phone: +49-(0)89-32 42 640

### Deutsch

Das Ausfüllen dieser Produktinformations-Karte ist freiwillig. Sollten Sie diese Karte vervollständigen, so werden die Daten für zukünftige Produktentwicklungen von Alpine als Referenzdaten herangezogen. Ebenso können Sie in der Zukunft Informationen über neue Alpine Produkte erhalten oder uns auch Ihre Meinung über Alpine Produkte und Dienstleistungen im Rahmen von Kunden-Befragungen mitteilen. Stimmen Sie dem Kontakt durch Alpine zu, so würden wir Sie bitten, in dem dafür vorgesehenen Feld zu unterschreiben und die Karte kostenfrei an uns zurückzuschicken. Zusätzliche Kommentare und Meinungen können Sie gerne an den zuständigen Kontakt im Kundendienst Alpine Electronics (Europe) GmbH senden.  
Frankfurter Ring 117, 80807 München, Germany  
Phone: 089-32 42 640

### Français

En remplissant volontairement cette fiche, et en l'envoyant à Alpine, vous acceptez que ces informations soient utilisées par Alpine, dans le cadre de développement de nouveaux produits. Par ailleurs, vous autorisez Alpine à solliciter votre opinion par mailing sur de nouveaux produits ou services. Si vous acceptez les termes ci-dessus, veuillez signer cette carte à l'endroit indiqué, et nous la retourner. Tout autre commentaire ou demande doit être adressé à l'attention de: Responsable du service consommateur Alpine Electronics (Europe) GmbH.  
Frankfurter Ring 117, 80807 München, Germany  
Phone: +49-(0)89-32 42 640

### Español

El envío de la información solicitada es voluntario. Si Vd. nos la remite, será utilizada de modo confidencial para el desarrollo de futuros productos Alpine. Si Vd. desea recibir información sobre nuevos productos de nuestra gama, indique su nombre en el espacio designado y remitános la tarjeta. Cualquier solicitud adicional puede ser enviada a: Persona responsable del Servicio de Atención al Cliente de Alpine Electronics (Europe) GmbH.  
Frankfurter Ring 117, 80807 München, Germany  
Phone: +49-(0)89-32 42 640

#### Q1. PRODUCT PURCHASED

1. Cassette Player
2. CD Player
3. MD Player
4. DVD Player
5. CD Changer
6. Amplifier
7. Speaker
8. Subwoofer
9. Monitor Controller
10. Video Monitor
11. Navigation
12. Processor/Equalizer
13. CD/Video CD Changer
14. Other \_\_\_\_\_

#### Q2. MODEL NUMBER: \_\_\_\_\_

#### Q3. DATE OF PURCHASE:

Month: \_\_\_\_\_ Year: \_\_\_\_\_

#### Q4. If navigation system, which monitor?

1. Alpine → (Model No.) \_\_\_\_\_
2. Other → (Brand Name) \_\_\_\_\_

#### Q5. STORE TYPE WHERE PURCHASED:

1. Car Audio Specialist
2. Audio/Video Store
3. Electronics/Appliance Store
4. Car Accessories Shop
5. Other \_\_\_\_\_

#### Q6. Type of vehicle in which this unit is installed:

Make: \_\_\_\_\_ Model: \_\_\_\_\_  
Purchased Model \_\_\_\_\_  
Year: \_\_\_\_\_ Year: \_\_\_\_\_

#### Q7. How was this vehicle purchased?

1. Purchase
2. Lease

#### Q8. Purpose of buying this unit?

1. Addition
2. Replacement

↓  
• Previous brand replaced?  
1. Factory installed

2. Alpine
3. Other → (Brand Name) \_\_\_\_\_

#### Q9. Have you purchased Alpine products before?

1. First time
2. Two or More times

#### Q10. When you purchased this Alpine unit, did you compare it with other brand?

1. Yes → (Brand Name) \_\_\_\_\_
2. No

#### Q11. GENDER

1. Male
2. Female

#### Q12. AGE \_\_\_\_\_

#### Q13. MARITAL STATUS

1. Single
2. Married

#### Q14. OCCUPATION

1. Company Owner/Self-employed/  
Freelance
2. Manager
3. Company Employee
4. Civil Servant
5. Educator
6. Student
7. Other \_\_\_\_\_

#### Q15. Comments \_\_\_\_\_

#### Q1. gekauftes Gerät

1. Kassetten-Spieler
2. CD-Spieler
3. MD-Spieler
4. DVD-Spieler
5. CD-Wechsler
6. Verstärker
7. Lautsprecher
8. Subwoofer
9. Monitor-Controller
10. Video-Monitor
11. Navigationssystem
12. Prozessor/Equalizer
13. CD/Video-CD-Wechsler
14. andere \_\_\_\_\_

#### Q2. Modellnummer: \_\_\_\_\_

#### Q3. Kaufdatum:

Monat: \_\_\_\_\_ Jahr: \_\_\_\_\_

#### Q4. Falls Navigationssystem: Welcher Monitor?

1. Alpine → (Modellnr.) \_\_\_\_\_
2. Anderer Hersteller →  
(Herstellername) \_\_\_\_\_

#### Q5. Art des Geschäfts, in dem Sie das Gerät gekauft haben:

1. Spezialist für Auto-Audioanlagen
2. Audio/Video-Geschäft
3. Elektro-Geschäft
4. Autozubehör-Geschäft
5. Anderer Hersteller \_\_\_\_\_

#### Q6. Art des Fahrzeugs, in das das Gerät installiert wurde:

Marke: \_\_\_\_\_ Modell: \_\_\_\_\_  
gekauft im \_\_\_\_\_  
Jahr: \_\_\_\_\_ Baujahr: \_\_\_\_\_

#### Q7. Wie haben Sie das Fahrzeug gekauft?

1. Kauf
2. Leasing

#### Q8. Zweck des Kaufs dieses Geräts?

1. Zusätzlich
2. Austausch

↓  
• Marke des ausgetauschten Geräts?  
1. Serienmäßige Ausstattung

2. Alpine
3. Anderer Hersteller →  
(Herstellername) \_\_\_\_\_

#### Q9. War dies das erste Mal, dass Sie ein Alpine-Gerät gekauft haben?

1. Erstes Mal
2. Zweites Mal oder öfter

#### Q10. Haben Sie dieses Alpine-Gerät vor dem Kauf mit Geräten anderer Hersteller verglichen?

1. Ja → (Herstellername) \_\_\_\_\_
2. Nein

#### Q11. Geschlecht

1. Männlich
2. Weiblich

#### Q12. Alter \_\_\_\_\_

#### Q13. Familienstand

1. Ledig
2. Verheiratet

#### Q14. Beruf

1. Selbständige/Firmeninhaber/freiberuflich  
Tätige
2. Leitende Angestellte
3. Sonstige Angestellte
4. Beamte
5. Schulbildung
6. Studium
7. Sonstige \_\_\_\_\_

#### Q15. Kommentar: \_\_\_\_\_

#### Q1. PRODUIT ACHETE

1. Lecteur de cassette
2. Lecteur de CD
3. Lecteur MD
4. Lecteur DVD
5. Changeur de CD
6. Amplificateur
7. Haut-parleur
8. Haut-parleur de graves
9. Station Multimedia
10. Moniteur Vidéo
11. Navigation
12. Processeur/Egaliseur
13. Changeur de CD/CD Vidéo
14. Autre \_\_\_\_\_

#### Q2. NUMERO DU MODELE: \_\_\_\_\_

#### Q3. DATE D'ACHAT:

Mois: \_\_\_\_\_ Année: \_\_\_\_\_

#### Q4. Si c'est un système de navigation, quel moniteur?

1. Alpine → (N° du modèle) \_\_\_\_\_
2. Autre → (Marque) \_\_\_\_\_

#### Q5. TYPE DE MAGASIN OU VOUS AVEZ ACHETE LE PRODUIT:

1. Spécialiste autoradio
2. Magasin audio/vidéo
3. Magasin d'électronique/appareils
4. Magasin d'accessoires automobiles
5. Autre \_\_\_\_\_

#### Q6. Type de véhicule dans lequel cet appareil est installé:

Marque: \_\_\_\_\_ Modèle: \_\_\_\_\_  
Année \_\_\_\_\_ Année du  
d'achat: \_\_\_\_\_ modèle: \_\_\_\_\_

#### Q7. Comment avez-vous acheté ce véhicule?

1. Achat
2. Location-bail

#### Q8. Pourquoi avez-vous acheté cet appareil?

1. Addition
2. Remplacement

↓  
• Marque précédente remplacée?  
1. Installée en usine

2. Alpine
3. Autre → (Marque) \_\_\_\_\_

#### Q9. Avez-vous déjà acheté des produits Alpine?

1. Première fois
2. Deux fois ou plus

#### Q10. Lorsque vous avez acheté ce produit Alpine, l'avez-vous comparé à une autre marque?

1. Oui → (Marque) \_\_\_\_\_
2. Non

#### Q11. SEXE

1. Masculin
2. Féminin

#### Q12. AGE \_\_\_\_\_

#### Q13. SITUATION DE FAMILLE

1. Célibataire
2. Marié

#### Q14. PROFESSION

1. Entrepreneur/Travailleur indépendant/  
Free-lance
2. Directeur
3. Employé de bureau
4. Fonctionnaire
5. Educateur
6. Etudiant
7. Autre \_\_\_\_\_

#### Q15. Commentaires \_\_\_\_\_

#### Q1. Producto Comprado

1. Radio/Cassette
2. Radio/CD
3. Reproductor de MD
4. Reproductor de DVD
5. Cambiador de CD
6. Amplificador
7. Altavoz
8. Subwoofer
9. Monitor de control
10. Monitor de video
11. Sistema de navegación
12. Procesador/Equalizador
13. Cambiador de CD/Video CD
14. Otros \_\_\_\_\_

#### Q2. Número de modelo: \_\_\_\_\_

#### Q3. Fecha de compra:

Mes: \_\_\_\_\_ Año: \_\_\_\_\_

#### Q4. En caso de sistema de navegación, ¿qué monitor?

1. Alpine → (N° de modelo) \_\_\_\_\_
2. Otros → (Nombre de marca) \_\_\_\_\_

#### Q5. TIPO DE TIENDA DONDE COMPRÓ:

1. Especialista en audio de automóviles
2. Tienda de audio/video
3. Tienda de electrónica/electrodomésticos
4. Tienda de accesorios automovilísticos
5. Otros \_\_\_\_\_

#### Q6. Tipo de vehículo en que la unidad está instalada:

Marca: \_\_\_\_\_ Modelo: \_\_\_\_\_  
Año de \_\_\_\_\_ Año del  
compra: \_\_\_\_\_ modelo: \_\_\_\_\_

#### Q7. ¿Cómo fue comprado este vehículo?

1. compra
2. Leasing

#### Q8. ¿Propósito de comprar esta unidad?

1. Mejora del sistema
2. Sustitución

↓  
• ¿Sustitución de marca anterior?  
1. Instalado en la fábrica

2. Alpine
3. Otros → (Nombre de marca) \_\_\_\_\_

#### Q9. ¿Ha comprado Vd. productos Alpine anteriormente?

1. Primera vez
2. Dos o más veces

#### Q10. Cuando usted compró esta unidad Alpine, ¿la comparó con otros fabricantes?

1. Si → (Nombre de marca) \_\_\_\_\_
2. No

#### Q11. SEXO

1. Masculino
2. Femenino

#### Q12. Edad \_\_\_\_\_

#### Q13. Estado civil

1. Soltero
2. Casado

#### Q14. Ocupación

1. Propietario de empresa/Autónomo/  
Profesional independiente
2. Gerente
3. Empleado de compañía
4. Empleado público
5. Profesor
6. Estudiante
7. Otros \_\_\_\_\_

#### Q15. Comentarios \_\_\_\_\_

# Scheda informazioni prodotto

## Italiano

La compilazione di questo formulario è volontaria. Se compilate questo formulario, ritornandolo ad Alpine, i Vostri dati saranno raccolti in un file di riferimento per lo sviluppo dei nuovi prodotti Alpine. In aggiunta Voi potrete ricevere in futuro informazioni riguardanti i nuovi prodotti o la richiesta di una Vostra opinione circa i prodotti o i servizi forniti da Alpine. Se siete d'accordo, Vi preghiamo di ritornarci il formulario compilato negli appositi spazi con i Vostri dati. In caso desideriate fornire altri commenti o richiedere informazioni aggiuntive, potete indirizzare il tutto a : Responsabile dipartimento Servizio Clienti Alpine Electronics (Europe) GmbH.  
Frankfurter Ring 117, 80807 München, Germany  
Phone: +49-(0)89-32 42 640

### Q1. PRODOTTO ACQUISTATO

1. Lettore di cassette
2. Lettore CD
3. Lettore MD
4. Lettore DVD
5. CD Changer
6. Amplificatore
7. Altoparlante
8. Subwoofer
9. Radio Monitor
10. Monitor video
11. Sistema di navigazione
12. Processore/equalizzatore
13. Cambia CD/Video CD
14. Altro \_\_\_\_\_

### Q2. NUMERO MODELLO: \_\_\_\_\_

### Q3. DATA DI ACQUISTO:

Mese: \_\_\_\_\_ Anno: \_\_\_\_\_

### Q4. In caso di acquisto di un sistema di navigazione, quale monitor possiede?

1. Alpine → (No. Modello) \_\_\_\_\_
2. Altro → Nome marca \_\_\_\_\_

### Q5. NEGOZIO DI ACQUISTO:

1. Specialista Car Stereo
2. Negozio di audio/video
3. Negozio di elettronica/elettrodomestici
4. Negozio accessori automobile
5. Altro \_\_\_\_\_

### Q6. Tipo di veicolo posseduto:

Marca: \_\_\_\_\_ Modello: \_\_\_\_\_  
Anno \_\_\_\_\_ Anno \_\_\_\_\_  
acquisto: \_\_\_\_\_ modello: \_\_\_\_\_

### Q7. Modalità acquisto

1. Acquisto
2. Leasing

### Q8. Scopo acquisto

1. Aggiunta
2. Sostituzione
- ↓
- Marca sostituita
1. Installato di fabbrica
2. Alpine
3. Altro → (Nome marca) \_\_\_\_\_

### Q9. Avevate già acquistato prodotti Alpine?

1. No
2. Due o tre volte

### Q10. Nell'acquistarlo, avete paragonato questo prodotto ad un'altra marca?

1. Sì → (Nome marca) \_\_\_\_\_
2. No

### Q11. SESSO

1. Maschile
2. Femminile

### Q12. ETA

### Q13. STATO CIVILE

1. Celibe/nubile
2. Coniugato/coniugata

### Q14. LAVORO

1. Proprietario di azienda/artigiano/libero professionista
2. Manager
3. Impiegato
4. Impiegato statale
5. Insegnante
6. Studente
7. Altro \_\_\_\_\_

### Q15. Commenti \_\_\_\_\_

- ◆ I agree to the above stated terms of the Alpine Product Information Card.
- ◆ Ich stimme dem Kontakt durch Alpine für Informations- und Befragungszwecke zu.
- ◆ J'accepte les termes de cette carte d'information produit Alpine.
- ◆ Estoy conforme con los términos de la tarjeta de información sobre producto de Alpine.
- ◆ Accetto i termini della scheda informazioni prodotti Alpine.

\_\_\_\_\_ (Date/Datum/Date/Fecha/Data)

\_\_\_\_\_ (Signature/Unterschrift/Signature/Firma)

### Name/Nom/Nombre/Nome

\_\_\_\_\_  
(First Name/Vorname/Prénom/Primer nombre/Nome)

\_\_\_\_\_  
(Surname/Familienname/Nom de famille/Apellido/Cognome)

### Home Address/Privatanschrift/Adresse/Dirección/Indirizzo

\_\_\_\_\_  
(Street/Straße/Rue/Calle/Via) (Post Code/Postleitzahl/Code postal/Código postal/Codice postale)

\_\_\_\_\_  
(Town/City/Stadt/Ville/Ciudad/Città) (Country/Land/Pays/Pais/Paese)

Telephone Number: \_\_\_\_\_

E-Mail/Correo electrónico: \_\_\_\_\_

Q1 NO. Other	Q2
-----------------	----

Q3 Month	Year	Q4 NO.1. Model No.
		NO.2. Brand Name

Q5 NO. Other	Q6 Make:	Model:
	Purchased Year:	Model Year:

Q7 NO.	Q8 NO. 1	Previous brand replaced.	Brand Name
	2	1. 2. 3. →	

Q9 NO.	Q10 1 → Brand Name	Q11 NO.
	NO. 2	

Q12         years old	Q13 NO.	Q14 NO. Other
-----------------------	---------	------------------

Q15 Comments \_\_\_\_\_

**LUFTPORT**  
PAR AVION  
PRIORITAIRE

NE PAS AFFRANCHIR  
  
NICHT FREIMACHEN  
NO STAMP REQUIRED

---

REPOSE PAYEE/ WERBEANTWORT  
ALLEMAGNE

---

ALPINE ELECTRONICS (EUROPE) GmbH  
Frankfurter Ring 117, 80807 München,  
Germany