

User's Manual

640UI

MP3-COMPATIBLE
IN-DASH CD RECEIVER WITH
FRONT PANEL USB PORT



BOSS[®]

AUDIO SYSTEMS

CONTENTS LIST

PAGE CONTENTS

2	NOTE OF DISCS
3	ACCESSORY INCLUDED
4	INSTALLATION
6	DETACHABLE CONTROL PANEL
7	WIRING DIAGRAM
8	PANEL OPEN/CLOSE OPERATION
9	CONTROL PANEL FUNCTION
10	BASIC OPERATIONS
11	MENU OPERATION
12	AUDIO OPERATION
14	TUNER OPERATION
15	RDS OPERATION
16	CD /MP3/WMA OPERATION
20	USB OPERATION
21	MEMORY CARD OPERATION
22	RECORDING OPERATION
25	MUSIC FILES TRANSFERRING
27	MUSIC FILES ERASING
29	FILES MANAGER
30	iPod OPERATION
32	REMOTE FUNCTION
33	SPECIFICATIONS
34	TROUBLE SHOOTING

1. NOTE OF DISCS

MOISTURE CONDENSATION

On a rainy day or in a very damp area, moisture may condense on the lenses inside the unit. Should this occur, the unit will not operate properly. In such a case, remove the disc and wait for about an hour until the moisture has evaporated.

NOTES ON CDs

1. A dirty or defective disc may cause sound dropouts while playing. To enjoy optimum sound, handle the disc as follows. Handle the disc by its edge. To keep the disc clean, do not touch the surface (P.1).



2. Do not stick paper or tape on the disc (P.2).

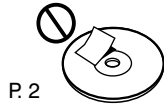

3. Do not expose the discs to direct sunlight or heat sources such as hot air-ducts, or leave them in a car parked in direct sunlight where there can be a considerable rise in temperature inside the car (P.3).

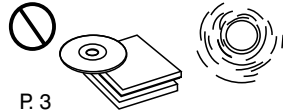

4. Before playing, clean the discs with an optional cleaning cloth. Wipe each disc from the centre out (P.4).



5. Do not use solvents such as benzene, thinner, commercially available cleaners, or antistatic spray intended for analog discs.

NOTES ON DISCS

If you use the discs explained below, the sticky residue can cause the CD to stop spinning and may cause malfunction or ruin your discs.

Do not use second-hand or rental CDs that have a sticky residue on the surface (for example, from peeled-off stickers or from ink, or glue leaking from under the stickers).

**There are paste residue.
Ink is sticky (P.5).**

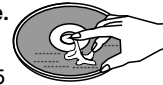

Do not use rental CDs with old labels that are beginning to peel off.

Stickers that are beginning to peel away, leaving a sticky residue (P.6).

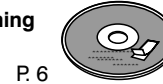

Do not use your CDs with labels or stickers attached.

Labels are attached (P.7).

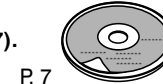

Do Not Use Special Shape CDs

Be sure to use round shape CDs only for this unit and do not use any special shape CDs. Use of special shape CDs may cause the unit to malfunction.(P.8).



Be sure to use CDs with disc mark



Only for this unit.

CD-Rs and CD-RWs which have not undergone finalization processing cannot be played. (For more information on finalization processing, refer to the manual for your CD-R/CD-RW writing software or CD-R/CD-RW recorder.) Additionally, depending on the recording status, it may prove impossible to play certain CDs record on CD-R or CD-RW.

2. ACCESSORY INCLUDED

When first unpacking your new full detachable DVD head unit, please check first that the package contains all of the items below. If something is missing, contact the store where you purchased the player.

- Owner's Manual



- Warranty Card



- Remote control



- Lithium Battery



- Half Sheeve

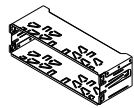

- Insert Key

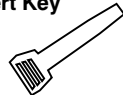

- 1. Dashboard
- 2. Nut (5mm)
- 3. Spring washer
- 4. Screw (4X12mm)
- 5. Screw
- 6. Support Strap
- 7. Plain washer

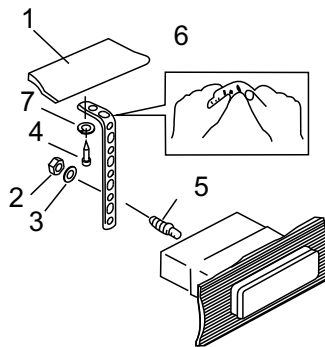

3. INSTALLATION

- Before finally installing the unit, connect the wiring temporarily and make sure it is all connected up properly and the unit and system work properly.
- Use only the parts included with the unit to ensure proper installation. The use of unauthorized parts can cause malfunctions.
- Consult with your nearest dealer if installation requires the drilling of holes or other modifications of the vehicle.
- Install the unit where it does not get in the driver's way and cannot injure the passenger if there is a sudden stop, like an emergency stop.
- If installation angle exceeds 30° from horizontal, the unit might not give its optimum performance.

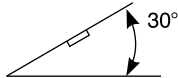

- Avoid installing the unit where it would be subject to high temperature, such as from direct sunlight, or from hot air, from heater, or where it would be subject to dust dirt or excessive vibration.
- Be sure to remove the front panel before installing the unit.

DIN FRONT/REAR-MOUNT

This unit can be properly installed either from "Front" (conventional DIN Front-mount) or "Rear" (DIN Rear-mount installation, utilizing threaded screw holes at the sides of the unit chassis). For details, refer to the following illustrated installation methods A and B.

DIN FRONT-MOUNT (Method A)

Installation the unit

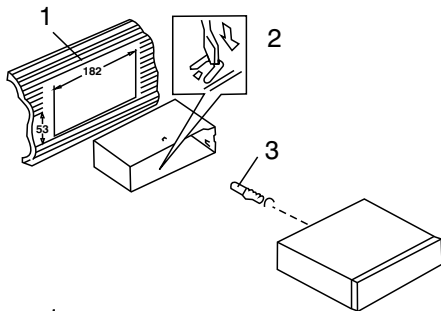

1. Dashboard
2. Holder

After inserting the half sleeve into the dashboard, select the appropriate tab according to the thickness of the dashboard material and bend them inwards to secure the holder in place.

3. Screw

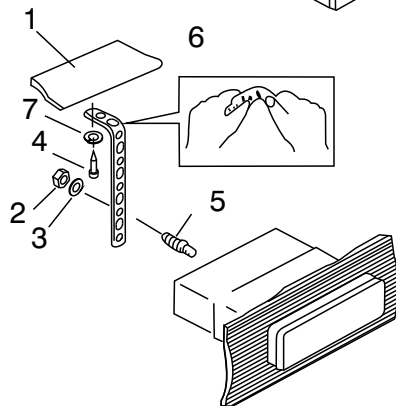

1. Dashboard
2. Nut (5mm)
3. Spring washer
4. Screw (4x12mm)
5. Screw
6. Support Strap

Be sure to use the support strap to secure the back of the unit in place. The strap can be bent by hand to the desired angle.

7. Plain washer

Removing the unit

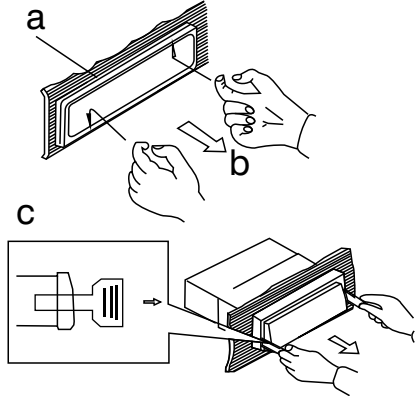

- a. Frame
- b. Insert fingers into the groove in the front of frame and pull out to remove the frame. (When re-attaching the frame, point the side with a groove down wards and attach it.)
- c. Insert the levers supplied with the unit into the grooves at both sides of the unit as shown in figure until they click. Pulling the levers makes it possible to remove the unit from the dashboard.

Trim Plate Installation:

Push the trim plate against the chassis until it is fitted.

You must do this before you install the front panel, otherwise it can't be attached.

DIN REAR-MOUNT (METHOD B)

Installation using the screw holes on the sides of the unit.

Fastening the unit to the factory radio mounting bracket.

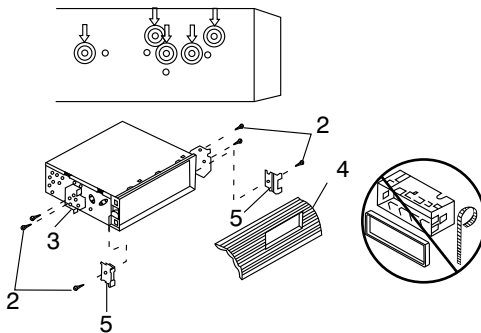

1. Select a position where the screw holes of the bracket and the screw holes of the main unit become aligned (are fitted) and tighten the screws at 2 places on each side.
2. Screw
3. Factory radio mounting bracket.
4. Dashboard or Console
5. Hook (Remove this part)

Note: the mounting box, outer trim ring, and half-sleeve are not used for method B installation.

4. DETACHABLE CONTROL PANEL (D.C.P)

Removing The Detachable Control Panel (D.C.P).



1. Turn the power off
2. Press the D.C.P. release button
3. Remove the D.C.P.

Attaching the DCP

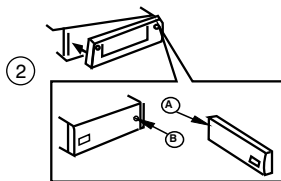

1. Attach the panel at the right side first, with point B on the main unit touching point A on the D.C.P. (As shown on the diagram).
2. Then press the left side of D.C.P. onto the main unit until a "click" sound is heard.

CAUTION

- DO NOT insert the D.C.P from the left side. Doing so may damage it.
- The D.C.P can easily be damaged by shocks. After removing it, place it in a protective case and be careful not to drop it or subject it to strong shocks.
- When the release button is pressed and the D.C.P is unlocked, the car's vibrations may cause it to fall. To prevent damage to the D.C.P always store it in a protective case after detaching it.
- The rear connector that connects the main unit and the D.C.P is an extremely important part. Be careful not to damage it by pressing on it with fingernails, pens, screwdrivers, etc.

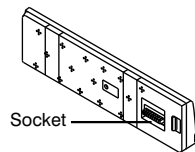

Note:

If the D.C.P is dirty, wipe off the dirt with soft, dry cloth only. And use a cotton swab soaked in isopropyl alcohol to clean the socket on the back of the D.C.P.

RESETTING THE UNIT:

- After releasing the front panel, use a pencil or any non-metallic object to press & hold the reset button for five seconds to reset the unit.

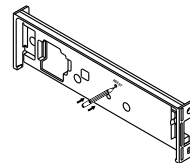

5. WIRING DIAGRAM (20 PIN + ISO PLUG)

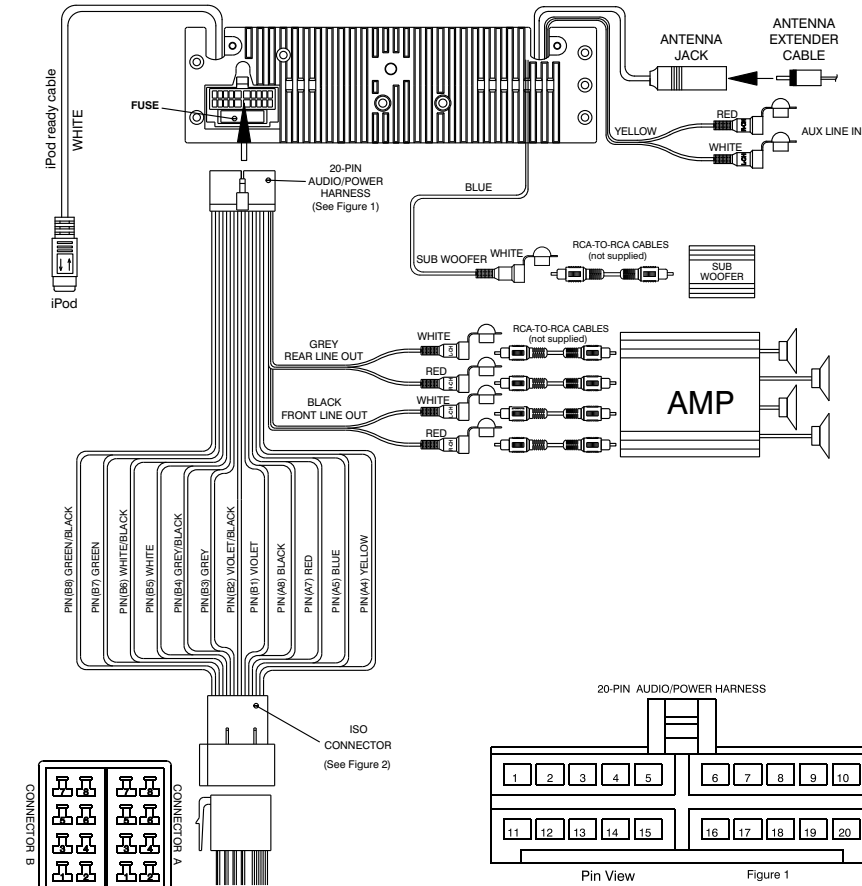
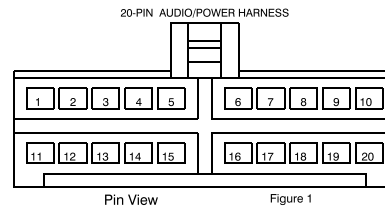

Figure 2
ISO CONNECTOR 4PIN+8PIN
FEMALE WITH MALE TERMINAL

ISO CONNECTOR WIRING CHART

PIN	WIRE COLOR	FUNCTION LABEL
A4	YELLOW	CONSTANT 12 VOLTS (+)
A5	BLUE	POWER ANTENNA
A7	RED	IGNITION(ACC)
A8	BLACK	GROUND
B1	VIOLET	RIGHT REAR SPEAKER (+)
B2	VIOLET/BLACK	RIGHT REAR SPEAKER (-)
B3	GREY	RIGHT FRONT SPEAKER (+)
B4	GREY/BLACK	RIGHT FRONT SPEAKER (-)
B5	WHITE	LEFT FRONT SPEAKER (+)
B6	WHITE/BLACK	LEFT FRONT SPEAKER (-)
B7	GREEN	LEFT REAR SPEAKER (+)
B8	GREEN/BLACK	LEFT REAR SPEAKER (-)



PIN	WIRE COLOR	FUNCTION LABEL
1	GREY/BLACK	RIGHT FRONT SPEAKER (-)
2	GREY	RIGHT FRONT SPEAKER (+)
3	VIOLET	RIGHT REAR SPEAKER (+)
4	VIOLET/BLACK	RIGHT REAR SPEAKER (-)
5		
6	GREEN	LEFT REAR SPEAKER (+)
7	GREEN/BLACK	LEFT REAR SPEAKER (-)
8	RED	IGNITION(ACC)
9	BLACK	REAR PRE-AMP LINE OUT COMMON
10	RED	RIGHT REAR PRE-AMP LINE OUT
11	WHITE	LEFT FRONT SPEAKER (+)
12	WHITE/BLACK	LEFT FRONT SPEAKER (-)
13		
14	BLUE	POWER ANTENNA
15	YELLOW	CONSTANT 12 VOLTS (+)
16	BLACK	CHASSIS GROUND
17	WHITE	LEFT FRONT PRE-AMP LINE OUT
18	RED	RIGHT FRONT PRE-AMP LINE OUT
19	BLACK	FRONT PRE-AMP LINE OUT COMMON
20	WHITE	LEFT REAR PRE-AMP LINE OUT

6. PANEL OPEN/CLOSE OPERATION

This unit is equipped with the most advanced full logic motorized slide down system. You can enjoy this advance technology with just a single press of the "OPEN" button Please read carefully the following operation instruction before operating the unit.

OPEN / CLOSE THE PANEL:

Press the Open button to slide down (open) a closed panel or to slide up (close) an opened panel.

LOADING A CD

When the panel is in the slide down position, the disc slot becomes accessible.

Insert a CD through the disc slot, the CD will be automatically loaded and the panel will also close automatically & playback will begin.

If no CD is inserted, press Open button again to slide up(close) the panel.

EJECTING A CD

Press Open button to slide down the panel, if a CD is loaded, it will be ejected automatically. No further key press is needed.

If the ejected CD is not being removed, after 10 seconds it will be reloaded automatically. And the panel will automatically slide up after disc has been reloaded.

Warning : If the ejected disc remains in the slot, the Open button will not function, so closing the panel by using Open button is prevented unless the disc is removed or reloaded.

CAUTION:

- A) Please always use the "OPEN" button to slide up/ down the front panel. **Please never try to slide up or down the front panel manually**, this will cause serious & permanent damage to the slide down mechanism, and this will void the warranty.
- B) Please do not try to detach / remove the front panel (by pressing the detach button) or attach the front panel when the panel is in the slide down position. This may cause serious & permanent damage to the unit & panel. Only attach or detach the front panel when the panel is in the slide up position.

7. CONTROL PANEL FUNCTION(RDS+iPod)

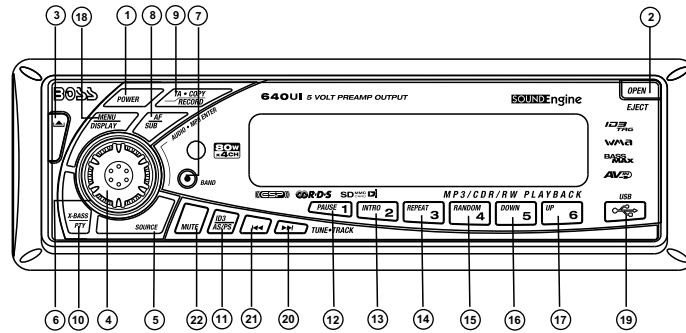

OPERATIONS:

KEY	SYSTEM		TUNER		CD/MP3/WMA		iPod	
	Short Press	Long Press	Short Press	Long Press	Short Press	Long Press	Short Press	Long Press
1	Power							
2	Panel Open & Close				Eject			
3	Panel release button							
4	Audio Menu				Enter		Enter	
5	Mode							
6	Encoder Volume							
7			Band		File/Folder Search	File Erase	iPod Search	
8		Sub-W	AF					
9		Record Copy	TA					
10		ix-Bass	PTY					
11			PS	AS	ID3		iPod information	
12			M1	Memory 1	Pause /Play		Pause /Play	
13			M2	Memory 2	Intro	Folder Intro		
14			M3	Memory 3	Repeat	Folder Repeat	Repeat	Album Repeat
15			M4	Memory 4	Random	Folder Random	Shuffle	Album Shuffle
16			M5	Memory 5	Folder Down			
17			M6	Memory 6	Folder Up			
18	Display	Menu						
19	USB Cover / Socket							
20			Seek Up	Tune Up	Track/File Up	Fast Forward	File Up	Fast Forward
21			Seek Down	Tune Down	Track/File Down	Fast Backward	File Down	Fast Backward
22	Mute							

8. BASIC OPERATIONS

3) PANEL RELEASE BUTTON ()

Press this button to remove the control panel.

1) POWER ON/OFF BUTTON (POWER)

Press POWER button or any other button on the front of the radio (except Open/Eject) to turn the unit on. Press POWER button again to turn the unit off.

2) MUTE BUTTON (MUTE)

Press the mute button momentarily to mute the audio volume, and "Mute" will flash in the display. Press the mute button again to restore volume to the previous setting.

8) SUB-WOOFER (SUB-W)

Long press the SUB-W button to activate the Subwoofer function On, and "Subwoofer" will appear on the LCD display for 3 seconds. Press the SUB-W button again to turn off the Subwoofer function.

NOTE Please refer to the related description in "Audio Operation of Subwoofer" for details operation of the Subwoofer control !

TIPS The Subwoofer Level and Low Pass Filter control will only appear in the Audio Menu only if the Subwoofer function is currently activated 'On'.

10) iX-BASS BUTTON (iX-Bass)

Long press the iX-Bass button to turn on the **iX-Bass** function, and "iX-Bass" will appear in the LCD display for 3 seconds. Press the iX-Bass button again to turn off the **iX-Bass** function.

NOTE Please refer to the related description in "Audio Operation of iX-Bass" for details operation of iX-Bass control !

TIPS The **iX-Bass** Boost Level control will only appear in the Audio Menu only if the iX-Bass function is currently activated 'On'.

5) MODE BUTTON (SOURCE)

Press MODE button to select a different mode of operation as indicated on the display panel. Available modes include Tuner, CDP, USB Host, SD/MMC , iPod and Aux Line In .

AUX INPUT

Connect the external signal to the RCA line in jack located at the rear of the **unit**, then press Mode button to select Aux mode. Press Mode Button again to cancel Aux Mode and return to previous mode.

6) ENCODER VOLUME BUTTON

To increase the volume, rotate the volume control **clockwise**. To decrease the volume, rotate the volume control counter clockwise. When volume is adjusted, the volume level will be shown on the display panel as a number ranging from 0 (lowest) to 46 (highest).

18) DISPLAY (DISPLAY)

Press DISPLAY/MENU momentarily to navigate through the following Display , and back to the default display. The selected display mode will appear in the LCD when the unit is turned on.



Default Display



EQ Animation

9. MENU OPERATION

18) MENU FUNCTION LIST (MENU)

Press DISPLAY/ MENU for more than 3 seconds to access the menu. **MENU** will appear in the display momentarily. Navigate the menu by pressing DISPLAY/ MENU momentarily to move forward to the next option. The menu can also be navigated by using the Tuning Up or Tuning Down Button to move to the next or previous option. Once the desired option appears in the display, adjust that option by rotating the volume control within 5 seconds. The following options are adjusted through this menu feature.

Contrast

The contrast level of the display is set at "CONTRAST 05" by default. Rotate the volume control To adjust the contrast level from 00 to 10.

Clock Format

This option allows selection of a 12 hour or 24 hour clock format. "CLK FORMAT 12H" is the Default setting. Rotate the volume control to change to the 24 hour clock format.

Time Set

The time on the clock will be set to 12:00 as the default. Program the current time by rotating the volume control clockwise to adjust the minutes and counterclockwise to adjust the hours.

Local / Distance Select

This feature is used to designate the strength of the signals at which the radio will stop during automatic tuning. "Distance" is the default, allowing the radio to stop at a broader range of signals. To set the unit to select only strong local stations during automatic tuning, rotate the volume control until "Local" appears in the display.

Regional On/Off (Region)

REGIONAL "OFF" will be displayed by default. The user now has 5 seconds to adjust by using volume up/down button from "off" to "On". If "on" is selected when the AF search or PI seek, it will implement to station which have all the PI codes which are the same as current station. If "off" is selected, when AF search or PI seek the regional code in the format PI code will be ignored. A regional station is possible to be received.

NOTE The Regional function On/Off Setting is valid when the "AF" function is "on"

Programmable Turn-on Volume (VOL PGM)

This option allows selection of the volume level the radio will automatically assume when first turned on. "VOL PGM 12" is the default setting, which will turn the radio on at the volume level selected when the unit was last turned off.

To program a specific volume level for the radio to turn on at, rotate the volume control to select "VOLUME LEVEL". Within 5 seconds.

Beep Tone

The beep tone feature allows the selection of an audible beep tone to be heard each time a button is pressed on the face of the radio. "BEEP TONE On" is the default display. Rotate the volume control to select the "BEEP TONE Off" option.

Illumination Color (COLOR)

This option allows selection between two colors for the backlight illumination of the unit.

"COLOR 1" is the default display and will illuminate the unit in blue backlight. Rotate the volume button to select "COLOR 2", which will illuminate the display in red backlight.

Record Quality (REC MODE)

This feature allows the selection of the Recording Quality for FM, AUX Line in. The default mode is "Std" (Standard mode) Rotate the volume control to select the "High" (High Quality Mode) option.

Tips Pls refer to RECORD Operation regarding the details specification of the Std / High Quality mode

NOTE Under Recording is progressing, the "REC MODE" will not appear in the Menu list.

10. AUDIO OPERATION

Audio Menu

Press "AUDIO" button to access the Audio Menu. User can navigate thru the Audio Menu items by pressing the "AUDIO" button repeatedly, or by pressing the Tuning Up or Tuning Down Button. Once the desired menu item appears on the display, adjust that option by using the Volume Up or Down button within 5 seconds. The following menu items can be adjusted as described above. The unit will automatically exit the Audio Menu after five seconds of inactivity.

VOLUME (Volume Level)

- User has 5 seconds to use the Volume button to adjust the desired volume level, the volume level will be shown on the LCD display as a number ranging from 00 (lowest) to 46 (highest).

SUBWOOFER (Subwoofer Level)

- User has 5 seconds to use the Volume Knob to adjust the Subwoofer level from '00' to '12'.

NOTE The Sub-woofer level control is only applicable if the unit is equipped with the optional sub-woofer line out, and only if connected to an optional subwoofer speaker.

NOTE The Subwoofer level control option will only appear in the Audio Menu if the "Subwoofer" function is activated "ON" by pressing the "Sub-w" button on control panel.

SUB-W LPF (Subwoofer Low Pass Filter)

- User has 5 seconds to use the Volume Up or Down button to select the 3 different Low Pass filter to Flat, 80Hz, 120Hz or 160Hz.

NOTE The Subwoofer LPF control is only applicable if the unit is equipped with the optional subwoofer line out, and only if connected to an optional subwoofer speaker.

NOTE The Subwoofer LPF option will only appear in the Audio Menu if the "Subwoofer" function is activated by pressing the "Sub-w" button on control panel.

iX-BASS (iX-Bass Level)

- User has 5 seconds to use the Volume Knob to select the 3 different Bass Boost level: Low, Mid, or High.

NOTE The iX-Bass option will only appear in the Audio Menu if the "iX-Bass" feature is currently activated "ON" by pressing the "iX-Bass" button on control panel.

BASS (Bass Level)

- User has 5 seconds to use the Volume Up or Down button to adjust the desired Bass level range from -6 to +6.

BASS -CFQ (Bass Center Frequency).

- User has 5 seconds to use the Volume Up or Down button to adjust the desired Bass Center Frequency to 60Hz, 80Hz, 100Hz, or 200Hz.

BASS-Q: (Bass Quality Factor)

- User has 5 seconds to use the Volume Up or Down button to adjust the desired Bass Quality Factor to 2N, 1N, 1W or 2W.

Figure 1 shows the Bass Quality factor (Curve characteristics) of each step.

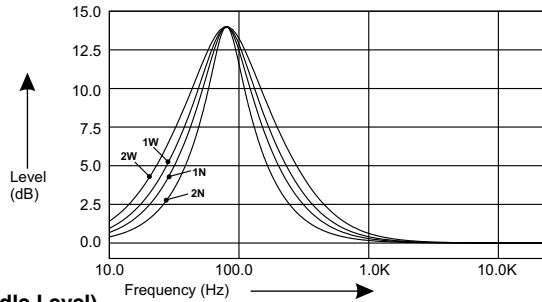

Figure 1

MIDDLE (Middle Level)

- User has 5 seconds to use the Volume Up or Down button to adjust the desired Middle level range from -6 to +6.

MID-CFQ (Middle Center Frequency)

- User has 5 seconds to use the Volume Up or Down button to adjust the desired Middle Range Center Frequency to 500Hz, 1KHz, 1.5KHz, or 2.5KHz.

MIDDLE-Q (Middle Quality Factor)

- User has 5 seconds to use the Volume Up or Down button to adjust the desired Middle Quality Factor to 2N, 1N, 1W or 2W.

Figure 2 shows the middle Quality factor (Curve characteristics) of each step.

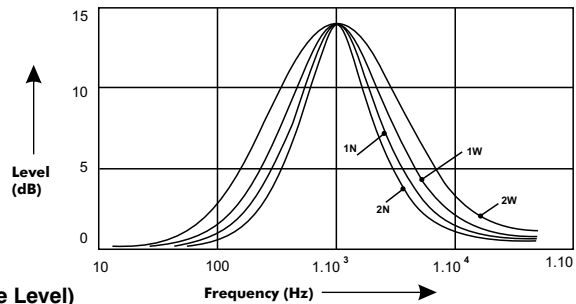

Figure 2

TREBLE (Treble Level)

- User has 5 seconds to use the Volume Up or Down button to adjust the desired Treble level range from -6 to +6.

TRE-CFQ (Treble Center Frequency)

- User has 5 seconds to use the Volume Up or Down button to adjust the desired Treble center frequency to 10KHz, 12.5KHz, 15KHz, or 17.5KHz.

BALANCE

- User has 5 seconds to use the Volume Up or Down button to adjust the Balance between the right and left speakers from R12 (full right) to L12 (full left). "C00" represents an equal balance between the right and left speakers.

FADER

- User has 5 seconds to use Volume Up or Down button to adjust the Fader between the front and rear speakers from R12 (full rear) to F12 (full front). "C00" represents an equal balance between the front and rear speakers.

11. TUNER OPERATION

7) BAND BUTTON (BAND/SEARCH)

Press BAND to change between FM bands and AM(MW) bands.

20-21) TUNING UP/DOWN BUTTON (◀▶)

Manual Tuning

Press the Up Tuning or Down Tuning button for more than 3 seconds to move the radio frequency number up or down one step.

Auto Seek Tuning

Press the Up Tuning or Down Tuning button for less than 3 seconds to move to next station automatically.

12-17) PRESET STATIONS BUTTONS

Six numbered preset buttons store and recall stations for each band.

Store a Station

Select a band (if needed), then select a station. Hold a preset button for 3 seconds. The preset number will appear in the display.

Recall a Station

Select a band (if needed). Press a preset button to select the corresponding stored station.

11) AUTOMATICALLY STORE / PRESET SCAN (AS/PS)

Automatically Store

Automatically select 6 strong stations and store them in the current band. Select a band (if needed). Press AS/PS button for more than three seconds. The new stations replace stations already stored in that band.

Preset Scan

Scan stations stored in the current band. Select a band (if needed). Press AS/PS button for less than 3 seconds. The unit will pause for ten seconds at each preset station. Press AS/PS button again to stop scanning when the desired station is reached.

STEREO

The unit will automatically pick up a stereo signal, when available. When in stereo mode, the ST icon appears in the display. When no stereo signal is available, the unit will automatically revert to mono operation, and no icon will be displayed.

IMPORTANT NOTE ON THE EUROPEAN / RDS TUNER SETTING

This unit Tuner setting is default at "U.S.A" frequency. If user is using this unit in European Area with RDS Radio System. Please long press Open / Eject button on the panel to activate the RDS Radio System. After the "Europe On" displayed on the LCD. Now the radio system was changed from U.S.A to European RDS System. Long press Open / Eject button again can Off the European RDS System.

NOTE For details operation of the RDS system, please refer to page "RDS Operation".

12. RDS OPERATION

RDS functions

The unit is equipped with the following RDS function:

AF = Alternative Frequencies
 CT = Clock Time
 EON = Enhanced other Network
 PI = Program identifications
 PS = Program service name
 PTY = Program Type
 REG = Regional Change
 TA = Traffic Announcement
 TP = Traffic program

1. AF Function

By pressing AF button < 3 seconds to select AF ON/OFF. "AF ON" or "AF OFF" will show & remain on the LCD segment for 5 seconds.. Under AF "On" mode, if the tuned in station signal is getting weak, the unit will automatically switches to a different frequency on the same network with stronger signal.

Note1: Factory Default setting is "AF ON"

2. TA Function

By pressing TA button < 3 seconds, turn switch on TA standby mode. "TA ON" will show & remain on the LCD segment for 5 seconds & the TA icon will light up on the LCD. In the stand by mode, when a traffic announcement broadcast starts, the traffic announcement broadcast will be received as top priority regardless of the function mode. When a traffic announcement starts, "TRAFFIC INFO" will show on the LCD, press the TA button can cancelled the broadcast reception while a traffic announcement broadcast is being received. The unit will go back to the previous mode and TA goes into stand by mode again. When the TP icon is not light up for 60 seconds. A beep Alarm tone is heard and the LCD will show "Lost TP, TA". TA seek will automatic activate and searches to another TA station.

3. PTY Function

Pressing PTY button < 3 seconds to goes into PTY select mode. "PTY" icon will light up on the LCD. The LED around encoder volume will starts blinking. The user now has 5 seconds to select the desired PTY item by using volume up/down button. Once selected the PTY item, user have 5 seconds to press "SELECT" or "TUNE UP or TUNE DOWN" buttons < 3 seconds to seek for the selected PTY item. The LCD will display "PTY SEEK". If no station with the selected PTY broadcast can be received, the LCD will display "No Match PTY" and blinks for 5 seconds then returns to the previous mode.

User can store his favor PTY into the preset memory M1 to M6. After selected a PTY item, long press any one of the preset memory button can store the selected PTY. To recall the stored PTY item by switching on PTY mode then press preset memory < 3 seconds, the unit will automatically search the stored PTY station in the preset memory

Music Group	Speech Group
POP , ROCK	NEWS, AFFAIRS, INFO
EASY, LIGHT	SPORT, EDUCATE, DRAMA
CLASSICS, OTHER	CULTURE, SCIENCE, VARIED
JAZZ, COUNTRY	WEATHER, FINANCE, CHILDREN
NATION, OLDIES	SOCIAL, RELIGION, PHONE IN
FOLK	TRAVEL, LEISURE, DOCUMENT

Note: Factory default stored for PTY preset memory.

M1/News, M2/Information, M3/Pop Music, M4/Sports, M5/Classics, M6/Finance.

13. CD /MP3/WMA OPERATION

INSERT AND EJECT CD

Insert a CD label-side up with the unit turned on, and the disc will begin to play. Press the Eject button to stop CD play and eject the CD. The unit does not have to be turned on to eject the CD.

CD-DA OPERATION

12) PAUSE BUTTON

Press the pause button to suspend disc play. Press the pause button again to resume disc Play.

20-21) TRACK SELECT

Press the Up Tuning or Down Tuning button (**⏮** **⏭**) for less than one second to advance to the next track on the CD, The selected track number will appear on the display. Press and hold the Up Tuning or Down Tuning button (**⏮** **⏭**) for more than one second to fast forward or fast reverse through the disc. CD play starts when the button is released.

14) REPEAT BUTTON (REPEAT)

Press REPEAT BUTTON (REPEAT) during disc play to continuously repeat the track. Press REPEAT BUTTON (REPEAT) again to stop Repeating.

15) RANDOM BUTTON (RANDOM)

Press RANDOM BUTTON (RANDOM) during disc play to play all tracks on a CD in random, shuffled order. Press RANDOM BUTTON (RANDOM) again to stop random play.

13) INTRO SCAN BUTTON (INTRO)

During disc play, press INTRO SCAN BUTTON (INTRO) to play the first 10 seconds to each track on the disc. When the desired track is reached, press INTRO SCAN BUTTON (INTRO) again to end the scan and play the selected track.

MP3/WMA OPERATION

MP3 and WMA (Windows Media Audio) music files are audio compression format. This unit can play MP3/WMA directly from files contained on a CD-R/RW, USB Memory Stick, SD or MMC Memory Card.

Notes on MP3/WMA Play

This unit can play MP3 (MPEG1, 2, 2.5 Audio Layer 3). However, the MP3 recording media and accepted formats are limited. When writing MP3/WMA, pay attention to the following restrictions.

Acceptable Medium Formats

The following formats are available for the media used in this unit. The maximum number of characters used for file name including the delimiter (".") and three-character extension are indicated in parentheses.

- ISO 9660 Level 1 (11 characters)
- ISO 9660 Level 2 (31 characters)
- Joliet (31 characters)
- Romeo (31 characters)

Up to 200 characters can be displayed in the long file name format. For a list of available characters, see the instruction manual of the writing software and the section "Entering File and Folder Names" below. The media reproducible on this unit has the following limitations:

- Maximum number of nested folders: 8
- Maximum number of files per disc: 999
- Maximum number of files per media device: 2000
- Maximum number of folders per disc: 255

MP3/WMA written in the formats other than the above may not be successfully played and their file names or folder names may not be properly displayed.

MP3/WMA Encoder and CD Writer Settings

Use the following settings when compressing audio data in MP3 data with the MP3 encoder.

- Transfer bit rate : 32- 320 kbps
- Sampling frequency : 32,44.1,48 kHz(WMA) 16,22.05,24,32,44.1, 48kHz (MP3)

When using a CD writer to record MP3/WMA up to the maximum disc capacity, disable additional writing. For recording on an empty disc up to the maximum capacity at once, check disc at once.

Entering ID3 Tag

This unit supports ID3 tag versions 1.0 and 1.1.

Entering File and Folder Names

Names using the code list characters are the only file names and folder names that can be entered and displayed. Using any other character will cause the file and folder names to be displayed incorrectly. The unit recognizes and plays only files with the MP3/WMA extension.

NOT → *A file name entered with characters not on the code list may not play correctly.*

Writing Files into a Media

When a media containing MP3/WMA data is loaded, the unit checks all data. If the media contains many folders or non-MP3/WMA files, MP3/WMA play will be delayed, it may take time for the unit to move to the next file, and searches may not be performed smoothly. Loading such a media may produce loud noise and cause damage to the speakers. **Do not attempt to play a media containing a non-MP3/WMA file with the MP3/WMA extension or a media containing non MP3/WMA files.**

Bit Rates

The unit supports bit rates from 32 - 320 kbps.

Files Playing Order

When selected for play, Folder Search, File Search or Folder Select, files and folders are accessed in the order in which they were written by the PC writer. Because of this, the order in which they are expected to be played may not match the order in which they are actually played. For example, a media with the following folder/file hierarchy is subject to Folder Search, File Search or Folder Select as shown below.

- An outline of a Media with MP3/WMA is shown below. Subfolders are shown as folders in the folder currently selected.

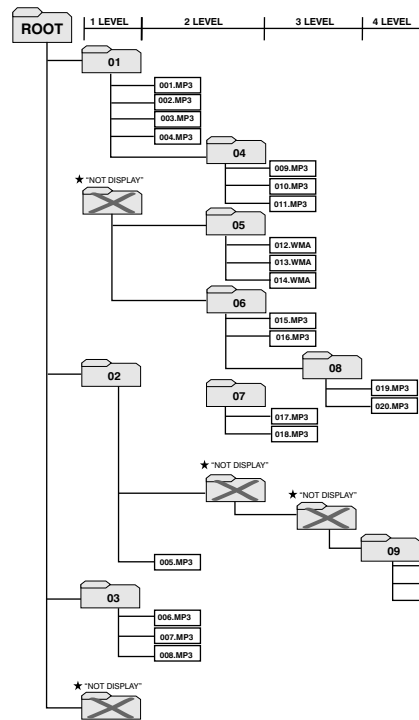

- The equipment assigns folder numbers. The user can not assign folder numbers.
- ★ It is not possible to check folders that do not include MP3/WMA files. (These folders will be skipped without displaying the folder number and name)

FILE/FOLDER PLAY

There are three different play methods as following:

File/Folder Intro play:

- Press M2 button more than 3 seconds during playing MP3/WMA disc for "intro play" all files of the current folder. Intro play should restart from the first song of the current folder, after all files in the current files have been intro-played.
To disable current folder "intro play", long press M2 button more than 3 seconds
- Press M2 button less than 3 seconds is "intro play" all files on the disc. Intro play should restart at the very first file of the disc after all files in the disc has been intro played.
To disable all files "intro play", press M2 button less than 3 seconds

File/Folder Repeat play :

- Press M3 button more than 3 seconds during playing MP3/WMA disc for “repeat play” all files of the current folder. And keep on repeat playing the current folder until “repeat play” is disabled.
To disable current folder “repeat play”, long press M3 button more than 3 seconds
- Press M3 button less than 3 seconds to “repeat play” the current file. And keep on repeat playing the current file until the “repeat play” is disabled.
To disable current file “repeat play”, press M3 button less than 3 seconds

File/Folder Random play:

- Press M4 button more than 3 seconds during playing MP3/WMA disc to “random play” all files of the current folder.
To disable current folder “random play”, long press M4 button more than 3 seconds
- Press M4 button less than 3 seconds is “random play” all files on the disc.
To disable all file “ random play”, press M4 button less than 3 seconds.

Folder Up / Down Play

- Press M5 button less than 3 seconds to One Folder Down
- Press M6 button less than 3 seconds to One Folder Up

MP3/WMA File or Folder Search**Direct File Number Searching**

Press BAND button. The LCD will display "Number", and the illumination around the select knob will blink. Rotate the knob to select the desired track number, then press in on the knob to confirm and play the selected file.





Folder / Files Navigate Searching

Press BAND button twice. The LCD will display "Navigate", and the illumination around the select knob will blink. Rotate the knob to navigate through all folders and sub-folders on the disc. The folder names will be displayed on the LCD. Press the select knob for more than three seconds to play the first file in the folder. Press the select knob for less than three seconds to access the sub-folders or files. Rotate the select knob to navigate, then press the select knob to confirm and begin file play. During navigation search, press AS/PS or rotate the select knob counter-clockwise to move back to the last upper level of a folder.

ID3 INFORMATION DISPLAY

If any MP3/WMA file recording with ID3 Tag information. The ID3 information such like Album title, Track title, Artist Title will be displayed and automatic scrolling through the LCD while the file is playing. User also allows pressing the AS/PS button repeatedly to view the ID3 tag information manually.

NOTE OF ID3 ICONS ON DISPLAY

ICON	DESCRIPTION
	FOLDER ICON
	FILE ICON
	TRACK ICON
	ARTIST ICON
	ALBUM ICON

14. USB OPERATION

The unit can support USB Host Function. It can playback MP3 and WMA Audio format which are stored into USB Memory Stick or USB interface Music Player. **Please** read below before you start the operation of USB HOST Function.

Inserting and Removing USB Drive

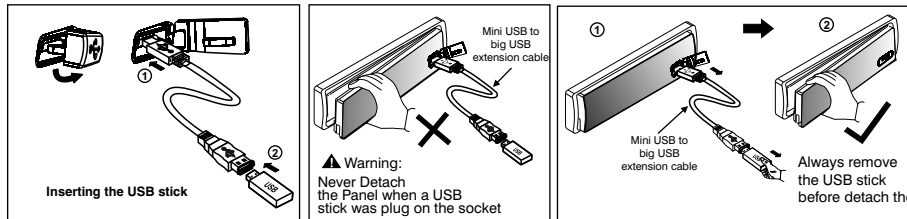

Mode change to USB HOST

Under any other mode while inserting a USB Stick into the front panel USB plug, the unit will Automatically switches from present playing mode to USB HOST mode. The unit will display 'USB HOST' for a while then starts 'Reading' the files contained on the USB Stick. Once the unit read the USB Stick successfully, the first audio music file on the USB stick Playback will Automatically start. Press Mode button repeatedly to change to other modes or switch back to USB HOST.

▲ WARNING:

Before remove the USB stick from the Front panel USB plug. Always remember to switch off the unit's power or switch to other mode then remove out the USB Stick. Never try removing the USB Stick while playing music file on the USB stick. It may damage the USB Stick and sometimes will caused the unit system lock up.

NOTE The unit can support playback Music Player which have USB Interface. However due to the fast changing decoder technology and different kind of hardware interface. This unit may or may not be compatible to all the Music Player and USB Stick especially those USB Stick / Player which require to install a program driver.

NOTE About Music Flash Player with USB Interface, Usually, the unit takes longer time to read this kind of player than normal USB Stick. Especially, if the Flash Player with built-in power battery sometimes takes 20-30 seconds to start up the playback

NOTE The unit is not compatible to playing any Portable Hard disk.

Music File Playback Operation

All the USB playback operation function is same as the operation on CD/MP3/WMA. **Please** refer to 'CD/MP3/WMA Operation' for more details.

15. MEMORY CARD OPERATION

The unit can support playback MP3 and WMA Audio format which are stored into **SD** and **MMC** Memory Card . Please read below before you start the operation of Memory Card

Inserting and Removing a SD or MMC card on the main unit

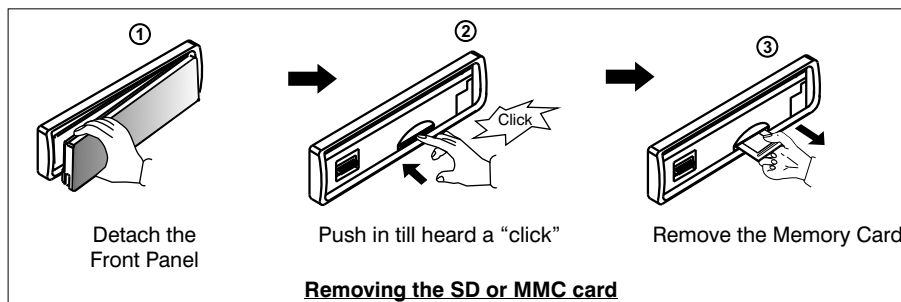
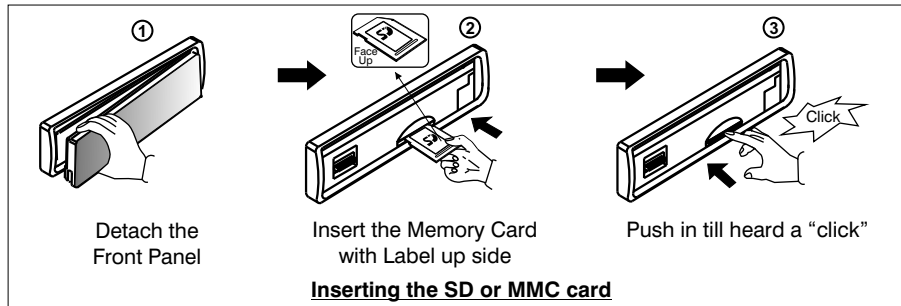

Mode change to MEMORY CARD

After a SD or MMC card was inserted into the main unit card slot. Press Mode button to select **SD/MMC** mode .The unit will display **SD/MMC** for a while then starts **Reading** The files contained on the Memory Card. Once the unit read the MEMORY CARD successfully, the first audio music file on the Memory Card will automatically start playback. Press Mode button repeatedly is allowing changing to other modes or switch back to **SD/MMC** mode.

NOTE If **no Memory** Card is inserted into the main unit card slot. Press mode button will automatically skip **SD/MMC** mode.

Music File Playback Operation

All the SD or MMC Memory Card playback operation function is same as the operation on CD/MP3/WMA. Please refer to 'CD/MP3/WMA Operation' for more details.

16. RECORDING OPERATION

This unit allows user to RECORD his favorite Music and Audio. You can store your favor Music and Audio to the USB Stick, as well as Memory Card. Please read below for the details operation of the RECORD function.

RECORDABLE MEDIA

The following audio sources modes are available for record on this unit.

- FM Radio : Recording FM Program
- CDP : Recording CD Music
- iPod Mode : Recording iPod Audio Muisc
- AUX in Mode : Recording AUX Line in Audio

STORAGE DEVICES FOR RECORD

The following media can be used for storage of the music or audio files on this unit :

- Removable USB Stick
- SD Memory Card
- MMC Memory Card

RECORDING FM or iPod Audio Music or AUX line in music

This operation must to be performed in the FM Radio Mode or iPod Mode or AUX Mode.

- **To START Recording:**
 1. Long press COPY / RECORD button on the front panel to activate the RECORD mode.
 2. The LCD will display **Rec → USB** as default, rotate the encoder volume knob to Navigate thru **Rec → USB** > **Rec → CARD** > for selection of the storage Media.
 3. Once selected the storage media, Press AUDIO button as confirmation to start the record to this selected media. If no further button is press within the 10 second time out, the unit will automatically resume to the previous mode.
 4. If unit detect the selected device memory capacity is used up, **Memory Full** will display on the LCD for a while then automatically resume to the previous mode (The following step is an example of if selected USB)
 5. Under RECORD processing, the LCD will display **Rec ××× USB** following with the elapsed time.
- NOTE** 1) Under recording mode, all the FM/iPod/AUX operation is not functional, like Tune Up / Down , Preset Memory 1 -6 etc.
2) The Audio will remain in recording mode even MUTE function is activated.
3) The Recording will automatically stop if the storage device memory is full.
- Tips** Record Quality- The unit have TWO record quality mode, Standard & High for selection in the MENU. Please see "MENU"- "REC MODE" for details operation

The below table indicates the difference of TWO Record quality mode

Record Mode	Bit Rate	Sample Rate	Capacity
High(High)	96KbPs	44.1KHZK	About 0.7MB/minute
Standard(Std)	128KbPs	44.1KHZK	About 0.35MB/minute

● **To STOP Recording**

1. Long press **COPY / RECORD** button again to stop the recording. The LCD will display **Rec ■ USB** and the recorded FM Program or Music is automatically saved as a saved as a file into the Folder, "MY_TUNER" by the advance "File Management." System of this unit.

Tips For more details information of File Management system of this unit. **Please** see "FILE MANAGER".

NOTE The unit will terminate the recording automatically under the following operation, but the FM Program or Music have been recorded will be kept & saved as a file into the folder, "MY_TUNER".

- 1) Switch the Power to off mode
- 2) Mode change
- 3) Inserting a CD Disc
- 4) Inserting a USB Stick
- 5) Detach the Front Panel from the main unit

To PAUSE Recording

This unit can allow the user to PAUSE the recording. This is a useful function for the user to cut commercial or advertises program which he may not want to record into file.

1. During the recording, press "PAUSE" button to pause the record. The LCD will display **Rec ■ 00:00** until the PAUSE button is pressed again to resume the recording.

RECORDING CD MUSIC

This operation only can be performed when the unit is in the CD PLAYING Mode.

1. Playback a track to be recorded, then long press button **COPY / RECORD** on the front panel to activate the RECORD mode .
2. The LCD will display **Rec ■ USB** as default, Rotate the encoder volume knob to navigate thru **Rec ■ USB** > **Rec ■ CARD** for selection of the storage media.
3. Once selected the storage media, Press **AUDIO** button as confirmation to start the record to the selected media. If no further button is press within a 10 second time out, the unit will automatically resume to the previous mode.

4. If the unit detects the selected media memory capacity is used up, **Memory Full** will be displayed on the LCD for a while then automatically resume to previous mode (The following step in an example of if selected USB).
5. After pressing AUDIO button to start the record , the unit will re-start playback from the beginning of the track and the recording will start at the same time.
6. Under RECORD processing, the LCD will displayed **Rec x USB** following with the elapsed time.
7. When the recording is completed, the LCD will displayed **Rec 4 USB** for a while and automatically playback the next music track on the CD disc. The recorded music is automatically saved as a file into the Folder , "MY_CD" by the advance "File Management." system of this unit .

Tips For more details information of File Management system of this unit. **Please** see "FILE MANAGER".

- NOTE** 1) Under recording mode, All the CD operation is not functional, like Track up / down, Repeat, Random, Intro etc.
 2) The Audio will remain recording mode by the unit system even MUTE function is activated.
 3) The Recording will automatically stop if the storage device memory is full.

● **To Cancel Recording**

1. Long press button COPY / RECORD again to cancel the recording. The LCD will display **Rec ■ USB** . The track that has been recorded incompletely will be deleted.

NOTE The unit will cancel the Recording automatically under the following operation.
 The track that has been recorded incompletely will be deleted.

- 1) Switch the power to off mode
- 2) Mode change
- 3) Inserting a CD Disc
- 4) Inserting a USB Stick
- 5) Detach the Front Panel from the main unit

▲ WARNING:

- 1) Never remove the USB Stick while recording to USB Stick. It may damage the USB Stick and **sometimes** will caused the unit system lock up.
- 2) This is not recommend to insert USB stick while recording is under progress to other storage **device**. Always remember to stop the record or after the record is completed, then insert the USB stick.
- 3) Do not switching mode of the unit during the Recording
- 4) Do not turn off the Power of the unit during the Recording
- 5) Do not switch the ignition key off during the Recording

17. MUSIC FILES TRANSFERRING

Thanks for the most useful and convenient files transferring function of this unit, user can easily transfer music files between , USB Stick, SD or MMC Memory card and on the CD Disc. Please read below for the details operation of this function:

TRANSFERABLE MEDIA

Files are transferable within the following media:

- Removable USB Stick
- SD Memory Card
- MMC Memory Card

MUSIC FORMAT SUPPORTED BY FILE TRANSFER ARE

- MP3 and WMA

TRANSFER MP3 OR WMA MUSIC FILES ON CD DISC

This operation only can be performed during disc playing a MP3 or WMA music file.

1. Playback a music file to be transferred and then long press the COPY / RECORD butto to activate the Transfer mode.
2. The LCD will display **USB** as default, Rotate the encoder volume knob to navigate thru **USB** > **CARD** > for selection of the storage media.
3. Once selected the storage media, Press AUDIO button as confirmation to transfer the playing file. If no further button is press within a 10 second time out, the unit will automatically resume to the previous mode.
4. If the unit detected the selected media memory capacity is used up, **Memory Full** will be displayed on the LCD for a while then automatically resume to the previous mode.
5. After pressing AUDIO button to start the transfer, the playing music file will stop and the transferring will start at the same time. (The following step is an example of if selected USB).
6. When the transfer is processing, the LCD will displayed **10% USB**.
7. When the file transfer is completed, the LCD will display **100% USB** for a while and automatically playback the present music file which have been transferred. The transferred music file is automatically saved as a file into Folder "MY_MP3" or "MY_WMA" by the advance "File Management." system of this unit.

Tips For more details information of File Management system of this unit. Please see "FILE MANAGER".

NOTE Under transferring mode, All the MP3/WMA operation is not functional, like file up / down, Repeat, Random, and Intro etc.

NOTE The audio will remain recording by the unit system even MUTE function is activated

NOTE The Transferring will automatically stop if the storage device memory is **less than 2MB**

● **To Cancel Transferring.**

1. Long press button COPY / RECORD again to cancel the recording. The LCD will display

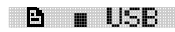





 The music file that has been transferred incompletely will be deleted.

NOTE The unit will stop the file transfer automatically under the following operation, the music file that has been transferred incompletely will be deleted.

- 1) Switch the power to off mode
- 2) Mode change
- 3) Inserting a CD Disc
- 4) Inserting a USB Stick
- 5) Detach the Front Panel from the main unit

TRANSFER MP3 OR WMA MUSIC FILES BETWEEN MEDIA DEVICES

Select a device by mode button and playback the music file need to be transfer:

1. Long press the COPY / RECORD button to activate the transfer mode.
2. The LCD will display  as default, Rotate the encoder volume knob to navigate thru  >  > for selection of the storage media.
3. Once selected the storage media, Press AUDIO button as confirmation to transfer the playing file. If no further button is press within a 10 second time out, the unit will automatically resume to the previous mode
4. If the unit detected the selected media memory capacity is used up,  will be displayed on the LCD for a while then automatically resume to the previous mode.
5. After pressing AUDIO button to start the transfer, the playing music file will stop and the transferring will start at the same time. (The following step is an example of if selected USB).
6. When the transfer is processing, the LCD will displayed .
7. When the file transfer is completed, the LCD will display  for a while and automatically playback the present music file which have been transferred. The transferred music file is automatically saved as a file into Folder "MY_MP3" or "MY_WMA" by the advance "File Management." system of this unit.

Tips For more details information of File Management system of this unit. Please see "FILE MANAGER".

NOTE Under transferring mode, All the MP3/WMA operation is not functional, like file up / down, Repeat, Random, and Intro etc.

NOTE The audio will remain recording by the unit system even MUTE function is activated

NOTE The Transferring will automatically stop if the storage device memory is **less than 2MB**

▲ WARNING:

- 1) Never remove the USB Stick while recording or file transferring to USB Stick. It may damage the USB Stick and sometimes will caused the unit system lock up.
- 2) It is not recommended to insert USB stick while recording is under progress to other storage device. Always remember to stop the recording or after the recording is completed, then insert the USB stick.
- 3) Do not switching mode of the unit during the File Transferring .
- 4) Do not turn off the Power of the unit during the File Transferring.
- 5) Do not switch the ignition key off during the File Transferring

18. MUSIC FILES ERASING

You can erase files from the USB Stick or Memory Card Please read below for the details operation of this function:

ERASABLE MEDIA

- USB Stick and Memory Card .

NOTE ➤ Music files which are on the CD Disc is NOT ERASABLE by this unit.

ERASING MUSIC FILES ON THE MEDIA

There are THREE different methods for erasing files;

1. Erase while the Music File is playing.

- Long press BAND button to activate the ERASE mode
- The LCD will display **ERASE 0010**
- Short Press the AUDIO to enter into the ERASE mode.
- Once enter into the erase mode. You can rotate the encoder volume knob to select “**▶**” as to confirm the erase or rotate the volume knob to select “**✕**” as for cancel the erase mode. If no further button is press within 5 seconds time out. The unit automatically resume to the previous mode.
- Once the “**▶**” is display on the LCD, press the AUDIO button again to final confirm erase the present playback music file.

NOTE ➤ If want to CANCEL the erase of the present music file, Rotate the encoder volume knob to “**✕**”. Once the “**✕**” is displayed on the LCD, press the AUDIO button again to cancel the erase mode.

- After pressing AUDIO button to start the ERASE, the present playing music file will stop and the erasing will start at the same time.
- **ERASE 0010** ✓ will display on the LCD after the music file erase is successful, and the unit will automatically start playback the next music file.

2. Erase under Files Number Search Mode

User can select the Music file Number want to erase by file Number Search mode



- After selected the file number want to erase, Long press the BAND button to activate the ERASE mode.
- The LCD will display **ERASE 0010** .
- Short Press the AUDIO to enter into the ERASE mode
- Once enter into the erase mode. User can rotate the encoder to select “**▶**” to confirm the erase or rotate the volume knob to select “**✕**” to cancel the ERASE mode. If no further button is press within a 5 second time out. The unit automatically resume to the previous mode.
- Once the “**▶**” is displayed on the LCD, press the AUDIO button to final confirm to erase the selected music file.



NOTE ➤ If want to CANCEL the erase of the present music file, Rotate the encoder to “**✕**”. Once the “**✕**” is display on the LCD, press the AUDIO button again to cancel the erase Mode.



- After pressing AUDIO button to start the ERASE, the present playing music file will Stop and the erasing will start at the same time
- **ERASE 0010** ✓ will display on the LCD after the music file erase is successful, and the Unit automatically start playback of the next music file.

3. Erase under Files NAVIGATE search mode

You can select a Music file want to erase by files Navigate Search mode

- After selected the music file want to erase by files navigate search, Long press BAND button to activate the ERASE mode.
- The LCD will display **ERASE 010**.
- Short Press the AUDIO button to enter into the ERASE mode
- Once Enter into the ERASE mode, user can rotate the encoder to select “” as to confirm the erase or rotate the volume knob to select “” to cancel the ERASE mode. If no further button is press within a 5 second time out. The unit will automatically resume to the previous mode.
- Once the “” is displayed on the LCD, press the AUDIO button again to final confirm Erase the selected music file.

NOTE If want to CANCEL the erase of the present music file, Rotate the encoder to “”
Once the “” is display on the LCD, press the AUDIO button again to cancel the erase mode.

- After pressing AUDIO button to start the ERASE, the present playing music file will stop and the erasing will start at the same time.
- **ERASE  ** Will display on the LCD after the music file erase is successful and the unit will automatically start playback of the next music file.

▲ WARNING:

- 1) Do not switching mode of the unit during the Erasing
- 2) Do not turn off the Power of the unit during the Erasing
- 3) Do not switch the Ignition key off during the Erasing
- 4) Do not detach the front panel during the Erasing

19. FILES MANAGER

The advance "File Management." System of this unit can help to well you organize all the music files just like a PC . Please read below for details:

FOLDERS MANAGEMENT

This unit will automatically self-create the below default folders onto any USB /SD / MMC media device, once these devices are inserted into the unit.

- MY_CD : Folder for saving all the music files source from CD Disc
- MY_MP3: Folder for saving all the MP3 music files transfer from other device
- MY_WMA: Folder for saving all the WMA music files transfer from other device
- MY_FM : Folder for saving all the music files source from FM Program
- MY_AUX : Folder for saving all the music files source from AUX Line In
- MY_iPod: Folder for saving all the music files source from iPod Player

FILES MANAGEMENT

This unit will automatically self-create the file name following with the Folder Name, for example:
Music file which recorded from CD disc, the file name 'CD0001.MP3' will be automatically created & saved in the respective folder.

20. iPod OPERATION

This unit is equipped with iPod Ready function which allow end user to have direct control of the iPod on the front panel control button and display iPod song information on the unit's LCD display. **Please** read below for more details operation

iPod Compatibility Chart

This unit is support following iPod software version

iPod 1G	Not Supported
iPod 2G	Not Supported
iPod 3G	Firmware Version 2.2
iPod Mini	All versions
iPod 4G	All versions
iPod Photo	All versions
iPod Nano	All versions
iPod 5G(Video)	All versions

Connect the iPod to this unit

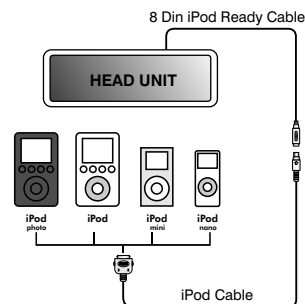

About Video File

This unit is **NOT ABLE** to select any VIDEO FILE OR VIDEO ALBUM which contained in the iPod Video. This unit will only automatically select Music Album or File regardless the connected Video iPod last playing is a Video File or Album.

Turning iPod Power On and Off

The iPod power turns on automatically as soon as it is connected to the 30 Pin Connector and as long as the vehicle's ignition is turned ON. The iPod power can be turned OFF by removing the iPod from the 30 Pin Connector or if the vehicle's ignition is turned OFF. Under this condition the iPod will go into pause mode and goes into sleep mode about 2 minutes later

NOTE While the iPod is connected, the power cannot be turned on or off from the iPod itself.

Tips “  ” to disconnect will be shown in the iPod's display while it is connected to the unit .

iPod Battery Charging

While connected to the unit, the iPod will automatically start re-charging as long as the vehicle's ignition key is turn to ACC or ON.

Switch to iPod Mode

When the Head unit is power on and iPod is connected to the 30 pin connector, press the mode button to change to iPod mode and the unit will display **iPod for a while then starts **Reading** the music files contained in the iPod and the playback will automatically start. Press Mode button repeatedly to change to other modes or switch back to iPod mode.**

iPod information Display on the Head Unit LCD

This unit can display the Song, Artist, Album name and Elapsed time on the LCD display, **this** information can be displayed by pressing the AS/PS button repeatedly while a iPod Song file is playing

Searching a Desire Song

Under iPod playback mode, press BAND to enter into the iPod Searching Mode. Pressing BAND button repeatedly to accesses the different searching methods as below :

- 1) **Playlist**
- 2) **Artist**
- 3) **Album**
- 4) **Song**
- 5) **Genre**

Once selected the desire searching method, within 10 second press the AUDIO button as confirm & access into the searching mode, then turn the rotate encode volume knob to navigate thru the Album or Artist or Song contained in the iPod. Press the AUDIO button to confirm & play the selected song. During the searching mode, press AS/PS as quick move back to the last upper level of Album, Playlist, Genre, etc.

Song Select

Press the Track UP (>>) or Track DOWN (<<) button for less than one second to skip to the next or previous song. Press and Hold Track UP (>>) or Track DOWN (<<) button for more than 3 seconds to fast forward or fast reverse of the current song.

Song Repeat / Repeat All play :

Long press the M3 button for more than 3 seconds during iPod playback mode for "REPEAT ALL". All songs of the current album will be kept on repeat playing until the "Repeat All" function is disabled. To disable current Album "REPEAT ALL" function, long press M3 button more than 3 seconds

Press the M3 button for less than 3 seconds to "REPEAT PLAY" the current song. And keep on repeat playing the current song until the "REPEAT PLAY" function is disabled. To disable current song "REPEAT PLAY", press the M3 button less than 3 seconds

Shuffle play: / Shuffle Album

Long press the M4 button for more than 3 seconds during iPod playback mode to activate the "SHUFFLE ALBUM" function. This function allows RANDOM playback of all the albums contained on the iPod. To disable "SHUFFLE ALBUM" function, long press M4 button for more than 3 seconds.

Press the M4 button for less than 3 seconds during iPod playback mode to activate "SHUFFLE PLAY". This function allows the playback of all the songs in the iPod in random sequence. To disable "SHUFFLE PLAY", short press M4 button again for less than 3 seconds.

21. REMOTE FUNCTION(RDS + iPod)

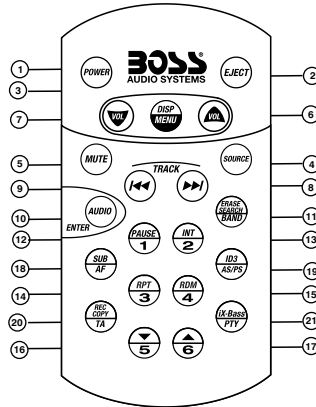

OPERATIONS:

KEY	SYSTEM		TUNER		CD/MP3/WMA		iPod	
	Short Press	Long Press	Short Press	Long Press	Short Press	Long Press	Short Press	Long Press
1	Power							
2	Panel Open & Close				Eject			
3	Display	Menu						
4	Mode							
5	Mute							
6	Volume Up							
7	Volume Down							
8			Seek Up	Tune Up	Track/File Up	Fast Forward	File Up	Fast Forward
9			Seek Down	Tune Down	Track/File Down	Fast Backward	File Down	Fast Backward
10	Audio Menu				Enter		Enter	
11			Band		File/Folder Search	File Erase	iPod Search	
12			M1	Memory 1	Pause /Play		Pause /Play	
13			M2	Memory 2	Intro	Folder Intro		
14			M3	Memory 3	Repeat	Folder Repeat	Repeat	Album Repeat
15			M4	Memory 4	Random	Folder Random	Shuffle	Album Shuffle
16			M5	Memory 5	Folder Down			
17			M6	Memory 6	Folder Up			
18		Sub-W	AF					
19			PS	AS	ID3		iPod information	
20		Record Copy	TA					
21		ix-Bass	PTY					

22. SPECIFICATIONS

CD PLAYER

System	Compact disc audio system
Usable disc	Compact disc
Sampling frequency	44.1KHz
No of quantization bits	1bit
Frequency	5-20,000Hz
Number of channels	2 stereo
S/N Ratio	70dB

MEDIA SECTION

USB Host

Host 1.1 compatibles 2.0

Memory Card

Support Type of Memory Card SD and MMC

RADIO SECTION

FM

Frequency Range	87.5-108 Mhz 87.5-107.9Mhz
Intermediate Frequency	10.7 MHz
Usable Sensitivity	Better than 15dB at S/N 30 dB
Stereo Separation	25 dB at 1KHz
S/N Ratio	50 dB

AM/MW

Frequency Range	522-1620 KHz 530-1720 KHz
Intermediate Frequency	450KHz
Usable Sensitivity	Better than 45dB
S/N Ratio	40 dB

GENERAL

Power Supply	DC 11 -14V
Polarity	Negative Ground
Speaker impedance	4 ohms
Power Output	4 x 80W

REMARK :

Specifications subject to change without notice.

23. TROUBLE SHOOTING

Before going through the check list, check wiring connection. If any of the problems persist after check list has been made, consult your nearest service dealer.

Symptom	Cause	Solution
No power	The car ignition is not on.	If the power supply is properly connected to the car accessory terminal, switch the ignition key to "ACC"
	The fuse is blown.	Replace the fuse.
Disc cannot be loaded or ejected	Presence of CD disc inside the player.	Remove the disc in the player, then put a new one.
	Inserting the disc in reverse direction.	Insert the compact disc with the label facing upward.
	Compact disc is extremely dirty or defective disc.	Clean the disc or try to play a new one.
	Temperature inside the car is too high.	Cool off or until the ambient temperature returns to normal.
	Condensation.	Leave the player to off for an hour or so, then try again.
No sound	Volume is in minimum.	Adjust volume to a desired level.
	Wiring is not properly connected.	Check wiring connection.
The operation keys do not work	The built-in microcomputer is not operating properly due to noise.	Press the RESET button. Front panel is not properly fixed into its place
Sound skips.	The installation angle is more than 30 degrees.	Adjust the installation angle to less than 30 degrees.
	The disc is extremely dirty or a defective disc.	Clean the compact disc or try to play a new one.
The radio does not work. The radio station automatic selection does not work.	The antenna cable is not connected.	Insert the antenna cable firmly.
	The signals are too weak.	Select a station manually.
ERROR 1	Mechanism Error	Press the reset button to correct the problem. If the error code does not disappear, consult your nearest service dealer.
Write Error	The Media Device not able to copy or record by the unit.	Replace the Media Device or Format the Flash Memory
Read Error	The Media Device not able to play file by the unit	Replace the Media Device or Format the Flash Memory
Memory Full	The media device memory is full not allow to copy	Replace the Media device or erase some un-usage files.
No File	No file Format supports for Playback on the disc or Media Device	Replace the disc or Media Device..
Disc Error	Maybe disc dirty / disc scratched /disc upside down.	Replace the disc.



If at any time in the future you should need to dispose of this product please note that Waste electrical products should not be disposed of with household waste. Please recycle where facilities exist. Check with your Local Authority or retailer for recycling advice.(Waste Electrical and Electronic Equipment Directive)

640UI

MP3- COMPATIBLE
IN-DASH CD RECEIVER WITH
FRONT PANEL USB PORT

12.2006

tech support: www.bossaudio.com/support

iPod is a trademark of Apple Computer, Inc.,
registered in the U.S. and other countries.



10 R - 02 0915

BOSS[®]

AUDIO SYSTEMS

BOSS Audio Systems • 3451 Lunar Court • Oxnard, CA 93030
www.bossaudio.com

800.999.1236