



BV7965

Contents

*In-Dash AM/FM
DVD/MP3/CD Receiver With
3.6" Widescreen Touchscreen TFT Monitor
With Front Panel USB Port*

| | |
|---|-----------|
| Notes on installation..... | 2 |
| Accessories..... | 2 |
| Precautions..... | 3 |
| Wiring diagram..... | 4 |
| Control panel layout..... | 5 |
| Basic operation..... | 6 |
| Radio operation..... | 8 |
| RDS operation..... | 9 |
| DVD, MPEG4, VCD, MP3,WMA, CD operation..... | 11 |
| Remote control layout..... | 13 |
| Remote control operation..... | 14 |
| Setup..... | 21 |
| A. System setup..... | 21 |
| B. Language setup..... | 22 |
| C. Audio setup..... | 23 |
| D. Video setup..... | 24 |
| E. Digital setup..... | 25 |
| Installing the front panel..... | 26 |
| Detaching the front pane..... | 26 |
| Removing the front panel..... | 26 |
| Cleaning the connector..... | 26 |
| Unit installation..... | 27 |
| Specificaton..... | 28 |

NOTES ON INSTALLATION

NOTES ON INSTALLATION





- The unit is designed for 12V DC, negative ground operation system only. Before installing the unit, make sure your vehicle is connected to 12V DC negative grounded electrical system.
- The negative battery terminal must be disconnected before making connections, Incorrect can reduce damaging to the unit due to short circuit.
- Be sure to connect the color coded leads correctly according to the diagram. Incorrect connections may cause the unit malfunction or damage the vehicle's electrical system.
- Be sure to connect the speaker(-) leads to the speaker(-)terminal. Never connect the left and right channel speaker cables each other or to the vehicle body. Do not block vents or radiator panels. Blocking them will cause heat to build up inside and may result in fire.
- After the completion of the installation and begin to operate the unit (including replacing the battery), please press the RESET button on the front panel with pointed objects(such as ball pen)to set the unit to initial status.

ACCESSORIES

- | | |
|---------------------------|-------------------|
| ■ WIRELESS REMOTE CONTROL | ■ MOUNTING SLEEVE |
| ■ OWNER'S MANUAL | ■ USB CABLE |
| ■ A/V INPUT CABLE | ■ SPEAKER CABLE |
| ■ NUT (5MM) | ■ SPRING WASHER |
| ■ SCREW (5 X 25MM) | ■ SCREW |
| ■ STRAP | ■ LEVER |
| ■ RADIO REMOVAL KEYS | ■ WIRING HARNESS |

PRECAUTIONS

THIS UNIT CAN PLAY THE FOLLOW DISC ONLY

| TYPE OF DISC | LABEL ON THE DISC | RECORDED MATERIAL | SIZE OF DISC |
|--------------|---|---------------------------|--------------|
| MPEG4/DIVX |  | Sound and moving pictures | 12CM |
| DVD |  | Sound and moving pictures | 12CM |
| VCD |  | Sound and moving pictures | 12CM |
| MP3/WMA | MP3 WMA | Sound only | 12CM |
| CD |  | Sound only | 12CM |

NOTE: The unit is compact ible with DVD, DVD+/-R,VCD 1.0/2.0/3.0,SVCD,CD,CD-R,CD-RW and JPEG

- DO NOT ATTEMPT TO MODIFY THE UNIT, MODIFYING THE UNIT MAY CAUSE AN ACCIDENT.
- STOP THE VEHICLE BEFORE CARRYING OUT ANY OPERATION THAT COULD INTERFERE WITH YOUR DRIVING.
- DO NOT TURN ON THE UNIT IF THE TEMPERATURE INSIDE THE VEHICLE IS OUT OF -20°C TO 60°C.
- THIS PRODUCT IS DESIGNED FOR ONE SINGLE VIDEO OUTPUT, PLEASE USE A SPLITTER IF YOU WOULD LIKE TO CONNECT FOR MULTIPLE VIDEO OUTPUT.
- TO ENJOY OPTIMUM SOUND AND VISION WHILE PLAYING, HANDLE THE DISC. AS FOLLOWS:
 - Handle the disc by its edge to keep the disc clean, and do not touch the surface.
 - Do not use your CDs with paste residue or ink attached.
 - Do not use CDs with labels or stickers attached, which may leave a sticky residue while beginning to peel off.
 - Clean the discs with an optional cleaning cloth. Wipe each disc from center out.



WIRING DIAGRAM

WIRE CONNECTION

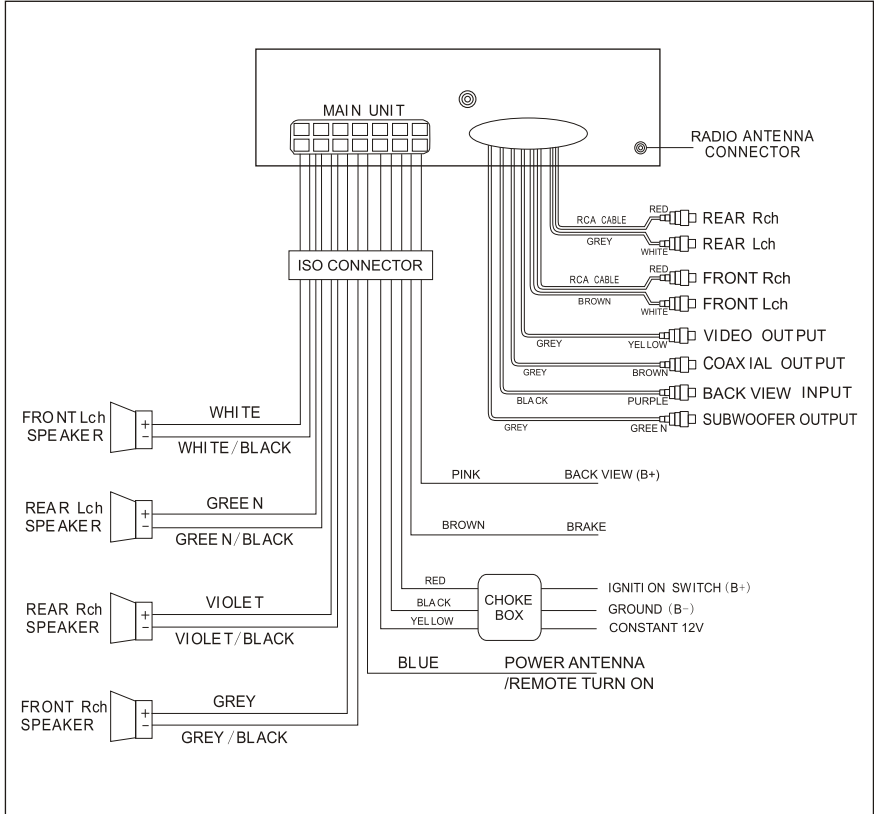

⚠ WARNING

BRAKE WIRE MUST BE CONNECTED TO THE (-) SIDE OF THE PARKING BRAKE SYSTEM. IF YOU DO NOT HOOK THIS WIRE UP, YOU WILL GET A WARNING ON THE SCREEN THAT YOU WILL NOT BE ABLE TO WATCH THE VIDEO WHILE THE CAR IS MOVING. YOU WILL BE ABLE TO HEAR THE MOVIE BUT YOU WILL NOT BE ABLE TO WATCH IT UNLESS YOU HOOK UP THE BRAKE WIRE. THEN YOU HAVE TO ENGAGE THE PARKING BRAKE SYSTEM TO WATCH IT.

CONTROL PANEL LAYOUT

FRONT PANEL LAYOUT

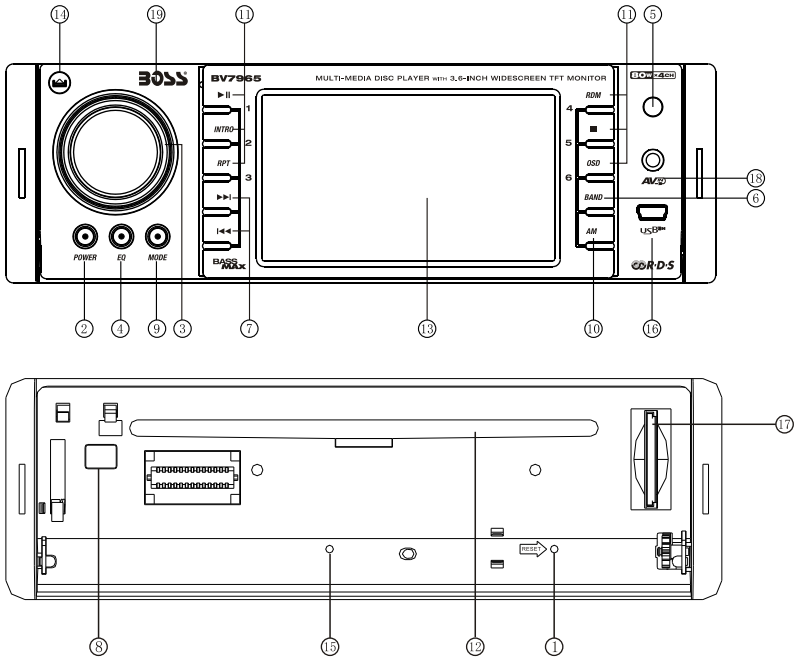

- | | |
|---------------------------------|-------------------------------|
| 1. Reset Button | 11. Number Button |
| 2. Power Button | 12. DISC Slot |
| 3. Volume/ Sel Button | 13. TFT Display |
| 4. Preset EQ Button | 14. Release Button |
| 5. Remote Control Sensor | 15. Flashing LED |
| 6. Band Button | 16. Mini USB connector |
| 7. Tuning/Selcting Tracks/FW/RW | 17. SD/MMC Slot |
| 8. Eject Button | 18. A/V in |
| 9. Mode Button | 19. SEL/Programme Type Button |
| 10. Preset Stations/AMS | |

BASIC OPERATION

INITIAL SYSTEM STARTS-UP

Operating the unit for the first time or after replacing the car battery, you should press (14) to detach the front panel, and LED (15) will be blinking. Press(1) Reset button with a pointed object(such as a ballpoint)to set the unit to initial procedure.

NOTE: WHEN SOME ERRORS OCCUR IN THE LCD DISPLAY, YOU CAN ALSO PRESS RESET BUTTON TO RESUME TO NORMAL. AND IT WILL ERASE THE CLOCK SETTING AND SOME MEMORIZED FUNCTIONS.

TURNING THE UNIT ON/OFF

Press the POWER button will turn the radio on. Pressing for shortly will shut it off.

VOLUME SELECTOR

For Volume button(3),press “VOL+” to increase the sound level and press “VOL-” to decrease the sound level.

BASS/TREBLE/BAL(L-R)/FADE SELECTOR

Press “SEL” button once to enter “AUDIO SETUP” menu.

Press “◀◀” or “▶▶” button to select you desired mode. You can adjust the current level by press “VOL+” or “VOL-” knob.

AUDIO SETUP

| | |
|---------|------|
| BASS | +2 |
| TREBLE | +2 |
| BALANCE | 0 |
| FADER | 0 |
| EQ | FLAT |
| LOUD | OFF |

NOTE: IF YOU DON'T ADJUST THE KNOB WITHIN 5 SECONDS AFTER SELECTING THE DESIRED, THE UNIT WILL AUTOMATICALLY RETURN TO THE CURRENT MODE BEING DISPLAYED.

MUTE FUNCTION

Press EQ button more than 1 second is mute function.Press this button to cut down the sound output and “MUTE” appear on the LCD.Press it again to revert the previous volume level.

BASIC OPERATION

SETTING EQ

While listening music, you can set up rock music, popular, classic music or jazz pre-EQ by pressing(4)"EQ" button the procedure as follows:

- POP mode is selected when the button is first press and rock indicated on LCD.
- POP mode is selected when press the button for the second time and class indicated on LCD.
- Classic mode is selected when press the button for the third time and rock indicated on LCD.
- Press the button for the forth time to Select the JAZZ Pre-EQ mode, press the button fifth times to turn off the P-EQ system→ Press EQ button more than 1 second is "MUTE" function.

NOTE: BASS MODE AND TREBLE RETURN TO INITIAL SETTINGS WHEN EQ SYSTEM IS ON, "BASS" AND "TREBLE" DISAPPEAR.

MODE SELECTOR

Press "MOD" button to select Radio → DVD → AUX mode.

SENSOR

(5)Receptor for the card remote commander.

ADJUST TIME

- Press "SEL" button to enter "SYSTEM SETUP".
- Press VOL+/- button select "DISP ON" mode.
- When the clock appear on the menu, Press "VOL+" or "VOL-" to adjust hours or minutes.

| SYSTEM SETUP | |
|--------------|---------|
| DISP | ON |
| CLOCK | 00:00 |
| DEFAULT | RESTORE |

RADIO OPERATION

BAND SELECTOR

press (6)(band)button repeatedly to select band in the following order:

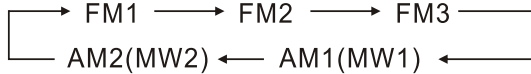

NOTE: ON DVD PLAYING MODE, PRESS (6) BUTTON TO SWITCH TO AUTO PAL OR NTSC SYSTEM

MANUAL/AUTOMATIC TUNING

1. Pressing AMS button shortly, the radio searches station from the lowest frequency to highest frequency. When a station strength level is more than the threshold level of the stop level. The radio will holding the station for 5 seconds and the station frequency blinking on the LCD at the same time. Pressing AMS button once again. The radio search will stop on the station. Pressing anyone preset number button for several seconds. The radio will save the station at the preset number button.

2. Pressing and holding AMS button more then 3 seconds. The radio searches from the lowest frequency and check the signal strength. When the field strength level is more than threshold level of the stop level. The radio storing the station at the preset number (is can store 3x6 stations for FM and 2x6 stations for AM in all) after finishing a circle of search. It will stop searching on the M1.

NUMBER BUTTONS

Number buttons can help you store your favorite station by pressing any one of the number button. You can follow the steps as bellow:

Press and hold any number button(1~6) until "CH" appears in the LCD display when receiving a station. And now the station is already stored in the corresponding number button.

18FM STATIONS AND 12 AM STATIONS CAN BE STORED

NOTE: Number button 1,2,3,4,5,6 have dual function, While radio mode, it use to store and recall preset stations, While DVD, VCD, CD, MP3 and WMA playing mode, they have other function.

For detail. Please refer to corresponding playing operation.

RDS OPERATION

RDS(RADIO DATA SYSTEM)OPERATION

TA:

Operated as follows:

-TA is turned ON/OFF and TA indicator is displayed.

When traffic announcement is transmitted, regardless of the mode, traffic announcement is received.

If VOLUME LEVEL is below 24, VOLUME LEVEL is raised to 24, and returns to its previous mode and volume level when the traffic announcement is over. If volume is adjusted during traffic announcement, only the previous volume is valid.

-When TA is on, SEEK, SCAN, AUTO MEMORY function can be received or saved only when traffic program identification code has been received.

-When TA is ON, traffic program identification code is not received during specified time.

TA SEEK: TA SEEK is activated.

PTY RADIO MODE

Press "SEL" Button more than 1 second is PTY function.

-Previous PTY is displayed when PTY key(19) is pressed. If there are no keys entered for

2seconds, previously selected PTY is searched. During 1LOOP, if desired PTY is not found, NO PTY is displayed.

-2 program types are SPEECH and MUSIC.

Rotate VOL knob clockwise or anti-clockwise to select the desired program type.

AF: Alternative Frequencies

- Setting RDS Mode Press AF button(9) and release immediately to switch on or off RDS mode. Whenever RDS is switched on, symbol "AF" appears on the display.

NOTE: TURN ON/OFF TA OR PTY MODE MUST PRESS THE BUTTON "TA" OR BUTTON "PTY" ON THE REMOTE CONTROLLER.

RDS OPERATION

AF/REG

AF

- AF/REG key directs the activation of AF SEARCH.
- AF indicator is displayed when AF is ON, AF search is activated when reception is had.
- During FM MODE, when AF is ON, SEEK, SCAN, AUTO, MEMORY function can only receive and save RDS program. However, when italy option is in use, regardless of RDS, programs that satisfy SD LEVEL Can be received and saved.

| INDICATOR | CONDITIONS |
|-------------|--|
| AF ON | AF ON MODE, RDS information is received. |
| AF OFF | AF OFF MODE |
| AF FLASHING | AF ON MODE, RDS information is not received. |

REGION

- AF MOD E is converted to REGION ON/OFF MODE when AF ON MODE is pressed for longer 1sec.
- ON: P1 CODE is checked when AF CHECK in progress
- OFF: P1 CODE and COVERAGEARE A is not checked when AF CHECK in progress.

DVD, MPEG4, VCD, MP3, WMA, CD OPERATION

DVD, MPEG4, VCD, MP3, WMA, CD OPERATION

While listening to (or watching) DVD, MPEG4, DIVX, VCD, MP3, WMA and CD, just insert a Disc (with labeled side up) into the disc slot(12), the mechanism will automatically switch on. While it is Radio /AUX mode and a Disc was loaded, press(9) MOD button to play the Disc.

If a ID3 disc is playing. The songs name, artist name and file name will shufft show on LCD.

SELECTING TRACKS/ FW./RW

Press (7) to choose your favorite track upward or downward respectively. Press and hold(7) button to fast forward or rewind the track upward or downward respectively.

PLAYING TRACKS REPEATLY

Press (11)"3RPT"button to perform repeat playing function when you need to repeat playing the track you like.

Press "3RPT" button for the first time, it will repeat playing the same track for CD, VCD, MP3 and WMA, same chapter for DVD mode. "RPT" appears. Press "3RPT" button for the second time, entire Disc will be playing repeatedly for VCD and CD playing. entire TiTle will be playing repeatedly for DVD playing, the entire directory for MP3 and WMA playing " RPT" appears on the LCD display.

Press "3RPT" button for the third time to stop repeat mode for CD, VCD and DVD playing mode, repeat entire disc for MP3 and WMA playing mode.

Press "3RPT" button for the forth, time to stop repeat mode for MP3 and WMA playing mode.

SCANNING TRACK AUTOMATICALLY

During CD playback, press "2INT" button, to play the first 10 seconds of each track on the disc,

the display will show " INT", track number and elapsed time.

Which indicates INT function is already activated.

Press "2INT"button once again to return to normal playback.

NOTE: INT DOESN'T WORK DURING PLAYING DVD/MP3/WMA

DVD, MPEG4, VCD, MP3,WMA, CD OPERATION

PLAYING TRACKS IN RANDOM ORDER

During playback, press "4RDM" button, and "RDM" appears on the display, which indicates RDM function is carried out. The unit plays any track at random. Press RDM once again to return to normal playback mode.

STOP PLAYING

During playback, press (11) "5STOP" button to stop the playback, LCD will show "STOP". To return to normal play mode, press 1 ► button again.

PAUSE THE PLAYBACK

During playback, press (11) "1PLAY" button to suspend the playback, on the LCD display and show "PAUSE" To return to normal play mode, press it again, to resume play.

EJECT A DISC

During Eject button(8) to eject disc, "OPEN" will appear on LCD display.

VIDEO SET UP

While you watching DVD or receiver TV program you can enter "VIDEO SETUP" to adjust the picture quality.

IF the picture appear to disorder when you adjustment. Please come into the "SYSTEM SETUP" select the "DEFAULT" menu, then press the knob of VOL +/- to confirm the value of factory recognize tacitly.

VIDEO SETUP

| | |
|-----------|----|
| BRIGHTNE | 33 |
| CONTRAST | 33 |
| SHARPNESS | 2 |
| COLOR | 30 |
| HUE | 30 |

REAR VIEW CAMERA SET UP

Put the unit back view control view connect to power 14.4 V negative grounded electrical system. Connect car back view camera output to the "BACK VIEW VIDEO" input. When you backward your car. The back view picture will automatically turn to the front screen.

REMOTE CONTROL LAYOUT

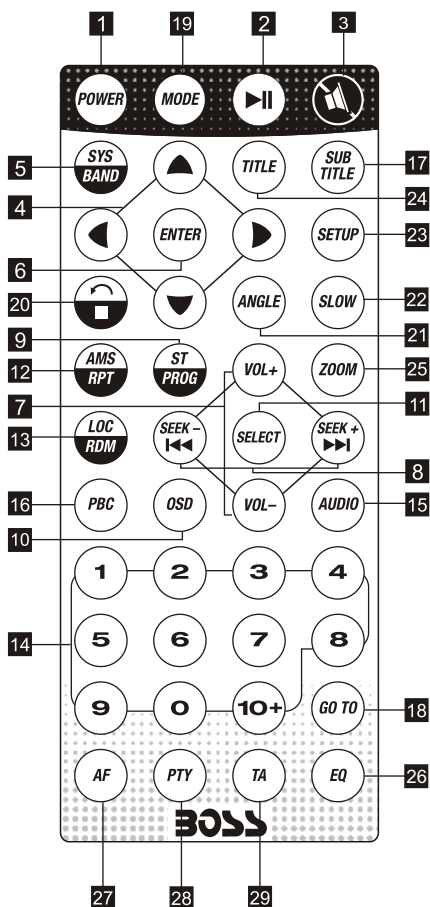

- 1 POWER BUTTON
- 2 PAUSE/PLAY BUTTON1
- 3 MUTE BUTTON
- 4 SELECTING MENU BUTTON
- 5 BAND/SYSTEM SWITCH
- 6 ENTER BUTTON
- 7 VOLUME CONTROL
- 8 TUNING/SELECTING/FW/RW
- 9 PROGRAM PLAYING
- 10 ON-SCREEN DISPLAY
- 11 SETTING THE SOUND
- 12 REPEAT PLAYING
- 13 RANDOM PLAYING
- 14 NUMBER BUTTON
- 15 AUDIO SETTING
- 16 PBC MENU
- 17 SUBTITLE SETTING
- 18 PLAYING TIME SETTING
- 19 MODE SWITCH
- 20 STOP BUTTON
- 21 ANGLE SETTING
- 22 SLOW MOTION PLAY
- 23 SETUP MENU
- 24 MENU DISPLAY
- 25 ZOOM SETTING
- 26 EQ Button
- 27 Alternative Frequencies Button
- 28 Program Type Button
- 29 Traffic Announcement Button

REMOTE CONTROL OPERATION

REPLACING THE BATTERY

When the operational range of the remote control becomes short or non functions while operating. Replace a new CR2025 battery. Make sure the battery polarity before replacement.

1. Pull out Battery Holder while pressing The stopper

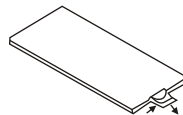

2. Put the button type battery(+) mark upward into the Battery Holder.

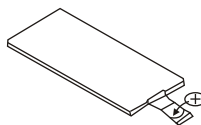

3. Insert the Battery Holder into the Remote control.

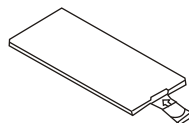

POWER BUTTON

Press (1)  button to turn power On/Off.





PAUSE/PLAY BUTTON

Press (2)  button to suspend the playback of CD, MP3, WMA, VCD and DVD, Press it again to return to normal palyback mode.

MUTE BUTTON

Press (3)  button to cut down the sound output, press it again to resume the previous sound level.

MENU SELECTOR

Press (4)  /  /  /  to select your desired menu, then press(6)(ENTER) or play button (2)  to confirm.

NOTE: This function works in main menu mode only, refer to page 12.

BAND/SYSTEM SWITCH

During radio mode, Press (5) (BAND/SYS) to switch receiving band. During the player mode, press (5)(BAND/SYS) button to switch to AUTO, PAL OR NTSC system.

REMOTE CONTROL OPERATION

VOLUME INCREASING/DECREASING

Press(7) (VOL+ or VOL-) button to increase or decrease the volume level respectively.

TUNING/SELECTING TRACKS/FAST FORWARD/REWIND

During radio mode, continuously press(8) button to manual search a station downward or upward respectively; if press and hold the button for more than 3seconds. The radio will automatically search a station downward of upward respectively until it finds a station.

During the playing mode, press the (8) button to rewind or forward for you to reach your desired track quickly. When discontinuously press (8) button, you can select your desired portion downward or upward or upward respectively.

if press and hold the button for more than 3seconds, you can select you desired portion fast forward/rewind.

PROGRAM PLAYING/ST

During Disc playing mode, press(9) PROG button to enter programming page.

Press(4) button and (14) numbers button to program the tracks to be played.

NOTE: ST WILL ONLY WORK ON RADIO MODE.

ON-SCREEN DISPLAY

During DVD, VCD, and CD mode, press(10) (OSD) button. The displayer shows Track/Chapter, Current Time.

NOTE: DURING MP3/WMA MODE, ONLY SHOW DIRECTORY AND TRACKS.

REMOTE CONTROL OPERATION

VOL/BAS/TRE/BAL/FAD SELECTOR

During DVD, VCD, and CD mode, Repeat press(11)(SEL) button to select the desired mode in the following order:

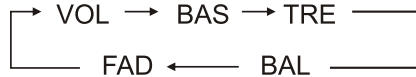

NOTE: AFTER SELECTING YOUR DESIRED MODE, YOUR CAN ADJUST THE CURRENT MODE BEING DISPLAYED BY(VOL) BUTTON. WHEN P-EQ MODE ISACTIVATED, PRESS SEL BUTTON TO SELECT THE MODES, AND BASS/TREBLE MODE ARE INVALID.(SHOW AS BELOW)



REPEAT PLAYING/ AMS

1.press AMS button(12),

In CD/MP3/VCD mode, repeat function is: RPT1 , RPT DIR, RPT ALL, RPT OFF.

In DVD mode, repeat function is: PRT CHAPTER, PRT TITLE.

2.Radio mode is AMS function.

RANDOM PLAYING

During the Disc playing mode, press(13)(RDM) button to play any track at random.

During the RADIO mode, press the button is LOCAL function.

NOTE: IN VCD PCB MODE AND SOME DVD DISCS, RANDOM PLAYING WILL BE WORK.

REMOTE CONTROL OPERATION

NUMBER BUTTONS

During radio mode, you can select one of the 6 stored stations on each band by pressing any one of the number button(14). During the playing mode, you can select any track directly by using number button(14)(0~10+). For example, if you need the fifteenth track, you can first press button 10+ and press button 5, the corresponding track(15) will be played.

NOTE: WHEN BUTTON 10+ IS FIRST PRESSED. IT WORKS AS 10+, IT WORKS AS 20+ WHEN PRESSED AT THE SECOND TIME, THE THIRD TIME...30+...AND SO ON.

LEFT/RIGHT/STEREO SELECTOR

During the playing mode, continuously press(15) (Audio) can change the sound to left/right speaker or stereo mode.

PBC(MENU)

-During VCD/2.0 mode, when press(16)(PBC) button at the first time, PBC playback starts and the menu of entire disc appears on the TV. And then you can select your favorite track by using number button (14~10+). To cancel PBC playing, press (16)(PBC) button again.

-During DVD mode, when press (16)(PBC) button, to show all tracks'title on TV screen.

SUBTITLE SELECTOR

During DVD mode, press(SUB-T)(17) button to switch the subtitle language.

SETTING DISC PLAYBACK TIME

During Disc playing mode, press(18)GOTO button can set the specific time to play. Using(4) and (14)number button to set track/Chapter or time, and press ENTER button to play.

MODE SWITCH

Press (19) button to switch Radio, Disc Playing USB/SD/MMC or AUX mode.

REMOTE CONTROL OPERATION

STOP THE PLAYBACK

In Disc playing mode, press (20) button to suspend the playback, press it again to stop the playback.

MULTI-ANGLE KEY

In DVD playing mode, press(21) key, you can watch the DVD content from different angle. If the disc supports.

SLOW REVERSE/SLOW ADVANCE PLAY

During DVD/VCD playing mode, press(22) key once for 1/2 slow advance, twice for 1/3, third for 1/4, fourth 1/5, fifth for 1/6, sixth 1/7, seventh return to normal playback speed.

Title Key

In DVD playing mode, press(24) key to show all tracks'title on TV screen. Then press (14)(0~10+)key or press (4) key to choose your desired track number and press (18) (ENTER)key or (2) key to start.

NOTE: NO TITLE DISPLAY IN MP3, WMA, CD MODE.

ZOOM KEY

In DVD/VCD playing mode, press(25) key once for 2 x zoom, twice for 3 x zoom, third time for 4 x zoom, fourth time for 1/2 zoom, fifth time for 1/3 x zoom, sixth time for 1/4 x zoom, seventh time to cancel the zoom mode. And you can pan the picture by pressing the cursor keys.

NOTE: NO ZOOM FUNCTION FOR MP3, WMA, CD PLAYING MODE.

REMOTE CONTROL OPERATION

SETUP

- 1.Press SETUP (23) key of remote control in the stop mode.(Press the STOP button twice to ensure the player is under STOP mode.
- 2.The main page of setup menu is displayed.
- 3.Select the preferred item by using the (4)button
- 4.Press (6) ENTER button

A. System Setup

This setup page includes all the items of TV system, Screen saver ,TV type, Password, Rating & Default features. The detail please refer to SYSTEM SETUP MENU.

B. Language Setup

This setup page includes all the items of OSD Language, Audio Language, Subtitle Language and Menu Language features. The detail please refer to LANGUAGE SETUP MENU.

C. Audio Setup

This setup page includes all the items for AUDIO. Please to AUDIO SETUP MENU.

D. Video Setup

This setup page includes all the items for VIDEO. The details please refer to VIDEO SETUP MENU.

E. Digital setup

EQ BUTTON

Press (26) button to select PRE-EQ:
ROCK → POP → JAZZ → FLATE mode

REMOTE CONTROL OPERATION

MIXED FILE FORMAT DISC

While you listen to (or watching) mixed file format disc, which is together with MP3, WMA, JPG or MPEG4 formats, just insert the disc into the disc slot, the mechanism will automatically switch on. For details, please refer to the following steps:

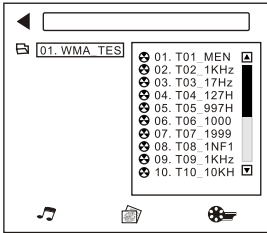

Playing Music Files

In the right menu, please move the arrow \uparrow or \downarrow on your favorite track then press ENTER button or directly press NUMBER BUTTONS to make the selection.

NOTE: If you press the right key, you will enter the status of selecting playing music, picture or video format files. Move the left/right key on your desired file and press ENTER button to play. If you press the left key, you will return to directory. Continue pressing the left key, you can also enter the referred status just now.

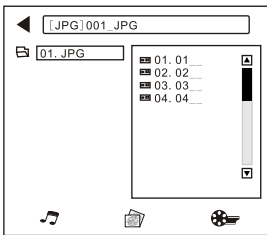

Playing Picture Files

You can press NUMBER BUTTONS directly to select your favourite picture files or move the arrow \uparrow or \downarrow on that file and press ENTER button. Then the picture will be displayed on the monitor. By pressing \uparrow , \downarrow , \rightarrow , \leftarrow , you can adjust to different angle to enjoy your picture. Press STOP button to return to last status.

NOTE: If you continue pressing right key, you will enter the status of selecting playing music, picture or video files. Move the left/right key on your desired and press ENTER button. Press the play button to playing picture automatic.

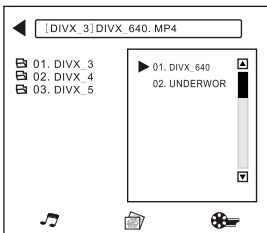

Playing Video Files

You can move the arrow \uparrow or \downarrow on the video file that you would like to watch, then press ENTER button or play button to confirm. Or press the left key to return to directory to choose another files at other directory.

Press play button to playing picture .

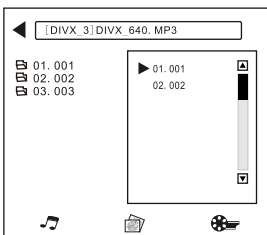

TRACK SEARCH MODE

In MP3/WMA mode:

- in one file, press button(8) select the track.
- In several files, press(\leftarrow) button to select list, and press(\rightarrow) button to select number of you desire song. Then press ENTER to play the song.

SETUP

A. SYSTEM SETUP

1. TV System

This player can play discs recorded in either PAL or NTSC format. Select NTSC format when you connected to NTSC TV. Select PAL format when you connected to PAL TV. If you select AUTO, the unit will auto select the format (PAL/NTSC) according to your TV system.

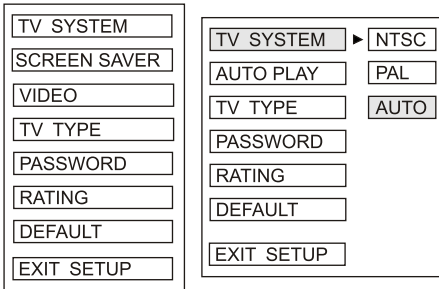

2. Screen Saver

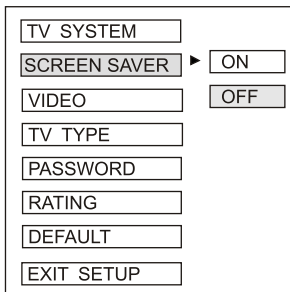

3. VIDEO

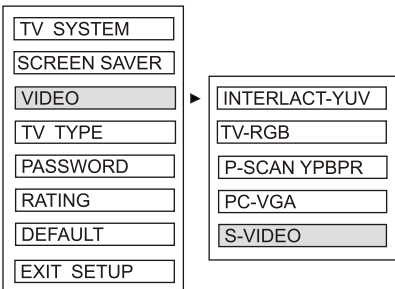

4. TV Type

Enter the password and press ENTER button. Type the old password (The instal factory code is 0000) and key in 4 characters password now you want to use, and type again to confirm.

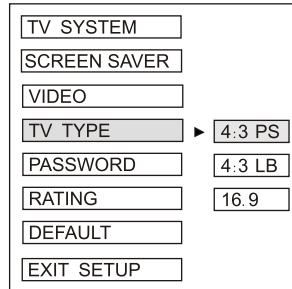

5. Password

1) 4:3 PS

Played back in the PAN & SCAN style (If connected to wide scen TV, the left and right edges are cut off).

2) 4:3 LB

Played back in LETTERBOX style. (If connected to wide screen TV, black bands appear at top and button of the screen.

3) 16:9

Select when a wide screen TV set is connected.

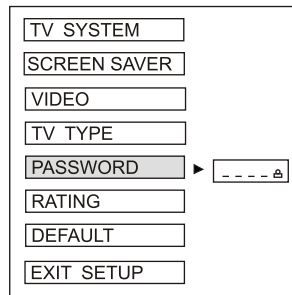

SETUP

6. RATING

Select suitable guidance rating by the cursor button and confirmed by pressing ENTER button.

Rating 1: [Kid Safe]

Select this when the programs are safe to all kid view.

Rating 2: [G]

Select this that allows admission to person of all ages.

Rating 3[PG]

Select this that needs parental guiding their children.

Rating 4[PG13]

Select following when children under 13 are forbidden to view.

Rating 5[PG-R]

Select this when the "PG-R" was printed on the DVD disc.

Rating 6 [R]

Select this when children under 17 must be guide to view by their parents.

Rating 7[NC-17]

Select this when children under 17 are orbidden to view

Rating 8[Adult]

Select this, when only allows admission to all adults.

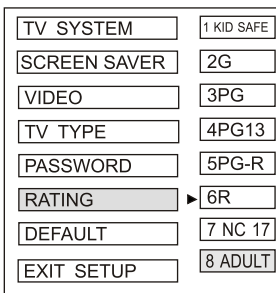

7. Default

Recover acquiescing in state when leaving the factory.

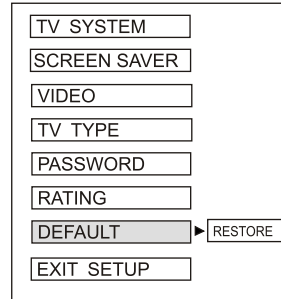

B. LANGUAGE SETUP

Select the preferred OSD Language, Audio Language, Subtitle Language and Menu Language by using the cursor buttons.

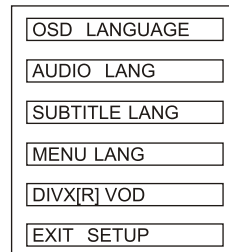

1. OSD Language

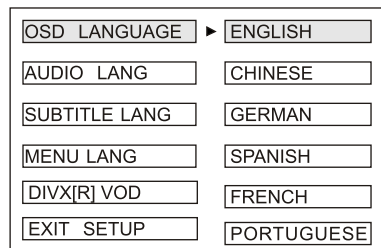

SETUP

2. AUDIO Language

| | |
|---------------|------------|
| OSD LANGUAGE | CHINESE |
| AUDIO LANG | ENGLISH |
| SUBTITLE LANG | JAPAN |
| MENU LANG | FRENCH |
| DIVX[R] VOD | SPANISH |
| EXIT SETUP | PORTUGUESE |
| | LATIN |
| | GERMAN |

5. DIVX[R] VOD Language

| | |
|---------------|---------------|
| OSD LANGUAGE | |
| AUDIO LANG | |
| SUBTITLE LANG | |
| MENU LANG | |
| DIVX[R] VOD | REGISTER CODE |
| EXIT SETUP | |

3. SUBTITLE Language

| | |
|---------------|------------|
| OSD LANGUAGE | CHINESE |
| AUDIO LANG | ENGLISH |
| SUBTITLE LANG | JAPAN |
| MENU LANG | FRENCH |
| DIVX[R] VOD | SPANISH |
| EXIT SETUP | PORTUGUESE |
| | GERMAN |
| | OFF |

C. AUDIO SETUP

SPDIF/OFF

Analog or optical output port all has not output signal.

| |
|------------|
| AUDIO OUT |
| KEY |
| EXIT SETUP |

4. MENU Language

| | |
|---------------|------------|
| OSD LANGUAGE | CHINESE |
| AUDIO LANG | ENGLISH |
| SUBTITLE LANG | JAPAN |
| MENU LANG | FRENCH |
| DIVX[R] VOD | SPANISH |
| EXIT SETUP | PORTUGUESE |
| | GERMAN |
| | LATIN |

a. Audio Out

This is to activate the audio output from ANAL OG/OPTICAL mode to SPDIF/ RAW mode or SPDIF/PCM mode.

| | |
|------------|-----------|
| AUDIO OUT | SPDIF/OFF |
| KEY | SPDIF/RAW |
| EXIT SETUP | SPDIF/PCM |

SETUP

SPDIF/RAW:

When the player is connected with the power amplifier by the analog or optical port, please select this item; when the playing disc which is recorded by Dolby Digital, DTS or MPEG recoding system, the analog or optical output signal of the unit will be the same as the digital signal (RAW format) of the playing disc. At the same time, the power amplifier you connected must have the decode function of Dolby Digital, DTS or MPEG.

SPDIF/PCM:

When the player is connected with the 2 channel, digital stereo amplifier, please select this item; when the playing disc which is recorded by Dolby Digital or MPEG recording system, the analog or optical output will be modulated to 2 channel output by PCM.

D. VIDEO SETUP

This is for the user to set Brightness Contrast, Hue and Saturation of the picture by pressing the arrow left/right button.

Press Enter button to confirm the change.

NOTE: ONLY ON TV/AV MODE, THE VIDEO SETUP IS AVAILABLE.

b. key

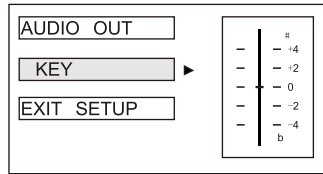

2. Contrast

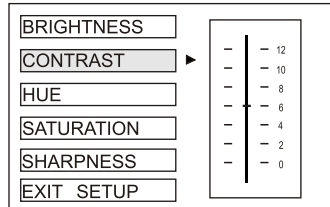

3. Hue

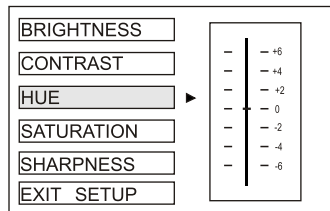

1. Brightness

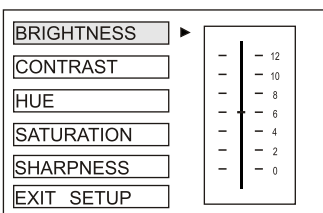

4. Saturation

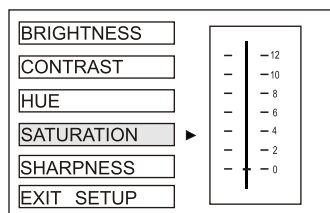

SETUP

5. Sharpness

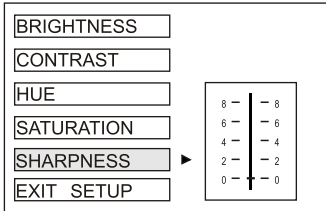

E. DIGITAL SETUP

This is for the user to set operation mode, dynamic range compression and stereo mode.

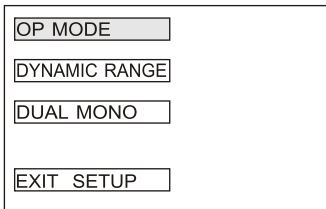

2. Dynamic Range

To set the dynamic range compression.

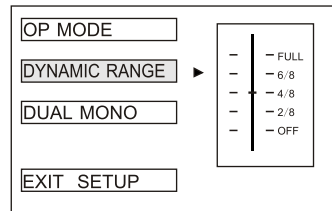

1. OP Mode

To set the operating modes for Doby Digital decoder.

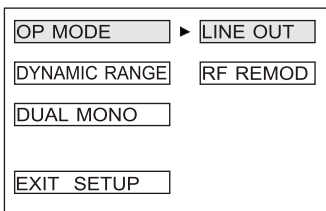

3. Dual Mono

To set the stereo mode.

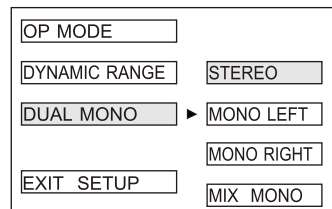

INSTALLING THE FRONT PANEL

To install the front panel, insert the panel into the housing and make sure the panel is properly installed, otherwise, abnormalities occur on the display or some keys will not function properly.

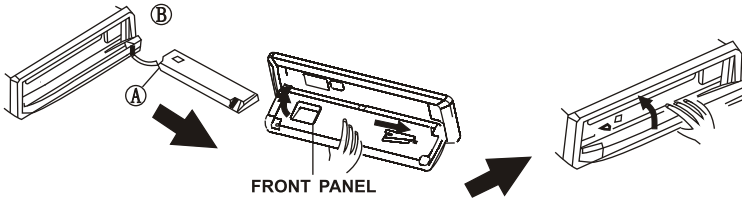

DETACHING THE FRONT PANEL

Press REL button in the upper left corner, and then front panel will not function properly.

REMOVING THE FRONT PANEL

When the front panel was turned down to a position of 90°, hold and slide the front panel to left, and then pull it out.

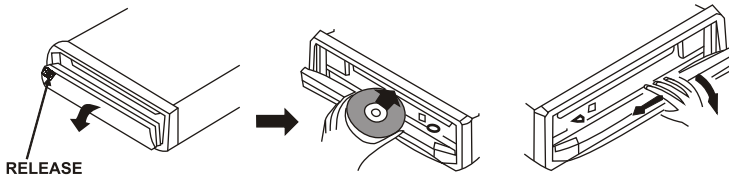

CLEANING THE CONNECTOR

If the connector between the main unit and the front panel is dirty, it may result in abnormal working conditions. To avoid such a problem happening, please detach the front panel, and clean the connector with an alcohol swab. Gently clean and avoid damaging the connector.



NOTE: ALWAYS SHUT THE CAR OFF WHEN YOU WANT TO CLEAN THESE TABS.

UNIT INSTALLATION

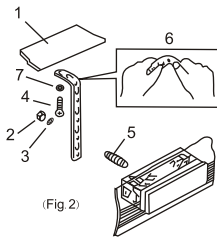

1. Dashboard
 2. Nut (5mm)
 3. Spring Washer
 4. Screw (5 x 25mm)
 5. Screw
 6. Strap
- Be sure to use the strap to secure the back of the unit in place. The strap can be bent by hand to the desired angle.
7. Plain Washer

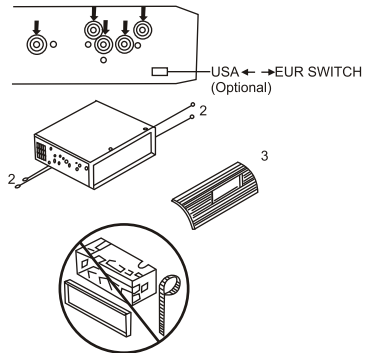

Fastening the unit to the factory radio mounting bracket:

1. Select a position where the screw holes of the bracket and the screw holes of the main unit become aligned (are fitted), and tighten the screws at 2 places on each side. Use either truss screws (5 x 5mm) or flush surface screws (4 x 5mm)
2. Screw
3. Dashboard or Console

Removing the unit

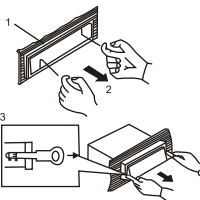

1. Frame
 2. Insert fingers into the groove in the front of frame and pull out to remove the frame. (When reattaching the frame, point the side with a groove downwards and attach it.)
 3. Lever
- Insert the levers supplied with the unit into the grooves at both sides of the unit as shown in figure until they click. Pulling the levers makes possible to remove the unit from the dashboard.

DIN REAR-MOUNT (Method B)

Installation using the screw holes on the sides of the unit.

NOTE: The mounting box, outer trim ring, and half-sleeve are not used for method B installation.

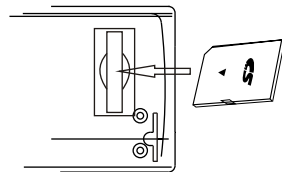

INPUT THE SD CARD

The SD angle should be on top to slide into this unit. Push it inside the slot to make it work and then press it again to have it eject.

SPECIFICATON

GENERAL

| | |
|----------------------------|---------------------------|
| Power Supply Requirements: | DC 14.4V, Negative Ground |
| Load Impedance: | 4 ohms |
| Maximum Output Power: | 80W x 4(CH) |
| Chassis Dimensions: | 178x163x50mm(WxDxH) |

DVD DECK SECTION

| | |
|-----------------|--|
| Discs Played: | DVD, MPEG4, DIVX, VCD 1.0/2.0/3.0, MP3 WMA, CD, CD-R, CD-RW, Picture-CD |
| Video system: | AUTO/PAL/NTSC |
| Mounting Angle: | 0° ~ 30° |

VIDEO SECTION

| | |
|---------------------|------------------------------------|
| Video System: | 4:3 Letter Box, 4:3 Pan Scan, 16:9 |
| Video Output Level: | 1.0V p-p 75 ohms |

TFT SIZE: 3.6"

AUDIO SECTION

| | |
|------------------------|----------------|
| Maximum Output LEVEL: | 2Vrms (+ 3 dB) |
| Frequency Response: | 20~20KHz |
| Signal-to-noise Ratio: | 65dB |
| Separation: | 65dB |

FM TUNER SECTION

| | |
|-----------------------------|--|
| Tuning Range: | 87.5-108MHz(Europe) 87.5-107.9MHz(U.S.A.) |
| IF: | 10.7MHz |
| Usable Sensitivity (-30dB): | 15dB |
| Signal-to-noise Ratio: | 60dB |
| Stereo Separation: | 30dB(1KHz) |
| Frequency Response: | 30~15000 Hz |

AM TUNER SECTION

| | |
|-----------------------------|--|
| Tuning Range: | 522-1620KHz(Europe) 530-1710KHz(U.S.A.) |
| IF: | 450KHz |
| Usable Sensitivity(-20dB) : | 28dB |

NOTE: Design and specifications are subject to change without notice for improvements.