



BV8220

Contents

*In-Dash AM/FM
DVD/MP3/CD Receiver With
5" Widescreen Touchscreen TFT Monitor
With Front Panel USB Port*

Precautions	2	DISC Special Functions	27
Safety Information	3	Selecting audio languages	27
Disc Notes	4	Selecting Subtitles	27
Installation	5	Selecting multi-angle views	27
Detaching the control panel	7	Title menu function	27
Changing the control panel	8	Setup	28
Electrical Connection	9	General Setup	28
Remote Control	10	Speaker Setup	30
Control Panel	13	Dolby Digital Setup	30
Touch Panel.....	13	Preferences Setup	31
Unit Keys	14	Defaults Table	32
Basic Operations	17	Other Main Operations	33
TFT Monitor Adjustment	17	USB Operations	33
Rear View Camera	17	MP3/WMA/JPEG Play	34
Audio Quality Adjustments	17	MPEG4 Play	34
Setting Audio Mode	18	Specifications	35
Reset The Factory Setting	18	Trouble Shooting	36
Scroll Caption Adjustments	18		
Radio Operations	19		
Listening to the radio	19		
Storing stations in memory	19		
Listening to a preset station	20		
RDS Function	20		
DISC Operations	22		
Basic Operations	22		
Select Playback Mode	24		
AUX Operation	25		
On-Screen Disc Operations	26		

Precautions

THANK YOU FOR PURCHASING THIS CAR DVD PLAYER .

Before operating the unit, read this manual thoroughly and keep it handy for future reference .

To avoid injury or accident , read the following precautions before installing and operating the unit .

ON INSTALLATION

- DO NOT install any receiver in locations where;
 - it may obstruct the steering wheel and gearshift lever operations, as this may result in a traffic accident.
 - it may obstruct the operation of safety devices such as air bags, as this may result in a fatal accident.
 - it may obstruct visibility.
- DO NOT operate any receiver while manipulating the steering wheel, as this may result in a traffic accident.
- The driver must not watch the monitor while driving.
- IF THE DRIVER watches the monitor while driving, it may lead to carelessness and cause an accident.
- IF YOU NEED to operate the receive while driving, be sure to look ahead carefully or you may be involved in a traffic accident.
- IF THE PARKING BRAKE is not engaged. “ ParkingBrake ” flashes on the monitor, and no playback picture will be shown.
 - This warning appears only when the parking brake wire is connected to the parking brake system built in the car (refer to the electric connection)

ABOUT THE LIQUID CRYSTAL DISPLAY (LCD) PANEL

Do not press too firmly on the LCD panel on the unit as doing so can distort the picture or cause a malfunction . The picture may become unclear , or the LCD panel may be damaged .

NOTES ON CLEANING

-Clean the LCD panel with a slightly damp soft cloth.

-Do not use solvents such as benzine, thinner, commercially available cleaners or antistatic spray .

-Do not use alcohol to clean the screen .

If your car was parked in a cold or hot place, the picture may not be clear .

The monitor is not damaged . The picture will become clear the temperature in your car becomes normal .

Safety Information

CAUTION:

THIS DVD PLAYER IS A CLASS I LASER PRODUCT. HOWEVER THIS DVD PLAYER USES A VISIBLE/INVISIBLE LASER BEAM WHICH COULD CAUSE HAZARDOUS RADIATION EXPOSURE IF DIRECTED. BE SURE TO OPERATE THE DVD PLAYER CORRECTLY AS INSTRUCTED.

USE OF CONTROLS OR ADJUSTMENTS OR PERFORMANCE OF PROCEDURES OTHER THAN THOSE SPECIFIED HEREIN MAY RESULT IN HAZARDOUS RADIATION EXPOSURE. DO NOT OPEN COVERS AND DO NOT REPAIR YOURSELF. REFER SERVICING TO QUALIFIED PERSONNEL.

WARNING:

TO REDUCE THE RISK OF FIRE OR ELECTRIC SHOCK, DO NOT EXPOSE THIS EQUIPMENT TO RAIN OR MOISTURE.

TO REDUCE THE RISK OF FIRE OR ELECTRIC SHOCK, AND ANNOYING INTERFERENCE, USE ONLY THE RECOMMENDED ACCESSORIES.

THIS DEVICE IS INTENDED FOR CONTINUOUS OPERATION.

COPYRIGHT PROTECTION





This product incorporates copyright protection technology that is protected by method claims of certain U.S. Patents and other intellectual property rights owned by Macrovision Corporation and other rights owners. Use of this copyright protection technology must be authorized by Macrovision Corporation, and is intended for home and other limited viewing uses only unless otherwise authorized by Macrovision Corporation. Reverse engineering or disassembly is prohibited.

REGION MANAGEMENT INFORMATION:

This DVD Player is designed and manufactured to respond to the Region Management Information that is recorded on a DVD disc. If the Region number described on the DVD disc does not correspond to the Region number of this DVD Player, this DVD Player cannot play this disc.

Disc Notes

Disc formats supported by this player

DVD		Audio and Video Disc size 12 cm
VCD		Audio and Video Disc size 12 cm
CD		Audio Disc size 12 cm
MP3		Audio Disc size 12 cm

Discs which cannot be played with this player

- DVD-RAM
- CDV
- CDG

Handling and Cleaning

- Dirt, dust, scratches and warping disc will cause misoperation.
- Do not place stickers or make scratches on discs.
- Do not warp discs.
- A disc should always be kept in its case when not in use to prevent from damaging.
- Do not place discs in the following places:
 1. Direct sunlight
 2. Dirty, dusty and damp areas
 3. Near car heaters
 4. On the seats or dashboard

Disc Cleaning

Use a dry soft cloth to wipe the surface. If the disc is quite dirty, use a soft cloth slightly moistured with isopropyl (rubbing) alcohol. Never use solvents such as benzine, thinner or conventional record cleaners as they may mar the surface of the disc.

Note:

A disc may become somewhat scratched (although not enough to make it

unusable) depending on your handle it and conditions in the usage environment. Note these scratches are not an indication of any problem with the player.

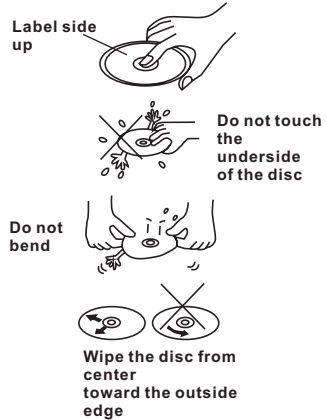

Preparing New Discs with Rough Spots

A new disc may have rough edges on its inside and outside edges. If a disc with rough edges is used, the proper setting will not be performed and the player will not play the disc. Therefore, remove the rough edges in advance by using a ball point pen or pencil as shown on the right. To remove the rough edges, press the side of the pen or pencil against the inside and outside edges of the disc.

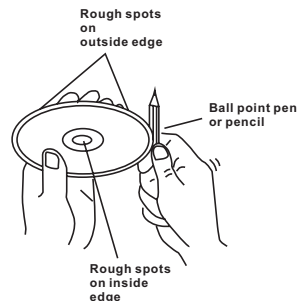

Installation

NOTES:

Choose the mounting location where the unit will not interfere with the normal driving function of the driver.

Before finally installing the unit, connect the wiring temporarily and make sure it is all connected up properly and the unit and the system work properly.

Use only the parts included with the unit to ensure proper installation. The use of unauthorized parts can cause malfunctions.

Consult with your nearest dealer if installation requires the drilling of holes or other modifications of the vehicle.

Install the unit where it does not get in the driver's way and cannot injure the passenger if there is a sudden stop, like an emergency stop.

If installation angle exceeds 30° from horizontal, the unit might not give its optimum performance.

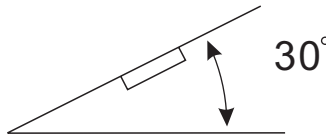

Avoid installing the unit where it would be subject to high temperature, such as from direct sunlight, or from hot air, from the heater, or where it would be subject to dust, dirt or excessive vibration.

DIN FRONT/REAR-MOUNT

This unit can be properly installed either from "Front"(conventional DIN Front-mount) or "Rear"(DIN Rear-mount installation, utilizing threaded screw holes at the sides of the unit chassis). For details, refer to the following illustrated installation methods.

USA/EURO FREQUENCY SWITCH

On the right of this device, there is a USA/EURO frequency switch, you can select the desired radio frequency before installing .

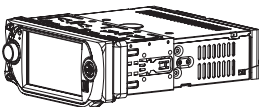

USA/EURO Frequency Switch (radio frequency switch for selecting between the USA and EUROPE frequency band.)

Installation

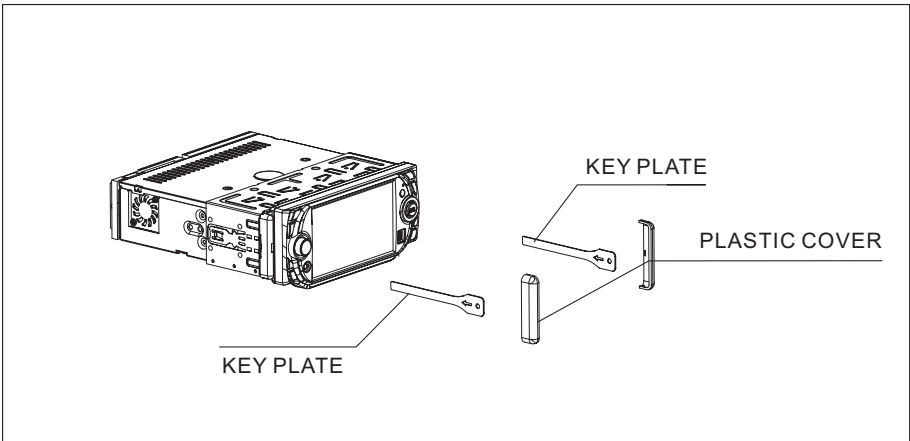
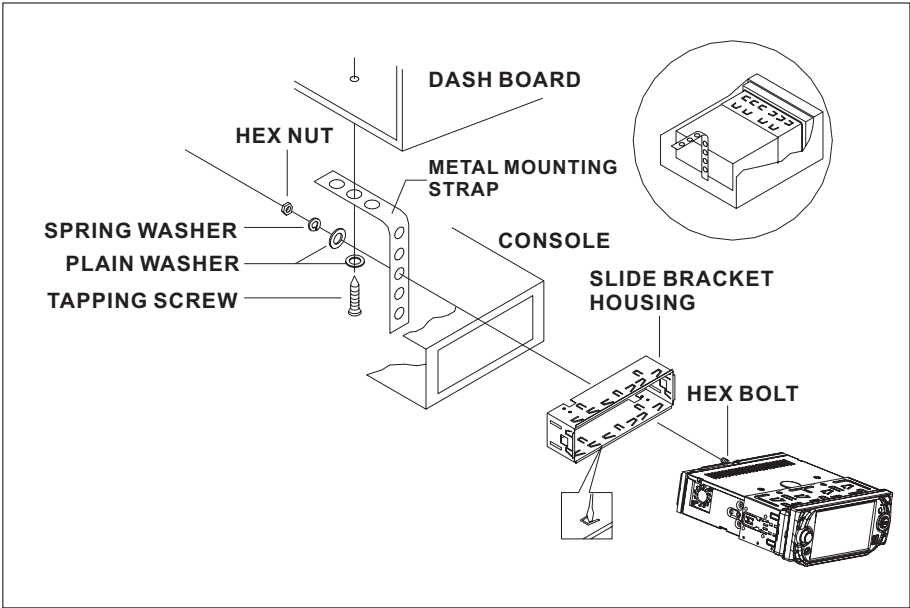

If you want to take CHASSIS out of the SLIDE BRACKET HOUSING, first remove the PLASTIC COVER of the both sides away, then insert the two KEY PLATE into left and right side of chassis as above illustration.

Installation

How To Remove And Install The Front Panel

When detaching or attaching the control panel, be careful not to damage the connectors on the back of the control panel and on the panel holder.

Detaching The Front Panel

Before detaching the control panel, be sure to turn off the power.

1). Press the release button and the left hand side of the front panel will release.

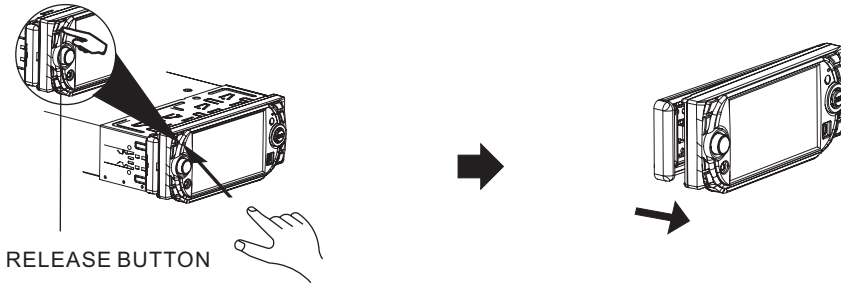

2). Pull-off the front panel and keep the front panel into the case .

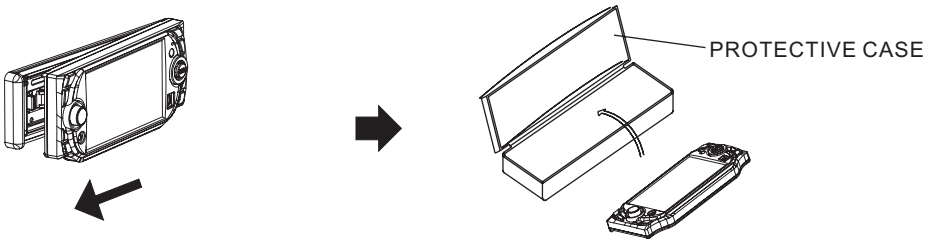

Attaching The Front Panel

1). First insert the right hand side of the front panel into the hollow of the unit .

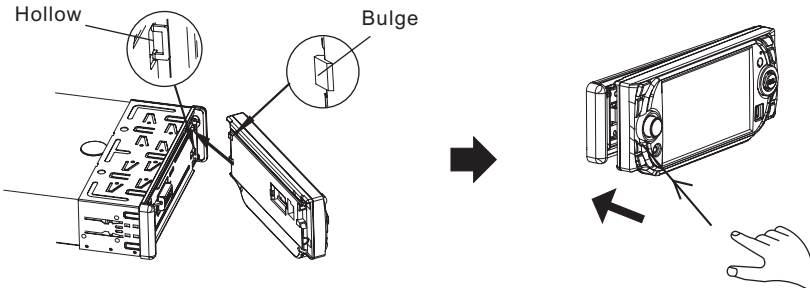

(NOTE : the “bulge” point on the panel must be attached into the hollow of the unit .)

2). Gently push the left hand side of the front panel until you feel a “ Click” .



Panel Angle Adjustment

CHANGING THE CONTROL PANEL ANGLE

When you want to change the viewing angle of the operating unit to play, you can touch the  section on touch screen (or press the  button on the front panel) repeatedly to select the desired angle as follows:

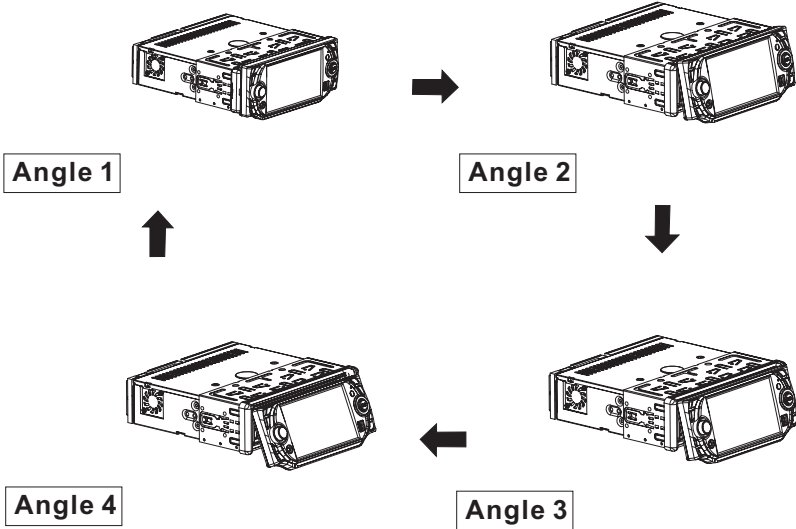

Caution:

Do not insert your finger behind the control panel.

Electric Connection

WIRING CONNECTION

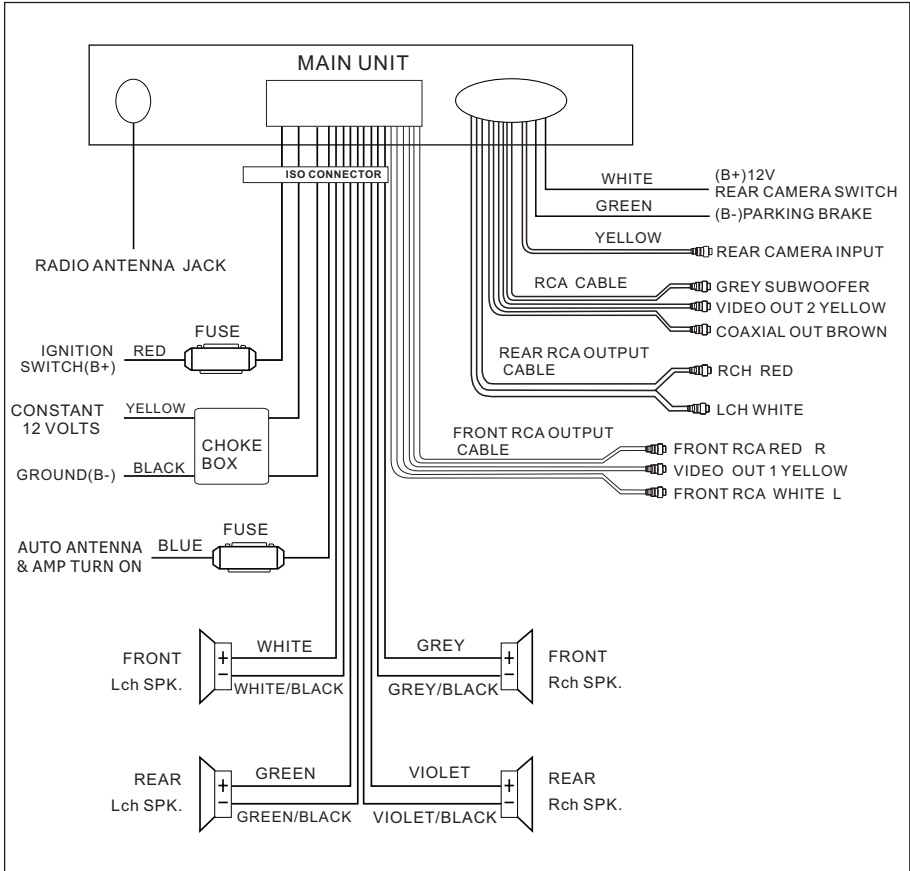

Note :

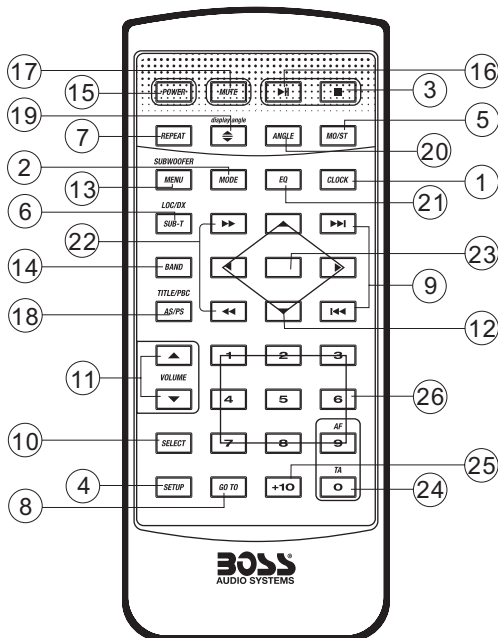

The "PARKING BRAKE" wire must be connected to the parking brake system of your car. When the parking brake is engaged, the LCD screen will be allowed to view your video. If not, the screen will produce an image saying, "PARKING BRAKE" This is a safety feature designed for the driver not to watch a video while driving. The video output on this unit is not affected by this.

Remote Control



Ref #	Button	Function
1	CLOCK	Press it briefly to view the clock time , Press again to return to normal display mode . Press longer to set the time .
2	MODE	Press repeatedly to cycle through the various modes: RADIO > DISC > AUX IN.
3	STOP	Press once to pause playback. Press PLAY/PAUSE to resume playback. Please note: if you press STOP twice, playback will start at the beginning of the disc.
4	SETUP	Press this button to open the SETUP menu.
5	MO/ST (AUDIO)	In Radio mode, press this button to change between Mono and Stereo reception modes (when a station is weak, sometimes switching to Mono will improve sound quality). In Disc Playback mode, pressing this button opens the AUDIO setup menu for making changes to the way the soundtrack is reproduced.
6	SUBTITLE LOCAL/DISTANT	In DVD Disc Playback mode, pressing this button will allow you to change the subtitle language on discs which have this as an option. In Radio mode, press this button to change the radio reception sensitivity in stations are near or far.
7	REPEAT	Pressing this button will open a menu presenting you with the playback repeat options available for that kind of disc.

Remote Control

Ref #	Button	Function
8	GOTO	Press it button to begin playback at a moment in the program you designate. Use number buttons to enter the data that is needed.
9	▶▶ / ◀◀	Press these buttons to skip ahead or back one track. (Note: In DVD mode, press continually the ◀◀ twice to skip back one)
10	SEL	Press this button repeatedly to cycle through the various audio and video adjustments you can make: Volume, Bass, Treble, Balance, Fader, Color, Brightness, Contrast and Tint.
11	VOL+/-	Use these controls to adjust the volume level.
12	◀ / ▶ / ▲ / ▼	Press to navigate the various menus present in the product.
13	Menu SubWoofers ()	Press this button briefly to display the root level directory of a DVD disc. Press and hold this button to turn on or off the SUBWOOFER output.
14	BAND (OSD)	In Radio mode, press this button repeatedly to switch between the five radio bands: FM1 > FM2 > FM3 > AM1 > AM2. In Disc Playback modes, Press this button to see information about the disc currently in play.
15	 (POWER)	Press this button to turn the unit ON , press and hold to turn the unit OFF.
16	PLAY/ PAUSE	In Disc Playback mode, press to pause playback. Press again to start where playback stopped.
17	MUTE	Press this button to turn off the audio. Press again to restore the sound to its prior volume level.
18	TITLE/ PBC(A/P)	When playing a DVD, pressing this button will open the TITLE menu which is recorded on the DVD. When playing a VCD disc, press this button to create a PBC (Playback Control) menu for the disc to assist in making playback selections. In Radio mode, press and hold this button to start the Auto-Program mode, during which the tuner will scan for all strong stations and assign them to the radio preset buttons.
19		Press this button to adjust the screen viewing angle (see page 8).
20	ANGLE	For DVD discs which have alternate viewing angles encoded, when you see the "angle mark" symbol advising you that these angles are available, press this button to see them.
21	EQ/LOUD	Press repeatedly to cycle through the different equalizer curve presets you may wish to use for enhanced listening.
22	▶▶ / ◀◀	In Disc Playback mode, press for fast forward/reverse playback.
23	ENTER	This button is used to confirm selections and settings within many of the menus in the OSD system.

Remote Control

Ref #	Button	Function
24	0-9	These buttons are used for numeric entry in many different menus. In addition, in Radio Mode (when RDS is engaged), 0 serves as the TA button and 9 serves as the AF button.
25	+10	This button is used with the other number buttons for use with two-digit number entries.
26	1-6	Six numbered preset buttons store and recall stations for each band.

Preparing the Remote Control

Inserting the Battery

1. First push to inside as the direction indicated by the arrow (See ①) And then Remove the battery holder as the direction indicated by the arrow (See ②).
2. Replace the battery Set a new battery property with (+)side up as illustrated (See ③).
3. Insert the battery holder. Push in the holder to the original position(See ④).

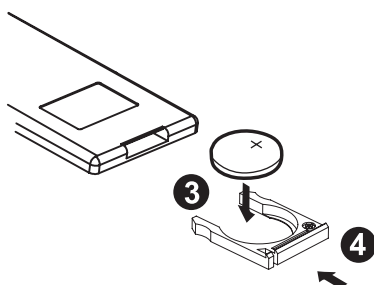
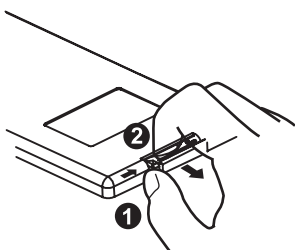

Using the Remote Control

Face the remote control towards the player front face IR mark (remote control signal receiver).

Operation angle: About ± 30 degree in each the direction of the front of the IR mark.

Note :

The lithium cell in the battery compartment of remote control has been secured for transport with a foil . Before initial use please remove this foil so that the remote control is ready for operation .

Control Panel

Key Functions

Touch Panel

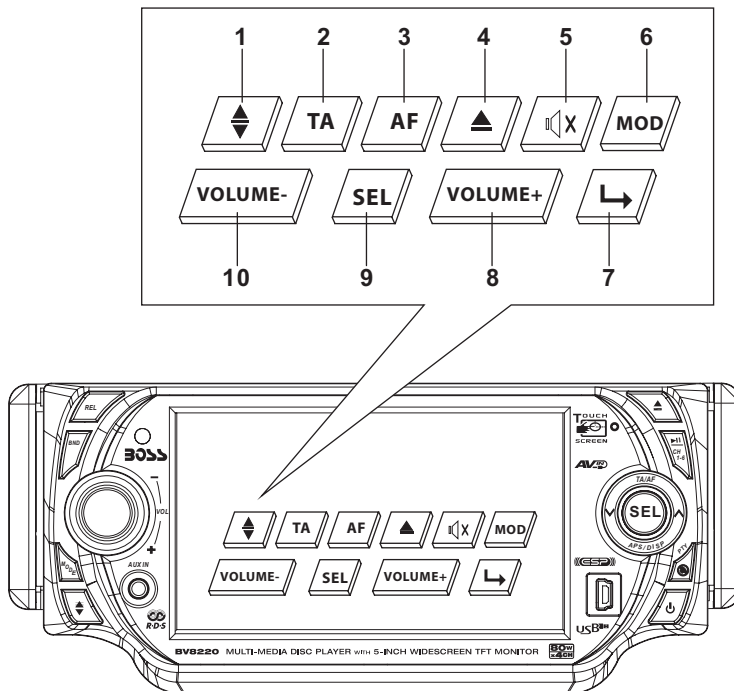

Touch Screen Key :

1. **◆ (Angle)** : Changing the viewing angle of the operating unit .
2. **TA** : Turning pre-switching for traffic announcements on and off . (For RDS)
3. **AF** : Switch on and off and alternative frequency. (For RDS)
4. **▲ (Eject)** : Touch it to insert and eject the DISC .
5. **🔊 X** : To switch of the sound .
6. **MOD** : operating mode selection .
7. **⏮** : Previous
8. **Volume+** : volume adjustment (+)
9. **SEL** : select the menu of the Sound/Picture
10. **Volume-** : volume adjustment (-)

Control Panel

Unit Keys :

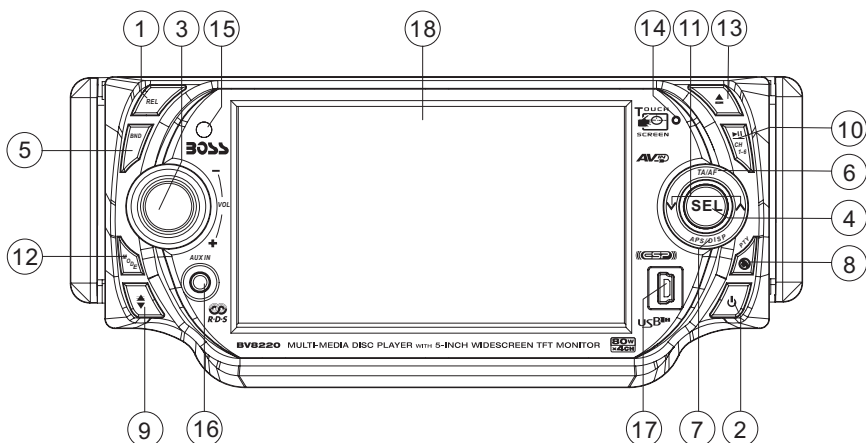

1. REL BUTTON

Press this button to release the front panel for removal . Refer to see page 7.

2. ⏻ (POWER On/Off)BUTTON

Press this button to switch the device on. WELCOME appears in the display. Press it again to switch the device off. SEE YOU appears in the display.

3. VOL+ / VOL- KNOB

In normal mode, this knob is used to increase or decrease the volume. It is also used as an UP/DOWN knob when audio or video settings are being adjusted when accessed using the SELECT button.

4. SELECT KNOB

To access the available adjustment settings for audio and video, press this knob repeatedly to cycle through and select them:

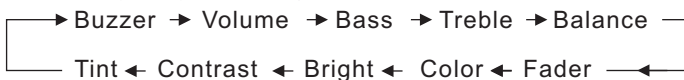

5. BAND BUTTON

In **Radio mode**, press it repeatedly to select the desired radio band: FM1, FM2, Fm3, AM1(MW1), AM2(MW2) .

6. TA/AF BUTTON

TA Function [traffic Announcement] Button(for Rds Only)

In RADIO mode

When you swing briefly the SEL knob in the TA/AF direction , the TA function is activated, the TA symbol appears in the display . (swing it again to turn off .)

Control Panel

AF [Alternative Frequencies]

Swing and hold (for about 2 seconds) the SEL knob in the TA/AF direction , the AF function is activated. The AF symbol appears in the display . (Swing and hold it again to cancel this function .) The function about RDS to see page 20 .

Note: In Radio mode, press and hold the SEL knob for a long time to access the selection menu:

REG ON/REG OFF, PI MUTE/PI SOUND, AF ON/AF OFF .

Repeatedly pressing the SEL knob to select the item and by using the VOL+/- to change .

7. APS, DISPLAY FUNCTIONS (using the SELECT knob)

Scan Function

In Radio mode, swing the SEL knob briefly in the APS/DISP direction , the radio briefly plays all the preset stations of the frequency band .

Automatic Preset Setup

In Radio mode, swing the SEL knob in direction of the APS/DISP for about 2 seconds to active automatic station storage. The radio searches within the current frequency band, e.g. Fm1, for the stronger signal level until the search cycle has finished . The six strongest stations are then allocated to the corresponding storage locations . Then the station of the first storage location is set .

Display ON/OFF Function:

In Disc mode, swing the SEL knob briefly in the direction of APS/DISP to turn off the display image (the monitor on the unit only) , the sound will stay on.

(Swing it again to resume the playback picture mode.) You can press SEL knob briefly to select the “BG COLOR” by repeatedly pressing the SEL knob, then rotate the VOL+/- to select the background color among of the “AUTO, BG COLOR: 01.....BG COLOR: 11”, in “AUTO” mode, the monitor of unit will change the background color automatically .

8. (MUTE)/PTY BUTTON

Press this button briefly to select the MUTE or NOT .

In Radio Mode, press this button and hold for a bout 2 seconds to select the PYT of the program type (examples of such types of program are : NEWS, POP.....)

9. ANGLE (Screen position)

Press this button repeatedly to cycle through the different positions.

10. /CH 1-6 (RADIO PRESET)BUTTON

A). In Disc Playback Mode

Press this button to pause playback, press it again to resume playback.

B). In Radio Mode

Press this button repeatedly to preset station. (Please refer to see page 20 .)

Control Panel

11. **∨ / ∧** BUTTONS (TUNE, SEEK, TRACK, SKIP UP/DOWN)

A) In DISC, USB mode:

if you wish to jump forwards or backwards press the SEL button (4) briefly in the **∧** or **∨** direction. (Note: in DVD mode, press the SEL button continually twice in **∨** direction to skip back one track during playback.)

To go through the tracks keep the SEL button pressed in the **∧** or **∨** direction for about 2 seconds. FF X2 appears in the display. Operating the SEL button again, the speed of rapid forward/reverse changes according to the disc as follow:

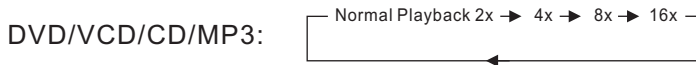

B) In Radio Mode:

Move the SEL button in the direction of **∧** or **∨** in order to set a radio station manually. Keep the SEL taste pressed down in the **∧** or **∨** direction in order to start the search for a radio station automatically.

12. **MODE** BUTTON

Press it repeatedly to select AUX IN , RADIO and DISC mode.

During the USB playback, you can press STOP button and then press GOTO button to select the DISC mode.

13. **▲** (EJECT) button

Press it button to eject the DISC or insert the DISC to start play .

14. **RESET** button

Press this button to return to the factory settings .

15. **IR** sensor

16. **AUX** Input Jack

For information about connecting a AUX device, please see page 25 .

17. **USB** PORT

For information about connecting a USB device, please see page 35.

18. **TFT** Display (liquid crystal display)

The operation of the TFT, please see page 17.

Basic Operation

POWER On/Off



Press it to switch the device ON, press it again to switch the device OFF.

Ejecting The Disc



Use your finger to touch the ▲ range on touch screen, the control panel of the unit will swing downwards. Then you can insert the disc or eject the disc. (You can also press the ▲ button on the front panel to eject the disc or insert the disc to start play.)

Select Sources



Touch repeatedly the MOD section on the screen, the signals will display in the screen as follow :

DISC → **AUX IN** → **RADIO**

Volume Adjusting

Volume button



Revolve : clockwise to increase /
Anticlockwise to decrease .



Press the VOL+/- on remote control ,
to change the volume level .

Touch screen



Touch the screen the VOLUME+ to increase the volume level .



Touch the screen the VOLUME- to decrease the volume level .

Mute Function



Use your finger to touch the  section , it will mute the sound but the disc continues playing. Touch it again to resume .

Setting The Clock



Touch the CLK section on the screen and hold for about 2 seconds the hour will flash , rotate the VOL+/- to adjust . Touch it again, the minute will flash, then use the VOL+/- to adjust .

Setting The Buzzer ON/OFF



Touch the SEL section on the touch screen to select the **BUZZER** item, and then touch the VOL+/- (or rotate the vol+ /vol-) to switch the **BUZZER ON/OFF** .

Basic Operation

LCD Monitor Adjustment



During DISC playback, use your finger to touch briefly the SEL section on the screen (or press SEL button on front panel) to access the Picture mode



selection menu, by repeatedly touch the SEL section, and then touch the VOL+/- (or rotate the VOL+/-) to adjust the selected mode .

(The corresponding value will show on the monitor)

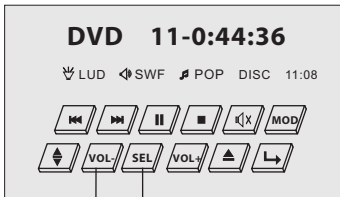

touch to select

touch to adjust

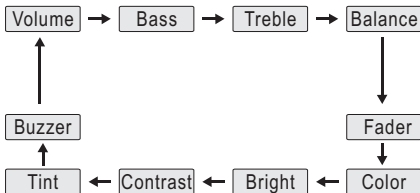

ADJUSTABLE ITEMS:

COLOR: 0 to 32

Adjust the color for the picture-lighter or darker.

BRIGHT: 0 to 32

User can use the Vol+/- knob to adjust the brightness level from 0 to 32 .

CONTRAST: 0 to 32

To adjust the contrast of the bright and dark portion.

TINT: 0 to 32

Adjust the tint if the human skin color is unnatural.

-Adjustable when "NTSC " is selected for "NTSC/PAL " .

Rear View Camera

When you connect a rear view camera to this system. It will display the image in a mirror like fashion. Once you engage the car into Reverse the screen will show the camera image. Then once you take the car out of Reverse the screen will go back to the previous mode.

Audio Quality Adjustment



During DISC playback, use your finger to touch briefly the SEL section on the screen (or press SEL button on the front panel)



to access the Sound mode selection menu, by repeatedly touch the SEL section, and then touch the vol+/- (or rotate the vol+/-) to adjust the selected mode . (The corresponding value will show on the monitor)

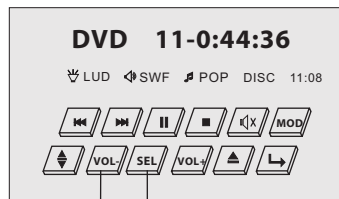
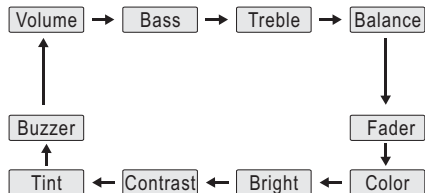

touch to select

touch to adjust

It's depend on your habit to setup the data .

ADJUSTABLE ITEMS:

Volume: 0 to 32

Adjust volume level by using VOL + / - .

Bass: -14 to +14

Adjust bass level by using VOL + / - .

Treble: -14 to +14

Adjust treble level by using VOL + / - .

Basic Operation

Balance: R 0-10 to L 0-10 .

Adjust sound balance between left and right speakers by using VOL + / - .

Fader: F 0-10 to R 0-10 .

Adjust sound balance between front and rear speakers by using VOL + / VOL - .

Setting Audio Modes

 Touch the screen the DSP range (or press the EQ/LOUD button on the remote) to select one of the preset sound modes .

(Rock/Pop/Jazz/Classic/Flat) .

The information will display in the monitor as follow :

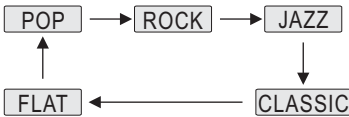

touch to select

It`s depend on your habit to select the Audio mode .

Scroll Caption Adjustment

In Radio mode:

You can adjust your desired scroll caption , the method of the operation as follow:

- Press and hold the SETUP button (for about 2 seconds) on the remote control, the adjustment scroll bar will display on the screen .
- Use the VOL+/- to select among of the "A, B, CX, Y, Z, and blank ", and use the ^ / v button on the front panel

to ahead/back (proceed/cancel) , and then press the SETUP button briefly to confirm .

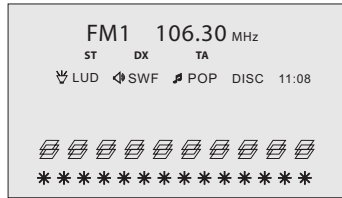

(Please note : press the button longer again to renew it .)

Reset Factory Settings

RESET button is placed on the housing and must be activated with either a ballpoint pen or thin metal object. The RESET button is to be activated for the following reasons:

- Initial installation of the unit when all wiring is completed.
- All the function buttons do not operate.
- Error symbol on the display.

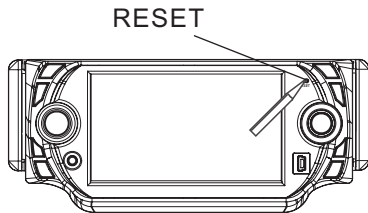

NOTE:

If RESET is selected, all memory data will deleted, please re-adjust .

Radio Operation

Listening to the Radio

Switching To Radio Mode

 Touch the MOD range repeatedly on the screen to select the RADIO mode. the following information will appears as below:

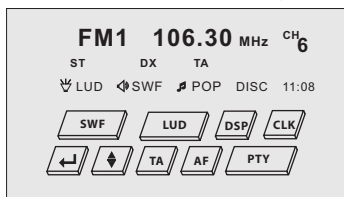
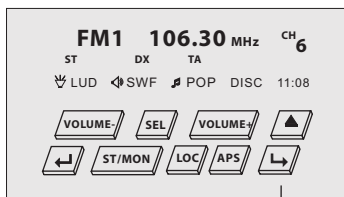
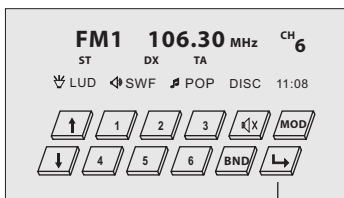

 Touch “” to next .

 Touch “” to previous .

Selecting The Frequency Band



 Touch the **BND** section on the touch screen repeatedly to select the band , screen band will show in turn :





(You can also press the BND on front panel repeatedly to select the band .)





Start Searching For a Station

Manual Search

During Radio mode, briefly touch the screen of “” section or swing the SEL knob in direction “” on front panel to increase frequency by one step of channel spacing .

Briefly touch the “” section or swing the SEL knob in direction the “” button on front panel to decrease frequency by one step of channel spacing .

Automatic Search

During Radio mode, touch and hold (for more than 2's) the screen of “/ ” section or swing and hold the SEL knob in the direction “ / ” on the front panel to start search for a radio station automatically .

When an FM stereo broadcast is hard to receive

 Touch the **ST/MON** section on touch screen (or press ST/MO button on the remote) to select the MONO or STEREO mode .

(When Stereo mode is activated, the ST symbol will appear .)

Radio Operation

To tune in strong-signal FM Station only (LO/DX function)



Touch the LOC section on the touch screen (or press LO/DX button on the remote) to select the LOCAL or DX mode .



(You can choose between the LOCAL and DX(DISTANCE) mode for local or long-distance traffic news .)

Storing Stations In Memory

Setting Memory

Press the **▶/CH 1-6** button repeatedly on the front panel to preset stations at radio mode . (Or touch the screen the 1-6 sections)

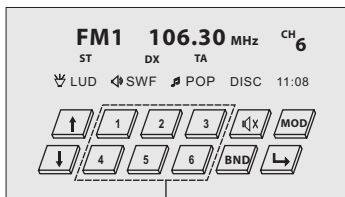

Touch to preset station

With this system, a total of 30 stations can be stored in the memory of six buttons. Each band stores up to six preset stations. The stations might be FM1, FM2, FM3, AM1(MW1), and AM2(MW2) band.

The operation is as below :

-Store in Memory

Touch and keep the 1-6 sections (or press and hold the **▶/CH 1-6**) for about 2 seconds, the current listening station will be stored into the number location .

-Retrieve a preset station

Touch the 1-6 sections briefly (or press the **▶/CH1-6** button repeatedly) to retrieve a station which had been stored in the memory in advance the chose number is shown on display .

Automatic Memory Storing & Program Scanning

Automatic Preset Setup



In Radio Mode, Touch and keep the APS section on the touch screen (or swing and hold the SEL knob in direction of the APS/DISP) for about 2 seconds to active automatic station storage. The radio searches within the current frequency band, e.g. FM1, for the stronger signal level until the search cycle has finished . The six strongest stations are then allocated to the corresponding storage locations . Then the station of the first storage location is set .



Scan Function



In Radio mode, briefly touch the APS section on the touch screen the radio briefly plays all the preset stations of the frequency band .



RDS FUNCTION



In Radio mode, touch it to select the desired item, it will display the following as below :

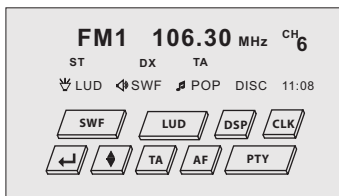

TA Traffic Announcement

(priority For Traffic Information)



In Radio mode, touch the TA section briefly (or swing the SEL knob briefly in the TA/AF direction), to activate the TA function . Touch it again to turn off the TA function .When the TA function is activated, the TA symbol appears in the display .



Radio Operation

During radio operation in one FM frequency band the search for a traffic announcement station is started automatically (TA SEEK) .

If an FM station is being received which transmits the latest traffic announcements from time to time, the TP display lights up.

When the TA function is switched on , the FM traffic automatically interrupt CD operation (the word TRAFFIC appears in the display).

The volume level is increased to the minimum value for the transmission of traffic announcements.

After the traffic announcements has finished, the program that was previously running is resumed.

Interruption of the TA Function:
if you would like to interrupt the current traffic announcement, touch the TA section on screen briefly . This does switch off the TA mode .

AF FUNCTION

(Alternative Frequencies)



In Radio mode, touch the AF section briefly (or swing and hold the SEL knob in the TA/AF direction) , to activate the AF function. Touch it again to turn off the AF function .

AF is a function that works with the help of RDS (Radio Data System) and can only be used with FM stations . The radio searches in the background for the best frequency reception of the station that has been tuned into .

Touch the AF section on touch screen or swing and keep the SEL knob in the TA/AF direction for about 2 seconds , the AF function is activated. The AF symbol appears in the display .

When the AF function has been switched on, the radio continuously tests the signal strength of the AF frequency . The test interval for each AF frequency depends on the signal strength of the current station and varies from a few

minutes in the case of weak signals.

Whenever the new AF frequency is stronger than the station that is currently tuned in , the radio switched to this frequency for a short time for a short time and the message “NEW FREQUENCY “ is displayed for one or two seconds.

Note :

the status of the AF function is shown by an AF symbol in the display.

- If the AF symbol appears in the display, the AF function is switched on and RDS transmission data is being received .
- If the AF symbol flashes in the display, the AF function is selected but no RDS signal can be received at the moment .

PTY FUNCTION



In Radio mode, touch the PTY section briefly (or press and hold the MU/PTY button on the front panel) , to select the Program type .

PTY Selection of the program type

besides the stations name, some FM stations also transmit information on the type of program. This information can be displayed by your car radio .

Examples of such types of program are :

SPORT NEWS POP WEATHER

With PTY function you can specifically select stations transmitting a particular type of program. Touch the PTY range on screen repeatedly to call up the PTY selection menu . The message “PTY SEEK” then appears briefly in the display .

When PTY has been selected the radio starts searching for corresponding PTY information and stops when the PTY information has been found, “NO PTY” appears in the display. If the PTY information being searched for no longer exists, the PTY function automatically switches to normal mode .

DISC Operation

Basic Operation

During DISC playback, you can touch the screen to display the following:

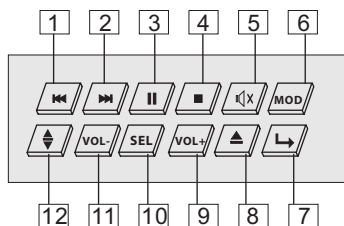
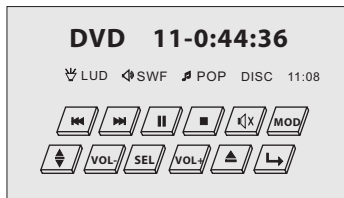

1. Previous
2. Next
3. Pause
4. Stop
5. Mute
6. Mode
7. To next page
8. Insert or Eject the disc.
9. Volume+(adjustment+)
10. Select
11. Volume-(adjustment-)
12. Change Angle of unit.

Touch it to select the other item, it will display the following as below:



Touch it to select the other item .



Touch it to select the other item .

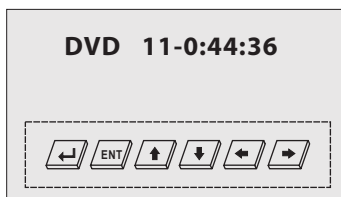

Above these operation buttons for DVD setup.

Touch it for previous .

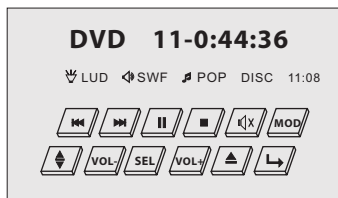

DISC Operation

Switching the DVD mode



Touch the MOD section on the touch screen (or press MOD button) to select the DISC mode, it display like following :

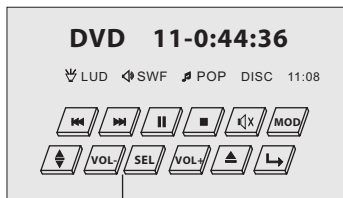

Function setup
(different the source the display is different)

Stopping Play



Touch the screen the ■ range (or press the ■ button on remote control .) To stop the unit playback. Touch the || section or press || button on front panel to start play.

Pause (still picture)



Touch the “ || ” section on touch screen during playback will stop play temporary, touch it again to return the normal playback .

Rapid Forward/Rapid Reverse



During DISC playback, Touch and hold (for about 2 seconds)the ►► / ◀◀ section on the touch screen (or swing and hold (for more than 2's) the SEL knob in the direction “ ^ / v ” on the front panel , the speed of rapid forward/reverse changes according to the disc as follow:



DVD/VCD/CD/MP3:

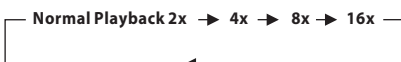

Skipping Track



During DISC playback, Touch the screen of “ ►► / ◀◀ ” range to skip to next/back one track.



(You can also swing briefly the SEL knob in direction “ ^ / v ” buttons on the front pane to skip to next / back one track.)

Note :

1. In DVD mode, touch the ◀◀ section continually twice to back one track . (Move the SEL knob in the direction of the v button on the front panel continually twice to back one track .)
2. For some VCD2.0 disc (PBC-playback control), above these buttons may be unavailable .

Zoom Function



Repeatedly touch ZOOM section , the displaying rate can be 2x, 3x, 4x, 1/2, 1/3, 1/4 .

Press the direction keys ▲ / ▼ / ► / ◀ buttons on the remote control or touch the screen of “ ↑ / ↓ / ← / → ” section to move through the enlarged picture .
Note: During JPEG playback , touch the screen of ZOOM section , the word “zoom 100%” will display, then you can touch and hold (more than 2's) the ►►/◀◀ section on touch screen (press briefly the ►►/◀◀ buttons on remote control) to increase /decrease in size .During the ZOOM mode, use the direction buttons to move the picture up, down, left, right of the direction .

Loud Function



Touch the LUD section on the touch screen to switch the LOUD-NESS function ON and OFF .

Subwoofer Function





touch the SWF section on the screen to switch the Subwoofer function ON and OFF .

DISC Operation

Selecting The Play Modes

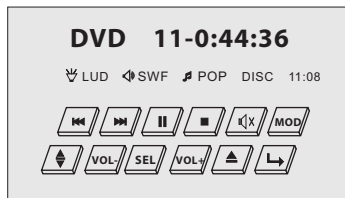
During the Disc playback, touch the touch screen, it will display the following as below :



 Touch the  section to select .



1). Repeat Function

FOR DVD :

 Touch the screen the RPT section (or press longer RPT on remote control) to select REPEAT mode as follow :



FOR VCD/CD/MP3 :

 Touch the screen the RPT section (or press longer RPT on remote control) to select REPEAT mode as follow :



1. Continuously repeat at the current chapter/track, when selected REP-ONE mode .
2. Select REP-ALL mode to continuously repeat all chapter/track on the current disc .

2). RDM(RANDOM) Function

 Touch the RDM section (or press 4/RDM button longer on remote control to play in random.

Each playing, the order is different . (depend on the disc used for VCD). Touch it again to cancel this function . (Note: the “” button is not available .)

3). INT Function

FOR CD :

 Touch the screen the INT section (or long press the 3/INT button on the remote) to play the previous 6 seconds part of each track/chapter on disc.(touch it again to cancel)

FOR VCD :

 Touch the screen the INT section (or long press the 3/INT button on the remote).it display will following menu as below :

(touch it again to cancel this mode .)

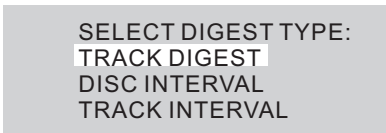

Use the UP, DOWN, LEFT and RIGHT arrows on the remote to select the item, and then press ENTER to confirm .

FOR DVD :

 Touch the screen the INT section (or long press the 3/INT button on the remote). it display will following menu as below :

(touch it again to cancel this mode .)

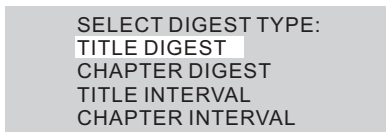

Use the UP, DOWN, LEFT and RIGHT arrows on the remote to select the item, and then press ENTER to confirm .

Note : The 3/INT button is not available for MP3 .

DISC Operation

DISC Search (GOTO)



Touch the **GOTO** section, it display will following as below :

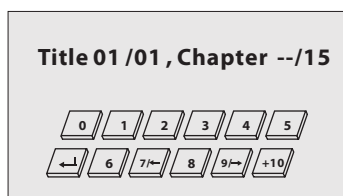

FOR DVD :

Touch the screen the **GOTO** range (or press **GOTO** on the remote). Twice, the screen will display the following message :

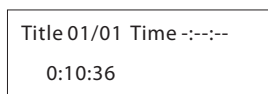

You can select the item you want to watch through TIME setting by using numeric buttons . (E.x. 0:10:36)

FOR VCD (With PBC OFF):

Touch the screen the **GOTO** range (or press **GOTO** on the remote). Once, the screen will display the following message :

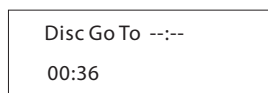

Use the numeric buttons to input the time directly (E.x. : 00:36)

Note:

Touch and hold the “ 7← ” or “ 9/→ ” range on the touch screen , you can select the title or chapter of DVD . (Only for the DVD with title /chapter.)

AUX Operation

To connect analogue replay devices. Use this jack to replay sound of other replay equipment such as DVD players, computers, etc. Via the loudspeakers.

AUX IN JACK IN PANEL

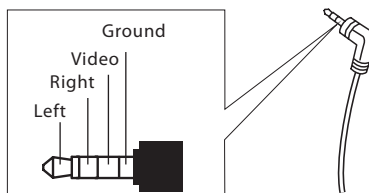
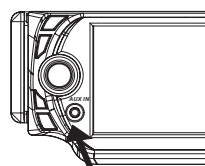

1). Please connect the external device with stereo jack plug the Aux in socket .

2). Touch the MOD section on screen or press the MOD button to select the AUX IN connection.

3). You now hear the sound from the external device played back through the loudspeakers .

4). Touch the volume+/- sections on touch screen or use the VOL+/- on the remote to adjust the volume level.

DISC Operation

ON-SCREEN DISPLAY FUNCTION



During playback, touch the screen the OSD section (or press the OSD on the remote), it will display the following as below :

1. DVD:

A.Touch or Press **OSD** for first time:



Title Number, Total Title Number, Chapter Number, Total Chapter Number of this Title of the disc currently being played will be shown on the screen, along with the elapsed time.

B.Touch or Press **OSD** for second time:



C.Touch or Press **OSD** for hird time:



D.Touch or Press **OSD** for fourth time:



E. Touch or Press **OSD** for fifth time:
The message on the screen will be cleared.

2.Example for VCD/SVCD/CD:

A.Touch or Press **OSD** for first time:



B.Touch or Press **OSD** for second time:



C.Touch or Press **OSD** for hird time:



D.Touch or Press **OSD** for fourth time:

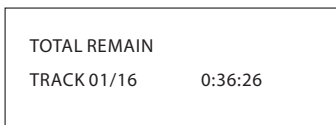

E.Touch or Press **OSD** for the fifth time:
The message on the screen will be cleared for SVCD and VCD.

NOTE:

For CD and MP3,the message will always display on the screen.

3.Example for MP3:

Each time **OSD** is pressed or touch , the message displayed on screen changes as follows:



DISC Special Functions

DVD/VCD Special Function



1. Multi-subtitle Language Function (for DVD Only)



During DVD playback. Touch the **SUBTITLE** section on touch screen (or press the SUBTITLE on the remote). Each time the button is pressed or touch, number of the subtitle language changes in sequential order.

Notes:

- The language number is different according to the disc.
- Some discs only contain one subtitle language.
- When no different subtitle language are recorded, will be displayed at screen left top corner.

2. Multi-Audio Language Function



For DVD: During DVD playback, touch the **AUDIO** section on touch screen (or press the AUDIO on the remote). Each time the button is pressed or touch, number of the audio soundtrack language changes on sequential order.

Notes:

- The language number is different according to the disc.
- Some disc only contain one language soundtrack
- When no different language soundtrack are recorded will be display at screen left top corner.

For VCD/CD:

during playback, touch the **AUDIO** section of the touch screen or Press **AUDIO** on the remote. It is possible to switch the sound between monaural and stereo sound.



3. Multi-Angle Function (for DVD Only)



During DVD playback, touch the **ANGLE** section on the remote. Each time the button is pressed or touch, number of the angle changes in sequential order.

Notes:

- The angle number is different according to the disc.
- The function only work for disc having scenes recorded at different angles.
- When no different angle are recorded, will be displayed at screen left top corner.

4. Title Menu Function



For DVD: If the DVD has multiple titles recorded on the disc. It can select preferred title from the title menu to start playback.

- During DVD playback, touch the **TITLE** section or press TITLE button on the remote. The title menu is display.
- Touch the cursor button shown in TV screen, select preferred title by the cursor button and confirmed by touch ENT button.

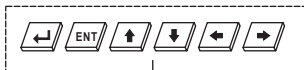

Touch to select

For VCD:

Press **TITLE/PBC** button on the remote control while the disc is playing, you can switch between "PBC on" and "PBC off" mode.

Setup

USING THE MENU

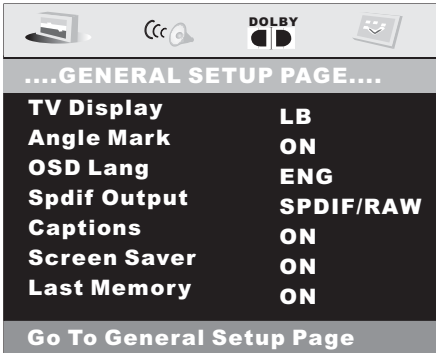

1. Touch the **SET** section of DVD setup on touch screen (or press the SETUP on the remote .)
2. The SETUP menu is displayed.
3. Select the preferred item by touch the **↑ / ↓ / ← / →** range on the screen or by using the **▶ / ◀ / ▼ / ▲** buttons .
4. Touch the ENT section on screen or Press ENTER button on remote to confirm .

The Following Buttons For Entering The Selection.

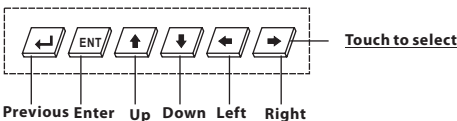

The buttons of the left and right are for selection of setting type .
The buttons of the up and down are for selection of the setting program .

Overview Of The Main Menu

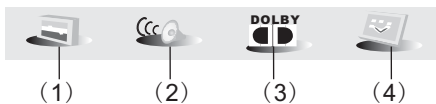

- (1).General Settings
- (2).Speaker Settings
- (3).DOLBY Digital Settings
- (4).Preference Settings

GENERAL SETUP TV Setting

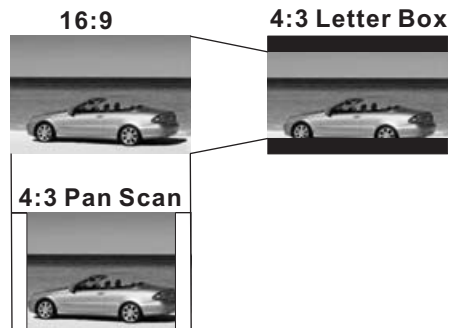
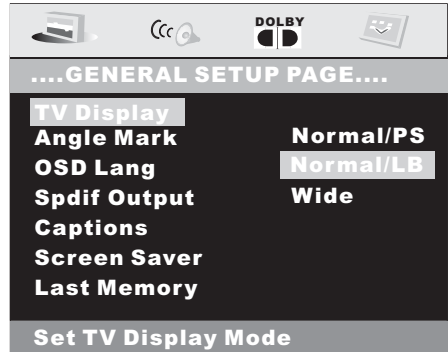

1.TV DISPLAY SETUP

This is to select the appropriate TV aspect (4:3 or 16:9) according to the connected TV set.

Normal/PS (For 4:3 TV)

Played back in the PAN & SCAN style.
(If connected to wide-screen TV, the left and right edges are cut off.)

Normal/LB (For 4:3 TV)

Played back in LETTER BOX style.
(If connected to wide-screen TV, black bands appear at top and bottom of the screen.)

Wide (For 16:9 TV)

Select when a wide-screen TV set is connected.

Setup

GENERAL SETUP

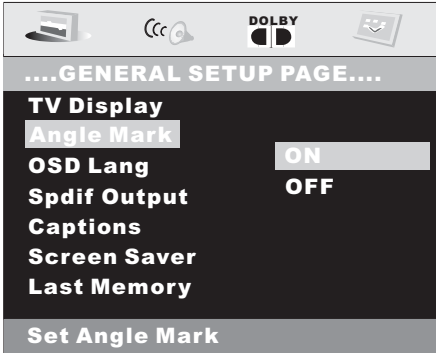

2. ANGLE MARK DISPLAY SETUP

If it is set to ON, when the multi-angle DVD disc is playing,  (the angle mark) will appear on the screen; if it is set to OFF, the mark will not appear.

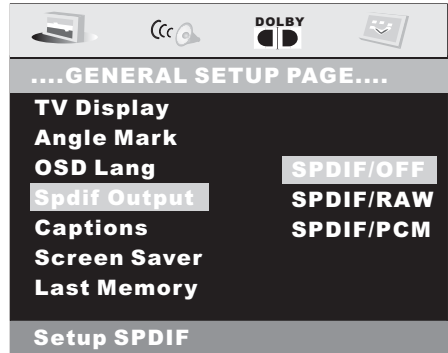



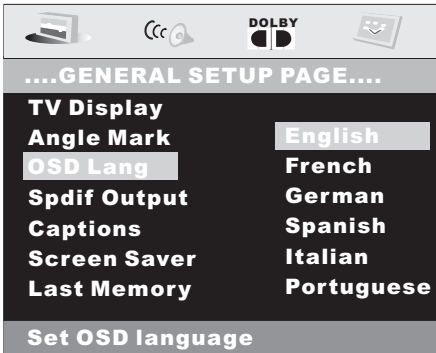

4. SPDIF OUTPUT

This is to activate the audio output from SPDIF OFF mode to SPDIF/RAW mode to SPDIF/PCM mode.

LANGUAGE DISPLAYING



3. OSD LANG TYPE SETUP

Touch the  /  section on the touch screen or press the  /  button on the remote to select the preferred OSD language, then touch the ENT section to confirm.

SUBTITLES HIDING

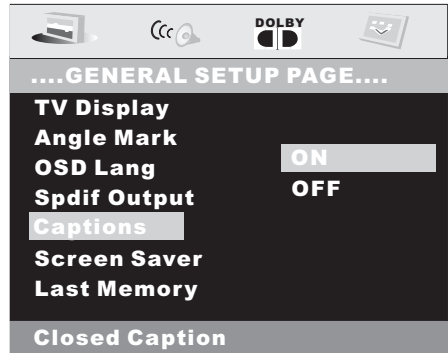

5. CAPTIONS SETUP

Activate the CAPTIONS feature by selecting ON. And release this feature by selecting OFF.

Setup

GENERAL SETUP

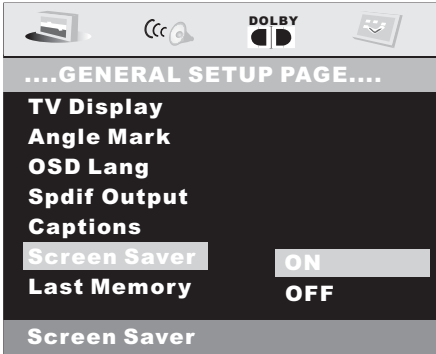

6. SCR SAVER SETUP

Select the SCR SAVER output
ON/OFF.

SPEAKER SETUP

.....Speaker Setup Page.....

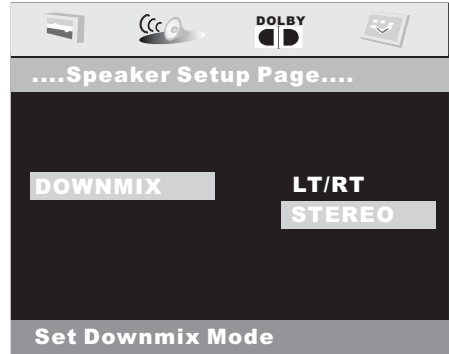

This is to activate the audio output from DOLBY AC3 5.1 DOWNMIX to 2 channel mode. Select the preferred SPEAKER connection by using the cursor buttons. Select the LT/RT to activate the Dolby surround compatible output. Select the STEREO to activate simple stereo mode.

DOLBY DIGITAL SETUP

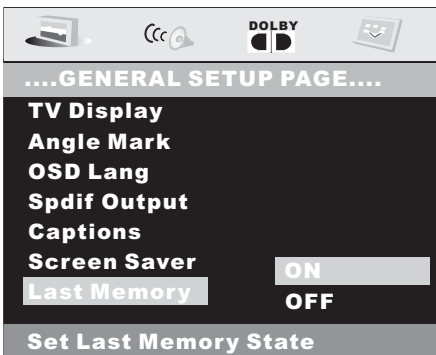

7. LAST MEMORY SETUP

Select the LAST MEMORY output
ON/OFF.

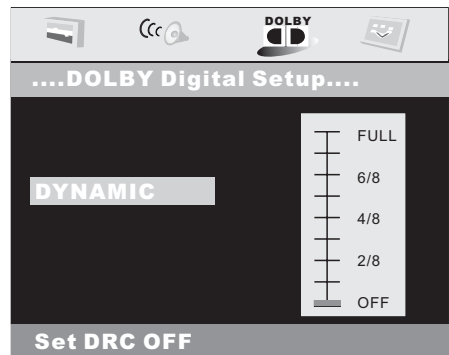

DYNAMIC RANGE CONTROL

Select DRC and adjust the dynamic range of a Doby Digital encoded program. There are 8 steps between full compression and off compression.

Setup

--- PREFERENCES PAGE ---

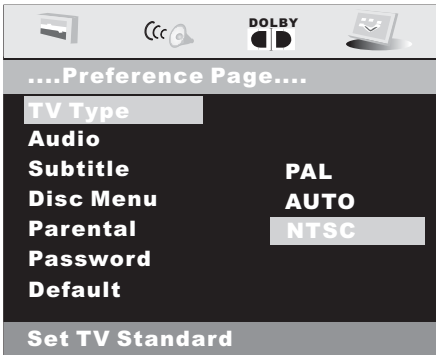

1. TV TYPE SETUP

This player can play discs recorded in either PAL or NTSC format. Select NTSC format, when you connected to NTSC TV. Select PAL format, when you connected to PAL TV. Select AUTO format, the player TV output format will according to the DVD disc format .

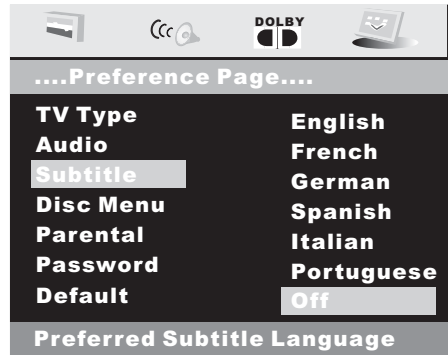

3. SUBTITLE LANGUAGE SETUP

Select the preferred SUBTITLE language by using the cursor buttons.

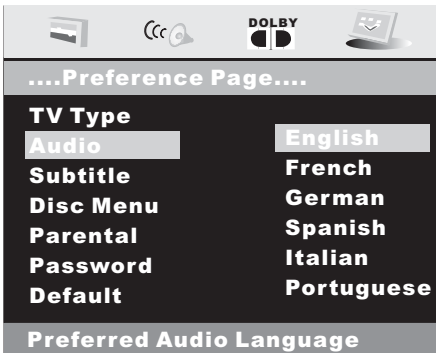

2. AUDIO LANGUAGE SETUP

Select the preferred AUDIO sound-track by using the cursor buttons.

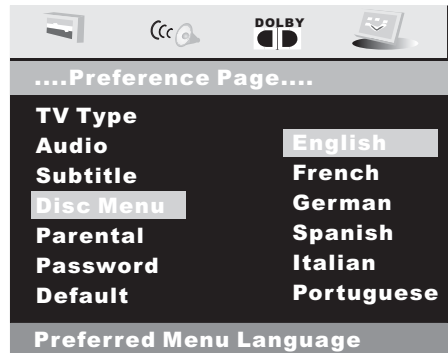

4. DISC MENU LANGUAGE SETUP

Select the preferred DISC MENU language by using the cursor buttons.

Setup

--- PREFERENCES PAGE ---

Age control

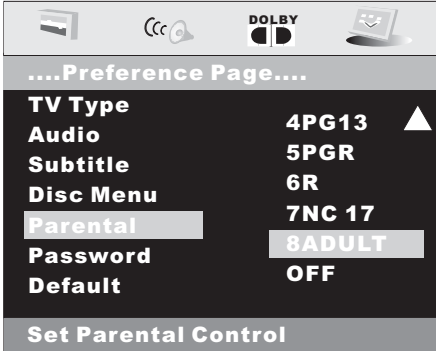

5. PARENTAL

Select suitable parental guidance by the cursor buttons and conformed by pressing ENTER button.

7. DEFAULTS

Select reset to become factory initial setting.

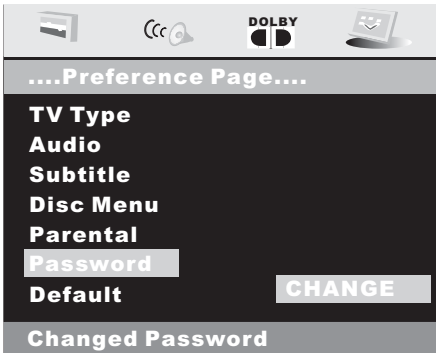

6. PASSWORD

Select the change and press ENTER button. Type the old password (The initial factory code is **1379**) and key in 4 characters password now you want to use, and retype again to confirm key in correctly.

DEFAULTS TABLE

GENERAL SETUP	TV DISPLAY	NORMAL/LB
	ANGLE MARK	ON
	OSD LANGUAGE	ENGLISH
	SPDIF OUPUT	SPDIF/RAM
	CAPTIONS	ON
	SCR SAVER	ON
	LAST MEMORY	ON
SPEAKER SETUP	DOWNMIX	STEREO
DOLBY DIGITAL	DYNAMIC	OFF
PREFERENCES	TV TYPE	AUTO
	AUDIO	ENGLISH
	SUBTITLE	OFF
	DISC MENU	ENGLISH
	PARENTAL	8 ADULT
	PASSWORD	1379

Other Main Operation

USB Operation

Following the diagram below, connect your USB device to the front panel USB port . If it is properly connected, the device will be mounted and start playing automatically.

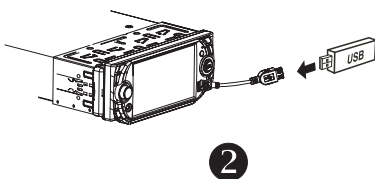
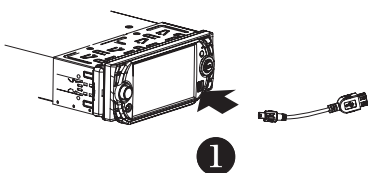

you can also select the desired item of the USB device . The buttons on the remote control, on the device, have the same functions as the touch buttons of this touch screen have .

In USB Playback mode

Use the UP, DOWN, RIGHT or LEFT buttons to navigate to and select files to play, and press ENTER to begin playback (or viewing, in the case of JPEG files). To skip to the next or last track, touch or press the ►► or ◀◀. Press the ►► or ◀◀ buttons for Fast Forward or Fast Reverse playback. **REPEAT** play modes are also available by repeatedly pushing **REPEAT** until the desired mode is found.

Changing From DISC to USB Playback Modes

If the disc present in the player is an MP3 disc, touch ■ section on screen or press the STOP on remote once then touch or press the GOTO to USB playback.

If the disc present in the player is an DVD or VCD or CD disc, touch ■ on the screen or press STOP twice on the remote then touch GOTO section on the screen or press the GOTO button on the remote to USB playback.

Changing From USB to DISC Playback Modes

If you are in USB Playback mode and wish to begin playback of a disc already in the player, touch the ■ range on the touch screen or press the STOP on the remote once. Then touch GOTO range on the screen or press the GOTO on the remote and the player will switch to DVD/VCD/CD/MP3 Playback mode.

Important Note:

To prevent damage to the USB device, do not remove or disconnect it during playback. it is also a good practice to remove the USB drive during disc playback.

Other Main Operation

MP3/WMA/JPEG/MPEG4 DISC PLAY

When you insert a disc which contains MP3, WMA or JPEG files, the different file types are detected, and a list of the files are produced, as shown in the diagram below.

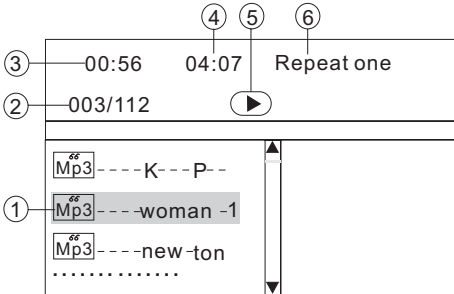

- ①. Current track(file)(highlighted bar)
- ②. Current track (file) number/total number of tracks(files) in the current folder.
- ③. Elapsed playing time of the current track(not available for JPEG disc)
- ④. total playing time.(not available for JPEG disc)
- ⑤. Operation mode icon. ▶ (Play), ■ (stop), || (pause), ►► (forward) ◀◀(reverse).
- ⑥. Selected playback mode

Touch the screen, it will display the following as below :
(when the parking brake is applied .)

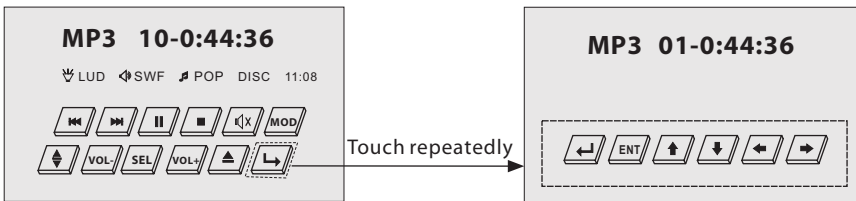

Touch the ↑ / ↓ / ← / → sections on touch screen (or Use ▲ / ▼ / ► / ◀ on remote control) to select the item or folder, then touch the ENT section (or press ENTER button on remote) to confirm.

Touch the RPT on the touch screen (or Pressing REPEAT button on the remote) repeatedly can select two kinds of repeat play mode.

REP-ONE:

Play the same song over and over again.

REP ALL:

Play all songs in the discover and over again.

Moving To Another Track :

1. Touch the ►► or ◀◀ section to skip a track ahead or back.
2. Swing the SEL knob in the direction ▲ or ▼ button to skip a track ahead or back.

Fast Forward/Fast Backward

1. Touch longer (more than 2's) the " ►►/◀◀ " range for fast forward or fast backward .
2. Swing and hold (more than 2's) the SEL knob in the direction ▲ or ▼ button for forward or backward .

Specification

Supply Voltage:	12V DC (11V-15V)
Current Consumption:	Less than 10 A
Signal System:	Compositive video 1.0Vp-p 75 Ω
Power Output:	80W x 4
Discs Played:	(1)DVD-VIDEO Disc 5"(12 cm) single-sided, single-layer 5"(12 cm) single-sided, double-layer (2)Compact Disc (CD-DA, VIDEO CD) 5"(12cm) disc
Audio Signal Output:	5-Channel RCA Output (Front & Rear + 1-Subwoofer)
Characteristics:	(1)Frequency Response 20 Hz - 20 KHz (2)S/N Ratio 90 dB (JIS) (3)Wow and Flutter Below measurable limits

RADIO Section:

	For 3 Bands (Europe)	For 2 Bands (Europe)	For 2 Bands (U.S.A.)
Frequency Coverage:	87.5 to 108 MHz	87.5 to 108 MHz	87.5 to 107.9 MHz
IF:	10.7 MHz	10.7 MHz	10.7 MHz
Sensitivity (S/N = 30 dB):	15 dBu MW	15 dBu MW	15 dBu AM
Frequency Coverage:	522 to 1620 KHz	522 to 1620 KHz	530 to 1710 KHz
IF:	450 KHz	450 KHz	450 KHz
Sensitivity (S/N = 20 dB):	40 dBu	40 dBu	40 dBu

TFT Monitor:

Monitor Screen Size:	5 Inch Wide
Number of Pixels:	1440 X 234 pixels
Color System:	NTSC/PAL

NOTE: Specifications and design are subject to modification, without notice, due to improvements in technology.

Trouble Shooting

Before going through the check list, check wiring connection. If any of the problems persist after check list has been made, consult your nearest service dealer.

SYMPTOM	CAUSE	SOLUTION
No power	The car ignition switch is not on	If the power supply is properly connected to the car accessory terminal, switch the ignition key to "ACC"
	The fuse is blown	Replace the fuse
Disc can not be loaded or ejected	Presence of disc inside the player.	Remove the disc in the player, then put a new one
	Inserting the disc in reverse direction	Insert the compact disc with the label facing upward
	The disc is extremely dirty or defective	Clean the disc or try to play a new one
	Temperature inside the car is too high	Cool off or until the ambient temperature return to normal
Television/video image appears black-white	The color system is set incorrectly	Please switch to correct color system from menu
No television/video image appears	The unit is not connected to the parking brake detection switch	Make proper connection according to "wire connection"
	The parking brake is not engaged	For safety reasons no television /video images are displayed while the vehicle is moving. Engaging the parking brake will cause images to be displayed.
No color in picture	The disc format is not according to the TV-set used (PAL/NTSC)	Please the television mode of the choice accommodation
JPEG disc can not be played back	No JPEG files are recorded on the disc.	Change the disc
	JPEG files are not recorded in a compliant format	Change the disc Record JPEG files using a compliant application
The operation keys do not work	The built-in microcomputer is not operating properly due to noise	Press the RESET button. Front panel is not properly fixed into its place
The radio does not work	The antenna cable is not connected	Insert the antenna cable firmly
	The signals are too weak	Select a station manually