



BV8855T

Contents

**In-Dash AM/FM-RDS
DVD/MP3/CD Receiver With
6.2" Widescreen Touchscreen TFT Monitor
With Built - In TV tuner and USB Port
SD/MMC Card Slot**

Precautions	2	Selecting Subtitles	27
Safety Information	3	Selecting multi-angle views	27
Disc Notes	4	Title menu function	27
Installation	5	Setup	28
Detaching the control panel	7	General Setup	28
Changing the control panel	8	Speaker Setup	30
Electric Connection	9	Dolby Digital Setup	30
Remote Control	10	Preferences Setup	31
Control Panel	13	Defaults Table	32
Touch Panel.....	13	Other Main Operations	33
Unit Keys	14	USB Operations	33
Basic Operations	16	TV Operations	33
TFT Monitor Adjustment	17	SD/MMC Card Operations	35
Rear View Camera	17	MP3/WMA/JPEG Play	36
Audio Quality Adjustments	17	MPEG4 Play	36
Setting Audio Mode	18	Specifications	37
Reset Factory Settings	18	Trouble Shooting	38
Radio Operations	19		
Listening to the radio	19		
Storing stations in memory	19		
Listening to a preset station	20		
RDS Function	20		
DISC Operations	22		
Basic Operations	22		
Select Playback Mode	24		
AUX Operation	25		
On-Screen Disc Operations	26		
DISC Special Functions	27		
Selecting audio languages	27		

Precautions

THANK YOU FOR PURCHASING THIS CAR DVD PLAYER .

Before operating the unit, read this manual thoroughly and keep it handy for future reference .

To avoid injury or accident , read the following precautions before installing and operating the unit .

ON INSTALLATION

- DO NOT install any receiver in locations where;
 - it may obstruct the steering wheel and gearshift lever operations, as this may result in a traffic accident.
 - it may obstruct the operation of safety devices such as air bags, as this may result in a fatal accident.
 - it may obstruct visibility.
- DO NOT operate any receiver while manipulating the steering wheel, as this may result in a traffic accident.
- The driver must not watch the monitor while driving.
- IF THE DRIVER watches the monitor while driving, it may lead to carelessness and cause an accident.
- IF YOU NEED to operate the receive while driving, be sure to look ahead carefully or you may be involved in a traffic accident.
- IF THE PARKING BRAKE is not engaged. “ ParkingBrake ” flashes on the monitor, and no playback picture will be shown.
 - This warning appears only when the parking brake wire is connected to the parking brake system built in the car (refer to the electric connection)

ABOUT THE LIQUID CRYSTAL DISPLAY (LCD) PANEL

Do not press on the LCD panel on the unit as doing so can distort the picture or cause a malfunction . The picture may become unclear , or the LCD panel may be damaged .

NOTES ON CLEANING

-Clean the LCD panel with a slightly damp soft cloth.

-Do not use solvents such as benzine, thinner, commercially available cleaners or antistatic spray .

-Do not use alcohol to clean the screen .

If your car was parked in a cold or hot place, the picture may not be clear . The monitor is not damaged . The picture will become clear the temperature in your car becomes normal .

Safety Information

CAUTION:

THIS DVD PLAYER IS A CLASS I LASER PRODUCT. HOWEVER THIS DVD PLAYER USES A VISIBLE/INVISIBLE LASER BEAM WHICH COULD CAUSE . HAZARDOUS RADIATION EXPOSURE IF DIRECTED. BE SURE TO OPERATE THE DVD PLAYER CORRECTLY AS INSTRUCTED.

USE OF CONTROLS OR ADJUSTMENTS OR PERFORMANCE OF PROCEDURES OTHER THAN THOSE SPECIFIED HEREIN MAY RESULT IN HAZARDOUS RADIATION EXPOSURE. DO NOT OPEN COVERS AND DO NOT REPAIR YOURSELF. REFER SERVICING TO QUALIFIED PERSONNEL.

WARNING:

TO REDUCE THE RISK OF FIRE OR ELECTRIC SHOCK, DO NOT EXPOSE THIS EQUIPMENT TO RAIN OR MOISTURE.

TO REDUCE THE RISK OF FIRE OR ELECTRIC SHOCK, AND ANNOYING INTERFERENCE, USE ONLY THE RECOMMENDED ACCESSORIES.

THIS DEVICE IS INTENDED FOR CONTINUOUS OPERATION.

COPYRIGHT PROTECTION





This product incorporates copyright protection technology that is protected by method claims of certain U.S. Patents and other intellectual property rights owned by Macrovision Corporation and other rights owners. Use of this copyright protection technology must be authorized by Macro vision Corporation, and is intended for home and other limited viewing uses only unless otherwise authorized by Macrovision Corporation. Reverse engineering or disassembly is prohibited.

REGION MANAGEMENT INFORMATION:

This DVD Player is designed and manufactured to respond to the Region Management Information that is recorded on a DVD disc. If the Region number described on the DVD disc does not correspond to the Region number of this DVD Player, this DVD Player cannot play this disc.

Disc Notes

Disc formats supported by this player

DVD		Audio and Video Disc size 12 cm
VCD		Audio and Video Disc size 12 cm
CD		Audio Disc size 12 cm
MP3		Audio Disc size 12 cm

Discs which cannot be played with this player

- DVD-RAM
- CDV
- CDG

Handling and Cleaning

- Dirt, dust, scratches and warping disc will cause misoperation.
- Do not place stickers or make scratches on discs.
- Do not warp discs.
- A disc should always be kept in its case when not in use to prevent from damaging.
- Do not place discs in the following places:
 1. Direct sunlight
 2. Dirty, dusty and damp areas
 3. Near car heaters
 4. On the seats or dashboard

Disc Cleaning

Use a dry soft cloth to wipe the surface. If the disc is quite dirty, use a soft cloth slightly moistured with isopropyl (rubbing) alcohol. Never use solvents such as benzine, thinner or conventional record cleaners as they may mar the surface of the disc.

Note:

A disc may become somewhat scratched (although not enough to make it

unusable) depending on your handle it and conditions in the usage environment. Note these scratches are not an indication of any problem with the player.

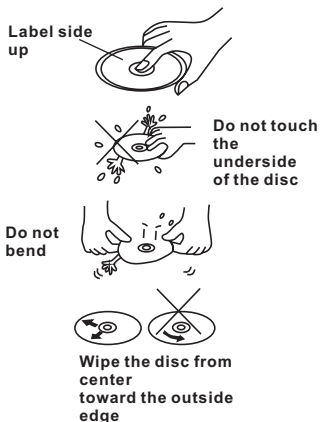

Preparing New Discs with Rough Spots

A new disc may have rough edges on its inside and outside edges. If a disc with rough edges is used, the proper setting will not be performed and the player will not play the disc. Therefore, remove the rough edges in advance by using a ball point pen or pencil as shown on the right. To remove the rough edges, press the side of the pen or pencil against the inside and outside edges of the disc.

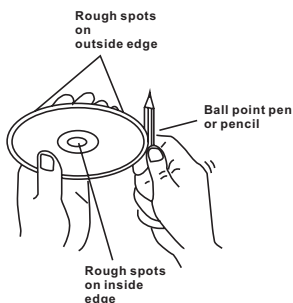

Installation

NOTES:

1. Choose the mounting location where the unit will not interfere with the normal driving function of the driver.
2. Before finally installing the unit, connect the wiring temporarily and make sure it is all connected up properly and the unit and the system work properly.
3. Use only the parts included with the unit to ensure proper installation. The use of unauthorized parts can cause malfunctions.
4. Consult with your nearest dealer if installation requires the drilling of holes or other modifications of the vehicle.
5. Install the unit where it does not get in the driver's way and cannot injure the passenger if there is a sudden stop, like an emergency stop.
6. Avoid installing the unit where it would be subject to high temperature, such as from direct sunlight, or from hot air, from the heater, or where it would be subject to dust, dirt or excessive vibration.
7. If installation angle exceeds 30° from horizontal, the unit might not give its optimum performance.

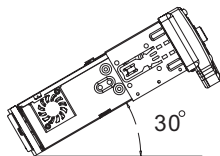

DIN FRONT/REAR-MOUNT

This unit can be properly installed either from "Front"(conventional DIN Front-mount) or "Rear"(DIN Rear-mount installation, utilizing threaded screw holes at the sides of the unit chassis). For details, refer to the following illustrated installation methods.

Revoving the unit

1

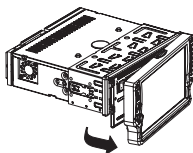

1. Press the **REL** button to release the front panel .

2

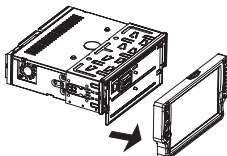

2. Remove the control panel .

Installation

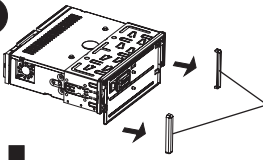
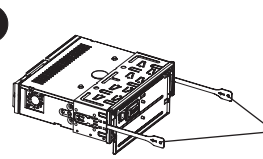
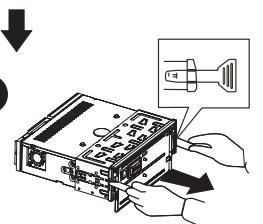
- 3**  3. Remove the PLASTIC COVER of the both sides away
- 4**  4. Insert the two KEY PLAT into the grooves at both sides of the unit as shown in figure until they click .
- 5**  5. Pulling the levers makes it possible to remove the unit from the dashboard .

Installation the unit

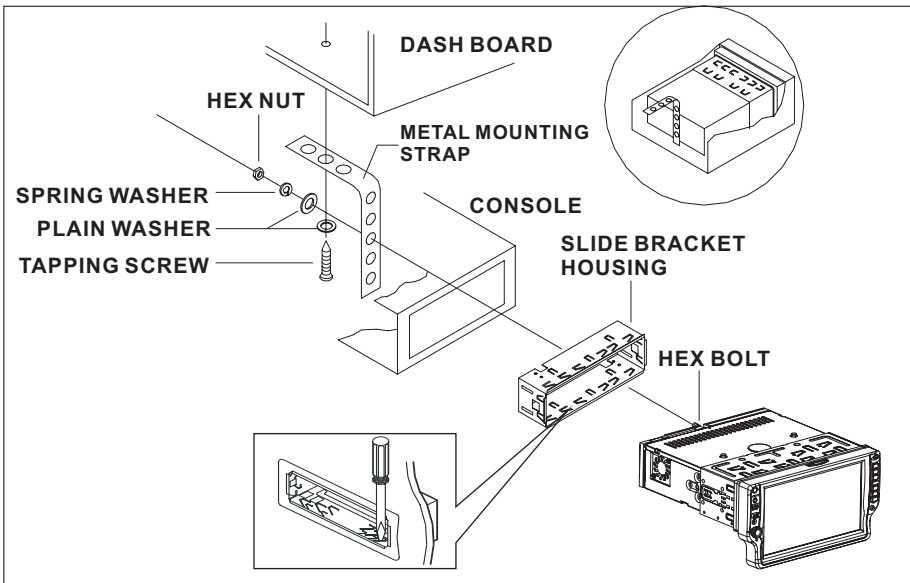

Installation

How To Remove And Install The Front Panel

When detaching or attaching the control panel, be careful not to damage the connectors on the back of the control panel and on the panel holder.

Detaching The Front Panel

Before detaching the control panel, be sure to turn off the power.

1). Press the “REL” release button and the left hand side of front panel will release.

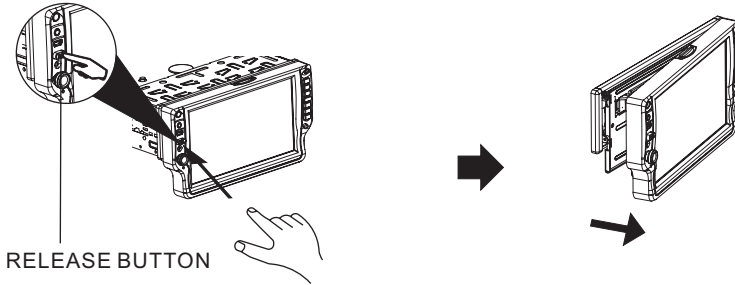

2). Pull-off the front panel and keep the front panel into the case .

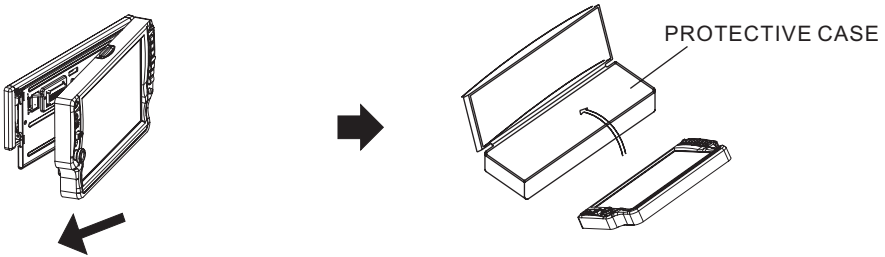

Attaching The Front Panel

1). First insert the right hand side of the front panel into the hollow of the unit .

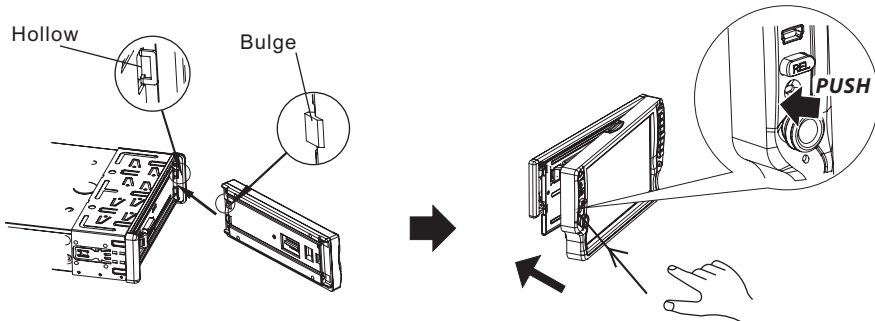

(NOTE : the “bulge” point on the panel must be attached into the hollow of the unit .)

2). Gently push the left hand side of the front panel until you feel a “Click” .



Panel Angle Adjustment

CHANGING THE CONTROL PANEL ANGLE

When you want to change the viewing angle of the operating unit to play, you can touch the  section on touch screen (or press the  button on the front panel) repeatedly to select the desired angle as follows:

ANGLE 1 - ANGLE 2 - ANGLE 3 - ANGLE 4 - ANGLE 1 .

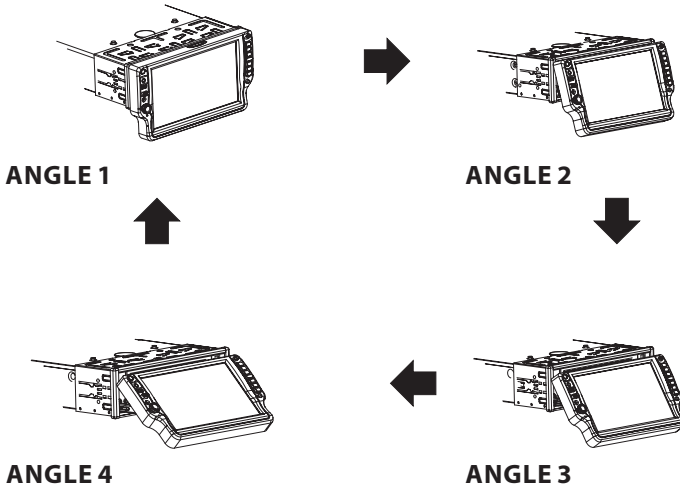

Caution:

Do not insert your finger behind the control panel.

Electric Connection

WIRING CONNECTION

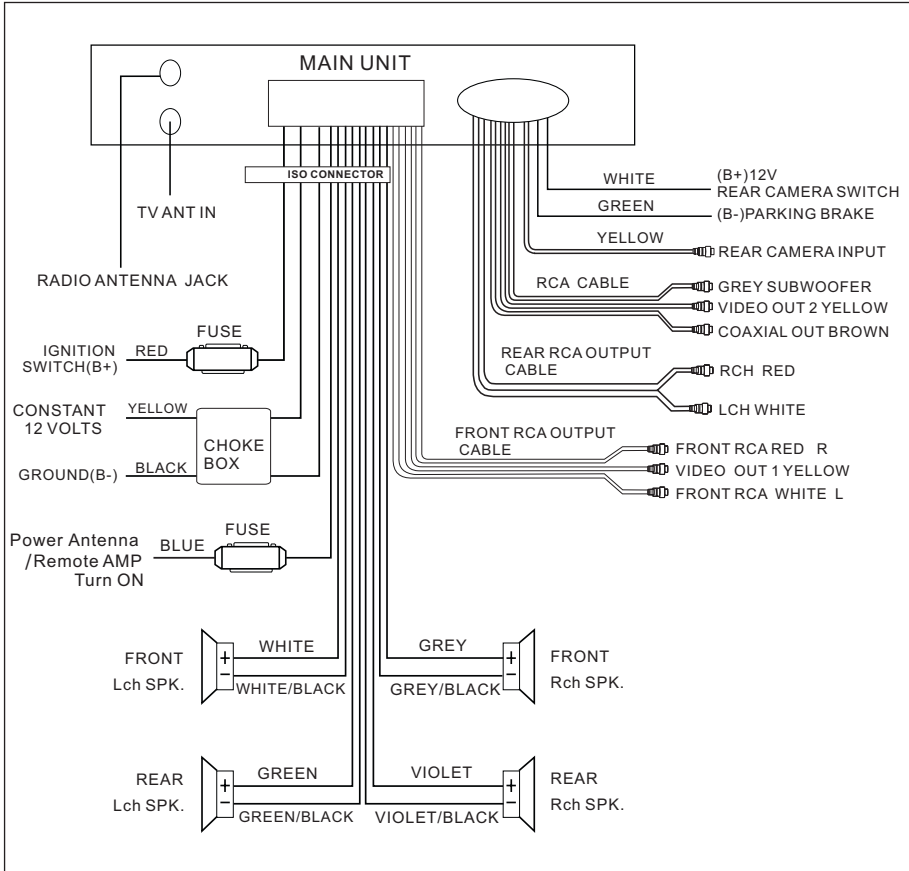

Note :

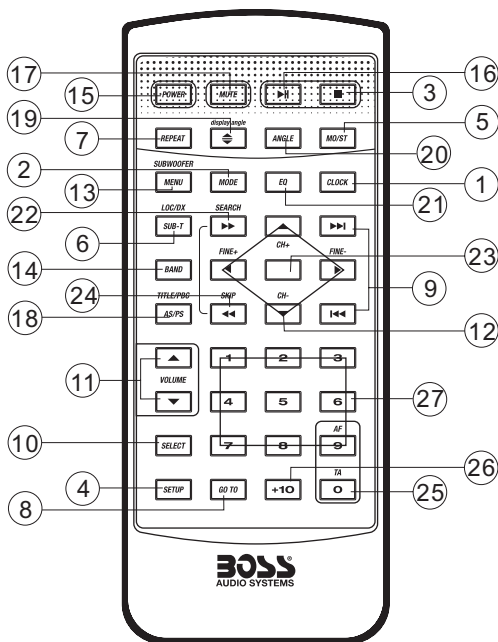

The "PARKING BRAKE" wire must be connected to the parking brake system of your car. When the parking brake is engaged, the LCD screen will be allowed to view your video. If not, the screen will produce an image saying, "PARKING BRAKE" This is a safety feature designed for the driver not to watch a video while driving. The video output on this unit is not affected by this.

Remote Control



Ref #	Button	Function
1	CLOCK	Press it briefly to view the clock time , Press again to return to normal display mode . Press longer to set the time .
2	MODE	Press repeatedly to cycle through the various modes: RADIO > DISC > AUX IN.
3	STOP	Press once to pause playback. Press PLAY/PAUSE to resume playback. Please note: if you press STOP twice, playback will start at the beginning of the disc.
4	SETUP	Press this button to open the SETUP menu.
5	MO/ST (AUDIO)	In Radio mode, press this button to change between Mono and Stereo reception modes (when a station is weak, sometimes switching to Mono will improve sound quality). In Disc Playback mode, pressing this button opens the AUDIO setup menu for making changes to the way the soundtrack is reproduced.
6	SUBTITLE LOCAL/DISTANT	In DVD Disc Playback mode, pressing this button will allow you to change the subtitle language on discs which have this as an option. In Radio mode, press this button to change the radio reception sensitivity in stations are near or far.
7	REPEAT	Pressing this button will open a menu presenting you with the playback repeat options available for that kind of disc.

Remote Control

Ref #	Button	Function
8	GOTO	Press it button to begin playback at a moment in the program you designate. Use number buttons to enter the data that is needed.
9	▶▶ / ◀◀	Press these buttons to skip ahead or back one track. (Note: In DVD mode, press continually the ◀◀ twice to skip back one)
10	SEL	Press this button repeatedly to cycle through the various audio and video adjustments you can make: Volume, Bass, Treble, Balance, Fader, Color, Brightness, Contrast and Tint.
11	VOL+/-	Use these controls to adjust the volume level.
12	◀ / ▶ / ▲ / ▼	Press to navigate the various menus present in the product.
13	Menu SubWoofers ()	Press this button briefly to display the root level directory of a DVD disc. Press and hold this button to turn on or off the SUBWOOFER output.
14	BAND (OSD)	In Radio mode, press this button repeatedly to switch between the five radio bands: FM1 > FM2 > FM3 > AM1 > AM2. In Disc Playback modes, Press this button to see information about the disc currently in play.
15	 (POWER)	Press this button to turn the unit ON , press and hold to turn the unit OFF.
16	PLAY/ PAUSE	In Disc Playback mode, press to pause playback. Press again to start where playback stopped.
17	MUTE	Press this button to turn off the audio. Press again to restore the sound to its prior volume level.
18	TITLE/ PBC(A/P)	When playing a DVD, pressing this button will open the TITLE menu which is recorded on the DVD. When playing a VCD disc, press this button to create a PBC (Playback Control) menu for the disc to assist in making playback selections. In Radio mode, press and hold this button to start the Auto-Program mode, during which the tuner will scan for all strong stations and assign them to the radio preset buttons.
19		Press this button to adjust the screen viewing angle (see page 8).
20	ANGLE	For DVD discs which have alternate viewing angles encoded, when you see the "angle mark" symbol advising you that these angles are available, press this button to see them.
21	EQ	Press repeatedly to cycle through the different equalizer curve presets you may wish to use for enhanced listening.
22	SEARCH ▶▶	In Disc Playback mode, press for fast forward playback. In TV mode, press to cause the tuner to search for the next channel on the TV band.

Remote Control

Ref #	Button	Function
23	ENTER	This button is used to confirm selections and settings within many of the menus in the OSD system.
24	SKIP ◀◀	In Disc Playback mode, press for fast reverse playback. In TV mode, press to add or delete a channel from the stored channel list.
25	0-9	These buttons are used for numeric entry in many different menus. In addition, in Radio Mode (when RDS is engaged), 0 serves as the TA button and 9 serves as the AF button.
26	+10	This button is used with the other number buttons for use with two-digit number entries.
27	1-6	Six numbered preset buttons store and recall stations for each band.

Preparing the Remote Control

Inserting the Battery

1. First push to inside as the direction indicated by the arrow (See ①) And then Remove the battery holder as the direction indicated by the arrow (See ②).
2. Replace the battery Set a new battery property with (+)side up as illustrated (See ③).
3. Insert the battery holder. Push in the holder to the original position(See ④).

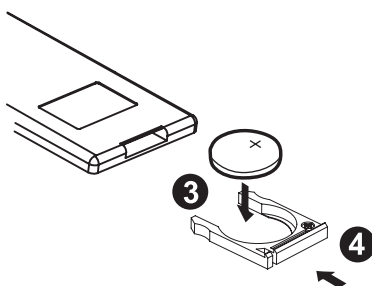
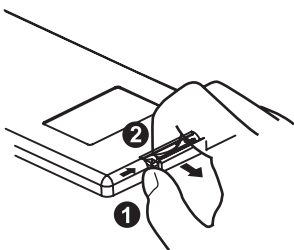

Using the Remote Control

Face the remote control towards the player front face IR mark (remote control signal receiver).

Operation angle: About ± 30 degree in each the direction of the front of the IR mark.

Note :

The lithium cell in the battery compartment of remote control has been secured for transport with a foil . Before initial use please remove this foil so that the remote control is ready for operation .







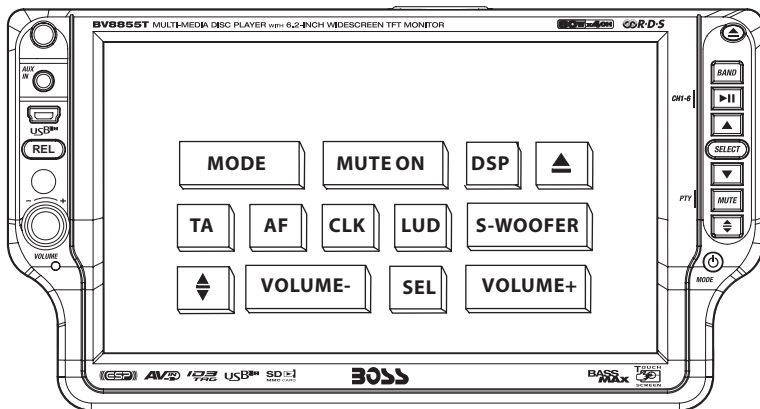





Control Panel

Key Functions

Touch Panel



Touch Screen Key :

	Operating mode selection		Touch briefly show/hide clock, touch longer to set the clock .
	To switch of the sound		Loudness Function
	Select EQ function		Subwoofer Function
	Loading and ejecting the DVD/CD		Changing the viewing angle of the operating unit
	Turning pre-switching for traffic announcements ON and OFF . (Only for RDS)		Decrease the volume level
	Switch ON and OFF and alternative frequency . (Only for RDS)		Select the menu of the Picture/Sound
			Increase the volume level

Control Panel

Unit Keys :

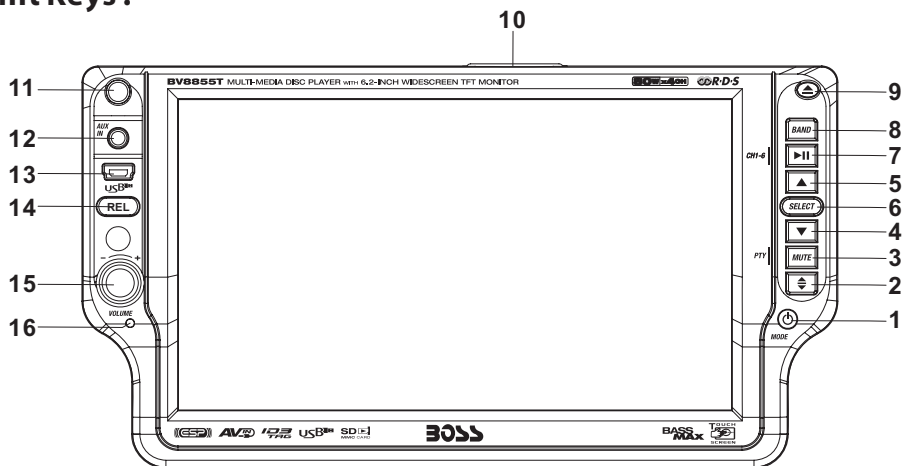

1 (POWER On/Off)/MODE BUTTON

Press this button to switch the device on. WELCOME appears in the display. Press it again to switch the device off. SEE YOU appears in the display. In playback mode, you can use the button to select the input mode by pressing repeatedly until the proper one is found :
DISC > AUX IN > RADIO > TV .

2 ANGLE (Screen position)

Press this button repeatedly to cycle through the different positions.



3 MUTE/PTY BUTTON



Press this button briefly to select the MUTE or NOT .



In Radio Mode, press this button and hold for a bout 2 seconds to select the **PTY** of the program type (examples of such types of program are : **NEWS, POP.....**)

4/5 / BUTTONS (TUNE, SEEK, TRACK, SKIP UP/DOWN)

A) In DISC, USB mode:

if you wish to jump forwards or backwards press briefly the  /  button .
 (Note: in DVD mode, press the  button continually twice to skip back one track during playback.)

Note: For some VCD 2.0 discs (PBC-playback control),  and  buttons may be unavailable.

To go through the tracks , press longer (for more than 2's) the  /  button , FF X2 appears in the display. Press it again, the speed of rapid forward/ reverse changes according to the disc as follow:

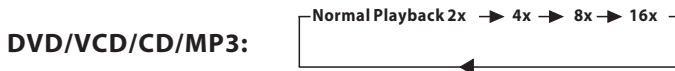

Control Panel

- B) **In Radio Mode:**
Press briefly the ▲ or ▼ button in order to set a radio station manually. press longer (for more than 2's) the ▲ or ▼ button in order to start the search for a radio station automatically.

6 SELECT BUTTON

To access the available adjustment settings for audio and video, press this knob repeatedly to cycle through and select them:

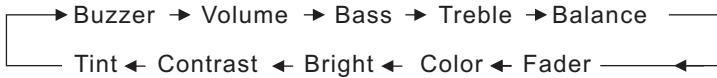

7 ► /CH 1-6 (RADIO PRESET)BUTTON

- A) **In Disc Playback Mode**
Press this button to pause playback, press it again to resume playback.
- B) **In Radio Mode**
Press this button repeatedly to preset station. (refer to see page 20 .)

8 BAND BUTTON

In Radio mode, press it repeatedly to select the desired radio band: FM1, FM2, FM3, AM1(MW1), AM2(MW2) .

9 ▲ (EJECT) BUTTON

Press it button to eject the DISC or insert the DISC to start play .

10 SD/MMC card slot

11 IR sensor

12 AUX Input JACK

For information about connecting a AUX device, please see page 25 .

13 USB PORT

For information about connecting a USB device, please see page 33.

14 REL BUTTON

Press this button to release the front panel for removal . Refer to see page 7.

15 VOL+/VOL- KNOB

In normal mode, this knob is used to increase or decrease the volume. It is also used as an UP/DOWN knob when audio or video settings are being adjusted when accessed using the SELECT button.

16 RESET BUTTON

Press this button to return to factory settings .

Basic Operation

POWER On/Off



Press it to switch the device ON, press and hold about 2 seconds to switch the device OFF.

Ejecting The Disc



Use your finger to touch the ▲ range on touch screen, the control panel of the unit will swing downwards. Then you can insert the disc or eject the disc. (You can also press the ▲ button on the front panel to eject the disc or insert the disc to start play.)

Select Sources



Touch repeatedly the MOD section on the screen, the signals will display in the screen as follow :



Volume Adjusting

Volume button



Revolve : clockwise to increase /

Anticlockwise to decrease .

Touch screen



Touch the screen the VOLUME+ to increase the volume level .



Touch the screen the VOLUME- to decrease the volume level .



Mute Function



Touch “MUTE ON” range, it will mute the sound but the disc continues playing . Touch it again to resume .

Setting The Clock



Touch briefly the “CLK” range to show/hide the clock . Touch hold for more than 2's the hour will flash ,use the VOL+/- to adjust .Touch it again, the minute will flash, then use the VOL+/- to adjust .

Setting The Buzzer ON/OFF



Repeatedly touch “SEL” range to select the **BUZZER** item, and the use the VOL+/- to switch the **BUZZER ON/OFF** .

Setting the Background Color



In radio mode, repeatedly touch the “SEL” range to select the “wallpaper” item, and then use the VOL+/- to select the background color among of the “**wallpaper AUTO, wallpaper: 01 wallpaper: 11**”, in the “**AUTO**” mode, the monitor of unit will change the background color automatically .

Basic Operation

TFT Monitor Adjustment



During DISC playback, use your finger to touch briefly the SEL section on the screen (or press SEL button on front panel)



to access the Picture mode selection menu, by repeatedly touch the SEL section, and then touch the VOL+/- (or rotate the VOL+/-) to adjust the selected mode .

(The corresponding value will show on the monitor)

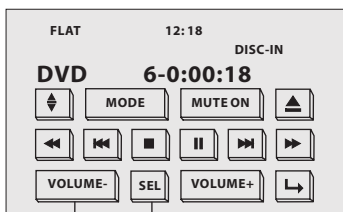
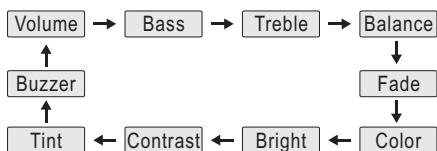

touch to select

touch to adjust

ADJUSTABLE ITEMS:

COLOR: 0 to 32

Adjust the color for the picture-lighter or darker.

BRIGHT: 0 to 32

Adjust if the picture is too bright or too dark.

CONTRAST: 0 to 32

Adjust the contrast of the bright and dark portion.

TINT: 0 to 32

Adjust the tint if the human skin color is unnatural.

-Adjustable when "NTSC " is selected for "NTSC/PAL " .

Rear View Camera

When connecting the rear view camera, the mirror image of the rear view through the rear view camera is automatically displayed on the monitor when you change the gear to the back position. (The monitor on the unit only.)

Audio Quality Adjustment



During DISC playback, use your finger to touch briefly the SEL section on the screen (or press SEL button on the front panel)



to access the Sound mode selection menu, by repeatedly touch the SEL section, and then touch the vol+/- (or rotate the vol+/-) to adjust the selected mode . (The corresponding value will show on the monitor)

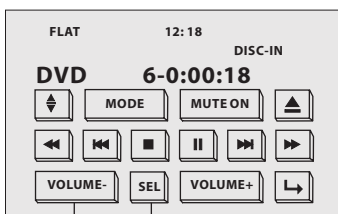
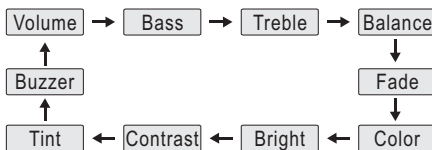

touch to select

touch to adjust

ADJUSTABLE ITEMS:

Volume: 0 to 32

Adjust volume level by using VOL + / - .

Bass: -14 to +14

Adjust bass level by using VOL + / - .

Treble: -14 to +14

Adjust treble level by using VOL + / - .

Basic Operation

Balance: R 0-10 to L 0-10 .

Adjust sound balance between left and right speakers by using VOL + / - .

Fader: F 0-10 to R 0-10 .

Adjust sound balance between front and rear speakers by using VOL + / VOL - .

Setting Audio Modes

DSP Touch the screen the DSP range (or press the EQ button on the remote control) to select one of the preset sound modes .

(Rock/Pop/Jazz/Classic/Flat) .

The information will display in the monitor as follow :

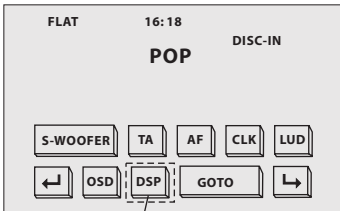
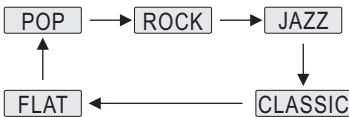

touch to select

It`s depend on your habit to select the Audio mode .

Reset Factory Settings

RESET button is placed on the housing and must be activated with either a ballpoint pen or thin metal object.



The RESET button is to be activated for the following reasons:

- A. Initial installation of the unit when all wiring is completed.
- B. All the function buttons do not operate.
- C. Error symbol on the display.

USA/EURO FREQUENCY SWITCH

On the right of this device, there is a USA/EURO frequency switch, you can select the desired radio frequency before installing .

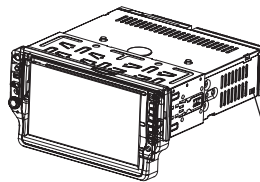

USA/EURO Frequency Switch (radio frequency switch for selecting between the USA and EUROPE frequency band.)

Radio Operation

Listening to the Radio

Switching To Radio Mode

 Touch the screen of “**MODE**” range (or press the MOD button on the front panel) repeatedly to select the RADIO mode. the following information will appears as below:

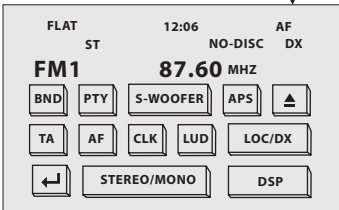
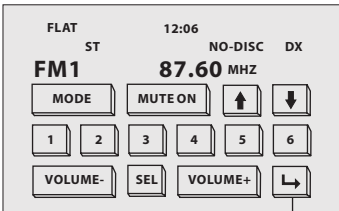

 Touch “  ” to next .

 Touch “  ” to previous .





Selecting The Frequency Band

 Touch the screen of “**BND**” section (or press the **BND** on the front panel) repeatedly to select the band , the message will show in turn :







Start Searching For a Station

Manual Search

During Radio mode, briefly touch the screen of “  ” section or press the “  ” on front panel to increase frequency by one step of channel spacing . Briefly touch the “  ” section or press the “  ” button on the front panel to decrease frequency by one step of channel spacing .

Automatic Search

During Radio mode, touch and hold (for more than 2's) the screen of “  /  ” section or press longer the “  /  ” on the front panel to start search for a radio station automatically .

When an FM stereo broadcast is hard to receive

Touch the “**STEREO/MONO**” section on touch screen (or press **ST/MO** button on the remote control) to select the MONO or STEREO mode . (When Stereo mode is activated, the ST symbol will appear .)

To tune in strong-singnal FM Station only (LO/DX function)

Touch the “**LOC/DX**” range on the touch screen (or press LO/DX button on the remote control) to select the LOCAL or DX mode . (You can choose between the LOCAL and DX(DISTANCE) mode for local or long-distance traffic news .)

Radio Operation

Storing Stations In Memory

Setting Memory

Press the "FM/CH 1-6" button repeatedly on the front panel to preset stations at radio mode. (Or touch the screen the 1-6 sections)

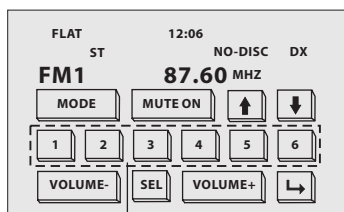

Touch to preset station

With this system, a total of 30 stations can be stored in the memory of six preset stations. Each band stores up to six preset stations. The stations might be FM1, FM2, FM3, AM1(MW1), and AM2(MW2) band.

The operation is as below :

-Store in Memory

Touch and keep the 1-6 sections (or press and hold the FM/CH 1-6) for about 2 seconds, the current listening station will be stored into the number location .

-Retrieve a preset station

Touch the 1-6 sections briefly (or press the FM/CH 1-6 button repeatedly) to retrieve a station which had been stored in the memory in advance the chose number is shown on display .

Automatic Memory Storing & Program Scanning

Automatic Preset Setup

 In Radio Mode, Touch and keep the APS section on the touch screen for about 2 seconds to active

automatic station storage. The radio searches within the current frequency band, e.g. FM1, for the stronger signal level until the search cycle is finished . The six strongest stations are then allocated to the corresponding storage locations . Then the station of the first storage location is set .

Scan Function

 In Radio mode, briefly touch the APS section on the touch screen , the radio briefly plays all the preset stations of the frequency band .

RDS FUNCTION

 In Radio mode, touch it to select the desired item, it will display the following as below :

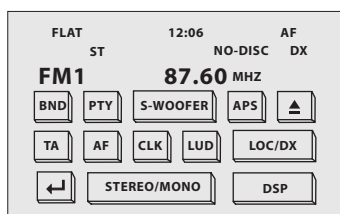

TA Traffic Announcement

(Priority For Traffic Information)

 In Radio mode, touch briefly the screen of "TA" range to activate the TA function.

Touch it again to turn off the TA function . When the TA function is activated, the TA symbol appears in the display . During radio operation in one FM frequency band the search for a traffic announcement station is started automatically (TA SEEK) . If an FM station is being received which transmits the latest traffic announcements from time to time, the TP display lights up .

Radio Operation

When the TA function is switched on , the FM traffic automatically interrupt CD operation(the word TRAFFIC appears in the display).

The volume level is increased to the minimum value for the transmission of traffic announcements.

After the traffic announcements has finished, the program that was previously running is resumed.

Interruption of the TA Function: if you would like to interrupt the current traffic announcement, touch the TA section on screen briefly . This does switch off the TA mode .

AF FUNCTION

(Alternative Frequencies)



In Radio mode, touch briefly the screen of “**AF**” range to activate the AF function. Touch it again to turn off the AF function .



AF is a function that works with the help of RDS (Radio Data System) and can only be used with FM stations . The radio searches in the background for the best frequency reception of the station that has been tuned into .

Touch the AF section on touch screen or swing and keep the SEL knob in the TA/AF direction for about 2 seconds , the AF function is activated. The AF symbol appears in the display .

When the AF function has been switched on, the radio continuously tests the signal strength of the AF frequency . The test interval for each AF frequency depends on the signal strength of the current station and varies from a few minutes in the case of weak signals. Whenever the new AF frequency is stronger than the station that is currently tuned in , the radio switched to this frequency for a short time for a short time and the message “NEW FREQUENCY “ is displayed for one or two seconds.

Note :

the status of the AF function is shown by an AF symbol in the display.

- If the AF symbol appears in the display, the AF function is switched on and RDS transmission date is being received .
- If the AF symbol flashes in the display, the AF function is selected but no RDS signal can be received at the moment .

PTY FUNCTION



In Radio mode, touch the screen of “PTY” range to select the Program type .



PTY Selection of the program type

besides the stations name, some FM stations also transmit information on the type of program. This information can be displayed by your car radio .

Examples of such types of program are :

SPORT NEWS POP WEATHER

With PTY function you can specifically select stations transmitting a particular type of program. Touch the PTY range on screen repeatedly to call up the PTY selection menu . The message “PTY SEEK” then appears briefly in the display .

When PTY has been selected the radio starts searching for corresponding PTY information and stops when the PTY information has been found, “NO PTY” appears in the display. If the PTY information being searched for no longer exists, the PTY function automatically switches to normal mode .

DISC Operation

Basic Operation

During DISC playback, you can touch the screen to display the following:

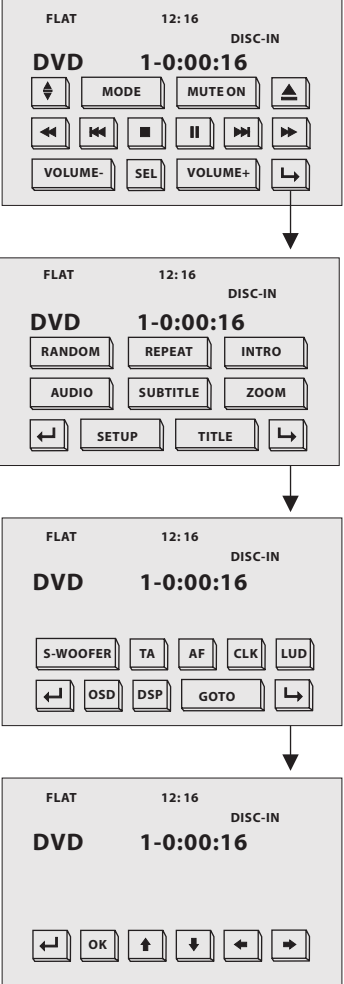

- Touch “ → ” to next .
- Touch “ ← ” to previous .

Switching the DVD mode

Touch the screen of “MODE” range (or press MOD button on the front panel) to select the DISC mode, it display like following :



Function setup
(different the source the display is different)

Stopping Play

- Touch the screen the ■ range (or press the ■ button on remote control .) To stop the unit playback. Touch the || section or press ► button on front panel to start play.

Pause (still picture)

- Touch the “ || ” section on touch screen during playback will stop play temporary, touch it again to return the normal playback .

Rapid Forward/Rapid Reverse



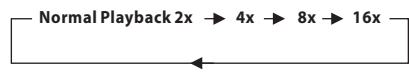

- During DISC playback, touch the screen of “ ►► / ◄◄ ” range or press longer (more than 2’s) the “ ▲ / ▼ ” button on the front panel , the speed of rapid forward/reverse changes according to the disc as follow:

DVD/VCD/CD/MP3:





DISC Operation

Skipping Track













 During DISC playback, Touch the  /  section on the touch screen to skip to next/back one track. (You can also press the  /  on the front panel to skip to next /back one track.)

Note :

1. In DVD mode, touch the  section continually twice to back one track . (Press the  button continually twice to back one track .)
2. For some VCD2.0 disc (PBC-playback control), above these buttons may be unavailable .

Zoom Function

 Repeatedly touch the section of the ZOOM, the displaying rate can be 2x, 3x, 4x, 1/2, 1/3, 1/4 .

Use the direction keys ( /  /  /  on remote control or  /  /  /  on touch screen) to move the enlarged picture . Note: During the JPEG disc playback , touch the screen of “ZOOM” range , the “zoom 100%” word will display, then you can touch longer (more than 2’s) the  /  section on touch screen (or press the  /  buttons on remote control) to zoom in/zoom out the picture. In zoomed mode, use the direction keys to move the enlarged picture .

Loud Function

 Touch the screen of “LUD” range to switch the Loudness function ON or OFF.

Subwoofer Function

 Use your finger touch the “S-WOOFER” section on the screen to turn on the Subwoofer function, touch it again to cancel function .

Selecting The Play Modes

During the Disc playback, touch the touch screen, it will display the following as below :



Touch to select

1) Repeat Function

FOR DVD :

Touch the screen the of “REPEAT” range (or press longer **2/RPT** button on the remote control) to select REPEAT mode as follow :



FOR VCD/CD/MP3 :

Touch the screen the of “REPEAT” range (or press longer **2/RPT** button on the remote control) to select REPEAT mode as follow :



1. Continuously repeat at the current chapter/track, when selected REP-ONE mode .
2. Select REP-ALL mode to continuously repeat all chapter/track on the current disc .

2) RDM(RANDOM) Function

During DISC playback, touch screen of “RANDOM” section (press the **4/RDM** button longer on the remote control to play in random.

DISC Operation

Each playing, the order is different .
 (Depend on the disc used for VCD).
 Touch it again to cancel this function .
 Note : in random mode, the ⏮ button is not available .

3) INT Function

FOR CD :

Touch the screen of the "INTRO" section
 (or longer press the 3/INT button on the
 remote control) to play the previous 6
 seconds part of each track/chapter on
 disc. (Touch it again to cancel this mode)

FOR VCD :

Touch the screen of the "INTRO" section
 (or longer press the 3/INT button on the
 the remote control). It display will
 following menu as below :
 (touch it again to cancel this mode .)

SELECT DIGEST TYPE:
TRACK DIGEST
DISC INTERVAL
TRACK INTERVAL

Use the UP, DOWN, LEFT and RIGHT
 arrows on the remote to select the item,
 and then press ENTER to confirm .

FOR DVD :

Touch the screen of the "INTRO" section
 (or longer press the 3/INT button on the
 the remote control). It display will
 following menu as below :
 (touch it again to cancel this mode .)

SELECT DIGEST TYPE:
TITLE DIGEST
CHAPTER DIGEST
TITLE INTERVAL
CHAPTER INTERVAL

Use the UP, DOWN, LEFT and RIGHT
 arrows on the remote to select the item,
 and then press ENTER to confirm .

NOTE : For MP3, the 3/INT button is not
 available.

DISC Search (GOTO)



Touch to select



FOR DVD :

Touch the screen the of "GOTO" range
 (or press the GOTO button on the remote
 control) Twice, the screen will display
 the following message :

Title 01/01 Time ---:--
 0:10:36

You can select the item you want to
 watch through TIME setting by using
 numeric buttons . (E.x. 0:10:36)

FOR VCD (With PBC OFF):

Touch the screen the of "GOTO" range
 (or press the GOTO button on the remote
 control)Once, the screen will display the
 following message :

Disc Go To ---:--
 00:36

Use the numeric buttons to input the
 time directly (E.x. : 00:36)

DISC Operation

Note:

Touch and hold the ← / → section on the touch screen, you can select the title or chapter of DVD. (Only for the DVD with title /chapter.)

AUX Operation

On the front panel of this unit, there is an AUX IN jack, follow the diagram below to connect analogue replay devices. Use this jack to replay sound of other replay equipment such as DVD players, computers, etc. Via the loudspeakers.

AUX IN JACK FRONT PANEL

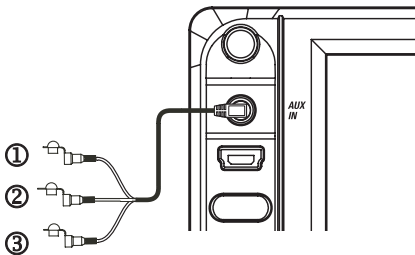

① VIDEO IN (yellow)

② RCH IN (red)

③ LCH IN (white)

1) Please connect the external device with stereo jack plug the Aux in socket.

2) Touch the MOD section on screen or press the MOD button to select the AUX IN connection. It will display the following as below :

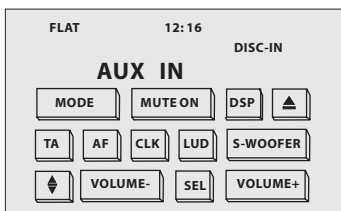

3) You now hear the sound from the external device played back through the loudspeakers.

4) Touch the volume+/- sections on touch screen or use the VOL+/- on the remote to adjust the volume level.

DISC Operation

ON-SCREEN DISPLAY FUNCTION

 During playback, touch the screen the OSD section (or press the OSD on the remote), it will display the following as below :

1. DVD:

A. Touch or Press **OSD** for first time:

```
TITLE ELAPSED
T 01/01 C 01/38 0:02:06
```

Title Number, Total Title Number, Chapter Number, Total Chapter Number of this Title of the disc currently being played will be shown on the screen, along with the elapsed time.

B. Touch or Press **OSD** for second time:

```
TITLE REMAIN
T 01/01 C 01/38 3:24:36
```

C. Touch or Press **OSD** for hird time:

```
CHAPTER ELAPSED
T 01/01 C 01/38 0:02:56
```

D. Touch or Press **OSD** for fourth time:

```
CHAPTER REMAIN
T 01/01 C 01/38 0:04:32
```

E. Touch or Press **OSD** for fifth time:
The message on the screen will be cleared.

2.Example for VCD/SVCD/CD:

A. Touch or Press **OSD** for first time:

```
SINGLE ELAPSED
TRACK 01/16 0:00:56
```

B. Touch or Press **OSD** for second time:

```
SINGLE REMAIN
TRACK 01/16 0:05:10
```

C. Touch or Press **OSD** for hird time:

```
TOTAL ELAPSED
TRACK 01/16 0:31:36
```

D. Touch or Press **OSD** for fourth time:

```
TOTAL REMAIN
TRACK 01/16 0:36:26
```

E. Touch or Press **OSD** for the fifth time:
The message on the screen will be cleared for SVCD and VCD.

NOTE:

For CD and MP3, the message will always display on the screen.

3.Example for MP3:

Each time **OSD** is pressed or touch , the message displayed on screen changes as follows:

```
SINGLE ELAPSED → SINGLE REMAIN
←
```

DISC Special Functions

DVD/VCD Special Function

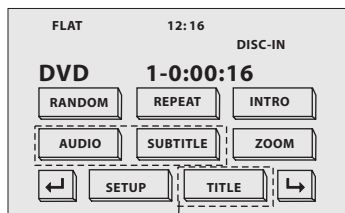

Touch to select

1. Multi-subtitle Language Function (for DVD Only)

SUBTITLE During DVD playback. Touch the **SUBTITLE** section on touch screen (or press the SUBTITLE on the remote).



Each time the button is pressed or touch, number of the subtitle language changes in sequential order.

Notes:

- The language number is different according to the disc.
- Some discs only contain one subtitle language.
- When no different subtitle language are recorded,  will be displayed at screen left top corner.

2. Multi-Audio Language Function

AUDIO For DVD: During DVD playback, touch the **AUDIO** section on touch screen (or press the AUDIO on the remote.) Each time the button is pressed or touch, number of the audio soundtrack language changes on sequential order.



Notes:

- The language number is different according to the disc.
- Some disc only contain one language soundtrack
- When no different language soundtrack are recorded  will be display at screen left top corner.

For VCD/CD:

during playback, touch the **AUDIO** section of the touch screen or Press **AUDIO** on the remote. It is possible to switch the sound between monaural and stereo sound.



3. Multi-Angle Function (for DVD Only)

ANGLE During DVD playback, touch the **ANGLE** section or Press ANGLE button on the remote. Each time the button is pressed or touch, number of the angle changes in sequential order.



Notes:

- The angle number is different according to the disc.
- The function only work for disc having scenes recorded at different angles.
- When no different angle are recorded,  will be displayed at screen left top corner.

4. Title Menu Function

TITLE For DVD: If the DVD has multiple titles recorded on the disc. It can select preferred title from the title menu to start playback.

- During DVD playback, touch the **TITLE** section or press TITLE button on the remote. The title menu is display.
- Touch the cursor button shown in TV screen, select preferred title by the cursor button and confirmed by touch ENT button.

For VCD:

Press **TITLE/PBC** button on the remote control while the disc is playing, you can switch between "PBC on" and "PBC off" mode.

Setup

USING THE MENU

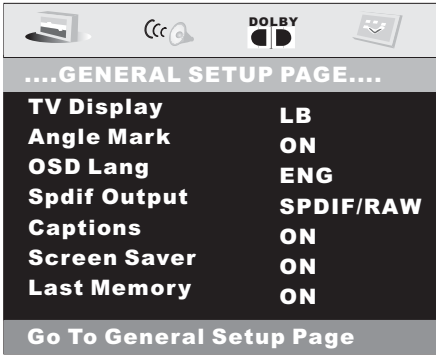

1. Touch the screen of “**SETUP**” range or press the **SETUP** button on remote .
2. The **SETUP** menu is displayed.
3. Select the preferred item by touch the **↑ / ↓ / ← / →** range on the screen or by using the **▶ / ◀ / ▼ / ▲** buttons .
4. Touch screen of the “**OK**” range or Press **ENTER** on the remote to confirm .

The Following Buttons For Entering The Selection.

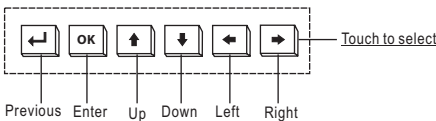

The buttons of the left and right are for selection of setting type .
The buttons of the up and down are for selection of the setting program .

Overview Of The Main Menu

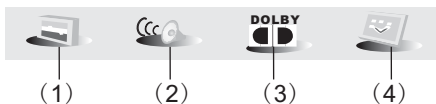

- (1) **General Settings**
- (2) **Speaker Settings**
- (3) **DOLBY Digital Settings**
- (4) **Preference Settings**

GENERAL SETUP

TV Setting

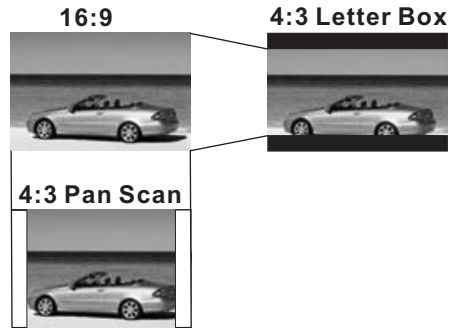
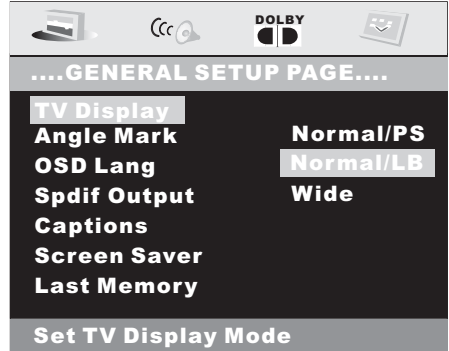

1. TV DISPLAY SETUP

This is to select the appropriate TV aspect (4:3 or 16:9) according to the connected TV set.

Normal/PS (For 4:3 TV)

Played back in the PAN & SCAN style.
(If connected to wide-screen TV, the left and right edges are cut off.)

Normal/LB (For 4:3 TV)

Played back in LETTER BOX style.
(If connected to wide-screen TV, black bands appear at top and bottom of the screen.)

Wide (For 16:9 TV)

Select when a wide-screen TV set is connected.

Setup

GENERAL SETUP

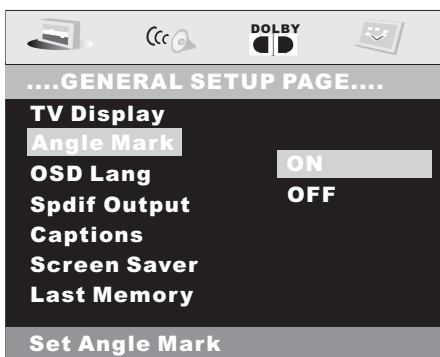

2.ANGLE MARK DISPLAY SETUP

If it is set to ON, when the multi-angle DVD disc is playing,  (the angle mark) will appear on the screen; if it is set to OFF, the mark will not appear.

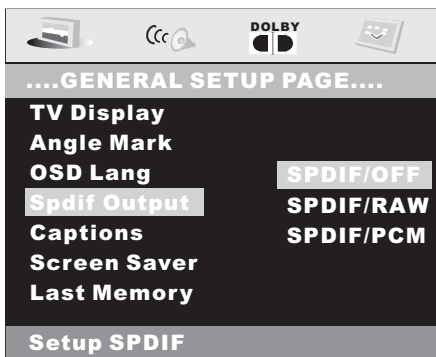



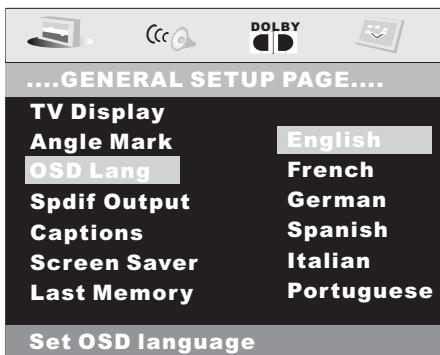

4.SPDIFF OUTPUT

This is to activate the audio output from SPDIF OFF mode to SPDIF/RAW mode to SPDIF/PCM mode.

LANGUAGE DISPLAYING



3.OSD LANG TYPE SETUP

Touch the  /  section on the touch screen or press the  /  button on the remote to select the preferred OSD language, then touch the **OK** section to confirm.

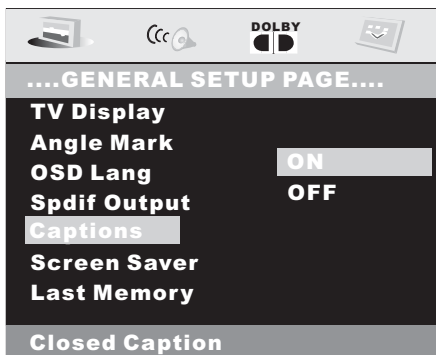

5.CAPTIONS SETUP

Activate the CAPTIONS feature by selecting ON. And release this feature by selecting OFF.

Setup

GENERAL SETUP

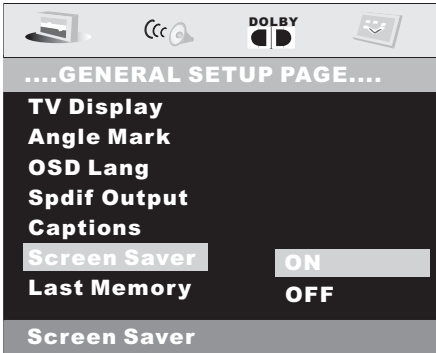

6. SCREENSAVER SETUP

If the screen displays a static image for too long, some "burn-in" may occur, leaving a permanent trace of the image behind. To avoid this, turn ON the SCREENSAVER item. After a short period of inactivity on the monitor, the unit will substitute a moving image to avoid burn-in.

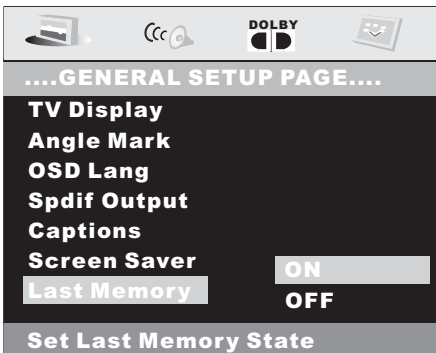

7. LAST MEMORY SETUP

Select the LAST MEMORY output ON/OFF.

SPEAKER SETUP

.....Speaker Setup Page.....

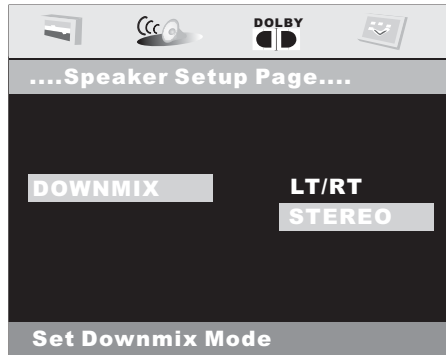

DOLBY DOWNMIX

Many DVD discs are recorded using a surround sound recording technology called Dolby AC3 5.1. When such a disc is played in a normal 2- or 4-channel playback unit like this one, the surround sound must be "downmixed" to stereo. In this case, choose "stereo," unless the output from this unit is connected to a mobile Dolby surround sound system. In that case, choose LT/RT.

DOLBY DIGITAL SETUP

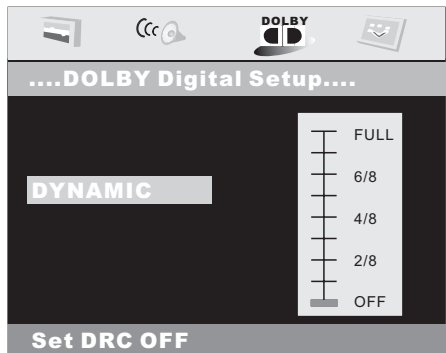

DYNAMIC RANGE CONTROL

Select DRC and adjust the dynamic range of a Dolby Digital encoded program. There are 8 steps between full compression and off compression.

Setup

--- PREFERENCES PAGE ---

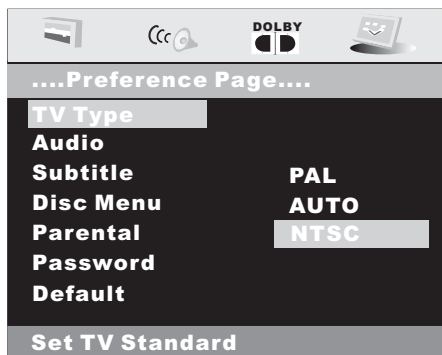

1. TV TYPE SETUP

This player is capable of playing discs recorded in either PAL or NTSC formats. Make the selection based on whether you are connecting the unit to a PAL TV or an NTSC TV. You can also set the unit to AUTO (autoselect). The disadvantage to autoselect is that each time you turn the unit on it checks to see what kind of monitor is connected, which causes a small delay and some flickering of the display image which you may find unpleasant.



2. AUDIO LANGUAGE SETUP

Select the preferred AUDIO soundtrack language using the cursor buttons.

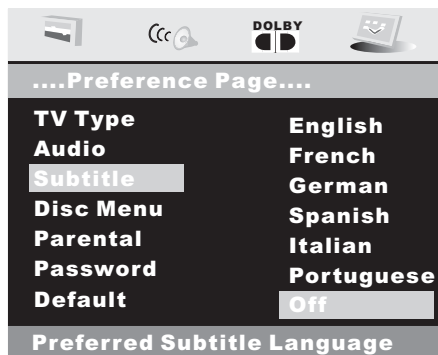

3. SUBTITLE LANGUAGE SETUP

Select the preferred SUBTITLE language by using the cursor buttons.

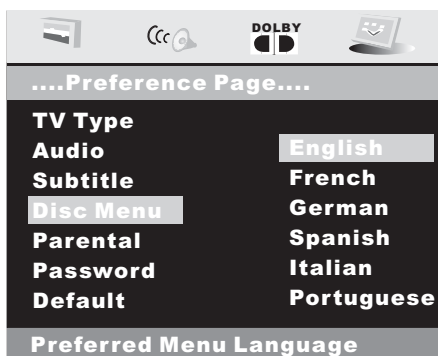

4. DISC MENU LANGUAGE SETUP

Select the preferred DISC MENU language by using the cursor buttons.

Setup

--- PREFERENCES PAGE ---

Age control

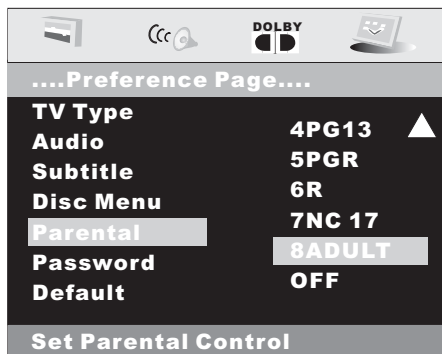

5. PARENTAL

Select suitable parental guidance with the cursor buttons and confirm it by pressing the ENTER button.

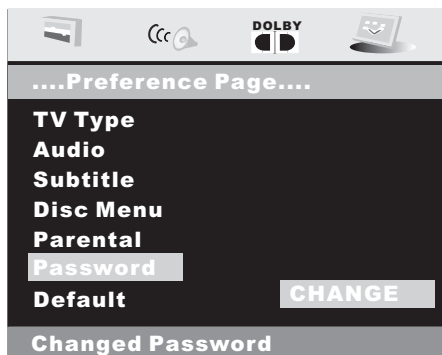

6. PASSWORD SELECTION

The password must be used to make changes to the Parental Control menu above. The factory default password is **1379**. To change this password, press change. You will be asked for the current password. Once you have entered it, you have the opportunity to change it. Then, when you enter the Parental Control menu, you will be required to use this new password in order to make any changes.



7. DEFAULTS

Selecting the DEFAULT item and confirming RESET will return ALL personal settings you have made, including radio and TV presets, to the factory default settings.

DEFAULTS TABLE

GENERAL SETUP	TV DISPLAY	NORMAL/LB
	ANGLE MARK	ON
	OSD LANGUAGE	ENGLISH
	SPDIF OUPUT	SPDIF/RAM
	CAPTIONS	ON
	SCR SAVER	ON
	LAST MEMORY	ON
SPEAKER SETUP	DOWNMIX	STEREO
DOLBY DIGITAL	DYNAMIC	OFF
PREFERENCES	TV TYPE	AUTO
	AUDIO	ENGLISH
	SUBTITLE	OFF
	DISC MENU	ENGLISH
	PARENTAL	8 ADULT
PASSWORD	1379	

Other Main Operation

USB Operation

Following the diagram below, connect your USB device to the front panel USB port. If it is properly connected, the device will be mounted and start playing automatically.

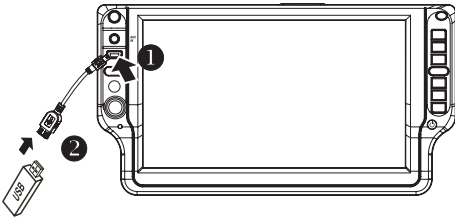

you can also select the desired item of the USB device. The buttons on the remote control, on the device, have the same functions as the touch buttons of this touch screen have.

In USB Playback mode

Use the UP, DOWN, RIGHT or LEFT buttons to navigate to and select files to play, and press ENTER to begin playback (or viewing, in the case of JPEG files). To skip to the next or last track, touch or press the ►► or ◀◀. Press the ►► or ◀◀ buttons for Fast Forward or Fast Reverse playback.

REPEAT play modes are also available by repeatedly pushing **REPEAT** until the desired mode is found.

Changing From USB to DISC Playback modes

If you are in USB Playback mode and wish to begin playback of a disc already in the player, touch the ■ range on the touch screen or press the STOP on the remote once. Then touch GOTO range on the screen or press the GOTO on the remote and the player will switch to DVD/VCD/CD/MP3 Playback mode.

Changing From DISC to USB Playback Modes

If the disc present in the player is an MP3 disc, touch ■ section on screen or press the STOP on remote once then touch or press the GOTO to USB playback.

If the disc present in the player is an DVD or VCD or CD disc, touch ■ on the screen or press STOP twice on the remote then touch GOTO section on the screen or press the GOTO button on the remote to USB playback.

Important Note:

To prevent damage to the USB device, do not remove or disconnect it during playback. it is also a good practice to remove the USB drive during disc playback.

TV Operation

Switching to TV mode

1. Connect the TV antenna to the TV.IN (from Ant) jack on the back of the unit.
2. Touch the **MODE** section on the touch screen (or press the mode button on the remote to select the TV mode. The message will display in the monitor as follow :

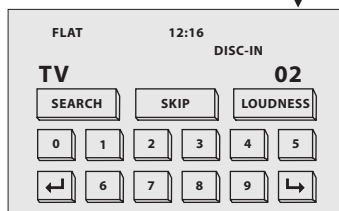
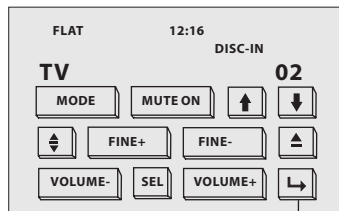

Other Main Operation

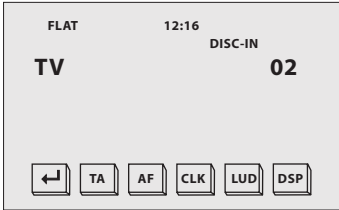

Touch “ ↲ ” to next .

Touch “ ↶ ” to previous .

Auto searching TV channels

SEARCH Touch the screen of “ **SEARCH** ” range or press the “SEARCH” button on the remote control

to star search channel automatically. It will display the following as below:

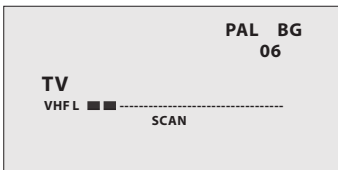

Selecting channel

Touch the screen of “ ↑ ” section or press the “▲” button on the remote control to choose the channel upward .

Touch the screen of “ ↓ ” section or press the “▼” button on the remote control to choose the channel downward .

- The numeric button (0-9) on the remote control allow you to select the corresponding channel directly.

Note:

In TV mode, the +10 button is not available.

Fine Tuning

Touch the “**FINE+ / FINE-**” section on the touch screen (or press ▶ / ◀ button on the remote control) to fine tune the current channel .

Channel ADD/DEL

SKIP In TV mode , after search channel automatically, when you want delete the no sign channel,

Touch the screen of “ **SKIP** ” range or press the SKIP button on the remote , the screen display SKIP , the channel will be deleted. Also, you can touch or press numeric button to select channel, then touch or press “**SKIP**” button to add channel (the screen display SAVE).

Dub system

Touch the screen of “ **SEL** ” range or press the “**SEL**” button repeatedly to select the TV standard . and then you can use the VOL+/- to select among of the “**PAL-BG, PAL-DK, PAL-I, PAL-M, PAL-N, NTSC, SECAM-BG ,SECAM-DK**” .

Other Main Operation

SD/MMC card OPERATION

The unit can support playback MP3/WMA/JPEG/MP4 format which are stored into SD and MMC memory card .

Please read below before you start the operation of memory card .

Inserting and removing a SD or MMC card on the front panel of unit .

Inserting the SD or MMC card .

①

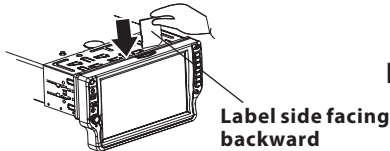

Insert the memory card into slot with label side facing backward .

②

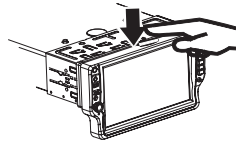

Press in till heard a "CLICK" .

Removing the SD or MMC card .

①

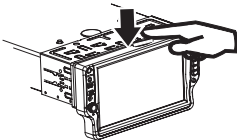

Press in till heard a "CLICK" .

②

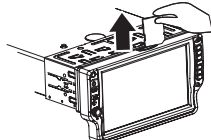

Remove the memory card .

Mode change to SD/MMC card

After a SD or MMC card was inserted into the main unit card slot . The unit will starts playing the files contained on the memory card . Once the unit read the memory card successfully, the first file on the memory card will automatically start play back .

Press the mode button repeatedly is allowing changing to other modes .

Change DISC to SD/MMC card

The operations are same as USB mode, refer to see USB operation .

Change SD/MMC card to DISC

The operations are same as USB mode, refer to see USB operation .

File Playback Operation

All the SD or MMC memory car playback operation function is same as the operation on **CD/MP3/WMA** .

Please to "MP3/WMA" operation for more details .

Other Main Operation

MP3/WMA/JPEG/MPEG4 DISC PLAY

When you insert a disc which contains MP3, WMA or JPEG files, the different file types are detected, and a list of the files are produced, as shown in the diagram below.

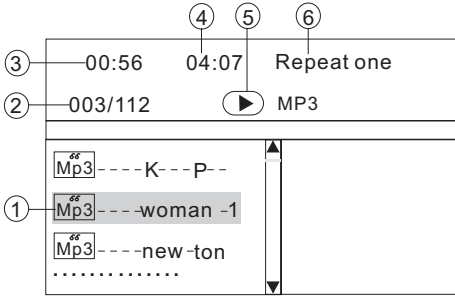

- 1 Current track(file)(highlighted bar)
- 2 Current track (file) number/total number of tracks(files) in the current folder.
- 3 Elapsed playing time of the current track(not available for JPEG disc)
- 4 total playing time.(not available for JPEG disc)
- 5 Operation mode icon. ▶ (Play), ■ (stop) || (pause) ▶▶ (forward) ◀◀ (reverse).
- 6 Selected playback mode

Touch the screen, it will display the following as below :
(when the parking brake is applied .)

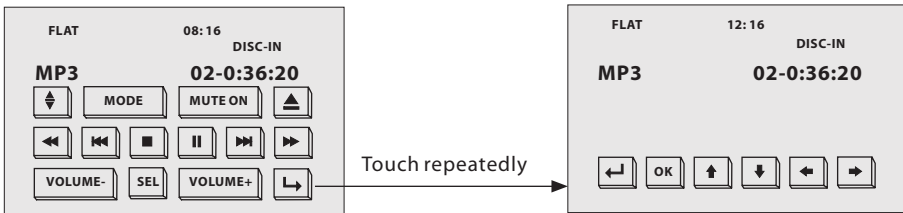

In stop mode, touch the ↑ / ↓ / ← / → sections on touch screen (or Use ▲ / ▼ / ▶ / ◀ on the remote control) to select the item or folder, then touch the “OK” range (or press **ENTER** button on the remote control) to confirm.

Touch the screen of “REPEAT ” range or press longer “REPEAT” on the remote control repeatedly can select two kinds of repeat play mode.

REP-ONE:

Play the same song over and over again.

REP ALL:

Play all songs on the disc, then repeats the entire disc over and over again .

Moving To Another Track :

1. Touch the ▶▶ or ◀◀ section to skip a track ahead or back.
2. Press the ▲ or ▼ button to skip a track ahead or back.

Fast Forward/Fast Backward

1. Touch longer (more than 2's) the “ ▶▶/◀◀ ” range for fast forward or fast backward .
2. Press longer the ▲ or ▼ button for forward or backward .

Specification

Supply Voltage:	12V DC (11V-15V)	
Current Consumption:	Less than 10 A	
Signal System:	Compositive video 1.0Vp-p 75 Ω	
Discs Played:	(1)DVD-VIDEO Disc 5"(12 cm) single-sided, single-layer 5"(12 cm) single-sided, double-layer (2)Compact Disc (CD-DA, VIDEO CD) 5"(12cm) disc	
Audio Signal Output:	2ch&4ch line out	
Characteristics:	(1)Frequency Response	20 Hz - 20 KHz
	(2)S/N Ratio	90 dB (JIS)
	(3)Wow and Flutter	Below measurable limits

RADIO Section:

	For 3 Bands (Europe) FM	For 2 Bands (Europe) FM	For 2 Bands (U.S.A.) FM
Frequency Coverage:	87.5 to108 MHz	87.5 to108 MHz	87.5 to107.9 MHz
IF:	10.7 MHz	10.7 MHz	10.7 MHz
Sensitivity (S/N = 30 dB):	15 dBu	15 dBu	15dBu
	MW	MW	AM
Frequency Coverage:	522 to1620 KHz	522 to1620 KHz	530 to1710 KHz
IF:	450 KHz	450 KHz	450 KHz
Sensitivity (S/N = 20 dB):	40 dBu	40 dBu	40 dBu

TV Section :

TV System:	NTSC/PAL/SECAM
TV Sensitivity:	45dB μ V @CH25 in average

TFT Monitor:

Monitor Screen Size:	6.2 Inch Wide
Number of Pixels:	480 X RGB X 234 pixels
Color System:	NTSC/PAL

NOTE: Specifications and design are subject to modification, without notice, due to improvements in technology.

Trouble Shooting

Before going through the check list, check wiring connection. If any of the problems persist after check list has been made, consult your nearest service dealer.

SYMPTOM	CAUSE	SOLUTION
No power	The car ignition switch is not on	If the power supply is properly connected to the car accessory terminal, switch the ignition key to "ACC"
	The fuse is blown	Replace the fuse
Disc can not be loaded or ejected	Presence of disc inside the player.	Remove the disc in the player, then put a new one
	Inserting the disc in reverse direction	Insert the compact disc with the label facing upward
	The disc is extremely dirty or defective	Clean the disc or try to play a new one
	Temperature inside the car is too high	Cool off or until the ambient temperature return to normal
Television/video image appears black-white	The color system is set incorrectly	Please switch to correct color system from menu
No television/video image appears	The unit is not connected to the parking brake detection switch	Make proper connection according to "wire connection"
	The parking brake is not engaged	For safety reasons no television /video images are displayed while the vehicle is moving. Engaging the parking brake will cause images to be displayed.
No color in picture	The disc format is not according to the TV-set used (PAL/NTSC)	Please the television mode of the choice accommodation
JPEG disc can not be played back	No JPEG files are recorded on the disc.	Change the disc
	JPEG files are not recorded in a compliant format	Change the disc Record JPEG files using a compliant application
The operation keys do not work	The built-in microcomputer is not operating properly due to noise	Press the RESET button. Front panel is not properly fixed into its place
The radio does not work	The antenna cable is not connected	Insert the antenna cable firmly
	The signals are too weak	Select a station manually