

User's Manual

BV9980RDS

**IN-DASH DVD/MP3/CD RECEIVER
WITH MOTORIZED FLIP-OUT
7-INCH WIDESCREEN
TOUCHSCREEN TFT MONITOR
WITH USB AND MEMORY CARD PORTS
AND FRONT PANEL AUX INPUT**

RDS EUROPEAN
FREQUENCY MODEL



BV9980RDS

**IN-DASH DVD/MP3/CD RECEIVER
WITH MOTORIZED FLIP-OUT 7-INCH WIDESCREEN
TOUCHSCREEN TFT MONITOR
WITH USB AND MEMORY CARD PORTS
AND FRONT PANEL AUX INPUT**

RDS EUROPEAN FREQUENCY MODEL

12.2007



BOSS Audio Systems • 3451 Lunar Court • Oxnard, CA 93030

www.bossaudio.com

800.999.1236

tech support: www.bossaudio.com/support

BOSS[®]

AUDIO SYSTEMS

BOSS[®]

AUDIO SYSTEMS

18
19
20
21
22
23
24
25
26

Thank you for buying this product.

Please read through these operation instruments so you will know how to operate your model properly. *After reading please keep this booklet in safe place for future reference.*

1 Before You Start

- Important Safeguards 4
- About this manual 4
- Precautions 5
- Maintenance 6
- Location & function of the controls 7
- Remote control 8
- Specifications 11

2 Installation

- Wiring Connections 12
- Install the Unit 13
- Detach the Unit 14
- Install the Front Panel 15
- Detach the Front Panel 15

3 Common Operations

- Reset the Unit 16
- Turning the Unit On/Off 16
- Volume Control 16
- Setting the Sound Characteristics 16
- EQ Setting 16
- Turning Loudness On 16
- Eject a Disc 17
- Open the Monitor 17
- Angle Setting 17
- Mute Function 17
- Clear 17
- Mode Selector 17
- Menu Setup Button 17
- Infrared Sensor 17
- Eject a stuck Disc 17

4 Main Menu

- Main Menu Setup 18
- Audio Adjust 18

- Video Adjust 18
- Source Setup 18
- Others 18

5 DVD

- Playing a DVD 23
- DVD Setup 23
- Selecting Tracks Fast 23
- Stop the Playback 23
- Pause the Playback 23
- Skip Backward/Forward/F.F/F.REW the Playback 23
- Number Buttons 23
- Repeat Playing 23
- System Switch 24
- Slow Motion Playback 24
- Increase Picture Size 24
- On Screen Display 24
- Setting the Playback Time 24
- Changing the Viewing Angle 24
- Changing Audio Language 25
- Changing the Subtitle Language 25
- Selecting Menu 25
- DVD Setup Menu 25

6 MP3/USB/SD

- Playing a MP3/USB/SD Disc 32
- Selecting Tracks Fast 32
- Repeat Playing 32
- Number Buttons 32
- Stop Playing 32
- Selecting Tracks 32
- Pause the Playback 32
- Skip Backward/Forward/F.F/F.REW the Playback 33
- On Screen Display 33
- Exit an USB 33
- Exit a SD Card 33

Simple Troubleshooting Guide

The following checklist might helped to solve the problems which you meet when using the unit. Please double check and make sure if the connection and the procedure of the operation is properly before using the checklist below .

Problem	Cause/Solution
No power.	<ul style="list-style-type: none"> • Check and make sure whether the fuse is blown, replace with the proper value if necessary.
Some errors occur in the LCD or no function when pressing the button.	<ul style="list-style-type: none"> • Press RESET button.
Unable to receive stations.	<ul style="list-style-type: none"> • Check and make sure whether the antenna is inserted or the antenna is properly connected, if not, insert the antenna or connect it properly.
Poor effect on receiving a station.	<ul style="list-style-type: none"> • Antenna may not be the proper length. Make sure the antenna is fully extended; if broken, replace the antenna with a new one. • The antenna is poorly grounded, check and make sure the antenna is properly grounded at its mounting location.
CDs cannot be loaded.	<ul style="list-style-type: none"> • A CD is loaded in the mechanism.
Sound skips.	<ul style="list-style-type: none"> • The CD is dirty or damaged.
No images.	<ul style="list-style-type: none"> • The Video line from main unit to the TV is not connected properly.
Images skip.	<ul style="list-style-type: none"> • Improper setting of the color system. Set the color system to “PAL” or “NTSC” according to the connected television.

Note:

If any of the problem persist after check list had been made, consult your nearest service dealer. Never attempt to disassemble your unit by yourself.

 **Due to continuous product improvement, the operations are subject to run the model.**

AUX Touch Screen Menu

Press SRC to switch to the AUX mode:

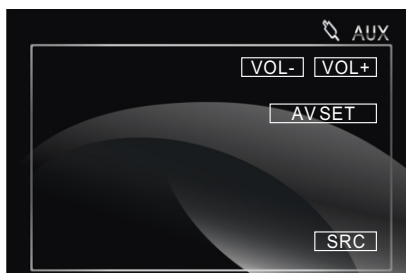

AVSET

For more details please refer to pages 18 to 19. To adjust VIDEO ADJUST, a DVD should be inserted and played normally at first.

VOL+ To increase the volume

VOL- To decrease the volume

7 VCD/CD

- Playing a VCD/CD Disc* 34
- Selecting Tracks Fast* 34
- Repeat Playing* 34
- Playing Tracks at Random* 34
- Number Buttons* 34
- Stop Playing* 34
- Pause the Playback* 34
- Skip Backward/Forward/F.F/F.REW the Playback* 34
- System Switch* 35
- Slow Motion Playback* 35
- Increase Picture Size* 35
- On Screen Display* 35
- Setting the Playback Time* 35
- Selecting Channel* 36
- Selecting Title* 36
- Program Playing* 36

8 MP4(AVI,MPEG4)

- Basic Operation of MP4* 37
- Number Buttons* 37
- Stop the Playback* 37
- Pause the Playback* 37
- On Screen Display* 37
- Repeat Playing* 37
- Setting the Playback Time* 37
- Slow Motion Playback* 37
- Selecting Tracks Fast* 38
- Skip Backward/Forward/F.F/F.REW the Playback* 38
- Playing Tracks at Random* 38
- Increase Picture Size* 38
- Changing Audio Language* 38
- Changing the Subtitle Language* 38

9 Tuner

- Listening to the Radio* 39
- Band Selector* 39
- Manual/Automatic Tuning* 39
- DX/LOC Selector* 39
- Selecting the Stored Station* 39
- MO/ST Selector* 40
- Scanning/Memorizing Stations Automatically* 40
- Number Buttons* 40
- On Screen Display* 40
- RDS SETUP* 41
- Alternative Frequencies* 41
- Traffic Alarm* 41
- Program Type* 41

10 AUX

- AUX Touch Screen Menu* 42

11 Additional Information

- Simple Troubleshooting Guide* 43

IMPORTANT SAFEGUARDS About this manual

- 1 Be sure to connect the color coded leads according to the diagram. Incorrect connections may cause the unit to malfunction or damage the vehicle's electrical system.
- 2 Be sure to connect the speaker (-) leads to the speaker (-) terminal. Never connect the left and right channel speaker cables each other or to the vehicle body.
- 3 Make sure all the connections are completely correct before turning on your unit.
- 4 When replacing the fuse(s), the replacement must be of the same amperage as shown on the fuse holder.
- 5 Do not block vents or radiator panels. Blocking them will cause heat to build up inside and may result in fire.
- 6 To lest the driver distract his attention from, please install the unit in an apt place.
- 7 Using the unit after starting the engine, otherwise the unit can not be started, because the electric energy of battery was used up.
- 8 The unit must be screened from direct sunlight, or the electric energy of battery will be wasting for the high temperature.
- 9 Do not use the unit in extreme high temperature or such low temperature conditions, and also avoid humidity and direct sunlight.
- 10 Take care of the magnetism of the unit. Do no put the credit card, cassette or watch around the unit, or they would be broken or some information in them lose.
- 11 To lest disturb the video frequency, keep far away from the unit when using your phone.
- 12 Do not put the remote control under high temperature or where the sun strikes it, or else the control remote can not work normally.

This unit features a number of sophisticated functions ensuring superior operation. All the functions have been designed for the easiest possible use, but many are not self-explanatory. This manual will help you understand the functions and operations of the unit. This manual main explains **remote control operation**. However, in addition to those functions related with DVD/VCD/CD/MP3/MP4 operation that can only be operated by the remote control, there are also functions can be operated by the buttons provided for the main unit.

WARNING!

Do not watch or operate the video monitor while driving. Doing so is unsafe and can distract the driver, which may cause an accident.

In some states or countries it is illegal for a driver to operate or view a video monitor while driving. It may also be illegal for a passenger to operate or view a video monitor in a moving vehicle even if the driver is not watching it.

Be sure that the installation and operation of this product is in compliance with local rules and regulations.

Tuner

RDS Setup

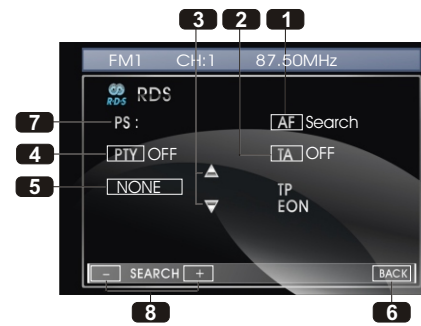

- 1 **AF**
Press it to activate AF function.
- 2 **TA**
Press it to activate TA function.
- 3 **▲/▼**
Press it to select PTY code.
- 4 **PTY**
Press it to activate PTY function.
- 5 During PTY ON, press this button to search the playing track's type.
- 6 **BACK**
Press it to turn to listening to the radio.
- 7 **PS:**
TO display the current RDS station's programs information.
- 8 **SEARCH+ /SEARCH-**
Press it to tune automatically.

Alternative Frequencies

Briefly pressing **26** AF to activate the auto searching station function. When AF is on, the RDS signal is weak or there is not, it will be found in the preset frequencies and the whole bands.

- Note:**
 - * It is also performed by pressing **11** in the monitor.

Traffic Alarm

Briefly pressing **25** TA to activate the traffic alarm function. When AF is on, there is **TA** displays on LCD, or else, if there is no TP information, the mode will search TP station automatically.

The **TA** is green when it is played by a station, if not, it is yellow. When TA is playing, the volume will be adjusted to a TA level automatically. When in other modes (such as DVD,AUX), if a TA program is played. The mode will skip to the RDS status automatically. It will resume to the primary mode after the TA is over.

- Note:**

- * Briefly press TA on the head unit or press **2** button in the monitor performs the same function.
- * When TA is off, there are no **TA** on LCD.

Program Type

Briefly pressing **7** PTY to activate PTY function. When PTY is on, **PTY ON** appears in the monitor, you can press **UP/DOWN** to select the program type, and then press PTY CODE to search the special program. And the monitor displays **PTY SEARCH**.

If PTY is off, **PTY OFF** appears in the monitor, the searching is stopped.

- Note:**

- * It is also performed by pressing **4** in the monitor.

MO/ST Selector

Press **6** **ST** button on the remote control to select **MONO** mode or **STEREO** mode.

Stereo reception is charged when “**STEREO**” appears. It is switched to mono mode when “**MONO**” appears. “**ST OFF**” appears on the display to switch to **MONO** compulsively.

▣ Note:

- * It is only valid on remote control.
- * Switch to **MONO** compulsively to improve the listening quality when weak signal.
- * It is only valid in FM tuning.

Scanning/Memorizing Stations Automatically

During radio status, you can press **4** **AMS** button on the remote control to scan each stored station 5 seconds respectively which stored in **23** Number Buttons (from 1 to 6). You can press the corresponding Number Buttons or **AMS** button when your desired station is charged. And it starts playing that station.

When press and hold **4** **AMS** button for more than 2 seconds, it will activate automatically memory storing function. The radio automatically selects a station and has it stored in any one of the **23** **Number Buttons (from 1 to 6)**.

▣ Note:

- * The unit can be stored up to 6 stations for each band.
- * It is only valid on remote control.

Number Buttons

During radio status, press **Number Buttons** to receive the stored stations.

During radio status, **Number Buttons (from 1 to 6)** **23** can help you store your favorite station. You can follow the steps as below:

- 1 When receiving a station, press and hold any one of the **Number Buttons (from 1 to 6)** until the number appears on the **LCD**, which indicates that station is already stored in the corresponding number button.
- 2 Press and hold **4** **AMS** button to receive stations automatically, and store them in 1 to 6 number respectively.
- 3 Press and hold another number button more than 2 seconds when listening in a station in one number button's, the station will be stored in that number button.

▣ Note:

- * Press **5** in the monitor performs the same function.

On Screen Display







During radio mode, briefly press **8** to RDS Setup, keep pressing **8** **OSD** to display the edition information and the **LCD** display the current time.

▣ Note:

- * Press **7** in the monitor performs the same function.

PRECAUTIONS

This unit can play the following discs only:

Type of disc	Label on the disc	Recorded material	Size of disc
DVD		Sound and moving pictures	12cm
VCD	 	Sound and moving pictures	12cm
CD		Sound only	12cm
MP3		Sound only	12cm
MPEG-4		Sound and moving pictures	12cm

NOTE: The unit is compatible with VCD1.0/1.1/2.0/3.0 version and DVCD disc.

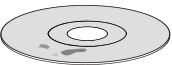
- **Do not attempt to modify the unit, modifying the unit may cause an accident.** —Do not use your CDs with paste residue or ink attached. 
- **Stop the vehicle before carrying out any operation that could interfere with your driving.** —Do not use CDs with labels or stickers attached, which may leave a sticky residue while beginning to peel off. (Shown as the picture) 
- **Do not work in extremely high or low temperature. Be sure the temperature inside the vehicle is between +60° C and -10° C before turning on your unit .**
- **To enjoy optimum sound and images while playing, handle the discs as follows:**

—Handle the disc by its edge to keep the disc clean, and do not touch the surface.



—Clean the discs with an optional cleaning cloth. Wipe each disc from the center out. (Shown as the picture)

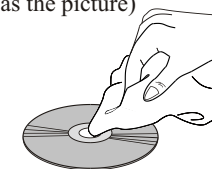

Besides playing the discs above, the unit also can be played SD card and connected to other connector. Please refer to the details on page 19 before you playing them.

Maintenance

Replacing the Fuse

Make sure the amperage matches the specified value when replacing the fuses. If the fuse is blown, check the power connection and replace with a new one. If the same problem occurs, it would be subjected to the malfunction. In such cases, please consult to the nearest service dealer.

⚠ Warning

Never use the fuse with the rated amperage more than that supplied to your unit, otherwise it will damage the unit.

Replacing the Battery

When the range of the operation of the card remote control becomes short or no functions while operating. Replace the lithium battery with a new button cell (CR2025). Make sure the battery polarity before replace.

Gently pull out the Battery Holder while pressing the Stopper.

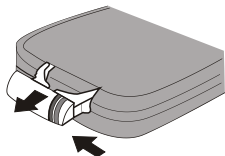

Put the button-type battery with mark(+) upward into the Battery Holder.

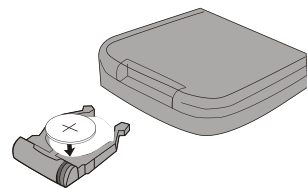

Insert the Battery Holder into the Remote Control.

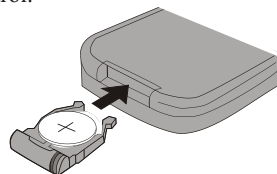

Precautions on Using Lithium Battery

Always keep the lithium battery beyond children's reach. In case swallowed, see a doctor immediately.

Cleaning the battery with a dry cloth, to ensure its perfect connected.

Make sure the proper polarity when loading with the battery.

To prevent short circuit, do not use metal tweezers to clip the battery.

⚠ Warning!

Improper handle with the battery may lead to explosion. It cannot be charged, disassembled or thrown into a fire.

Tuner

Listening to the radio

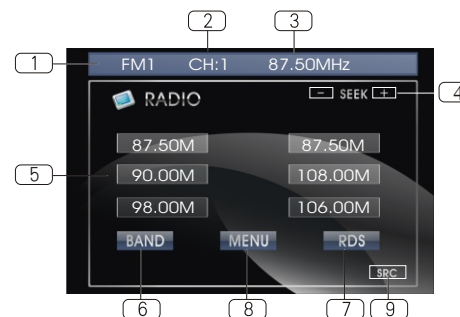

- 1 **Band Indicator**
Shows which band the radio is tuned to.
- 2 **Preset Number Indicator**
Shows what preset has been selected.
- 3 **Frequency Indicator**
Shows which frequency the tuner is tuned.
- 4 **SEEK+ / SEEK-**
Briefly press to tune by the presettable range, hold and press to tune automatically.
- 5 **The 6 stations of the current band.**
Briefly press to select station, hold and press to save the current station to one of the 6 stations.
- 6 **BAND**
To select the bands.
- 7 **RDS**
Press it to enter RDS SETUP.
- 8 **MENU**
Press this button to set the main menu.
- 9 **SRC**
Press this button to select the signal source.

Band Selector

During radio status, repeatedly press **3** BAND button to select bands in the following order:



▣ Note:

* Press BAND on the head unit or **6** in the monitor performs the same function.

Manual/Automatic Tuning

Manual Tuning: Repeatedly Press **20** (▶▶ or ◀◀) button on the remote control continuously to select a station downward or upward respectively.

Automatic Tuning: Press and hold **20** (▶▶ or ◀◀) button for more than 3 seconds, the radio automatically searches a station downward or upward respectively and plays when it finds a station.

▣ Note:

* Press ▶/◀ on the head unit or **4** in the monitor also performs the same function.

DX/LOC Selector

During radio status, press **5** LOC button to select strong or weak station reception. "LOC ON" appears on the display and only local station is available. "LOC OFF" appears on the display both distance and local stations can be received.

▣ Note:

* The function is only valid on remote control.
* The function is invalid in AM tuning.

Selecting the Stored Station

During radio status, press **27** ▲ button to select the stored station upward, press ▼ to select the stored station downward.

▣ Note:

* The function is only valid on remote control.

Selecting Tracks Fast

During MP4(AVI,MPEG4) playback, first press **21** **⏮** to return to the beginning of the current track, press **21** **⏮** again within 3 seconds to play previous track, press **21** **⏭** to play next track .

Note:

- * Pressing **⏮** and **⏭** button on the head unit or **⏮** and **⏭** in the monitor also performs the same function.

Skip backward/forward/F.F /F.REW the playback

Press **20** (**⏮** or **⏭**) on remote control to perform fast reward or fast forward. Each press will change as the following:



Note:

- * Press **⏮** and **⏭** in the monitor performs the same function.

Playing Tracks at Random

During MP4(AVI,MPEG4) playback, press **16** **RDM** button on the remote control to play any track at random which you select. Press it again to cancel this function.

Note:

- * The function is only valid on remote control.

Increase the size of the picture

During MP4(AVI,MPEG4) mode, Press **9** **ZOOM** to increase the picture in size. There are different sizes and they are as follows. Each pressing will increase the size til it reaches the maximum.

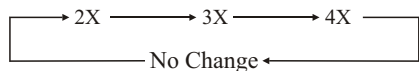

Note:

- * The function is only valid on remote control.
- * To remove the image by press **27** button.

Changing audio language (Multi-audio)

With MP4(AVI,MPEG4) disc featuring multi-audio recordings, repeatedly press **6** **AUDIO** to switch between language and audio systems during playback.

Selection options switch as follows:

AUDIO 1 — AUDIO 2 — AUDIO 3

Note:

- * This function is operated by using the remote control.
- * This function only operates with disc featuring multi-audio recordings.
- * The number in the “**Ⓞ**” mark on a disc package indicates the number of recorded languages/audio systems.

Changing the subtitle language (Multi-subtitle)

With MP4(AVI,MPEG4) disc featuring multi-subtitle recordings, repeatedly press **5** **SUB-T** to switch between subtitle languages during playback.

Selection options switch as follows:

Subtitles 1 — Subtitles 2 — Subtitles OFF

Note:

- * This function is operated by using the remote control.
- * This function only operates with disc featuring multi-subtitle recordings.
- * The number in the “**Ⓞ**” mark on a disc package indicates the number of recorded subtitle languages.

Location of the Controls

The Expanding

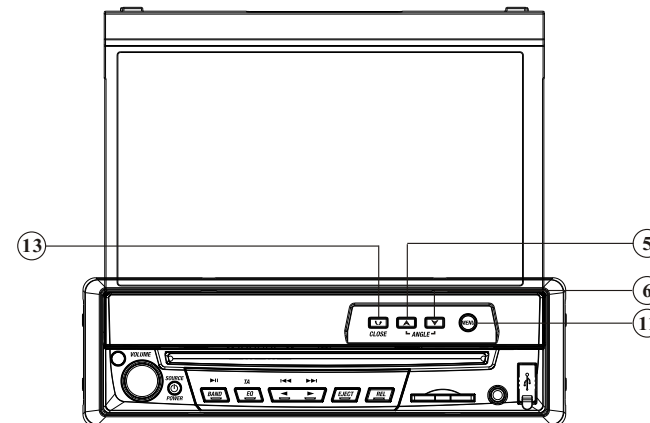

The Whole

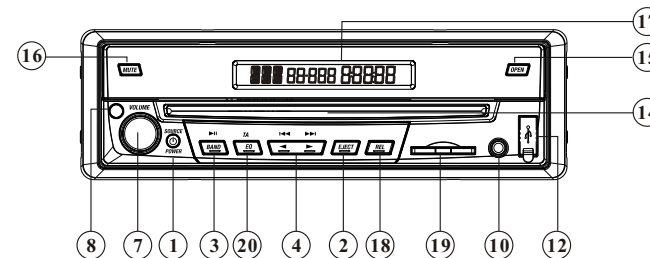

The Base

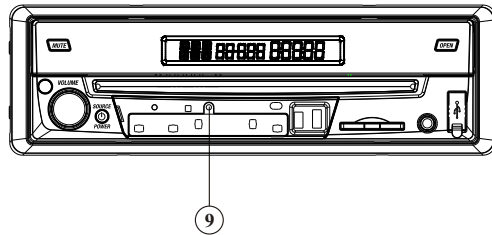

- | | |
|---|---|
| <p>① SOURCE/POWER
Brief press to select radio mode or playback mode, hold and press it to turn the unit on or off.</p> <p>② EJECT Button
Press it to insert or eject a disc.</p> <p>③ BAND/▶ (band selector/play/pause) Button
During radio mode,press it to select the bands; During playback mode,press it to play or pause.</p> <p>④ [◀/⏮]/[▶/⏭]([Adjust frequency backward/Previous]/[Adjust frequency forward/Next Track])</p> <p>⑤ ▲ (ANGEL+) Button</p> <p>⑥ ▼ (ANGEL-) Button</p> <p>⑦ VOL+/ VOL-/SEL</p> <p>⑧ REMOTE Infrared Sensor</p> <p>⑨ RESET Button</p> <p>⑩ A/V IN</p> | <p>⑪ (MENU) Button
During playback mode, brief press to set DVD menu; During radio mode,brief press it to set the radio menu,hold and press it to set the main menu.</p> <p>⑫ USB Socket</p> <p>⑬ (Back Space)/CLOSE Button</p> <p>⑭ Disc Loading Slot</p> <p>⑮ OPEN Button</p> <p>⑯ MUTE Button</p> <p>⑰ LCD Screen</p> <p>⑱ REL (release the front panel) Button</p> <p>⑲ SD Card Slot</p> <p>⑳ EQ/TA(equalizer/traffic alarm) Button</p> |
|---|---|

Basic Operation of Mp4

Insert a MP4(AVI,MPEG4) disc into the slot, the unit will automatically switch on, if a disc is loaded, press ① SOURCE to start the playback.

Note:

- * You can press EJECT button on the head unit to eject the MP4 disc.

Number Buttons

you can select any tracks directly by using ⑫ Number Buttons (0~9). The track you selected will be played automatically.

Note:

- * This function is operated by using the remote control.

Stop the playback

During MP4(AVI,MPEG4) playback, first press ⑬ to pause playing, then press ⑰ to play from the beginning of the disc, During stop status, press ⑱ pause to resume playing state.

Note:

- * Press [] in the monitor performs the same function.

Pause the Playback

During MP4(AVI,MPEG4) playback, press ⑰ button to switch between play and stop; during stop mode, Press it again to return to normal playback.

Note:

- * Press ▶ on the head unit or [] in the monitor performs the same operation.

On Screen Display

Press ⑧ OSD button the display shows:

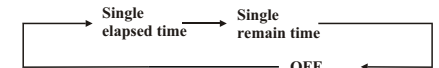

Press and hold ⑧ OSD LCD displays the current time.

Note:

- * This function is operated by using the remote control.

Repeat Playing

During Mp4 (AVI, MPEG4) playback, press ⑮ RPT to perform replaying function,first press it to replay the current track, press it again to cancel this function.

Note:

- * This function is operated by using the remote control.

Setting the Playback Time

During MP4(AVI,MPEG4) playback, first press ② GOTO, and monitor shows *select* : ---, press your desired time of the playback by using number buttons. and press ENTER to set the status. Secondly press GOTO button,and the monitor shows: -:--:--, input your desired time, then press ENTER.

Note:

- * This function is operated by using the remote control.

Slow motion playback

During MP4(AVI,MPEG4) mode, press ⑩ SLOW to slow forward or slow backward. There are speeds as follow:

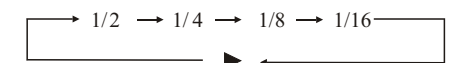

Note:

- * This function is operated by using the remote control.

Selecting Channel

During VCD status, repeatedly press **6** AUDIO button to select the following channel:



Selecting the corresponding channel to set the different sound characters.

Note:

- * This function is operated by using the remote control.

PBC Selector

During VCD status, firstly press **3** TITLE button, the PBC playback starts and the menu of entire disc appears on LCD. And then you can select your desired track by using **27** or **23**. When a track is playing, you can press MENU to return to the menu, if you would like to end the track and select others. To cancel PBC playing, press **3** TITLE button again.

Note:

- * PBC playing confirms to version 2.0 or above disc only.

Program Playing

During VCD/CD mode, press **13** PROG, the TFT displays the program menu. Pressing **NUMBER BUTTONS** to select the track Number and then press **27** to move the cursor to **START**, press **ENTER** to start program playing; move the cursor to EXIT and press ENTER to exit the program playing. Move the cursor to **⏮** and press ENTER to the previous page; move the cursor to **⏭** and press ENTER to the next page. During this process, press **18** ■ to cancel the program playing.

Note:

- * This function is operated by using the remote control.

Remote Control

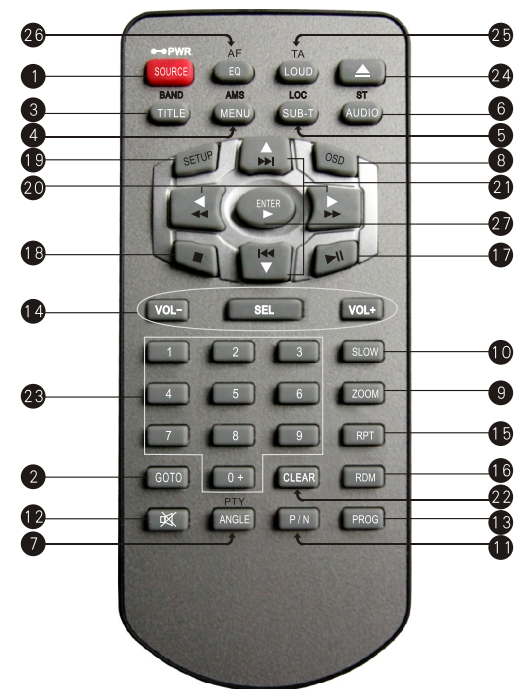

Tips:
For more information as to replacing battery, please refer to **Replacing the Battery** on page 6.

Before You Start

- | | |
|--|---|
| 1 SOURCE/PWR(mode switch /turn on or off) | 14 VOL+/VOL-/SEL |
| 2 GOTO (playing time/track) | 15 RPT(Repeat Playing) |
| 3 BAND/TITLE(band selection/tiele menu) | 16 RDM (Playing Tracks at Random) |
| 4 AMS/MENU(preset stations,memory automatically/menu) | 17 (Pause/Play) |
| 5 LOC/SUB -T(long distant or local station selection/subtitle display) | 18 (Stop Playing) |
| 6 ST/AUDIO (mono or stereo/language or channel selector) | 19 SETUP |
| 7 PTY/ANGLE(program type /play angle) | 20 (F.F/F.R) |
| 8 OSD
Briefly press it to display the current information;press and hold it to display the current setup. | 21 (Previous/Next Track) |
| 9 ZOOM (to increase the picture) | 22 CLEAR |
| 10 SLOW (Slow Forward/Reward) | 23 0~9 (Number) Buttons |
| 11 P/N(system adjusting) | 24 (Eject Button) |
| 12 Mute | 25 TA/LOUD(traffic alarm/ loudness) |
| 13 PROG(Program playing) | 26 AF/EQ (alternative frequency/equalizer button) |
| | 27 (Left/Right/Up/Down ENTER) |

VCD/CD

System Switch

During VCD mode, Press **11** P/N on remote control to set switch to PAL or NTSC or AUTO system.



Note:

* This function is operated by using the remote control.

Slow motion playback

During VCD mode, press **10** SLOW to slow forward or slow backward. There are speeds as follow:.

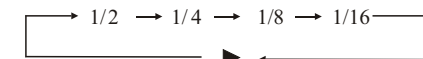

Note:

* This function is operated by using the remote control.

Increase the size of the picture

During VCD mode, Press **9** ZOOM to increase the picture in size. There are sizes as follow, Each pressing increases the size until the maximum size is reached.

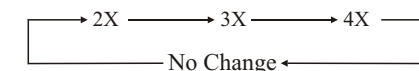

Note:

- * This function is operated by using the remote control.
- * To remove the image by press **27** button.

On Screen Display

During VCD/CD status, brief press **8** OSD button the display shows:

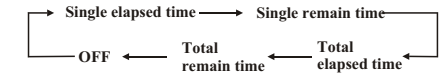

Press and hold **8** OSD to display the current time.

Note:

* This function is operated by using the remote control.

Setting the Playback Time

During CD playback, first press **2** GOTO, and TFT shows : *disc go to:--:--*,press your desired time of the playback by using number buttons.

Secondly press GOTO button, *track go to :--:--* appears on TFT, also input your desired numbers to play the current time of your selection.

During VCD mode, press **2** GOTO button to set the playing time, when the TFT display : *track/disc time/track time/repeat /time disp.* Press **27**[] [] to select the options, press ENTER to set the status. Then press **23**NUMBER BUTTONS to set the current status.



Note:

* This function is operated by using the remote control.



Playing a VCD/CD

Insert a VCD/CD disc into the slot, the unit will automatically switch on, if a disc is loaded, press SOURCE to start the playback.





Note:

- * You can eject a disc by pressing EJECT button on the base or  on the remote control or  in the monitor.

Selecting Tracks Fast

During VCD/CD playback, first press  to return to the beginning of the current track, press  again within 3 seconds to play previous track, press  to play next track.

Note:

- * Pressing  and  button on the head unit or  and  in the monitor also performs the same function.

Repeat Playing

During VCD/CD playback, press  RPT to perform replaying function, first press it to replay the current track, press it again to cancel this function.

Note:

- * This function is operated by using the remote control.
- * The default setting is Disc Repeat.

Playing Tracks at Random

During VCD/CD playback, press  RDM button on the remote control to play any track at random which you select. Press it again to return to normal playing.

Note:

- * This function is operated by using the remote control.





Number Buttons

Press one of  Number Buttons(0~9) to select a track to play automatically.

Note:

- * This function is operated by using the remote control.
- * Press  CLEAR to clear the mistake input.

Stop Playing

During VCD/CD playback, firstly Press  button then press  or  to replay, press  again to stop the playback.



Note:

- * Press  in the monitor performs the same function.

Pause the Playback

During VCD/CD playback, press  to switch between play and stop.

Note:

- * Press  in the monitor or  on the head unit performs the same function.

Skip backward/forward/F.F /F.REW the playback

Press  (← or →) on remote control to perform fast reward or fast forward. Each press will change as the following:

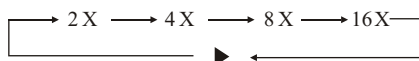

Note:

- * Press  and  in the monitor performs the same function.

Specifications

General

Power Requirement	14.4V DC (11-16V allowable)
Load Impedance	4Ω
Max.Power Output	85W x 4
Tone Controls	±10dB Bass 100Hz Treble 10KHz
Dimensions	Approx.160x178 x 50 mm (d/w/h)
TFT Sizes	Approx.170 x 117.5x16.5 mm (d/w/h)
Angle between folded and unfolded	30~100
Weight	Approx.2.3kg

FM Section

Tuning Range (Optional)	87.5-108(MHz) (Europe) 87.5-107.9(MHz) (U.S.A.)
IF Range	10.7MHz
Usable Sensitivity (-30dB)	10dBuV
Signal-to-noise Ratio	50dB
Stereo Separation	30dB (1KHz)
Frequency Response	20Hz-10KHz

AM Tuner Section

Frequency Range (Optional)	522-1620(KHz) (Europe) 530-1710 (KHz) (U.S.A.)
IF Range	450KHz
Usable Sensitivity (-20dB)	32dBuV

DVD/VCD/CD Player Section

VCD Signal System	AUTO/PAL/NTSC
Frequency Response	20Hz to 20KHz
Signal-to-noise Ratio	60dB
Separation	55dB(1KHz)
Distortion	1%

Note:
Due to continuous product improvement, specifications and design are subject to change without prior notice.

Wiring Connection

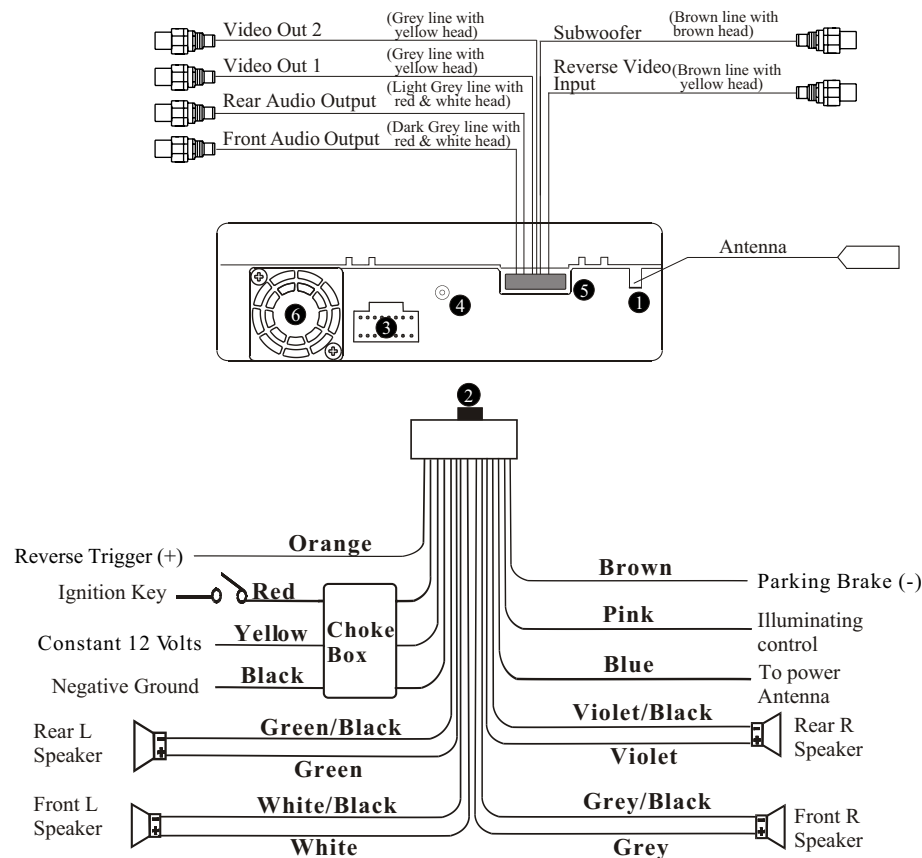

- | | |
|-------------------------|--------------|
| ① Antenna Receptacle | ④ Screw Hole |
| ② Output Plug(Male) | ⑤ Wire Clip |
| ③ Output Socket(Female) | ⑥ Fan Window |

Note:

- * The brown wire is connected with brake signal; for safety, the programs can be seen on the monitor after braking the car, but the menu and RCA output are free of it.
- If you do not want to use this function, connect it with the negative pole.
- Do not connect the pink wire to the battery, otherwise it will use up the power of battery.

Skip backward/forward/F.F /F.REW the playback

During MP3/USB/SD mode, Press **20** (◀◀ or ▶▶) on remote control to perform fast reward or fast forward. Each press will change as the following:

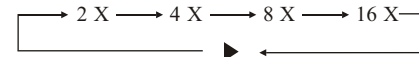

Note:

- * Press ◀◀ and ▶▶ in the monitor performs the same function.

On Screen Display

Hold and press **8** OSD button to display the current time.

Note:

- * This function is operated by using the remote control.

Exit an USB

During USB mode, the main unit would switch to SD or DISC mode, if the previous status is SD or DISC, otherwise the main unit would switch to TUNER mode when exit the USB.

During other modes, the main unit will keep the previous mode when exit the USB.

Exit a SD Card

Push SD card to exit it.

During SD mode, the main unit would switch to USB or DISC mode, if the previous status is USB or DISC, otherwise the main unit would switch to TUNER mode when exit the SD card.

During other modes, the main unit will keep the previous mode when exit the SD card.

Playing a MP3/USB/SD Disc

Insert a MP3 disc into the slot, the programs in the disc will be played, if a MP3 disc is loaded, press SOURCE to start the playback.

Insert an USB into the slot, the programs in the USB will be played, if there has an USB, press SOURCE to start the playback.

Insert a SD card into the slot, the programs in the card will be played, if there has SD card, press SOURCE to start the playback.

When playing a disc included PIC file, first press **18** ■, then press **[▲][▼]** to select the option.

Note:

- * You can eject a disc by pressing **EJECT** button on the base or **▲** on the remote control or **▲** in the monitor.
- * After inserts USB or SD must wait for 20 seconds to be able to eject the disc.

Selecting Tracks Fast

During MP3/USB/SD playback, press **27** ▲ to play the previous track, Press **27** ▼ to play next track.

Note:

- * Pressing **⏮** and **⏭** button on the head unit or **⏮** and **⏭** in the monitor also performs the same function.

Repeat Playing

During MP3/USB/SD playback, press **15** **RPT** to replay the current track, press it again to cancel this function.

Note:

- * This function is operated by using the remote control.
- * The default setting is single Repeat.

Number Buttons

Press one of **23** **Number Buttons(0~9)** to select a track to play automatically.

Note:

- * This function is operated by using the remote control.
- * Press **22** **CLEAR** to clear the mistake input.

Stop Playing

During MP3/USB/SD playback, Press **18** ■ to stop the playback.

Note:

- * Press **■** in the monitor performs the same function.

Selecting Tracks

During MP3/USB/SD mode, firstly press **2** **GOTO** and the TFT shows:---. Then press **23** **NUMBER BUTTONS** to input the track's Number to play it; secondly press **GOTO** button, and the TFT shows: ---:-- ,now input the desired Number to play the current track at this point.

Note:

- * This function is operated by using the remote control.

Pause the Playback

During MP3/USB/SD playback, press **17** **⏸** to switch between play and stop.

Note:

- * Press **⏸** in the monitor or **⏸** on the head unit performs the same function.

Install the Unit

Main Parts List

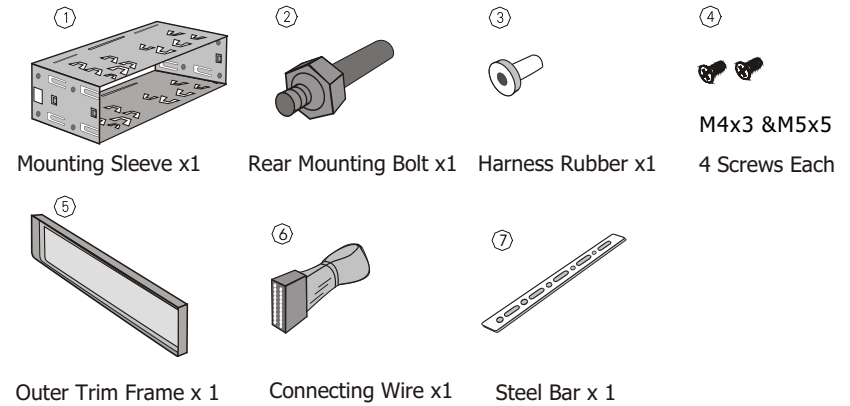

Installation Method ①: DIN Front-Mount

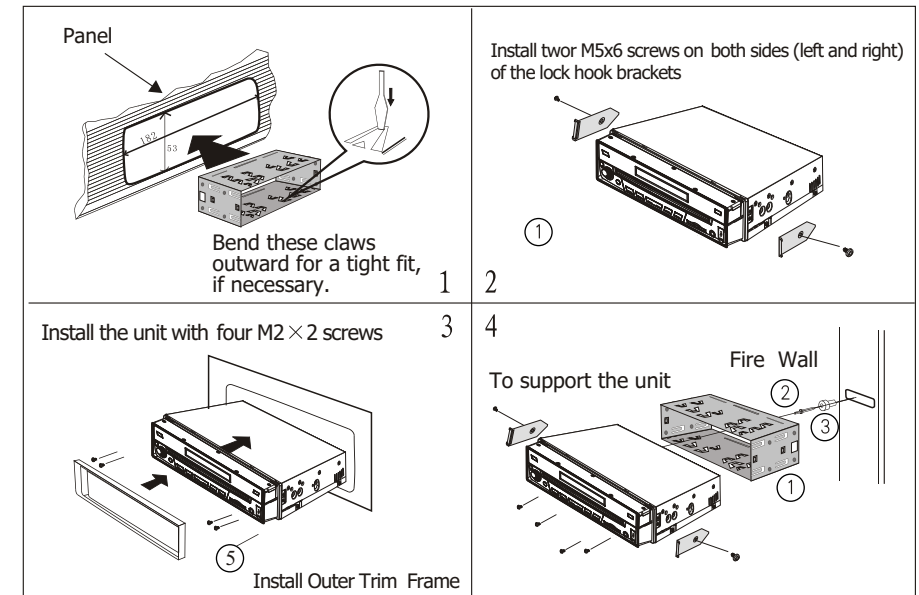

Install the Unit

Installation Method

Installation using the screw holes at the sides of the unit.

Select a position where the screw holes of the mounting bracket supplied with the car and the screw holes of the main unit become aligned (are fitted), and tighten the screws (see ④ at 2 places on each side). And then fasten them to the car.

- Note:
Outer Trim Frame ⑤ and Mounting Sleeve ① are not used for installation method.

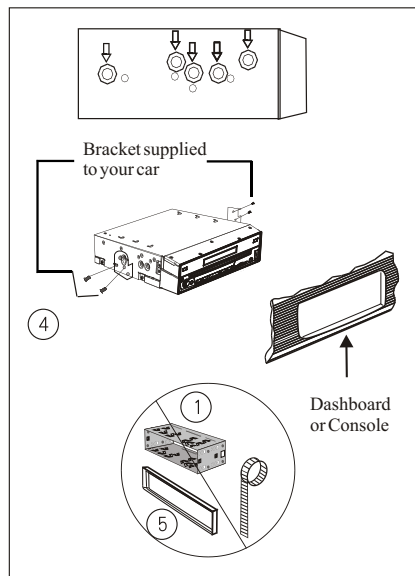

Detach the Unit

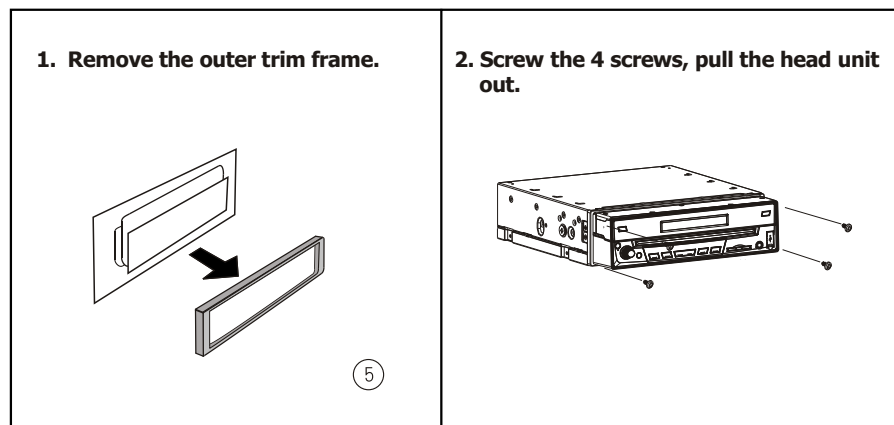

---Preferences page---

Default Example showing how to set load factory setting:

(Press ▲ or ▼)

(Press ►, ▲ or ▼, then press ENTER)

--Preference Page--	
TV Type	Auto
Audio	Eng
Subtitle	Eng
Disc Menu	Eng
Parental	
Password	
Default	

Go To Preference Page

→

--Preference Page--	
TV Type	Auto
Audio	Eng
Subtitle	Eng
Disc Menu	Eng
Parental	
Password	
Default	Reset

Load Factory Setting

---Preferences page---

Disc Menu Example showing how to set Disc Menu Language:

(Press ▲ or ▼)

--Preference Page--	
TV Type	Auto
Audio	Eng
Subtitle	Eng
Disc Menu	Eng
Parental	
Password	
Default	

Go To Preference Page

➔

(Press ▶, ▲ or ▼, then press ENTER)

--Preference Page--		English
TV Type	Auto	French
Audio	Eng	Spanish
Subtitle	Eng	Chinese
Disc Menu	Eng	Japanese
Parental		Korean
Password		Russian
Default		Thai

Preferred Menu Language

Parental Example showing how to set parental control:

(Press ▲ or ▼)

--Preference Page--	
TV Type	Auto
Audio	Eng
Subtitle	Eng
Disc Menu	Eng
Parental	
Password	
Default	

Go To Preference Page

➔

(Press ▶, ▲ or ▼, then press ENTER)

--Preference Page--		2 G ▲
TV Type	Auto	3 PG
Audio	Eng	4 PG 13
Subtitle	Eng	5 PGR
Disc Menu	Eng	6 R
Parental		7 NC 17
Password		8 Adult
Default		Off

Set Parental Control

Password Example showing how to set password, and the default password is 8888.

(Press ▲ or ▼)

--Preference Page--	
TV Type	Auto
Audio	Eng
Subtitle	Eng
Disc Menu	Eng
Parental	
Password	
Default	

Go To Preference Page

➔

(Press ▶, ▲ or ▼, then press ENTER)

--Preference Page--		Change
TV Type	Auto	
Audio	Eng	
Subtitle	Eng	
Disc Menu	Eng	
Parental		
Password		
Default		

Change Password

Install the Front Panel

Put notch (A) (shown as picture) onto shaft (B). And then slightly press into the right side.

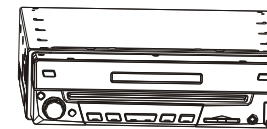
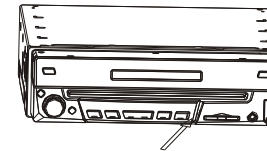
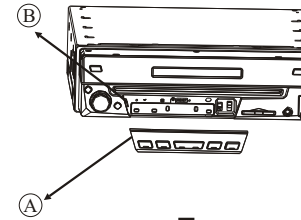

Detach the Front Panel

Press REL button in the upper right corner, and then the front panel will be folded down.

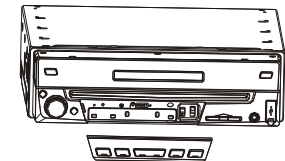
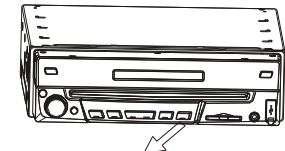
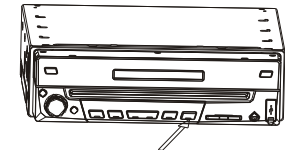

Reset the Unit

Operating the unit for the first time or after replacing the car battery, you must reset the unit.

Release the front panel at first, and then Press **9** **RESET** button in the panel with a pointed object, (such as a ballpoint pen) to set the unit to initial status.

Note:

- * When some errors occur on the display, you can also press **RESET** button to resume to normal, and it will erase the clock setting and some memorized functions.
- * This function can only be operated by the head unit.

Turning the Unit On/Off

Press **1** **PWR** button to turn on the unit, press it again, the unit is still in the waiting status. When insert a disc, the unit will automatically start playing. Keep pressing it more than 0.5 seconds to turn off the unit completely.

Note:

- * Pressing **POWER** button on the head unit also performs the same function.
- * During playback status, it will play automatically after inserting a disc.

Volume Control

Press **14** **VOL+** button to increase the sound level and press **14** **VOL-** button to decrease the sound level.

Note:

- * Rotating **7** on the head unit also performs the same function.

Setting the Sound Characteristics

Repeatedly press **14** **SEL** button to select the desired mode in the following order:



After selecting the desired mode, you can adjust the current level by pressing **14** **VOL** buttons.

Note:

- * Pressing **7** button and rotating it on the head unit also performs the same function.

EQ Setting

While listening to the popular music, classic music or rock music, you can select the corresponding preset modes to adjust the sound quality perfectly by using **26** **EQ** button.

Repeatedly keep pressing **26** **EQ** button to choose the following modes in turn:

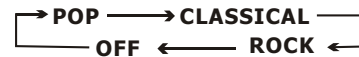

The default setting is OFF.

Note:

- * Press and hold **EQ** on the head unit also performs the same function.

Turning Loudness On/Off

keep pressing **25** **LOUD** button activates this feature. You can press this button to increase the low frequency, which can improve sensitivity for your ears. Keep pressing it again to stops this function.

Note:

- * This function is operated by using the remote control only.

---Preference page---

TVType Example showing how to set TV type:

(Press **▲** or **▼**) (Press **▶**, **▲** or **▼**, then press **ENTER**)

--Preference Page--	
TV Type	Auto
Audio	Eng
Subtitle	Eng
Disc Menu	Eng
Parental	
Password	
Default	

Go To Preference Page

→

--Preference Page--		
TV Type	Auto	PAL
Audio	Eng	Auto
Subtitle	Eng	NTSC
Disc Menu	Eng	
Parental		
Password		
Default		

Set TV Standard

Audio Example showing how to set Audio language:

(Press **▲** or **▼**) (Press **▶**, **▲** or **▼**, then press **ENTER**)

--Preference Page--	
TV Type	Auto
Audio	Eng
Subtitle	Eng
Disc Menu	Eng
Parental	
Password	
Default	

Go To Preference Page

→

--Preference Page--		
TV Type	Auto	English
Audio	Eng	French
Subtitle	Eng	Spanish
Disc Menu	Eng	Chinese
Parental		Japanese
Password		Korean
Default		Russian
		Thai

Preferred Audio Language

Subtitle Example showing how to set subtitle language:

(Press **▲** or **▼**) (Press **▶**, **▲** or **▼**, then press **ENTER**)

--Preference Page--	
TV Type	Auto
Audio	Eng
Subtitle	Eng
Disc Menu	Eng
Parental	
Password	
Default	

Go To Preference Page

→

--Preference Page--		
TV Type	Auto	English
Audio	Eng	French
Subtitle	Eng	Spanish
Disc Menu	Eng	Chinese
Parental		Japanese
Password		Korean
Default		Russian
		Thai

Preferred subtitle Language

--Dolby Digital Setup--

Dual Mono Example showing how to set stereo mode:

(Press ▲ or ▼)

--Dolby Digital Setup--

Dual Mono
Dynamic

Go To Dolby Digital Setup

⇒

(Press ▶, ▲ or ▼, then press ENTER)

--Dolby Digital Setup--

Dual Mono	Stereo
Dynamic	L-Mono
	R-Mono
	Mix-Mono

Dual Mono (1+1) Setup

Dynamic Example showing how to set dynamic range compression:

(Press ▲ or ▼)

--Dolby Digital Setup--

Dual Mono
Dynamic

Go To Dolby Digital Setup

⇒

(Press ▶, ▲ or ▼, then press ENTER)

--Dolby Digital Setup--

Dual Mono
Dynamic

Set DRC off

--- FULL
--- 3/4
--- 1/2
--- 1/4
--- OFF

Eject a Disc

Press ② EJ button to eject or insert a disc.

▣ **Note:**

- * Briefly Pressing ▲ on the remote control also performs the same function.

Open the Monitor

Press ⑮ OPEN button to slant the monitor or telescopes into.

▣ **Note:**

- * Keep pressing ▲ on the remote control also performs the same function.
- * The unit is running after the monitor telescopes into.

Angle Setting

Press ⑤ ▲ and ⑥ ▼ to adjust the best position of the monitor. Press ▲ to adjust monitor backward by definite angle, press ▼ to adjust it forward.

▣ **Note:**

- * when adjusting the monitor angle, please press this button, or the monitor would be broken.
- * This function is only operated by using the head unit.

Mute Function

Press ⑫ MUTE button to shut off the sound output. And “” appears on the LCD. Press it again to resume to previous volume level.

▣ **Note:**

- * Pressing MUTE on the head unit also performs the same function.

Clear

If input some wrong selection, press ⑳ CLEAR button to clear it.

▣ **Note:**

- * This function is only valid on remote control.

Mode Selector

Repeatedly briefly pressing ① SOURCE button to select radio mode or playback mode.

▣ **Note:**

- * Briefly pressing SOURCE on the head unit also performs the same function.

Menu Setup Button

During MAIN MENU SETUP/DVD MENU mode, briefly press ⑰ SETUP to turn on or turn off DVD Menu, press and hold it to turn on or turn off Main Menu Setup.

▣ **Note:**

- * Press ① MENU on the head unit to turn on the DVD Menu and Main Menu, and press ⑬ ⏪ to back out the previous menu.

Infrared Sensor:

Receptor ⑧ on the head unit for the remote control.

Ejecting a stuck Disc

During playback, if it can not be played normally or the disc can not eject, briefly press SRC on the head unit to switch to the radio mode, hold and press the EJ button 3 seconds, the disc will be eject.

Set up Main Menu

When the unit is on, the monitor will display the menu as follows:



Hold and press **SETUP** on the remote control or **MENU** on the head unit, or press **MENU** in the monitor to enter the menu as follows:

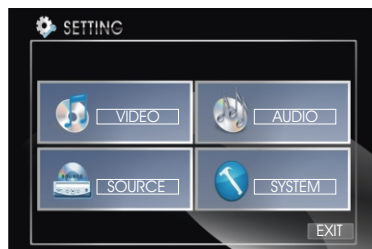

This menu includes **AUDIO**, **VIDEO**, **SOURCE**, **SYSTEM**, **EXIT**. Press them in the monitor to set the desired status.

Note:

* Press and hold **SETUP** or press **MENU** on the head unit to set up this menu; press the monitor to select the option.

1.Audio Adjust

After selecting **AUDIO**, the sub menu will appear as follows:

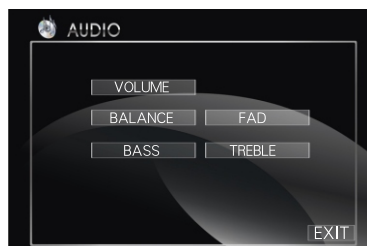

You can adjust **VOLUME**, **BALANCE**, **FAD**, **BASS**, **TREBLE**. For example, press **FAD**, the setting menu will appear as follow:



Press **◀** and **▶** to adjust the desired **FAD** level, press **EXIT** to exit this menu.

Note:

* Adjusting the other options perform the same operation.

--General Setup Page--

Captions

Example showing how to set captions on/off:

(Press **▲** or **▼**)

--General Setup Page--

TV Display	Wide
Angle Mark	On
OSD Lang	Eng
Captions	Off
Screen Saver	On

Go To General Setup Page

(Press **▶**, **▲** or **▼**, then press **ENTER**)

--General Setup Page--

TV Display	Wide	
Angle Mark	On	
OSD Lang	Eng	
Captions	Off	On
Screen Saver	On	Off

Closed Captions

Screen Saver

Example showing how to set Screen Saver on/off:

(Press **▲** or **▼**)

--General Setup Page--

TV Display	Wide
Angle Mark	On
OSD Lang	Eng
Captions	Off
Screen Saver	On

Go To General Setup Page

(Press **▶**, **▲** or **▼**, then press **ENTER**)

--General Setup Page--

TV Display	Wide	
Angle Mark	On	
OSD Lang	Eng	
Captions	Off	
Screen Saver	On	On
Screen Saver	On	Off

Screen Saver

--General Setup Page--**TV Display**

Example showing how to set TV Display mode:

(Press ▲ or ▼)

--General Setup Page--

TV Display	Wide
Angle Mark	On
OSD Lang	Eng
Captions	Off
Screen Saver	On

Go To General Setup Page



(Press ►, ▲ or ▼, then press ENTER)

--General Setup Page--

TV Display	Wide	Normal/PS
Angle Mark	On	Normal/LB
OSD Lang	Eng	Wide
Captions	Off	
Screen Saver	On	

Set TV Display mode

Angle Mark

Example showing how to set picture mode:

(Press ▲ or ▼)

--General Setup Page--

TV Display	Wide
Angle Mark	On
OSD Lang	Eng
Captions	Off
Screen Saver	On

Go To General Setup Page



(Press ►, ▲ or ▼, then press ENTER)

--General Setup Page--

TV Display	Wide	
Angle Mark	On	On
OSD Lang	Eng	Off
Captions	Off	
Screen Saver	On	

Set Angle Mark

OSD Lang

Example showing how to set language mode:

(Press ▲ or ▼)

--General Setup Page--

TV Display	Wide
Angle Mark	On
OSD Lang	Eng
Captions	Off
Screen Saver	On

Go To General Setup Page



(Press ►, ▲ or ▼, then press ENTER)

--General Setup Page--

TV Display	Wide	English
Angle Mark	On	French
OSD Lang	Eng	German
Captions	Off	Spanish
Screen Saver	On	Italian
		Dutch
		Portuguese

Set OSD Language

2.Video Adjust

After selecting VIDEO, the sub menu will appear as follows:

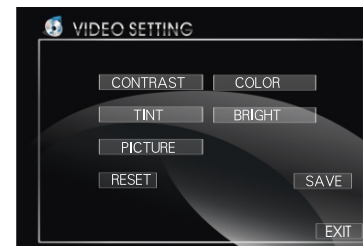

In this menu you can adjust CONTRAST, COLOR, TINT, BRIGHT, PICTURE, EXIT.

Picture Adjust

Press PICTURE in this menu, it will appear as follows:

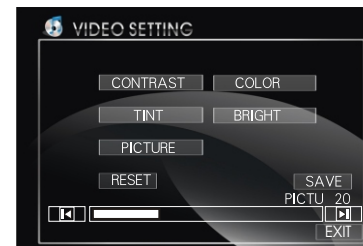

Press ◀ and ▶ to adjust the size, then press SAVE to save the setup, press EXIT to exit this menu.

Note:

* Adjusting the other options perform the same operation.

3.Source Adjust

In the main menu, press SOURCE in the monitor, the sub menu will appear as follows:



You can adjust TV, CDC, GPS and AUX to ON or OFF, press the corresponding button to set.

If one of them was set OFF, that function is null. For example, to set the AUX OFF, press SOURCE can not activate AUX function. But can not set the current playback OFF.

Note:

* If the item can not be set "ON", then this model does not contain this function.

4.System Adjust

After selecting SYSTEM, the sub menu will appear as follows:



In this menu you can adjust CLOCK SYSTEM, KEY BEEP, MONITOR FLEX and so on.

🔧 Clock System

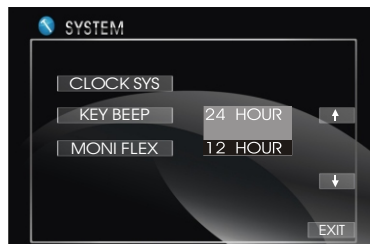

Press **CLOCK SYSTEM** in the monitor to set 12 HOUR or 24 HOUR in this menu.

🔧 Key Beep

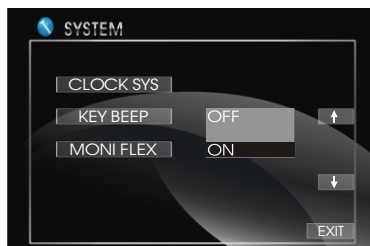

In this menu you can adjust **KEY BEEP**, press it in the monitor and select **ON** or **OFF**, the default setting is **ON**, it means when you press the keys, they sounded.

🔧 Monitor Flex

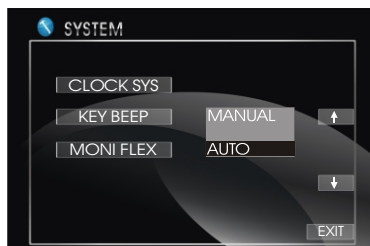

In this menu you can adjust **MONITOR FLEX**, press it in the monitor and select **MANUAL** or **AUTO**, the default setting is **AUTO**, it means the monitor will flex automatically.

🔧 Next Setup

Press **↓** to display the menu follows, press **↑** to display the previous one.

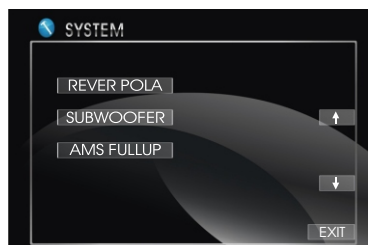

🔧 Reverse Pola

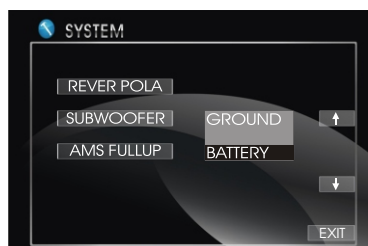

Setting **REVERSE POLA** in this menu. The signal is +12V when you are backing up a car, please press **BATTERY** in the monitor; if the signal is 0V, please press **GROUND**.

🔧 Subwoofer

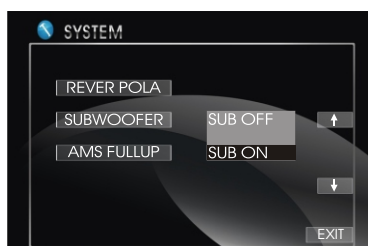

In this menu you can adjust **SUBWOOFER**, press it in the monitor and select **ON** or **OFF**, the default setting is **ON**.

Changing audio language (Multi-audio)

DVD's can provide audio playback with different language. With DVD's featuring multi-audio recordings, you can press **6** **AUDIO** to switch between language and audio systems during playback.

Selection options switch as follows:

AUDIO 1 — **AUDIO 2** — **AUDIO 3**

▣ Note:

- * This function is operated by using the remote control.
- * This function only operates with DVD's featuring multi-audio recordings.
- * The number in the “**6**” mark on a DVD's package indicates the number of recorded languages/audio systems.

Changing the subtitle language (Multi-subtitle)

With DVD's featuring multi-subtitle recordings. You can press **5** **SUB-T** to switch between subtitle languages during playback.

Selection options switch as follows:

Subtitles 1 — **Subtitles 2** — **Subtitles OFF**

▣ Note:

- * This function is operated by using the remote control.
- * This function only operates with DVD's featuring multi-subtitle recordings.
- * The number in the “**5**” mark on a DVD's package indicates the number of recorded subtitle languages.

Selecting MENU

- 1 **Selecting Menu:** During DVD status, press **4** **MENU** to return to the root menu, all of the chapters will appear on monitor. You can press **27** or **23** button to select your desired chapter.
- 2 **Selecting Title:** During DVD status, press **3** **TITLE** to return the title menu, all of the titles will appear on monitor. You also can press **27** or **23** button to select your desired chapter.

▣ Note:

- * The function is only valid on remote control.

DVD SETUP MENU

Briefly press **19** **SET UP** on remote control or briefly press **1** **MENU** on the head unit, main menu and sub-menu will appear on TFT, pressing **27** [**▲**] [**▼**] [**▶**] [**◀**] on remote control to select your desired items, then press **ENTER** on remote control to confirm. Press **13** [**⏪**] to back out. Press [**▶**] [**◀**] on the head unit to choose left or right direction.

▣ Notes:

- * The selections are the preferred options that will be chosen if they are available on a disc. If the disc that is inserted does not have the preferred option then the discs own preference will be used.
- * Regarding **SETUP MENU**, please refer to the following pages for more details.
- * Some functions varies depending on the types of models or formats of the disc.

System Switch

During playback mode, Press **11** P/N on remote control to set switch to PAL or NTSC or AUTO system.



Note:

- * The function can be operated by selecting the DVD MENU SETUP.

Slow motion playback

During DVD mode, press **16** SLOW to slow forward or slow backward. Here are the speeds for this feature:



Note:

- * The function is only valid on remote control.

Increase the size of the picture

During DVD mode, Press **9** ZOOM to increase the picture in size. Here are the speeds for this feature, Each press increases the size until the maximum size is reached.

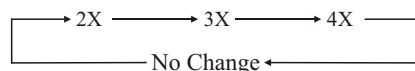

Note:

- * The function is only valid on remote control.
- * To remove the image by press **27** button.

On Screen Display

During DVD status, press **8** OSD button the display shows:

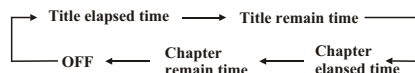

Press and hold **8** OSD to display the current time.

Note:

- * This function is operated by using the remote control only.

DVD Playback Setting

During DVD mode, press **2** GOTO button to set the playing time, when the TFT display : *title/chapter/audio/subtitle/angle /title time/chapter time/repeat /time disp.* Press **27** [▲] [▼] to select the options, press ENTER to set the status. Then press **NUMBER BUTTONS** or **27** [▶] [◀] to set the current status.

Note:

- * This function is operated by using the remote control only.

Changing the viewing angle (Multi-angle)

With DVDs featuring multi-angle (scenes shot from multiple angles) recordings, you can press **7** ANGLE to switch among viewing angles during playback.

Selection options switch as follows:

ANGLE 1 — **ANGLE 2** — **ANGLE 3**

Notes:

- * This function is operated by using the remote control only.
- * This function only operates with DVDs featuring multi-angle recordings.
- * The “” mark on a DVD's package indicates it features multi-angle scenes. The number in the “” mark indicates the number of angles from which scenes were shot.
- * It is invalid to pressing ANGLE during fast forward/fast reverse or pause.

AMS Fullup

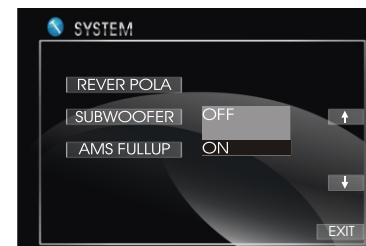

In this menu to set the modes of AMS. When the setup is ON, the presettable stations are full, no new one's can be added. When you select OFF, it will searching continually.

Press **↓** to display the menu follows, press **↑** to display the previous one.



To set the above options as the same operation.

Local Area



You can select EUROPE or USA to search the stations quickly by your current area, also, you can select FM ONLY to receive the FM stations only.

Local

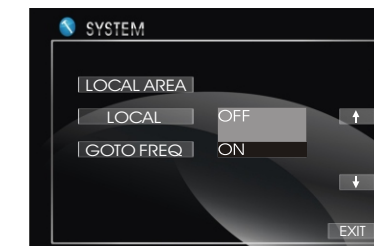

In this menu to search the LOCAL stations, when selected ON, the strong signal local stations can be received, when selected OFF, the week signal out-of-town stations may be received.

Goto FREQ

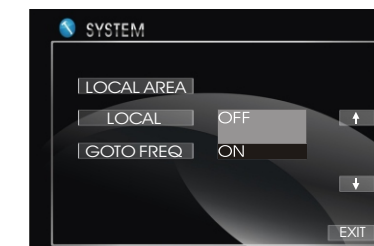

To select ON, you can using GOTO button on the remote control to select a station's frequency directly in radio mode.

RT Scroll

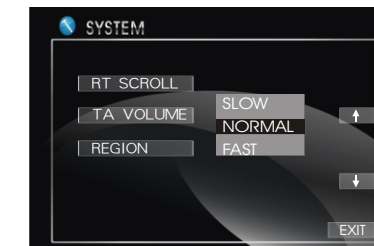

To select your desired speed, SLOW, NORMAL, FAST. The default settings is NORMAL.

TA Volume

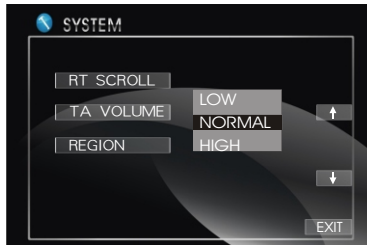

To select your desired volume, LOW, NORMAL, HIGH. The default settings is NORMAL.

REGION

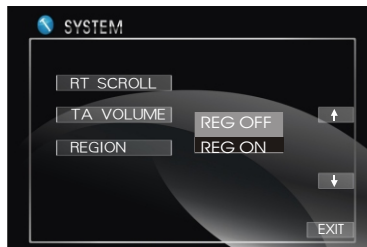

To set the AF searching region, the default setting is ON.

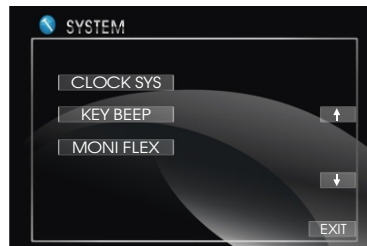

(Picture 1)

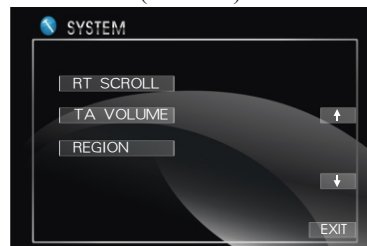

(Picture 2)

Press \uparrow in picture 1 or press \downarrow in picture 2 to enter the following menu:

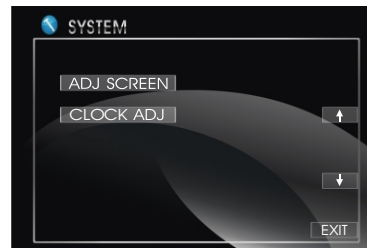

Adjust Screen



Press ADJ SCREEN to display the above menu, there are a square button in the top left corner. Press the square button at place ①, then the button will move to place ②, press it at place ②, it will move to place ③, then place ④, press SAVE at last.

Clock Adjust

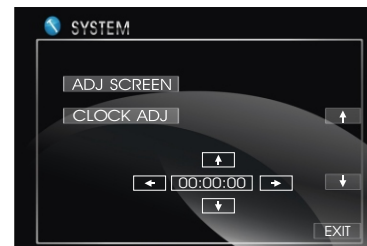

Press CLOCK ADJ in the monitor to adjust the clock.

Playing a DVD

Insert a DVD disc into the slot ⑭, the unit will automatically switch on, if a DVD disc is loaded, press **SOURCE** to start the playback.

Note:

- * You can eject a disc by pressing **EJECT** button on the base or \triangle on the remote control or \triangle in the monitor.

At the beginning of playing DVD, the monitor will display the menu as follows:

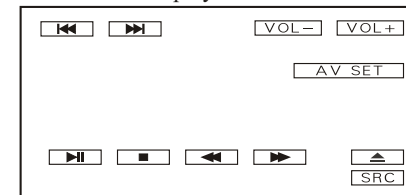

Note:

- * This menu appears by touch the monitor.

DVD SETUP

During DVD playback, select AV SET will appear the following menu:

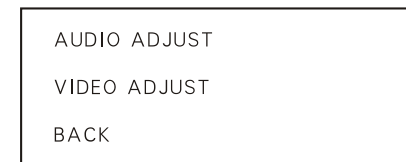

Note:

- * For more details please refer to pages 18 to 19.
- * To adjust VIDEO ADJUST, a DVD should be inserted and played normally at first.

Selecting Tracks Fast

During DVD playback, first press ② \lll to return to the beginning of the current track, press ② \lll again within 3 seconds to play previous track, press ② \ggg to play next track.

Note:

- * Pressing \lll and \ggg button on the head unit or \lll and \ggg in the monitor also performs the same function.

Stop the playback

During DVD playback, firstly press ⑬ \blacksquare to pause playing, then press ⑰ or ⑱ on the remote control to play. Press ⑬ \blacksquare twice to stop playing, press **PLAY** button to start playing.

Note:

- * Press \blacksquare and \blacksquare in the monitor performs the same function.

Pause the Playback

During DVD playback, press ⑰ \ggg to switch between play and stop; During stop mode, press this button to resume playback mode.

Note:

- * Press \ggg in the monitor or \ggg on the head unit performs the same function.

Skip backward/forward/F.F /F.REW the playback

Press ⑳ (\lll or \ggg) on remote control to perform fast reward or fast forward. Each pressing will change as follow:



Note:

- * Press \lll and \ggg in the monitor performs the same function.

Number Buttons

Press one of ⑳ Number Buttons(0~9) to select a track, it will be played automatically.

Note:

- * This function is operated by using the remote control.
- * Press ⑲ CLEAR to clear the mistake input.

Repeat Playing

During DVD playback, press ⑮ **RPT** on the remote control to perform replaying function as followings:

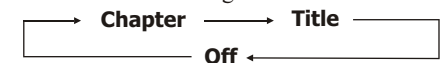

Note:

- * This function is operated by using the remote control.
- * The default setting is Disc Repeat.