

**User's Manual**

**BV9995B**

**BLUETOOTH®-ENABLED  
IN-DASH DVD/MP3/CD RECEIVER  
WITH MOTORIZED, FLIP-OUT 7" WIDESCREEN  
TOUCH SCREEN TFT MONITOR  
WITH USB AND SD MEMORY CARD PORTS  
AND FRONT PANEL AUX INPUT**

**RDS EUROPEAN FREQUENCY MODEL**



**BV9995B**

**BLUETOOTH®-ENABLED  
IN-DASH DVD/MP3/CD RECEIVER  
WITH MOTORIZED, FLIP-OUT  
7" WIDESCREEN TOUCH SCREEN TFT MONITOR  
WITH USB AND SD MEMORY CARD PORTS  
AND FRONT PANEL AUX INPUT**

**RDS EUROPEAN FREQUENCY MODEL**

12.2008



iPod is a trademark of Apple, Inc., registered in the U.S. and other countries.

**tech support: [www.bosssaudio.com/support](http://www.bosssaudio.com/support)**

**BOSS®  
AUDIO SYSTEMS**

**BOSS Audio Systems • 3451 Lunar Court • Oxnard, CA 93030  
[www.bosssaudio.com](http://www.bosssaudio.com)**

**800.999.1236**

**BOSS®  
AUDIO SYSTEMS**

1.9  
2.0  
2.1  
2.2  
2.3  
2.4  
2.5  
2.6



BV9995B

## CONTENTS

*Bluetooth-Enabled  
In-Dash DVD/MP3/CD Receiver  
With Motorized, Flip-Out 7" Widescreen  
Touch Screen TFT Monitor*

Welcome .....	3
Warning .....	3
Note .....	4
Features .....	5
Basic Operation .....	6
Panel Arrangement .....	7
Panel Button Control Instruction .....	8
Outlook And Basic Function .....	9
Main Menu Touch Operation .....	11
OSD Setup .....	12
Adjust Mode .....	13
Remote Control Function .....	14
Loading .....	16
Disc Play Touch Operation .....	17
DVD Mode .....	18
RDS User Operation .....	20
Radio Operation .....	22
DVD Basic Operation .....	23
VCD Basic Operation .....	33
CD/MP3 Basic Operation .....	36
Music Surroundings Setting .....	38
EQ Setting .....	39
Audio Frequency/Tone .....	40
BLUETOOTH Touch Operation .....	41
BLUETOOTH Operation & Setting-Up .....	42
Other Play Mode .....	43
Trouble Shooting .....	44
Wiring Diagram .....	45
Specifications .....	46
Accessory .....	47

## INSTRUCTIONS

### ACCESSORY

Accessory	Quantity
User Manual	1PC
Wire	1PC
USB Cable	1PC
Keys	2PCS
Install metal bar	1PC
Remote controller	1PC
Warranty card	1PC

## SPECIFICATIONS:

Power supply .....	DC 12V
Power range .....	10.8-16.0V DC
Max operate current .....	10A
Dimensions .....	155X182X53MM
Ground system.....	Negative ground
Amp Rating .....	85 Watts x 4 Channels

### FM tuner

European frequency range .....	87.5-108MHz
USA frequency range .....	87.5-107.9MHz
Signal/Noisse ratio.....	55dB
Stereo separation.....	30dB
Search station volt.....	20-30Buv
Distortion rate .....	1.5%

### AM tuner

European frequency range .....	522-1620KHz
USA frequency range .....	530-1710KHz
Limit noise sensitivity .....	32dB

### DVD PLAYER

Signal/Noise ratio .....	70dB
Frequency response .....	20Hz-20KHz

## WELCOME

Thank you for choosing Boss Audio for your A/V product.  
To properly use this product, please go through this instruction manual for installation and operation, put it in a safe place for future use!

## WARNING

1. Please keep the disc slot clean, wipe it off when there is some dirt on it. You should wipe off any dirt on the disc before you place it into the unit. If the disc is dirty and you place it inside the unit, it will cause the unit to go into an error and will not play the disc. Please ask professional to clean the laser.
2. Playing the radio at higher volumes for a long period of time may cause hearing issues. You should play this unit at a moderate listen level.
3. This unit is set up by precision parts. If you open up this unit, you will void any and all of your warranty.
4. Please do not touch LCD display with any hard object so that you prevent it from getting scratched or damaged.
5. To avoid an accident caused by watching the LCD screen. This unit has a vehicle lock out wire so that you will not be allowed to watch a video while driving down the road.
6. This unit is meant for a 12V power and negative ground system from a vehicle.



## NOTE:

We keep improving this product all the time. There may be some changes in it that are not in this manual.

# INSTRUCTIONS

## NOTE

- This unit can play the following disc

MODE	ICON	CONTENT	DISC SIZE
DVD		Sound, image	12cm
VCD		Sound, image	12cm
MP3	<i>MP3</i>	Sound only	12cm
CD		Sound only	12cm

Note: 1. This unit is compatible with MP4/DVD/VCD1.0/2.0/3.0 version, DVD, CD-R, CD-RW, MP3, WMA, JPEG.  
 2. When playing a DVD, VCD, MP3, CD disc the display will auto identify the disc and show corresponding word.  When appears on the display, that means that there is no function, please choose another mode.

# INSTRUCTIONS

## WIRING DIAGRAM

This player is equipped with ISO standard connector, please follow below instruction:

- Red - ACC ON (+12V)
- Yellow - 12 V Constant
- Black - Ground wire
- Blue - Power Antenna / Remote Amp Turn On
- Orange - Back-Up Camera Trigger (+)
- Grey/Grey black - Right front speaker (+/-)
- White/White black - Left front speaker (+/-)
- Purple/Purple black - Right rear speaker (+/-)
- Green/Green - Left rear speaker (+/-)
- Pink - Parking Brake (-)

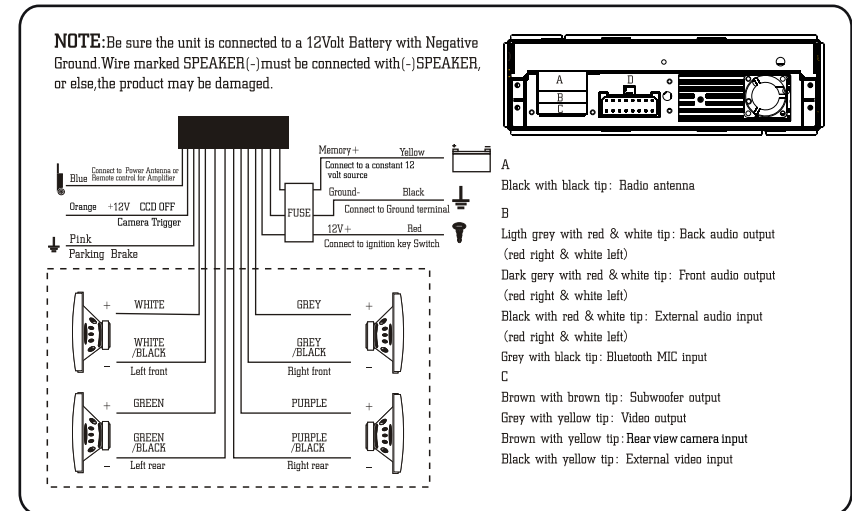

### Note:

The "PARKING BRAKE" wire must be connected to the parking brake system of your car. When the parking brake is engages, the LCD will be allowed to view your video. If not, the screen will produce an image saying, "PARKING BRAKE". This is a safety feature designed for the driver not to watch a video while driving. The video output on this unit will not be affected by this.

# INSTRUCTIONS

## TROUBLE SHOOTING

PROBLEM	CAUSE	SOLUTION
Can not power on	Check whether power fuse blew or not	Change fuse same as the old one
	Some factor cause MPU wrong operation	Press RESET button on the panel by pen point, then, power on
After ignition switch off, setting information all lose	Wrong connection between ignition line ACC and Constant 12 Volt wire	Change the wiring around
Remote control no function	No enough power supply from battery	Change battery in remote control
Poor performance of radio station	Improper length of antenna, poor connection of antenna grounding	Check whether antenna is connected or not, or poor connection
Can not load disc	The disc will not go in all the way	Remove the 2 screws on top of the radio
Can not play disc	Disc is scratched	Change new disc
	Put wrong side of disc into unit	Slot in the disc with sign side up
	Lens has dirty	Clean lens by lens clean disc
Can not switch language/subtitle	There is only one language/subtitle in disc	If disc is not with multi-language/subtitle, it cannot switch language/subtitle
No image	Video line between unit and TV is not properly connected	Reconnect lines

# INSTRUCTIONS

## FEATURES

### DVD PLAYER

1. MPEG-4 Decoder Technology
2. Compatible with MP4 (AVI/5.X), DVD (DVD-R/DVD-RW), VCD, SVCD, CD-RW, WMA, MP3, JPG
3. Supporting Multiple Subtitles, Angles, Languages
4. Child lock function
5. 4-Channel Audio Output
6. Pause, Play, Up/Down, Stop, Zoom, PBC Function

### RADIO

1. AM/FM Radio Tuner
2. 30 Radio Preset Stations (18FM, 12AM)

### BULETOOTH FUNCTION

1. Bluetooth wireless transfers
2. Displaying bluetooth pairing and connection status, call status, and caller's ID
3. Fast performance, fast connection, accurate and sensible search of devices in range
4. Support A2DP, AVRCP, HS/HF for handing calls and playing music

### LCD DISPLAY

1. 7" - 16:9 TFT LCD Display
2. Touchscreen

## BASIC OPERATION

### 1. SOURCE ON/OFF

Press SRC button on panel or SOURCE button on remote control quickly to power on.  
Press SRC button on panel or SOURCE button on remote control longer to power off.

### 2. PLAYING SOURCE CHOOSE

Press SOURCE button on remote control, unit will switch sources in the following sequence: RADIO → DVD → AUX

### 3. MUTE CONTROL

Press MUTE button on panel or MUTE button on remote control shortly to turn off sound output, press again to back to sound output.

### 4. VOLUME ADJUSTMENT

- 1) Press VOL+/VOL- button on panel, VOL+/VOL- button on remote control or touch button on display to adjust volume level.
- 2) The volume setting on this unit is 0 - 39.

### BASS, TREBLE, BALANCE & FADER ADJUSTING (SELECT)

Press SEL button on remote control to choose your desired Bass, Treble, Balance & Fader level:

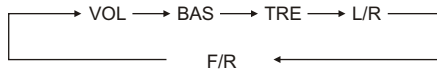

### NOTE:

- 1) DVD playing mode, MBP & User will be automatically activated.
- 2) After 5 seconds you choose desired mode, do not adjust volume button. The mode will automatically take you back to status before adjustment.

### 5. RESET

- 1) If unit is not working correctly, you should press the RES button. This will reset the radio and should start working correctly afterwards.
- 2) After reset, all settings will resume back to the factory default settings.

## OTHER PLAY MODE

### AUX IN:

### AUX IN OPERATION

- 1) Press "Source" button on remote control or touch "AUX" on the touch screen, to switch to AUX mode.
- 2) This will allow you to listen and or watch any source that you have plugged into this section of the radio.
- 3) This unit has 1 - Video RCA input & 1 pair of Audio RCA's for this feature.

### CCD (Back-Up Camera)

- 1) If there is a back-up camera installed onto your car, you will need to connect it to the CCD video input.
- 2) When you are backing up the car there you will see this image  on your screen.
- 3) You can set CCD image according to your car's own position in general setting mode.



## Contact book mode switching

You can touch this button under the Bluetooth mode to select the next mode.

- DIALED CALL** Touch this function key to search the dialed numbers. Each time this key is touched, the cursor will move to the next dialed number.
- RECEIVED CALL** Touch this function key to search the received numbers. Each time this key is touched, the cursor will move to the next received number.
- MISSED CALL** Touch this function key to search the missed numbers. Each time this key is touched, the cursor will move to the next missed number.

## Operations and Settings for the Bluetooth Function

### 1. Features of the Bluetooth function

- 1) You can use the function buttons on the unit to receive a call or dial a phone number.
- 2) You can directly use the hand-free microphone to talk on the phone.
- 3) You can use the build-in volume control switch to adjust the volume at will.
- 4) You can switch between the Bluetooth hand-free mode and the cell phone mode.
- 5) You can use your voice to dial a new number (valid only for cell phones with voice dialing function).
- 6) With the Bluetooth function, you can use the Bluetooth microphone in the car to talk with your folks and friends without having to hold your cell phone, so that your hands are dedicated for driving, which is safer and law-observing. In the mean time, magnetic radiation from the cell phone is avoided.

### 2. Bluetooth match conditions



You can shortly touch the Bluetooth function key under the main menu to directly access the Bluetooth interface. With a cell phone that supports the function of Bluetooth wireless connection, you can establish a connection between your cell phone and the automobile-loaded unit under the Bluetooth mode to achieve data exchange and synchronization.

### 3. Matching and connections between the cell phone and the Bluetooth of the unit

Set your cell phone to the Bluetooth mode, and use the cell phone to search equipments. After the Bluetooth equipment of the unit is searched, the cell phone will ask you for the Bluetooth password. Press the unit matching setup button , and enter the Bluetooth password (0000) and confirm it, and then the cell phone will ask you whether you authorize the connection with this equipment or not. Please select "YES", and the cell phone will be automatically connected with the said Bluetooth equipment within 30 seconds. "OK LINK" will be displayed on the Bluetooth interface to show that a connection between the cell phone and the Bluetooth device has been successfully established. Under and mode (radio, TV, DVD, etc.), if there is an incoming call to your cell phone which has been stably connected to the Bluetooth device of the unit, the unit will switch from other mode to the Bluetooth mode after the cell phone rings for about 10 seconds. Current mode will be automatically restored after hang-up.

## PANEL ARRANGEMENT

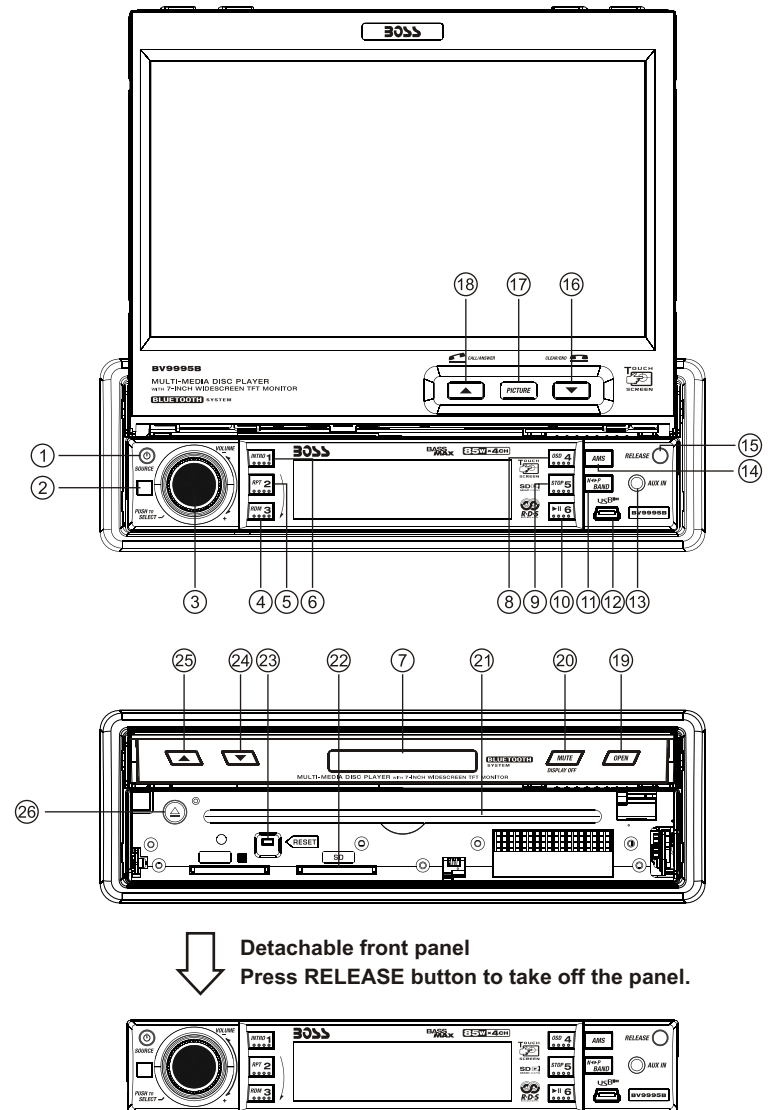

## PANEL BUTTON CONTROL INSTRUCTION

1. SRC On/Off / Function MODE button
2. Remote Controller Receiving Window
3. (VOL/SEL) Volume adjustment mode
4. Number Button 3/RDM (Random playback)
5. Number Button 2/RPT (Repeat Playback)
6. Number Button 1/INT (Intro Scan)
7. LCD Display window
8. Number Button 4/OSD
9. Number Button 5/ STOP
10. Number Button 6/PALY
11. BAND/SYS /P.N button
12. USB socket
13. Aux External Input
14. AMS Program Preset/Play Repeat button
15. Release button
16. DN Adjustment(TFT Screen)/Hang up
17. PIC Color Selection button
18. UP Adjustment(TFT Screen)/Hang-free
19. TFT Display Screen Extend/Retreat
20. MUTE / TFT on/off button
21. Disc load slot
22. SD socket
23. Reset button
24. DN Adjustment(TFT Screen)/Hang up
25. UP Adjustment(TFT Screen)/Hang-free
26. Disc out button

## BLUETOOTH TOUCH OPERATION (PIC 8)

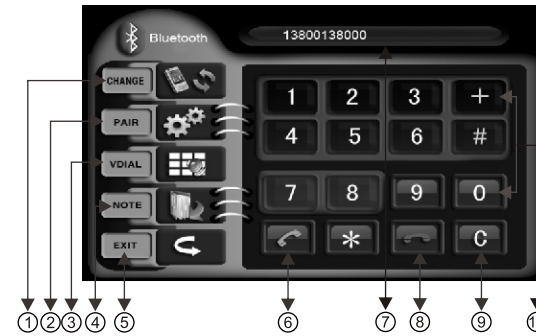

1. Bluetooth hand-free/cell phone switching
2. Matching function during Bluetooth connection
3. Voice dialing function
4. Contact book mode switching
5. Return to the main screen
6. Hand-free key
7. Phone number display
8. Hang-up key
9. Delete key
10. Number keys

### Functions and Descriptions

#### **Bluetooth hand-free/cell phone switching**

If you touch this switching button at the upper-left corner of the screen under the Bluetooth hand-free mode, the speaker will beep and the hand-free mode will be switched to the cell-phone mode.

#### **Voice dialing function**

If you touch the "Voice dial" button at the lower-left corner of the screen under the Bluetooth hand-free mode and the cell-phone mode, you will hear the keying tone, and you can go ahead with the voice dialing function according to the cell-phone instructions. Eg, if you wish to call someone, you can pronounce his/her name stored in the cell phone, then ,the name of the person to be called will be played by the speaker, and the telephone number of this person will be displayed on the screen and automatically dialed.

#### **To cancel voice dialing**

If you wish to disable the voice dialing function in the voice dialing mode, you can press the "Voice dialing" key again, and this function will be disabled after you hearing the keying tone.

 **Hand-free button:** After a phone number is keyed in, press this button to call the user of this phone number. When there is an incoming call. Press this button to connect this call.

 **Hang-up button:** When there is an incoming call, press this button to hang up or refuse to connect it.

 **Delete button:** When a wrong digit is keyed in, press this button to delete the wrong digit.

**Number keys:** You can use these number keys to enter a phone number.

**Phone number display:** The phone number that you have just entered is displayed here.



## AUDIO FREQUENCY

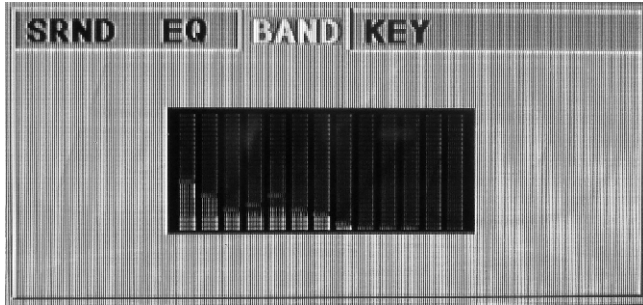

This function shows that the effect of standard audio output.

## TONE

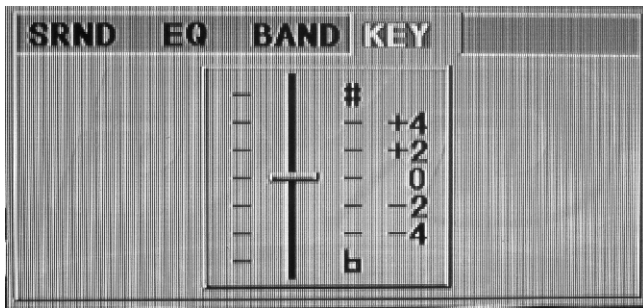

Note: You can change the timbre of the sound in DVD mode. We suggest keep it in the original place.

## OUTLOOK AND BASIC FUNCTION

### 1. Power On/Off / Function MODE button

Press this button for a short moment to turn on power, and long press it to turn off power. Every button-press to switch audio source mode.

### 2. Remote Controller Receiving Window

It receives infra red signals from the remote controller which fits this device.

### 3. (VOL/SEL) Volume adjustment mode

Repeat pressing this button can select the VOL. BAS. TRE. FAD adjustment mode. Then can rotate the button to adjust VOL. BAS. TRE. FAD as your likes.

### 4. Number Button 3/RDM (Random playback)

In radio mode, press this button to hear radio preset;  
In disc playback mode, press this button to play frocks on the disc in random order.

### 5. Number Button 2/RPT (Repeat Playback)

In radio mode, press this button to hear radio preset;  
In disc playback mode, press this button to repeat the current track indefinitely.

### 6. Number Button 1/INT (Intro Scan)

In radio mode, press this button to hear radio preset;  
In disc playback mode, press this button to start or stip the intro scan function.

### 7. LCD Display Window

Under radio mode, channel and frequency are displayed; Under play mode, the directory of the song and time elapsed are displayed.

### 8. Number Button 4/OSD

In radio mode, press this button to hear radio preset;  
In disc playback mode, press this button to display the disc location and playing time of the current music.

### 9. Number Button 5/ STOP

In radio mode, press this button to hear radio preset;  
In disc playback mode, press this button for to stop playback.

### 10. Number Button 6/PALY

In radio mode, press this button to hear radio preset;  
In disc playback mode, press this button for Play/Pause.

### 11. BAND/SYS /P.N

In radio mode, press this button to switch band, every time to choose band, the sequence is as follows:

FM1 → FM2 → FM3 → AM1 → AM2

In playing state, press this button to switch video system, AUTO, NTSC, PAL.

### 12. USB socket

Connect the USB memory to this socket, and the unit can play music format files supported by this unit in the USB memory

### 13. Aux External Input

External connected audio input.

## 14. AMS Program preset/Play Repeat button

In radio mode, press this button for a short moment to start scanning preset programs. In PLAY mode, press it to repeat playing a single song, and press it again to turn off this function.

## 15. Release button

Press this button can take off the control panel.

## 16. DN Adjustment(TFT Screen)/Hang up

After the display screen is extended, press this button to adjust the downward view angle of the screen in 5 setps of adjusting angle.

At Bluetooth state, when a phone come in, press this button can hang up the phone.

## 17. PIC Color selection button

Short press this button to chroma setup in the following level:

Bright → Soft → Sharp → Standard → Self Set

## 18. UP Adjustment(TFT Screen)/Hang-free

After the display screen is extended, press this button to adjust the upward view angle of the screen in 5 setps of adjusting angle.

At Bluetooth state, when a phone come in, press this button can answer the phone.

## 19. TFT Display screen extend/Retreat

Press this button to extend the TFT screen from the device or retreat it back. The maximum angle of extension is 104 degree.

Attention: Under the disc playing mode, there is no image display at the moment of screen extension after the button is pushed. It will become normal in 3 seconds.

## 20. MUTE / TFT on/off button

Press this button to shut off the sound output, re-press this button can resume the sound output, long press this button can turn off the TFT LCD display.

## 21. Disc load slot

Opening for disc to enter or retreat.

## 22. SD socket

This is a high-speeds transmission interface, which can read high-capacity date in MP3 or MP4 format.

## 23. Reset button

Press this button can back to default mode.

## 24. DN Adjustment(TFT Screen)/Hang up

Operation and function are the same as in (16).

## 25. UP Adjustment(TFT Screen)/Hang-free

Operation and function are the same as in (18).

## 26. Disc Out button

Press this button can eject the disc.

## EQ SETTING

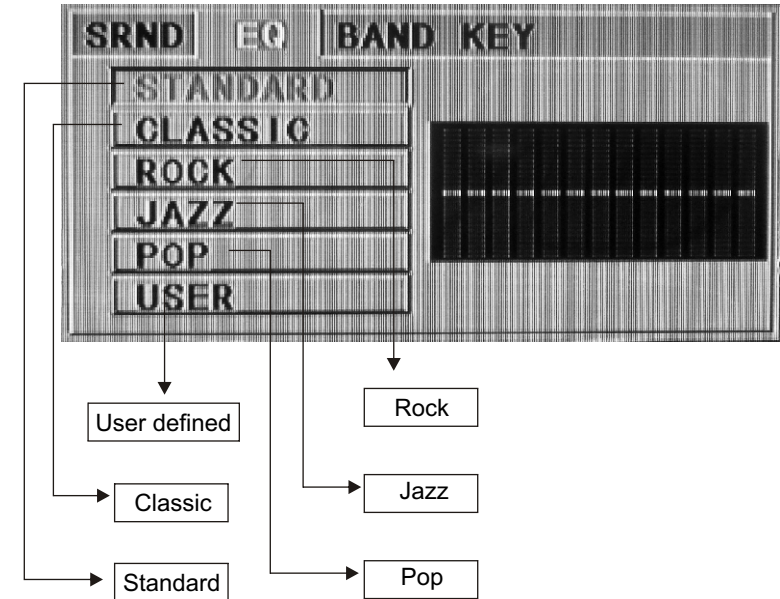

## MUSIC SURROUNDINGS SETTING (PIC 7)

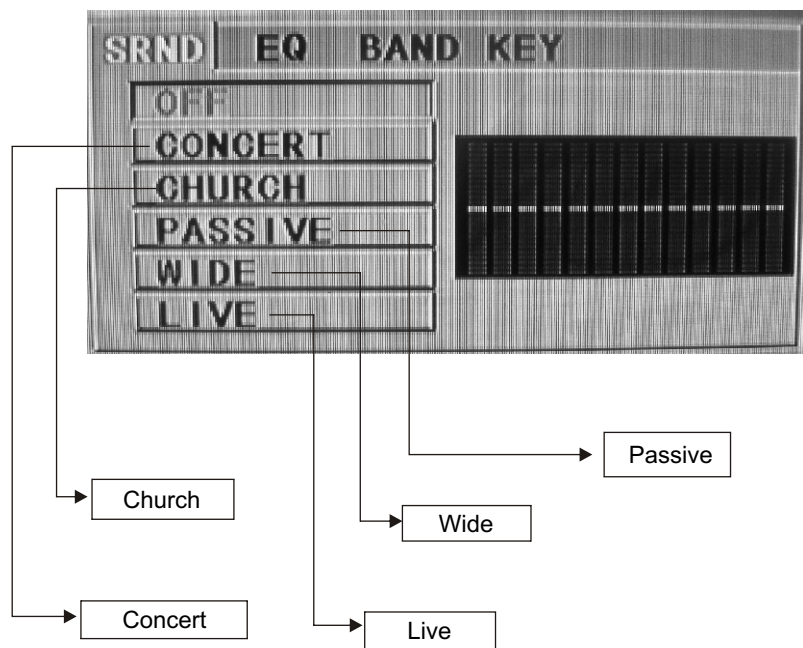

**Note:** This function only is used with the remote control in CD/MP3/USB/SD mode. Once you have one of these settings on. You will no longer have Bass & Treble adjustments until this feature is set to off.

## MAIN MENU TOUCH OPERATION (PIC 1)

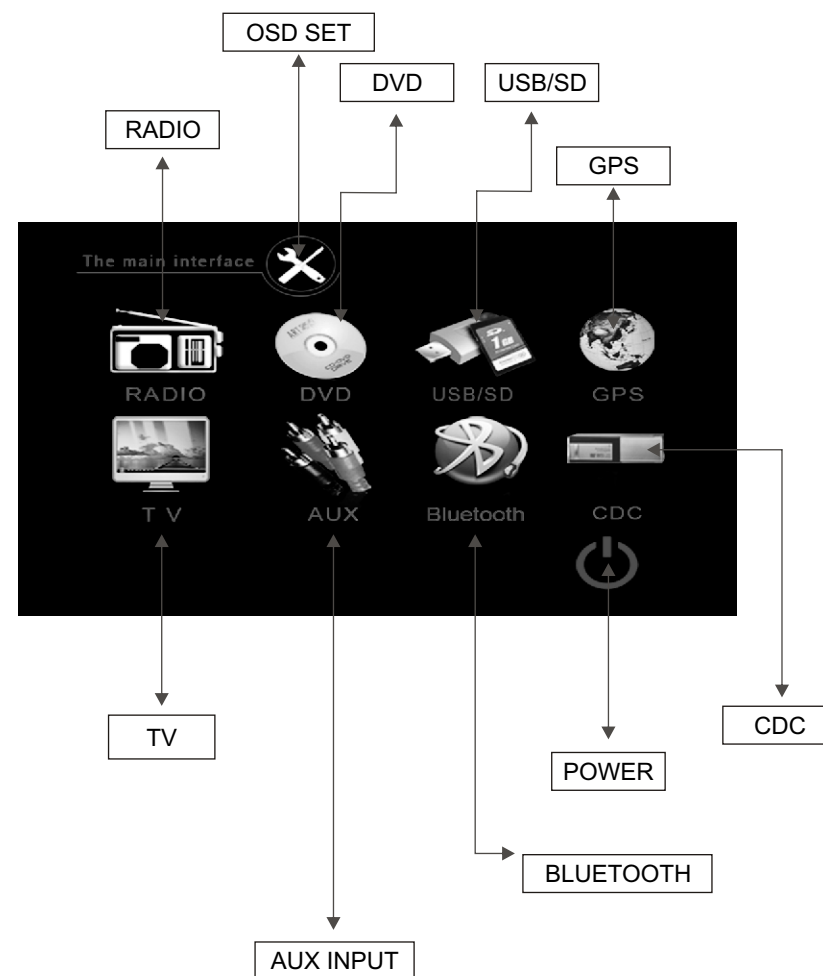

\* This unit without CDC/TV/GPS function.

## OSD SETUP (PIC 2)

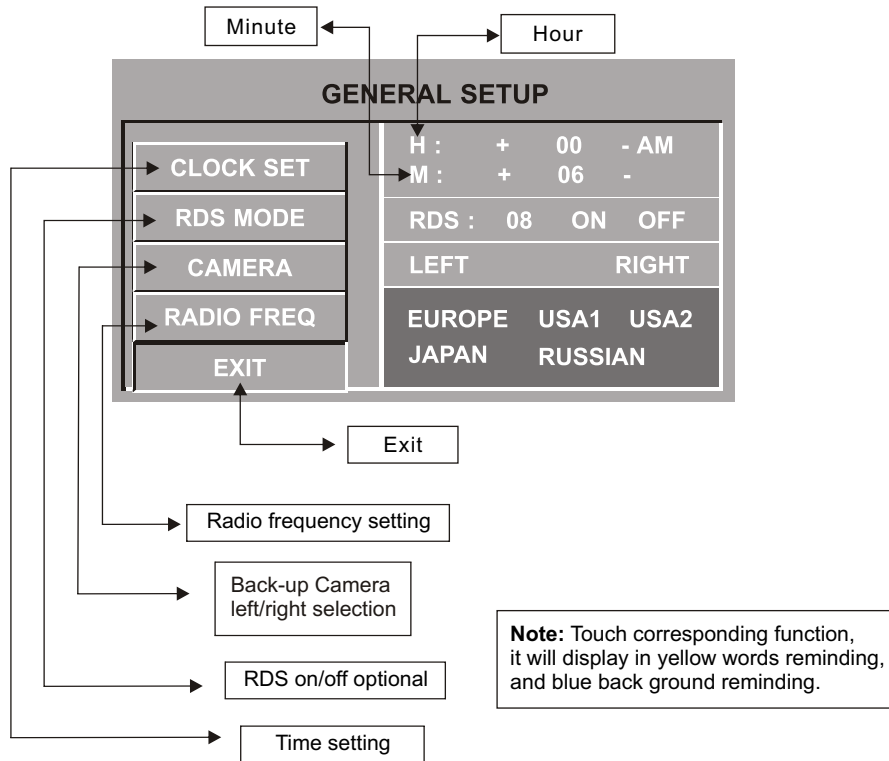

**Note:** There are 3 buttons automatically changed according to your setting change in radio state when you activate or exit RDS; Changes are as following:

PTY ↔ LOUD; TA ↔ EQ; AF ↔ ST

### TIME DISPLAY AND ADJUST

Time display: Touch main menu into adjust mode, press time setup button, the corresponding function will be display in yellow words.

- (1) Press "+" on hour to add hour, press "-" to reduce hour;
- (2) Press "+" on minute to add minute, press "-" to reduce minute.

**NOTE:** Touch the correspondence function, will be display in green background.

The unit include two times system: Europe time (24 hour setup), America time (12 hour setup), when show the AM mark it indicate morning time, when appear the PM mark, it show the time of afternoon.

**Remark:** This unit is with RDS function, it will automatically adjust the time when you activate RDS function or have received RDS radio channels. At no received RDS radio channels or AM state, you should adjust the time.

## 10. CD Program Play

In CD mode, you can set the sequence of playing by the program function, the operation is as follows:

When CD is playing, press ST/PROG button, then the display shows:

PROG	TC	TC	TC	TC			
1	__ : __	5	__ : __	9	__ : __	13	__ : __
2	__ : __	6	__ : __	10	__ : __	14	__ : __
3	__ : __	7	__ : __	11	__ : __	15	__ : __
4	__ : __	8	__ : __	12	__ : __	16	__ : __
		PLAY		DELETE			

Input the number of the song you want to program by the remote control, program the first song, input your desired song, for example, the sixth song, and press number button 6 on the remote control. Program the second song, press ▼ button move the cursor to 2[ \_ \_ ]. Input your desired song, for example, the ninth song, press number button 9 on the remote control. Press ► button to program play.

Back to the normal mode, press the ST/PROG button, then press ► button.

**Note:** This function can only be worked by the remote control.

## 11. MP3 Program Play

In MP3 mode, you can set the sequence of playing by the program function, the operation is as follows:

When MP3 is playing, press ST/PROG button, then the display shows:

PROG	TC	TC	TC	TC			
1	__ : __	5	__ : __	9	__ : __	13	__ : __
2	__ : __	6	__ : __	10	__ : __	14	__ : __
3	__ : __	7	__ : __	11	__ : __	15	__ : __
4	__ : __	8	__ : __	12	__ : __	16	__ : __
		PLAY		DELETE			

Then, input desired song by remote control.

For example: Program the first song, input 01, press ► button move the cursor to the second lattice, input desired song, for example the third song. Program the second song, press ► button, work with ▼ button, move the cursor to 2[ \_ \_ ]. Input 01, press ► button move the cursor to the second lattice, input desired song, for example, the sixth song (press 6). Press ► button to program play.

Back to the normal mode, press the ST/PROG button and then press ► button.

**Note:** This function can only be worked by the remote control.

# INSTRUCTIONS

## CD/MP3 BASIC OPERATION (Look at Picture #4)

Slide in CD/MP3 disc, unit will play it automatically. If disc is in slot, press DVD touch button on main menu can to play.

### 1. Repeat Play

In CD/MP3 mode, press AMS/RPT button on remote control, to startup following, repeat CD disc: Single song repeat→ Repeat play off.  
MP3 disc: Single song repeat→Directory repeat→ Repeat play off.

### 2. Fast Forward/Fast Rewind

Press SEEK + / SEEK - button on remote control, or ►► / ◀◀ touch button on display to speed forward or backward playing.  
Note: Hold above button a bit longer to operate.

### 3. Previous/Next Song Play

In playing mode, press SEEK + / SEEK - on remote control, or ►► / ◀◀ touch button on display to choose previous/next song.

### 4. Pause Play

In play mode, press ►|| button on remote control, or ►|| button on display to pause. Press again to go back to normal play.

### 5. Stop Play

In play mode:  
1) Press ■/〉 button on remote control to enter the pause mode, the position will be stored in unit. At that time, press ►|| button on remote control or touch button on display to resume playing at the stored position.  
2) Press ■/〉 button on remote control twice to enter into stop mode, here, press ►|| button on remote control or touch button on display, unit will play from the first song.

### 6. OSD

In playing mode, short press OSD on remote control to show all information of present disc.

### 7. Randomly Play

In CD mode, press LOC/RDM button on remote control, to instantly play each song. Press again to back to the normal play.

### 8. EQ Mode

1) This function can only be worked by remote control.  
2) When playing CD/MP3, press the "ZOOM" button on the remote control, you can choose the sound mode.  
3) When enter this function, press the button ▲/▼/◀/► to move the course to select sound mode which in the system menu, after your selection position will show red color to indicate the confirmation.

### 9. OPEN

Press ▲ button on pedestal to eject disc.

# INSTRUCTIONS

## ADJUST MODE (PIC 3)

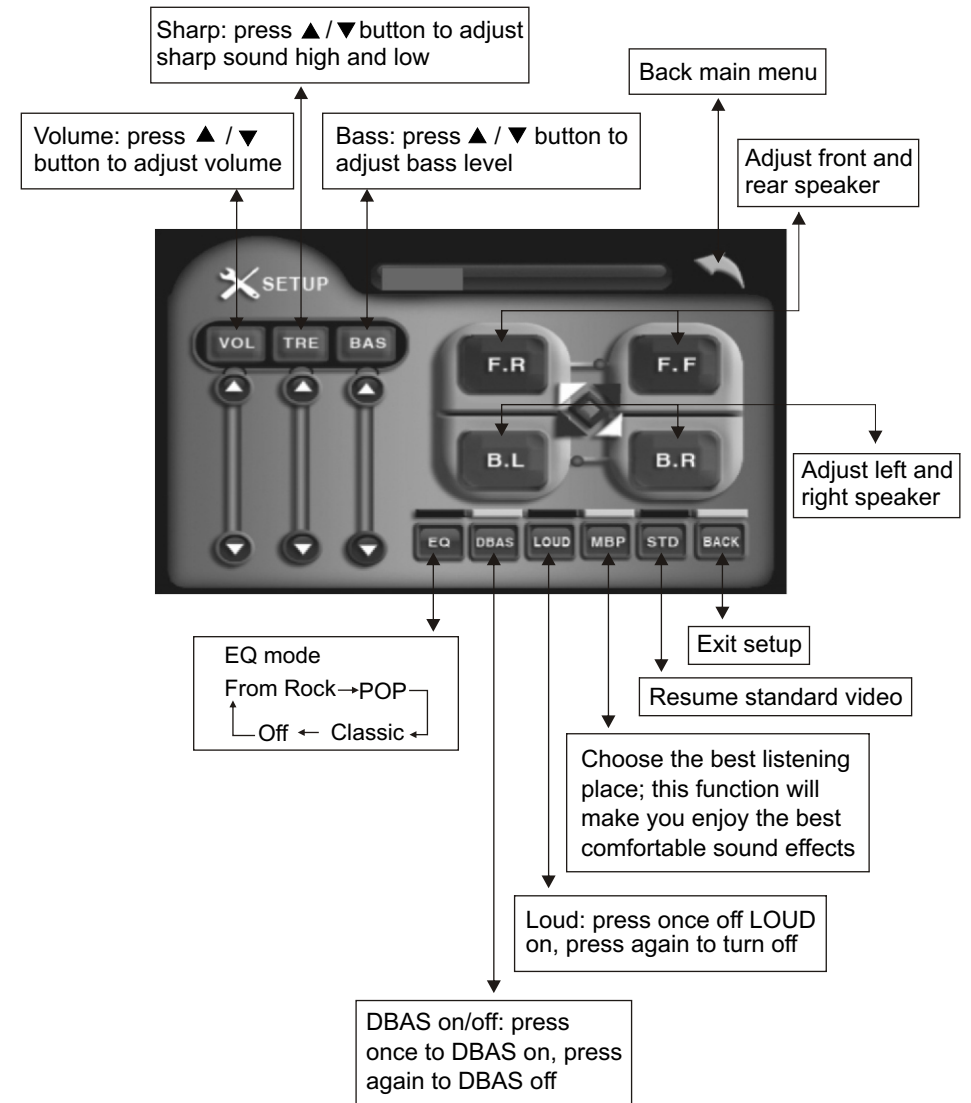

## REMOTE CONTROL FUNCTION

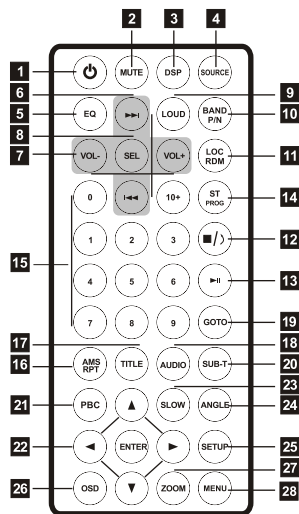

- |                |                      |
|----------------|----------------------|
| 1 POWER ON/OFF | 15 0-10+             |
| 2 MUTE         | 16 AMS/RPT           |
| 3 TIME DISPLAY | 17 TITLE             |
| 4 SOURCE       | 18 AUDIO             |
| 5 EQ           | 19 SET PLAYING TIME  |
| 6 SEEK+/SEEK-  | 20 SUBTITLE          |
| 7 VOL+/VOL-    | 21 PBC/MENU          |
| 8 SEL          | 22 UP/DOWN/L/R ENTER |
| 9 LOUD         | 23 SLOW              |
| 10 BAND/ P/N   | 24 ANGLE             |
| 11 LOC / RDM   | 25 SET UP            |
| 12 STOP        | 26 OSD               |
| 13 PLAY/PAUSE  | 27 ZOOM              |
| 14 ST/PROG     | 28 MENU              |

### 1. POWER

Press once to switch on, press again to switch off.

### 2. MUTE Button

Press once to turn off audio output, press again to resume volume level.

### 3. DSP

Press this button to show the time.

### 4. SOURCE Button

Press this button to choose audio sources.

### 5. EQ Button

Press this button to choose POP, ROCK, EQ off.

### 6. SEEK + ( >>> ) / SEEK - ( <<<< ) Button

Press this button to manual turning, speed or quick back, previous song and next song.

### 7. VOL + ( → ) / VOL - ( ← )

Press this button to increase or decrease volume level.

### 8. SEL Button

Press this button to choose sound feature.

### 9. LOUD Button

Press this button to startup LOUD function.

### 10. BAND - P/N Button

In radio mode, press this button to choose band. In VCD, DVD mode, press this button to choose AUTO, PAL or NTSC system.

### 11. LOC/RDM Button

In radio mode, press this button to switch between local and direction. In VCD, CD mode, press this key to randomly play.

### 12. STOP Button

Press this button to stop playing.

### 13. PLAY/PAUSE Button

Press this button to switch between play and pause. In stop mode, press this button to play.

### 14. ST/ PROG Button

In radio mode, press this button to choose stereo or mono station. In audio mode, it can help STOP button to programmed play.

### 15. PBC (MENU) Play

In VCD mode, press this button then play the PBC and display will show whole menu in disc, work with number button to choose song. When you are playing either song of the PBC, and you want to stop to select another song, press the button to turn off.

Note:

- 1) This function can be worked by the control.
- 2) PBC is suitable for the SVCD and VCD 2.0 disc.
- 3) In PBC mode, you can not press number button only to choose song.

### 16. VCD Program Playing

In VCD mode, you can set playing sequence of songs by program play function. The program playing operation steps are as follows:

In VCD mode, press ST/PTOG button, display will show:

PROG			
TC	TC	TC	TC
1 _ _ : _ _	5 _ _ : _ _	9 _ _ : _ _	13 _ _ : _ _
2 _ _ : _ _	6 _ _ : _ _	10 _ _ : _ _	14 _ _ : _ _
3 _ _ : _ _	7 _ _ : _ _	11 _ _ : _ _	15 _ _ : _ _
4 _ _ : _ _	8 _ _ : _ _	12 _ _ : _ _	16 _ _ : _ _
	PLAY	DELETE	

Input the songs which you want to programmed by the number buttons on remote control. Fr example: Program the first song, input your desires song, for example, the fourth song, and press number button 4 on the remote control. Program the second song, press ▼ button move the cursor to 2\_ \_ \_ . Input your desired song, for example, the eighth song, press number button 8 on the remote control. Press ► button to program play. Back to the normal mode, press the ST/PROG button, then press ► button.

Note: This function can only be worked by the remote control.

# INSTRUCTIONS

## 8. OSD

In playing mode, short press OSD on remote control to show all information of present disc.

## 9. Number Buttons

In VCD mode, press 0-9 number button to input song. For example, you want to choose 13th song, press 10+ button, and then press 3 button once to play 13th song.

Note: This function can only be worked by the remote control.

## 10. Repeat Play

In playing mode, press AMS/RPT button on remote control, to startup following, repeat function. Single song repeat→ Repeat play off.

Note:

- 1) When playing VCD disc, if PBC is on, no repeat function.
- 2) After unit is power off or mode is switched to other playing mode except VCD mode. if you switch back to VCD mode, repeat playing will be cancelled.

## 11. Randomly Play

In VCD mode, press LOC/RDM button on remote control, to instantly play each song. Press again to back to the normal play.

Note: When VCD disc, if PBC is on, RDM will not work.

## 12. Scan Play

In playing mode, it will play each song for 15 seconds to scan for your desired song.

- 1) Press 3/INT touch button on display to scan and play from the first song.
- 2) When you hear your desired song, press this button to cancel scan playing. It will go back to normal playing.

## 13. Switch Track

In VCD mode, press AUDIO button on remote control to switch track as following sequence:



## 14. OPEN

Press ▲ button on pedestal to eject disc.

# INSTRUCTIONS

## 15. 0 - 10 + Button

Press this button to choose desired song, section, preset stations.

\* Decimal numbers, for example the 19th song, press 1,9 button;

\* Centesimal numbers, for example, the 120th song, press 1,2,0 button.

## 16. AMS / RPT Button

In radio mode, press this button to browse stored stations. In audio mode, press this button to play repeatedly.

## 17. TITLE Button

In DVD mode, press this button to play back to the top menu of disc.

## 18. AUDIO Button

In DVD mode, press this button to switch language of dialogue. In VCD mode, press this button to choose left track, right track, and stereo.

## 19. SET Playing Time

In DVD mode, press this button, you can define playing time.

## 20. SUBTITLE Button

In DVD mode, press this button to switch language of subtitle.

## 21. PBC Button

In VCD mode, press this button to display all song menus, work with number button to choose songs.

## 22. UP, DOWN, LEFT, RIGHT, ENTER Button

In DVD mode, press this button to move cursor up, down, left, right to choose item in menu. Press the enter button to confirm choice.

## 23. SLOW Button

In audio mode, press this button to slow backward and slow forward.

## 24. ANGLE Button

In DVD mode, press this button to change play angle.

## 25. SETUP Button

In audio mode, press this button to choose different set items.

## 26. OSD Display

Press this button to display the title chapter and the left time.

## 27. ZOOM Button

In DVD/VCD mode, press this button to ZOOM in. In CD/MP3/USB/SD mode, press this button to choose EQ.

## 28. MENU Button

Press button to back to the main menu.

## BATTERY CHANGE

When control distance of remote control becomes shorter or no function, please change battery. Please confirm polarity before change.

One hand press stopper, then pull out battery.

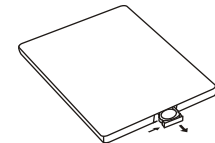

Put battery into controller.

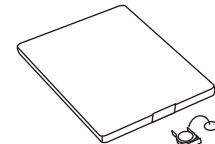

Insert battery holder into controller.

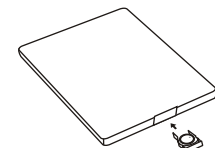

## LOADING

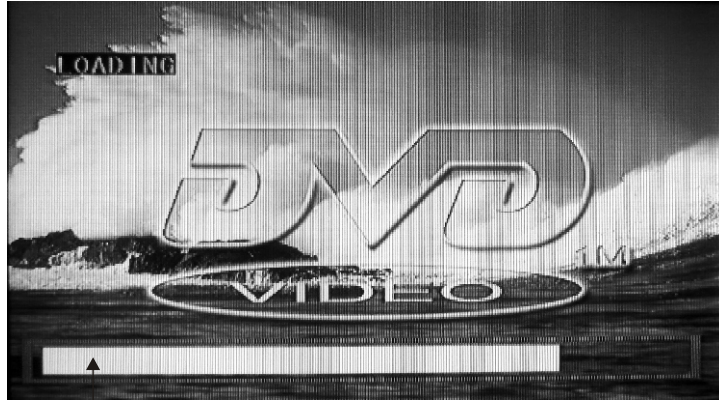

This white bar shows the rate of process of loading a disc.

**Note:** When loading a disc, touch screen function can not be used.

## VCD BASIC OPERATION (Look at picture #4)

Slide in the VCD disc, it will play it automatically. If the disc is in slot, press DVD touch button on main menu can to play.

### 1. Pause Play

In playing mode, press **▶||** button on remote control, or **▶||** on display to pause. Press again to back to normal play.

### 2. Stop Play

In playing mode, 1) Press **■/>** button on remote control to enter the pause mode, the position will be stored in unit. At that time, press **▶||** button on remote control or touch button on display to resume playing at the stored position.

2) Press **■/>** button on remote control twice to enter into stop mode, here, press **▶||** button on remote control or touch button on display, unit will play from the first song.

### 3. Fast Forward/Rewind Function

In playing mode, press **SEEK +** button on remote control, or **▶▶** touch button on display to speed play.

When you need quick back, press **SEEK -** button on remote control, or **◀◀** touch button on display to quick back play.

Note: Hold above button a bit longer to operate.

### 4. Previous/Next Song Play

In playing mode, press **SEEK + / SEEK -** on remote control, or **▶▶ / ◀◀** touch button on display to choose previous/next song.

### 5. Switch System

In playing mode, short press the **BAND/P/N** button on remote control, to select PAL, AUTO, NTSC TV system.

Note: This function can only be worked by the remote control.

### 6. Slow Play

Press **SLOW** button on remote control to slow play. The level of slow playing is as follows.

Sequence is : SLOW 1/2 → SLOW 1/3 → SLOW 1/4 → SLOW 1/5  
 ↑  
 PLAY ← SLOW 1/7 ← SLOW 1/6 ←

Note: This function can only be worked by the remote control.

### 7. Zoom In / Zoom Out

Press **ZOOM** button on remote control to zoom in / zoom out the picture. The levels are as follows:

ZOOM IN 2 → ZOOM IN 3 → ZOOM IN 4 → ZOOM IN 1/2  
 ↑  
 ZOOM IN OFF ← ZOOM IN 1/4 ← ZOOM IN 1/3 ←

Note:

1. This function can only be worked by the remote control.
2. Image which is zoomed in can be moved by up/down/left/right cursor to move.
3. Image which is zoomed out cannot be moved.



## DIGITAL SETUP

1. Press ▲ or ▼ button

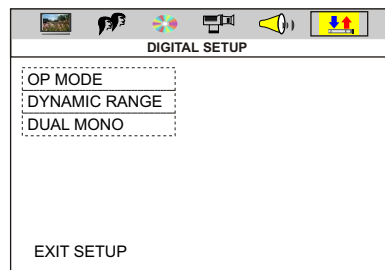
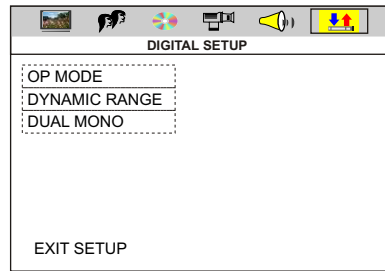
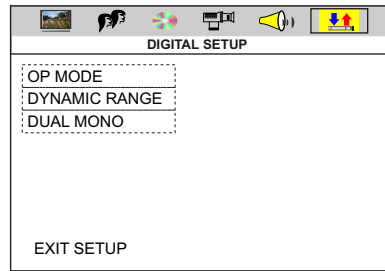

2. Press ▲/▼/◀/▶ button, then to enter.

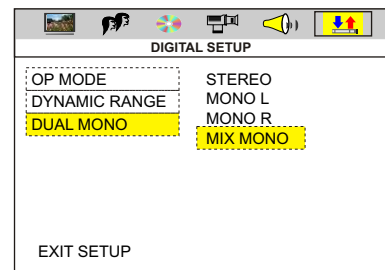
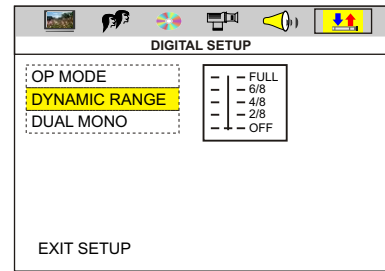
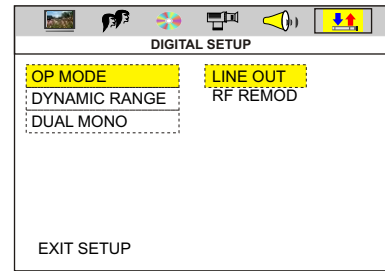

## DISC PLAY TOUCH OPERATION (PIC 4)

Touch this area to enter & exit main menu.

MP3 mode, press this button so you can move the cursor to left/right/up/down and select the songs which in the system menu

DVD mode, press this area to show function icons

Touch option:  
 ▶▶ next song;  
 ◀◀ previous songs;  
 ▲▼ adjust monitor angles;  
 Pls refer to Pic 5 when touch "SET" button;  
 There is a yellow remind when touch any button.

You can select "X2→X4→X8→X16→X20→Play" to speed up when you press this button ▶▶.  
 You can select "X2→X4→X8→X16→X20→Play" to backward when you press this button ◀◀.

# INSTRUCTIONS

## DVD MODE (PIC 5)

### AUDIO SETTING ON TOUCH SCREEN

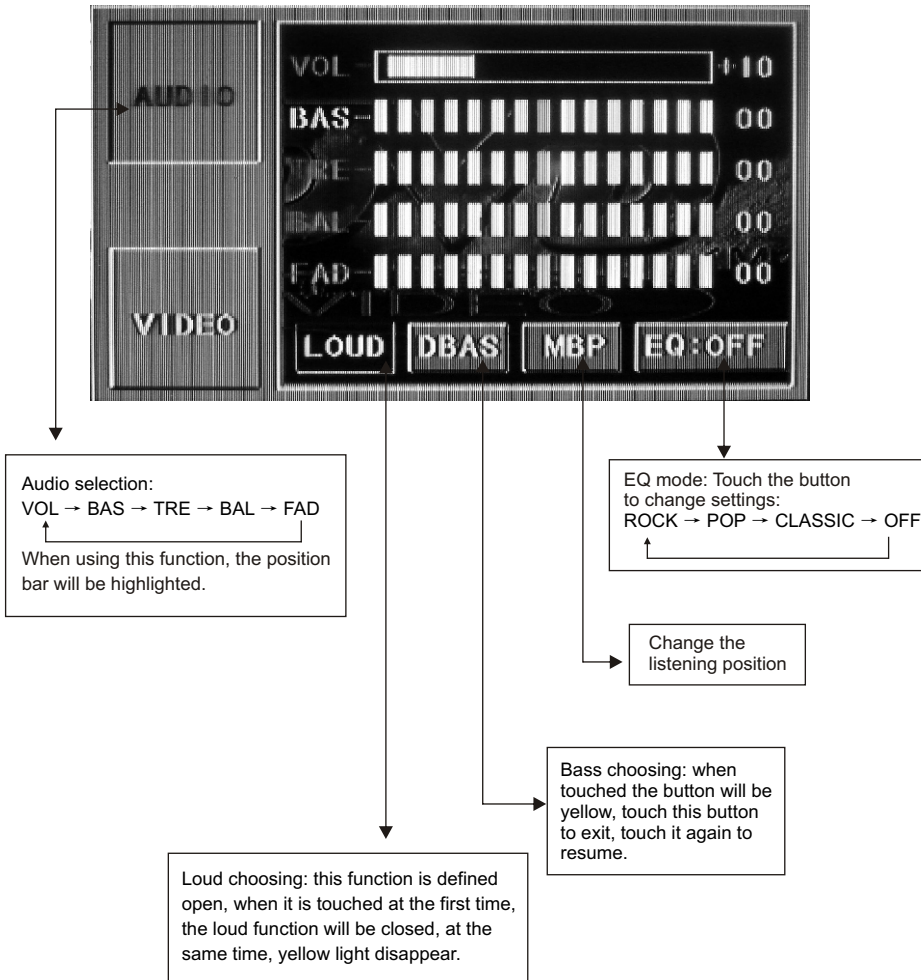

# INSTRUCTIONS

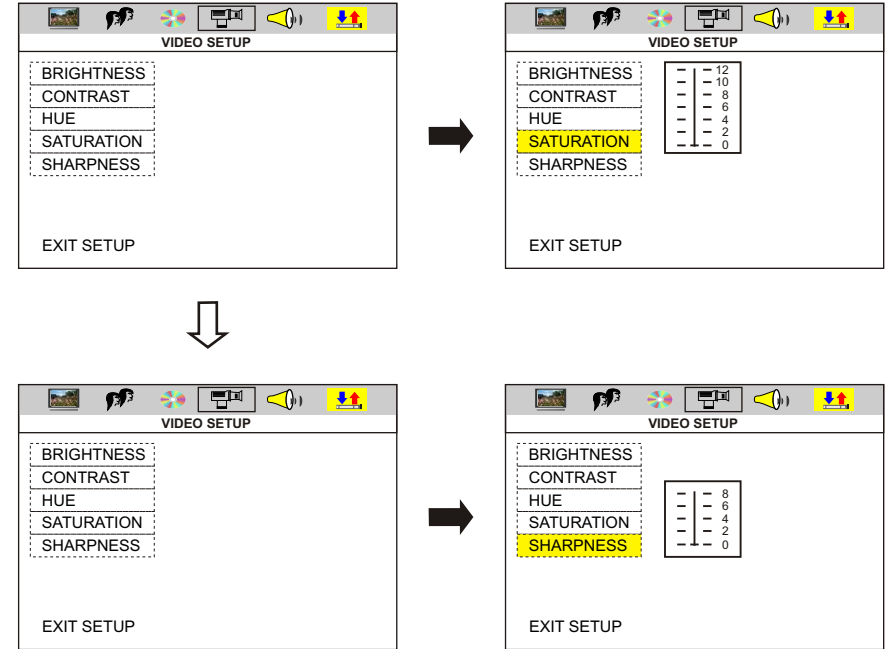

# INSTRUCTIONS

## VIDEO SETUP

1. Press ▲ or ▼ button

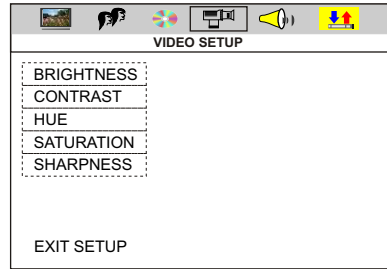

2. Press ▲/▼/◀/▶ button, then to enter.

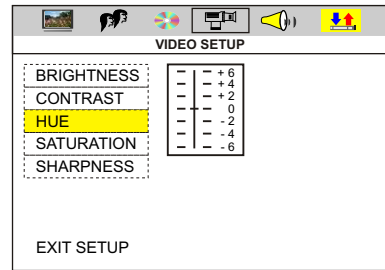
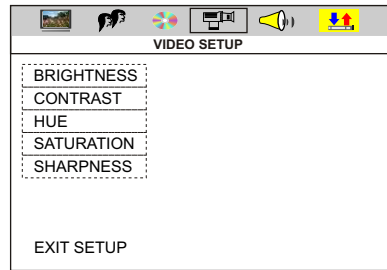
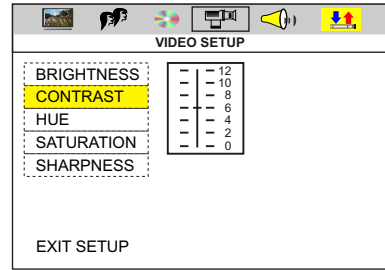
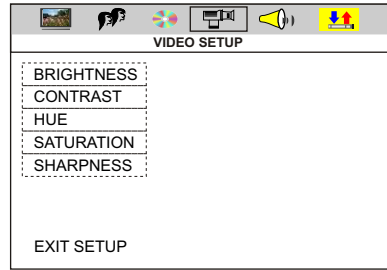
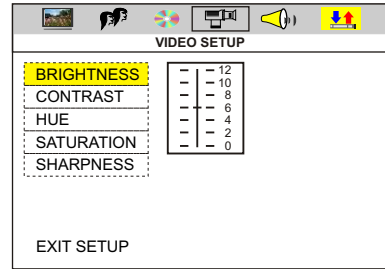

# INSTRUCTIONS

## VIDEO SETTING ON TOUCH SCREEN

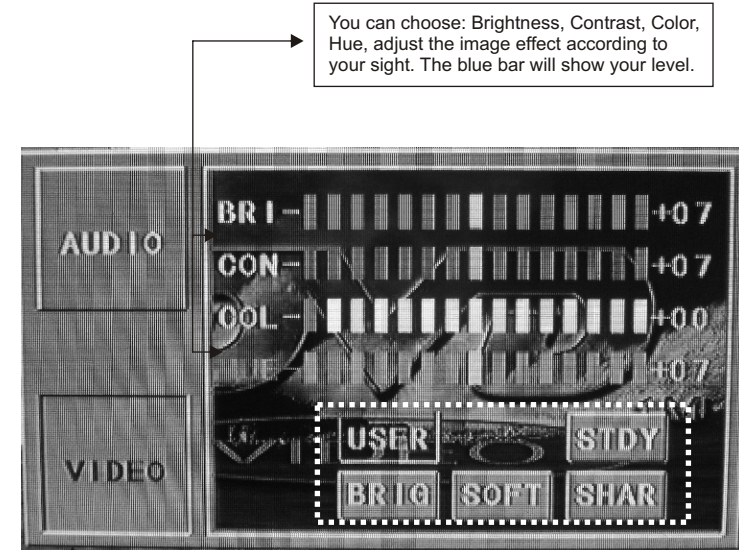

You can choose: Brightness, Contrast, Color, Hue, adjust the image effect according to your sight. The blue bar will show your level.

Video mode: When using this function, the position will be darker on the screen.

Image mode: You can choose the area in the broken line on the panel, standard, defined, soft, according what you need to choose, the blue back light will disappear.

## RDS USER OPERATION (PIC 6)

Press PTY, when PTY is on, it means there is strong RDS signals output.

Press this button to choose radio channels' name, please refer to details user manual.

Press this button to close sound output, re-press this button to resume sound.

Short press on this button to decrease radio frequency; longer press on this button to seek radio channels frequency decreased direction.

Short press on this button to increase radio frequency; longer press on this button to seek radio channels frequency increased direction.

Touch this area to enter & exit main menu.

Press this button to adjust angles of the monitor.

Press "SEL" to adjust other functions, please refer to pic 3.

In the radio state, press "APS" button, it will automatically seek radio channels in the whole band and preset the strongest radio channels.

Press TA, when TA is on, it means the unit is automatically track RDS radio channels.

Press this button each time, it will automatically execute the following operation in an order of FM1 → FM2 → FM3 → AM1 → AM2

For details of RDS operation, please refer to other instruction

**LANGUAGE SETUP**

- OSD LANGUAGE
- AUDIO LANG
- SUBTITLE LANG
- MENU LANG

EXIT SETUP



**LANGUAGE SETUP**

- OSD LANGUAGE
- AUDIO LANG
- SUBTITLE LANG
- MENU LANG

- ENGLISH
- GERMAN
- SPANISH
- FRENCH
- PORTUGUESE

EXIT SETUP

## AUDIO SETUP

1. Press ▲ or ▼ button

**AUDIO SETUP**

- AUDIO OUT
- KEY

EXIT SETUP

2. Press ▲/▼/◀/▶ button, then to enter.

**AUDIO SETUP**

- AUDIO OUT
- KEY

- SPDIF/OFF
- SPDIF/RAW
- SPDIF/PCM

EXIT SETUP



**AUDIO SETUP**

- AUDIO OUT
- KEY

EXIT SETUP



**AUDIO SETUP**

- AUDIO OUT
- KEY

- #
- +4
- +2
- 0
- -2
- -4
- b

EXIT SETUP

## LANGUAGE SETUP

1. Press ▲ or ▼ button

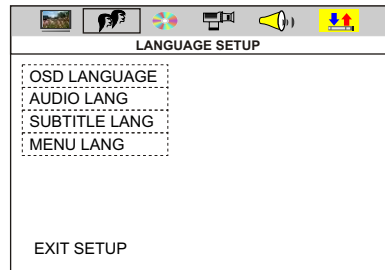

2. Press ▲/▼/◀/▶ button, then to enter.

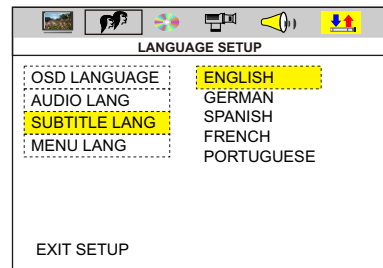
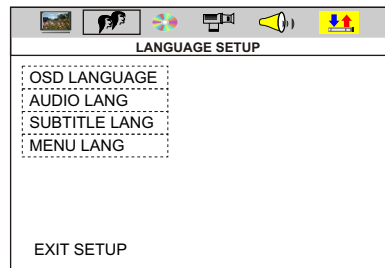
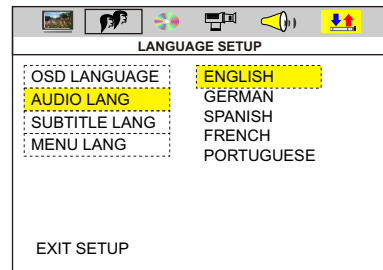
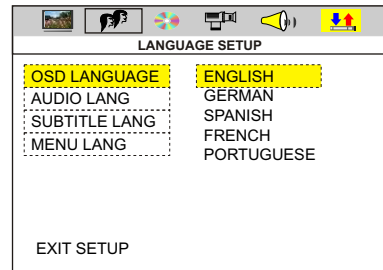

## RDS

### 1. EON (RDS Mark)

Indicate main unit is on auto tracking RDS mode.

### 2. AF (RDS Auto Tracking Mark)

Indicate radio is auto tracking RDS channel.

### 3. TA (RDS Signal Increasing Output)

Indicate RDS channel have signal increasing output.

### 4. TP (RDS Channel Stereo Mark)

Indicate RDS channel is on stereo playing mode.

### 5. POP.M (RDS Channel Mark)

Indicate RDS channel name.

### 1. RDS Tracking System

Press AF button in FM mode, and then press ◀▶ last 2 minutes, RDS will auto search channel up and down, it will stop searching when RDS channel be founded, but "AF" will keep remaining on the screen and waits for the next traffic emergency report.

### 2. RDS Tracking on Playing Mode

In playing mode, "AF" tracking system keeps on opening and waits for traffic emergency report.

1) PTY: RDS button, press once will show music mode POP, press 1-6 function memory button, every group have 2 channel.

POP M	ROCK M	EASY M
LIGHT M	CLASSICS M	OTHER M
JAZZ	COUNTRY	NATION

2) Press PTY button twice and then press 1-6 function memory button, every button have 3 channel.

NEWS	AFFAIRS	INFORMATION	SPORT
EDUCATION	DRAMA	CULTURE	SCIENCE
CHILDREN	SOCIETT	RELIGION	PHONING
TRAVEL			

**Note:** RDS channel in broken line is available.

AF: RDS auto search button, in radio mode also can press this button shortly auto tracking RDS channel, press this button shortly can cancel RDS function.

TA: In RDS mode, press this button can output TA signal, and check RDS channel is exist or not, if no RDS signal TFT will show "NO.TA.TP".



## SYSTEM SETUP

1. Press ▲ or ▼ button

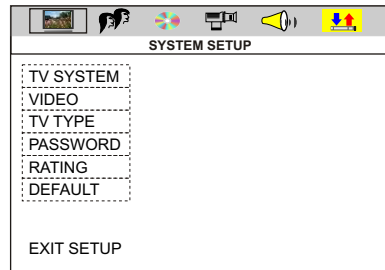

2. Press ▲/▼/◀/▶ button, then to enter.

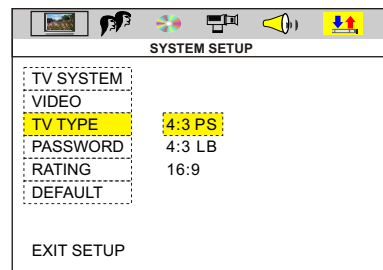
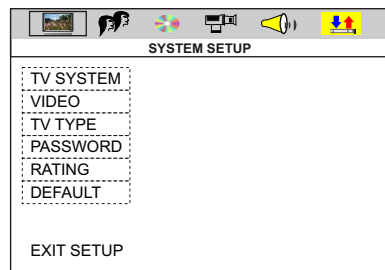
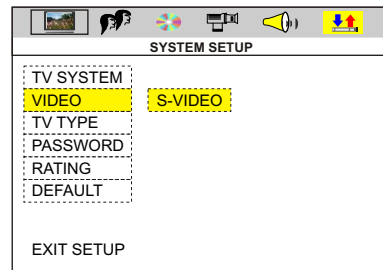
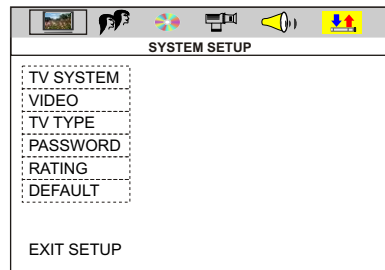
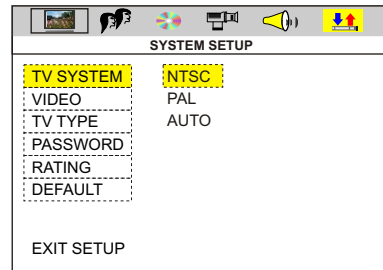

## DVD BASIC OPERATION (Please link with touch operation at pic 4)

Slide in DVD disc, unit will play it automatically. If disc is in slot, press DVD touch button on main menu to play disc.

### 1. Pause Play

In playing mode, press ►II button on remote control, or ►II on the display to pause. Press again to go back to normal play.

### 2. Stop Play

In playing mode, 1) Press ■/〉 button on remote control to enter the pause mode, the position will be stored in unit. At that time, press ►II button on remote control or touch button on display to resume playing at the stored position.

2) Press ■/〉 button on remote control twice to enter into stop mode, here, press ►II button on remote control or touch button on display, unit will play from the first song.

### 3. Fast Forward/Fast Backward Play

In playing mode, press SEEK + button on remote control, or ►► touch button on display to speed play.

When you need quick back, press SEEK - button on remote control, or ◀◀ touch button on display to quick back play.

Note: Hold above button a bit longer to operate.

### 4. Previous/Next Song Play

In playing mode, press SEEK + / SEEK - on remote control, or ►►/◀◀ touch button on display to choose previous/next song.

### 5. Switch System

In playing mode, short press the BAND/P/N button on remote control, to select PAL, AUTO, NTSC TV system.

Note: This function can only be worked by the remote control.

### 6. Slow Play

Press SLOW button on remote control to slow play. The level of slow playing is as follows.

Sequence is : SLOW 1/2 → SLOW 1/3 → SLOW 1/4 → SLOW 1/5  
 ↑  
 PLAY ← SLOW 1/7 ← SLOW 1/6

Note: This function can only be worked by the remote control.

### 7. Zoom In/Zoom Out

Press ZOOM IN button on remote control to zoom in / zoom out the picture. The levels are as follows:

ZOOM IN 2 → ZOOM IN 3 → ZOOM IN 4 → ZOOM IN 1/2  
 ↑  
 ZOOM IN OFF ← ZOOM IN 1/4 ← ZOOM IN 1/3

Note:

1. This function can only be worked by the remote control.
2. Image which is zoomed in can be moved by up/down/left/right cursor to move.
3. Image which is zoomed out cannot be moved.

