

Pioneer

Operation Manual

DVD RDS AV RECEIVER

AVH-5300DVD AVH-6300BT



Made for



iPod



iPhone



English

Thank you for purchasing this PIONEER product.

To ensure proper use, please read through this manual before using this product. It is especially important that you read and observe **WARNING**s and **CAUTION**s in this manual. *Please keep the manual in a safe and accessible place for future reference.*



Be sure to read this

- DVD video disc region numbers **6**
- Handling guidelines **66**

01 Precautions

IMPORTANT SAFEGUARDS **4**

To ensure safe driving **4**

To avoid battery exhaustion **5**

02 Before you start

About this unit **6**

Operating environment **6**

In case of trouble **7**

Protecting your unit from theft **7**

Resetting the microprocessor **7**

Demo mode **8**

Adjusting the response positions of the touch panels (Touch Panel Calibration) **8**

03 What's what

Head unit **9**

Optional remote control **9**

04 Basic operations

Basic operations of this unit **10**

Operating the scroll bar and the scrubber bar **10**

Activating the touch panel keys **11**

Common operations for menu settings/lists **12**

Opening and closing the LCD panel **12**

Ejecting a disc **12**

Ejecting an SD **12**

Setting the clock **13**

05 Tuner

Introduction of tuner operations **14**

06 Playing moving images

Introduction of video playback operations **15**

07 Playing audio

Introduction of sound playback operations **18**

08 Playing still images

Introduction of still image playback operations **20**

Introduction of still image playback as a slideshow operations **21**

09 Bluetooth Telephone

Introduction of Bluetooth telephone operations **22**

10 Detailed instructions

Storing and recalling stations **24**

Displaying radio text **24**

Storing and recalling radio text **24**

Storing the strongest stations **24**

Tuning in to strong signals **24**

Receiving traffic announcements **24**

Using PTY functions **25**

Switching the media file type **26**

Operating the DVD menu **26**

Operating this unit's iPod function from your iPod **26**

Random play (shuffle) **27**

Playing all songs in random order (shuffle all) **27**

Repeating playback **27**

Playing videos from your iPod **27**

Browsing for a video/music on the iPod **28**

Resume playback (Bookmark) **28**

Frame-by-frame playback **29**

Slow motion playback **29**

Searching for the part you want to play **29**

Changing audio language during playback (Multi-audio)	29
Changing the subtitle language during playback (Multi-subtitle)	30
Changing the viewing angle during playback (Multi-angle)	30
Return to the specified scene	30
Selecting audio output	30
PBC playback	30
Selecting tracks from the track title list	31
Selecting files from the file name list	31
Using S.Rtrv (sound retriever)	31
Changing audiobook speed	31
Displaying lists related to the currently playing song (Link Search)	31
Playing DivX® VOD content	31
Capture an image in JPEG files	32
Changing the wide screen mode	32
Calling a number in the phone book	33
Selecting a number by alphabet search mode	33
Using the missed, received and dialed call lists	34
Setting automatic answering	34
Adjusting the other party's listening volume	35
Switching the ring tone	35
Using the preset dial lists	35
Making a call by entering phone number	35
Setting the private mode	36
Pairing from this unit	36
Using a Bluetooth device to pair	36
Connecting to a Bluetooth device automatically	37
Switching visible unit	37
Displaying Bluetooth Device address	37
Entering PIN code for Bluetooth wireless connection	38

11 Menu operations

Introduction of menu operations	39
Audio Adjustments	40
Setting up the DVD player	43
System settings	47
Entertainment settings	54
Customizing menus	55

12 Other Functions

Changing the picture adjustment	56
Setting rear monitor output	56
Adjusting the response positions of the touch panels (Touch Panel Calibration)	57
Using an AUX source	57

Additional Information

Troubleshooting	58
Error messages	60
Understanding auto EQ error messages	63
Understanding messages	63
Indicator list	64
Handling guidelines	66
Compressed audio compatibility (disc, USB, SD)	68
iPod compatibility	69
Sequence of audio files	70
Using the display correctly	70
Copyright and trademark	71
Language code chart for DVD	73
Specifications	74

IMPORTANT SAFEGUARDS

Please read all of these instructions regarding your display and retain them for future reference.

- 1 **Read this manual fully and carefully before operating your display.**
- 2 **Keep this manual handy as a reference for operating procedures and safety information.**
- 3 **Pay close attention to all warnings in this manual and follow the instructions carefully.**
- 4 **Do not allow other persons to use this system until they have read and understood the operating instructions.**
- 5 **Do not install the display where it may (i) obstruct the driver's vision, (ii) impair the performance of any of the vehicle's operating systems or safety features, including air bags, hazard lamp buttons or (iii) impair the driver's ability to safely operate the vehicle.**
- 6 **Do not operate this display if doing so in any way will divert your attention from the safe operation of your vehicle. Always observe safe driving rules and follow all existing traffic regulations. If you experience difficulty in operating the system or reading the display, park your vehicle in a safe location and make necessary adjustments.**
- 7 **Please remember to wear your seat belt at all times while operating your vehicle. If you are ever in an accident, your injuries can be considerably more severe if your seat belt is not properly buckled.**
- 8 **Never use headphones while driving.**
- 9 **To promote safety, certain functions are disabled unless the parking brake is on, and the vehicle is not in motion.**
- 10 **Never set the volume of your display so high that you cannot hear outside traffic and emergency vehicles.**

WARNING

- **Do not attempt to install or service your display by yourself. Installation or servicing of the display by persons without training and experience in electronic equipment and automotive accessories may be dangerous and could expose you to the risk of electric shock or other hazards.** 

To ensure safe driving

WARNING

- **LIGHT GREEN LEAD AT POWER CONNECTOR IS DESIGNED TO DETECT PARKED STATUS AND MUST BE CONNECTED TO THE POWER SUPPLY SIDE OF THE PARKING BRAKE SWITCH. IMPROPER CONNECTION OR USE OF THIS LEAD MAY VIOLATE APPLICABLE LAW AND MAY RESULT IN SERIOUS INJURY OR DAMAGE.**
- To avoid the risk of damage and injury and the potential violation of applicable laws, this unit is not for use with a video screen that is visible to the driver.
- To avoid the risk of accident and the potential violation of applicable laws, no viewing of front seat video should ever occur while the vehicle is being driven. Also, rear displays should not be in a location where they are visibly distracting to the driver.
- In some countries or states the viewing of images on a display inside a vehicle even by persons other than the driver may be illegal. Where such regulations apply, they must be obeyed and this unit's DVD features should not be used.

When you attempt to watch a video image while driving, the warning **Viewing of front seat video source while driving is strictly prohibited.** will appear on the front display.

Precautions

To watch a video image on the front display, park your vehicle in a safe place and apply the parking brake.

When using a display connected to REAR MONITOR OUTPUT

Passengers in the rear seat can also watch moving images or still images if you connect this unit to a display using the **REAR MONITOR OUTPUT**.



WARNING

NEVER install the rear display in a location where the driver can watch a DVD while driving.

When using the rear view camera

With an optional rear view camera, this unit can be used as an aid to keep an eye on trailers, or when backing into a tight parking spot.



WARNING

- **SCREEN IMAGE MAY APPEAR REVERSED.**
- **USE INPUT ONLY FOR REVERSE OR MIRROR IMAGE REAR VIEW CAMERA. OTHER USE MAY RESULT IN INJURY OR DAMAGE.**



CAUTION

- The rear view camera function is to be used as an aid to keep an eye on trailers, or while backing up. Do not use for entertainment purposes.
- Please note that the edges of the rear view camera images may differ slightly according to whether full screen images are displayed when backing up, and whether the images are used for checking the rear when the vehicle is moving forward. 

To avoid battery exhaustion

Keep the vehicle engine running when using this unit to avoid draining the battery power.

- When no power is supplied to this unit, such as when the vehicle battery is being replaced, the microcomputer of this unit returns to its initial condition. We recommend that you transcribe the audio adjustment data.



WARNING

Do not use with vehicles that do not feature an ACC position. 

Before you start



If you want to dispose this product, do not mix it with general household waste. There is a separate collection system for used electronic products in accordance with legislation that requires proper treatment, recovery and recycling.

Private households in the member states of the EU, in Switzerland and Norway may return their used electronic products free of charge to designated collection facilities or to a retailer (if you purchase a similar new one).

For countries not mentioned above, please contact your local authorities for the correct method of disposal.

By doing so you will ensure that your disposed product undergoes the necessary treatment, recovery and recycling and thus prevent potential negative effects on the environment and human health. 

About this unit

The tuner frequencies on this unit are allocated for use in Western Europe, Asia, the Middle East, Africa and Oceania. Use in other areas may result in poor reception. The RDS (radio data system) function only operates in areas with broadcasting RDS signals for FM stations.

CAUTION

This product is a class 1 laser product classified under the Safety of laser products, IEC 60825-1:2007, and contains a class 1M laser module. To ensure continued safety, do not remove any covers or attempt to gain access to the inside of the product. Refer all servicing to qualified personnel.

CLASS 1 LASER PRODUCT

CAUTION—CLASS 1M VISIBLE AND INVISIBLE LASER RADIATION WHEN OPEN. DO NOT VIEW DIRECTLY WITH OPTICAL INSTRUMENTS.

CAUTION

- Do not allow this unit to come into contact with liquids. Electrical shock could result. Also, damage to this unit, smoke, and overheating could result from contact with liquids.
- The Pioneer CarStereo-Pass is for use only in Germany.
- Always keep the volume low enough to hear outside sounds.
- Avoid exposure to moisture.
- If the battery is disconnected or discharged, any preset memory will be erased.

DVD video disc region numbers

Only DVD video discs with compatible region numbers can be played on this player. You can find the region number of the player on the bottom of this unit and in this manual (refer to *Specifications* on page 74). 

Operating environment

This unit should be used within the temperature ranges shown below.

Operating temperature range: -10 °C to +60 °C
EN300328 ETC test temperature: -20 °C and +55 °C 

Before you start

In case of trouble

Should this product fail to operate properly, please contact your dealer or nearest authorized Pioneer Service Station. 

Protecting your unit from theft

The front panel can be detached to deter theft.

- If the front panel is not detached from the head unit within four seconds of turning off the ignition, a warning tone will sound.
- You can turn off the warning tone. Refer to *Switching the warning tone* on page 51.

Important

- Handle gently when removing or attaching the front panel.
- Avoid subjecting the front panel to excessive shock.
- Keep the front panel out of direct sunlight and high temperatures.
- If removed, replace the front panel on the unit before starting up your vehicle.
- To avoid damaging the device or vehicle interior, remove any cables and devices attached to the front panel before detaching it.

Removing the front panel

- **Pinch the top and bottom of its right side and pull the front panel out.**

Take care not to pinch it too tightly or to drop it, and also avoid contact with water or other fluids to prevent permanent damage.

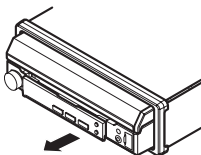

Re-attaching the front panel

- 1 Slide the front panel to the left.**

The front panel and the head unit are connected on the left side. Make sure that the front panel has been properly connected to the head unit.

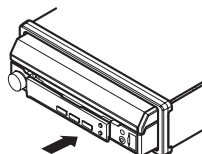

- 2 Press the right side of the front panel until it is firmly seated.**

- If you can't attach the front panel to the head unit successfully, try again. Forcing the front panel into place may result in damage. 

Resetting the microprocessor

By pressing **RESET**, you can reset the microprocessor to its initial settings without changing the bookmark information.

The microprocessor must be reset in the following situations:

- Before using this unit for the first time after installation
- If the unit fails to operate properly
- When strange or incorrect messages appear on the display

- 1 Turn the ignition switch OFF.**

- 2 Press RESET with a pen tip or other pointed instrument.**

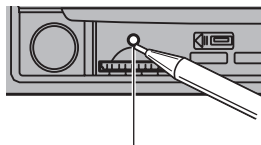

RESET button

Note

Switch your engine ON or set the ignition switch to ACC ON before pressing **RESET** in the following situations:

Before you start

- After completing connections
- When erasing all stored settings
- When resetting the unit to its initial (factory) settings

Demo mode

The feature demo automatically starts when you select **Source Off** for the source and continues while the ignition switch is set to ACC or ON. To cancel the feature demo, press and hold **MUTE/⏸**. Press and hold **MUTE/⏸** again to restart. Operating the feature demo while the car engine is turned off it may drain the battery power.

Important

Failure to connect the red lead (ACC) of this unit to a terminal coupled with ignition switch on/off operations may lead to battery drain.

Adjusting the response positions of the touch panels (Touch Panel Calibration)

If you feel that the touch panel keys on the screen deviate from the actual positions that respond to your touch, adjust the response positions of the touch panel. Refer to *Adjusting the response positions of the touch panels (Touch Panel Calibration)* on page 57.

What's what

Head unit

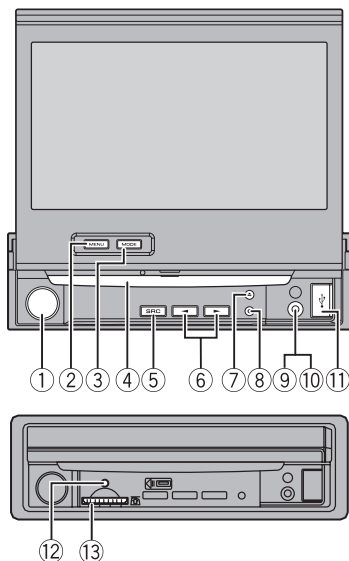

Part	Part
① Volume/ MUTE / ⏏ (⏏: AVH-6300BT only)	⑧ OPEN/CLOSE
② MENU Displaying the menu. Returning to the normal display.	⑨ AUX input jack (3.5 mm stereo/video jack) Use to connect an auxiliary device.
③ MODE Turning the information display off.	⑩ Auto EQ microphone input jack Use to connect an auto EQ microphone.
④ Disc loading slot	⑪ USB port When connecting, open the USB connector lid.
⑤ SRC/OFF	⑫ RESET
⑥ ◀▶ (TRACK/SEEK)	⑬ SD memory card slot
⑦ ▲ (eject)	

⚠ CAUTION

- Use an optional Pioneer USB cable (CD-U50E) to connect the USB audio player/USB memory as any device connected directly to the unit will protrude out from the unit and may be dangerous.
- Do not use unauthorized products.

Notes

- Insert an SD memory card with the contact surface facing down, and press on the card until it clicks and completely locks into place.
- When the navigation system is connected, press **MODE** to switch to the navigation display. Press **MODE** and hold to turn the display off. Press **MODE** again to turn the display on.
- Press and hold **MENU** to display **Picture Adjustment**. Refer to *Changing the picture adjustment* on page 56.
- For details on how to operate a navigation system from this unit, refer to its operation manual.

Optional remote control

The remote control CD-R55 is sold separately. For details concerning operations, see the remote control manual.

Basic operations of this unit

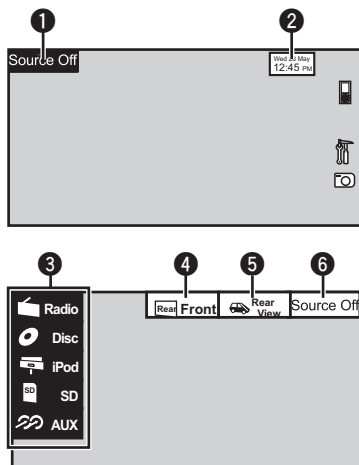

Touch panel keys

1 **Source Off** Displaying the source menu.

2 **Wed 28 May 12:45 PM** Switching to clock adjustment display. Refer to *Setting the clock* on page 13.

3 **Radio** Source icon
Selecting a favorite source. When the source icon is not displayed, it can be displayed by touching the screen.

4 **Rear Front** Switching the output source for the rear monitor. Refer to *Setting rear monitor output* on page 56.

5 **Rear View** Switching the rear view image on or off.

6 **Source Off** Turning the unit off.

Turning the unit on using the buttons

1 Press **SRC/OFF** to turn the unit on.

Turning the unit off using the buttons

1 Press **SRC/OFF** and hold until the unit turns off.

Selecting a source using the buttons

1 Press **SRC/OFF** to cycle through the sources listed below:

Selecting a source using the touch panel keys

1 Touch the source icon and then touch the desired source name.

- **Radio** – Radio
- **AV** – AV input
- **Disc** – Built-in DVD player
- **USB/iPod** – USB/iPod
- **SD** – SD memory card
- **AUX** – AUX
- When the source icon is not displayed, it can be displayed by touching the screen.
- While operating the menu, you cannot select a source by touching the source icon.

Adjusting the volume

1 Turn **MUTE/** to adjust the volume.

Notes

- In this manual, iPod and iPhone will be referred to as “iPod”.
- The **USB/iPod** icon will change as follows:
 - **USB** is displayed when a USB storage device is connected.
 - **iPod** is displayed when an iPod is connected.
 - **USB/iPod** is displayed when no device is connected.
- When appropriately set up, the image from the rear view camera can be displayed automatically. For details, refer to *Setting the rear view camera (back up camera)* on page 51. ■

Operating the scroll bar and the scrubber bar

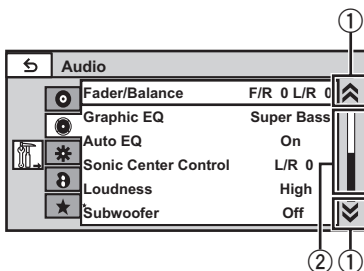

Basic operations

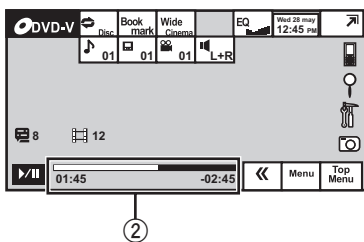

- ① Scroll icon
Appears when selectable items are hidden.
- ② Scrubber bar
Appears when the playback point can be specified or set by dragging.

Viewing the hidden items

- ① Touch the scroll icon or drag the scrubber bar to view any hidden items.
 - Also, you can drag the list to view any hidden items.

Specifying the playback point



- ① Drag the scrubber bar on the screen.
(Not available when the scrubber bar is grayed out.)

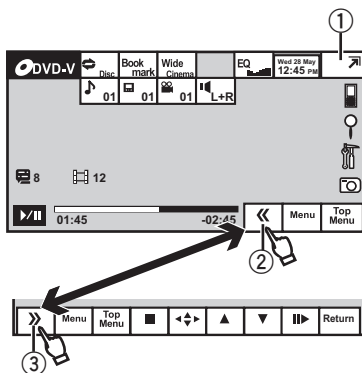

Activating the touch panel keys



Touch panel keys

- ①  Turning the display to simplified display.
Returning to the normal display by touching the screen when playing moving images.
Returning to the normal display by touching same icon when playing audio.
- ②  Viewing the hidden touch panel keys.
- ③  Shorten the touch panel area.



Common operations for menu settings/lists



(AVH-6300BT only)
Starting the Bluetooth telephone menu.
Refer to *Introduction of Bluetooth telephone operations* on page 22.



Displaying the list menu.
Starting the search function.



Displaying the menu.
Refer to *Introduction of menu operations* on page 39.



Displaying still images as a slide show when listening to another source.
Viewing slide shows.
Refer to *Introduction of still image playback operations* on page 20.



Returning to the previous display.
Returning to the previous list/category (the folder/category one level higher.)



Opening and closing the LCD panel

The LCD panel will open or close automatically when the ignition switch is turned on or off. You can turn off the automatic close/open function.

- Do not close the LCD panel by force with your hands. That will cause a malfunction.
- The automatic close/open function will operate the display as follows.
 - When the ignition switch is turned OFF while the LCD panel is opened, the LCD panel will close after six seconds.
 - When the ignition switch is turned ON again (or turned to ACC), the LCD panel will open automatically.
 - Removing or attaching the front panel will automatically close or open the LCD panel. (Refer to *Protecting your unit from theft* on page 7.)

- When the ignition switch is turned OFF after the LCD panel has been closed, turning the ignition switch ON again (or turning it to ACC) will not open the LCD panel. In this case, press **OPEN/CLOSE** to open the LCD panel.
- When closing the LCD panel, check to make sure that it has closed completely. If the LCD panel has stopped halfway, leaving it like this could result in damage.

CAUTION

Keep hands and fingers clear of the unit when opening, closing, or adjusting the LCD panel. Be especially cautious of children's hands and fingers.

● Press **OPEN/CLOSE** to open the LCD panel.

- To close the LCD panel, press **OPEN/CLOSE** again.

Turning the LCD panel horizontally

When the LCD panel is upright and hinders the operation of the air conditioner, the panel can be turned horizontally temporarily.

● Press and hold **OPEN/CLOSE** to turn the LCD panel horizontally.

- To return to the original position, press and hold **OPEN/CLOSE** again.
- The LCD panel returns to the original position automatically, indicated with a beeping sound 10 seconds after operation. 

Ejecting a disc

- 1 Press **▲** (eject).
- 2 Eject a disc. 

Ejecting an SD

- 1 Remove the front panel.

Refer to *Removing the front panel* on page 7.

- 2 Push an SD.
- 3 Eject an SD. 

Setting the clock

- 1 **Switch to Clock Adjustment display.**
Refer to *Basic operations of this unit* on page 10.
- 2 **Select the item to set.**
- 3 **Touch ▲ or ▼ to set the correct date and time.** 

Introduction of tuner operations

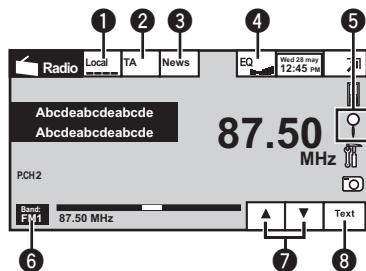

Touch panel keys

①

Local

Turning local seek tuning on and off.
Refer to *Tuning in to strong signals* on page 24.

②

TA

Turning TA (traffic announcement standby) on and off.
Refer to *Receiving traffic announcements* on page 24.

③

News

Turning news program interruption on and off.
Refer to *Using news program interruption* on page 25.

④

EQ

Switching the equalizer curves.
Refer to *Using the equalizer* on page 40.
Touch and hold for more than two seconds to turn the auto-equalizer on or off.
Refer to *Using the auto-equalizer* on page 41.

⑤



Displaying the preset channel list.
Refer to *Storing and recalling stations* on page 24.
Refer to *Storing the strongest stations* on page 24.
Refer to *Using PTY functions* on page 25.

⑥

Band:

Selecting a band (FM1, FM2, FM3 for FM or MW/LW).

⑦



Recalling radio station frequencies assigned to preset tuning keys.

⑧

Text

Displaying radio text
Refer to *Displaying radio text* on page 24.
Storing and recalling radio text.
Refer to *Storing and recalling radio text* on page 24.

Manual tuning (step by step) using the buttons

① Press ◀ or ▶ (**TRACK/SEEK**).

Seek tuning using the buttons

① Press and hold ◀ or ▶ (**TRACK/SEEK**).

Note

Noise may be generated when listening to MW/LW radio while charging an iPod with this unit. In such cases, disconnect the iPod from the unit.

Playing moving images

Introduction of video playback operations

You can view DVD/DVD-R/DVD-RW/CD/CD-R/CD-RW/USB/SD/iPod.

If an iPod with video capabilities is connected to this unit using an interface cable such as the CD-IU50V (sold separately), you can enjoy the video contents of the iPod as an **iPod** source.

DVD video

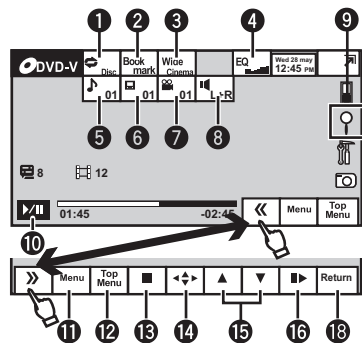

Video CD

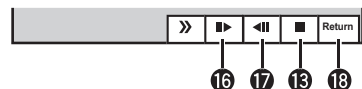



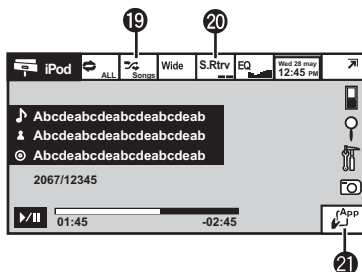



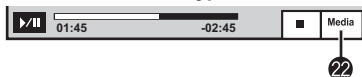

iPod video



When playing a disc containing a mixture of various media file types



Touch panel keys

- 1  Selecting the repeat range. Refer to *Repeating playback* on page 27.
- 2  During playback, touch the point at which you want to resume playback the next time the disc is loaded. Refer to *Resume playback (Bookmark)* on page 28.
- 3  Changing the screen mode. Refer to *Changing the wide screen mode* on page 32.
- 4  Switching the equalizer curves. Refer to *Using the equalizer* on page 40. Touch and hold for more than two seconds to turn the auto-equalizer on or off. Refer to *Using the auto-equalizer* on page 41.
- 5  Switching between audio languages during playback. Refer to *Changing audio language during playback (Multi-audio)* on page 29.
- 6  Switching between subtitle languages during playback. Refer to *Changing the subtitle language during playback (Multi-subtitle)* on page 30.
- 7  Switching among viewing angles during playback. Refer to *Changing the viewing angle during playback (Multi-angle)* on page 30.
- 8  Switching the audio output, when playing video discs recorded with LPCM audio. Refer to *Selecting audio output* on page 30. Switching between stereo and monaural audio output, when playing Video CD discs.

Playing moving images

9		Starting the search function. Refer to <i>Searching for the part you want to play</i> on page 29. Refer to <i>Selecting files from the file name list</i> on page 31. Displaying iPod menus. Refer to <i>Playing videos from your iPod</i> on page 27 and <i>Browsing for a video/music on the iPod</i> on page 28.
10		Pausing playback. Returning to normal playback during paused, slow motion, or frame-by-frame playback.
11	Menu	Displaying the DVD menu during DVD playback. Refer to <i>Operating the DVD menu</i> on page 26.
12	Top Menu	Returning to the top menu during DVD playback.
13		Stopping playback. Stopping playback at the point set in Resume playback. Touch one more time to stop playback completely when playing DivX. Refer to <i>Resume playback (Bookmark)</i> on page 28.
14		Displaying arrow keys to operate the DVD menu. Refer to <i>Using the arrow keys</i> on page 26.
15		Skipping to another title. Selecting a folder during DivX file playback.
16		Moving ahead one frame at a time during playback. Refer to <i>Frame-by-frame playback</i> on page 29. Touch and hold for more than two seconds to slow down playback speed. Speeding up the playback speed in four steps during slow motion playback on DVD video/Video CD.
17		Speeding down the playback speed in four steps, during slow motion playback on Video CD.
18	Return	Returning to the specified scene to which the DVD currently being played has been preprogrammed to return. Refer to <i>Return to the specified scene</i> on page 30.
19		Playing the video on your iPod in a random order. Refer to <i>Random play (shuffle)</i> on page 27.
20	S.Rtrv	Switching the S.Rtrv (sound retriever) function setting when playing a video on your iPod. Refer to <i>Using S.Rtrv (sound retriever)</i> on page 31.
21		Conducting operation from your iPod and listening to it using your car's speakers. Refer to <i>Operating this unit's iPod function from your iPod</i> on page 26.
22	Media	Switching between media file types to play on DVD/CD/USB/SD. Refer to <i>Switching the media file type</i> on page 26.

Playing moving images

Playing back videos

- 1 Insert the disc into the disc loading slot with the label side up.
Playback will automatically start.
- If you are playing a DVD or Video CD, a menu may appear. Refer to *Operating the DVD menu* on page 26 and *PBC playback* on page 30.
 - When the automatic playback function is on, the unit will skip the DVD menu and automatically start playback from the first chapter of the first title. Refer to *Automatic playback of DVDs* on page 46.
 - While an iPod is connected to this unit, **PIONEER, Accessory Attached** or ✓ (check mark) is displayed on the iPod.
 - When the source icon is not displayed, it can be displayed by touching the screen.
 - Disconnect headphones from the iPod before connecting it to this unit.
 - Depending on the iPod model and the amount of data stored in the iPod, it may take some time for playback to begin.
 - Use the touch panel keys to select the iPod after connecting it to this unit.
 - **No Device** is displayed when disconnecting the iPod.
 - If a message is displayed after loading a disc containing DivX VOD content, touch **Play**. Refer to *Playing DivX® VOD content* on page 31.

Ejecting a disc

- 1 Refer to *Ejecting a disc* on page 12 or *Ejecting an SD* on page 12.

Selecting a chapter using the buttons

- 1 Press ◀ or ▶ (**TRACK/SEEK**).

Fast forwarding or reversing using the buttons

- 1 Press and hold ◀ or ▶ (**TRACK/SEEK**).
- Fast forward/fast rewind may not always be possible on some discs. In such cases, normal playback will automatically resume.

tails, refer to *Resume playback (Bookmark)* on page 28.

- Some operations may not be available while watching a media due to the programming of the disc. In such cases, the ⏸ icon appears on the screen.
- To ensure proper operation, connect the dock connector cable from the iPod directly to this unit.
- While the iPod is connected to this unit, the iPod cannot be turned on or off. However, the iPod can be turned on or off when you select an SD as the source. ■

Notes

- This DVD player can play back a DivX file recorded on CD-R/RW or DVD-R/RW. (Please see the following section for files that can be played back. Refer to *DivX video files* on page 68.)
- Do not insert anything other than a DVD (-R/-RW) or CD (-R/-RW) into the disc loading slot.
- If the bookmark function is on, DVD playback resumes from the selected point. For more de-

Introduction of sound playback operations

You can listen to DVD-R/DVD-RW/CD/CD-R/CD-RW/USB/SD/iPod sound files.

Audio CD

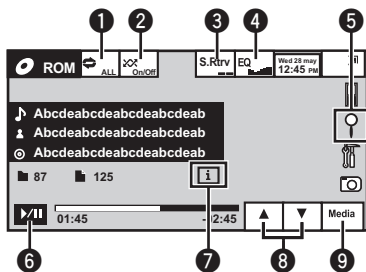



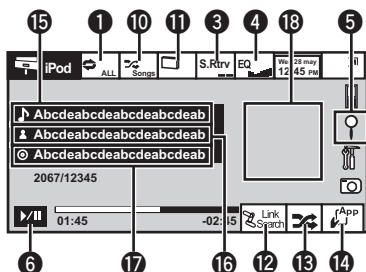

iPod audio





You can control an iPod with this unit by using a cable such as the CD-iU50 (sold separately).

Touch panel keys

- 1  Selecting the repeat range.
Refer to *Repeating playback* on page 27.
- 2  Playing songs in random order.
Refer to *Random play (shuffle)* on page 27.
- 3  Switching the S.Rtrv (sound retriever) function setting when playing audio.
Refer to *Using S.Rtrv (sound retriever)* on page 31.

- 4  Switching the equalizer curves.
Refer to *Using the equalizer* on page 40.
Touch and hold for more than two seconds to turn the auto-equalizer on or off.
Refer to *Using the auto-equalizer* on page 41.

- 5  Displaying a list of track titles to select songs on a CD.
Refer to *Selecting tracks from the track title list* on page 31.
Displaying the file name list to select the files.
Refer to *Selecting files from the file name list* on page 31.
Displaying iPod menus.
Refer to *Browsing for a video/music on the iPod* on page 28.

- 6  Pausing and starting playback.

- 7  Switching the text information to display on this unit when playing MP3/WMA/AAC files.

- 8  Selecting a folder.

- 9  Switching between media file types on a DVD/CD/USB/SD.
Refer to *Switching the media file type* on page 26.

- 10  Playing songs on the iPod in random order.
Refer to *Random play (shuffle)* on page 27.

- 11  Changing the speed of audiobook playback on the iPod.
Refer to *Changing audiobook speed* on page 31.

Playing audio

12



Switching to Link Search mode to play songs related to the currently playing song on the iPod. Refer to *Displaying lists related to the currently playing song (Link Search)* on page 31.

13



Playing all songs on the iPod in random order. Refer to *Playing all songs in random order (shuffle all)* on page 27.

14



Conducting operation from your iPod and listening to it using your car's speakers. Refer to *Operating this unit's iPod function from your iPod* on page 26.

Text information

15



Displaying the **Songs** list on the iPod. Refer to *Searching for a video/music by category* on page 28.

16



Displaying the **Artists** list on the iPod. Refer to *Searching for a video/music by category* on page 28.

17



Displaying the **Albums** list on the iPod. Refer to *Searching for a video/music by category* on page 28.

Artwork display

18

Starting **Album Link Search** on your iPod when you touch the artwork display. Refer to *Displaying lists related to the currently playing song (Link Search)* on page 31.

Playing back sound

- 1 Insert the disc into the disc loading slot with the label side up. Playback will automatically start.
- While an iPod is connected to this unit, **PIONEER, Accessory Attached** or ✓ (check mark) is displayed on the iPod.
 - When the source icon is not displayed, it can be displayed by touching the screen.
 - Disconnect headphones from the iPod before connecting it to this unit.
 - Depending on the iPod model and the amount of data stored in the iPod, it may take some time for playback to begin.
 - Use the touch panel keys to select the iPod after connecting it to this unit.
 - No Device** is displayed when disconnecting the iPod.

Ejecting a disc

- 1 Refer to *Ejecting a disc* on page 12 or *Ejecting an SD* on page 12.

Selecting a track using the buttons

- 1 Press ◀ or ▶ (**TRACK/SEEK**).

Fast forwarding or reversing using the buttons

- 1 Press and hold ◀ or ▶ (**TRACK/SEEK**).

Notes

- When playing back files recorded as VBR (variable bit rate) files, the play time will not be correctly displayed if fast forward or reverse operations are used.
- To ensure proper operation, connect the dock connector cable from the iPod directly to this unit.
- While the iPod is connected to this unit, the iPod cannot be turned on or off. However, the iPod can be turned on or off when you select an SD as the source.
- If the characters recorded on the disc are not compatible with this unit, those characters will not be displayed.
- Text information may not be correctly displayed depending on the recorded environment.
- Disconnect the USB portable audio player/USB memory when you are done using it.
- When you select **Clock** or **Speana** on *Selecting the background display* on page 54, the artwork is not displayed. ■

Introduction of still image playback operations

You can view still images saved in CD-R/CD-RW/USB/SD.

CD

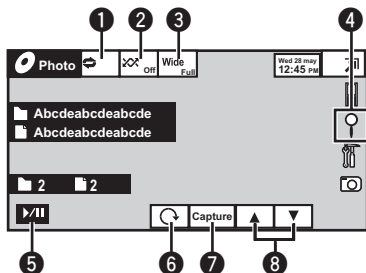

When playing a disc containing a mixture of various media file types

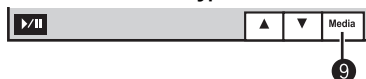

When loading a CD-R/CD-RW/USB/SD containing JPEG picture files, this unit starts a slideshow from the first folder/picture on the disc/device. The player displays the pictures in each folder on the CD-R/CD-RW in alphabetical order by file name.

The table below shows the controls for viewing a slideshow.

Touch panel keys

1		Selecting the repeat range. Refer to <i>Repeating playback</i> on page 27.
2		Playing files in a random order. Refer to <i>Random play (shuffle)</i> on page 27.
3	Wide	Changing the screen mode Refer to <i>Changing the wide screen mode</i> on page 32.
4		Displaying the file name list to select the files. Refer to <i>Selecting files from the file name list</i> on page 31.

5		Starting or pausing the slideshow.
6		Rotating the displayed picture 90° clockwise.
7	Capture	Capturing an image in JPEG files. Refer to <i>Capture an image in JPEG files</i> on page 32.
8		Selecting a folder.
9	Media	Switching between media file types. Refer to <i>Switching the media file type</i> on page 26.

Playing still images

- 1 Insert the disc into the disc loading slot with the label side up.
Playback will automatically start.
 - When the source icon is not displayed, it can be displayed by touching the screen.

Ejecting a disc

- 1 Refer to *Ejecting a disc* on page 12 or *Ejecting an SD* on page 12.

Selecting a file using the buttons

- 1 Press ◀ or ▶ (**TRACK/SEEK**).

Fast file searching

- 1 Press and hold ◀ or ▶ (**TRACK/SEEK**).
 - You can search 10 JPEG files at a time.

Notes

- This unit can play back a JPEG file recorded on CD-R/CD-RW/SD/USB storage device. (Please see the following section for files that can be played back. Refer to *JPEG picture files* on page 68.)
- Files are played back in file number order and folders are skipped if they contain no files. (If folder **01** (ROOT) contains no files, playback commences with folder **02**.) ▣

Playing still images

Introduction of still image playback as a slideshow operations

You can view still images saved in CD-R/CD-RW/USB/SD as a slideshow when listening to another source.

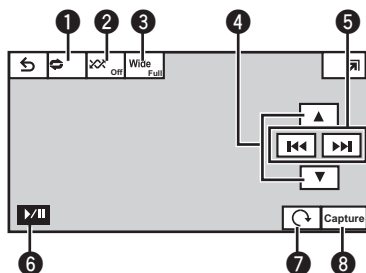

The table below shows the controls for viewing a slideshow.

Touch panel keys

1		Selecting the repeat range. Refer to <i>Repeating playback</i> on page 27.
2		Playing files in a random order. Refer to <i>Random play (shuffle)</i> on page 27.
3		Changing the screen mode. Refer to <i>Changing the wide screen mode</i> on page 32.
4		Selecting a folder.
5		Selecting a file.
6		Starting or pausing the slideshow.

7		Rotating the displayed picture 90° clockwise.
8		Capturing an image in JPEG files. Refer to <i>Capture an image in JPEG files</i> on page 32.

1 Start slideshow when listening to another source.

Refer to *Common operations for menu settings/lists* on page 12.



Displaying still images as a slideshow.

2 Select the device containing the files that you want to display.

- **Disc** – Built-in DVD player
- **USB** – USB
- **SD** – SD memory card
- To cancel searching, touch **Cancel**.

Note

When the USB or SD source is selected, this unit cannot view still images on USB/SD as a slideshow.

Introduction of Bluetooth telephone operations

Telephone standby display

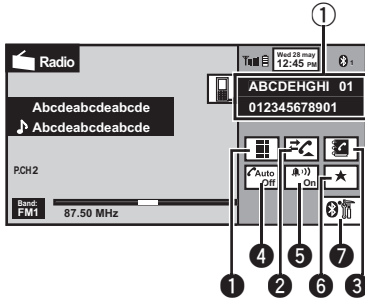

When switching to the entering phone number mode

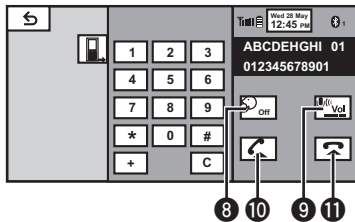

You can use Bluetooth telephone (AVH-6300BT only).

Important

- Since this unit is on standby to connect with your cellular phone via Bluetooth wireless technology, using it without the engine running can drain the battery power.
- Advanced operations that require attention such as dialing numbers on the monitor, etc., are prohibited while driving. Park your vehicle in a safe place when using these advanced operations.
- Operations available may be limited depending on the cellular phone connected to this unit.
- Be sure to park your vehicle in a safe place and apply the parking brake when performing this operation.

① Incoming call notice

Indicates that an incoming call has been received and has not been checked yet.

- Not displayed for calls made when your cellular phone is disconnected from this unit.

Touch panel keys

①		Switching the mode to enter the phone number directly. Refer to <i>Making a call by entering phone number</i> on page 35.
②		Switching to the call history list. Refer to <i>Using the missed, received and dialed call lists</i> on page 34.
③		Switching to the phone book mode. Refer to <i>Calling a number in the phone book</i> on page 33. Refer to <i>Selecting a number by alphabet search mode</i> on page 33.
④		Turning automatic answering on or off. Refer to <i>Setting automatic answering</i> on page 34.
⑤		Turning the ring tone for incoming calls on or off. Refer to <i>Switching the ring tone</i> on page 35.
⑥		Displaying the preset dial screen. Refer to <i>Using the preset dial lists</i> on page 35.
⑦		Displaying the Bluetooth connection menu. Refer to the instructions from page 36 to page 38.
⑧		Turning private mode on or off. Refer to <i>Setting the private mode</i> on page 36.
⑨		Adjusting the other party's listening volume. Refer to <i>Adjusting the other party's listening volume</i> on page 35.

Bluetooth Telephone

⑩



Accepting an incoming call.
Making a phone call, when selecting a phone number.
Switching between callers on hold.

⑪



Ending a call.
Rejecting an incoming call.
Canceling call waiting.

Notes

- You can also use **MUTE**/ to accept an incoming call, end a call and reject an incoming call.
- Private mode can only be operated while you are talking on the phone.
- To end the call, both you and the other caller must hang up your phones.

Setting up for hands-free phoning

Before you can use the hands-free phoning function you must set up the unit for use with your cellular phone. This entails establishing a Bluetooth wireless connection between this unit and your phone, registering your phone with this unit, and adjusting the volume level.

① Connection

First, you need to connect a Bluetooth telephone to this unit.

For detailed instructions on connecting your phone to this unit via Bluetooth wireless technology, see following section. *Using a Bluetooth device to pair* on page 36 and *Pairing from this unit* on page 36.

② Volume adjustment

Adjust the earpiece volume of your cellular phone to your preference. The unit will record the adjusted volume level as the default setting.

- The volume of the caller's voice and ring tone may vary depending on the type of cellular phone.
- If there is a large volume difference between the ring tone and caller's voice, the overall volume level may become unstable.
- Make sure to adjust the volume to a proper level before disconnecting the cellular phone from the unit. If the volume is muted (zero level) on your cellular phone, the volume level of your cellular phone remains muted even after the cellular phone is disconnected.



Storing and recalling stations

You can easily store up to six stations for each band as presets.

1 Display the preset screen.

Refer to *Introduction of tuner operations* on page 14.

The preset screen appears in the display.

2 Touch and hold one of the preset tuning keys to store the selected frequency in the memory.

The selected radio station frequency has been stored in the memory.

3 Touch one of the preset tuning keys to select the desired station.

Displaying radio text

Radio text data transmitted by RDS stations, such as station information, the name of the currently broadcast song and the name of the artist, can be displayed on this tuner.

- When no radio text is received, **No Text** appears in the display. 

Storing and recalling radio text

You can store data from up to six radio text transmissions to the **Memo1** to **Memo6** keys.

1 Display the radio text you want to store in the memory.

Refer to *Introduction of tuner operations* on page 14.

2 Touch and hold one of the keys to store the selected radio text.

The memory number is displayed and the selected radio text will be stored in the memory. The next time you press the same button in radio text display the stored text will be recalled from the memory. 

Storing the strongest stations

BSM (best stations memory) automatically stores the six strongest stations in the order of their signal strength.

Storing broadcast frequencies with BSM may replace broadcast frequencies you have saved using the preset tuning keys.

1 Display the preset screen.

Refer to *Introduction of tuner operations* on page 14.

The preset screen appears in the display.

2 Touch BSM to turn BSM on.

The six strongest broadcast frequencies will be stored under preset tuning keys in order of their signal strength.

- To cancel the storage process, touch **Cancel**. 

Tuning in to strong signals

Local seek tuning lets you tune in to only those radio stations with sufficiently strong signals for good reception.

FM: off — — — — — 

MW/LW: off — — — — — 

The highest level setting allows reception of only the strongest stations, while lower levels allow the reception of weaker stations. 

Receiving traffic announcements

Regardless of the source you are listening to, you can receive traffic announcements automatically with TA (traffic announcement standby).

1 Tune in to a TP or enhanced other network's TP station.

 indicator lights up.

Detailed instructions

2 Turn Traffic announcement on.

Refer to *Introduction of tuner operations* on page 14.

- If the TA function is turned on when you are not tuned in to a TP or enhanced other network's TP station, the  indicator lights up dimly.

3 Turn volume(MUTE) to adjust the TA volume when a traffic announcement begins.

The newly set volume is stored in the memory and will be recalled for subsequent traffic announcements.

4 Cancel the announcement while a traffic announcement is being received.

Refer to *Introduction of tuner operations* on page 14.

The tuner returns to the original source but remains in the TA function standby mode until the icon is touched again. 

Using PTY functions

You can tune in to a station using PTY (program type) information.

Searching for an RDS station by PTY information

You can search for general types of broadcasting programs, such as those listed in the following section. Refer to this page.

1 Display the preset screen.

Refer to *Introduction of tuner operations* on page 14.

2 Touch PTY.

3 Touch ▲ or ▼ to select a program type.

There are four program types:

News&Info—Popular—Classics—Others

4 Touch Start to begin the search.

The unit searches for a station broadcasting that type of program. When a station is found, its program service name is displayed.

PTY (program type ID code) information is listed in the following section. Refer to this page.

- To cancel the search, touch **Cancel**.
- The program of some stations may differ from that indicated by the transmitted PTY.
- If no station is broadcasting the type of program you searched for, **Not Found** is displayed for about two seconds and then the tuner returns to the original station.

Using news program interruption

When a news program is broadcast from a PTY code news station, the unit can switch from any station to the news broadcast station. When the news program ends, reception of the previous program resumes.

PTY list

News&Info

News (News), **Affairs** (Current affairs), **Info** (Information), **Sport** (Sports), **Weather** (Weather), **Finance** (Finance)

Popular

Pop Mus (Popular music), **Rock Mus** (Rock music), **Easy Mus** (Easy listening), **Oth Mus** (Other music), **Jazz** (Jazz), **Country** (Country music), **Nat Mus** (National music), **Oldies** (Oldies music), **Folk Mus** (Folk music)

Classics

L. Class (Light classical), **Classic** (Classical)

Others

Educate (Education), **Drama** (Drama), **Culture** (Culture), **Science** (Science), **Varied** (Varied), **Children** (Children's), **Social** (Social affairs), **Religion** (Religion), **Phone In** (Phone in), **Touring** (Travel), **Leisure** (Leisure), **Document** (Documentaries)



Switching the media file type

When playing a disc containing a mixture of various media file types, such as DivX and MP3, you can switch between media file types to play.

Audio data (CD-DA) and JPEG picture files on DVD-R/RW/ROM cannot be played back on this unit.

CD (audio data (CD-DA))—**Music/ROM** (compressed audio)—**Video** (DivX video files)—**Photo** (JPEG picture files) 

Operating the DVD menu

(Function for DVD video)

Some DVDs allow you to make a selection from the disc contents using a menu.

Using the arrow keys

1 Display arrow keys to operate the DVD menu.

Refer to *Playing moving images* on page 15.

2 Select the desired menu item.

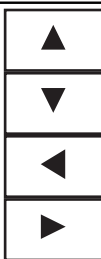

Selecting the desired menu item.



Starting playback from the selected menu item.



Operating the DVD menu by directly touching the menu item.

- When operating the DVD menu by directly touching the menu item, touch the icon to operate.



Returning to the normal DVD video display.



Displaying arrow keys.

- Ways to display the menu will differ depending on the disc.
- Depending on the contents of the DVD disc, this function may not work properly. In such cases, use the touch panel keys to operate the DVD menu. 

Operating this unit's iPod function from your iPod

You can listen to the sound from your iPod applications using your car's speakers, when **App Mode** is selected.

This function is not compatible with the following iPod models.

- iPod nano 1st generation
- iPod 5th generation
- While this function is in use, the iPod will not turn off even if the ignition key is turned off. Operate the iPod to turn off the power.

1 Switch the control mode to App Mode.

Refer to *Introduction of video playback operations* on page 15.

Refer to *Introduction of sound playback operations* on page 18.

2 Operate the connected iPod to select a video/song and play.

Notes

- The following functions are still accessible from the unit even if the control mode is set to **App Mode**.
 - Playing/pausing
 - Fast forwarding/reversing
 - Tracking up/down
 - Moving to a chapter up/down
- APP mode is compatible with the following iPod models.

Detailed instructions

- iPhone 4 (software version 4.1 or later)
- iPhone 3GS (software version 4.1 or later)
- iPhone 3G (software version 4.1 or later)
- iPhone (software version 3.1.3 or later)
- iPod touch 4th generation (software version 4.1 or later)
- iPod touch 3rd generation (software version 4.0 or later)
- iPod touch 2nd generation (software version 4.0 or later)
- iPod touch 1st generation (software version 3.1.3 or later)

Random play (shuffle)

Videos/songs/files can be played back in random order.

- **Songs** – Play back videos/songs in the selected list in random order.
- **Albums** – Play back videos/songs from a randomly selected album in order.
- **Folder** – Play back songs/tracks in the selected folder in random order.
- **Disc** – Play back songs/tracks in the selected disc in random order.
- **On** – Play back files in random order within the repeat range, **Folder** and **Disc**.
- **Off** – Cancel random play.

Playing all songs in random order (shuffle all)

(Function for iPod)

This method plays all songs on the iPod randomly.

Repeating playback

- **Disc** – Play through the current disc
- **Chapter** – Repeat the current chapter
- **Title** – Repeat the current title
- **Track** – Repeat the current track
- **File** – Repeat the current file
- **Folder** – Repeat the current folder

- **One** – Repeat just the current video/song/track
- **All** – Repeat all videos/songs in the selected list on the iPod
Repeat all files
- This function cannot be operated during Video CD playback featuring PBC (playback control).
- If you perform chapter search, fast forward/reverse, frame-by-frame playback or slow motion playback, the title repeat play will stop.
- When playing discs with compressed audio and audio data (CD-DA), playback is repeated within the type of data currently playing even if **Disc** is selected.
- If you select another folder during repeat play, the repeat play range changes to **Disc**. If you select USB or SD source, the repeat play range changes to **All**.
- If you perform track search or fast forward/reverse during **File**, the repeat play range changes to **Folder**.
- If you perform title/chapter search, fast forward/reverse, frame-by-frame playback or slow motion playback during **Chapter**, the repeat play range changes to **OFF**.
- If you perform track search or fast forward/reverse during **Track**, the repeat play range changes to **Disc**.
- When **Folder** is selected, it is not possible to play back a subfolder of that folder.

Playing videos from your iPod

(Function for iPod)

Videos can be played on this unit if an iPod with video capabilities is connected.

- This unit can play back “Movies”, “Music videos”, “Video Podcast” and “TV show” which are downloaded from the iTunes store.
- Before you display the video screen, be sure to change the video setting on the iPod so that the iPod can output the video to an external device.

Detailed instructions

1 Display the iPod menus.

Refer to *Playing moving images* on page 15.

2 Switch to iPod video mode.



Switching to iPod video mode.

3 Play the video from the iPod.

▪ If you want to switch to iPod music mode, touch the icon.



Switching to iPod music mode.



Browsing for a video/music on the iPod

(Function for iPod)

To make operating and searching easy, operations to control an iPod with this unit are designed to be as similar to the iPod as possible.

Searching for a video/music by category

1 Display the iPod menus.

Refer to *Playing moving images* on page 15.

Refer to *Playing audio* on page 18.

2 Touch one of the categories in which you want to search for a video/music.

- **Video Playlists** (video playlists)
- **Movies** (movies)
- **Music Videos** (music videos)
- **Video Podcasts** (video podcasts)
- **TV Shows** (TV shows)
- **Playlists** (playlists)
- **Artists** (artists)
- **Albums** (albums)
- **Songs** (songs)
- **Podcasts** (podcasts)
- **Genres** (genres)
- **Composers** (composers)
- **Audiobooks** (audiobooks)

3 Touch the title of the list that you want to play.

Repeat this operation until you find the desired video/music.

4 Start playback of the selected list.



Starting playback of the selected list.

Searching the list by alphabet

(Function for iPod)

1 Select a category.

Refer to *Searching for a video/music by category* on this page.

2 Switch to alphabet search mode.



Switching to alphabet search mode.

Alphabet search mode is displayed.

3 Touch the first letter of the title of the video/song you are looking for.

While searching, touch panel key operation is not available.

▪ To refine the search with a different letter, touch **Cancel**.

4 Touch the title of the list that you want to play.

Repeat this operation until you find the desired song/video.

5 Start playback of the selected list.



Starting playback of the selected list.



Resume playback (Bookmark)

(Function for DVD video)

Detailed instructions

By using the Bookmark function, you can resume playback from a selected scene the next time the disc is loaded.

The selected scene will be bookmarked so that playback resumes from that point next time.

- To clear the bookmark on a disc, touch and hold the button during playback.
- The oldest bookmark is replaced by the new one. 

Frame-by-frame playback

(Function for DVD video/video CD/DivX file)

Note

Images during frame-by-frame playback may be unclear for some discs. 

Slow motion playback

Notes

- There is no sound during slow motion playback.
- Images during slow motion playback may be unclear for some discs.
- Reverse slow motion playback is not available. 

Searching for the part you want to play

You can use the search function to find the part you want to play.

For DVD videos, you can select **Title** (title), **Chapter** (chapter) or **10key** (numeric keypad). For video CDs, you can select **Track** (track) or **10key** (numeric keypad).

- Chapter search is not available when disc playback is stopped.
- This function cannot be operated during some DVD videos or Video CD playback featuring PBC (playback control).

1 Start the search function.

Refer to *Playing moving images* on page 15.

2 Touch the desired search option (e.g., Chapter).

3 Touch 0 to 9 to input the desired number.

- To cancel the entered numbers, touch **C**.

4 Start playback from the selected part.



Registering the numbers and starting playback.

Note

With discs featuring a menu, you can also use the DVD menu to make your selection.

Refer to *Playing moving images* on page 15. 

Changing audio language during playback (Multi-audio)

With DVDs/DivX files that provides audio playback in different languages and different audio systems (Dolby Digital, DTS, etc.), you can switch between languages/audio systems during playback.

Notes

- With some DVDs, switching between languages/audio systems may only be possible using a menu display.
- You can also switch between languages/audio systems using **Video Setup** menu. For details, refer to *Setting the audio language* on page 43.
- Depending on the setting, the video may not be played back with the audio system used to record the DVD.
- You will return to normal playback if you change the **Audio** during fast forward/fast rewind, pause or slow motion playback. 

Changing the subtitle language during playback (Multi-subtitle)

With DVDs/DivX files featuring multi-subtitle recordings, you can switch between subtitle languages during playback.

Notes

- With some DVDs, switching between subtitle languages may only be possible using a menu display.
- You can also switch between subtitle languages using **Video Setup** menu. For details, refer to *Setting the subtitle language* on page 43.
- You will return to normal playback if you change the **Subtitle** during fast forward/fast rewind, pause or slow motion playback. 

Changing the viewing angle during playback (Multi-angle)

With DVDs featuring multi-angle (scenes shot from multiple angles) recordings, you can switch among viewing angles during playback.

- During playback of a scene shot from multiple angles, the angle icon is displayed. Use the **Video Setup** menu to turn the angle icon display on or off. For details, refer to *Setting the multi-angle DVD display* on page 44.

Note

You will return to normal playback if you change the viewing angle during fast forward/fast rewind, pause or slow motion playback. 

Return to the specified scene

(Function for DVD video)

This function cannot be used if a specified scene has not been preprogrammed on the DVD disc. 

Selecting audio output

When playing DVD video discs recorded with LPCM audio, you can switch the audio output. When playing video CDs, you can switch between stereo and monaural audio output.

- This function is not available when disc playback is stopped.
- **L+R** – left and right
- **Left** – left
- **Right** – right
- **Mix** – mixing left and right

You may not be able to select or use this function depending on the disc and the playback location. 

PBC playback

(Function for Video CDs)

During playback of Video CDs featuring PBC (Playback Control), **PBC ON** is displayed.

1 Start the search function.

Refer to *Playing moving images* on page 15.

2 Touch 10key to display the numeric keypad.

3 Touch 0 to 9 corresponding to a menu number.

4 Start playback from the selected part.



Registering the numbers and starting playback.

Notes

- You can display the menu by touching **Return** during PBC playback. For details, refer to the instructions provided with the disc.
- PBC playback of a Video CD cannot be canceled.
- During playback of Video CDs featuring PBC (Playback Control), you cannot select the repeat play range or use the search function. 

Detailed instructions

Selecting tracks from the track title list

You can select tracks to playback using the track title list which is a list of the tracks recorded on a disc.

1 Display the track title list.

Refer to *Playing audio* on page 18.

2 Touch your favorite track title.

Playback begins. 

Selecting files from the file name list

(Function for USB/SD/DivX)

File name list is a list of file names (or folder names) from which you can select a file (or folder) to playback.

1 Display the file (or folder) name list.

Refer to *Playing audio* on page 18.

Refer to *Introduction of still image playback operations* on page 20.

2 Touch your favorite file (or folder) name.

- When you have selected a folder, a list of the names of the files (or the folders) in it can be viewed. Repeat this operation to select the desired file name.

- If folder **01** (ROOT) contains no files, playback commences with folder **02**.

3 Start playback of the selected list.







Starting playback of the selected list.



Changing audiobook speed

(Function for iPod)

-  – Playback at a speed faster than normal
-  – Playback at normal speed
-  – Playback at a speed slower than normal 

Displaying lists related to the currently playing song (Link Search)

(Function for iPod)

1 Start Link Search.

Refer to *Introduction of sound playback operations* on page 18.

2 Touch one of the categories in which you want to play.

- **Artist** – Displays an album list of the artist currently being played.
- **Album** – Displays a song list from the album currently being played.
- **Genre** – Displays an album list from the genre currently being played.
- To cancel searching, touch **Cancel**.

3 Touch the title of the list that you want to play.

4 Start playback of the selected list.



Starting playback of the selected list.



Using S.Rtrv (sound retriever)

Automatically enhances compressed audio and restores rich sound.

Off — 

-  is more effective than . 

Playing DivX® VOD content

Some DivX VOD (video on demand) content may only be playable a fixed number of times. When you load a disc containing this type of content, the remaining number of times it can be played is shown on-screen. You can then decide whether or not to play the disc.

Detailed instructions

- If there is no limit to the number of times the DivX VOD content can be viewed, then you may load the disc into your player and play the content as often as you like, and no message will be displayed.
- You can confirm the number of times that the content can be played by checking the number displayed after **Remaining Views**:

Important

- In order to play DivX VOD contents on this unit, you first need to register the unit with your DivX VOD contents provider. For details on your registration code, refer to *Displaying the DivX® VOD registration code* on page 46.
- DivX VOD content is protected by a DRM (Digital Rights Management) system. This restricts playback of content to specific, registered devices.

● **If a message is displayed after loading a disc containing DivX VOD content, touch Play.**

Playback of the DivX VOD content will start.

- To skip to the next file, touch **Next Play**.
- If you do not want to play the DivX VOD content, touch **Stop**. 

Capture an image in JPEG files

You can capture image data and use it as wallpaper. Images can be stored and recalled easily in this unit.

- Only one image can be stored on this unit. Old image is overwritten with the new one.

1 **Pause the slideshow when the desired image is displayed.**

Refer to *Introduction of still image playback operations* on page 20.

Refer to *Introduction of still image playback as a slideshow operations* on page 21.

2 **Capture the image.**

Refer to *Introduction of still image playback operations* on page 20.

Refer to *Introduction of still image playback as a slideshow operations* on page 21.

3 **When Do you save this image? is displayed, touch Yes.**

While storing the image to this unit, **Saving the image Don't switch off the battery.** is displayed. When the process is finished, **Image saved.** is displayed.

- To cancel the storage process, touch **No**. 

Changing the wide screen mode

You can select a desired mode for enlarging a 4:3 picture to a 16:9 picture.

1 **Display the screen mode.**

Refer to *Introduction of video playback operations* on page 15.

Refer to *Introduction of still image playback operations* on page 20.

Refer to *Introduction of still image playback as a slideshow operations* on page 21.

2 **Touch the desired wide mode setting.**

Full (full screen)

The 4:3 picture is enlarged in the horizontal direction only, giving you a 4:3 TV picture (normal picture) without any omissions.

Just (just)

The picture is enlarged slightly at the center and the amount of enlargement increases horizontally toward the edges of the screen, enabling you to enjoy a 4:3 picture without sensing any disparity even when viewing on a wide screen.

Cinema (cinema)

The picture is enlarged by the same proportion as **Full** or **Zoom** in the horizontal direction and by an intermediate proportion between **Full** and **Zoom** in the vertical direction; ideal for a cinema-sized picture (wide screen picture) where captions lie outside the picture.

Zoom (zoom)

The 4:3 picture is enlarged in the same proportion both vertically and horizontally; ideal for a cinema sized picture (wide screen picture).

Detailed instructions

Normal (normal)

The 4:3 picture is displayed as it is, giving you no sense of disparity since its proportions are the same as that of the normal picture.

Notes

- You cannot operate this function while driving.
- Different settings can be stored for each video source.
- When a video is viewed in a wide screen mode that does not match its original aspect ratio, it may appear different.
- Remember that using the wide mode feature of this system for commercial or public viewing purposes may constitute an infringement on the author's rights protected by the Copyright Law.
- The video image will appear coarser when viewed in **Cinema** or **Zoom** mode. 

Calling a number in the phone book

(Function of AVH-6300BT)

The phone book in your cellular phone will be transferred automatically when the phone is connected to this unit.

After finding the number you want to call in the phone book, you can select the entry and make the call.

1 Switch to phone book mode.

Refer to *Introduction of Bluetooth telephone operations* on page 22.

The phone book display appears.

2 Select the phone number list.

The detailed phone number list of the selected entry is displayed.

3 Select the phone number.

- If you want to store the phone number, touch and hold the list.

4 Make the call.

Refer to *Introduction of Bluetooth telephone operations* on page 22.

5 End the call.

Refer to *Introduction of Bluetooth telephone operations* on page 22.

Note

Depending on the cellular phone, the phone book may not be transferred automatically. In this case, operate your cellular phone to transfer the phone book. The visibility of this unit should be on. Refer to *Switching visible unit* on page 37. 

Selecting a number by alphabet search mode

(Function of AVH-6300BT)

If a lot of numbers are registered in the phone book, you can search for the phone number by alphabet search mode.

1 Switch to phone book mode.

Refer to *Introduction of Bluetooth telephone operations* on page 22.

The phone book display appears.

2 Touch ABC to switch to alphabet search mode.

3 Touch the first letter of the entry you are looking for.

The Phone Book entries starting with that letter (e.g. "Ben", "Brian" and "Burt" when "B" is selected) will be displayed.

- If you want to change the character to Russian, touch the icon. To return to English, touch the icon again.



Changing the character to Russian.

- The order of the first name and last name may be different from that of the cellular phone.

4 Touch the list to display the phone number list of the selected entry.

- If several phone numbers are included in an entry, select one by touching the list.
- If you want to switch to the call history list, touch the icon.



Switching to the call history list.

5 Make the call.

Refer to *Introduction of Bluetooth telephone operations* on page 22.

6 End the call.

Refer to *Introduction of Bluetooth telephone operations* on page 22. 

Using the missed, received and dialed call lists

(Function of AVH-6300BT)

The 80 most recent calls dialed, received, and missed are stored in the memory. You can browse them and call numbers from these lists.

1 Switch to the call history list.

Refer to *Introduction of Bluetooth telephone operations* on page 22.

2 Select Missed Calls, Dialed Calls or Received Calls.



Displaying the received call list.



Displaying the dialed call list.



Displaying the missed call list.

3 Touch the list number to select a phone number.

Name and phone number are displayed in the detailed list.

- If you want to store the phone number, touch and hold the list.

4 Make the call.

Refer to *Introduction of Bluetooth telephone operations* on page 22.

5 End the call.

Refer to *Introduction of Bluetooth telephone operations* on page 22. 

Setting automatic answering

(Function of AVH-6300BT)

If this function is on, this unit automatically answers all incoming calls.

● Turn automatic answering on or off.

Refer to *Introduction of Bluetooth telephone operations* on page 22. 

Detailed instructions

Adjusting the other party's listening volume

(Function of AVH-6300BT)

To maintain the good sound quality, this unit can adjust the other party's listening volume. If the volume is not loud enough for the other party, use this function.

● Select Far-End VOL.

Refer to *Introduction of Bluetooth telephone operations* on page 22.

1—2—3

- This function can be performed even while talking on the phone.
- Settings can be stored for each device.

Switching the ring tone

(Function of AVH-6300BT)

You can select whether or not to use this unit's ring tone. If this function is set to on, the ring tone for this unit will sound.

1 Connect your cellular phone to this unit.

2 Turn ring tone on or off.

Refer to *Introduction of Bluetooth telephone operations* on page 22.

Using the preset dial lists

(Function of AVH-6300BT)

You can easily store up to six phone numbers as presets.

1 Display the preset screen.

Refer to *Introduction of Bluetooth telephone operations* on page 22.

2 Touch one of preset dial keys to select the desired phone number.

- If you want to delete a preset phone number, touch and hold the preset dial key.

3 Make the call.

Refer to *Introduction of Bluetooth telephone operations* on page 22.

4 End the call.

Refer to *Introduction of Bluetooth telephone operations* on page 22.

Making a call by entering phone number

(Function of AVH-6300BT)

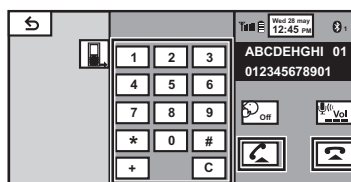

⚠ Important

Be sure to park your vehicle in a safe place and apply the parking brake when performing this operation.

1 Switch to the entering phone number mode.

Refer to *Introduction of Bluetooth telephone operations* on page 22.

2 Touch the number icons to input the numbers.

- Up to 24 digits can be entered.

3 Make the call.

Refer to *Introduction of Bluetooth telephone operations* on page 22.

4 End the call.

Refer to *Introduction of Bluetooth telephone operations* on page 22.

Note

Entering phone number mode cannot be operated unless a Bluetooth telephone is connected to this unit.

Setting the private mode

(Function of AVH-6300BT)

During a conversation, you can switch to private mode (talk directly on your cellular phone).

Refer to *Introduction of Bluetooth telephone operations* on page 22. 

Pairing from this unit

(Function of AVH-6300BT)

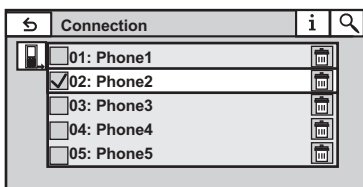

1 Display the Bluetooth Connection Menu.

Refer to *Introduction of Bluetooth telephone operations* on page 22.

2 Touch Connection to select a device.

3 Start to search.



Starting to search.

While searching,  is displayed and when available devices are found, the device names or Bluetooth device addresses (if names cannot be obtained) are displayed.

- If you want to switch between the device names and Bluetooth device addresses, touch the icon.



Switching between the device names and Bluetooth device addresses.

- To cancel searching, touch **Stop**.
- If five devices are already paired, **Memory Full** is displayed and pairing cannot be

performed. In such cases, delete a paired device first. Refer to this page.

- If no device can be found, **Not Found** is displayed. In such cases, check the status of the Bluetooth device and search again.

4 Touch a device name to select the device you want to connect to.

While connecting, **Pairing** is displayed. If the connection is established, **Paired** is displayed.

- If the connection fails, **Error** is displayed. In such cases, try again from the beginning.
- The PIN code is set to **0000** as the default, but can be changed. Refer to *Entering PIN code for Bluetooth wireless connection* on page 38.
- When establishing connection, the icon is displayed.

Touch the icon to disconnect the device.



Disconnecting a Bluetooth device.

- If you want to delete a paired Bluetooth telephone, display **Delete OK?**. Touch **Yes** to delete the device.



Deleting a paired device.

- Never turn the unit off while the paired Bluetooth telephone is being deleted. 

Using a Bluetooth device to pair

(Function of AVH-6300BT)

If you cannot open the connection between your Bluetooth device and this unit from your Bluetooth device, you can use this function to establish a connection.

1 Display the Bluetooth Connection Menu.

Refer to *Introduction of Bluetooth telephone operations* on page 22.

Detailed instructions

2 Touch Special Device to select the special device.

- Bluetooth devices that are difficult to establish a connection with are called special devices. If your Bluetooth device is listed as a special device, select the appropriate one.

3 Touch the special device list to open the connection.

This unit is now on standby for a connection with the Bluetooth device.

- If five devices are already paired,

Memory Full is displayed and pairing cannot be performed. In such cases, delete a paired device first. Refer to the previous page.

4 Use your Bluetooth device to establish a connection.

The connection method is different depending on the Bluetooth device. Refer to the manual for your Bluetooth device to establish a connection.

While connecting, **Pair your phone** is displayed. If the connection is established, **Paired** is displayed.

- If the connection fails, **Error** is displayed. In such cases, try again from the beginning.
- You may also need to enter a PIN code into this unit. If your telephone requires a PIN code to establish a connection, look for the code on the telephone or in its accompanying documentation.
- The PIN code is set to **0000** as the default, but can be changed. Refer to *Entering PIN code for Bluetooth wireless connection* on the next page. 

Connecting to a Bluetooth device automatically

(Function of AVH-6300BT)

If this function is set to on, a connection between your Bluetooth device and this unit will take place automatically as soon as the two devices are less than a few meters apart. Initially, this function is set to on.

1 Display the Bluetooth Connection Menu.

Refer to *Introduction of Bluetooth telephone operations* on page 22.

2 Touch Auto Connect to turn automatic connection on.

If your Bluetooth device is ready for a Bluetooth wireless connection, a connection to this unit will automatically be established.

- To turn automatic connection off, touch **Auto Connect** again.

3 Turn your vehicle's ACC switch off and on.

Switching visible unit

(Function of AVH-6300BT)

This function sets whether or not to make this unit visible to the other device.

Initially, this function is set to on.

1 Display the Bluetooth Connection Menu.

Refer to *Introduction of Bluetooth telephone operations* on page 22.

2 Touch Visibility to select visibility off.

- To turn visibility on, touch **Visibility** again. 

Displaying Bluetooth Device address

(Function of AVH-6300BT)

This unit displays its Bluetooth device address.

1 Display the Bluetooth Connection Menu.

Refer to *Introduction of Bluetooth telephone operations* on page 22.

2 Touch Device Information to display device information.

The Bluetooth device address is displayed. 

Entering PIN code for Bluetooth wireless connection

(Function of AVH-6300BT)

To connect your Bluetooth device to this unit via Bluetooth wireless technology, you need to enter a PIN code on your Bluetooth device to verify the connection. The default code is **0000**, but you can change it with this function.

1 Display the Bluetooth Connection Menu.

Refer to *Introduction of Bluetooth telephone operations* on page 22.

2 Touch PIN Code Input to select PIN code input.

3 Touch 1 to 0 to input pin code.

4 After inputting PIN code (up to 8 digits), store in this unit.



Storing the PIN code in this unit.



Menu operations

Introduction of menu operations

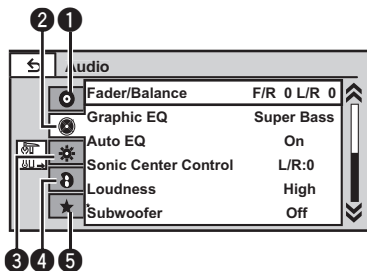

- You cannot display the Audio function menu when the mute function is on or a JPEG file is playing.

1 Display menus.

Refer to *Common operations for menu settings/lists* on page 12.

2 Touch any of the following touch panel keys to select the menu to be adjusted.

Touch panel keys

1		Video Setup menu Refer to <i>Setting up the DVD player</i> on page 43.
2		Audio function menu Refer to <i>Audio Adjustments</i> on the next page.
3		System menu Refer to <i>System settings</i> on page 47.
4		Entertainment menu Refer to <i>Entertainment settings</i> on page 54.
5		Custom menu You can choose menus within each menu (Audio function menu, etc.) and register them to this custom menu. Refer to <i>Customizing menus</i> on page 55.

Notes

- You can display the **Video Setup** menu when a **Disc**, **USB** or **SD** source is selected.
- If you start the **Video Setup** menu, playback is stopped.

Audio Adjustments

Note

When selecting FM as the source, you cannot switch to **Source Level Adjuster**.

Using fader/balance adjustment

You can change the fader/balance setting to provide an ideal listening environment for all of the occupied seats.

1 Display the audio function menu.

Refer to *Introduction of menu operations* on the previous page.

2 Touch Fader/Balance on the audio function menu.

3 Touch ▲ or ▼ to adjust the front/rear speaker balance.

Range: **Front:15 to Rear:15**

- Select **F/R: 0 L/R: 0** when only using two speakers.
- The front/rear speaker balance cannot be adjusted when the rear output setting is

Subwoofer. Refer to *Setting the rear output and subwoofer controller* on page 47.

4 Touch ◀ or ▶ to adjust the left/right speaker balance.

Range: **Left:15 to Right:15**

Using the equalizer

You can adjust the equalization to match the car's interior acoustic characteristics as desired.

Recalling equalizer curves

There are seven stored equalizer curves which you can easily recall at any time. Here is a list of the equalizer curves.

Display	Equalizer curve
Powerful	Powerful
Natural	Natural

Display	Equalizer curve
Vocal	Vocal
Custom1	Custom 1
Custom2	Custom 2
Flat	Flat
Super Bass	Super bass

- The equalizer curves for **Custom1** and **Custom2** can be adjusted.
- You cannot select **Custom1** and **Custom2** when using the auto-equalizer.
- When **Flat**, no changes are made to the sound. You can check the effects of the equalizer curves by switching alternatively between **Flat** and another equalizer curve.

1 Display the audio function menu.

Refer to *Introduction of menu operations* on the previous page.

2 Touch Graphic EQ on the audio function menu.

- You can select **Graphic EQ** when **Auto EQ** function is off.

3 Touch ◀ or ▶ to select the desired item.

Powerful—Natural—Vocal—Custom1—Custom2—Flat—Super Bass

Adjusting the 8-band graphic equalizer

You can adjust the level of each band for the equalizer curves.

- A separate **Custom1** curve can be created for each source. If you make adjustments when a curve other than **Custom2** is selected, the equalizer curve settings will be recorded in **Custom1**.
- A **Custom2** curve that is common for all sources can be created. If you make adjustments when the **Custom2** curve is selected, the **Custom2** curve will be updated.

1 Display the audio function menu.

Refer to *Introduction of menu operations* on the previous page.

Menu operations

2 Touch Graphic EQ on the audio function menu.

3 Touch ◀ or ▶ to select the desired item. Powerful—Natural—Vocal—Custom1—Custom2—Flat—Super Bass

4 Touch the Equalizer band to adjust.

5 Touch ▲ or ▼ to adjust the level of the equalizer band.

Range: **+12dB to -12dB**

- You can then select another band and adjust the level.

Using the auto-equalizer

The auto-equalizer is an equalizer curve created by auto EQ (refer to *Auto EQ (auto-equalizing)* on page 52).

You can turn the auto-equalizer on or off.

If you connect an optional microphone to this unit, you can use this function.

1 Display the audio function menu.

Refer to *Introduction of menu operations* on page 39.

2 Touch Auto EQ to turn the auto-equalizer on or off.

- You cannot use this function if auto EQ has not been carried out.

Using sonic center control

Sound that is suited for the listening position can easily be created with this function.

1 Display the audio function menu.

Refer to *Introduction of menu operations* on page 39.

2 Touch Sonic Center Control on the audio function menu.

3 Touch ◀ or ▶ to select a listening position.

Range: **Left:7 to Right:7**

Adjusting loudness

Loudness compensates for deficiencies in the low- and high-frequency ranges at low volume.

1 Display the audio function menu.

Refer to *Introduction of menu operations* on page 39.

2 Touch Loudness on the audio function menu.

3 Touch ◀ or ▶ to select a desired level.

Off (off)—Low (low)—Mid (mid)—High (high)

Using subwoofer output

This unit is equipped with a subwoofer output which can be turned on or off.

- The cut-off frequency and output level can be adjusted when the subwoofer output is on.

1 Display the audio function menu.

Refer to *Introduction of menu operations* on page 39.

2 Touch Subwoofer on the audio function menu.

3 Touch On or Off next to Subwoofer to turn the subwoofer output on or off.

4 Touch Normal or Reverse next to Phase to select the phase of subwoofer output.

5 Touch ◀ or ▶ next to Level to adjust the output level of the subwoofer.

Range: **+6 to -24**

6 Touch ◀ or ▶ next to Frequency to select the cut-off frequency.

50Hz—63Hz—80Hz—100Hz—125Hz

Only frequencies lower than those in the selected range are outputted from the subwoofer.

Boosting the bass

You can boost the bass level.

1 Display the audio function menu.

Refer to *Introduction of menu operations* on page 39.

2 Touch ◀ or ▶ to select a desired level.

Range: **0** to **+6**

Using the high pass filter

When you do not want low sounds from the subwoofer output frequency range to play from the front or rear speakers, turn on the HPF (high pass filter). Only frequencies higher than those in the selected range are output from the front or rear speakers.

1 Display the audio function menu.

Refer to *Introduction of menu operations* on page 39.

2 Touch ◀ or ▶ next to Frequency to select cut-off frequency.

Off (off)—50Hz—63Hz—80Hz—100Hz—125Hz

Only frequencies higher than those in the selected range are output from the front or rear speakers.

Adjusting source levels

With SLA (source level adjustment), the volume levels of each source can be adjusted to prevent significant differences between sources.

- Settings are based on the FM volume level, which remains unchanged.

1 Display the audio function menu.

Refer to *Introduction of menu operations* on page 39.

2 Compare the FM volume level with the level of the source you wish to adjust.

3 Touch Source Level Adjuster on the audio function menu.

4 Touch ▲ or ▼ to adjust the source volume.

Range: **+4** to **-4**

Notes

- The MW/LW volume level can also be adjusted with this function.
- Video CD, CD, compressed audio and DivX are automatically set to the same source level adjustment volume.
- iPod and USB storage device are automatically set to the same source level adjustment volume. 

Menu operations

Setting up the DVD player

Setting the subtitle language

You can set a desired subtitle language. When available, the subtitles will be displayed in the selected language.

1 Stop playback.

Refer to *Introduction of video playback operations* on page 15.

2 Display the Video Setup menu.

Refer to *Introduction of menu operations* on page 39.

3 Touch Subtitle Language on the Video Setup menu.

A subtitle language menu is displayed.

4 Touch the desired language.

The subtitle language is set.

- If you have selected **Others**, refer to *When you select Others* on this page.

Notes

- If the selected language is not available, the language specified on the disc is displayed.
- You can also switch the subtitle language by touching the icon during playback. (Refer to *Playing moving images* on page 15.)
- The setting made here will not be affected even if the subtitle language is switched during playback using **Subtitle**.

When you select Others

A language code input display is shown when **Others** is selected. Refer to *Language code chart for DVD* on page 73.

1 Touch 0 to 9 to input the language code.

- To cancel the entered numbers, touch **C**.

2 Registering the code.



Registering the code.

Setting the audio language

You can set the preferred audio language.

1 Display the Video Setup menu.

Refer to *Introduction of menu operations* on page 39.

2 Touch Audio Language on the Video Setup menu.

An audio language menu is displayed.

3 Touch the desired language.

The audio language is set.

- If you have selected **Others**, refer to *When you select Others* on this page.

Notes

- If the selected language is not available, the language specified on the disc is used.
- You can also switch the audio language by touching **Audio** during playback. (Refer to *Playing moving images* on page 15.)
- The setting made here will not be affected even if the audio language is switched during playback using **Audio**.

Setting the menu language

You can set the preferred language in which the menus recorded on a disc are displayed.

1 Display the Video Setup menu.

Refer to *Introduction of menu operations* on page 39.

2 Touch Menu Language on the Video Setup menu.

A menu language menu is displayed.

3 Touch the desired language.

The menu language is set.

- If you have selected **Others**, refer to *When you select Others* on this page.

Note

If the selected language is not available, the language specified on the disc is displayed.

Setting the multi-angle DVD display

The angle icon can be set so it appears on scenes where the angle can be switched.

1 Display the Video Setup menu.

Refer to *Introduction of menu operations* on page 39.

2 Touch Multi Angle on the Video Setup menu to turn angle icon display on or off.

Setting the aspect ratio

There are two kinds of display: a wide screen display that has a width-to-height ratio (TV aspect ratio) of 16:9, and regular display that has a TV aspect of 4:3. Be sure to select the correct TV aspect for the display connected to **REAR MONITOR OUTPUT**.

- When using regular display, select either **Letter Box** or **Pan Scan**. Selecting **16:9** may result in an unnatural picture.
- If you select the TV aspect ratio, the unit's display will change to the same setting.

1 Display the Video Setup menu.

Refer to *Introduction of menu operations* on page 39.

2 Touch TV Aspect on the Video Setup menu to select the TV aspect ratio.

Touch **TV Aspect** repeatedly until the desired aspect ratio appears.

- **16:9** – Wide screen picture (16:9) is displayed as is (initial setting)
- **Letter Box** – The picture is the shape of a letterbox with black bands on the top and bottom of the screen
- **Pan Scan** – The picture is cut short on the right and left sides of the screen

Notes

- When playing discs that do not specify **Pan Scan**, the disc is played back in **Letter Box** display even if you select the

Pan Scan setting. Confirm whether the disc package bears the **16:9 LB** mark.

- The TV aspect ratio cannot be changed for some discs. For details, refer to the disc's instructions.

Setting the slide show interval

JPEG files can be viewed as a slide show on this unit. In this setting, the interval between each image can be set.

1 Display the Video Setup menu.

Refer to *Introduction of menu operations* on page 39.

2 Touch Time Per Photo Slide on the Video Setup menu to select the slide show interval.

Touch **Time Per Photo Slide** repeatedly until the desired setting appears.

- **5sec** – JPEG images switch at intervals of 5 seconds
- **10sec** – JPEG images switch at intervals of 10 seconds
- **15sec** – JPEG images switch at intervals of 15 seconds
- **Manual** – JPEG images can be switched manually

Setting parental lock

Some DVD video discs let you use parental lock to restrict children from viewing violent and adult-oriented scenes. You can set parental lock to the desired level.

- When you have a parental lock level set and play a disc featuring parental lock, code number input indications may be displayed. In such cases, playback will begin when the correct code number is entered.

Menu operations

Setting the code number and level

A code number must be registered in order to play back discs with parental lock.

1 Display the Video Setup menu.

Refer to *Introduction of menu operations* on page 39.

2 Touch Parental on the Video Setup menu.

3 Touch 0 to 9 to input a four digit code number.

- To cancel the entered numbers, touch **C**.

4 Registering the code.



Registering the code.

The code number is set, and the level can now be set.

5 Touch 1 to 8 to select the desired level.

6 Touch Enter.

The parental lock level is set.

- **8** – Playback of the entire disc is possible (initial setting)
- **7 to 2** – Playback of discs for children and non-adult-oriented discs is possible
- **1** – Playback of discs for children only is possible

Notes

- We recommend to keep a record of your code number in case you forget it.
- The parental lock level is stored on the disc. Look for the level indication written on the disc package, included literature or on the disc itself. Parental lock of this unit is not possible if a parental lock level is not stored on the disc.
- With some discs, the parental lock may be active only for certain levels of scenes. The playback of those scenes will be skipped. For details, refer to the instruction manual that came with the disc.

Changing the level

You can change the set parental lock level.

1 Display the Video Setup menu.

Refer to *Introduction of menu operations* on page 39.

2 Touch Parental on the Video Setup menu.

3 Touch 0 to 9 to input the registered code number.

4 Registering the code.



Registering the code.

This sets the code number, and the level can now be changed.

- If you enter an incorrect code number, the  icon is displayed. Touch **C** and enter the correct code number.
- If you forget your code number, refer to *If you forget your code number* on this page.

5 Touch 1 to 8 to select the desired level.

6 Touch Enter.

The new parental lock level is set.

If you forget your code number

Press **RESET**.

Setting the DivX subtitle file

You can select whether or not to display DivX external subtitles.

- The DivX subtitles will be displayed even when **Custom** is selected if no DivX external subtitle files exist.

1 Display the Video Setup menu.

Refer to *Introduction of menu operations* on page 39.

2 Touch DivX Subtitle on the Video Setup menu to select the desired subtitle setting.

- **Original** – Display the DivX subtitles
- **Custom** – Display the DivX external subtitles

Notes

- Up to 42 characters can be displayed on one line. If more than 42 characters are set, the line breaks and the characters are displayed on the next line.
- Up to 126 characters can be displayed on one screen. If more than 126 characters are set, the excess characters will not be displayed.

Displaying the DivX® VOD registration code

In order to play DivX VOD (video on demand) contents on this unit, the unit must first be registered with a DivX VOD contents provider. For registration, generate a DivX VOD registration code and submit it to your provider.

- Keep a record of the code as you will need it when you register your unit to the DivX VOD provider.

1 Display the Video Setup menu.

Refer to *Introduction of menu operations* on page 39.

2 Touch DivX VOD on the Video Setup menu.

Registration Code and **Deregistration Code** appear.

3 Touch Registration Code.

Your registration code is displayed.

Displaying the deregistration code

If your device is already activated, deregister it by entering the deregistration code.

1 Display the Video Setup menu.

Refer to *Introduction of menu operations* on page 39.

2 Touch DivX VOD on the Video Setup menu.

3 Touch Deregistration Code.

- To cancel deregistration, touch **Cancel**.

4 Touch OK.

The deregistration is complete.

Automatic playback of DVDs

When a DVD disc with a DVD menu is inserted, this unit will cancel the menu automatically and start playback from the first chapter of the first title.

- Some DVDs may not operate properly. If this function is not fully operated, turn this function off and start playback.

1 Display the Video Setup menu.

Refer to *Introduction of menu operations* on page 39.

2 Touch DVD Auto Play to turn automatic playback on.

- To turn automatic playback off, touch **DVD Auto Play** again. 

Menu operations

System settings

Switching the auxiliary setting

Activate this setting when using an auxiliary device connected to this unit.

1 Display the system menu.

Refer to *Introduction of menu operations* on page 39.

2 Touch AUX Input on the system menu to turn AUX Input on or off.

Setting AV input

Activate this setting when using an external video component connected to this unit.

1 Display the system menu.

Refer to *Introduction of menu operations* on page 39.

2 Touch AV Input on the system menu to turn AV Input on or off.

Setting the rear output and subwoofer controller

This unit's rear output (rear speaker leads output and RCA rear output) can be used for full-range speaker (**Full**) or subwoofer (**Subwoofer**) connection. If you switch the rear output setting to **Subwoofer**, you can connect a rear speaker lead directly to a subwoofer without using an auxiliary amp. Initially, the unit is set for a rear full-range speaker connection (**Full**).

1 Turn the unit off.

Refer to *Basic operations of this unit* on page 10.

2 Display the system menu.

Refer to *Introduction of menu operations* on page 39.

3 Touch Rear Speaker on the system menu to switch the subwoofer output or full-range speaker.

- When no subwoofer is connected to the rear output, select **Full** (full-range speaker).
- When a subwoofer is connected to the rear output, select **Subwoofer** (subwoofer).

Notes

- Even if you change this setting, there will be no output unless you turn the subwoofer output on (refer to *Using subwoofer output* on page 41).
- If you change this setting, subwoofer output in the audio menu will return to the factory settings.
- Both rear speaker lead outputs and RCA rear output are switched simultaneously in this setting.

Setting the FM tuning step

Normally, the FM tuning step employed by seek tuning is 50 kHz. When AF or TA is on, the tuning step automatically changes to 100 kHz. It may be preferable to set the tuning step to 50 kHz when AF is on.

- The tuning step remains at 50 kHz during manual tuning.

1 Turn the unit off.

Refer to *Basic operations of this unit* on page 10.

2 Display the system menu.

Refer to *Introduction of menu operations* on page 39.

3 Touch FM Step on the system menu to select the FM tuning step.

Touching **FM Step** will switch the FM tuning step between 50 kHz and 100 kHz. The selected FM tuning step will appear.

RDS setting

Limiting stations to regional programming

When AF is used, the regional function limits the selection of stations to those broadcasting regional programs.

1 Turn the unit off.

Refer to *Basic operations of this unit* on page 10.

2 Display the system menu.

Refer to *Introduction of menu operations* on page 39.

3 Touch RDS Setup on the system menu.

4 Touch Regional on the menu to turn the regional function on.

- To turn the regional function off, touch **Regional** again.

Selecting alternative frequencies

When the tuner cannot get a good reception, the unit automatically searches for a different station in the same network.

1 Turn the unit off.

Refer to *Basic operations of this unit* on page 10.

2 Display the system menu.

Refer to *Introduction of menu operations* on page 39.

3 Touch RDS Setup on the system menu.

4 Touch Alternative FREQ to turn AF on.

- To turn AF off, touch **Alternative FREQ** again.

Note

Sound may be temporarily interrupted by another program during an AF frequency search.

Switching Auto PI Seek

The unit can automatically search for a different station with the same programming, even during preset recall.

1 Turn the unit off.

Refer to *Basic operations of this unit* on page 10.

2 Display the system menu.

Refer to *Introduction of menu operations* on page 39.

3 Touch Auto PI on the system menu to turn Auto PI Seek on.

- To turn Auto PI Seek off, touch **Auto PI** again.

Switching sound muting/attenuation

Sound from this system is automatically muted or attenuated when a signal from equipment with a mute function is received.

- Sound from this system returns to normal when the muting or attenuation is canceled.

1 Display the system menu.

Refer to *Introduction of menu operations* on page 39.

2 Touch Mute/ATT until the desired setting appears.

Touch **Mute/ATT** until the desired setting appears in the display.

- **Mute** – Muting
- **ATT –20dB** – Attenuation (**ATT –20dB** has a stronger effect than **ATT –10dB**)
- **ATT –10dB** – Attenuation
- **Off** – Turns the sound muting/attenuation off

Notes

- When **Mute** is displayed, the sound is turned off and no audio adjustments can be made.
- When **ATT** is displayed, the sound is attenuated and only the volume can be adjusted. (No other audio adjustments can be made.)
- Operation returns to normal when the phone connection is ended.

Menu operations

Selecting the menu language

The menu language can be selected from four languages.

If text information such as the title name, artist name or a comment is embedded in a European language or Russian, they can also be displayed on this unit.

- The language can be changed for the following:
 - System menu
 - Video Setup menu
 - On-screen display
 - Multi language setting for DivX
- If the embedded language and the selected language setting are not the same, text information may not display properly.
- Some characters may not be displayed properly.
- To complete this operation, switch the ignition key off and on after you set this setting.

1 Display the system menu.

Refer to *Introduction of menu operations* on page 39.

2 Touch System Language on the system menu to select the desired language.

3 Touch the desired language.

English (English)—**Français** (French)—**Español** (Spanish)—**Русский** (Russian)

Clearing Bluetooth memory

(AVH-6300BT only)

Important

Never turn the unit off while the Bluetooth memory is being cleared.

1 Turn the unit off.

Refer to *Basic operations of this unit* on page 10.

2 Display the system menu.

Refer to *Introduction of menu operations* on page 39.

3 Touch Bluetooth Memory Clear on the system menu.

4 Touch Clear.

After selecting a desired item, a confirmation display appears. Touch **OK** to delete the memory.

- If you do not want to clear the memory, touch **Cancel**.

Updating Bluetooth connection software

(AVH-6300BT only)

This function is used to update this unit with the latest software. For information on the software and updating, refer to our website.

Important

Never turn the unit off and never disconnect the phone while the software is being updated.

1 Turn the unit off.

Refer to *Basic operations of this unit* on page 10.

2 Display the system menu.

Refer to *Introduction of menu operations* on page 39.

3 Touch Bluetooth Software Update.

4 Touch Start to display the data transfer mode.

- Follow the on-screen instructions to finish updating the software.

Displaying the Bluetooth system version

(AVH-6300BT only)

If this unit fails to operate properly, you may need to consult your dealer for repair. In such cases, you may be asked to specify the system version. Perform the following procedure to check the version on this unit.

1 Turn the unit off.

Refer to *Basic operations of this unit* on page 10.

Menu operations

2 Display the system menu.

Refer to *Introduction of menu operations* on page 39.

3 Touch Bluetooth Version Information to display to the version of the Bluetooth module of this unit.

Setting the automatic open function

To prevent the display from hitting the shift lever of an automatic vehicle when it is in the **P** (park) position, or when you do not wish the display to open/close automatically, you can set the automatic open function to manual mode.

1 Display the system menu.

Refer to *Introduction of menu operations* on page 39.

2 Touch Auto Flap to select whether to open/close the display automatically or manually.

Each time you touch **Auto Flap** the setting switches between:

- **On** – The LCD panel will open or close automatically when the ignition switch is turned on or off.
- **Off** – You have to press **OPEN/CLOSE** to open/close the LCD panel.

Adjusting the LCD panel slide position

You can adjust the LCD panel slide position so that the panel is set back or forward.

1 Display the system menu.

Refer to *Introduction of menu operations* on page 39.

2 Touch Flap Set Back.

3 Touching the Flap Set Back keys allows you to move the LCD panel back and forth.



The LCD panel slides to the back.



The LCD panel slides to the front.

Adjusting the LCD panel angle



Important

- If you can hear the LCD panel knocking against your vehicle's console or dashboard, touch and hold **OPEN/CLOSE** to temporarily level the LCD panel.
- When adjusting the LCD panel angle, be sure to touch and hold **OPEN/CLOSE**. Forcibly adjusting the LCD panel by hand may damage it.



1 Display the system menu.

Refer to *Introduction of menu operations* on page 39.

2 Touch Display Tilt.

3 Touch the Display Tilt keys to adjust the LCD panel to an easily viewable angle.

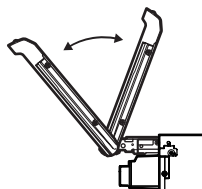

Menu operations



Laying the panel down.

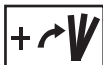

Returning the panel to the upright position.

- As the set angle is saved, the LCD panel will automatically be adjusted to the same position the next time the LCD panel is opened.

Switching the warning tone

If the front panel is not detached from the head unit within four seconds of turning off the ignition, a warning tone sounds. You can turn off the warning tone.

1 Display the system menu.

Refer to *Introduction of menu operations* on page 39.

2 Touch DT.WARNING to turn the warning tone on.

- To turn the warning tone off, touch **DT.WARNING** again.

Setting the rear view camera (back up camera)

⚠ CAUTION

Pioneer recommends the use of a camera which outputs mirror-reversed images. Otherwise, the screen image will appear reversed.

This unit features a function that automatically switches to the rear view camera video (**REAR VIEW CAMERA IN**) when a rear view camera is installed on your car and the gear shift is moved to the **REVERSE (R)** position. (For more details, consult your dealer.)

- After you set up the rear view camera setting, move the gear shift to **REVERSE (R)** and confirm that the rear view camera video is shown on the display.
- Change this setting if the display switches to the rear view camera video by error while you are driving forward.

- To stop watching the rear view camera video and return to the source display, press and hold **MUTE/⏸**.
- Touch the **RearView** source icon to display the rear view camera image while driving. Touch the source icon again to turn the rear view camera off. For details, refer to *Selecting a source using the touch panel keys* on page 10.

1 Display the system menu.

Refer to *Introduction of menu operations* on page 39.

2 Touch Camera Polarity on the system menu to select the appropriate setting.

- Battery** – When the polarity of the connected lead is positive while the gear shift is in **REVERSE (R)** position
- Ground** – When the polarity of the connected lead is negative while the gear shift is in **REVERSE (R)** position
- Off** – When a rear view camera is not connected to this unit

Selecting the video format

You can switch the video output format of **REAR MONITOR OUTPUT** between NTSC and PAL.

1 Display the system menu.

Refer to *Introduction of menu operations* on page 39.

2 Touch Video Output Format on the system menu to select the video output format. NTSC—PAL

Note

You can switch the video output format only for the source from this unit.

Auto EQ (auto-equalizing)

The auto-equalizer automatically measures the car's interior acoustic characteristics, and then creates an auto-equalizer curve based on that information.

WARNING

As a loud tone (noise) may be emitted from the speakers when measuring the car's interior acoustic characteristics, never perform auto EQ while driving.

CAUTION

- Thoroughly check the conditions before performing auto EQ as the speakers may be damaged if these functions are performed when:
 - The speakers are incorrectly connected. (For example, when a rear speaker is connected as a subwoofer output.)
 - A speaker is connected to a power amp delivering output higher than the speaker's maximum input power capability.
- If the microphone is placed in an unsuitable position the measurement tone may become loud and measurement may take a long time, resulting in battery drainage. Be sure to place the microphone in the specified location.

Before operating the auto EQ function

- Carry out auto EQ in as quiet a place as possible, with the car engine and air conditioning switched off. Also cut power to car phones or portable telephones in the car, or remove them from the car before carrying out auto EQ. Sounds other than the measurement tone (surrounding sounds, engine sound, telephones ringing etc.) may prevent correct measurement of the car interior acoustic characteristics.
- Be sure to carry out auto EQ using the optional microphone. Using another microphone may prevent measurement, or result in incorrect measurement of the car interior acoustic characteristics.
- In order to perform auto EQ, the front speaker must be connected.

- When this unit is connected to a power amp with input level control, auto EQ may not be possible if the power amp's input level is set below the standard level.
- When this unit is connected to a power amp with an LPF, turn this LPF off before performing auto EQ. Also set the cut-off frequency for the built-in LPF of an active subwoofer to the highest frequency.
- The distance has been calculated by computer to be the optimum delay to give accurate results for the circumstances, so please continue to use this value.
 - The reflected sound within the car is strong and delays occur.
 - The LPF on active subwoofers or external amps delay the lower sounds.
- Auto EQ changes the audio settings as follows:
 - The fader/balance settings return to the center position. (Refer to *Using fader/balance adjustment* on page 40.)
 - The equalizer curve switches to **Flat**. (Refer to *Recalling equalizer curves* on page 40.)
 - The front, center and rear speakers will automatically be adjusted to a high pass filter setting.
- Previous settings for auto EQ will be overwritten.

Performing auto EQ

1 Stop the car in a place that is quiet, close all the doors, windows and sun roof, and then turn the engine off.

If the engine is left running, engine noise may prevent correct auto EQ.

2 Fix the optional microphone in the center of the headrest of the driver's seat, facing forward.

The auto EQ may differ depending on where you place the microphone. If desired, place the microphone on the front passenger seat to carry out auto EQ.

Menu operations

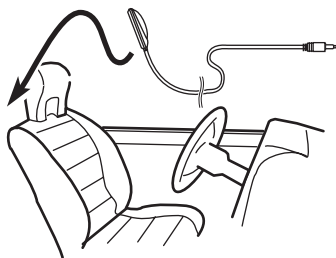

3 Turn the ignition switch to ON or ACC.

If the car's air conditioner or heater is turned on, turn it off. Noise from the fan in the air conditioner or heater may prevent correct auto EQ.

4 Display the system menu.

Refer to *Introduction of menu operations* on page 39.

5 Touch Auto EQ Measurement to enter auto EQ measurement mode.

6 Plug the microphone into the microphone input jack on this unit.

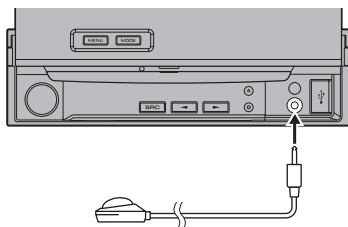

7 Touch Start to start auto EQ.

8 When the 10-second countdown starts, get out of the car and close the door within 10 seconds.

A measurement tone (noise) is emitted from the speakers, and auto EQ measurement begins.

When auto EQ is completed, **Complete** is displayed.

When the car's interior acoustic characteristics cannot be measured correctly, an error message will be displayed. (Refer to *Understanding auto EQ error messages* on page 63.)

- It takes about nine minutes for auto EQ measurement to be completed when all the speakers are connected.
- To stop auto EQ, touch **Stop**.
- To cancel auto EQ measurement mode during this procedure, touch the following touch panel key.



Canceling auto EQ measurement mode.

9 Store the microphone carefully in the glove compartment or another safe place.

If the microphone is subjected to direct sunlight for an extended period, high temperatures may cause distortion, color change or malfunction. ▣

Entertainment settings

Selecting the illumination color

This unit is equipped with multiple-color illumination.

Direct selection from preset illumination colors

You can select an illumination color from the color list.

1 Display the entertainment menu.

Refer to *Introduction of menu operations* on page 39.

2 Touch Appearance.

3 Touch Illumination and then touch a color on the list.

Customizing the illumination color

1 Display the entertainment menu.

Refer to *Introduction of menu operations* on page 39.

2 Touch Appearance.

3 Touch Illumination and then touch Custom.

4 Display the customizing menu.



Displaying the customizing menu.

5 Touch the color bar to customize the color.

6 Touch ◀ or ▶ to fine-tune the color.

7 Touch the icon and hold to store the customized color in the memory.



Storing the customized color in the memory.

The customized color has been stored in the memory.

The set color will be recalled from the memory the next time you touch the same icon.

Selecting the OSD color

The OSD color can be changed.

1 Display the entertainment menu.

Refer to *Introduction of menu operations* on page 39.

2 Touch Appearance.

3 Touch Screen.

4 Touch one of the colors on the list.

Selecting the background display

You can switch the background that is displayed when listening to a source.

1 Display the entertainment menu.

Refer to *Introduction of menu operations* on page 39.

2 Touch Background.

3 Touch the desired setting.

- If no JPEG images are stored in this unit, you cannot select photo. To store a JPEG image to this unit, refer to *Capture an image in JPEG files* on page 32. 

Menu operations

Customizing menus

1 Display menu columns to register.

Refer to *Introduction of menu operations* on page 39.

You can customize menus except

Video Setup menu.

2 Touch and hold the menu column to register it.

- To cancel registration, touch and hold the menu column again.

3 Display the custom menu and choose a registered menu.

Refer to *Introduction of menu operations* on page 39.

Note

You can register up to 12 columns.

Changing the picture adjustment

You can adjust the **Brightness** (brightness), **Contrast** (contrast), **Color** (color), **Hue** (hue), **Dimmer** (dimmer), **Temperature** (temperature), **Black Level** (black level) and **RGB Dot Adjustment** (RGB dot clock adjustment) for each source and rear view camera.

- You cannot adjust **Color**, **Hue**, **Black Level** and **RGB Dot Adjustment** for the audio source.

1 Press and hold MENU to display Picture Adjustment.

The adjustment function names are displayed.

2 If you are adjusting the Picture Adjustment, select the unit.

NAVI

Adjusting the **Picture Adjustment** for the Navigation system.

Rear View

Adjusting the **Picture Adjustment** for the rear view camera.

Source

Adjusting the **Picture Adjustment** for the source.

3 Touch any of the following touch panel keys to select the function to be adjusted. **Picture Adjustment** items are displayed.

- Brightness** – Adjusts the black intensity
- Contrast** – Adjusts the contrast
- Color** – Adjusts the color saturation
- Hue** – Adjusts the tone of color (red or green is emphasized)
- Dimmer** – Adjusts the brightness of the display
- Temperature** – Adjusts the color temperature, resulting in a better white balance
- Black Level** – Emphasizes the dark portions of images making the difference between bright and dark more distinct

- RGB Dot Adjustment** – Adjusts phase shifting by dot clock when a Navigation system is connected
 - You cannot adjust the picture adjustment for the rear view camera when **Camera Polarity** is set to **Off**. (Refer to *Setting the rear view camera (back up camera)* on page 51.)
 - You can adjust **Hue** only when the color system is set to NTSC.
 - With some rear view cameras, picture adjustment may not be possible.

4 Touch ◀ or ▶ to adjust the selected item.

Each time you touch ◀ or ▶, the level of the selected item increases or decreases.

- Dimmer** can be adjusted from **+1** to **+48**.
- Temperature** can be adjusted from **+3** to **-3**.

5 Touch Black Level and RGB Dot Adjustment to adjust.

- Black Level** can be set on or off.
- RGB Dot Adjustment** can be set to **1** or **2**.

Notes

- You cannot operate this function while driving.
- Different **Brightness/Contrast/Dimmer** settings can be set for when the illumination switch is on and when it is off.

Setting rear monitor output

The output source for the rear monitor can be switched to the following:

- Front** – The source on the front screen of this unit
- Disc** – The video and sound from the DVD
- AV** – The video and sound from AV input
- AUX** – The source for AUX input
- Off** – No source

Notes

- You cannot play DivX files on the rear and front monitors at the same time.
- If **Disc** is set to rear monitor output, you cannot select MW/LW band for the front monitor.

Other Functions

Adjusting the response positions of the touch panels (Touch Panel Calibration)

If you feel that the touch panel keys on the screen deviate from the actual positions that respond to your touch, adjust the response positions of the touch panel. There are two adjustment methods: 4-point adjustment, in which you touch four corners of the screen; and 16-point adjustment, in which you make fine-adjustments on the entire screen.

- Touch the screen gently for adjustment. Forcefully pressing the touch panel may damage the touch panel. Do not use a sharp pointed tool such as a ballpoint pen or mechanical pen. Doing so may damage the screen.
- If the touch panel cannot be adjusted properly, consult your local Pioneer dealer.

1 Turn the unit off.

Refer to *Basic operations of this unit* on page 10.

2 Press and hold MENU to display Picture Adjustment.

3 Press and hold MENU to start Touch Panel Calibration.

The 4-point touch panel adjustment screen appears.

4 Touch each of the arrows on the four corners of the screen.

- To cancel the adjustment, press and hold MENU.

5 Press MENU to complete 4-point adjustment.

Data for the adjusted position is saved.

- Do not turn off the engine while the data is being saved.

6 Press MENU to proceed to 16-point adjustment.

The 16-point touch panel adjustment screen appears.

- To cancel the adjustment, press and hold MENU.

7 Gently touch the center of the + mark displayed on the screen.

After you touch all the marks, the data for the adjusted position is saved.

- Do not turn off the engine while the data is being saved.

8 Press and hold MENU to complete the adjustment.

Using an AUX source

A separately sold auxiliary device such as a VCR or portable device can be connected to this unit. When connected, the auxiliary device is automatically recognized as an AUX source and is assigned to **AUX**.

About AUX connection methods

You can connect auxiliary devices to this unit.

Mini pin plug cable (AUX)

When connecting an auxiliary device using a mini plug cable

iPods and portable audio/video players can be connected to this unit via mini plug cable.

- If an iPod with video capabilities is connected to this unit via 3.5 mm plug (4 pole) cable (such as the CD-V150M), you can enjoy the video contents of the connected iPod.
- A portable audio/video player can be connected by using a 3.5 mm plug (4 pole) with an RCA cable (sold separately). However, depending on the cable, a reverse connection between the red (right side audio) cable and yellow (video) cable may be required in order for the sound and video image to be reproduced correctly.

● Insert the stereo mini plug into the AUX input jack on this unit.

Refer to the installation manual.

Refer to *What's what* on page 9. 

Additional Information

Troubleshooting

Common

Symptom	Cause	Action (Reference page)
The power will not turn on. The unit will not operate.	Leads and connectors are incorrectly connected.	Confirm once more that all connections are correct.
	The fuse is blown.	Rectify the cause and then replace the fuse. Be sure to install a fuse with the same rating.
	Noise and/or other factors are causing the built-in microprocessor to operate incorrectly.	Press RESET . (Page 9)
Operation with the remote control is not possible. The unit does not operate correctly even when the appropriate remote control buttons are pressed.	Battery power is low.	Load a new battery.
	Some operations are prohibited with certain discs.	Try operating with another disc.
Playback is not possible.	The disc is dirty.	Clean the disc.
	The type of disc loaded cannot be played on this unit.	Check the disc type.
	The disc loaded is not compatible with this video system.	Change the disc to one that is compatible with your video system.
There is no sound. The volume level will not rise.	Cables are not connected correctly.	Connect the cables correctly.
	The unit is performing still, slow motion or frame-by-frame playback.	There is no sound during still, slow motion or frame-by-frame playback.

Symptom	Cause	Action (Reference page)
There is no image displayed.	The parking brake cable is not connected.	Connect the parking brake cable, and apply the parking brake.
	The parking brake is not applied.	Connect the parking brake cable, and apply the parking brake.
The  icon is displayed, and operation is not possible.	The operation is prohibited for the disc.	This operation is not possible.
	The operation is not compatible with the configuration of the disc.	This operation is not possible.
The image displayed stops (pauses) and the unit cannot be operated.	The data could no longer be read during playback.	Stop playback once, and start playback again.
There is no sound. The volume level is low.	The volume level is low.	Adjust the volume level.
	The attenuator is on.	Turn the attenuator off.
The sound and video skip.	The unit is not firmly secured.	Firmly secure the unit.
	File size and transmission rate are above recommended rates.	Create a DivX file that is within the recommended size and transmission rate.
The aspect ratio is incorrect and the image is stretched.	The aspect ratio setting is incorrect for the display.	Select the appropriate setting for your display. (Page 44)
The motor sounds when the ignition switch is turned ON (or is turned to ACC).	The unit is confirming whether or not a disc is loaded.	This is a normal operation.

Additional Information

Symptom	Cause	Action (Reference page)
Nothing is displayed. The touch panel keys cannot be used.	The rear view camera is not connected. Camera Polarity is at incorrect setting.	Connect a rear view camera. Press and hold MENU to return to the source display and then select the correct setting for Camera Polarity . (Page 51)
No xxxx appears when a display is changed (No Title , for example).	There is no embedded text information.	Switch the display or play another track/file.
Sub-folders cannot be played back.	Folder repeat play has been selected.	Select the repeat range again.
The repeat range changes automatically.	Another folder was selected during repeat play. Track search or fast forward/reverse was performed during file repeat play.	Select the repeat range again. Select the repeat range again.

DVD

Symptom	Cause	Action (Reference page)
Playback is not possible.	The loaded disc has a different region number from this unit.	Replace the disc with one featuring the same region number as this unit.
A parental lock message is displayed and playback is not possible.	Parental lock is activated.	Turn parental lock off or change the level. (Page 44)
Parental lock cannot be canceled.	The code number is incorrect. You have forgotten your code number.	Enter the correct code number. (Page 44) Press RESET . (Page 45)

Symptom	Cause	Action (Reference page)
Dialog language (and subtitle language) cannot be switched.	The DVD being played does not feature multiple language recordings. You can only switch between items indicated in the disc menu.	The language cannot be switched if they are not recorded on the disc. Switch the language using the disc menu.
No subtitles are displayed.	The DVD being played does not feature subtitles. You can only switch between items indicated in the disc menu.	Subtitles are not displayed if they are not recorded on the disc. Switch the language using the disc menu.
Playback is not performed with the audio language and subtitle language settings selected in Video Setup menu.	The DVD being played does not feature dialog or subtitles in the selected language.	The language cannot be switched if the selected language is not recorded on the disc.
The viewing angle cannot be switched.	The DVD being played does not feature scenes shot from multiple angles. You are trying to switch to multi-angle viewing for a scene that was not recorded from multiple angles.	The viewing angle cannot be switched if the DVD does not feature scenes recorded from multiple angles. Switch between multiple angles when watching scenes recorded from multiple angles.

Additional Information

Symptom	Cause	Action (Reference page)
The image is extremely unclear/distorted and dark during playback.	Some discs feature a signal to prohibit copying.	Since this unit is compatible with the analog copy generation management system, when playing a disc that has a signal prohibiting copying, horizontal stripes or other imperfections may appear when viewed on some displays. This is not a malfunction.

Video CD

Symptom	Cause	Action
The PBC (playback control) menu cannot be called up.	The Video CD being played does not feature PBC.	This operation is not available for Video CDs that do not feature PBC.
Repeat play and track/time search are not possible.	The Video CD being played features PBC.	This operation is not available for Video CDs that feature PBC.

iPod

Symptom	Cause	Action
The iPod does not operate correctly.	The cables are incorrectly connected.	Disconnect the cable from the iPod. Once the iPod's main menu is displayed, reconnect the iPod and reset it.
	The iPod version is old.	Update the iPod version.



Error messages

When you contact your dealer or your nearest Pioneer Service Center, be sure to note the error message.

Tuner

Message	Cause	Action
No Data	This unit cannot receive program service name information.	Move to the desirable location with good reception.

DVD

Message	Cause	Action
Different Region Disc	The disc does not have the same region number as this unit.	Replace the DVD with one bearing the correct region number.
Error-02-XX/FF-FF	The disc is dirty.	Clean the disc.
	The disc is scratched.	Replace the disc.
	The disc is loaded upside down.	Check that the disc is loaded correctly.
	There is an electrical or mechanical error.	Press RESET .
Unplayable Disc	This type of disc cannot be played on this unit.	Replace the disc with one that can be played on this unit.
	The inserted disc does not contain any playable files.	Replace the disc.

Protect	All the files on the inserted disc are embedded with DRM.	Replace the disc.
Skipped	The inserted disc contains DRM protected files.	Play an audio file not embedded with Windows Media DRM 9/10.
TEMP	The temperature of the unit is outside the normal operating range.	Wait until the unit returns to a temperature within the normal operating limits.
Rental Expired.	The inserted disc contains expired DivX VOD content.	Select a file that can be played.

Additional Information

Message	Cause	Action
Video resolution not supported	The inserted disc contains a high definition DivX file.	Select a file that can be played.
It is not possible to write it in the flash.	Flash memory error.	Replace the flash memory.
Your device is not authorized to play this DivX protected video.	This unit's DivX registration code has not been authorized by the DivX VOD contents provider.	Register this unit to the DivX VOD contents provider.
Unplayable File	This type of file cannot be played on this unit.	Select a file that can be played.
Format Read	Sometimes there is a delay between the start of playback and when you start to hear any sound.	Wait until the message disappears and you hear sound.
Video frame rate not supported.	DivX file's frame rate is more than 30 fps.	Select a file that can be played.
Audio format not supported.	This type of file is not supported on this unit.	Select a file that can be played.

External storage device (USB, SD)

Message	Cause	Action
Unplayable File	This type of file cannot be played on this unit.	Select a file that can be played.
	There are no songs.	Transfer the audio files to the external storage device and connect.
	Security for the connected USB memory is enabled.	Follow the USB memory instructions to disable security.
Format Read	Sometimes there is a delay between the start of playback and when you start to hear any sound.	Wait until the message disappears and you hear sound.

Message	Cause	Action
Skipped	The connected external storage device contains WMA files that are protected by Windows Media™ DRM 9/10.	Play an audio file not embedded with Windows Media DRM 9/10.
Protect	All the files on the connected external storage device is protected by Windows Media DRM 9/10.	Transfer audio files not protected by Windows Media DRM 9/10 to the external storage device and connect.
Incompatible USB	The USB device connected to is not supported by this unit.	Connect a USB portable audio player or USB memory that is USB Mass Storage Class compliant.
	The USB device is not formatted with FAT16 or FAT32.	The connected USB device should be formatted with FAT16 or FAT32.
Incompatible SD	Unsupported SD card is inserted.	Use the supported SD card.
	Non-compatible SD storage device	Remove your device and replace it with a compatible SD storage device.
Check USB	The USB connector or USB cable has short-circuited.	Check that the USB connector or USB cable is not caught in something or damaged.
	The connected USB portable audio player/USB memory consumes more than maximum allowable current.	Disconnect the USB portable audio player/USB memory and do not use it. Turn the ignition switch to OFF, then to ACC or ON and then connect a compliant USB portable audio player/USB memory.

Additional Information

Message	Cause	Action
Error-02-9X/-DX	Communication failed.	Perform one of the following operations. –Turn the ignition switch OFF and back ON. –Disconnect the USB portable audio player/USB memory. –Change to a different source. Then, return to the USB portable audio player/USB memory.
Rental Expired.	The inserted external storage device contains expired DivX VOD content.	Select a file that can be played.
Video resolution not supported	The inserted external storage device contains a high definition DivX file.	Select a file that can be played.
It is not possible to write it in the flash.	Flash memory error.	Replace the flash memory.
Your device is not authorized to play this DivX protected video.	This unit's DivX registration code has not been authorized by the DivX VOD contents provider.	Register this unit to the DivX VOD contents provider.
Format Read	Sometimes there is a delay between the start of playback and when you start to hear any sound.	Wait until the message disappears and you hear sound.
Video frame rate not supported.	DivX file's frame rate is more than 30 fps.	Select a file that can be played.
Audio format not supported.	This type of file is not supported on this unit.	Select a file that can be played.

iPod

Message	Cause	Action
Format Read/Ready	Sometimes there is a delay between the start of playback and when you start to hear any sound.	Wait until the message disappears and you hear sound.
Error-02-6X/-9X/-DX	Communication failed.	Disconnect the cable from the iPod. Once the iPod's main menu is displayed, reconnect the iPod and reset it.
	iPod failure.	Disconnect the cable from the iPod. Once the iPod's main menu is displayed, reconnect the iPod and reset it.
Error-02-67	The iPod firmware version is old.	Update the iPod version.
Stop	There are no songs. There are no songs in the current list.	Transfer songs to the iPod. Select a list that contains songs.
Not Found	No related songs.	Transfer songs to the iPod.

Bluetooth

Message	Cause	Action
Error-10	The power failed for the Bluetooth module of this unit.	Turn the ignition switch OFF and then to ACC or ON. If the error message is still displayed after performing the above action, please contact your dealer or an authorized Pioneer Service Station.



Additional Information

Understanding auto EQ error messages

When correct measurement of the car's interior acoustic characteristics is not possible using auto EQ, an error message may appear on the display. In such cases, refer to the table below to see what the problem is and how it may be corrected. After checking, try again.

Message	Cause	Action
Error. Please check MIC.	The microphone is not connected.	Plug the optional microphone securely into the jack.
Error. Please check xxxx speaker.	The microphone cannot pick up the measuring tone of a speaker.	<ul style="list-style-type: none"> • Confirm that the speakers are connected correctly. • Correct the input level setting of the power amp connected to the speakers. • Plug the microphone securely into the jack.
Error. Please check noise.	The surrounding noise level is too high.	<ul style="list-style-type: none"> • Stop your car in a place that is quiet, and switch off the engine, air conditioner and heater. • Set the microphone correctly.
Error. Please check battery.	Power is not being supplied from the battery to this unit.	<ul style="list-style-type: none"> • Connect the battery correctly. • Check the battery voltage.



Understanding messages











Messages	Translation
Screen image may appear reversed.	Pioneer recommends the use of a camera which outputs mirror-reversed images. Otherwise, the screen image will appear reversed.

Additional Information

Indicator list



Area 1

	Indicates that the selected frequency is being broadcast in stereo.
	Indicates that a radio text has been received.
	Indicates that TA (traffic announcement standby) is on.
	Indicates that the news program interruption is on.
	Indicates that a Bluetooth telephone is connected.
	Indicates that the digital format is Dolby Digital.
	Indicates that the digital format is MPEG Audio.
	Indicates that the digital format is Linear PCM.
	Indicates the sampling frequency.
	Indicates that the digital format is DTS.

1 ch
2 ch
Mch

Indicates the audio channel.



Indicates that a disc with PBC On is being played.



Indicates that a cellular phone is connected.

- Indicates that an incoming call has been received and has not been checked yet.
- Not displayed for calls made when your cellular phone is disconnected from this unit.



- Indicates the battery strength of the cellular phone.
- The level shown on the indicator may differ from the actual battery strength.
- If the battery strength is not available, nothing is displayed in the battery strength indicator area.



Indicates the signal strength of the cellular phone.



Indicates that Auto EQ is on.



Shows which audio language has been selected.



Shows which subtitle language has been selected.



Shows which viewing angle has been selected.



Shows which audio output has been selected.

Additional Information

Area 2



Shows the disc/album currently being played.



Shows the track/song currently being played.



Shows the comment currently being played.



Shows the artist name for the track/song currently being played.



Shows cellular phone information.



Shows general phone information.



Shows home phone information.



Shows office phone information.



Shows other phone information.



Shows the name of the folder currently being played.



Shows the name of the file currently being played.



Shows the preset number of the station currently being tuned in to.



Shows the channel currently being tuned in to.

Area 3



Shows the title number currently being played.



Shows the chapter number currently being played.



Shows the genre of the track/song currently being played.

DEMO

Indicates that the feature demo is on.

Additional Information

Handling guidelines

Discs and player

Use only discs featuring any of following logos.



Use 12-cm discs. Do not use 8-cm discs or an adapter for 8-cm discs.

Use only conventional, fully circular discs. Do not use shaped discs.



Do not insert anything other than a DVD (-R/-RW) or CD (-R/-RW) into the disc loading slot.

Do not use cracked, chipped, warped, or otherwise damaged discs as they may damage the player.

Unfinalized CD-R/CD-RW discs cannot be played back.

Do not touch the recorded surface of the discs.

Store discs in their cases when not in use.

Do not attach labels, write on or apply chemicals to the surface of the discs.

To clean a disc, wipe the disc with a soft cloth outward from the center.

Condensation may temporarily impair the player's performance. Let it rest for about one hour to adjust to a warmer temperature. Also, wipe any damp discs off with a soft cloth.

Playback of discs may not be possible because of disc characteristics, disc format, recorded application, playback environment, storage conditions, and so on.

Road shocks may interrupt disc playback.

Read the precautions for discs before using them.

Certain functions may not be available for some DVD video discs.

It may not be possible to play back some DVD video discs.

It is not possible to play back DVD-RAM discs.

This unit is not compatible with discs recorded in AVCHD (Advanced Video Codec High Definition) format. Do not insert AVCHD discs as you may not be able to eject the disc.

External storage device (USB, SD)

Depending on the external storage device (USB, SD), the following problems may occur.

- Operations may vary.
- The storage device may not be recognized.
- Files may not be played back properly.

USB storage device

Connections via USB hub are not supported.

Do not connect anything other than a USB storage device.

Firmly secure the USB storage device when driving. Do not let the USB storage device fall onto the floor, where it may become jammed under the brake or accelerator pedal.

Depending on the USB storage device, the device may cause noise to occur in the radio.

Copyright protected files that are stored in the USB devices cannot be played back.

You cannot connect a USB portable audio player/USB memory to this unit via USB hub.

Partitioned USB memory is not compatible with this unit.

Depending on the kind of USB portable audio player/USB memory you use, the device may not be recognized or audio files may not be played back properly.

Do not leave the USB portable audio player/USB memory in direct sunlight for extended amounts of time. Doing so may cause the device to malfunction from the extreme rise in temperature.

Additional Information

SD memory card

This unit supports only the following types of SD memory cards.

- SD
- SDHC

Keep the SD memory card out of the reach of children. Should the SD memory card be swallowed, consult a doctor immediately.

Do not touch the connectors of the SD memory card directly with your fingers or with any metal device.

Do not insert anything other than an SD memory card into the SD card slot. If a metal object (such as a coin) is inserted into the slot, the internal circuits may break and cause malfunctions.

Do not insert a damaged SD memory card (e.g. warped, label peeled off) as it may not be ejected from the slot.

Do not try to force an SD memory card into the SD card slot as the card or this unit may be damaged.

When ejecting an SD memory card, press it and hold it until it clicks. It is dangerous for you to release your finger immediately after you press on the card as the card may shoot out of the slot and hit you in the face, etc. If the card shoots out of the slot, it may become lost.

iPod

To ensure proper operation, connect the dock connector cable from the iPod directly to this unit.

Firmly secure the iPod when driving. Do not let the iPod fall onto the floor, where it may become jammed under the brake or accelerator pedal.

About iPod settings

- When an iPod is connected, this unit changes the EQ (equalizer) setting of the iPod to off in order to optimize the acoustics. When you disconnect the iPod, the EQ returns to the original setting.
- You cannot set Repeat to off on the iPod when using this unit. Repeat is automatically changed to All when the iPod is connected to this unit.

Incompatible text saved on the iPod will not be displayed by the unit.

DVD-R/DVD-RW discs

Unfinalized DVD-R/DVD-RW discs which have been recorded in the Video format (video mode) cannot be played back.

Playback of DVD-R/DVD-RW discs may not be possible, due to disc characteristics, scratches or dirt on the disc, or dirt, condensation, etc. on the lens of this unit.

Depending on the application settings and the environment, playback of discs recorded on a personal computer may not be possible. (For details, contact the manufacturer of the application.)

CD-R/CD-RW discs

When CD-R/CD-RW discs are used, playback is possible only for discs which have been finalized.

Playback of CD-R/CD-RW discs recorded on a music CD recorder or a personal computer may not be possible due to disc characteristics, scratches or dirt on the disc, or dirt, condensation, etc., on the lens of this unit.

Depending on the application settings and the environment, playback of discs recorded on a personal computer may not be possible. (For details, contact the manufacturer of the application.)

Playback of CD-R/CD-RW discs may become impossible in case of direct exposure to sunlight, high temperatures, or the storage conditions in the vehicle.

Titles and other text information recorded on a CD-R/CD-RW disc may not be displayed by this unit (in the case of audio data (CD-DA)).

DualDiscs

DualDiscs are two-sided discs that have a recordable CD for audio on one side and a recordable DVD for video on the other.

Playback of the DVD side is possible with this unit. However, since the CD side of DualDiscs is not physically compatible with the general CD standard, it may not be possible to play the CD side with this unit. Frequent loading and ejecting of a DualDisc may result in scratches on the disc. Serious scratches can lead to playback problems on this unit. In some cases, a DualDisc may become stuck in the disc loading slot and will not eject. To prevent this, we recommend you refrain from using DualDisc with this unit. Please refer to the information from the disc manufacturer for more detailed information about DualDiscs.

Additional Information

JPEG picture files

JPEG is short for Joint Photographic Experts Group and refers to a still image compression technology standard.

Files are compatible with Baseline JPEG and EXIF 2.1 still images up to a resolution of 8 192 × 7 680. (EXIF format is used most commonly with digital still cameras.)

Playback of EXIF format files that were processed by a personal computer may not be possible.

There is no progressive JPEG compatibility.

DivX video files

Depending on the composition of the file information, such as the number of audio streams or file size, there may be a slight delay when playing back discs.

Some special operations may be prohibited due to the composition of the DivX files.

Only DivX files downloaded from a DivX partner site are guarantee for proper operation. Unauthorized DivX files may not operate properly.

DRM rental files cannot be operated until playback is started.

Recommended file size: 2 Mbps or less with a transmission rate of 2 GB or less.

The ID code of this unit must be registered to a DivX VOD provider in order to playback DivX VOD files. For information on ID codes, refer to *Displaying the DivX® VOD registration code* on page 46.

For more details about DivX, visit the following site: <http://www.divx.com/>

Important

- When naming a JPEG image file, add the corresponding filename extension (.jpg, .jpeg, .jpe or .jfif).
- This unit plays back files with these filename extensions (.jpg, .jpeg, .jpe or .jfif) as a JPEG image file. To prevent malfunctions, do not use these extensions for files other than JPEG image files. 

Compressed audio compatibility (disc, USB, SD)

WMA

File extension: .wma

Bit rate: 5 kbps to 320 kbps (CBR), VBR

Sampling frequency: 8 kHz to 48 kHz

Windows Media Audio Professional, Lossless, Voice/DRM Stream/Stream with video: Not compatible

MP3

File extension: .mp3

Bit rate: 8 kbps to 320 kbps

Sampling frequency: 8 kHz to 48 kHz (32 kHz, 44.1 kHz, 48 kHz for emphasis)

Compatible ID3 tag version: 1.0, 1.1, 2.2, 2.3 (ID3 tag Version 2.x is given priority over Version 1.x.)

M3u playlist: Not compatible

MP3i (MP3 interactive), mp3 PRO: Not compatible

AAC

Compatible format: AAC encoded by iTunes

File extension: .m4a

Sampling frequency: 8 kHz to 44.1 kHz

Bit rate: 8 kbps to 320 kbps

Apple Lossless: Not compatible

AAC file bought from the iTunes Store (.m4p file extension): Not compatible

DivX compatibility

Compatible format: DivX video format implemented in relation to DivX standards

File extensions: .avi or .divx

DivX Ultra format: Not compatible

DivX HD format: Not compatible

DivX files without video data: Not compatible

DivX plus HD format: Not compatible

Compatible audio codec: MP2, MP3, Dolby Digital

Additional Information

LPCM: Not compatible

Bit rate: 8 kbps to 320 kbps (CBR), VBR

Sampling frequency: 8 kHz to 48 kHz

Compatible external subtitle file extension: .srt

Supplemental information

Some characters in a file name (including the file extension) or a folder name may not be displayed.

This unit may not operate correctly depending on the application used to encode WMA files.

There may be a slight delay at the start of playback of audio files embedded with image data or audio files stored on an external storage device (USB/SD) that has numerous folder hierarchies.

Russian text to be displayed on this unit should be encoded in one of the following character sets:

- Unicode (UTF-8, UTF-16)
- A character set other than Unicode that is used in a Windows environment and is set to Russian in the multi-language setting

Disc

Playable folders: up to 700

Playable files: up to 999 for CD-R/CD-RW

Playable files: up to 3500 for DVD-R/DVD-RW

File system: ISO 9660 Level 1 and 2, Romeo, Joliet, UDF 1.02 (DVD-R/DVD-RW)

Multi-session playback: Compatible

Packet write data transfer: Not compatible

Regardless of the length of blank sections between the songs from the original recording, compressed audio discs play with a short pause between songs.

External storage device (USB, SD)

Playable folders: up to 6 000

Playable files: up to 65 535, up to 255 for one folder

Playback of copyright-protected files: Not compatible

Partitioned external storage device (USB, SD): Only the first playable partition can be played.

There is no compatibility for Multi Media Cards (MMC).

Compatibility with all SD memory cards is not guaranteed.

This unit is not compatible with SD-Audio/SD-Video.

CAUTION

- Pioneer accepts no responsibility for data loss on the USB memory/USB portable audio player/SD memory card even if that data is lost while using this unit.
- Do not leave the discs/external storage device (USB, SD) or iPod in places with high temperatures. 

iPod compatibility

This unit supports only the following iPod models. Supported iPod software versions are shown below. Older versions may not be supported.

- iPhone 4 (software version 4.1)
- iPhone 3GS (software version 4.1)
- iPhone 3G (software version 4.1)
- iPhone (software version 3.1.3)
- iPod nano 6th generation (software version 1.0)
- iPod nano 5th generation (software version 1.0.2)
- iPod nano 4th generation (software version 1.0.4)
- iPod nano 3rd generation (software version 1.1.3)
- iPod nano 2nd generation (software version 1.1.3)
- iPod nano 1st generation (software version 1.3.1)
- iPod touch 4th generation (software version 4.1)
- iPod touch 3rd generation (software version 4.0)
- iPod touch 2nd generation (software version 4.0)
- iPod touch 1st generation (software version 3.1.3)
- iPod classic 160GB (software version 2.0.4)
- iPod classic 120GB (software version 2.0.1)
- iPod classic (software version 1.1.2)
- iPod 5th generation (software version 1.3)

Depending on the generation or version of the iPod, some functions may not be available.

Operations may vary depending on the software version of iPod.

When using an iPod, an iPod Dock Connector to USB Cable is required.

When you use Pioneer CD-IU50V/CD-IU200V interface cable, consult your dealer for details.

About the file/format compatibility, refer to the iPod manuals.

Audio Book, Podcast: Compatible

Additional Information

⚠ CAUTION

Pioneer accepts no responsibility for data lost on the iPod, even if that data is lost while this unit is used.

Sequence of audio files

The user cannot assign folder numbers and specify playback sequences with this unit.

Example of a hierarchy

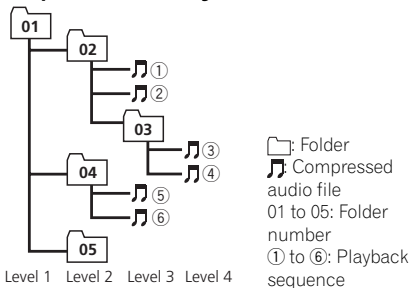

Disc

Folder selection sequence or other operation may differ depending on the encoding or writing software.

External storage device (USB, SD)

The playback sequence is the same as the recorded sequence in the external storage device (USB, SD).

To specify the playback sequence, the following method is recommended.

- ① Create a file name that includes numbers that specify the playback sequence (e.g., 001xxx.mp3 and 099yyy.mp3).
- ② Put those files into a folder.
- ③ Save the folder that contains the files to the external storage device (USB, SD).

However, depending on the system environment, you may not be able to specify the playback sequence.

For USB portable audio players, the sequence is different and depends on the player.

Using the display correctly

⚠ CAUTION

- If liquid or foreign matter should get inside this unit, turn off the power immediately and consult your dealer or the nearest authorized PIONEER Service Station. Do not use the unit in this condition because doing so may result in fire, electric shock, or other failure.
- If you notice smoke, a strange noise or smell, or any other abnormal signs from the display, turn off the power immediately and consult your dealer or the nearest authorized PIONEER Service Station. Using this unit in this condition may result in permanent damage to the system.
- Do not disassemble or modify this unit, as there are high-voltage components inside which may cause electric shock. Be sure to consult your dealer or the nearest authorized PIONEER Service Station for internal inspection, adjustments, or repairs.

Handling the display

- Never touch the screen with anything besides your finger when operating the touch panel function. The screen can scratch easily.
- When the display is subjected to direct sunlight for a long period of time, it will become very hot resulting in possible damage to the LCD screen. You should avoid exposing the display unit to direct sunlight as much as possible.
- The display should be used within the temperature range of -10°C to $+60^{\circ}\text{C}$. At temperatures higher or lower than this operating temperature range, the display may not operate normally.
- The LCD screen is exposed in order to increase its visibility within the vehicle. Do not press it strongly on it as this may damage it.
- Do not push the LCD screen forcefully as this may scratch it.

Additional Information

Liquid crystal display (LCD) screen

- Heat from the heater may damage the LCD screen, and cool air from the cooler may cause moisture to form inside the display resulting in possible damage.
- Small black dots or white dots (bright dots) may appear on the LCD screen. These are due to the characteristics of the LCD screen and do not indicate a malfunction.
- When using a cellular phone, keep the antenna away from the display to prevent disruption of the video image by the appearance of spots, colored stripes, etc.

LED (light-emitting diode) backlight

- At low temperatures, using the LED backlight may increase image lag and degrade the image quality due to the characteristics of the LCD screen. Image quality will improve with an increase in temperature.
- To protect the LED backlight, the display will darken in the following environments:
 - In the direct sunlight
 - Near the heater vent
- The product lifetime of the LED backlight is more than 10 000 hours. However, it may decrease if used in high temperatures.
- If the LED backlight reaches the end of its product lifetime, the screen will become dark and the image will no longer be projected. In such cases, please consult your dealer or the nearest authorized PIONEER Service Station.

Keeping the display in good condition

- When removing dust from the screen or cleaning the display, first turn the system power off, then wipe with a soft dry cloth.
- When wiping the screen, take care not to scratch the surface. Do not use harsh or abrasive chemical cleaners. ▣

Copyright and trademark

This item incorporates copy protection technology that is protected by U.S. patents and other intellectual property rights of Rovi Corporation. Reverse engineering and disassembly are prohibited.

Bluetooth

The Bluetooth® word mark and logos are registered trademarks owned by Bluetooth SIG, Inc. and any use of such marks by Pioneer Corporation is under license. Other trademarks and trade names are those of their respective owners.

- Bluetooth is a short-range wireless radio connectivity technology that is developed as a cable replacement for mobile phones, handheld PCs and other devices. Bluetooth operates in 2.4 GHz frequency range and transmits voice and data at speeds up to 1 megabit per second. Bluetooth was launched by a special interest group (SIG) that comprises of Ericsson Inc., Intel Corp., Nokia Corp., Toshiba and IBM in 1998, and it is currently developed by nearly 2 000 companies worldwide.

DVD video

DVD is a trademark of DVD Format/Logo Licensing Corporation.

iTunes

Apple and iTunes are trademarks of Apple Inc., registered in the U.S. and other countries.

Additional Information

MP3

Supply of this product only conveys a license for private, non-commercial use and does not convey a license nor imply any right to use this product in any commercial (i.e. revenue-generating) real time broadcasting (terrestrial, satellite, cable and/or any other media), broadcasting/streaming via internet, intranets and/or other networks or in other electronic content distribution systems, such as pay-audio or audio-on-demand applications. An independent license for such use is required. For details, please visit <http://www.mp3licensing.com>.

WMA

Windows Media is either a registered trademark or trademark of Microsoft Corporation in the United States and/or other countries. This product includes technology owned by Microsoft Corporation and cannot be used or distributed without a license from Microsoft Licensing, Inc.

SD memory card

SD Logo is a trademark of SD-3C, LLC.
SDHC Logo is a trademark of SD-3C, LLC.

iPod & iPhone

iPhone, iPod, iPod classic, iPod nano, and iPod touch are trademarks of Apple Inc., registered in the U.S. and other countries.

"Made for iPod" and "Made for iPhone" mean that an electronic accessory has been designed to connect specifically to iPod or iPhone, respectively, and has been certified by the developer to meet Apple performance standards.

Apple is not responsible for the operation of this device or its compliance with safety and regulatory standards.

Please note that the use of this accessory with iPod or iPhone may affect wireless performance.

Dolby Digital

Manufactured under license from Dolby Laboratories. "Dolby", "Pro Logic", and the

double-D symbol are trademarks of Dolby Laboratories.

DivX

DivX®, DivX Certified® and associated logos are trademarks of DivX, Inc. and are used under license.

ABOUT DIVX VIDEO: DivX® is a digital video format created by DivX, Inc. This is an official DivX Certified® device that plays DivX video. Visit divx.com for more information and software tools to convert your files into DivX video.

ABOUT DIVX VIDEO-ON-DEMAND: This DivX Certified® device must be registered in order to play purchased DivX Video-on-Demand (VOD) movies. To obtain your registration code, locate the DivX VOD section in *Menu operations*. Go to vod.divx.com for more information on how to complete your registration. 

Additional Information

Language code chart for DVD

Language (code), input code

Japanese (ja), 1001	Dzongkha (dz), 0426	Kurdish (ku), 1121	Kinyarwanda (rw), 1823
English (en), 0514	Ewe (ee), 0505	Komi (kv), 1122	Sanskrit (sa), 1901
French (fr), 0618	Esperanto (eo), 0515	Cornish (kw), 1123	Sardinian (sc), 1903
Spanish (es), 0519	Estonian (et), 0520	Kirghiz, Kyrgyz (ky), 1125	Sindhi (sd), 1904
German (de), 0405	Basque (eu), 0521	Latin (la), 1201	Northern Sami (se), 1905
Italian (it), 0920	Persian (fa), 0601	Luxembourgish (lb), 1202	Sangho (sg), 1907
Chinese (zh), 2608	Fulah (ff), 0606	Ganda (lg), 1207	Sinhala (si), 1909
Dutch, Flemish (nl), 1412	Finnish (fi), 0609	Limburgan (li), 1209	Slovak (sk), 1911
Portuguese (pt), 1620	Fijian (fj), 0610	Lingala (ln), 1214	Slovenian (sl), 1912
Swedish (sv), 1922	Faroese (fo), 0615	Lao (lo), 1215	Samoan (sm), 1913
Russian (ru), 1821	Western Frisian (fy), 0625	Lithuanian (lt), 1220	Shona (sn), 1914
Korean (ko), 1115	Irish (ga), 0701	Luba-Katanga (lu), 1221	Somali (so), 1915
Greek (el), 0512	Gaelic (gd), 0704	Latvian (lv), 1222	Albanian (sq), 1917
Afar (aa), 0101	Galician (gl), 0712	Malagasy (mg), 1307	Serbian (sr), 1918
Abkhazian (ab), 0102	Guarani (gn), 0714	Marshallese (mh), 1308	Swati (ss), 1919
Avestan (ae), 0105	Gujarati (gu), 0721	Maori (mi), 1309	Sotho, Southern (st), 1920
Afrikaans (af), 0106	Manx (gv), 0722	Macedonian (mk), 1311	Sundanese (su), 1921
Akan (ak), 0111	Hausa (ha), 0801	Malayalam (ml), 1312	Swahili (sw), 1923
Amharic (am), 0113	Hebrew (he), 0805	Mongolian (mn), 1314	Tamil (ta), 2001
Aragonese (an), 0114	Hindi (hi), 0809	Marathi (mr), 1318	Telugu (te), 2005
Arabic (ar), 0118	Hiri Motu (ho), 0815	Malay (ms), 1319	Tajik (tg), 2007
Assamese (as), 0119	Croatian (hr), 0818	Maltese (mt), 1320	Thai (th), 2008
Avaric (av), 0122	Haitian (ht), 0820	Burmese (my), 1325	Tigrinya (ti), 2009
Aymara (ay), 0125	Hungarian (hu), 0821	Nauru (na), 1401	Turkmen (tk), 2011
Azerbaijani (az), 0126	Armenian (hy), 0825	Bokmal (nb), 1402	Tagalog (tl), 2012
Bashkir (ba), 0201	Herero (hz), 0826	Ndebele, North (nd), 1404	Tswana (tn), 2014
Belarusian (be), 0205	Interlingua (ia), 0901	Nepali (ne), 1405	Tonga (to), 2015
Bulgarian (bg), 0207	Indonesian (id), 0904	Ndonga (ng), 1407	Turkish (tr), 2018
Bihari (bh), 0208	Interlingue (ie), 0905	Nynorsk (nn), 1414	Tsonga (ts), 2019
Bislama (bi), 0209	Igbo (ig), 0907	Norwegian (no), 1415	Tatar (tt), 2020
Bambara (bm), 0213	Sichuan Yi (ii), 0909	Ndebele, South (nr), 1418	Twi (tw), 2023
Bengali (bn), 0214	Inupiaq (ik), 0911	Navajo, Navaho (nv), 1422	Tahitian (ty), 2025
Tibetan (bo), 0215	Ido (io), 0915	Chichewa (ny), 1425	Uighur, Uyghur (ug), 2107
Breton (br), 0218	Icelandic (is), 0919	Occitan (oc), 1503	Ukrainian (uk), 2111
Bosnian (bs), 0219	Inuktitut (iu), 0921	Ojibwa (oj), 1510	Urdu (ur), 2118
Catalan (ca), 0301	Javanese (jv), 1022	Oromo (om), 1513	Uzbek (uz), 2126
Chechen (ce), 0305	Georgian (ka), 1101	Oriya (or), 1518	Venda (ve), 2205
Chamorro (ch), 0308	Kongo (kg), 1107	Ossetian (os), 1519	Vietnamese (vi), 2209
Corsican (co), 0315	Kikuyu, Gikuyu (ki), 1109	Panjabi, Punjabi (pa), 1601	Volapük (vo), 2215
Cree (cr), 0318	Kuanyama (kj), 1110	Pali (pi), 1609	Walloon (wa), 2301
Czech (cs), 0319	Kazakh (kk), 1111	Polish (pl), 1612	Wolof (wo), 2315
Church Slavonic (cu), 0321	Kalaallisut (kl), 1112	Pashto, Pushto (ps), 1619	Xhosa (xh), 2408
Chuvash (cv), 0322	Central Khmer (km), 1113	Quechua (qu), 1721	Yiddish (yi), 2509
Welsh (cy), 0325	Kannada (kn), 1114	Romansh (rm), 1813	Yoruba (yo), 2515
Danish (da), 0401	Kanuri (kr), 1118	Rundi (rn), 1814	Zhuang, Chuang (za), 2601
Divehi (dv), 0422	Kashmiri (ks), 1119	Romanian (ro), 1815	Zulu (zu), 2621



Additional Information

Specifications

General

Rated power source	14.4 V DC (allowable voltage range: 12.0 V to 14.4 V DC)
Grounding system	Negative type
Maximum current consumption	10.0 A
Dimensions (W × H × D): DIN	
Chassis	180 mm × 50 mm × 160 mm
Nose	188 mm × 58 mm × 32 mm
D	
Chassis	178 mm × 50 mm × 165 mm
Nose	170 mm × 46 mm × 27 mm
Weight	2.2 kg

Display

Screen size/aspect ratio	7.0 inch wide/16:9 (effective display area: 154.0 mm × 86.9 mm)
Pixels	345 600 (1 440 × 240)
Display method	TFT active matrix, driving type
Color system	PAL/SECAM compatible
Durable temperature range (power off)	-20 °C to +80 °C
Angle adjustment	50° to 110° (initial settings: 90°)

Audio

Maximum power output	50 W × 4 70 W × 1/2 Ω (for subwoofer)
Continuous power output	22 W × 4 (1 kHz, 5% THD, 4 Ω load, both channels driven)
Load impedance	4 Ω (4 Ω to 8 Ω (2 Ω for 1 ch) allowable)
Preout maximum output level	4.0 V
Equalizer (8-Band Graphic Equalizer):	
Frequency	40 Hz/80 Hz/200 Hz/400 Hz/ 1 kHz/2.5 kHz/8 kHz/10 kHz
Gain	± 12 dB
HFP:	
Frequency	50 Hz/63 Hz/80 Hz/100 Hz/ 125 Hz
Slope	-12 dB/oct

Subwoofer (mono):

Frequency	50 Hz/63 Hz/80 Hz/100 Hz/ 125 Hz
Slope	-18 dB/oct
Gain	+6 dB to -24 dB
Phase	Normal/Reverse
Bass boost:	
Gain	+12 dB to 0 dB

DVD Player

System	DVD video, Video CD, CD, WMA, MP3, AAC, DivX, JPEG system
Usable discs	DVD video, Video CD, CD, CD-R/RW, DVD-R/RW/RDL
Region number	2
Frequency response	5 Hz to 44 000 Hz (with DVD, at sampling frequency 96 kHz)
Signal-to-noise ratio	96 dB (1 kHz) (IEC-A net- work) (RCA level)
Output level:	
Video	1.0 Vp-p/75 Ω (\pm 0.2 V)
Number of channels	2 (stereo)
MP3 decoding format	MPEG-1 & 2 Audio Layer 3
WMA decoding format	Ver. 7, 7.1, 8, 9, 10, 11, 12 (2 ch audio) (Windows Media Player)
AAC decoding format	MPEG-4 AAC (iTunes en- coded only) (.m4a) (Ver. 9.0.3 and earlier)
DivX decoding format	Home Theater Ver. 3, 4, 5, 2, 6 (.avi, .divx)

USB

USB standard specification	USB 1.1, USB 2.0 full speed
Maximum current supply	500 mA
USB Class	MSC (Mass Storage Class)
File system	FAT16, FAT32
MP3 decoding format	MPEG-1 & 2 Audio Layer 3
WMA decoding format	Ver. 7, 7.1, 8, 9, 10, 11, 12 (2 ch audio) (Windows Media Player)
AAC decoding format	MPEG-4 AAC (iTunes en- coded only) (Ver. 9.0.3 and earlier)
DivX decoding format	Home Theater Ver. 3, 4, 5, 2, 6 (.avi, .divx)

SD

Compatible physical format	Version 1.1
File system	FAT12, FAT16, FAT32

Additional Information

MP3 decoding format	MPEG-1 & 2 Audio Layer 3
WMA decoding format	Ver. 7, 7.1, 8, 9, 10, 11, 12 (2 ch audio) (Windows Media Player)
AAC decoding format	MPEG-4 AAC (iTunes encoded only) (Ver. 9.0.3 and earlier)
DivX decoding format	Home Theater Ver. 3, 4, 5.2, 6 (.avi, .divx)

FM tuner

Frequency range	87.5 MHz to 108.0 MHz
Usable sensitivity	9 dBf (0.8 μ V/75 Ω mono, S/N: 30 dB)
Signal-to-noise ratio	72 dB (IEC-A network)

MW tuner

Frequency range	531 kHz to 1 602 kHz (9 kHz)
Usable sensitivity	25 μ V (S/N: 20 dB)
Signal-to-noise ratio	62 dB (IEC-A network)

LW tuner

Frequency range	153 kHz to 281 kHz
Usable sensitivity	28 μ V (S/N: 20 dB)
Signal-to-noise ratio	62 dB (IEC-A network)

Bluetooth

(AVH-6300BT)	
Version	Bluetooth 2.0 certified
Output power	+4 dBm Maximum (Power class 2)

Note

Specifications and the design are subject to modifications without notice. ■

<http://www.pioneer.eu>

Visit www.pioneer.co.uk (or www.pioneer.eu) to register your product.

PIONEER CORPORATION

1-1, Shin-ogura, Saiwai-ku, Kawasaki-shi,
Kanagawa 212-0031, JAPAN

PIONEER ELECTRONICS (USA) INC.

P.O. Box 1540, Long Beach, California 90801-1540, U.S.A.
TEL: (800) 421-1404

PIONEER EUROPE NV

Haven 1087, Keetberglaan 1, B-9120 Melsele, Belgium/Belgique
TEL: (0) 3/570.05.11

PIONEER ELECTRONICS ASIACENTRE PTE. LTD.

253 Alexandra Road, #04-01, Singapore 159936
TEL: 65-6472-7555

PIONEER ELECTRONICS AUSTRALIA PTY. LTD.

5 Arco Lane, Heatherton, Victoria, 3202 Australia
TEL: (03) 9586-6300

PIONEER ELECTRONICS OF CANADA, INC.

300 Allstate Parkway, Markham, Ontario L3R 0P2, Canada
TEL: 1-877-283-5901
TEL: 905-479-4411

PIONEER ELECTRONICS DE MEXICO, S.A. de C.V.

Bldv.Manuel Avila Camacho 138 10 piso
Col.Lomas de Chapultepec, Mexico, D.F. 11000
TEL: 55-9178-4270

先鋒股份有限公司

台北市內湖區瑞光路407號8樓
電話：(02) 2657-3588

先鋒電子（香港）有限公司

香港九龍尖沙咀海港城世界商業中心
9樓901-6室
電話：(0852) 2848-6488

Published by Pioneer Corporation.
Copyright © 2010 by Pioneer Corporation.
All rights reserved.