

Pioneer

CD RDS RECEIVER

DEH-5200SD

Operation Manual

English

Thank you for purchasing this PIONEER product.

To ensure proper use, please read through this manual before using this product. It is especially important that you read and observe **WARNING**s and **CAUTION**s in this manual. *Please keep the manual in a safe and accessible place for future reference.*

01 Before You Start

- About this unit **3**
- In case of trouble **3**
- Demo mode **3**
- Reverse mode **4**
- Resetting the microprocessor **4**
- Sound muting **4**
- About this manual **4**

02 Operating this unit

- Head unit **5**
- Optional remote control **5**
- Basic Operations **6**
- Menu operations identical for function settings/audio adjustments/initial settings/lists **6**
- Tuner **6**
 - Basic Operations **6**
 - Using PI Seek **7**
 - Using Auto PI Seek for preset stations **7**
 - Storing and recalling stations **7**
 - Using radio text **8**
 - Advanced operations using special buttons **8**
 - Function settings **8**
 - PTY list **9**
- CD/CD-R/CD-RW and external storage devices (USB, SD) **9**
 - Basic Operations **9**
 - Displaying text information **10**
 - Selecting and playing files/tracks from the name list **11**
 - Advanced operations using special buttons **11**
 - Function settings **11**
- iPod **11**
 - Basic Operations **11**
 - Displaying text information **12**

- Browsing for a song **12**
 - Advanced operations using special buttons **13**
 - Function settings **13**
- Audio Adjustments **14**
- Initial Settings **15**
- Other Functions **17**
- Using the AUX source **17**
 - Clock display **17**
 - Mute **17**
 - Using different entertainment displays **17**

Additional Information

- Troubleshooting **18**
- Error messages **18**
- Handling guideline **20**
- Compressed audio compatibility (disc, USB, SD) **21**
- iPod compatibility **23**
- Sequence of audio files **23**
- Copyright and trademark **23**
- Specifications **26**

Before You Start



If you want to dispose this product, do not mix it with general household waste. There is a separate collection system for used electronic products in accordance with legislation that requires proper treatment, recovery and recycling.

Private households in the member states of the EU, in Switzerland and Norway may return their used electronic products free of charge to designated collection facilities or to a retailer (if you purchase a similar new one).

For countries not mentioned above, please contact your local authorities for the correct method of disposal.

By doing so you will ensure that your disposed product undergoes the necessary treatment, recovery and recycling and thus prevent potential negative effects on the environment and human health. 

About this unit

The tuner frequencies on this unit are allocated for use in Western Europe, Asia, the Middle East, Africa and Oceania. Use in other areas may result in poor reception. The RDS (radio data system) function operates only in areas with FM stations broadcasting RDS signals.

CAUTION

- Do not allow this unit to come into contact with liquids. Electrical shock could result. Also, damage to this unit, smoke, and overheating could result from contact with liquids.
- "CLASS 1 LASER PRODUCT"

This product contains a laser diode of higher class than 1. To ensure continued safety, do

not remove any covers or attempt to gain access to the inside of the product. Refer all servicing to qualified personnel.

- The Pioneer CarStereo-Pass is for use only in Germany.
- Always keep the volume low enough to hear outside sounds.
- Avoid exposure to moisture.
- If the battery is disconnected or discharged, any preset memory will be erased. 



In case of trouble

Should this product fail to operate properly, please contact your dealer or nearest authorized Pioneer Service Station. 

Demo mode

Important

- Failure to connect the red lead (ACC) of this unit to a terminal coupled with ignition switch on/off operations may lead to battery drain.
- Remember that if the feature demo continues operating when the car engine is turned off, it may drain battery power.

The demo automatically starts when the ignition switch is set to ACC or ON while the unit is turned off. Turning off the unit does not cancel demo mode. To cancel the demo mode, press **DISP**//SCRL. Press **DISP**//SCRL again to start. Operating the demo while the ignition switch is set to ACC may drain battery power. 

Reverse mode

If you do not perform an operation within about 30 seconds, screen indications start to reverse, and then continue reversing every 10 seconds. Pressing button **BAND/ESC** when power to this unit is turned off while the ignition switch is set to ACC or ON cancels the reverse mode. Press button **BAND/ESC** again to start the reverse mode.

Resetting the microprocessor

The microprocessor must be reset under the following conditions:

- Prior to using this unit for the first time after installation
- If the unit fails to operate properly
- When strange or incorrect messages appear on the display

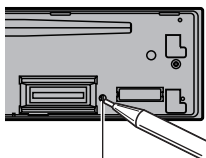

RESET button

- 1 Remove the front panel.
- 2 Press **RESET** with a pen tip or other pointed instrument.

Sound muting

Sound is muted automatically when:

- A call is made or received using a cell phone connected to this unit.
- Voice guidance is output from a connected Pioneer navigation unit.

The sound is turned off, **MUTE** is displayed and no audio adjustments, except volume control, are possible. Operation returns to normal when the phone connection or the voice guidance is ended.

About this manual

In the following instructions, USB memories, USB portable audio players, and SD memory cards are collectively referred to as “external storage devices (USB, SD).” If only USB memories and USB portable audio players are indicated, they are collectively referred to as “USB storage devices.”

Operating this unit

Head unit

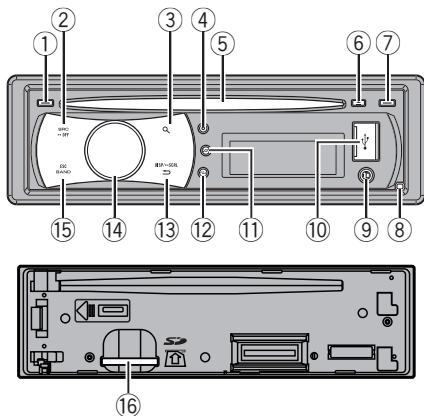

Part	Part
① TA/NEWS	⑨ AUX input jack (3.5 mm stereo jack)
② SRC/OFF	⑩ USB port
③ (list)	⑪ iPod/iPod
④ S.Rtrv	⑫ ↔/LOC
⑤ Disc loading slot	⑬ DISP/↔/SCRL
⑥ ▲ (eject)	⑭ MULTI-CONTROL (M.C.)
⑦ MUTE/CLK	⑮ BAND/ESC
⑧ Detach button	⑯ SD memory card slot
	⑰ You can see the SD memory card slot if you remove the front panel.

CAUTION

Use an optional Pioneer USB cable (CD-U50E) to connect the USB audio player/USB memory to the USB port. Since the USB audio player/USB memory is projected forward from the unit, it is dangerous to connect directly.

Do not use the unauthorized product. 

Optional remote control

The remote control CD-R320 is sold separately.

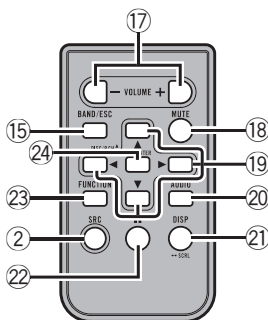

Part	Operation
⑰ VOLUME	Press to increase or decrease volume.
⑱ MUTE	Press to mute. Press again to unmute.
⑲ ▲/▼/◀/▶	Press to perform manual seek tuning, fast forward, reverse and track search controls. Also used for controlling functions.
⑳ AUDIO	Press to select an audio function.
㉑ DISP/SCRL	Press to select different displays. Press and hold to scroll through the text information.
㉒ II	Press to pause or resume.
㉓ FUNCTION	Press to select functions. Press and hold to recall the initial setting menu when the sources are off.
㉔ LIST/ENTER	Press to display the disc title, track title, folder, or file list depending on the source. While in the operating menu, press to control functions.



Basic Operations

Important

- Handle gently when removing or attaching the front panel.
- Avoid subjecting the front panel to excessive shock.
- Keep the front panel out of direct sunlight and high temperatures.
- Remove any cables and devices attached to this unit before detaching the front panel to avoid damage to the device or vehicle interior.

Removing the front panel to protect your unit from theft

- 1 Press the detach button to release the front panel.
- 2 Grab the front panel and remove.
- 3 Always keep the detached front panel in the protection device such as protection case.

Re-attaching the front panel

- 1 Slide the front panel to the left until it clicks. Front panel and the head unit are connected on the left side. Make sure that the front panel has been properly connected to the head unit.

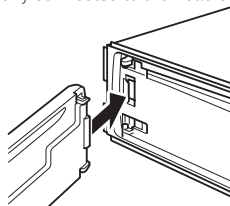

- 2 Press the right side of the front panel until it is firmly seated. If you can't attach the front panel to the head unit successfully, try again. However, forcing the front panel into place may result in damage.

Turning the unit on

- 1 Press **SRC/OFF** to turn the unit on.

Turning the unit off

- 1 Press **SRC/OFF** and hold until the unit turns off.

Selecting a source

- 1 Press **SRC/OFF** to cycle between:
TUNER (tuner)—**CD** (built-in CD player)—**USB** (USB)/**iPod** (iPod)—**SD** (SD memory card)—**AUX** (AUX)

Adjusting the volume

- 1 Turn **M.C.** to adjust volume.

Notes

- When this unit's blue/white lead is connected to the vehicle's auto-antenna relay control terminal, the vehicle's antenna extends when this unit's source is turned on. To retract the antenna, turn the source off.
- In this manual, iPod and iPhone will be referred to as iPod.

Menu operations identical for function settings/audio adjustments/initial settings/lists

Returning to the previous display
Returning to the previous list/category (the folder/category one level higher)

- 1 Press **DISP/↔/SCRL**.

Returning to the main menu
Returning to the top tier of list/category

- 1 Press and hold **DISP/↔/SCRL**.

Returning to the ordinary display
Canceling the initial setting menu

- 1 Press **BAND/ESC**.

Returning to the ordinary display from the list/category

- 1 Press **BAND/ESC**.



Tuner

Basic Operations



RDS

Operating this unit

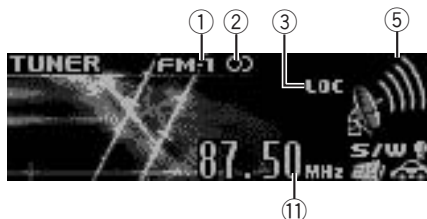

Non-RDS or MW/LW

- ① Band indicator
- ② (stereo) indicator
- ③ **LOC** indicator
Appears when local seek tuning is on.
- ④ Preset number indicator
- ⑤ Signal level indicator
- ⑥ **TEXT** indicator
Shows when the radio text is received.
- ⑦ PTY label indicator
- ⑧ Program service name
- ⑨ News () indicator
Appears when the set news program is received.
- ⑩ TP () indicator
Appears when a TP station is tuned in.
- ⑪ Frequency indicator

Selecting a band

- ① Press **BAND/ESC** until the desired band (**FM-1**, **FM-2**, **FM-3** for FM or **MW/LW**) is displayed.

Manual tuning (step by step)

- ① Push **M.C.** left or right.

Seeking

- ① Push and hold **M.C.** left or right.
You can cancel seek tuning by pushing **M.C.** left or right.
While pushing and holding **M.C.** left or right, you can skip stations. Seek tuning starts as soon as you release **M.C.**

Using PI Seek

If the tuner cannot find a suitable station, or reception status deteriorates, the unit automatically searches for a different station with the same programming. During the search, **PI seek** is displayed and sound is muted.

Using Auto PI Seek for preset stations

When preset stations cannot be recalled, the unit can be set to perform PI Seek during preset recall.

- The default setting for Auto PI Seek is off.
Refer to **Auto PI** (*auto PI seek*) on page 16.

Storing and recalling stations

You can easily store up to six stations for each band as presets.

1 Press (list).

Preset screen is displayed.

2 Use **M.C.** to store the selected frequency in memory.

Turn to change the preset number. Press and hold to store.

3 Use **M.C.** to select the desired station.

Turn to change the station. Press to select.

- All stations stored for FM bands can be recalled from each independent FM band.
- You can also change the station by pushing **M.C.** up or down.
- To return to the ordinary display, press **BAND/ESC** or (list).

Operating this unit

Using radio text

Displaying radio text

You can display the currently received radio text and the three most recent radio texts.

- 1 Press **DISP/SCRL** and hold to display radio text.
 - You can cancel radio text display by pressing **DISP/SCRL**, **TA/NEWS**, **SRC/OFF**, **EQ** or **BAND**.
 - When no radio text is received, **NO TEXT** appears in the display.
- 2 Push **M.C.** left or right to recall the three most recent radio texts.
- 3 Push **M.C.** up or down to scroll.

Storing and recalling radio text

You can store data from up to six radio text transmissions for keys **RT Memo 1** to **RT Memo 6**.

- 1 Display the radio text you want to store in memory.
- 2 Press **Q** (list).
Preset screen is displayed.
- 3 Use **M.C.** to store the selected radio text.
Turn to change the preset number. Press and hold to store.
- 4 Use **M.C.** to select the desired radio text.
Turn to change the radio text. Press to select.
 - To return to the ordinary display, press **BAND/ESC** or **Q** (list).

- The tuner automatically memorizes the three latest radio text broadcasts received, replacing text from the least recent reception with new text when it is received.

Advanced operations using special buttons

Receiving traffic announcements

TA (traffic announcement standby) lets you receive traffic announcements automatically, regardless of the source you are listening to.

- 1 Tune in a TP or enhanced other network's TP station.
- 2 Press **TA/NEWS** to turn traffic announcement standby on or off.
- 3 Use **M.C.** to adjust the TA volume when a traffic announcement begins.
The newly set volume is stored in memory and recalled for subsequent traffic announcements.
- 4 Press **TA/NEWS** while a traffic announcement is being received to cancel the announcement.
The tuner returns to the original source but remains in the standby mode until **TA/NEWS** is pressed again.

Using news program interruption

When a news program is broadcast from a PTY code news station, the unit automatically switches to the news broadcast station. When the news program ends, reception of the previous program resumes.

- 1 Press **TA/NEWS** and hold to turn on or off news program interruption.
A news program can be canceled by pressing **TA/NEWS**.

Function settings

1 Press M.C. to display the main menu.

2 Turn M.C. to change the menu option and press to select FUNCTION.

3 Turn M.C. to select the function.

After selecting, perform the following procedures to set the function.

BSM (best stations memory)

BSM (best stations memory) automatically stores the six strongest stations in the order of their signal strength.

- 1 Press **M.C.** to turn BSM on.
To cancel, press **M.C.** again.

Regional (regional)

When AF is used, the regional function limits the selection of stations broadcasting regional programs.

- 1 Press **M.C.** to turn the regional function on or off.

Local (local seek tuning)

Operating this unit

Local seek tuning lets you tune in only those radio stations with sufficiently strong signals for good reception.

- Press **M.C.** to turn local on.
 - To cancel, press **M.C.** again.
- Push **M.C.** left or right to select the desired setting.

FM: **Level 1—Level 2—Level 3—Level 4**

MW/LW: **Level 1—Level 2**

Larger setting number is higher level. The highest level setting allows reception of only the strongest stations, while lower settings let you receive progressively weaker stations.

PTY search (program type selection)

You can tune in a station by using PTY (program type) information.

- Press **M.C.** to display the setting mode.
- Push **M.C.** left or right to select the desired setting.

News&Inf—Popular—Classics—Others

- Press **M.C.** to begin the search. The unit searches for a station broadcasting that program type. When a station is found, its program service name is displayed.

PTY (program type ID code) information is listed in the following section. Refer to this page.

To cancel the search, press **M.C.** again.

The program of some stations may differ from that indicated by the transmitted PTY.

If no station is broadcasting the type of program you searched for, **NOT FOUND** is displayed for about two seconds and then the tuner returns to the original station.

Traffic (traffic announcement standby)

- Press **M.C.** to turn traffic announcement standby on or off.

AF (alternative frequencies search)

When the tuner cannot get a good reception, the unit automatically searches for a different station in the same network.

- Press **M.C.** to turn AF on or off.

News (news program interruption)

- Press **M.C.** to turn NEWS function on or off.

PTY list

News&Inf

News (News), **Affairs** (Current affairs), **Info** (Information), **Sport** (Sports), **Weather** (Weather), **Finance** (Finance)

Popular

Pop Mus (Popular music), **Rock Mus** (Rock music), **Easy Mus** (Easy listening), **Oth Mus** (Other music), **Jazz** (Jazz), **Country** (Country music), **Nat Mus** (National music), **Oldies** (Oldies music), **Folk mus** (Folk music)

Classics

L. Class (Light classical), **Classic** (Classical)

Others

Educate (Education), **Drama** (Drama), **Culture** (Culture), **Science** (Science), **Varied** (Varied), **Children** (Children's), **Social** (Social affairs), **Religion** (Religion), **Phone In** (Phone in), **Touring** (Travel), **Leisure** (Leisure), **Document** (Documentaries)

CD/CD-R/CD-RW and external storage devices (USB, SD)

Basic Operations



- Bit rate/sampling frequency indicator
Shows the bit rate or sampling frequency of the current track (file) when the compressed audio is playing.
 - When playing back VBR (variable bit rate)-recorded WMA files, the average bit rate value is displayed.
 - When playing back VBR (variable bit rate)-recorded MP3 files, **VBR** is displayed instead of bit rate value.

Operating this unit

- When playing back VBR (variable bit rate)-recorded AAC files, the average bit rate value is displayed. However, depending on the software used to decode AAC files, **VBR** may be displayed.
- Folder number indicator
Shows the folder number currently playing when the compressed audio is playing.
 - Track number indicator
 - PLAY/PAUSE** indicator
 - S.Rtrv** indicator
Appears when Sound Retriever function is on.
 - Song time (progress bar)
 - Play time indicator

Playing a CD/CD-R/CD-RW

- Insert the disc, label side up, into the disc loading slot.
- If a disc has already been inserted, press **SRC/OFF** to select the built-in CD player.

Ejecting a CD/CD-R/CD-RW

- Press **▲** (eject).

Playing songs on a USB storage device

- Open the USB connector cover.
- Plug in the USB storage device using a USB cable.

Stop playing a USB storage device

- You may disconnect the USB storage device at anytime.

Playing songs on an SD memory card

- Remove the front panel.
- Insert an SD memory card into the SD card slot. Insert it with the contact surface facing down and press the card until it clicks and completely locks.
- Re-attach the front panel.
- Press **SRC/OFF** to select **SD** as the source. Playback will start.

Stop playing an SD memory card

- Remove the front panel.
- Press the SD memory card until it clicks. The SD memory card is ejected.
- Pull out the SD memory card.
- Re-attach the front panel.

Selecting a folder

- Push **M.C.** up or down.

Selecting a track

- Push **M.C.** left or right.

Fast forwarding or reversing

- Push and hold **M.C.** left or right.

Returning to root folder

- Press and hold **BAND/ESC**.

Switching between compressed audio and CD-DA

- Press **BAND/ESC**.













Notes













- When playing compressed audio, there is no sound during fast forward or reverse.
- USB portable audio players that can be charged via USB will be recharged when plugged in and the ignition switch is set to ACC or ON.
- Disconnect USB storage device from unit when not in use.
- If plug and play is on and a USB storage device is present, depending on the type of device, the source may switch to **USB** automatically when you turn on the engine. Please change plug and play setting as necessary. Refer to **USB plug&play** (*plug and play*) on page 16.

Displaying text information

Selecting the desired text information

- Press **DISP/↔/SRC.L**.

CD TEXT discs: Play time—: disc artist name and : track title—: disc artist name and : disc title—: disc title and : track title—: track artist name and : track title—: track title and play time—: track title, : track artist name and : disc title

WMA/MP3/AAC/WAV: : track title and play time—: track title and : artist name—: track title and : album title—: file name and : folder name—play time—: artist name and : album title—: track title, : artist name and : album title

Scrolling the text information to the left

- Press and hold **DISP/↔/SRC.L**.

Notes

- Incompatible text stored with the audio file may not be displayed or may be displayed incorrectly.
- Depending on the version of iTunes used to write MP3/AAC files onto a disc, comment information may be incorrectly displayed.

Operating this unit

- When Windows Media Player 11 is used to encode the WAV files, text information can be displayed.

Selecting and playing files/tracks from the name list

1 Press **Q** (list) to switch to the file/track name list mode.

2 Use **M.C.** to select the desired file name (or folder name).

Changing file or folder name 1 Turn M.C.
Playing 1 When a file or track is selected, press M.C.
Seeing a list of files (or folders) in the selected folder 1 When a folder is selected, press M.C.
Playing a song in the selected folder 1 When a folder is selected, press and hold M.C.



Note

Track title list will display the list of track titles on a CD TEXT disc.

Advanced operations using special buttons

<p>Selecting a repeat play range</p> <p>1 Press ↔/LOC to cycle between the following:</p> <p>CD/CD-R/CD-RW</p> <ul style="list-style-type: none"> DISC – Repeat all tracks TRACK – Repeat the current track FOLDER – Repeat the current folder <p>External storage device (USB, SD)</p> <ul style="list-style-type: none"> TRACK – Repeat the current file FOLDER – Repeat the current folder ALL – Repeat all files
<p>Enhancing compressed audio and restoring rich sound (sound retriever)</p> <p>1 Press S.Rtrv to cycle between:</p> <p>OFF (off)—1—2</p> <p>1 is effective for low compression rates, and 2 is effective for high compression rates.</p>

Function settings

1 Press **M.C.** to display the main menu.

2 Turn **M.C.** to change the menu option and press to select **FUNCTION**.

3 Turn **M.C.** to select the function.

After selecting, perform the following procedures to set the function.

Play mode (repeat play)

- 1 Press **M.C.** to select a repeat play range.
For details, refer to *Selecting a repeat play range* on this page.

Random mode (random play)

- 1 Press **M.C.** to turn random play on or off.

Pause (pause)

- 1 Press **M.C.** to pause or resume.

Sound Retriever (sound retriever)

Automatically enhances compressed audio and restores rich sound.

- 1 Press **M.C.** to select the desired setting.
For details, refer to *Enhancing compressed audio and restoring rich sound (sound retriever)* on this page.



iPod

Basic Operations

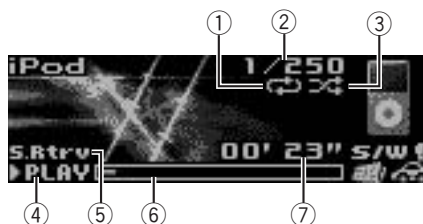

- Repeat indicator
- Song number indicator
- Shuffle indicator
- PLAY/PAUSE** indicator
- S.Rtrv** indicator

Appears when Sound Retriever function is on.

Operating this unit











- ⑥ Song time (progress bar)
- ⑦ Play time indicator

Playing songs on iPod ① Open the USB connector cover and plug in an iPod using the iPod Dock Connector to USB Cable.
Selecting a track (chapter) ① Push M.C. left or right.
Fast forwarding or reversing ① Push and hold M.C. left or right.

Notes

- The iPod's battery will be charged if the ignition switch is set to ACC or ON, while connected.
- While the iPod is connected to this unit, the iPod cannot be turned on or off unless the control mode is set to **iPod**.
- Disconnect headphones from the iPod before connecting to this unit.
- The iPod will turn off about two minutes after the ignition switch is set to OFF.

Displaying text information

Selecting the desired text information ① Press DISP/↔/SCRL . Play time—  : artist name and  : song title—  : artist name and  : album title—  : album title and  : song title—  : song title and play time —  : song title,  : artist name and  : album title
Scrolling the text information to the left ① Press and hold DISP/↔/SCRL .

Note

Incompatible text saved on the iPod will not be displayed by the unit.

Browsing for a song

- 1 Press **Q** (list) to switch to the top menu of the list search.

2 Use M.C. to select a category/song.

Changing the name of song or category ① Turn M.C. Playlists (playlists)— Artists (artists)— Albums (albums)— Songs (songs)— Podcasts (podcasts)— Genres (genres)— Composers (composers)— Audiobooks (audiobooks)
Playing ① When a song is selected, press M.C.
Seeing a list of songs in the selected category ① When a category is selected, press M.C.
Playing a song in the selected category ① When a category is selected, press and hold M.C.
Searching by alphabet in the list ① When a list for the selected category is displayed, press Q / LIST to switch to alphabet search mode. ② Turn M.C. to select a letter. ③ Press M.C. to display the alphabetical list. <ul style="list-style-type: none"> • If alphabet search is aborted, NOT FOUND is displayed.

Note

Depending on the number of files in the iPod, there may be a delay when displaying a list.

Operating this unit

Advanced operations using special buttons

Selecting a repeat play range

- 1 Press **↔/LOC** to cycle between the following:
 - **ONE** – Repeat the current song
 - **ALL** – Repeat all songs in the selected list

Playing all songs in a random order (shuffle all)

- 1 Press **⌘/iPod** to turn shuffle all on.

Playing songs related to the currently playing song
You can play songs from the following lists.

- Album list of currently playing artist
- Song list of currently playing album
- Album list of currently playing genre

- 1 Press and hold **M.C.** to switch to the link play mode.
- 2 Turn **M.C.** to change the mode; press to select.
 - **Artist** – Plays an album of currently playing artist.
 - **Album** – Plays a song of currently playing album.
 - **Genre** – Plays an album of currently playing genre.

The selected song/album will be played after the currently playing song.

 - The selected song/album may be cancelled if you operate functions other than link search (e.g. fast forward and reverse).
 - If no related albums/songs are found, **Not found** is displayed.
 - Depending on the song selected to play, the end of the currently playing song and the beginning of the selected song/album may be cut off.

Operating this unit's iPod function from your iPod
This function is not compatible with the following iPod models.

- iPod nano 1st generation
- iPod 5th generation

This unit's iPod function allows you to conduct operations from your iPod and listen to it using your car's speakers.

- Press **⌘/iPod** and hold to switch the control mode.
 - **iPod** – This unit's iPod function can be operated from the connected iPod.
 - **AUDIO** – This unit's iPod function can be operated from this unit.

Enhancing compressed audio and restoring rich sound (sound retriever)

Refer to *Enhancing compressed audio and restoring rich sound (sound retriever)* on page 11.

Function settings

1 Press **M.C.** to display the main menu.

2 Turn **M.C.** to change the menu option and press to select **FUNCTION**.

3 Turn **M.C.** to select the function.

After selecting, perform the following procedures to set the function.

Play mode (repeat play)

- Refer to **Play mode (repeat play)** on page 11. However the repeat range is different from CD/USB storage device. Refer to *Selecting a repeat play range* on this page.

Shuffle mode (shuffle)

- 1 Press **M.C.** to select your favorite setting.
 - **Shuffle Songs** – Play back songs in the selected list in random order.
 - **Shuffle Albums** – Play back songs from a randomly selected album in order.
 - **Shuffle OFF** – Cancel random play.

Shuffle all (shuffle all)

- 1 Press **M.C.** to turn shuffle all on. To turn off, set **Shuffle mode** in the **FUNCTION** menu to off.

Link play (link play)

- 1 Turn **M.C.** to change the mode; press to select. For details about the settings, refer to *Playing songs related to the currently playing song* on this page.

Control mode (control mode)

- 1 Press **M.C.** to select your favorite setting. For details about the settings, refer to *Operating this unit's iPod function from your iPod* on this page.

PAUSE (pause)

- Refer to **Pause (pause)** on page 11.

Audiobooks (audiobook speed)

The playback speed of audiobook can be changed.

- 1 Press **M.C.** to select your favorite setting.
 - **Faster** – Playback faster than normal speed
 - **Normal** – Playback in normal speed
 - **Slower** – Playback slower than normal speed

Operating this unit

Sound Retriever (sound retriever)

- Refer to **Sound Retriever** (*sound retriever*) on page 11.



Notes

- Switching the control mode to **iPod** pauses song playback. Operate the iPod to resume playback.
- The following functions are still accessible from the unit even if the control mode is set to **iPod**.
 - Volume
 - Fast forward/reverse
 - Track up/down
 - Pausing
 - Switching the text information
- When the control mode is set to **iPod**, operations are limited as follows:
 - Only **Control mode** (control mode), **PAUSE** (pause) and **Sound Retriever** (sound retriever) functions are available.
 - Browse function cannot be operated from this unit.

Audio Adjustments



- ① Audio display
Shows the audio adjustment status.

- Press **M.C.** to display the main menu.
- Turn **M.C.** to change the menu option and press to select **AUDIO**.
- Turn **M.C.** to select the audio function.
After selecting, perform the following procedures to set the audio function.

Fader/Balance (fader/balance adjustment)

- Push **M.C.** up or down to adjust front/rear speaker balance.
F15 to **R15** is displayed as the front/rear speaker balance moves from front to rear.
 - F/R 0** is the proper setting when only two speakers are used.
 - When the rear output setting is **Rear SP:S/W**, you cannot adjust front/rear speaker balance. Refer to **S/W control** (*rear output and subwoofer setting*) on page 16.
- Push **M.C.** left or right to adjust left/right speaker balance.
L15 to **R15** is displayed as the left/right speaker balance moves from left to right.

Powerful (equalizer recall)

- Push **M.C.** left or right to select an equalizer curve.
Powerful—Natural—Vocal—Custom1—Custom2—Flat—S.Bass
 - When **Flat** is selected no adjustments are made to the sound.

100 Hz (equalizer adjustment)

You can adjust the currently selected equalizer curve setting as desired. Adjusted equalizer curve settings are memorized in **Custom1** or **Custom2**.

- A separate **Custom1** curve can be created for each source. If you make adjustments when a curve other than **Custom2** is selected, the equalizer curve settings will be memorized in **Custom1**.
 - A **Custom2** curve can be created common to all sources. If you make adjustments when the **Custom2** curve is selected, the **Custom2** curve will be updated.
- Recall the equalizer curve you want to adjust.
 - Push **M.C.** left or right to select the equalizer band to adjust.
100Hz—315Hz—1.25kHz—3.15kHz—8kHz
 - Push **M.C.** up or down to adjust the equalizer curve.
+6 to **-6** is displayed as the equalizer curve is increased or decreased.

LOUD (loudness)

Loudness compensates for deficiencies in the low- and high-frequency ranges at low volume.

- Press **M.C.** to turn loudness on or off.
- Push **M.C.** left or right to select the desired setting.
Low (low)—**Mid** (mid)—**High** (high)—**OFF** (off)

Sub W.1 (subwoofer on/off setting)

Operating this unit

This unit is equipped with a subwoofer output which can be turned on or off.

- ① Press **M.C.** to turn subwoofer output on or off.
- ② Push **M.C.** left or right to select the phase of subwoofer output.
Push **M.C.** left to select reverse phase and **Reverse** appears in the display. Push **M.C.** right to select normal phase and **Normal** appears in the display.

Sub W.2 (subwoofer adjustment)

When the subwoofer output is on, you can adjust the cut-off frequency and the output level of the subwoofer.

Only frequencies lower than those in the selected range are outputted from the subwoofer.

- ① Push **M.C.** left or right to select cut-off frequency.
50Hz—63Hz—80Hz—100Hz—125Hz
- ② Push **M.C.** up or down to adjust the output level of the subwoofer.
Each time **M.C.** is pushed up or down, subwoofer level increases or decreases. **+6** to **-24** is displayed as the level is increased or decreased.

Bass (bass boost)

- ① Push **M.C.** up or down to select a desired level.
0 to **+6** is displayed as the level is increased or decreased.

HPF (high pass filter adjustment)

When you do not want low sounds from the subwoofer output frequency range to play from the front or rear speakers, turn on the HPF (high pass filter). Only frequencies higher than those in the selected range are output from the front or rear speakers.

- ① Press **M.C.** to turn high pass filter on or off.
- ② Push **M.C.** left or right to select cut-off frequency.
50Hz—63Hz—80Hz—100Hz—125Hz

SLA (source level adjustment)

SLA (Source level adjustment) lets you adjust the volume level of each source to prevent radical changes in volume when switching between sources.

- Settings are based on the FM volume level, which remains unchanged.
Before adjusting source levels, compare the FM volume level with the level of the source you wish to adjust.
 - The MW/LW volume level can also be adjusted with source level adjustments.
- ① Push **M.C.** up or down to adjust the source volume.
Adjustment range: **+4** to **-4**



When selecting FM as the source, you cannot switch to **SLA**.

Initial Settings



- ① Function display
 - Shows the function status.

1 Press SRC/OFF and hold until the unit turns off.

2 Press M.C. and hold until the initial setting menu appears in the display.

3 Turn M.C. to select the initial setting.

After selecting, perform the following procedures to set the initial setting.

Language select (multi language)

For your convenience, this unit equips multiple language display. You can select the language best suited to your first language.

- ① Press **M.C.** to select the language.
English—Français—Italiano—Español—Deutsch—Nederlands—РУССКИЙ

Calendar (setting the date)

- ① Push **M.C.** left or right to select the segment of the calendar display you wish to set.
Year—Day—Month
- ② Push **M.C.** up or down to set the date.

Clock (setting the clock)

Operating this unit

- 1 Push **M.C.** left or right to select the segment of the clock display you wish to set.
Hour—Minute
- 2 Push **M.C.** up or down to put a clock right.
 - You can match the clock to a time signal by pressing **M.C.**
 - If **00** to **29**, the minutes are rounded down. (e.g., **10:18** becomes **10:00**.)
 - If **30** to **59**, the minutes are rounded up. (e.g., **10:36** becomes **11:00**.)

EngineTime alert (elapsed time display setting)

This setting allows you to measure the length of time that elapses from when the machine is turned on and display the amount of elapsed time per set period. Also, you will hear alarm.

- 1 Press **M.C.** to select your favorite setting.
OFF—15Minutes—30Minutes

FM step (FM tuning step)

Normally the FM tuning step employed by seek tuning is 50 kHz. When AF or TA is on, the tuning step automatically changes to 100 kHz. It may be preferable to set the tuning step to 50 kHz when AF is on.

- 1 Press **M.C.** to display the setting mode.
- 2 Turn **M.C.** to select the FM tuning step.
50kHz (50 kHz)—**100kHz** (100 kHz)
- 3 Press **M.C.** to confirm the selection.

Auto PI (auto PI seek)

The unit can automatically search for a different station with the same programming, even during preset recall.

- 1 Press **M.C.** to turn Auto PI seek on or off.

USB plug&play (plug and play)

This setting allows you to switch your source to **USB/iPod** automatically.

- 1 Press **M.C.** to turn the plug and play on or off.
 - **ON** – When USB storage device/iPod is connected, the source is automatically switched to **USB/iPod**. If you disconnect your USB storage device/iPod, this unit's source is turned off.
 - **OFF** – When USB storage device/iPod is connected, the source is not switched to **USB/iPod** automatically. Please change the source to **USB/iPod** manually.

Warning tone (warning tone setting)

If the front panel is not detached from the head unit within two seconds of turning off the ignition, a warning tone sounds. You can turn off the warning tone.

- 1 Press **M.C.** to turn the warning tone on or off.

AUX (auxiliary input)

Activate this setting when using auxiliary device connected to this unit.

- 1 Press **M.C.** to turn auxiliary setting on or off.

Dimmer (dimmer setting)

To prevent the display from being too bright at night, the display is automatically dimmed when the car's headlights are turned on. You can turn the dimmer on or off.

- 1 Press **M.C.** to turn dimmer on or off.

Brightness (display brightness setting)

- 1 Push **M.C.** left or right to adjust the brightness level.
0 to **15** is displayed as the level is increased or decreased.
 - When dimmer is functioning, the brightness level can be adjusted **0** to **10**.

S/W control (rear output and subwoofer setting)

This unit's rear output (rear speaker leads output and RCA rear output) can be used for full-range speaker (**Rear SP:F.Range**) or subwoofer (**Rear SP:S/W**) connection. If you switch the rear output setting to **Rear SP:S/W**, you can connect a rear speaker lead directly to a subwoofer without using an auxiliary amp.

- 1 Press **M.C.** to switch the rear output setting.
 - When no subwoofer is connected to the rear output, select **Rear SP:F.Range** (full-range speaker).
 - When a subwoofer is connected to the rear output, select **Rear SP:S/W** (subwoofer).
- Even if you change this setting, there is no output unless you turn the subwoofer output on (refer to **Sub W.1** (*subwoofer on/off setting*) on page 14).
- If you change this setting, subwoofer output in the audio menu will return to the factory settings.
- Both rear speaker lead outputs and RCA rear output are switched simultaneously in this setting.

Mute (muting or attenuation setting)

- 1 Press **M.C.** to switch the telephone muting/attenuation.
 - The sound is muted or attenuated, **MUTE** or **ATT** are displayed and no audio adjustment is possible.
 - Sound from this system returns to normal when the muting or attenuation is canceled.

Demonstration (demo display setting)

Operating this unit

- 1 Press **M.C.** to turn the demo display on or off.
- You can also turn on or off feature demo by pressing **DISP** while this unit is turned off. For more details, refer to *Demo mode* on page 3.

Reverse mode (reverse mode setting)

- 1 Press **M.C.** to turn the reverse mode on or off.
- You can also turn on or off reverse mode by pressing **BAND** while this unit is turned off. For more details, refer to *Reverse mode* on page 4.

Ever-scroll (scroll mode setting)

When Ever Scroll is set to ON, recorded text information scrolls continuously in the display. Set to OFF if you prefer the information to scroll just once.

- 1 Press **M.C.** to turn the ever scroll on or off.



Using different entertainment displays

You can enjoy entertainment displays while listening to each sound source.

1 Press M.C. to display the main menu.

2 Turn M.C. to change the menu option and press to select ENTERTAINMENT.

3 Turn M.C. to change the display.

Background visual—genre—background picture 1—background picture 2—background picture 3—background picture 4—simple display—movie screen 1—movie screen 2—calendar

- Genre display changes depending on the genre of music.
- Genre display may not operate correctly depending on the application used to encode audio files.

Other Functions

Using the AUX source

- 1 Insert the stereo mini plug into the AUX input jack.
- 2 Press **SRC/OFF** to select AUX as the source.



Note

AUX cannot be selected unless the auxiliary setting is turned on. For more details, refer to **AUX** (*auxiliary input*) on the previous page.

Clock display

- Press and hold **MUTE/CLK** to select the desired setting.

Clock off—clock display—elapsed time display

Mute

- 1 Press **MUTE/CLK** to cut the sound.
- 2 To cancel it, press **MUTE/CLK** again.

Additional Information

Troubleshooting

Symptom	Cause	Action (See)
The display automatically returns to the ordinary display.	You did not perform any operation within about 30 seconds.	Perform operation again.
The repeat play range changes unexpectedly.	Depending on the repeat play range, the selected range may change when selecting another folder or track, or when fast forwarding/reversing.	Select the repeat play range again.
A subfolder is not played back.	Subfolders cannot be played when FOLDER (folder repeat) is selected.	Select another repeat play range.
NO XXXX appears when a display is changed (e.g., NO TITLE).	No text information embedded	Switch the display or play another track/file.
The display is illuminated when the unit is turned off.	Demo mode is on.	Press DISP/ / SCRL to cancel demo mode.
The unit is malfunctioning. There is interference.	You are using a device, such as a cell phone, that transmits electromagnetic waves near the unit.	Move electrical devices that may be causing the interference away from the unit.



Error messages

When you contact your dealer or your nearest Pioneer Service Center, be sure to note the error message.

Built-in CD Player

Message	Cause	Action
ERROR-11, 12, 17, 30	Dirty disc	Clean disc.
	Scratched disc	Replace disc.
ERROR-10, 11, 12, 15, 17, 30, A0	Electrical or mechanical	Turn the ignition switch OFF and back ON, or switch to a different source, then back to the CD player.
	ERROR-15	The inserted disc is blank
ERROR-22, 23	Unsupported CD format	Replace disc.
FORMAT READ	There is sometimes a delay between the start of playback and when you start to hear any sound	Wait until the message disappears and you hear sound.
NO AUDIO	The inserted disc does not contain any playable files	Replace disc.
SKIPPED	The inserted disc contains DRM protected WMA files	Replace disc.
PROTECT	All the files on the inserted disc are embedded with DRM	Replace disc.

External storage device (USB, SD)

Message	Cause	Action
NO DEVICE	When plug and play is off, no USB storage device is connected.	<ul style="list-style-type: none"> • Turn the plug and play on. • Connect a compatible USB storage device.
FORMAT READ	There is sometimes a delay between the start of playback and when you start to hear any sound	Wait until the message disappears and you hear sound.

Additional Information

NO AUDIO	No songs	Transfer the audio files to the USB storage device and connect.
	The connected USB storage device has security enabled	Follow the USB storage device instructions to disable the security.
SKIPPED	The connected USB storage device contains WMA files embedded with Windows Media™ DRM 9/10	Play an audio file not embedded with Windows Media DRM 9/10.
PROTECT	All the files in the USB storage device are embedded with Windows Media DRM 9/10	Transfer audio files not embedded with Windows Media DRM 9/10 to the USB storage device and connect.
CHECK USB	The USB connector or USB cable has short-circuited.	Check that the USB connector or USB cable is not caught in something or damaged.
	The connected USB storage device consumes more than 500 mA (maximum allowable current).	Disconnect the USB storage device and do not use it. Turn the ignition switch to OFF, then to ACC or ON and then connect only compliant USB storage devices.
NOT COMPATIBLE	Not compatible USB device	Disconnect your device and replace it with a compatible USB storage device.
ERROR-19	Communication failure	Perform one of the following operations. –Turn the ignition switch OFF and back ON. –Disconnect or eject the external storage device. –Change to a different source. Then, return to the USB or SD source.

ERROR-23	USB storage device is not formatted with FAT12, FAT16 or FAT32	USB storage device should be formatted with FAT12, FAT16 or FAT32.
iPod		
Message	Cause	Action
NO DEVICE	When plug and play is off, no USB storage device or iPod is connected.	<ul style="list-style-type: none"> • Turn the plug and play on. • Connect a compatible iPod.
FORMAT READ	There is sometimes a delay between the start of playback and when you start to hear any sound	Wait until the message disappears and you hear sound.
ERROR-19	Communication failure	Disconnect the cable from iPod. Once iPod's main menu is displayed, reconnect cable. Reset the iPod.
	iPod failure	Disconnect the cable from iPod. Once iPod's main menu is displayed, reconnect cable. Reset the iPod.
ERROR-16	Old iPod firmware versions	Update the iPod version.
	iPod failure	Disconnect the cable from iPod. Once iPod's main menu is displayed, reconnect cable. Reset the iPod.
N/A USB	Not compatible iPod	Disconnect your device and replace it with a compatible iPod.

Additional Information

CHECK USB	iPod operates correctly but does not charge	Check if the connection cable for iPod shorted out (e.g., not caught in metal objects). After checking, turn the ignition switch OFF and back ON or disconnect the iPod and reconnect.
	STOP	No songs
	No songs in the current list	Select a list that contains songs.



Handling guideline

Discs and player

Use only discs featuring either of following two logos.



Use 12-cm disc. Do not use 8-cm disc or an adapter for 8-cm disc.

Use only conventional, fully circular discs. Do not use shaped discs.



Do not insert anything other than a CD into the CD loading slot.

Do not use cracked, chipped, warped, or otherwise damaged discs as they may damage the player.

Unfinalized CD-R/CD-RW disc playback is not possible.

Do not touch the recorded surface of the discs.

Store discs in their cases when not in use.

Avoid leaving discs in excessively hot environments including under direct sunlight.

Do not attach labels, write on or apply chemicals to the surface of the discs.

To clean a CD, wipe the disc with a soft cloth outward from the center.

Condensation may temporarily impair the player's performance. Leave it to adjust to the warmer temperature for about one hour. Also, wipe any damp discs with a soft cloth.

Playback of discs may not be possible because of disc characteristics, disc format, recorded application, playback environment, storage conditions, and so on.

Road shocks may interrupt disc playback.

Read the precautions for discs before using them.

External storage device (USB, SD)

Address any questions you have about your external storage device (USB, SD) to the manufacturer of the device.

Do not leave the external storage device (USB, SD) in any place with high temperatures.

Depending on the external storage device (USB, SD), the following problems may occur.

- Operations may vary.
- This unit may not recognize the storage device.
- The file may not be played back properly.

USB storage device

Connections via a USB hub are not supported.

Do not connect anything other than a USB storage device.

Firmly secure the USB storage device when driving. Do not let the USB storage device fall onto the floor, where it may become jammed under the brake or accelerator pedal.

Depending on the USB storage device, the following problems may occur.

- The device may generate noise in the radio.

Additional Information

SD memory card

This unit supports only the following SD memory cards.

- SD
- miniSD
- microSD
- SDHC

Keep the SD memory card out of the reach of children. Should the SD memory card be swallowed, consult a doctor immediately.

Do not touch the connectors of the SD memory card directly with your fingers or with any metal device.

Do not insert anything other than an SD memory card into the SD card slot. If a metal object (e.g. a coin) is inserted into the slot, the internal circuits may break and cause malfunctions.

When inserting a miniSD or microSD, use an adapter. Do not use an adapter which has metal parts other than the connectors exposed.

Do not insert a damaged SD memory card (e.g. warped, label peeled off) as it may not be ejected from the slot.

Do not try to force an SD memory card into the SD card slot as the SD memory card or this unit may be damaged.

When you eject an SD memory card, press it and hold until it clicks. It is dangerous to press the SD memory card and release your finger immediately as the SD card may shoot out of the slot and hit you in the face, etc. If the SD memory card shoots out of the slot, it may go missing.

iPod

Do not leave the iPod in direct sunlight for extended amounts of time. Extended exposure to direct sunlight can result in iPod malfunction due to the resulting high temperature.

Do not leave the iPod in any place with high temperatures.

To ensure proper operation, connect the dock connector cable from the iPod directly to this unit.

Firmly secure the iPod when driving. Do not let the iPod fall onto the floor, where it may become jammed under the brake or accelerator pedal.

For details, refer to the iPod's manuals.

About iPod settings

- When an iPod is connected, this unit changes the EQ (equalizer) setting of the iPod to off in order to optimize the acoustics. When you disconnect the iPod, the EQ returns to the original setting.
- You cannot set Repeat to off on the iPod when using this unit. Repeat is automatically changed to All when connecting the iPod to this unit.

DualDiscs

DualDiscs are two-sided discs that have a recordable CD for audio on one side and a recordable DVD for video on the other.

Since the CD side of DualDiscs is not physically compatible with the general CD standard, it may not be possible to play the CD side with this unit.

Frequent loading and ejecting of a DualDisc may result in scratches on the disc. Serious scratches can lead to playback problems on this unit. In some cases, a DualDisc may become stuck in the disc loading slot and will not eject. To prevent this, we recommend you refrain from using DualDisc with this unit. Please refer to the information from the disc manufacturer for more detailed information about DualDiscs.



Compressed audio compatibility (disc, USB, SD)

WMA

File extension: .wma

Bit rate: 48 kbps to 320 kbps (CBR), 48 kbps to 384 kbps (VBR)

Sampling frequency: 32 kHz, 44.1 kHz, 48 kHz

Windows Media Audio Professional, Lossless, Voice/DRM Stream/Stream with video: No

MP3

File extension: .mp3

Bit rate: 8 kbps to 320 kbps

Sampling frequency: 8 kHz to 48 kHz (32 kHz, 44.1 kHz, 48 kHz for emphasis)

Additional Information

Compatible ID3 tag version: 1.0, 1.1, 2.2, 2.3, 2.4 (ID3 tag Version 2.x is given priority over Version 1.x.)

M3u playlist: No

MP3i (MP3 interactive), mp3 PRO: No

WAV

File extension: .wav

Quantization bits: 8 and 16 (LPCM), 4 (MS ADPCM)

Sampling frequency: 16 kHz to 48 kHz (LPCM), 22.05 kHz and 44.1 kHz (MS ADPCM)

AAC

Compatible format: AAC encoded by iTunes

File extension: .m4a

Sampling frequency: 11.025 kHz to 48 kHz

Transmission rate: 16 kbps to 320 kbps, VBR

Apple Lossless: No

AAC file bought on the iTunes Store (.m4p file extension): No

Supplemental information

Only the first 32 characters can be displayed as a file name (including the file extension) or a folder name.

This unit may not operate correctly depending on the application used to encode WMA files.

There may be a slight delay when starting playback of audio files embedded with image data.

Russian text to be displayed on this unit should be encoded with the following character sets:

- Unicode (UTF-8, UTF-16)
- Character sets other than Unicode that are used in a Windows environment and are set to Russian in the multi-language setting

Disc

Playable folder hierarchy: up to eight tiers (A practical hierarchy is less than two tiers.)

Playable folders: up to 99

Playable files: up to 999

File system: ISO 9660 Level 1 and 2, Romeo, Joliet

Multi-session playback: Yes

Packet write data transfer: No

Regardless of the length of blank section between the songs of the original recording, compressed audio discs play with a short pause between songs.

External storage device (USB, SD)

Playable folder hierarchy: up to eight tiers (A practical hierarchy is less than two tiers.)

Playable folders: up to 1 500

Playable files: up to 15 000

Playback of copyright protected files: No

Partitioned external storage device (USB, SD): Only the first playable partition can be played.

There may be a slight delay when starting playback of audio files on an external storage device (USB, SD) with numerous folder hierarchies.

SD memory card

There is no compatibility for Multi Media Cards (MMC).

Compatibility with all SD memory cards is not guaranteed.

This unit is not compatible with SD-Audio.



CAUTION

Pioneer accepts no responsibility for data lost on the USB memory/USB portable audio player/SD memory card/SDHC memory card even if that data is lost while using this unit. 

Additional Information

iPod compatibility

This unit supports only the following iPod models. Supported iPod software versions are shown below. Older versions may not be supported.

- iPod nano 4th generation (software version 1.0.3)
- iPod nano 3rd generation (software version 1.1.3)
- iPod nano 2nd generation (software version 1.1.3)
- iPod nano 1st generation (software version 1.3.1)
- iPod touch 2nd generation (software version 3.0)
- iPod touch 1st generation (software version 3.0)
- iPod classic 120GB (software version 2.0.1)
- iPod classic (software version 1.1.2)
- iPod 5th generation (software version 1.3)
- iPhone 3GS (software version 3.0)
- iPhone 3G (software version 3.0)
- iPhone (software version 3.0)

Depending on the generation or version of the iPod, some functions can not be operated.

Operations may vary depending on the software version of iPod.

When using an iPod, iPod Dock Connector to USB Cable is required.

Pioneer CD-IU50 interface cable is also available. For details, consult your dealer.

About the file/format compatibility, refer to iPod manuals.

Audio Book, Podcast: Yes

CAUTION

Pioneer accepts no responsibility for data lost on the iPod even if that data is lost while using this unit. 

Sequence of audio files

The user cannot assign folder numbers and specify playback sequences with this unit.

Example of a hierarchy

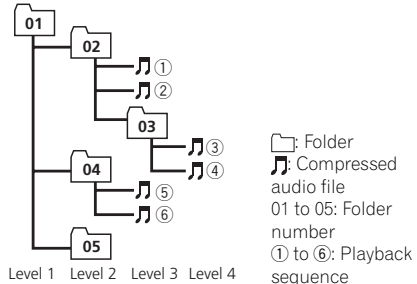

Disc

Folder selection sequence or other operation may differ depending on the encoding or writing software.

External storage device (USB, SD)

Playback sequence is the same as recorded sequence in the external storage device (USB, SD).

To specify the playback sequence, the following method is recommended.

- ① Create the file name including numbers that specify the playback sequence (e.g., 001xxx.mp3 and 099yyy.mp3).
- ② Put those files into a folder.
- ③ Save the folder containing files on the external storage device (USB, SD).

However, depending on the system environment, you cannot specify the playback sequence.

For USB portable audio players, the sequence is different and depends on the player. 

Copyright and trademark

iTunes

Apple and iTunes are trademarks of Apple Inc., registered in the U.S. and other countries.

Additional Information

MP3

Supply of this product only conveys a license for private, non-commercial use and does not convey a license nor imply any right to use this product in any commercial (i.e. revenue-generating) real time broadcasting (terrestrial, satellite, cable and/or any other media), broadcasting/streaming via internet, intranets and/or other networks or in other electronic content distribution systems, such as pay-audio or audio-on-demand applications. An independent license for such use is required. For details, please visit <http://www.mp3licensing.com>.

WMA



Windows Media and the Windows logo are trademarks or registered trademarks of Microsoft Corporation in the United States and/or other countries.

This product includes technology owned by Microsoft Corporation and cannot be used or distributed without a license from Microsoft Licensing, Inc.

SD memory card



SD Logo is a trademark.



miniSD Logo is a trademark.



microSD Logo is a trademark.



SDHC Logo is a trademark.

iPod



iPod is a trademark of Apple Inc., registered in the U.S. and other countries.

"Made for iPod" means that an electronic accessory has been designed to connect specifically to iPod and has been certified by the developer to meet Apple performance standards.

Apple is not responsible for the operation of this device or its compliance with safety and regulatory standards.

iPhone



iPhone is a trademark of Apple Inc.

Additional Information

“Works with iPhone” means that an electronic accessory has been designed to connect specifically to iPhone and has been certified by the developer to meet Apple performance standards.

Apple is not responsible for the operation of this device or its compliance with safety and regulatory standards. □

Additional Information

Specifications

General

Power source	14.4 V DC (10.8 V to 15.1 V allowable)
Grounding system	Negative type
Maximum current consumption	10.0 A
Dimensions (W × H × D):	
DIN	
Chassis	180 mm × 50 mm × 165 mm
Nose	188 mm × 58 mm × 17 mm
D	
Chassis	178 mm × 50 mm × 165 mm
Nose	170 mm × 46 mm × 17 mm
Weight	1.3 kg

Audio

Maximum power output	50 W × 4 50 W × 2/4 Ω + 70 W × 1/2 Ω (for subwoofer)
Continuous power output	22 W × 4 (50 Hz to 15 000 Hz, 5 % THD, 4 Ω load, both channels driven)
Load impedance	4 Ω to 8 Ω × 4 4 Ω to 8 Ω × 2 + 2 Ω × 1
Preout maximum output level	4.0 V
Equalizer (5-Band Graphic Equalizer):	
Frequency	100/315/1.25k/3.15k/8k Hz
Gain	±12 dB
HPF:	
Frequency	50/63/80/100/125 Hz
Slope	-12 dB/oct
Subwoofer (mono):	
Frequency	50/63/80/100/125 Hz
Slope	-18 dB/oct
Gain	+6 dB to -24 dB
Phase	Normal/Reverse
Bass boost:	
Gain	+12 dB to 0 dB

CD player

System	Compact disc audio system
Usable discs	Compact disc
Signal-to-noise ratio	94 dB (1 kHz) (IEC-A network)
Number of channels	2 (stereo)
MP3 decoding format	MPEG-1 & 2 Audio Layer 3
WMA decoding format	Ver. 7, 7.1, 8, 9, 10, 11 (2ch audio) (Windows Media Player)
AAC decoding format	MPEG-4 AAC (iTunes encoded only) (.m4a) (Ver. 8.2 and earlier)

WAV signal format Linear PCM & MS ADPCM
(Non-compressed)

USB

USB standard specification	USB 2.0 full speed
Maximum current supply	500 mA
USB Class	MSC (Mass Storage Class)
File system	FAT12, FAT16, FAT32
MP3 decoding format	MPEG-1 & 2 Audio Layer 3
WMA decoding format	Ver. 7, 7.1, 8, 9, 10, 11 (2ch audio) (Windows Media Player)
AAC decoding format	MPEG-4 AAC (iTunes encoded only) (.m4a) (Ver. 8.2 and earlier)
WAV signal format	Linear PCM & MS ADPCM (Non-compressed)

SD

Compatible physical format	Version 2.00
Maximum memory capacity	32 GB (for SD and SDHC)
File system	FAT12, FAT16, FAT32
MP3 decoding format	MPEG-1 & 2 Audio Layer 3
WMA decoding format	Ver. 7, 7.1, 8, 9, 10, 11 (2ch audio) (Windows Media Player)
AAC decoding format	MPEG-4 AAC (iTunes encoded only) (.m4a) (Ver. 8.2 and earlier)
WAV signal format	Linear PCM & MS ADPCM (Non-compressed)

FM tuner

Frequency range	87.5 MHz to 108.0 MHz
Usable sensitivity	9 dBf (0.8 μV/75 Ω mono, S/N: 30 dB)
Signal-to-noise ratio	72 dB (IEC-A network)

MW tuner

Frequency range	531 kHz to 1 602 kHz (9 kHz)
Usable sensitivity	25 μV (S/N: 20 dB)
Signal-to-noise ratio	62 dB (IEC-A network)

LW tuner

Frequency range	153 kHz to 281 kHz
Usable sensitivity	28 μV (S/N: 20 dB)
Signal-to-noise ratio	62 dB (IEC-A network)



Note

Specifications and the design are subject to modifications without notice. ■

<http://www.pioneer.eu>

Visit www.pioneer.co.uk (or www.pioneer.eu) to register your product.

PIONEER CORPORATION

4-1, MEGURO 1-CHOME, MEGURO-KU
TOKYO 153-8654, JAPAN

PIONEER ELECTRONICS (USA) INC.

P.O. Box 1540, Long Beach, California 90801-1540, U.S.A.
TEL: (800) 421-1404

PIONEER EUROPE NV

Haven 1087, Keetberglaan 1, B-9120 Melsele, Belgium/Belgique
TEL: (0) 3/570.05.11

PIONEER ELECTRONICS ASIACENTRE PTE. LTD.

253 Alexandra Road, #04-01, Singapore 159936
TEL: 65-6472-7555

PIONEER ELECTRONICS AUSTRALIA PTY. LTD.

178-184 Boundary Road, Braeside, Victoria 3195, Australia
TEL: (03) 9586-6300

PIONEER ELECTRONICS OF CANADA, INC.

300 Allstate Parkway, Markham, Ontario L3R 0P2, Canada
TEL: 1-877-283-5901
TEL: 905-479-4411

PIONEER ELECTRONICS DE MEXICO, S.A. de C.V.

Bldv.Manuel Avila Camacho 138 10 piso
Col.Lomas de Chapultepec, Mexico, D.F. 11000
TEL: 55-9178-4270

先鋒股份有限公司

總公司：台北市中山北路二段44號13樓
電話：(02) 2521-3588

先鋒電子（香港）有限公司

香港九龍尖沙嘴海港世界商業中心
9樓901-6室
電話：(0852) 2848-6488

Published by Pioneer Corporation.
Copyright © 2009 by Pioneer Corporation.
All rights reserved.