

Pioneer

CD RDS RECEIVER

DEH-P7100BT

Operation Manual

English

Declaration of Conformity with regard to the R&TTE Directive 1999/5/EC

Manufacturer:

Pioneer Corporation

4-1, Meguro 1-chome, Meguro-ku
Tokyo 153-8654, Japan

EU Representative's:

Pioneer Europe NV

Haven 1087, Keetberglaan 1,
9120 Melsele, Belgium
<http://www.pioneer.eu>



English:

Hereby, Pioneer, declares that this DEH-P7100BT is in compliance with the essential requirements and other relevant provisions of Directive 1999/5/EC.

Suomi:

Pioneer vakuuttaa täten että DEH-P7100BT tyyppinen laite on direktiivin 1999/5/EY oleellisten vaatimusten ja sitä koskevien direktiivin muiden ehtojen mukainen.

Nederlands:

Hierbij verklaart Pioneer dat het toestel DEH-P7100BT in overeenstemming is met de essentiële eisen en de andere relevante bepalingen van richtlijn 1999/5/EG

Français:

Par la présente Pioneer déclare que l'appareil DEH-P7100BT est conforme aux exigences essentielles et aux autres dispositions pertinentes de la directive 1999/5/CE

Svenska:

Härmed intygar Pioneer att denna DEH-P7100BT står i överensstämmelse med de väsentliga egenskapskrav och övriga relevanta bestämmelser som framgår av direktiv 1999/5/EG.

Dansk:

Undertegnede Pioneer erklærer herved, at følgende udstyr DEH-P7100BT overholder de væsentlige krav og øvrige relevante krav i direktiv 1999/5/EF

Deutsch:

Hiermit erkläre Pioneer, dass sich dieses DEH-P7100BT in Übereinstimmung mit den grundlegenden Anforderungen und den anderen relevanten Vorschriften der Richtlinie 1999/5/EG befindet". (BMW)

Ελληνικά:

ΜΕ ΤΗΝ ΠΑΡΟΥΣΑ Pioneer ΔΗΛΩΝΕΙ ΟΤΙ DEH-P7100BT ΣΥΜΜΟΡΦΟΝΕΤΑΙ ΠΡΟΣ ΤΙΣ ΟΥΣΙΩΔΕΙΣ ΑΠΑΙΤΗΣΕΙΣ ΚΑΙ ΤΙΣ ΛΟΙΠΕΣ ΣΧΕΤΙΚΕΣ ΔΙΑΤΑΞΕΙΣ ΤΗΣ ΟΔΗΓΙΑΣ 1999/5/EK

Italiano:

Con la presente Pioneer dichiara che questo DEH-P7100BT è conforme ai requisiti essenziali e alle altre disposizioni pertinenti stabilite dalla direttiva 1999/5/CE.

Español:

Por medio de la presente Pioneer declara que el DEH-P7100BT cumple con los requisitos esenciales y cualesquiera otras disposiciones aplicables o exigibles de la Directiva 1999/5/CE

Português:

Pioneer declara que este DEH-P7100BT está conforme com os requisitos essenciais e outras disposições da Directiva 1999/5/CE.

Čeština:

Pioneer tímto prohlašuje, že tento DEH-P7100BT je ve shodě se základními požadavky a dalšími příslušnými ustanoveními směrnice 1999/5/ES

Eesti:

Käesolevaga kinnitab Pioneer seadme DEH-P7100BT vastavust direktiivi 1999/5/EÜ põhinõuetele ja nimetatud direktiivist tulenevatele teistele asjakohastele sätetele.

Magyar:

Alulírott, Pioneer nyilatkozom, hogy a DEH-P7100BT megfelel a vonatkozó alapvető követelményeknek és az 1999/5/EC irányelv egyéb előírásainak.

Latviešu valoda:

Ar šo Pioneer deklarē, ka DEH-P7100BT atbilst Direktīvas 1999/5/EK būtiskajām prasībām un citiem ar to saistītajiem noteikumiem.

Lietuvių kalba:

Šiuo Pioneer deklaruoją, kad šis DEH-P7100BT atitinka esminius reikalavimus ir kitas 1999/5/EB Direktyvos nuostatas.

Malti:

Hawnhekk, Pioneer jiddikjara li dan DEH-P7100BT jikkonforma mal-htigijiet essenzjali u ma provvedimenti oħrajn rilevanti li hemm fid-Direttiva 1999/5/EC

Slovenčina:

Pioneer týmto vyhlasuje, že DEH-P7100BT spĺňa základné požiadavky a všetky príslušné ustanovenia Smernice 1999/5/ES.

Slovenščina:

Pioneer izjavlja, da je ta DEH-P7100BT v skladu z bistvenimi zahtevami in ostalimi relevantnimi določili direktive 1999/5/ES.

Română:

Prin prezenta, Pioneer declara ca acest DEH-P7100BT este in conformitate cu cerintele esentiale si alte prevederi ale Directivei 1999/5/EU.

Български:

С настоящето, Pioneer декларира, че този DEH-P7100BT отговаря на основните изисквания и други съответни постановления на Директива 1999/5/EC.

Polski:

Niniejszym Pioneer oświadcza, że DEH-P7100BT jest zgodny z zasadniczymi wymogami oraz pozostałymi stosownymi postanowieniami Dyrektywy 1999/5/EC

Norsk:

Pioneer erklærer herved at utstyret DEH-P7100BT er i samsvar med de grunnleggende krav og øvrige relevante krav i direktiv 1999/5/EF.

Íslenska:

Hér með lýsir Pioneer yfir því að DEH-P7100BT er í samræmi við grunnkröfur og aðrar kröfur, sem gerðar eru í tilskipun 1999/5/EC

Thank you for purchasing this PIONEER product.

Please read through this manual before using the product for the first time, to ensure proper use. *After reading, please keep the manual in a safe and accessible place for future reference.*

01 Before You Start

- About this unit **6**
 - Features **6**
 - Operating environment **7**
- Visit our website **7**
- In case of trouble **7**
- Protecting your unit from theft **7**
 - Removing the front panel **7**
 - Attaching the front panel **8**
- Feature demo mode **8**
- Resetting the microprocessor **8**

02 What's what

- Head unit **9**
- Optional remote control **10**
- Display indication **11**

03 Basic Operations

- Power ON/OFF **12**
 - Turning the unit on **12**
 - Turning the unit off **12**
- Selecting a source **12**
- Adjusting the volume **12**

04 Tuner

- Basic Operations **13**
- Storing and recalling broadcast frequencies **13**
- Receiving PTY alarm broadcasts **13**
- Switching the RDS display **13**
- Introduction to advanced operations **14**
- Storing the strongest broadcast frequencies **14**
- Tuning in strong signals **14**
- Selecting alternative frequencies **14**
 - Using PI Seek **15**
 - Using Auto PI Seek for preset stations **15**
 - Limiting stations to regional programming **15**
- Receiving traffic announcements **15**

- Using PTY functions **16**
 - Searching for an RDS station by PTY information **16**
 - Using news program interruption **16**
 - Using radio text **16**
 - PTY list **17**

05 Built-in CD Player

- Basic Operations **19**
- Displaying text information on disc **19**
- Selecting tracks from the track title list **20**
- Selecting files from the file name list **20**
- Introduction to advanced operations **20**
- Selecting a repeat play range **21**
- Playing tracks in random order **21**
- Scanning folders and tracks **21**
- Pausing playback **21**
- Using advanced sound retriever **22**
- Entering disc titles **22**

06 Playing songs on USB storage device

- Basic Operations **23**
- Selecting files from the file name list **23**
- Displaying text information of an audio file **23**
- Introduction to advanced operations **23**
 - Function and operation **23**

07 Playing songs on iPod

- Basic Operations **25**
- Browsing for a song **25**
 - Searching songs by category **25**
 - Searching songs by alphabet **25**
- Displaying text information on iPod **26**
- Introduction to advanced operations **26**
 - Function and operation **26**
- Playing songs in a random order (shuffle) **26**
- Playing all songs in a random order (shuffle all) **27**

Playing songs related to the currently playing song **27**

Operating this unit's iPod function from your iPod **27**

Changing audiobook speed **28**

08 Using Bluetooth wireless technology

Connecting a Bluetooth device **29**

- Introduction to connection operations **29**
- Using a Bluetooth device to pair **30**
- Pairing from this unit **30**
- Disconnecting a Bluetooth device **31**
- Deleting a paired Bluetooth device **31**
- Connecting a paired Bluetooth device and selecting a service **31**
- Connecting to a Bluetooth device automatically **32**
- Displaying system version for repair **32**
- Displaying BD (Bluetooth Device) address **32**
- Editing device name **32**
- Entering PIN code for Bluetooth wireless connection **33**

Bluetooth Audio **33**

- Setting up for Bluetooth audio **34**
- Basic Operations **34**
- Introduction to advanced operations **34**
- Playing songs on a Bluetooth audio player **34**
- Stopping playback **34**

Bluetooth Telephone **35**

- Setting up for hands-free phoning **35**
- Making a phone call **35**
- Taking a phone call **36**
- Using the phone number list **36**
- Calling a number in the phone book **36**

– Using the missed, received and dialed call lists **37**

– Introduction to advanced operations **38**

– Transferring entries to the phone book **38**

– Setting automatic answering **38**

– Adjusting the intended party's listening volume **38**

– Switching the ring tone **39**

– Making a call by entering phone number **39**

– Setting the private mode **39**

09 Using voice recognition

Using voice recognition to operate this unit **40**

Using voice recognition to make a call **40**

Making a call to a phone number in memory **41**

If you become unsure of an operation: **41**

Voice command list **41**

10 Audio Adjustments

Introduction of audio adjustments **43**

Using balance adjustment **43**

Using the equalizer **43**

– Recalling equalizer curves **43**

– Adjusting equalizer curves **44**

– Adjusting 7-band graphic equalizer **44**

Adjusting loudness **45**

Using subwoofer output **45**

– Adjusting subwoofer settings **45**

Boosting the bass **46**

Using the high pass filter **46**

Adjusting source levels **46**

Using automatic sound levelizer **46**

Adjusting the voice guidance volume **47**

11 Initial Settings

Adjusting initial settings **48**

- Selecting the language **48**
- Setting the date **48**
- Setting the clock **48**
- Turning the off clock display on or off **49**
- Setting the FM tuning step **49**
- Switching Auto PI Seek **49**
- Switching the warning tone **49**
- Switching the auxiliary setting **50**
- List TTS (Text to speech) Playback **50**
- Switching the dimmer setting **50**
- Setting the rear output and subwoofer output **50**
- Switching the feature demo **51**
- Switching the ever scroll **51**
- Activating the BT AUDIO source **51**
- Resetting the Bluetooth wireless technology module **51**
- Updating the software about Bluetooth connection **52**

12 Other Functions

- Using the AUX source **53**
 - About AUX1 and AUX2 **53**
 - AUX1 source: **53**
 - AUX2 source: **53**
 - Selecting AUX as the source **53**
 - Setting the AUX title **53**
- Using the external unit **53**
 - Selecting the external unit as the source **53**
 - Basic operation **54**
 - Advanced operations **54**
- SMS (Short Message Service) Reception Notification Function **54**

13 Available accessories

- Playing songs on iPod **55**
 - Basic operation **55**
 - Displaying text information on iPod **55**
 - Browsing for a song **55**

- Introduction to advanced operations **55**
- Playing songs in a random order (shuffle) **56**

Multi-CD Player **56**

- Basic Operations **56**
- Using CD TEXT functions **56**
- Introduction to advanced operations **56**
- Using compression and bass emphasis **57**
- Using ITS playlists **57**
- Using disc title functions **58**

DVD Player **59**

- Basic Operations **59**
- Selecting a disc **59**
- Selecting a folder **59**
- Introduction to advanced operations **59**

TV tuner **61**

- Basic Operations **61**
- Storing and recalling broadcast stations **61**
- Storing the strongest broadcast stations sequentially **61**

Additional Information

- Troubleshooting **62**
- Error messages **62**
- Handling guideline of discs and player **64**
- Dual Discs **64**
- Compressed audio compatibility **65**
- iPod **65**
 - iPod compatibility **65**
 - About handling the iPod **65**
 - About iPod settings **66**
- Compressed audio files on the disc **66**
 - Example of a hierarchy **66**
- Bluetooth profiles **66**
- Copyright and trademark notice **67**
- Specifications **68**



If you want to dispose this product, do not mix it with general household waste. There is a separate collection system for used electronic products in accordance with legislation that requires proper treatment, recovery and recycling.

Private households in the member states of the EU, in Switzerland and Norway may return their used electronic products free of charge to designated collection facilities or to a retailer (if you purchase a similar new one).

For countries not mentioned above, please contact your local authorities for the correct method of disposal.

By doing so you will ensure that your disposed product undergoes the necessary treatment, recovery and recycling and thus prevent potential negative effects on the environment and human health. 

About this unit

The tuner frequencies on this unit are allocated for use in Western Europe, Asia, the Middle East, Africa and Oceania. Use in other areas may result in poor reception. The RDS (radio data system) function operates only in areas with FM stations broadcasting RDS signals.



CAUTION

- Do not allow this unit to come into contact with liquids. Electrical shock could result. Also, damage to this unit, smoke, and overheating could result from contact with liquids.
- "CLASS 1 LASER PRODUCT"

This product contains a laser diode of higher class than 1. To ensure continued safety, do

not remove any covers or attempt to gain access to the inside of the product. Refer all servicing to qualified personnel.

- The Pioneer CarStereo-Pass is for use only in Germany.
- Keep this manual handy as a reference for operating procedures and precautions.
- Always keep the volume low enough so that you can hear sounds from outside the vehicle.
- Protect this unit from moisture.
- If the battery is disconnected or discharged, the preset memory will be erased and must be reprogrammed.

Features

This unit is compatible with a wide variety of file formats and media/storage devices.

File format compatibility

- WMA
- MP3
- AAC
- WAV

For details about compatibility, refer to *Compressed audio compatibility* on page 65.

- This unit may not operate correctly depending on the application used to encode WMA files.

Media/storage device compatibility

- CD/CD-R/CD-RW
- USB portable audio player/USB memory

Make inquiries to the manufacturer about your USB portable audio player/USB memory. For details about the supported device, refer to *Specifications* on page 68.

iPod compatibility

This unit can control and listen to songs on an iPod.

In this manual, iPod and iPhone will be referred to as iPod.

For details about the supported iPod, refer to *iPod compatibility* on page 65.

Before You Start

Hands-free phoning

This unit realizes effortless hands-free phoning with Bluetooth wireless technology.

Bluetooth audio player compatibility

When you use this unit with a Bluetooth audio player featuring Bluetooth wireless technology, you can control the Bluetooth audio player.

CAUTION

- Pioneer accepts no responsibility for data lost on the USB memory/USB portable audio player even if that data is lost while using this unit.
- Pioneer accepts no responsibility for data lost on the iPod even if that data is lost while using this unit.

Operating environment

This unit should be used within the temperature ranges shown below.

Operating temperature range: -10 °C to +60 °C (14 °F to 140 °F)

EN300328 ETC test temperature: -20 °C and +55 °C (-4 °F and 131 °F) 

Visit our website

Visit us at the following site:

<http://www.pioneer.co.uk>

- Register your product. We will keep the details of your purchase on file to help you refer to this information in the event of an insurance claim such as loss or theft.
- We offer the latest information about Pioneer Corporation on our website. 

In case of trouble

Should this product fail to operate properly, please contact your dealer or nearest authorized Pioneer Service Station. 

Protecting your unit from theft

The front panel can be detached to deter theft.

- If the front panel is not detached from the head unit within five seconds of turning off the ignition, a warning tone sounds.
- You can turn off the warning tone. Refer to *Switching the warning tone* on page 49.

Important

- Handle gently when removing or attaching the front panel.
- Avoid subjecting the front panel to excessive shock.
- Keep the front panel out of direct sunlight and high temperatures.

Removing the front panel

1 Press  to open the front panel.

2 Grip the left side of the front panel and pull it gently outward.

Take care not to grip it too tightly or to drop the front panel and protect it from contact with water or other fluids to prevent permanent damage.

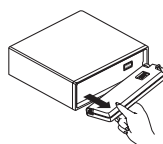

3 Put the front panel into the provided protective case for safe keeping.

Attaching the front panel

- Reattach the front panel by holding it upright to the unit and clipping it securely into the mounting hooks.

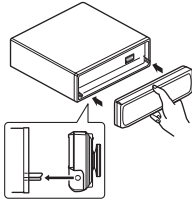

- 2 Press RESET with a pen tip or other pointed instrument.

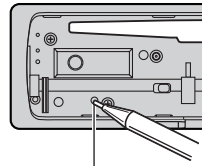

RESET button



Feature demo mode

The feature demo automatically starts when power to this unit is turned off while the ignition switch is set to ACC or ON. Press

DISP/SCRL during feature demo operation to cancel the feature demo mode. Press

DISP/SCRL again to start. Remember that if the feature demo continues operating when the car engine is turned off, it may drain battery power.



Important

The red lead (ACC) of this unit should be connected to a terminal coupled with ignition switch on/off operations. If this is not done, the vehicle battery may be drained. 

Resetting the microprocessor

The microprocessor must be reset under the following conditions:

- Prior to using this unit for the first time after installation
- If the unit fails to operate properly
- When strange or incorrect messages appear on the display

1 Removing the front panel

What's what

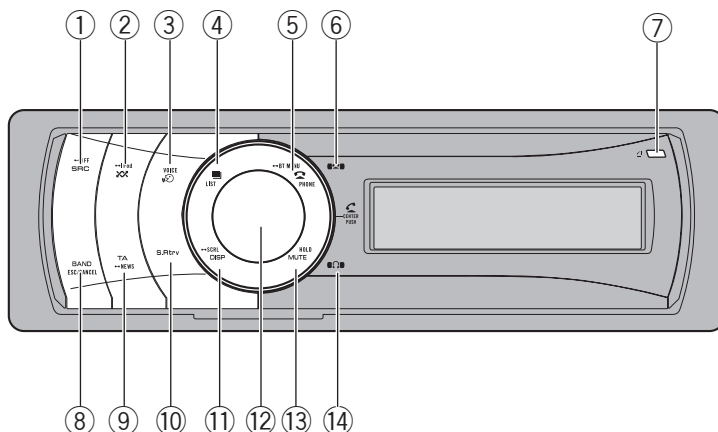

Head unit

① SRC/OFF button

Press to cycle through all the available sources. Press and hold to turn the unit off.

② X (random)/iPod button

Press to turn random function on or off while using CD or USB.

While using an iPod, press to shuffle all tracks.

Press and hold to switch the control mode while using an iPod.

If using the iPod with an interface adapter (CD-IB100II), press to switch the shuffle function.

③ VOICE/PHONE button

Press to start voice recognition for telephone call.

④ LIST button

Press to display the track title list, folder list, file list or preset channel list depending on the source.

Press and hold to switch to link play mode while using an iPod.

For details, refer to *Playing songs related to the currently playing song* on page 27.

⑤ PHONE/BT MENU button

Press to display the phone book list. While operating a phone call, press to end a call,

reject an incoming call or cancel making a call.

Press and hold to select **TELEPHONE** as a source.

⑥ Bluetooth indicator

Lights up when your cellular phone is connected via Bluetooth wireless technology.

- When selecting a source other than **TELEPHONE**, it flashes while using hands-free phoning.

⑦ Open front panel button

Press to open the front panel.

⑧ BAND/ESC/CANCEL button

Press to select among three FM bands and MW/LW bands.

Press to return to the ordinary display when operating the menu.

While using voice recognition function, press to cancel voice recognition.

⑨ TA/NEWS button

Press to turn TA function on or off. Press and hold to turn NEWS function on or off.

⑩ S.Rtrv button

Press to switch advanced sound retriever settings.

⑪ DISP/SCRL button

Press to select different displays.

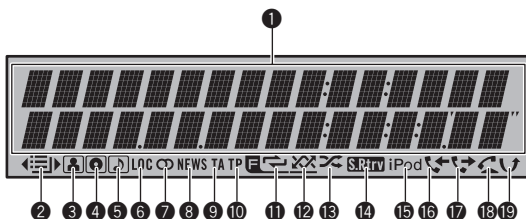

Press and hold to scroll through the text information.

12 MULTI-CONTROL

Move to perform manual seek tuning, fast forward, reverse and track search controls. When a call comes in, press to answer the incoming call.

Also used for controlling functions.

Turn to increase or decrease the volume.

- While using hands-free phoning, you can select **Far end Volume** and switch in **FUNCTION** by pressing **MULTI-CONTROL**.

13 MUTE/HOLD button

Press to turn off the sound. To turn on the sound, press again.

While talking on the phone, press to put the call on hold.

14 "Ω" indicator

Lights up when your Bluetooth audio player is connected via Bluetooth wireless technology. ■

Optional remote control

The remote control CD-SR120 is sold separately.

Operation is the same as when using the buttons on the head unit.

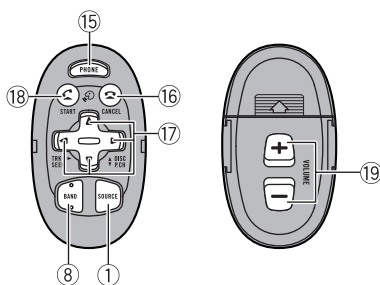

15 PHONE button

Press to display the phone book list. While operating a phone call, press to end a call, reject an incoming call or cancel making a call.

Press and hold to select **TELEPHONE** as a source.

16 CANCEL button

While operating the phone source, press to end a call or reject an incoming call.

While using voice recognition function, press to cancel voice recognition.

17 ▲/▼/◀/▶ buttons

Press to perform manual seek tuning, fast forward, reverse and track search controls. Also used for controlling functions.

18 C/START button

Press to start talking on the phone while operating a phone source.

Press to start voice recognition for telephone call.

19 VOLUME buttons

Press to increase or decrease the volume. ■

What's what

Display indication

1 Main display section

Displays band, frequency, elapsed playback time and other settings.

- Tuner
Band and frequency are displayed.
- RDS
Program service name, PTY information and other literal information are displayed.
- Built-in CD player, USB, iPod
Elapsed playback time and literal information are displayed.
- Bluetooth Audio
Device name, track name, artist name, album name are displayed.
- Bluetooth Telephone
Device name, clock, caller's name, caller's number, intended party's name, and intended party's number are displayed.

2 (folder) indicator

Appears when operating list function.
When an upper tier folder or menu exists, ◀ appears.
When a lower tier folder or menu exists, ▶ appears.

3 (artist) indicator

Appears when the disc (track) artist name is displayed on the main display section.
Appears when artist search refinement on the iPod browsing function is in use.

4 (disc) indicator

Appears when the disc (album) name is displayed on the main display section.
Appears when album search refinement on the iPod browsing function is in use.

5 (song) indicator

Appears when the track (song) name is displayed on the main display section.
Appears when song search refinement on the iPod browsing function is in use.

6 LOC indicator

Appears when local seek tuning is on.

7 (stereo) indicator

Appears when the selected frequency is being broadcast in stereo.

8 NEWS indicator

Appears when NEWS (news program interruption) function is on.

9 TA indicator

Appears when TA (traffic announcement standby) function is on.

10 TP indicator

Appears when a TP station is tuned in.

11 (folder repeat) indicator

Appears when folder repeat is on.
When repeat function is on, only  is displayed.

12 (folder random) indicator

Appears when folder random is on.
When random function is on, only  is displayed.

13 (shuffle) indicator

Appears when shuffle function is on while the iPod source is being selected.

14 (Sound Retriever) indicator

Appears when Sound Retriever function is on.

15 iPod indicator

Appears when the iPod connection is recognized while the control mode is set to iPod.

16 (received call) indicator

Appears when received call list is displayed while telephone source is being selected.

17 (dialled call) indicator

Appears when dialled call list is displayed while telephone source is being selected.

18 (auto answer) indicator

Shows when the automatic answering function is on (Refer to *Setting automatic answering* on page 38).

19 (missed call) indicator

Appears when there are missed call log.
Appears when missed call list is displayed while telephone source is being selected. ■

Power ON/OFF

Turning the unit on

- Press **SRC/OFF** to turn the unit on.

Turning the unit off

- Press **SRC/OFF** and hold until the unit turns off. 

Selecting a source

You can select a source you want to listen to. To switch to the built-in CD player, load a disc in the unit. Refer to page 19.

- Press **SRC/OFF** repeatedly to switch between the following sources.

Tuner—Television—DVD player/Multi-DVD player—Built-in CD player—Multi-CD player—iPod—USB—External unit 1—External unit 2—AUX1—AUX2—BT Audio



Notes

- In the following cases, the sound source will not change.
 - When no unit corresponding to the selected source is connected.
 - When there is no disc or magazine in the player.
 - When the iPod is not connected to this unit with the interface adapter.
 - When AUX (auxiliary input) is set to off (refer to page 50).
 - When the **BT AUDIO** source is set to off (refer to *Activating the BT AUDIO source* on page 51).
 - When an USB storage device or iPod is not connected to the USB port of this unit, **NO DEVICE** is displayed.
- AUX1 is set to on by default. Turn off the AUX1 when not in use (refer to *Switching the auxiliary setting* on page 50).
- Charging the portable audio player using car's DC power source while connecting it to

AUX input may generate noise. In this case, stop charging.

- External unit refers to a Pioneer product (such as ones available in the future) that, although incompatible as a source, enables control of basic functions with this unit. Two external units can be controlled with this unit. When two external units are connected, the external unit is automatically allocated to external unit 1 or external unit 2 by this unit.
- When this unit's blue/white lead is connected to the vehicle's auto-antenna relay control terminal, the vehicle's antenna extends when this unit's source is turned on. To retract the antenna, turn the source off. 

Adjusting the volume

- Turn **MULTI-CONTROL** to adjust the sound level. 

Basic Operations

● Select a band

Press **BAND/ESC/CANCEL**.

- Band can be selected from among **FM1**, **FM2**, **FM3** or **MW/LW**.

● Manual tuning (step by step)

Push **MULTI-CONTROL** left or right.

● Seek tuning

Push and hold **MULTI-CONTROL** left or right, and then release.

- You can cancel seek tuning by pushing **MULTI-CONTROL** left or right.
- While pushing and holding **MULTI-CONTROL** left or right, you can skip stations. Seek tuning starts as soon as you release **MULTI-CONTROL**.

Notes

- This unit's AF (alternative frequencies search) function can be turned on and off. AF should be off for normal tuning operation (refer to the next page).
- RDS service may not be provided by all stations.
- RDS functions such as AF and TA are only active when your radio is tuned to an RDS station. 

Storing and recalling broadcast frequencies

You can easily store up to six broadcast frequencies for later recall.

- Six stations for each band can be stored in memory.

1 Press /LIST.



Preset screen is displayed.

2 Use **MULTI-CONTROL** to store the selected frequency in memory.

Turn to change the preset number. Press and hold to store.

3 Use **MULTI-CONTROL** to select the desired station.

Turn to change the station. Press to select.

- You can also change the station by pushing **MULTI-CONTROL** up or down.
- To return to the ordinary display, press **BAND/ESC/CANCEL** or  /LIST.
- If you do not operate the list within about 30 seconds, the display automatically returns to the ordinary display. 

Receiving PTY alarm broadcasts

When the emergency PTY code broadcasts, the unit receives it automatically (**ALARM INT** appears). When the broadcasting ends, the system returns to the previous source.

- An emergency announcement can be canceled by pressing **TA/NEWS**.
- You can also cancel an emergency announcement by pressing **SRC/OFF**, **BAND/ESC/CANCEL** or **MULTI-CONTROL**. 

Switching the RDS display

When you tune in an RDS station its program service name is displayed. Switch the display to find out the frequency.

● Press **DISP/SCRL**.

Press **DISP/SCRL** repeatedly to switch between the following settings:

Program service name—PTY information—Frequency

PTY (program type ID code) information is listed in the following section. Refer to page 17.

- PTY information and the frequency of the current station appears on the display for eight seconds. 

Introduction to advanced operations

1 Press MULTI-CONTROL to display the main menu.

2 Use MULTI-CONTROL to select FUNCTION.

Turn to change the menu option. Press to select.

The function menu is displayed.

3 Turn MULTI-CONTROL to select the function.

BSM (best stations memory)—**Regional** (regional)—**Local** (local seek tuning)—**PTY** (program type selection)—**Traffic** (traffic announcement standby)—**AF** (alternative frequencies search)—**News** (news program interruption)



Notes

- To return to the ordinary display, press **BAND/ESC/CANCEL**.
- If MW/LW band is selected, you can only select **BSM** or **Local**.

Storing the strongest broadcast frequencies

BSM (best stations memory) lets you automatically store the six strongest broadcast frequencies.

1 Display the function menu.

Refer to *Introduction to advanced operations* on this page.

2 Use MULTI-CONTROL to select BSM in the function menu.

3 Press MULTI-CONTROL to turn BSM on.

The six strongest broadcast frequencies are stored in the order of their signal strength.

- To cancel, press **MULTI-CONTROL** again.

Tuning in strong signals

Local seek tuning lets you tune in only those radio stations with sufficiently strong signals for good reception.

1 Display the function menu.

Refer to *Introduction to advanced operations* on this page.

2 Use MULTI-CONTROL to select Local in the function menu.

3 Press MULTI-CONTROL to turn local seek tuning on.

- To turn local seek tuning off, press **MULTI-CONTROL** again.

4 Push MULTI-CONTROL left or right to set the sensitivity.

FM: **Level 1—Level 2—Level 3—Level 4**

MW/LW: **Level 1—Level 2**

Larger setting number is higher level. The highest level setting allows reception of only the strongest stations, while lower settings let you receive progressively weaker stations.

Selecting alternative frequencies

When the tuner cannot get a good reception, the unit automatically searches for a different station in the same network.

1 Display the function menu.

Refer to *Introduction to advanced operations* on this page.

2 Use MULTI-CONTROL to select AF in the function menu.

3 Press MULTI-CONTROL to turn AF on.

- To turn off, press **MULTI-CONTROL** again.



Notes

- Only RDS stations are tuned in during seek tuning or BSM when AF is on.

Tuner

- When you recall a preset station, the tuner may update the preset station with a new frequency from the station's AF list. No preset number appears on the display if the RDS data for the station received differs from that of the originally stored station.
- During AF search, sound may be temporarily interrupted.
- AF can be turned on or off independently for each FM band.

Using PI Seek

If the tuner cannot find a suitable station, or reception status becomes bad, the unit automatically searches for a different station with the same programming. During the search, **PI SEEK** is displayed and the output is muted.

Using Auto PI Seek for preset stations

When preset stations cannot be recalled, the unit can be set to perform PI Seek during preset recall.

- The default setting for Auto PI Seek is off. Refer to *Switching Auto PI Seek* on page 49.

Limiting stations to regional programming

When AF is used, the regional function limits the selection of stations broadcasting regional programs.

1 Display the function menu.

Refer to *Introduction to advanced operations* on the previous page.

2 Use **MULTI-CONTROL** to select **Regional** in the function menu.

3 Press **MULTI-CONTROL** to turn the **regional function** on.

- To turn off, press **MULTI-CONTROL** again.



Notes

- Regional programming and regional networks are organized differently depending on the country (i.e., they may change according to the hour, state or broadcast area).
- The preset number may disappear from the display if the tuner tunes in a regional station which differs from the originally set station.
- The regional function can be turned on or off independently for each FM band.

Receiving traffic announcements

TA (traffic announcement standby) lets you receive traffic announcements automatically, no matter what source you are listening to. TA can be activated for both a TP station (a station that broadcasts traffic information) or an enhanced other network's TP station (a station carrying information which cross-references TP stations).

1 Tune in a TP or enhanced other network's TP station.

TP indicator lights.

2 Press **TA/NEWS** to turn traffic announcement standby on.

- To turn off, press **TA/NEWS** again.

3 Use **MULTI-CONTROL** to adjust the **TA volume** when a traffic announcement begins.

The newly set volume is stored in memory and recalled for subsequent traffic announcements.

4 Press **TA/NEWS** while a traffic announcement is being received to cancel the announcement.

The tuner returns to the original source but remains in the standby mode until **TA/NEWS** is pressed again.

Notes

- You can also turn this function on or off in the menu that appears by using **MULTI-CONTROL**.
- The system switches back to the original source following traffic announcement reception.
- Only TP and enhanced other network's TP stations are tuned in during seek tuning or BSM when TA is on. 

Using PTY functions

You can tune in a station by using PTY (program type) information.

Searching for an RDS station by PTY information

You can search for general types of broadcasting programs, such as those listed in the following section. Refer to the next page.

1 Display the function menu.

Refer to *Introduction to advanced operations* on page 14.

2 Use **MULTI-CONTROL** to select PTY in the function menu.

3 Push **MULTI-CONTROL** left or right to select a program type.

News/Info—Popular—Classics—Others

4 Press **MULTI-CONTROL** to begin the search.

The unit searches for a station broadcasting that program type. When a station is found, its program service name is displayed.

PTY (program type ID code) information is listed in the following section. Refer to the next page.

- To cancel the search, press **MULTI-CONTROL** again.
- The program of some stations may differ from that indicated by the transmitted PTY.

- If no station is broadcasting the type of program you searched for, **Not found** is displayed for about two seconds and then the tuner returns to the original station.

Using news program interruption

When a news program is broadcast from a PTY code news station, the unit automatically switches to the news broadcast station. When the news program ends, reception of the previous program resumes.

● Press **TA/NEWS** and hold to turn on news program interruption.

Press **TA/NEWS** until **NEWS ON** appears in the display.

- To turn off news program interruption, press **TA/NEWS** and hold until **OFF** appears in the display.
- A news program can be canceled by pressing **TA/NEWS**.

Note

You can also turn on or off news programs in the menu that appears by using **MULTI-CONTROL**.

Using radio text

This tuner can display radio text data transmitted by RDS stations, such as station information, the name of the currently broadcast song and the name of the artist.

- The tuner automatically memorizes the three latest radio text broadcasts received, replacing text from the least recent reception with new text when it is received.

Displaying radio text

You can display the currently received radio text and the three most recent radio texts.

1 Press **DISP/SCRL** and hold to display radio text.

Radio text for the currently broadcasting station is displayed.

Tuner

- You can cancel radio text display by pressing **DISP/SCRL** or **BAND/ESC/CANCEL**.
- When no radio text is received, **NO TEXT** appears in the display.

2 Push **MULTI-CONTROL** left or right to recall the three most recent radio texts.

Pushing **MULTI-CONTROL** left or right switches between the current and the three radio text data displays.

- If there is no radio text data in memory the display will not change.

3 Push **MULTI-CONTROL** up or down to scroll.

Push **MULTI-CONTROL** up to go to the beginning. Push **MULTI-CONTROL** down to scroll the radio text data.

Storing and recalling radio text

You can store data from up to six radio text.

1 Display the radio text you want to store in memory.

Refer to *Displaying radio text* on the previous page.

2 Press /LIST.

Preset screen is displayed.

3 Use **MULTI-CONTROL** to store the selected radio text in memory.

Turn to change the preset number. Press and hold to store.

4 Use **MULTI-CONTROL** to select the desired radio text.

Turn to change the radio text. Press to select.

- You can also change the radio text by pushing **MULTI-CONTROL** up or down.
- To return to the ordinary display, press **BAND/ESC/CANCEL** or **LIST/**  .

PTY list

General	Specific	Type of program
News/Info	News	News
	Affairs	Current affairs
	Info	General information and advice
	Sport	Sports
	Weather	Weather reports/meteorological information
	Finance	Stock market reports, commerce, trading, etc.
Popular	Pop Mus	Popular music
	Rock Mus	Contemporary modern music
	Easy Mus	Easy listening music
	Oth Mus	Non-categorized music
	Jazz	Jazz
	Country	Country music
	Nat Mus	National music
	Oldies	Oldies, golden oldies
Classics	Folk mus	Folk music
	L. Class	Light classical music
	Classic	Classical music

Others	Educate	Educational programs
	Drama	Radio plays and serials
	Culture	National or regional culture
	Science	Nature, science and technology
	Varied	Light entertainment
	Children	Children's
	Social	Social affairs
	Religion	Religious affairs or services
	Phone In	Phone in
	Touring	Travel programs; not for traffic announcements
	Leisure	Hobbies and recreational activities
	Document	Documentaries



Built-in CD Player

Basic Operations

● Open the front panel

Press **!**.

Disc loading slot appears.

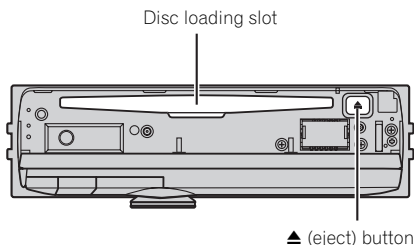

■ When loading a disc, face the label side of a disc up.

- To avoid a malfunction, make sure that no metal objects come into contact with the terminals when the front panel is open.

● Eject a disc

Press **▲** (eject).

● Select a folder

Push **MULTI-CONTROL** up or down.

- You cannot select a folder that does not have a compressed audio file recorded in it.

● Select a track

Push **MULTI-CONTROL** left or right.

● Fast forward or reverse

Push and hold **MULTI-CONTROL** left or right.

- When playing compressed audio, there is no sound on fast forward or reverse.

● Return to root folder

Press and hold **BAND/ESC/CANCEL**.

- If folder 01 (ROOT) contains no files, playback commences with folder 02.

● Switch between compressed audio and CD-DA

Press **BAND/ESC/CANCEL**.

- This operation is available only when playing CD-EXTRA or MIXED-MODE CDs.
- If you have switched between compressed audio and CD-DA, playback starts at the first track on the disc.

Notes

- The built-in CD player can play back audio CD and compressed audio recorded on a CD-ROM. (Please see the following section for files that can be played back. Refer to page 66.)
- Read the precautions for the player and discs in the following section. Refer to page 64.
- A disc has already been inserted, press **SRC/OFF** to select the built-in CD player.
- There is sometimes a delay between starting up disc playback and the sound being issued. When being read, **FORMAT READ** is displayed.
- If an error message is displayed, refer to *Error messages* on page 62.
- Playback is carried out in order of file number. Folders are skipped if they contain no files. (If folder 01 (ROOT) contains no files, playback commences with folder 02.)
- You can eject the CD by pressing and holding **▲** (eject) with eject position when the CD loading or ejecting cannot operate properly. **▣**

Displaying text information on disc

● Press **DISP/SCRL** to select the desired text information.

For title entered CD

Source name/play time—disc title/play time

For CD TEXT discs

Source name/play time—disc artist name/
track title—disc artist name/disc title—disc
title/track title—track artist name/track title—
track title/play time

For WMA/MP3/AAC

Source name/play time—folder name/file
name—artist name/track title—artist name/
album title—album title/track title—track title/
play time—comment/play time—bit rate/play
time

For WAV

Source name/play time—folder name/file
name—sampling frequency/play time

**Notes**

- You can scroll to the left of the title by pressing and holding **DISP/SCRL**.
- Audio CD that contains certain information such as text and/or number is CD TEXT.
- If specific information is not recorded on a disc, title or name is not displayed.
- If the characters recorded on the audio file are not compatible with this unit, those characters will not be displayed.
- The text information of some audio files may not be correctly displayed.
- Depending on the version of iTunes used to write MP3 files onto a disc, comment information may not be correctly displayed.
- Depending on the version of Windows Media™ Player used to encode WMA files, album names and other text information may not be correctly displayed.
- When playing back VBR (variable bit rate)-recorded files, **VBR** is displayed instead of bit rate value.
- The sampling frequency shown in the display may be abbreviated.
- When Ever Scroll is set to ON at the initial setting, text information scrolls continuously in the display. Refer to *Switching the ever scroll* on page 51.

Selecting tracks from the track title list

Track title list lets you see the list of track titles on a CD TEXT disc and select one of them to play back.

1 Press /LIST to switch to the track title list mode.

2 Use MULTI-CONTROL to select the desired track title.

Turn to change the track title. Press to play.

- You can also change the track title by pushing **MULTI-CONTROL** up or down.
- You can scroll to the left of the title by pressing and holding **DISP/SCRL**. To stop scrolling, press **DISP/SCRL**.

- To return to the ordinary display, press **BAND/ESC/CANCEL** or /LIST.

- If you do not operate the list within about 30 seconds, the display automatically returns to the ordinary display.

Selecting files from the file name list

File name list lets you see the list of file names (or folder names) and select one of them to playback.

1 Press /LIST to switch to the file name list mode.

Names of files and folders appear in the display.

2 Use MULTI-CONTROL to select the desired file name (or folder name).

Turn to change the name of file or folder.

- when a file is selected, press to play.
- when a folder is selected, press to see a list of files (or folders) in the selected folder.
- when a folder is selected, press and hold to play a song in the selected folder.

- You can also play the file by pushing **MULTI-CONTROL** right.

- You can also play a song in the selected folder by pushing and holding **MULTI-CONTROL** right.

- To return to the previous list (the folder one level higher), push **MULTI-CONTROL** left.

- To return to the ordinary display, press **BAND/ESC/CANCEL** or /LIST.

- If you do not operate the list within about 30 seconds, the display automatically returns to the ordinary display.

Introduction to advanced operations

1 Press MULTI-CONTROL to display the main menu.

Built-in CD Player

2 Use MULTI-CONTROL to select FUNCTION.

Turn to change the menu option. Press to select.

The function menu is displayed.

3 Turn MULTI-CONTROL to select the function.

Repeat (repeat play)—**Random** (random play)—**Scan** (scan play)—**Pause** (pause)—

S. Retriever (advanced sound retriever)—**Title input** (disc title input)

Notes

- To return to the ordinary display, press **BAND/ESC/CANCEL**.
- If you do not operate functions except for **Title input** within about 30 seconds, the display automatically returns to the ordinary display.
- When playing a compressed audio disc or CD TEXT disc, you cannot switch to disc title input display. 

Selecting a repeat play range

1 Display the function menu.

Refer to *Introduction to advanced operations* on the previous page.

2 Use MULTI-CONTROL to select Repeat in the function menu.

3 Press MULTI-CONTROL to select the desired setting.

- **Disc** – Repeat all tracks
- **Track** – Repeat the current track
- **Folder** – Repeat the current folder
- If you select another folder during repeat play, the repeat play range changes to disc repeat.
 - Performing track search or fast forward/reverse during **Track** (track repeat) changes the repeat play range to disc/folder.
 - When **Folder** (folder repeat) is selected, it is not possible to play back a subfolder of that folder. 

Playing tracks in random order

Tracks in a selected repeat range are played in random order.

● Press /iPod to turn random play on.

Tracks play in a random order.

- To turn random play off, press /iPod again.

Note

You can also turn this function on or off in the menu that appears by using **MULTI-CONTROL**. 

Scanning folders and tracks

Scan play searches the song within the selected repeat range.

1 Display the function menu.

Refer to *Introduction to advanced operations* on the previous page.

2 Use MULTI-CONTROL to select Scan in the function menu.

3 Press MULTI-CONTROL to turn scan play on.

The first 10 seconds of each track is played.

4 When you find the desired track press MULTI-CONTROL to turn scan play off.

- If the display has automatically returned to the playback display, select **Scan** again by using **MULTI-CONTROL**.
- After scanning of a disc (folder) is finished, normal playback of the tracks begins. 

Pausing playback

1 Display the function menu.

Refer to *Introduction to advanced operations* on the previous page.

2 Use MULTI-CONTROL to select Pause in the function menu.

3 Press MULTI-CONTROL to turn pause on.

Playback of the current track pauses.

- To turn pause off, press **MULTI-CONTROL** again. 

Using advanced sound retriever

Advanced sound retriever function automatically enhances compressed audio and restores rich sound.

● Press S.Rtrv repeatedly to select the desired setting.

OFF (off)—1—2

- 2 is more effective than 1.



Note

You can also perform this operation in the menu that appears by using **MULTI-CONTROL**. 

Entering disc titles

Use the disc title input feature to store up to 48 CD titles in the unit. Each title can be up to 10 characters long.

1 Display the function menu.

Refer to *Introduction to advanced operations* on page 20.

2 Play the CD that you want to enter a title for.

3 Use MULTI-CONTROL to select Title input in the function menu.

4 Press DISP/SCRL to select the desired character type.

Press **DISP/SCRL** repeatedly to switch between the following character types:

Alphabet (upper case), numbers and symbols
 —Alphabet (lower case)—European letters, such as those with accents (e.g. **á, à, ä, ç**)—
 Numbers and symbols

5 Push MULTI-CONTROL up or down to select a letter of the alphabet.

6 Push MULTI-CONTROL left or right to move the cursor to the previous or next character position.

7 Move the cursor to the last position by pushing MULTI-CONTROL right after entering the title.

When you push **MULTI-CONTROL** right one more time, the entered title is stored in memory.

8 Press BAND/ESC/CANCEL to return to the playback display.



Notes

- Titles remain in memory, even after the disc is removed from the unit, and are recalled when the disc is reinserted.
- After data for 48 discs are stored in the memory, data for a new disc overwrites the oldest one.
- If you connect a multi-CD player, you can input disc titles for up to 100 discs.
- When a multi-CD player that does not support disc title functions is connected, you cannot enter disc titles in this unit. 

Playing songs on USB storage device

For details about the supported device, refer to Specifications on page 68.

Basic Operations

● Select a folder

Push **MULTI-CONTROL** up or down.

● Fast forward or reverse

Push and hold **MULTI-CONTROL** left or right.

● Select a track

Push **MULTI-CONTROL** left or right.

● Return to root folder

Press and hold **BAND/ESC/CANCEL**.



Notes

- Optimum performance of this unit may not be obtained depending on the connected USB storage device.
- If folder 01 (ROOT) contains no files, playback commences with folder 02.
- When the USB portable audio player having battery charging function is connected to this unit and the ignition switch is set to ACC or ON, the battery is charged.
- You can disconnect the USB storage device anytime you want to finish listening to it.
- If you do not use an USB storage device, disconnect it from this unit.

Selecting files from the file name list

The operation is the same as that of the built-in CD player. (Refer to *Selecting files from the file name list* on page 20.)

Displaying text information of an audio file

The operation is the same as that of the built-in CD player.
Refer to *Displaying text information on disc* on page 19.

Introduction to advanced operations

1 Press MULTI-CONTROL to display the main menu.

2 Use MULTI-CONTROL to select FUNCTION.

Turn to change the menu option. Press to select.

The function menu is displayed.

3 Turn MULTI-CONTROL to select the function.

Repeat (repeat play)—**Random** (random play)—**Scan** (scan play)—**Pause** (pause)—**S. Retriever** (advanced sound retriever)

Function and operation

Repeat, Random, Scan, Pause and **S. Retriever** operations are basically the same as that of the built-in CD player.

Function name	Operation
Repeat	Refer to <i>Selecting a repeat play range</i> on page 21. However, the repeat play ranges you can select are different from that of the built-in CD player. The repeat play ranges of the USB portable audio player/USB memory are: <ul style="list-style-type: none"> • Track – Repeat just the current file • Folder – Repeat the current folder • All – Repeat all files
Random	Refer to <i>Playing tracks in random order</i> on page 21.
Scan	Refer to <i>Scanning folders and tracks</i> on page 21.
Pause	Refer to <i>Pausing playback</i> on page 21.
S. Retriever	Refer to <i>Using advanced sound retriever</i> on the previous page.

**Notes**

- To return to the ordinary display, press **BAND/ESC/CANCEL**.
- If you select another folder during repeat play, the repeat play range changes to **All**.
- If you perform track search or fast forward/reverse during **Track**, the repeat play range changes to **Folder**.
- When **Folder** is selected, it is not possible to play back a subfolder of that folder.
- After file or folder scanning is finished, normal playback of the files begins again. 

Playing songs on iPod

For details about the supported iPod, refer to iPod compatibility on page 65.

Basic Operations

● Fast forward or reverse

Push and hold **MULTI-CONTROL** left or right.

● Select a track (chapter)

Push **MULTI-CONTROL** left or right.



Notes

- When using an iPod, iPod Dock Connector to USB Cable (CD-IU50) is required.
- Read the precautions for iPod in the following section. Refer to page 65.
- If an error message is displayed, refer to *Error messages* on page 62.
- When the ignition switch is set to ACC or ON, the iPod's battery is charged while the iPod is connected to this unit.
- While the iPod is connected to this unit, the iPod cannot be turned on or off.
- Before connecting the dock connector of this unit to the iPod, disconnect the headphones from the iPod.
- The iPod is turned off about two minutes after the ignition switch is set to OFF.

Browsing for a song

Searching songs by category

Operations to control an iPod with this unit is designed to be as close to the iPod as possible to make operation and song search easy.

- Depending on the number of files in the iPod, there may be a delay when displaying a list.
- If the characters recorded on the iPod are not compatible with this unit, those characters are not displayed.

1 Press /LIST.

2 Use **MULTI-CONTROL** to select a category.

Turn to change the category. Press to select.

Playlists (playlists)/**Artists** (artists)—**Artists** (artists)/**Albums** (albums)—**Albums**(albums)/**Songs** (songs)—**Songs** (songs)/**Podcasts** (podcasts)—**Podcasts** (podcasts)/**Genres** (genres)—**Genres** (genres)/**Composers** (composers)—**Composers** (composers)/**Audiobooks** (audiobooks)—**Audiobooks** (audiobooks)/**Playlists** (playlists)

List for the selected category is displayed.

- You can start playback throughout the selected category by pressing and holding **MULTI-CONTROL**. You can also perform this operation by pushing and holding **MULTI-CONTROL** right.
- You can also change the category by pushing **MULTI-CONTROL** up or down.
- You can also select the category by pushing **MULTI-CONTROL** right.
- To return to the previous category, push **MULTI-CONTROL** left.

3 Repeat step 2 to find a song you want to listen to.

- To return to the top tier of categories, push and hold **MULTI-CONTROL** left.
- If you do not operate the list within about 30 seconds, the display automatically returns to the ordinary display.

Searching songs by alphabet

1 Press /LIST.

2 Use **MULTI-CONTROL** to select a category.

Turn to change the category. Press to select.

3 Press /LIST to switch to alphabet search mode.

4 Turn **MULTI-CONTROL** to select a letter of the alphabet.

5 Press **MULTI-CONTROL** to display the alphabetical list.

While searching, **Searching** flashes.

- If alphabet search fails, **NOT FOUND** is displayed.

Displaying text information on iPod

- Press **DISP/SCRL** to select the desired text information.

Source name/play time—artist name/song title—artist name/album name—album name/song title—song title/play time



Notes

- If the characters recorded on the iPod are not compatible with this unit, those characters are not displayed.
- You can scroll the text information to the left by pressing and holding **DISP/SCRL**.
- When Ever Scroll is set to ON at the initial setting, text information scrolls continuously in the display. Refer to *Switching the ever scroll* on page 51.

Introduction to advanced operations

1 Press MULTI-CONTROL to display the main menu.

2 Use MULTI-CONTROL to select FUNCTION.

Turn to change the menu option. Press to select.

The function menu is displayed.

3 Turn MULTI-CONTROL to select the function.

Repeat (repeat play)—**Shuffle** (shuffle)—**Shuffle all** (shuffle all)—**L.Play** (link play)—**Control** (control mode)—**Pause** (pause)—**Audiobook** (audiobook speed)—**S. Retriever** (advanced sound retriever)

Function and operation

Repeat, **Pause** and **S. Retriever** operations are basically the same as that of the built-in CD player.

Function name	Operation
Repeat	Refer to <i>Selecting a repeat play range</i> on page 21. However, the repeat play ranges you can select are different from that of the built-in CD player. The repeat play ranges of the iPod are: <ul style="list-style-type: none"> • One – Repeat the current song • All – Repeat all songs in the selected list
Pause	Refer to <i>Pausing playback</i> on page 21.
S. Retriever	Refer to <i>Using advanced sound retriever</i> on page 22.



Notes

- To return to the ordinary display, press **BAND/ESC/CANCEL**.
- If you do not operate functions within about 30 seconds, the display automatically returns to the ordinary display.
- When **Control** is set to **iPod**, only **Control**, **Pause** and **S. Retriever** can be operated.

Playing songs in a random order (shuffle)

1 Display the function menu.

Refer to *Introduction to advanced operations* on this page.

2 Use MULTI-CONTROL to select Shuffle in the function menu.

3 Press MULTI-CONTROL to select your favorite setting.

- **Songs** – Play back songs in the selected list in random order.
- **Albums** – Play back songs from a randomly selected album in order.
- **OFF** – Cancel random play.

Playing songs on iPod

Playing all songs in a random order (shuffle all)

- Press /iPod to turn shuffle all on.

All songs on the iPod play randomly.

- To turn shuffle all off, set **Shuffle** in the **FUNCTION** menu to off.



Note

You can also turn this function on in the menu that appears by using **MULTI-CONTROL**. 

Playing songs related to the currently playing song

Songs related to the currently playing song are played. You can play songs of the following lists.

- Album list of currently playing artist
- Song list of currently playing album
- Album list of currently playing genre
- Depending on the number of files in the iPod, there may be a delay when displaying a list.

- 1 Press and hold  /LIST to switch to the link play mode.

- 2 Use **MULTI-CONTROL** to select the desired mode.

Push **MULTI-CONTROL** left or right to change the mode; press to select.

- **Artists** – Plays the album of currently playing artist.
- **Albums** – Plays the song of currently playing album.
- **Genres** – Plays the album of currently playing genre.

Searching flashes while searching the list and then the playback of the list starts.

- If the related albums/songs are not found, **NOT FOUND** is displayed.



Note

You can also turn this function on in the menu that appears by using **MULTI-CONTROL**. 

Operating this unit's iPod function from your iPod

This function cannot be operated with the following iPod models.

- iPod nano first generation
- iPod fifth generation

This function cannot be performed with the iPod models other than listed above, even if this function can be controlled.

This unit's iPod function can be operated from your iPod. Sound can be heard from the car's speakers, and operation can be conducted from your iPod.

- While this function is in use, even if the ignition key is turned off, the iPod will not be turned off. To turn off power, operate the iPod.

- 1 Press /iPod and hold to switch the control mode.

Each pressing and holding /iPod switches the control mode as follows:

- **iPod** – This unit's iPod function can be operated from the connected iPod.
- **AUDIO** – This unit's iPod function can be operated from this unit.

- 2 When you select iPod, operate the connected iPod to select a song and play.

- Switching the control mode to **iPod** pauses song playback. Operate the iPod to start playback.
- Even if the control mode is set to **iPod**, following functions are available from this unit.
 - Volume
 - Fast forward/reverse
 - Track up/down
 - Pausing
 - Switching the text information



Notes

- You can also turn this function on or off in the menu that appears by using **MULTI-CONTROL**.
- When the control mode is set to **iPod**, operations are limited as follows:

Playing songs on iPod

- Functions other than **Control** (control mode), **Pause** (pause) and **S. Retriever** (advanced sound retriever) cannot be selected.
- The volume can only be controlled from this unit.
- Turning this function on pauses song playback. Operate the iPod to start playback.

Changing audiobook speed

While listening to an audiobook on iPod, playback speed can be changed.

1 Display the function menu.

Refer to *Introduction to advanced operations* on page 26.

2 Use MULTI-CONTROL to select Audiobook in the function menu.

3 Press MULTI-CONTROL to select your favorite setting.

- **Faster** – Playback faster than normal speed
- **Normal** – Playback in normal speed
- **Slower** – Playback slower than normal speed

Using Bluetooth wireless technology

Connecting a Bluetooth device

Before using the Bluetooth audio player and Bluetooth telephone, you need to connect Bluetooth device to this unit. Please read the following section and connect correctly.

If you use Bluetooth device with this unit for the first time, read the following section.

- *Using a Bluetooth device to pair* on the next page
- *Pairing from this unit* on the next page

If your Bluetooth device has already been paired, read the following section.

- *Connecting a paired Bluetooth device and selecting a service* on page 31

If your Bluetooth device needs to be disconnected from this unit, read the following section.

- *Disconnecting a Bluetooth device* on page 31

Also, you can use other convenient functions listed below. You can use these functions when needed.

- *Deleting a paired Bluetooth device* on page 31
- *Connecting a paired Bluetooth device and selecting a service* on page 31
- *Connecting to a Bluetooth device automatically* on page 32
- *Displaying system version for repair* on page 32
- *Displaying BD (Bluetooth Device) address* on page 32
- *Editing device name* on page 32
- *Entering PIN code for Bluetooth wireless connection* on page 33



Note

Before you can use the devices featuring Bluetooth wireless technology, you may need to enter the PIN code into this unit. If your device requires a PIN code to establish a connection, look for the

code on the device or in its accompanying documentation. Refer to *Entering PIN code for Bluetooth wireless connection* on page 33.

Introduction to connection operations

1 Select BT AUDIO or TELEPHONE as a source.

To select **BT AUDIO**, press **SRC/OFF**.
To select **TELEPHONE**, press and hold **PHONE**//BT MENU.

2 Press MULTI-CONTROL to display the main menu.

3 Use MULTI-CONTROL to select CONNECTION.

Turn to change the menu option. Press to select.
The connection menu is displayed.

4 Turn MULTI-CONTROL to select the function.

Open device (open a connection to the device)—**Search device** (search device)—**DisconnectDevice** (disconnect device)—**Delete device** (delete device)—**Paired device** (service setting)—**Auto connect** (automatic connection setting)—**BT Version INFO** (version information)—**Device INFO** (device information)—**Device edit** (editing the device name)—**Pin code input** (pin code input)



Notes

- If a Bluetooth device is not connected to this unit yet, **DisconnectDevice** function is not available.
- If a Bluetooth device is not paired with this unit yet, **Delete device** and **Paired device** function is not available.
- To return to the ordinary display, press **BAND/ESC/CANCEL**.

Using Bluetooth wireless technology

- If you do not operate functions except for **Open device**, **Search device**, **DisconnectDevice**, **Device edit** and **Pin code input** within about 30 seconds, the display automatically returns to the ordinary display.
- If you do not operate **Open device** and **Search device** within 30 seconds after the Bluetooth device is paired, the display automatically returns to the ordinary display. If you do not operate within 30 seconds after **Disconnected** is displayed, the display automatically returns to the ordinary display.

Using a Bluetooth device to pair

1 Display the connection menu.

Refer to *Introduction to connection operations* on the previous page.

2 Turn MULTI-CONTROL to select Open device.

- If there is previous connection log in this unit, you can select the Bluetooth device from **Paired device**.

Refer to *Connecting a paired Bluetooth device and selecting a service* on the next page.

3 Push MULTI-CONTROL up or down to select the special device.

- Bluetooth devices that are difficult to establish connection is called special device. If your Bluetooth device is listed in the special device, select the appropriate one.

4 Press MULTI-CONTROL to open the connection.

Ready will be displayed.

This unit is now on standby for connection from Bluetooth device.

- If five devices are already paired, **MEMORY FULL** is displayed and it is not possible to perform the pairing operation. In this case, delete a paired device first. Refer to *Deleting a paired Bluetooth device* on the next page.

- Push **MULTI-CONTROL** left or right to display the device name, BD address and PIN code of this unit.

5 Use your Bluetooth device to establish connection.

Connection method is different depending on the Bluetooth device. See the manual of your Bluetooth device to establish connection. When the connection is established, **Paired** is displayed.

- If the connection fails, **ERROR** is displayed. In this case, try again from the beginning.
- PIN code is set to **0000** as the default. You can change this code in the initial setting. Refer to *Entering PIN code for Bluetooth wireless connection* on page 33.

Pairing from this unit

1 Display the connection menu.

Refer to *Introduction to connection operations* on the previous page.

2 Use MULTI-CONTROL to select Search device.

3 Push MULTI-CONTROL up or down to select a device.

4 Press MULTI-CONTROL to start searching.

While searching, **Searching** flashes. When available Bluetooth devices are found, device name or BD address (if names cannot be obtained) is displayed.

- To cancel searching, press **MULTI-CONTROL** again.
- If five devices are already paired, **MEMORY FULL** is displayed and it is not possible to perform the pairing operation. In this case, delete a paired device first. Refer to *Deleting a paired Bluetooth device* on the next page.
- If no device can be found, **Not found** is displayed. In this case, check the status of Bluetooth device and search again.

Using Bluetooth wireless technology

5 Push MULTI-CONTROL up or down to select a device name you want to connect.

- If only one device was found, this step cannot be performed.
- Push **MULTI-CONTROL** left or right to display the device name and BD address.

6 Press MULTI-CONTROL to establish connection.

While connecting, **Pairing** flashes. If the connection is established, **Paired** is displayed.

- If the connection fails, **ERROR** is displayed. In this case, try again from the beginning.
- PIN code is set to **0000** as the default. You can change this code in the initial setting. Refer to *Entering PIN code for Bluetooth wireless connection* on page 33.

Disconnecting a Bluetooth device

This function can be operated only when the Bluetooth wireless connection is being established.

1 Display the connection menu.

Refer to *Introduction to connection operations* on page 29.

2 Use MULTI-CONTROL to select DisconnectDevice.

3 Push MULTI-CONTROL up or down to select a device.

- If only one device was found, this step cannot be performed.

4 Press MULTI-CONTROL to disconnect the Bluetooth wireless connection.

While disconnecting, **Disconnecting** flashes. If the Bluetooth wireless connection is terminated, **Disconnected** is displayed.

- If multiple Bluetooth devices have been connected and you wish to disconnect them, press **MULTI-CONTROL** and then select the device. In this case, repeat operation from step 3.

Deleting a paired Bluetooth device

1 Display the connection menu.

Refer to *Introduction to connection operations* on page 29.

2 Use MULTI-CONTROL to select Delete device.

3 Push MULTI-CONTROL up or down to select a device.

- If only one device was found, this step cannot be performed.
- Push **MULTI-CONTROL** left to display the BD address.
- If device name cannot be obtained, BD address is displayed.

4 When the device name is being displayed, push MULTI-CONTROL right to display Delete YES.

Deleting device is now on standby.

- If you do not want to delete the device, push **MULTI-CONTROL** left.

5 Press MULTI-CONTROL to delete the device.

While deleting, **Deleting** flashes. After the device is deleted, **Deleted** is displayed.

Connecting a paired Bluetooth device and selecting a service

Bluetooth service of the paired device can be selected. You can choose a Bluetooth service from **PHONE** service, **AVRCP** service or **A2DP** service.

1 Display the connection menu.

Refer to *Introduction to connection operations* on page 29.

2 Use MULTI-CONTROL to select Paired device.

3 Push MULTI-CONTROL up or down to select a device.

- If only one device was found, this step cannot be performed.

Using Bluetooth wireless technology

- Push **MULTI-CONTROL** left or right to switch the BD address and device name.
- If device name cannot be obtained, BD address is displayed.

4 Press MULTI-CONTROL to display the service select screen.

5 Push MULTI-CONTROL up or down to select the service.

PHONE—AVRCP—A2DP

- “✱” is displayed on the connected service.
- Profile that is not compatible with the connected device cannot be selected.

6 Press MULTI-CONTROL to start or stop the selected service.

Connecting to a Bluetooth device automatically

It is possible to set the automatic connection between your Bluetooth device and this unit. If this function is set to on, connection between your Bluetooth device and this unit will take place automatically as soon as the two devices are less than a few meters apart.

- Initially, this function is set to on.

1 Display the connection menu.

Refer to *Introduction to connection operations* on page 29.

2 Use MULTI-CONTROL to select Auto connect.

3 Press MULTI-CONTROL to turn automatic connection on.

If your Bluetooth device is ready for Bluetooth wireless connection, connection to this unit is automatically established.

- While using Bluetooth audio player in A2DP, it is not possible to connect the Bluetooth telephone automatically.
- To turn automatic connection off, press **MULTI-CONTROL** again.

Displaying system version for repair

Should this unit fails to operate properly and you consult your dealer for repair, you may be asked to indicate the system versions of this unit and of Bluetooth module. You can display the versions and confirm them.

1 Display the connection menu.

Refer to *Introduction to connection operations* on page 29.

2 Use MULTI-CONTROL to select BT Version INFO.

The system (microprocessor) version of this unit is displayed.

3 Push MULTI-CONTROL left to switch to the version of the Bluetooth module of this unit.

- Pushing **MULTI-CONTROL** right returns to the system version of this unit.

Displaying BD (Bluetooth Device) address

This unit displays the BD address of this unit.

1 Display the connection menu.

Refer to *Introduction to connection operations* on page 29.

2 Use MULTI-CONTROL to select Device INFO in the function menu.

3 Push MULTI-CONTROL left to switch to the BD address.

12-digit hexadecimal string is displayed.

- Pushing **MULTI-CONTROL** right returns to the device name.

Editing device name

You can edit the device name.

The device name is set to **DEH-P7100BT** as default.

Using Bluetooth wireless technology

1 Display the connection menu.

Refer to *Introduction to connection operations* on page 29.

2 Use MULTI-CONTROL to select Device edit.

3 Push MULTI-CONTROL up or down to select a letter of the alphabet.

- Device name can be up to 32 characters long.

4 Push MULTI-CONTROL left or right to move the cursor to the previous or next character position.

5 After editing device name, press MULTI-CONTROL to store in this unit.

Entering PIN code for Bluetooth wireless connection

To connect your Bluetooth device to this unit via Bluetooth wireless technology, you need to enter PIN code on your Bluetooth device to verify the connection. The default code is **0000**, but you can change this in this function.

- With some Bluetooth devices, you don't need to enter the PIN code.

1 Display the connection menu.

Refer to *Introduction to connection operations* on page 29.

2 Use MULTI-CONTROL to select Pin code input.

3 Push MULTI-CONTROL up or down to select a number.

4 Push MULTI-CONTROL left or right to move the cursor to the previous or next position.

5 After inputting PIN code (up to 16 digits), press MULTI-CONTROL to store in this unit.

- Pushing **MULTI-CONTROL** right in the confirmation display returns you to the PIN code input display, and you can change the PIN code.

- If an invalid character has been entered, subsequent characters are not displayed.
- If an invalid character has been entered in the beginning, PIN code cannot be stored in memory. 

Bluetooth Audio

Important

- Depending on the Bluetooth audio player connected to this unit, the operations available with this unit are limited to the following two levels:
 - A2DP profile (Advanced Audio Distribution Profile): Only playing back songs on your audio player is possible.
 - AVRCP profile (Audio/Video Remote Control Profile): Playing back, pausing, selecting songs, etc., are possible.
- Since there are a number of Bluetooth audio players available on the market, operations with your Bluetooth audio player using this unit vary extensively. Refer to the instruction manual that came with your Bluetooth audio player as well as this manual while operating your player on this unit.
- Information about songs (e.g. the elapsed playing time, song title, song index, etc.) cannot be displayed on this unit.
- While you are listening to songs on your Bluetooth audio player, refrain from using on your cellular phone as much as possible. If you use your cellular phone, the signal from your cellular phone may cause noise on the song playback.
- When you are talking on a cellular phone connected to this unit via Bluetooth wireless technology, song playback from your Bluetooth audio player connected to this unit is muted.
- While using Bluetooth audio player, automatic connection of Bluetooth telephone cannot be performed.
- Even if you are listening to a song on your Bluetooth audio player and you switch to another source, song playback continues.

Using Bluetooth wireless technology

Even though your audio player does not contain a Bluetooth module, you can still control it from this unit via Bluetooth wireless technology using a Bluetooth adapter (sold separately).

Setting up for Bluetooth audio

Before you can use the Bluetooth audio function you must set up the unit for use with your Bluetooth audio player. This entails establishing a Bluetooth wireless connection between this unit and your Bluetooth audio player, and pairing your Bluetooth audio player with this unit.

● Connecting and pairing

For detailed instructions on connecting your phone to this unit via Bluetooth wireless technology, see following section. *Connecting a Bluetooth device* on page 29.

Basic Operations

● Fast forward or reverse

Push and hold **MULTI-CONTROL** left or right.

● Select a track

Push **MULTI-CONTROL** left or right.

● Starting playback

Press **BAND/ESC/CANCEL**.

Introduction to advanced operations

1 Press MULTI-CONTROL to display the main menu.

2 Use MULTI-CONTROL to select FUNCTION.

Turn to change the menu option. Press to select.

The function menu is displayed.

3 Turn MULTI-CONTROL to select the function.

Play (play)—**Stop** (stop)—**Pause** (pause)



Notes

- To return to the ordinary display, press **BAND/ESC/CANCEL**.
- If you do not operate functions within about 30 seconds, the display automatically returns to the ordinary display.

Function and operation

Pause is the same as that of the built-in CD player.

Function name	Operation
Pause	Refer to <i>Pausing playback</i> on page 21.

Playing songs on a Bluetooth audio player

1 Display the function menu.

Refer to *Introduction to advanced operations* on this page.

2 Use MULTI-CONTROL to select Play in the function menu.

3 Press MULTI-CONTROL to start playback.

Stopping playback

1 Display the function menu.

Refer to *Introduction to advanced operations* on this page.

2 Use MULTI-CONTROL to select Stop in the function menu.

3 Press MULTI-CONTROL to stop the playback. 

Using Bluetooth wireless technology

Bluetooth Telephone

Important

- Since this unit is on standby to connect with your cellular phone via Bluetooth wireless technology, using this unit without running the engine can result in battery drainage.
- Advanced operations that require your attention such as dialing numbers on the monitor, using phone book, etc., are prohibited while you are driving. When you need to use these advanced operations, stop your vehicle in a safe place.
- Depending on the cellular phone connected to this unit, the operations available with this unit may be limited.

Setting up for hands-free phoning

Before you can use the hands-free phoning function you must set up the unit for use with your cellular phone. This entails establishing a Bluetooth wireless connection between this unit and your phone, pairing your phone with this unit, adjusting the volume level and adjusting the microphone angle.

1 Connecting and pairing

For detailed instructions on connecting your phone to this unit via Bluetooth wireless technology, see following section. *Connecting a Bluetooth device* on page 29.

2 Volume adjustment

Adjust the earpiece volume on your cellular phone for comfort. When adjusted, the volume level is recorded in this unit as the default setting.

- Caller's voice volume and ring volume may vary depending on the type of cellular phone.
- If the difference between the ring volume and caller's voice volume is big, overall volume level may become unstable.
- Before disconnecting the cellular phone from this unit, make sure to adjust the volume to a proper level. If the volume is muted (zero level) on your cellular phone, the volume level of your cel-

lular phone remains muted even after the cellular phone is disconnected.

3 Microphone angle adjustment

The microphone needs to be pointed toward the person speaking.

Making a phone call

Dial a number

The most basic way to make a call is to simply dial the number.

For detailed instructions, refer to *Making a call by entering phone number* on page 39.

Calling a number in the Phone Book or the Call History

For detailed instructions, refer to *Calling a number in the phone book* on the next page and *Using the missed, received and dialed call lists* on page 37.

Voice recognition

If your cellular phone features voice recognition technology, you can make a call by voice commands.

- Operation varies depending on the type of cellular phone. Refer to the instruction manual that came with your cellular phone for detailed instructions.

1 Press BAND/ESC/CANCEL and hold until Voice dial appears in the display.

When **Voice dial ON** is displayed, voice recognition function is ready.

- If your cellular phone does not feature voice recognition function, **NO VOICE DIAL** appears in the display and operation is not possible.

2 Pronounce the name of your contact.

Using Bluetooth wireless technology

Taking a phone call

Answering or rejecting an incoming call

- **Answering an incoming call**

When a call comes in, press **MULTI-CONTROL**.

- **End a call**

Press **PHONE/☎/BT MENU**.

- **Rejecting an incoming call**

When a call comes in, press **PHONE/☎/BT MENU**.



Note

The estimated call time appears in the display (this may differ slightly from the actual call time).

Operating a call waiting

- **Answering a call waiting**

When a call comes in, press **MULTI-CONTROL**.

- **End all calls**

Press **PHONE/☎/BT MENU**.

- **Switch between callers on hold**

Press **MULTI-CONTROL**.

- **Rejecting call waiting**

Press **PHONE/☎/BT MENU**.



Notes

- To end the call, both you and your caller need to hang up the phone.
- While in standby mode, you can recall **Phone book** by pushing **MULTI-CONTROL** down.
- While in standby mode, you can recall **Missed calls** by pushing **MULTI-CONTROL** up.
- While in standby mode, you can recall **Dialed calls** by pushing **MULTI-CONTROL** right.

- While in standby mode, you can recall **Received calls** by pushing **MULTI-CONTROL** left.

Using the phone number list



Important

- Be sure to park your vehicle and apply the parking brake when operating the list.
- List can be called up from all sources. The methods to call up the list are different by the source.

1 Press PHONE/☎/BT MENU to switch to the phone number list mode.

2 Use MULTI-CONTROL to select a category.

Phone book (phone book list)—**Missed calls** (missed call list)—**Dialed calls** (dialed call list)—**Received calls** (received call list)

- For more detailed information about **Phone book**, see the following section. *Calling a number in the phone book* on this page.
- For more detailed information about **Missed calls**, **Dialed calls** and **Received calls**, see the following section. *Using the missed, received and dialed call lists* on the next page.
 - The name in the **Phone book**, **Missed calls**, **Dialed calls** or **Received calls** selected with the cursor is on for 2 seconds or longer is read out.

Calling a number in the phone book

While this unit and your cellular phone are being connected, the phone book of this unit is automatically synchronized with that of the cellular phone. However, the synchronization may not be performed depending on the type of cellular phone. In this case, you will need to set up the phone book manually. To set up the phone book, see the following section. *Transferring entries to the phone book* on page 38.

Using Bluetooth wireless technology

After finding the number you want to call in the phone book, you can select the entry and make the call.

1 Press **PHONE/☎/BT MENU** to switch to the phone number list mode.

- If **TELEPHONE** is selected as the source, press **☰/LIST** to switch to the phone number list mode.

2 Use **MULTI-CONTROL** to select **Phone book**.

Turn to change the menu option. Press to select.

3 Turn **MULTI-CONTROL** to select the first letter of the name you are looking for.

- You can also perform the same operation by pushing **MULTI-CONTROL** up or down.

To change the character, press **DISP/SCRL**. Pressing **DISP/SCRL** switches the character in the following order.

Alphabet—Russian—Greek

- The order of the first name and last name may be different from that of the cellular phone.

4 Press **MULTI-CONTROL** to display entries.

The display shows the first three Phone Book entries starting with that letter (e.g. “Ben”, “Brian” and “Burt” when “B” is selected).

5 Turn **MULTI-CONTROL** to select a phone book entry you want to call.

- You can also perform the same operation by pushing **MULTI-CONTROL** up or down.

6 Press **MULTI-CONTROL** to display the phone number list of the selected entry.

- You can also display the phone number list of the selected entry by pushing **MULTI-CONTROL** right.
- You can scroll literal information by pressing and holding **DISP/SCRL**. To stop scrolling, press **DISP/SCRL**.
- If several phone numbers are included in an entry, select one by turning **MULTI-CONTROL**.

- If you want to go back and select another entry, push **MULTI-CONTROL** left.

7 Press **MULTI-CONTROL** to make a call.

8 To end the call, press **PHONE/☎/BT MENU**.

Using the missed, received and dialed call lists

The 80 most recent calls dialed, received, and missed are stored in memory. You can browse them and call numbers from these lists.

1 Press **PHONE/☎/BT MENU** to switch to the phone number list mode.

- If **TELEPHONE** is selected as the source, press **☰/LIST** to switch to the phone number list mode.

2 Use **MULTI-CONTROL** to select **Missed calls, Dialed calls or Received calls**.

Turn to change the menu option. Press to select.

3 Turn **MULTI-CONTROL** to select a phone number.

Turning **MULTI-CONTROL** to change the phone numbers stored in the list.

- You can also change the phone number by pushing **MULTI-CONTROL** up or down.

4 Press **MULTI-CONTROL** to display the detailed list.

Name and phone number are displayed in the detailed list.

- You can also display the detailed list by pushing **MULTI-CONTROL** right.
- You can scroll literal information by pressing and holding **DISP/SCRL**. To stop scrolling, press **DISP/SCRL**.
- Turning **MULTI-CONTROL** switches to the previous or next phone number displayed in the detailed list.
- If you do not operate anything within about 30 seconds, the list display is canceled automatically.

Using Bluetooth wireless technology

5 Press **MULTI-CONTROL** to make a call.

6 To end the call, press **PHONE/☎/BT MENU**.

Introduction to advanced operations

1 Press and hold **PHONE/☎/BT MENU** to select **TELEPHONE** as the source.

2 Press **MULTI-CONTROL** to display the main menu.

3 Use **MULTI-CONTROL** to select **FUNCTION**.

The function menu is displayed.

Turn to change the menu option. Press to select.

4 Turn **MULTI-CONTROL** to select the function.

PH BTransfer (phone book transfer)—

Auto answer (automatic answer setting)—

Far end Volume (Adjust the intended party's listening volume)—**Ring tone** (ring tone select)—

Number dial (call by entering number)—

SCO Private mode (private mode)



Notes

- To return to the playback display, press **BAND/ESC/CANCEL**.
- If you do not operate functions other than **PH BTransfer**, and **Number dial** within about 30 seconds, the display automatically returns to the ordinary display.
- You can operate **SCO Private mode** only while talking on the phone.
- If Bluetooth telephone is not connected to this unit, **Number dial** cannot be operated.

Transferring entries to the phone book

Phone books in your cellular phone can be transferred to this unit by using your cellular phone.

- 1 000 entries for each user (max. 5 devices) can be stored in the phone book. Each independent entry can hold five phone numbers and genres.

1 Display the function menu.

Refer to *Introduction to advanced operations* on this page.

2 Use **MULTI-CONTROL** to select **PH BTransfer**.

3 Press **MULTI-CONTROL** to enter the phone book transfer standby mode.

4 Use the cellular phone to perform phone book transfer.

Perform phone book transfer using the cellular phone. For detailed instructions, refer to the instruction manual that came with your cellular phone.

When phone book transfer is completed,

Data transferred is displayed.

- The display indicates how many entries have been transferred and the total number to be transferred.

Setting automatic answering

1 Display the function menu.

Refer to *Introduction to advanced operations* on this page.

2 Use **MULTI-CONTROL** to select **Auto answer**.

3 Press **MULTI-CONTROL** to turn automatic answering on.

- To turn automatic answering function off, press **MULTI-CONTROL** again.

Adjusting the intended party's listening volume

To maintain the good speech quality, this unit can adjust the intended party's listening volume. If the volume is not enough for intended party, adjust this function.

Using Bluetooth wireless technology

1 Display the function menu.

Refer to *Introduction to advanced operations* on the previous page.

2 Use MULTI-CONTROL to select Far end Volume.

3 Push MULTI-CONTROL left or right to select the desired setting.

1—2—3—4—5

- This function can be performed even while talking on the phone.
- Settings can be stored for each device.

Switching the ring tone

You can select whether to use this unit's ring tone or not. If this function is set to on, ring tone from this unit will sound.

1 Display the function menu.

Refer to *Introduction to advanced operations* on the previous page.

2 Use MULTI-CONTROL to select Ring tone.

3 Press MULTI-CONTROL to turn ring tone on.

To turn ring tone off, press MULTI-CONTROL again.

Making a call by entering phone number

Important

Be sure to park your vehicle and apply the parking brake when performing this operation.

1 Display the function menu.

Refer to *Introduction to advanced operations* on the previous page.

2 Use MULTI-CONTROL to select Number dial.

3 Push MULTI-CONTROL up or down to select a number.

4 Push MULTI-CONTROL left or right to move the cursor to the previous or next position.

- Up to 32 digits can be entered.

5 When you finish entering the number, press MULTI-CONTROL.

Call confirmation appears.

6 Press MULTI-CONTROL again to make a call.

7 To end the call, press PHONE//BT MENU.

Setting the private mode

During a conversation, you can switch to private mode (talking directly on your cellular phone).

1 Display the function menu.

Refer to *Introduction to advanced operations* on the previous page.

2 Use MULTI-CONTROL to select SCO Private mode.

3 Press MULTI-CONTROL to turn private mode on.

To turn private mode off, press MULTI-CONTROL again. 

Using voice recognition to operate this unit



Important

In this section, voice recognition operation is illustrated in English. For about languages other than English, please refer to enclosed command list. Also, supported commands are shown in the list.

You can use voice recognition to perform operations such as the following.

- Input a phone number, and make a call.
- Input a name stored in the phonebook and make a call.
- Input a name and type stored in the phonebook, and make a call.
- Access Help.
- Perform voice recognition again.

1 Press VOICE/☞ to start voice recognition.

The audio sound is muted, and a beep tone sounds.

2 When you hear Voice Command, please, and a beep tone, say a voice command.

3 Perform the operation in accordance with the voice guidance.



Notes

- To cancel voice recognition partway through, say **cancel** or **abort** or press **SRC/OFF**, **BAND/ESC/CANCEL**, or **⏏**.
- When you want to return to the state immediately after voice recognition was started, say **Restart** after you hear the beep tone to return to the state of Step 2.
- If a voice command is said incorrectly, an error occurs and the unit waits for a voice command to be said. Say a correct voice command.

- If you are unsure of a voice command, say **Help** or **What can I say?** to play the help voice guidance.
- Voice recognition is possible when any of the sources is selected, but a call can only be made when a cellular phone is connected. Refer to page 29, and check whether a cellular phone is connected to this unit correctly. If a voice command is said when no cellular phone is connected, an error occurs and the unit waits for a voice command to be said. Connect a cellular phone and say a correct voice command.
- For a list of voice commands, refer to the next page.
- When no voice command is spoken for 8 seconds, a beep tone and **cancel** is heard, and voice recognition returns to the ordinary display.
- Operation varies depending on the type of cellular phone. Refer to the instruction manual that came with your cellular phone for detailed instructions.
- If the language is set to **РУССКИЙ** in the **Language select**, voice guidance cannot be performed.

Using voice recognition to make a call

You can use voice recognition to make a call. This explanation uses the example of making a call to **0123456789**.

1 Start voice recognition.

Refer to *Using voice recognition* on this page.

2 Say Dial 0123456789.

3 Say Dial.

4 A call is made to the number read out.

Using voice recognition

Notes

- A phone number of up to 30 digits long can be read out. If a phone number that exceeds 30 digits is input, an error occurs and the unit waits for a voice command to be said. Say a correct voice command.
- You can also input a phone number in parts. When inputting **01234** and **56789** separately, say the next part of the number (**56789**) after you hear **01234 Please complete the number. Otherwise say "Dial" or "Correction"**.
- When you want to correct a phone number, say **Correction** and then say the correct phone number after you hear the beep tone. When you are inputting a phone number in parts, you can correct the part of the number you said last. If you input **55555** when you should have input **56789**, say **Correction** when you hear **Please complete the number. Otherwise say "Dial" or "Correction"**., and then say the correct number. 

Making a call to a phone number in memory

You can also use voice recognition to make a call to a phone number stored in the memory. This explanation uses the example of making a call to the cellular phone of **Sandy Jones**.

1 Start voice recognition.

Refer to *Using voice recognition* on the previous page.

2 Say Call Sandy Jones.

You will hear **On which number do you want to call <name>, <type>.**, and then a beep tone.

- In the case of when there is only one phone number corresponding to the registered name (**Call Sandy Jones**), say **Dial** to make the phone call.

3 Say mobile.

4 If the read out name (Sandy Jones) and type (mobile) are correct, say Yes after you hear the beep tone.

5 A call is made to the number read out.

Notes

- Saying **Call Sandy Jones mobile** in Step 1 allows you to specify the name and type in one go.
- If a type that is not registered is specified when a type is specified, an error occurs and the unit waits for a voice command to be said. Say a correct voice command. 

If you become unsure of an operation:

If you become unsure of a voice command partway through an operation, access the help.

1 Start voice recognition.

Refer to *Using voice recognition* on the previous page.

2 Say Help or What can I say?

3 The help voice guidance plays, and the voice commands you can use are pronounced. 

Voice command list

Command Type	Operation
Dial (number)	Use this when you want to directly specify a phone number. A number of up to 32 digits can be read out.
(Number)	Use this when you want to specify a number to add to the number specified with Dial (number) . (You can also specify a phone number in parts.) <ul style="list-style-type: none"> • 0 to 9, *, # and + can be entered.

Using voice recognition

Call (name) (+type)	Use this when you want to specify a "name" in a registered phonebook entry, or specify both a "name" and "type" in a registered phonebook entry. <ul style="list-style-type: none"> • On mobile phone, at home, at work, default or other can be entered.
(Type)	Use this when you want to specify a "type" for a "name" in a registered phonebook entry.
Dial	Confirm whether to make the call when a call is specified with a number. Saying Dial starts the call operation.
Yes Confirm	Confirm whether to make the call when a call is specified with other than a number (name, type, etc.). Saying Yes starts the call operation.
Correction	Correct the read out phone number.
Help What can I say	Obtain guidance on what operations are possible with the current voice recognition.
Restart	Restores the voice recognition start state.
Cancel Abort	Ends voice recognition.
zero	0 can be entered.
one	1 can be entered.
two	2 can be entered.
three	3 can be entered.
four	4 can be entered.
five	5 can be entered.
six	6 can be entered.
seven	7 can be entered.
eight	8 can be entered.
nine	9 can be entered.
star	* can be entered.
hash	# can be entered.
plus	+ can be entered.



Audio Adjustments

Introduction of audio adjustments

1 Press MULTI-CONTROL to display the main menu.

2 Use MULTI-CONTROL to select AUDIO.
Turn to change the menu option. Press to select.
The audio menu is displayed.

3 Turn MULTI-CONTROL to select the audio function.

Turn **MULTI-CONTROL** to switch between the audio functions in the following order.
FAD BAL (balance adjustment)—**Powerful** (graphic equalizer adjustment)—**50Hz** (7-band graphic equalizer adjustment)—**Loudness** (loudness)—**Sub W1** (subwoofer on/off setting)—**Sub W2** (subwoofer setting)—**Bass** (bass boost)—**HPF** (high pass filter)—**SLA** (source level adjustment)—**ASL** (automatic sound levelizer)—**Guidance VOL** (voice guidance volume adjustment)

- You can select the **Sub W2** only when subwoofer output is turned on in **Sub W1**.
- When selecting FM as the source, you cannot switch to **SLA**.
- If **Language select** (language selection) is set to **РУССКИЙ**, **Guidance VOL** cannot be adjusted.
- If **TELEPHONE** is selected as a source, only **FAD BAL** (balance adjustment) and **Guidance VOL** (guidance volume) can be operated.
- To return to the display of each source, press **BAND/ESC/CANCEL**.
- If you do not operate functions except for **50Hz** within about 30 seconds, the display is automatically returned to the ordinary display. 

Using balance adjustment

You can change the fader/balance setting so that it can provide the ideal listening environment in all occupied seats.

1 Display the audio menu.

Refer to *Introduction of audio adjustments* on this page.

2 Use MULTI-CONTROL to select FAD BAL in the audio function menu.

3 Push MULTI-CONTROL up or down to adjust front/rear speaker balance.

Each time **MULTI-CONTROL** is pushed up or down, the front/rear speaker balance moves towards the front or rear.

FAD F15 to **FAD R15** is displayed as the front/rear speaker balance moves from front to rear.

- **FAD 0** is the proper setting when only two speakers are used.
- When the rear output setting is **Sub W**, you cannot adjust front/rear speaker balance. Refer to *Setting the rear output and subwoofer output* on page 50.

4 Push MULTI-CONTROL left or right to adjust left/right speaker balance.

Each time **MULTI-CONTROL** is pushed left or right, the left/right speaker balance moves towards the left or right.

BAL L15 to **BAL R15** is displayed as the left/right speaker balance moves from left to right. 

Using the equalizer

The equalizer lets you adjust the equalization to match the car's interior acoustic characteristics as desired.

Recalling equalizer curves

There are seven stored equalizer curves which you can easily recall at any time. Here is a list of the equalizer curves.

Display	Equalizer curve
Powerful	Powerful
Natural	Natural
Vocal	Vocal

Custom1	Custom 1
Custom2	Custom 2
Flat	Flat
Super Bass	Super bass

- **Custom1** and **Custom2** are adjusted equalizer curves that you create. Adjustments can be made with a 7-band graphic equalizer.
- When **Flat** is selected, no supplement or correction is made to the sound. This is useful to check the effect of the equalizer curves by switching alternatively between **Flat** and a set equalizer curve.

1 Display the audio menu.

Refer to *Introduction of audio adjustments* on the previous page.

2 Use MULTI-CONTROL to select the graphic equalizer adjustment.

Powerful appears in the display.

If the equalizer curve has been previously selected, the curve of that previously selected will be displayed instead of **Powerful**.

3 Push MULTI-CONTROL left or right to select an equalizer curve.

Each time **MULTI-CONTROL** is pushed left or right, equalizer curves are selected in the following order:

Powerful—Natural—Vocal—Custom1—Custom2—Flat—Super Bass

Adjusting equalizer curves

The factory supplied equalizer curves, with the exception of **Flat**, **Custom1** and **Custom2** can be adjusted to a fine degree (nuance control).

1 Recall the equalizer curve you want to adjust.

Refer to *Recalling equalizer curves* on the previous page.

2 Push MULTI-CONTROL up or down to adjust the equalizer curve.

Each time **MULTI-CONTROL** is pushed up or down, the equalizer curve increases or decreases respectively.

+6 to **-4** (or **-6**) is displayed as the equalizer curve is increased or decreased.

- The actual range of the adjustments are different depending on which equalizer curve is selected.
- The equalizer curve with all frequencies set to **0** cannot be adjusted.

Adjusting 7-band graphic equalizer

For **Custom1** and **Custom2** equalizer curves, you can adjust the level of each band.

- A separate **Custom1** curve can be created for each source. (The built-in CD player and the multi-CD player are set to the same equalizer adjustment setting automatically.) If you make adjustments when a curve other than **Custom2** is selected, the equalizer curve settings will be memorized in **Custom1**.
- A **Custom2** curve can be created common to all sources. If you make adjustments when the **Custom2** curve is selected, the **Custom2** curve will be updated.

1 Recall the equalizer curve you want to adjust.

Refer to *Recalling equalizer curves* on the previous page.

2 Use MULTI-CONTROL to select 7-band graphic equalizer adjustment.

Frequency and the level (e.g., **50Hz LV+4**) appears in the display.

3 Push MULTI-CONTROL left or right to select the equalizer band to adjust.

Each time **MULTI-CONTROL** is pushed left or right, equalizer bands are selected in the following order:

50Hz—125Hz—315Hz—800Hz—2kHz—5kHz—12.5kHz

Audio Adjustments

4 Push MULTI-CONTROL up or down to adjust the level of the equalizer band.

Each time **MULTI-CONTROL** is pushed up or down, the level of the equalization band increases or decreases.

+6 to **-6** is displayed as the level is increased or decreased.

- You can then select another band and adjust the level. 

Adjusting loudness

Loudness compensates for deficiencies in the low- and high-sound ranges at low volume.

1 Display the audio menu.

Refer to *Introduction of audio adjustments* on page 43.

2 Use MULTI-CONTROL to select Loudness in the audio function menu.

3 Press MULTI-CONTROL to turn loudness on.

Loudness level (e.g., **Mid**) appears in the display.

- To turn loudness off, press **MULTI-CONTROL** again.

4 Push MULTI-CONTROL left or right to select a desired level.

Each time **MULTI-CONTROL** is pushed left or right, level is selected in the following order:

Low (low)—**Mid** (mid)—**High** (high) 

Using subwoofer output

This unit is equipped with a subwoofer output which can be turned on or off.

1 Display the audio menu.

Refer to *Introduction of audio adjustments* on page 43.

2 Use MULTI-CONTROL to select Sub W1.

3 Press MULTI-CONTROL to turn subwoofer output on.

Normal appears in the display. Subwoofer output is now on.

- To turn subwoofer output off, press **MULTI-CONTROL** again.

4 Push MULTI-CONTROL left or right to select the phase of subwoofer output.

Push **MULTI-CONTROL** left to select reverse phase and **REV** appears in the display. Push **MULTI-CONTROL** right to select normal phase and **Normal** appears in the display.

Adjusting subwoofer settings

When the subwoofer output is on, you can adjust the cut-off frequency and the output level of the subwoofer.

Only frequencies lower than those in the selected range are outputted from the subwoofer.

- When the subwoofer output is on, you can select **Sub W2**.

1 Display the audio menu.

Refer to *Introduction of audio adjustments* on page 43.

2 Use MULTI-CONTROL to select Sub W2.

3 Push MULTI-CONTROL left or right to select cut-off frequency.

Each time **MULTI-CONTROL** is pushed left or right, cut-off frequencies are selected in the following order:

50Hz—63Hz—80Hz—100Hz—125Hz

4 Push MULTI-CONTROL up or down to adjust the output level of the subwoofer.

Each time **MULTI-CONTROL** is pushed up or down, subwoofer level increases or decreases. **+6** to **-24** is displayed as the level is increased or decreased. 

Boosting the bass

Bass boost function boosts the bass level of sound.

1 Display the audio menu.

Refer to *Introduction of audio adjustments* on page 43.

2 Use MULTI-CONTROL to select Bass.

3 Push MULTI-CONTROL up or down to select a desired level.

0 to +6 is displayed as the level is increased or decreased. 

Using the high pass filter

When you do not want low sounds from the subwoofer output frequency range to play from the front or rear speakers, turn on the HPF (high pass filter). Only frequencies higher than those in the selected range are output from the front or rear speakers.

1 Display the audio menu.

Refer to *Introduction of audio adjustments* on page 43.

2 Use MULTI-CONTROL to select HPF.

3 Press MULTI-CONTROL to turn high pass filter on.

80Hz appears in the display. High pass filter is now on.

- If the high pass filter has been previously adjusted, the frequency of that previously selected will be displayed instead of 80Hz.

- To turn high pass filter off, press

MULTI-CONTROL again.

4 Push MULTI-CONTROL left or right to select cut-off frequency.

Each time MULTI-CONTROL is pushed left or right, cut-off frequencies are selected in the following order:

50Hz—63Hz—80Hz—100Hz—125Hz 

Adjusting source levels

Source level adjustment (SLA) lets you adjust the volume level of each source to prevent radical changes in volume when switching between sources.

- Settings are based on the FM volume level, which remains unchanged.

1 Compare the FM volume level with the level of the source you wish to adjust.

2 Display the audio menu.

Refer to *Introduction of audio adjustments* on page 43.

3 Use MULTI-CONTROL to select SLA in the audio function menu.

4 Push MULTI-CONTROL up or down to adjust the source volume.

+4 to -4 is displayed as the source volume is increased or decreased.



Notes

- The MW/LW volume level can also be adjusted with source level adjustments.
- The built-in CD player and the multi-CD player are set to the same source level adjustment volume automatically.
- External unit 1 and external unit 2 are set to the same source level adjustment volume automatically. 

Using automatic sound levelizer

During driving, noise in the car changes according to the driving speed and road conditions. The automatic sound levelizer (ASL) monitors such varying noise and automatically increases the volume level, if this noise becomes greater. The sensitivity (variation of volume level to noise level) of ASL can be set to one of five levels.

Audio Adjustments

1 Display the audio menu.

Refer to *Introduction of audio adjustments* on page 43.

2 Use MULTI-CONTROL to select ASL.

3 Press MULTI-CONTROL to turn ASL on.

Mid appears in the display.

- To turn ASL off, press **MULTI-CONTROL** again.

4 Push MULTI-CONTROL left or right to select the desired ASL level.

Each time **MULTI-CONTROL** is pushed left or right, ASL level is selected in the following order:

Low (low)—**Mid-L** (mid-low)—**Mid** (mid)—**Mid-H** (mid-high)—**High** (high)

Adjusting the voice guidance volume

Volume of voice guidance and TTS (text to speech) can be adjusted.

1 Display the audio menu.

Refer to *Introduction of audio adjustments* on page 43.

2 Use MULTI-CONTROL to select Guidance VOL.

3 Push MULTI-CONTROL up or down to adjust the guidance volume.

0 to **62** is displayed as the guidance volume is increased or decreased.

Adjusting initial settings

- 1 Press **SRC/OFF** and hold until the unit turns off.
- 2 Press **MULTI-CONTROL** and hold until the initial setting menu appears in the display.
- 3 Turn **MULTI-CONTROL** to select one of the initial settings.

Language select (language selection)—**Calendar** (calendar)—**Clock** (clock)—**Off clock** (off clock)—**FM step** (FM tuning step)—**Auto PI** (auto PI seek)—**Warning tone** (warning tone)—**AUX1** (auxiliary input 1)—**AUX2** (auxiliary input 2)—**List guidance** (voice guidance setting)—**Dimmer** (dimmer)—**Rear SP** (rear output and subwoofer controller)—**Demo mode** (feature demo)—**Ever scroll** (ever scroll)—**BT AUDIO** (BT audio setting)—**BT Memory Clear** (clearing Bluetooth memory)—**Software update** (software update)

- To cancel initial settings, press **BAND/ESC/CANCEL**. 

Selecting the language

For your convenience, this unit equips multiple language guidance. You can select the language best suited to your first language.

- 1 **Display the initial setting menu.**
Refer to *Adjusting initial settings* on this page.
- 2 **Use MULTI-CONTROL to select Language select in the initial setting menu.**
- 3 **Push MULTI-CONTROL left or right to select the language.**
English—Français—Italiano—Español—Deutsch—Nederlands—РУССКИЙ
- 4 **Press MULTI-CONTROL to determine the selection.**
 - Display guidance and voice guidance are set to the same language simultaneously.

- If the language is set to **РУССКИЙ**, voice guidance and TTS (text to speech) cannot be performed. 

Setting the date

The calendar display adjusted in this mode appears when the telephone source is selected or sources and the feature demo are off.

- 1 **Display the initial setting menu.**
Refer to *Adjusting initial settings* on this page.
- 2 **Use MULTI-CONTROL to select Calendar in the initial setting menu.**
Calendar appears in the display.
- 3 **Push MULTI-CONTROL left or right to select the segment of the calendar display you wish to set.**
Day—Month—Year
As you select segments of the calendar display the segment selected will blink.

- 4 **Push MULTI-CONTROL up or down to set the date.**
Pushing **MULTI-CONTROL** up will increase the selected day, month or year. Pushing **MULTI-CONTROL** down will decrease the selected day, month or year. 

Setting the clock

Use these instructions to set the clock.

- 1 **Display the initial setting menu.**
Refer to *Adjusting initial settings* on this page.
- 2 **Use MULTI-CONTROL to select Clock in the initial setting menu.**
- 3 **Push MULTI-CONTROL left or right to select the segment of the clock display you wish to set.**
Hour—Minute
As you select segments of the clock display, the selected segment blinks.

Initial Settings

4 Push MULTI-CONTROL up or down to put a clock right.



Note

You can match the clock to a time signal by pressing **MULTI-CONTROL**.

- If **00** to **29**, the minutes are rounded down. (e.g., **10:18** becomes **10:00**.)
- If **30** to **59**, the minutes are rounded up. (e.g., **10:36** becomes **11:00**.) 

Turning the off clock display on or off

If the off clock display is turned on and the sources and the feature demo are off, the clock display appears on the display.

1 Display the initial setting menu.

Refer to *Adjusting initial settings* on the previous page.

2 Use MULTI-CONTROL to select Off clock in the initial setting menu.

3 Press MULTI-CONTROL to turn the off clock display on.

- To turn the off clock display off, press **MULTI-CONTROL** again. 

Setting the FM tuning step

Normally the FM tuning step employed by seek tuning is 50 kHz. When AF or TA is on, the tuning step automatically changes to 100 kHz. It may be preferable to set the tuning step to 50 kHz when AF is on.

1 Display the initial setting menu.

Refer to *Adjusting initial settings* on the previous page.

2 Use MULTI-CONTROL to select FM step in the initial setting menu.

3 Press MULTI-CONTROL to select the FM tuning step.

Pressing **MULTI-CONTROL** repeatedly will switch the FM tuning step between 50 kHz and 100 kHz. The selected FM tuning step will appear in the display.



Note

The tuning step remains at 50 kHz during manual tuning. 

Switching Auto PI Seek

The unit can automatically search for a different station with the same programming, even during preset recall.

1 Display the initial setting menu.

Refer to *Adjusting initial settings* on the previous page.

2 Use MULTI-CONTROL to select Auto PI in the initial setting menu.

3 Press MULTI-CONTROL to turn Auto PI seek on.

- To turn Auto PI seek off, press **MULTI-CONTROL** again. 

Switching the warning tone

If the front panel is not detached from the head unit within four seconds of turning off the ignition, a warning tone sounds. You can turn off the warning tone.

1 Display the initial setting menu.

Refer to *Adjusting initial settings* on the previous page.

2 Use MULTI-CONTROL to select Warning tone in the initial setting menu.

3 Press MULTI-CONTROL to turn warning tone on.

- To turn warning tone off, press **MULTI-CONTROL** again. 

Switching the auxiliary setting

Auxiliary devices connected to this unit can be activated individually. Set each AUX source to ON when using. For more information about connecting or using auxiliary devices, refer to *Using the AUX source* on page 53.

1 Display the initial setting menu.

Refer to *Adjusting initial settings* on page 48.

2 Use MULTI-CONTROL to select AUX1/ AUX2 in the initial setting menu.

3 Press MULTI-CONTROL to turn AUX1/ AUX2 on.

- To turn AUX off, press **MULTI-CONTROL** again. 

List TTS (Text to speech) Playback

TTS playback can be performed for an item selected with the cursor in a list. If this is set to on, any item the cursor is on for 2 seconds or longer is read out.

- This function is available for the name in the following lists:
 - **Phone book** (phone book)
 - **Missed calls** (missed call history)
 - **Dialed calls** (dialed call history)
 - **Received calls** (received call history)

1 Display the initial setting menu.

Refer to *Adjusting initial settings* on page 48.

2 Use MULTI-CONTROL to select List guidance.

3 Press MULTI-CONTROL to turn List guidance on.

- To turn this function off, press **MULTI-CONTROL** again.
- If the language is set to **РУССКИЙ** in the **Language select**, this function cannot be performed. 

Switching the dimmer setting

To prevent the display from being too bright at night, the display is automatically dimmed when the car's headlights are turned on. You can turn the dimmer on or off.

1 Display the initial setting menu.

Refer to *Adjusting initial settings* on page 48.

2 Use MULTI-CONTROL to select Dimmer in the initial setting menu.

3 Press MULTI-CONTROL to turn dimmer on.

- To turn dimmer off, press **MULTI-CONTROL** again. 

Setting the rear output and subwoofer output

This unit's rear output (rear speaker leads output) can be used for full-range speaker (**Full**) or subwoofer (**Sub W**) connection. If you switch the rear output setting to **Sub W**, you can connect a rear speaker lead directly to a subwoofer without using an auxiliary amp. Initially, the unit is set for rear full-range speaker connection (**Full**).

1 Display the initial setting menu.

Refer to *Adjusting initial settings* on page 48.

2 Use MULTI-CONTROL to select Rear SP in the initial setting menu.

Initial Settings

3 Press MULTI-CONTROL to switch the rear output setting.

Pressing **MULTI-CONTROL** will switch between **Full** (full-range speaker) and **Sub W** (subwoofer) and that status will be displayed.

- When no subwoofer is connected to the rear output, select **Full** (full-range speaker).
- When a subwoofer is connected to the rear output, select **Sub W** (subwoofer).

Notes

- Even if you change this setting, there is no output unless you turn the subwoofer output on (refer to *Using subwoofer output* on page 45).
- If you change this setting, subwoofer output in the audio menu will return to the factory settings. 

Switching the feature demo

The feature demo automatically starts when power to this unit is turned off while the ignition switch is set to ACC or ON.

1 Display the initial setting menu.

Refer to *Adjusting initial settings* on page 48.

2 Use MULTI-CONTROL to select Demo mode in the initial setting menu.

3 Press MULTI-CONTROL to turn the feature demo on.

- To turn the feature demo off, press **MULTI-CONTROL** again.

Notes

- Remember that if the feature demo continues operating when the car engine is turned off, it may drain battery power.
- You can also turn on or off feature demo by pressing **DISP/SCRL** while this unit is turned off. For more details, refer to *Feature demo mode* on page 8. 

Switching the ever scroll

When Ever Scroll is set to ON, recorded text information scrolls continuously in the display. Set to OFF if you prefer the information to scroll just once.

1 Display the initial setting menu.

Refer to *Adjusting initial settings* on page 48.

2 Use MULTI-CONTROL to select Ever scroll in the initial setting menu.

3 Press MULTI-CONTROL to turn the ever scroll on.

- To turn the Ever Scroll off, press **MULTI-CONTROL** again. 

Activating the BT AUDIO source

You need to activate the **BT AUDIO** source in order to use a Bluetooth audio player.

1 Display the initial setting menu.

Refer to *Adjusting initial settings* on page 48.

2 Use MULTI-CONTROL to select BT AUDIO in the initial setting menu.

3 Press MULTI-CONTROL to turn the BT AUDIO source on.

- To turn the **BT AUDIO** source off, press **MULTI-CONTROL** again. 

Resetting the Bluetooth wireless technology module

Bluetooth telephone and Bluetooth Audio data can be deleted. To protect personal information, we recommend deleting this data before transferring the unit to other persons. The following settings will be deleted.

- phone book entries on the Bluetooth telephone
- preset numbers on the Bluetooth telephone

- registration assignment of Bluetooth telephone
- call history of Bluetooth telephone
- history of the most recently connected Bluetooth audio
- information of the connected Bluetooth device

1 Display the initial setting menu.

Refer to *Adjusting initial settings* on page 48.

2 Use MULTI-CONTROL to select BT Memory Clear.

3 Push MULTI-CONTROL right to show a confirmation display.

Yes is displayed. Clearing memory is now on standby.

- If you do not want to reset phone memory, push **MULTI-CONTROL** left. The display reverts.

4 Press MULTI-CONTROL to clear the memory.

Cleared is displayed and the settings are deleted. 

Updating the software about Bluetooth connection

This function is used to update this unit with the latest software. For about software and updating, refer to our website.

Important

Never turn the unit off while the software is being updated.

1 Display the initial setting menu.

Refer to *Adjusting initial settings* on page 48.

2 Use MULTI-CONTROL to select Software update.

3 Press MULTI-CONTROL to display the data transfer mode.

- To finish the updating, follow the on-screen instructions. 

Other Functions

Using the AUX source

Up to two auxiliary devices such as VCR or portable devices (sold separately) can be connected to this unit. When connected, auxiliary devices are automatically read as AUX sources and assigned to **AUX1** or **AUX2**. The relationship between **AUX1** and **AUX2** sources is explained below.

About AUX1 and AUX2

There are two methods to connect auxiliary devices to this unit.

AUX1 source:

When connecting auxiliary device using a stereo mini plug cable

- **Insert the stereo mini plug into the input jack on this unit.**

For more details, refer to the installation manual.

This auxiliary device is automatically set to **AUX1**.

AUX2 source:

When connecting auxiliary device using an IP-BUS-RCA Interconnector (sold separately)

- **Use an IP-BUS-RCA Interconnector such as the CD-RB20/CD-RB10 (sold separately) to connect this unit to auxiliary device featuring RCA output.**

For more details, refer to the IP-BUS-RCA Interconnector owner's manual.

This auxiliary device is automatically set to **AUX2**.

- You can only make this type of connection if the auxiliary device has RCA outputs.

Selecting AUX as the source

- **Press SRC/OFF to select AUX as the source.**
 - If the auxiliary setting is not turned on, **AUX** cannot be selected. For more details, refer to *Switching the auxiliary setting* on page 50.

Setting the AUX title

The title displayed for the **AUX1** or **AUX2** source can be changed.

- 1 After you have selected AUX as the source, use MULTI-CONTROL and select FUNCTION to display Title input.**

- 2 Enter a title in the same way as the built-in CD player.**

For details concerning operation, refer to *Entering disc titles* on page 22. 

Using the external unit

External unit refers to a Pioneer product (such as ones available in the future) that, although incompatible as a source, enables control of basic functions with this unit. Two external units can be controlled with this unit. When two external units are connected, the external unit is automatically allocated to external unit 1 or external unit 2 by this unit.

Basic operations of the external unit are explained below. Allocated functions are different depending on the connected external unit. For details concerning functions, refer to external unit's owner's manual.

Selecting the external unit as the source

- **Press SRC/OFF to select EXTERNAL as the source.**

Basic operation

Functions allocated to the following operations are different depending on the connected external unit. For details concerning functions, refer to the connected external unit's owner's manual.

- Press **BAND/ESC/CANCEL**.
- Press and hold **BAND/ESC/CANCEL**.
- Push **MULTI-CONTROL** left or right.
- Push and hold **MULTI-CONTROL** left or right.
- Push **MULTI-CONTROL** up or down.

Advanced operations

1 Press **MULTI-CONTROL** to display the main menu.

2 Use **MULTI-CONTROL** to select **FUNCTION**.

Turn to change the menu option. Press to select.

3 Turn **MULTI-CONTROL** to select the function.

FUNC1 (function 1)—**FUNC2** (function 2)—

FUNC3 (function 3)—**FUNC4** (function 4)—

Auto/MAN (auto/manual)



Note

To return to the ordinary display, press **BAND/ESC/CANCEL**. 



Notes

- When an SMS is received while a menu screen is displayed, the display of the menu is cancelled.
- When an SMS is received while the feature demo is on, the feature demo is cancelled and then started again after the SMS reception message has been displayed. 

SMS (Short Message Service) Reception Notification Function

When an SMS is received by the connected cellular phone, a message is displayed for 8 seconds to notify you of the reception. A beep tone also sounds at that time.

Available accessories

Playing songs on iPod

Basic operation

You can use this unit to control an interface adapter for iPod (e.g. CD-IB100II), which is sold separately.

- **Fast forward or reverse**

Push and hold **MULTI-CONTROL** left or right.

- **Select a track**

Push **MULTI-CONTROL** left or right.

Notes

- Read the precautions for iPod in the following section. Refer to page 65.
- If an error message is displayed, refer to *Error messages* on page 62.
- When the ignition switch is set to ACC or ON, the iPod's battery is charged while the iPod is connected to this unit.
- While the iPod is connected to this unit, the iPod cannot be turned on or off.
- Before connecting the dock connector of this unit to the iPod, disconnect the headphones from the iPod.
- The iPod is turned off about two minutes after the ignition switch is set to OFF.

Displaying text information on iPod

The operation is the same as that of the iPod connected to USB interface of this unit. (Refer to *Displaying text information on iPod* on page 26.)

Browsing for a song

The operation is the same as that of the iPod connected to USB interface of this unit. (Refer to *Browsing for a song* on page 25.)

However, the selectable categories are slightly different. Selectable categories are

Playlists (playlists)—**Artists** (artists)—**Albums** (albums)—**Songs** (songs)—**Genres** (genres)

Introduction to advanced operations

1 Press MULTI-CONTROL to display the main menu.

2 Use MULTI-CONTROL to select FUNCTION.

Turn to change the menu option. Press to select.

The function menu is displayed.

3 Turn MULTI-CONTROL to select the function.

Repeat (repeat play)—**Shuffle** (shuffle)—**Pause** (pause)

Function and operation



Repeat and **Pause** operations are basically the same as that of the built-in CD player.

Function name	Operation
Repeat	Refer to <i>Selecting a repeat play range</i> on page 21. However, the repeat play ranges you can select are different from that of the built-in CD player. The repeat play ranges of the iPod are: <ul style="list-style-type: none"> • One – Repeat the current song • All – Repeat all songs in the selected list
Pause	Refer to <i>Pausing playback</i> on page 21.

Notes

- To return to the ordinary display, press **BAND/ESC/CANCEL**.
- If you do not operate functions within about 30 seconds, the display automatically returns to the ordinary display.

Playing songs in a random order (shuffle)

- Press /iPod repeatedly to select the desired setting.
 - **Songs** – Play back songs in the selected list in random order.
 - **Albums** – Play back songs from a randomly selected album in order.
 - **OFF** – Cancel random play.
- To turn shuffle off, press /iPod again. 

Multi-CD Player

Basic Operations

You can use this unit to control a multi-CD player, which is sold separately.

- Only functions described in this manual are supported by 50-disc multi-CD players.
- This unit is not designed to operate disc title list functions with a 50-disc multi-CD player. For information about the disc title list functions, refer to *Selecting discs from the disc title list* on page 59.

- **Select a disc**

Push **MULTI-CONTROL** up or down.

- **Fast forward or reverse**

Push and hold **MULTI-CONTROL** left or right.

- **Select a track**

Push **MULTI-CONTROL** left or right.



Notes

- When multi-CD player completes preparatory operations, **READY** is displayed.
- If an error message is displayed, refer to the multi-CD player owner's manual.
- If there are no discs in the multi-CD player magazine, **NO DISC** is displayed.

Using CD TEXT functions

You can use these functions only with a CD TEXT compatible multi-CD player.

The operation is the same as that of the built-in CD player.

Refer to *Displaying text information on disc* on page 19.

Introduction to advanced operations

You can only use **COMP/DBE** (compression and DBE) with a multi-CD player that supports them.

1 Press MULTI-CONTROL to display the main menu.

2 Use MULTI-CONTROL to select FUNCTION.

Turn to change the menu option. Press to select.

The function menu is displayed.

3 Turn MULTI-CONTROL to select the function.

Repeat (repeat play)—**Random** (random play)

—**Scan** (scan play)—**Pause** (pause)—

COMP/DBE (compression and DBE)—

ITS play (ITS play)—**ITS memory** (ITS programming)—**Title input** (disc title input)

- If you do not operate functions other than **ITS memory** and **Title input** within about 30 seconds, the display automatically returns to the ordinary display.

- When playing a CD TEXT disc on a CD TEXT compatible multi-CD player, you cannot switch to **Title input**. The disc title is already recorded on the CD TEXT disc.

Function and operation

Repeat, **Random**, **Scan**, **Pause** and **Title input** operations are basically the same as that of the built-in CD player.

Available accessories

Function name	Operation
Repeat	<p>Refer to <i>Selecting a repeat play range</i> on page 21.</p> <p>However, the repeat play ranges you can select are different from that of the built-in CD player. The repeat play ranges of the multi-CD player are:</p> <ul style="list-style-type: none"> • MCD – Repeat all discs in the multi-CD player • Track – Repeat just the current track • Disc – Repeat the current disc
Random	Refer to <i>Playing tracks in random order</i> on page 21.
Scan	Refer to <i>Scanning folders and tracks</i> on page 21.
Pause	Refer to <i>Pausing playback</i> on page 21.
Title input	Refer to <i>Entering disc titles</i> on page 22.



Notes

- To return to the playback display, press **BAND/ESC/CANCEL**.
- If you select other discs during repeat play, the repeat play range changes to **MCD**.
- If you perform track search or fast forward/reverse during **Track**, the repeat play range changes to **Disc**.
- After track or disc scanning is finished, normal playback of the tracks begins again.

Using compression and bass emphasis

You can only use these functions with a multi-CD player that supports them.

COMP (compression) and DBE (dynamic bass emphasis) functions lets you adjust the sound playback quality of the multi-CD player.

1 Display the function menu.

Refer to *Introduction to advanced operations* on the previous page.

2 Use MULTI-CONTROL to select COMP/DBE in the function menu.

- If the multi-CD player does not support COMP/DBE, **No COMP** is displayed when you attempt to select it.

3 Press MULTI-CONTROL to select your favorite setting.

OFF—COMP 1—COMP 2—OFF—DBE 1—DBE 2

Using ITS playlists

ITS (instant track selection) lets you make a playlist of favorite tracks from the multi-CD player magazine. After you have added your favorite tracks to the playlist, you can turn on ITS play and play just those selections.

You can use ITS to enter and play back up to 99 tracks per disc from up to 100 discs (with the disc titles). (With multi-CD players sold before the CDX-P1250 and CDX-P650, up to 24 tracks can be stored in the playlist.)

Creating a playlist with ITS programming

1 Play a CD that you want to program.

Push **MULTI-CONTROL** up or down to select the CD.

2 Display the function menu.

Refer to *Introduction to advanced operations* on the previous page.

3 Use MULTI-CONTROL to select ITS memory in the function menu.

4 Select the desired track by pushing MULTI-CONTROL left or right.

5 Push MULTI-CONTROL up to store the currently playing track in the playlist.

Memory complete is displayed and the currently playing selection is added to your playlist.

6 Press BAND/ESC/CANCEL to return to the playback display.

**Note**

After data for 100 discs is stored in memory, data for a new disc will overwrite the oldest one.

Playback from your ITS playlist

ITS play lets you listen to the tracks that you have entered into your ITS playlist. When you turn on ITS play, tracks from your ITS playlist in the multi-CD player begin to play.

1 Select the repeat range.

Refer to *Playing tracks in random order* on page 21.

2 Display the function menu.

Refer to *Introduction to advanced operations* on page 56.

3 Use MULTI-CONTROL to select ITS play in the function menu.**4 Press MULTI-CONTROL to turn ITS play on.**

ITS play: ON appears in the display. Playback begins of those tracks from your playlist within the previously selected **MCD** or **Disc** ranges.

- If no tracks in the current range are programmed for ITS play, then **ITS Empty** is displayed.
- To turn ITS play off, press **MULTI-CONTROL** again.

Erasing a track from your ITS playlist

You can delete a track from your ITS playlist if ITS play is on.

If ITS play is already on, skip to step 2. If ITS play is off, use **MULTI-CONTROL**.

1 Play the CD with the track you want to delete from your ITS playlist, and turn ITS play on.

Refer to *Playback from your ITS playlist* on this page.

2 Display the function menu.

Refer to *Introduction to advanced operations* on page 56.

3 Use MULTI-CONTROL to select ITS memory in the function menu.**4 Select the desired track by pushing MULTI-CONTROL left or right.****5 Push MULTI-CONTROL down to erase the track from your ITS playlist.**

The currently playing selection is erased from your ITS playlist and playback of the next track begins.

6 Press BAND/ESC/CANCEL to return to the playback display.**Erasing a CD from your ITS playlist**

You can delete all tracks of a CD from your ITS playlist if ITS play is off.

1 Play the CD that you want to delete.

Push **MULTI-CONTROL** up or down to select the CD.

2 Display the function menu.

Refer to *Introduction to advanced operations* on page 56.

3 Use MULTI-CONTROL to select ITS memory in the function menu.**4 Push MULTI-CONTROL down to erase all tracks on the currently playing CD from your ITS playlist.**

All tracks on the currently playing CD are deleted from your playlist and **Memory deleted** is displayed.

5 Press BAND/ESC/CANCEL to return to the playback display.**Using disc title functions**

You can input CD titles and display the titles. Then, you can easily search for and play a desired disc.

Available accessories

Entering disc titles

Use the disc title input feature to store up to 100 CD titles (with ITS playlist) into the multi-CD player. Each title can be up to 10 characters long.

For details concerning operation, refer to *Entering disc titles* on page 22.

- Titles remain in the memory even after the disc is removed from the magazine, and are recalled when the disc is reinserted.
- After data for 100 discs is stored in memory, data for a new disc will overwrite the oldest one.

Displaying disc titles

You can display the text information of any disc that has the disc title entered.

The operation is the same as that of the built-in CD player.

Refer to *Displaying text information on disc* on page 19.

Selecting discs from the disc title list

Disc title list lets you see the list of disc titles entered in the multi-CD player and select one of them to play back.

1 Press  /LIST to switch to the disc title list mode during the playback display.

2 Use MULTI-CONTROL to select the desired disc title.

Turn to change the disc title. Press to play.

- You can also change the disc title by pushing **MULTI-CONTROL** up or down.
- When playing CD TEXT disc, push **MULTI-CONTROL** right to see a list of the tracks in the selected disc. Push **MULTI-CONTROL** left to return to the disc list.
- If no title is entered for a disc, **NO DISC TITLE** is displayed.
- **NO DISC** is displayed next to the disc number when there is no disc in the magazine.
- If you do not operate the list within about 30 seconds, the display automatically returns to the ordinary display. 

DVD Player

Basic Operations

You can use this unit to control a DVD player or multi-DVD player, which is sold separately.

For details concerning operation, refer to the DVD player's or multi-DVD player's operation manual. This section provides information on DVD operations with this unit which differs from that described in the DVD player's or multi-DVD player's operation manual.

● Select a chapter/track

Push **MULTI-CONTROL** left or right.

● Fast forward or reverse

Push and hold **MULTI-CONTROL** left or right.

- When playing compressed audio, there is no sound on fast forward or reverse.

● To skip back or forward to another chapter/track, push **MULTI-CONTROL** left or right.

Selecting a disc

- You can operate this function only when a multi-DVD player is connected to this unit.
- Push **MULTI-CONTROL** up or down to select the desired disc.

Selecting a folder

- You can operate this function only when a DVD player compatible with compressed audio playback is connected to this unit.
- Push **MULTI-CONTROL** up or down to select a folder.

Introduction to advanced operations

1 Press **MULTI-CONTROL to display the main menu.**

2 Use MULTI-CONTROL to select FUNCTION.

Turn to change the menu option. Press to select.

The function menu is displayed.

3 Turn MULTI-CONTROL to select the function.

During DVD video or Video CD playback

Repeat (repeat play)—**Pause** (pause)

During CD playback

Repeat (repeat play)—**Random** (random play)

—**Scan** (scan play)—**Pause** (pause)—**ITS play** (ITS play)—**ITS memory** (ITS input)—

Title input (disc title input)

During compressed audio playback

Repeat (repeat play)—**Random** (random play)

—**Scan** (scan play)—**Pause** (pause)

▪ To return to the playback display, press

BAND/ESC/CANCEL.

▪ If you do not operate functions except for **ITS memory** and **Title input** within about 30 seconds, the display is automatically returned to the ordinary display.

Function and operation

Repeat, **Random**, **Scan**, **Pause** and **Title input** operations are basically the same as that of the built-in CD player.

Also, **ITS play** and **ITS memory** operations are basically the same as that the multi-CD player.

Function name	Operation
Repeat	<p>Refer to <i>Selecting a repeat play range</i> on page 21.</p> <p>But the repeat play range that you can select is vary depending on the type of disc or system. The repeat play ranges of the DVD player/multi-DVD player are as below:</p> <p>During PBC playback of Video CDs, this function cannot be operated.</p> <ul style="list-style-type: none"> • Disc – Repeat the current disc • Folder – Repeat the current folder • Title – Repeat just the current title • CHAP – Repeat just the current chapter • Track – Repeat the current track
Random	Refer to <i>Playing tracks in random order</i> on page 21.
Scan	Refer to <i>Scanning folders and tracks</i> on page 21.
Pause	Refer to <i>Pausing playback</i> on page 21.
ITS play	Refer to <i>Using ITS playlists</i> on page 57.
ITS memory	Refer to <i>Using ITS playlists</i> on page 57.
Title input	Refer to <i>Entering disc titles</i> on page 22.



Notes

- If you select other discs during repeat play, the repeat play range changes to **Disc**.
- When playing back Video CD or CD, if you perform track search or fast forward/reverse during **Track**, the repeat play range changes to **Disc**.
- When playing back compressed audio, if you select another folder during repeat play, the repeat play range changes to **Disc**.
- When playing back compressed audio, if you perform track search or fast forward/reverse during **Track**, the repeat play range changes to **Folder**.

Available accessories

- Multi-DVD player that has ITS functions and disc title functions can also be connected to this unit. In this case, **ITS play**, **ITS memory** and disc title input can be controlled.
- The ITS function of a DVD player differs slightly from ITS playback with a multi-CD player. With multi-DVD player, ITS playback applies only to the CD playing. For details, refer to *Using ITS playlists* on page 57. 

TV tuner

Basic Operations

You can use this unit to control a TV tuner, which is sold separately.

For details concerning operation, refer to the TV tuner's operation manual. This section provides information on TV operations with this unit, which differs from that described in the TV tuner's operation manual.

• Select a band

Press **BAND/ESC/CANCEL**.

• Select a channel (step by step)

Push **MULTI-CONTROL** left or right.

• Seek tuning

Push and hold **MULTI-CONTROL** left or right, and then release.



Notes

- Band can be selected from **TV-1** or **TV-2**.
- You can cancel seek tuning by pushing **MULTI-CONTROL** left or right.
- While pushing and holding **MULTI-CONTROL** left or right, you can skip stations. Seek tuning starts as soon as you release **MULTI-CONTROL**.

Storing and recalling broadcast stations

You can easily store up to 12 broadcast stations for later recall.

- 12 stations for each band can be stored in memory.

1 Press /LIST.

Preset screen is displayed.

2 Use **MULTI-CONTROL** to store the selected station in memory.

Turn to change the preset number. Press and hold to store.

3 Use **MULTI-CONTROL** to select the desired station.

Turn to change the station. Press to select.

- You can also change the station by pushing **MULTI-CONTROL** up or down.
- If you do not operate the list within about 30 seconds, the display automatically returns to the ordinary display.

Storing the strongest broadcast stations sequentially

1 Press **MULTI-CONTROL** to display the main menu.

2 Use **MULTI-CONTROL** and select **FUNCTION** to display BSSM.

3 Press **MULTI-CONTROL** to turn BSSM on.

Search begins to flash. While **Search** is flashing, the 12 strongest broadcast stations are stored in order from the lowest channel up. When finished, the preset channel list appears.

- To cancel the storage process, press **MULTI-CONTROL** again.

4 Use **MULTI-CONTROL** to select the desired station.

Turn to change the station. Press to select.

- You can also change the station by pushing **MULTI-CONTROL** up or down.
- To return to the ordinary display, press **BAND/ESC/CANCEL**.
- If you do not operate the list within about 30 seconds, the display automatically returns to the ordinary display. 

Additional Information

Troubleshooting

Bluetooth audio/telephone

Symptom	Cause	Action
The audio of the Bluetooth audio source is not played back.	A Bluetooth-connected cellular phone is currently in a phone call.	The audio will be played back when the call is completed.
	A Bluetooth-connected cellular phone is currently in operation.	Do not operate the cellular phone at this time.
	A call was made with a Bluetooth-connected cellular phone and then immediately terminated. As a result, communication between this unit and the cellular phone was not terminated properly.	Reconnect the Bluetooth connection between this unit and the cellular phone.



Error messages

When you contact your dealer or your nearest Pioneer Service Center, be sure to have the error message recorded.

Built-in CD Player

Message	Cause	Action
ERROR-11, 12, 17, 30	Scratched disc	Replace disc.
	Dirty disc	Clean disc.
ERROR-10, 11, 12, 15, 17, 30, A0	Electrical or mechanical	Turn the ignition switch OFF and back ON, or switch to a different source, then back to the CD player.
ERROR-15	The inserted disc does not contain any data	Replace disc.

ERROR-22, 23	The CD format cannot be played back	Replace disc.
NO AUDIO	The inserted disc does not contain any files that can be played back	Replace disc.
SKIPPED	The inserted disc contains WMA files that are protected by DRM	Replace disc.
PROTECT	All the files on the inserted disc are secured by DRM	Replace disc.

USB audio player/USB memory

Message	Cause	Action
NO AUDIO	No songs	Transfer the audio files to the USB portable audio player/USB memory and connect.
	USB memory with security enabled is connected	Follow the USB memory instructions to disable the security.
NO DEVICE	The USB storage device or iPod is not connected to the USB port of this unit.	Connect a compatible USB storage device.
SKIPPED	The connected USB portable audio player/USB memory contains WMA files that are protected by Windows Media™ DRM 9/10	Play an audio file not protected by Windows Media DRM 9/10.
PROTECT	All the files on the connected USB portable audio player/USB memory are protected by Windows Media DRM 9/10	Transfer audio files not protected by Windows Media DRM 9/10 to the USB portable audio player/USB memory and connect.

Additional Information

NOT COMPATIBLE	The USB device connected to is not supported by this unit.	Connect a USB portable audio player or USB memory that is USB Mass Storage Class compliant.
CHECK USB	The USB connector or USB cable is short-circuited.	Confirm that the USB connector or USB cable is not caught in something or damaged.
	The connected USB portable audio player/USB memory consumes more than 500 mA (maximum allowable current).	Disconnect the USB portable audio player/USB memory and do not use it. Turn the ignition switch to OFF, then to ACC or ON and then connect the compliant USB portable audio player/USB memory.
ERROR-19	Communication failure	Perform one of the following operations. –Turn the ignition switch OFF and back ON. –Disconnect the USB portable audio player/USB memory. –Change to a different source. Then, return to the USB portable audio player/USB memory.
ERROR-23	USB device is not formatted with FAT16 or FAT32	USB device should be formatted with FAT16 or FAT32.

iPod

Message	Cause	Action
ERROR-19	Communication failure	Disconnect the cable from iPod. Once iPod main menu is displayed, connect the cable again. Reset the iPod.
	iPod failure	Disconnect the cable from iPod. Once iPod main menu is displayed, connect the cable again. Reset the iPod.
ERROR-16	Old version of iPod	Update the iPod version.
	iPod failure	Disconnect the cable from iPod. Once iPod main menu is displayed, connect the cable again. Reset the iPod.
ERROR-A1 CHECK USB	iPod is not charged but operates correctly	Check if the connection cable for iPod shorted out (e.g., not caught in metal objects). After checking, turn the ignition switch OFF and back ON or disconnect the iPod and connect again.
NO SONGS	No songs	Transfer the songs to iPod.
STOP	No songs in the current list	Select a list that contains the songs.
NO DEVICE	The USB storage device or iPod is not connected to the USB port of this unit.	Connect a compatible iPod.

Additional Information

Bluetooth audio/telephone

Message	Cause	Action
ERROR-10	Power failure of the Bluetooth module of this unit	Turn the ignition switch OFF and then to ACC or ON. If the error message is displayed again after the action, please contact your dealer or an authorized Pioneer Service Station.



Handling guideline of discs and player

- Use only discs featuring either of following two logos.



- Use only conventional, fully circular discs. Do not use shaped discs.



- Use 12-cm or 8-cm CD. Do not use an adapter when playing 8-cm CDs.
- Do not insert anything other than a CD into the CD loading slot.
- Do not use cracked, chipped, warped, or otherwise damaged discs as they may damage the player.
- Unfinalized CD-R/CD-RW disc playback is not possible.
- Do not touch the recorded surface of the discs.
- Store discs in their cases when not in use.

- Avoid leaving discs in excessively hot environments including under direct sunlight.
- Do not attach labels, write on or apply chemicals to the surface of the discs.
- To clean a CD, wipe the disc with a soft cloth outward from the center.
- Condensation may temporarily impair the player's performance. Leave it to adjust to the warmer temperature for about one hour. Also, wipe any dump discs with a soft cloth.
- Playback of discs may not be possible because of disc characteristics, disc format, recorded application, playback environment, storage conditions, and so on.
- Text information may not be correctly displayed depending on the recorded environment.
- Road shocks may interrupt disc playback.
- Read the precautions for discs before using them. ■

Dual Discs

- Dual Discs are two-sided discs that have a recordable CD for audio on one side and a recordable DVD for video on the other.
- Since the CD side of Dual Discs is not physically compatible with the general CD standard, it may not be possible to play the CD side with this unit.
- Frequent loading and ejecting of a Dual Disc may result in scratches on the disc. Serious scratches can lead to playback problems on this unit. In some cases, a Dual Disc may become stuck in the disc loading slot and will not eject. To prevent this, we recommend you refrain from using Dual Disc with this unit.
- Please refer to the information from the disc manufacturer for more detailed information about Dual Discs. ■

Additional Information

Compressed audio compatibility

WMA

- Compatible format: WMA encoded by Windows Media Player
- File extension: .wma
- Bit rate: 48 kbps to 320 kbps (CBR), 48 kbps to 384 kbps (VBR)
- Sampling frequency: 32 kHz to 48 kHz
- Windows Media Audio 9 Professional, Lossless, Voice: No

MP3

- File extension: .mp3
- Bit rate: 8 kbps to 320 kbps (CBR), VBR
- Sampling frequency: 16 kHz to 48 kHz (32, 44.1, 48 kHz for emphasis)
- Compatible ID3 tag version: 1.0, 1.1, 2.2, 2.3, 2.4 (ID3 tag Version 2.x is given priority than Version 1.x.)
- M3u playlist: No
- MP3i (MP3 interactive), mp3 PRO: No

AAC

- Compatible format: AAC encoded by iTunes
- File extension: .m4a
- Sampling frequency: 11.025 kHz to 48 kHz
- Transmission rate: 16 kbps to 320 kbps
- Apple Lossless: No

WAV

- File extension: .wav
- Compatible format: Linear PCM (LPCM), MS ADPCM
- Quantization bits: 8 and 16 (LPCM), 4 (MS ADPCM)
- Sampling frequency: 16 kHz to 48 kHz (LPCM), 22.05 kHz to 44.1 kHz (MS ADPCM)

iPod

iPod compatibility

- This unit supports only the following iPod models. Supported iPod software versions are shown below. Older versions of iPod software may not be supported.
 - iPod nano first generation (software version 1.3.1)
 - iPod nano second generation (software version 1.1.3)
 - iPod nano third generation (software version 1.1.2)
 - iPod fifth generation (software version 1.3.0)
 - iPod classic (software version 1.1.2)
 - iPod touch (software version 2.0)
 - iPhone (software version 2.0)
 - iPhone 3G (software version 2.0)
- Depending on the generation or version of the iPod, some functions can not be operated.
- Operations may vary depending on the software version of iPod.
- When using an iPod, iPod Dock Connector to USB Cable (CD-IU50) is required. For details, consult your dealer.
- This unit can control previous generations iPod models with a Pioneer iPod adapter (e.g. CD-IB100II). For details concerning operation with the iPod adapter, refer to *Playing songs on iPod* on page 55.

About handling the iPod

- Pioneer accepts no responsibility for data lost on the iPod even if that data is lost while using this unit.
- Do not leave the iPod in direct sunlight for extended amounts of time. Extended exposure to direct sunlight can result in iPod malfunction due to the resulting high temperature.
- Do not leave the iPod in a high temperature.
- Firmly secure the iPod when driving. Do not let the iPod fall onto the floor, where it may become jammed under the brake or accelerator pedal.
- For details, refer to the iPod's manuals.

Additional Information

About iPod settings

- When an iPod is connected, this unit changes the EQ (equalizer) setting of the iPod to Flat in order to optimize the acoustics. When you disconnect the iPod, the EQ returns to the original setting.
- You cannot set Repeat to off on the iPod when using this unit. Even if you set Repeat to off on the iPod, Repeat is automatically changed to All when connecting the iPod to this unit.

Compressed audio files on the disc

- There may be a slight delay when starting playback of audio files encoded with image data.
- ISO 9660 Level 1 and 2 compliant. Romeo and Joliet file systems are both compatible with this player.
- Multi-session playback is possible.
- Compressed audio files are not compatible with packet write data transfer.
- Only 32 characters from beginning can be displayed as a file name (including the file extension) or a folder name.
- Folder selection sequence or other operation may be altered depending on the encoding or writing software.
- Regardless of the length of blank section between the songs of original recording, compressed audio discs play with a short pause between songs.
- Russian text to be displayed on this unit should be encoded with the following character sets:
 - Unicode (UTF-8, UTF-16)
 - Character sets other than Unicode that are used in Windows environment and are set to Russian in the multi-language setting

Example of a hierarchy

: Folder

: Compressed audio file

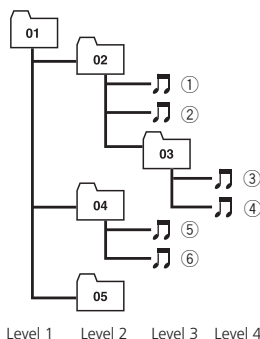

Level 1 Level 2 Level 3 Level 4

- This unit assigns folder numbers. The user cannot assign folder numbers.
- Folder hierarchy is allowed up to eight tiers. However, a practical hierarchy of folder is less than two tiers.
- Up to 999 files on a CD (-R/-RW) can be played back.
- Up to 99 folders on a disc can be played back.

Bluetooth profiles

- In order to use Bluetooth wireless technology, devices must be able to interpret certain profiles. This unit is compatible with the following profiles.
 - A2DP (Advanced Audio Distribution Profile)
 - AVRCP (Audio/Video Remote Control Profile)
 - GAP (Generic Access Profile)
 - SDP (Service Discovery Protocol)
 - OPP (Object Push Profile)
 - HFP (Hands Free Profile)
 - PBAP (Phone Book Access Profile)
 - SPP (Serial Port Profile)

Additional Information

Copyright and trademark notice

WMA



Windows Media and the Windows logo are trademarks or registered trademarks of Microsoft Corporation in the United States and/or other countries.

- This product includes technology owned by Microsoft Corporation and cannot be used or distributed without a license from Microsoft Licensing, Inc.

MP3

Supply of this product only conveys a license for private, non-commercial use and does not convey a license nor imply any right to use this product in any commercial (i.e. revenue-generating) real time broadcasting (terrestrial, satellite, cable and/or any other media), broadcasting/streaming via internet, intranets and/or other networks or in other electronic content distribution systems, such as pay-audio or audio-on-demand applications. An independent license for such use is required. For details, please visit <http://www.mp3licensing.com>.

iTunes

iTunes is a trademark of Apple Inc., registered in the U.S. and other countries.

iPod



iPod is a trademark of Apple Inc., registered in the U.S. and other countries.

iPhone



iPhone is a trademark of Apple Inc.

Bluetooth



The Bluetooth® word mark and logos are registered trademarks owned by Bluetooth SIG, Inc. and any use of such marks by Pioneer Corporation is under license. Other trademarks and trade names are those of their respective owners.

- Bluetooth is a short-range wireless radio connectivity technology that is developed as a cable replacement for mobile phones, handheld PCs and other devices. Bluetooth operates in 2.4 GHz frequency range and transmits voice and data at speeds up to 1 megabit per second. Bluetooth was launched by a special interest group (SIG) that comprises of Ericsson Inc., Intel Corp., Nokia Corp., Toshiba and IBM in 1998, and it is currently developed by nearly 2000 companies worldwide. ▣

Additional Information

Specifications

General

Power source	14.4 V DC (12.0 V to 14.4 V allowable)
Grounding system	Negative type
Max. current consumption	10.0 A
Dimensions (W × H × D): DIN	
Chassis	180 mm × 50 mm × 162 mm
Nose	188 mm × 58 mm × 16 mm
D	
Chassis	180 mm × 50 mm × 162 mm
Nose	170 mm × 46 mm × 16 mm
Weight	1.4 kg

Audio

Maximum power output	50 W × 4 50 W × 2/4 Ω + 70 W × 1/2 Ω (for subwoofer)
Continuous power output ...	22 W × 4 (50 Hz to 15 000 Hz, 5 % THD, 4 Ω load, both channels driven)
Load impedance	4 Ω to 8 Ω × 4 4 Ω to 8 Ω × 2 + 2 Ω × 1
Preout max output level	4.0 V
Equalizer (7-Band Graphic Equalizer):	
Frequency	50/125/315/800/2k/5k/12.5k Hz
Gain	±12 dB
HPF:	
Frequency	50/63/80/100/125 Hz
Slope	-12 dB/oct
Subwoofer (mono):	
Frequency	50/63/80/100/125 Hz
Slope	-18 dB/oct
Gain	+6 dB to -24 dB
Phase	Normal/Reverse
Bass boost:	
Gain	+12 dB to 0 dB

CD player

System	Compact disc audio system
Usable discs	Compact disc
Signal-to-noise ratio	94 dB (1 kHz) (IEC-A network)
Number of channels	2 (stereo)
MP3 decoding format	MPEG-1 & 2 Audio Layer 3
WMA decoding format	Ver. 7, 7.1, 8, 9, 10, 11 (2ch audio) (Windows Media Player)

AAC decoding format	MPEG-4 AAC (iTunes encoded only) (.m4a) (Ver. 7.7 and earlier)
WAV signal format	Linear PCM & MS ADPCM (Non-compressed)

USB

USB standard specification	USB 2.0 full speed
Maximum current supply ...	500 mA
Minimum memory capacity	256 MB
USB Class	MSC (Mass Storage Class)
File system	FAT16, FAT32
MP3 decoding format	MPEG-1 & 2 Audio Layer 3
WMA decoding format	Ver. 7, 7.1, 8, 9, 10, 11 (2ch audio) (Windows Media Player)
AAC decoding format	MPEG-4 AAC (iTunes encoded only) (.m4a) (Ver. 7.7 and earlier)
WAV signal format	Linear PCM & MS ADPCM (Non-compressed)

FM tuner

Frequency range	87.5 MHz to 108.0 MHz
Usable sensitivity	9 dBf (0.8 μV/75 Ω mono, S/N: 30 dB)
Signal-to-noise ratio	72 dB (IEC-A network)

MW tuner

Frequency range	531 kHz to 1 602 kHz (9 kHz)
Usable sensitivity	25 μV (S/N: 20 dB)
Signal-to-noise ratio	62 dB (IEC-A network)

LW tuner

Frequency range	153 kHz to 281 kHz
Usable sensitivity	28 μV (S/N: 20 dB)
Signal-to-noise ratio	62 dB (IEC-A network)

Bluetooth

Version	Bluetooth 2.0 + EDR certified
Output power	+4 dBm Max. (Power class 2)



Note

Specifications and the design are subject to modifications without notice due to improvements. 

<http://www.pioneer.eu>

Visit www.pioneer.co.uk (or www.pioneer.eu) to register your product.

PIONEER CORPORATION

4-1, MEGURO 1-CHOME, MEGURO-KU
TOKYO 153-8654, JAPAN

PIONEER ELECTRONICS (USA) INC.

P.O. Box 1540, Long Beach, California 90801-1540, U.S.A.
TEL: (800) 421-1404

PIONEER EUROPE NV

Haven 1087, Keetberglaan 1, B-9120 Melsele, Belgium/Belgique
TEL: (0) 3/570.05.11

PIONEER ELECTRONICS ASIACENTRE PTE. LTD.

253 Alexandra Road, #04-01, Singapore 159936
TEL: 65-6472-7555

PIONEER ELECTRONICS AUSTRALIA PTY. LTD.

178-184 Boundary Road, Braeside, Victoria 3195, Australia
TEL: (03) 9586-6300

PIONEER ELECTRONICS OF CANADA, INC.

300 Allstate Parkway, Markham, Ontario L3R 0P2, Canada
TEL: 1-877-283-5901
TEL: 905-479-4411

PIONEER ELECTRONICS DE MEXICO, S.A. de C.V.

Bldv.Manuel Avila Camacho 138 10 piso
Col.Lomas de Chapultepec, Mexico, D.F. 11000
TEL: 55-9178-4270

先鋒股份有限公司

總公司：台北市中山北路二段44號13樓
電話：(02) 2521-3588

先鋒電子（香港）有限公司

香港九龍尖沙嘴海港世界商業中心
9樓901-6室
電話：(0852) 2848-6488

Published by Pioneer Corporation.
Copyright © 2009 by Pioneer Corporation.
All rights reserved.