



PLANTRONICS
SOUND INNOVATION™

→ ● ● ● → USER GUIDE_

PULSAR™ 590 & 590A

STEREO BLUETOOTH® HEADSET



 Bluetooth®

TABLE OF CONTENTS

Package Contents	2
Features	3
Charging	5
Powering	6
Indicator Lights	6
Pairing	7
Adjusting Fit	9
In-flight & Wired Uses	10
Headset Controls	11
Troubleshooting	13
Product Specifications	14
Technical Assistance	14
Regulatory Notices	14

Attention!

PLEASE REVIEW THIS USER GUIDE CAREFULLY BEFORE USING YOUR PRODUCT.

If you need further assistance please contact Plantronics at (866) 363-BLUE (2583). Troubleshooting information can be found on page 13 and also on the web at www.plantronics.com/support. Please **do not** return the product to the store where it was purchased.

Register Your Product Online

Visit www.plantronics.com/productregistration to register your product online so we can provide you with the best possible service and technical support.



PACKAGE CONTENTS

Pulsar 590 & 590A

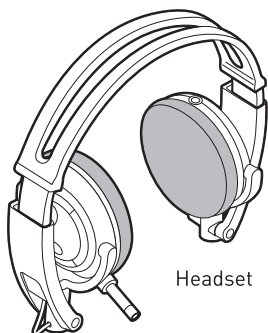

Headset

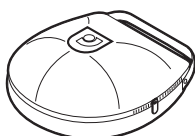

Travel Case

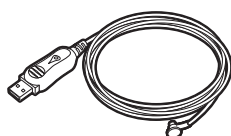

USB Charging Cable

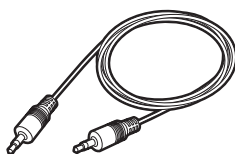

In-flight Cable



Desktop Charging Stand

Pulsar 590

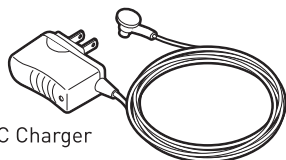

AC Charger

Pulsar 590A

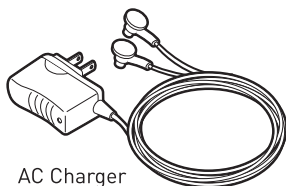

AC Charger

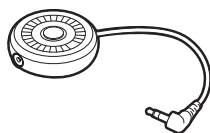

Universal Adapter

FEATURES

Headset

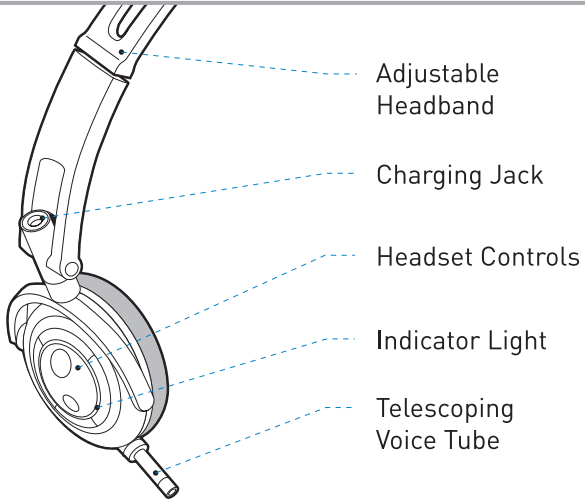

Headset Controls

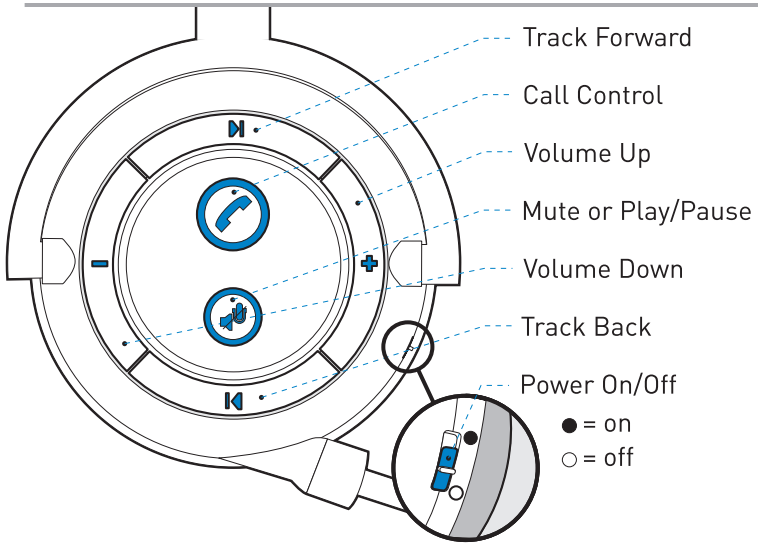

FEATURES

Desktop Charging Stand

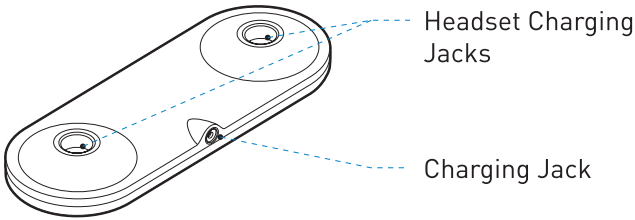

Universal Adapter

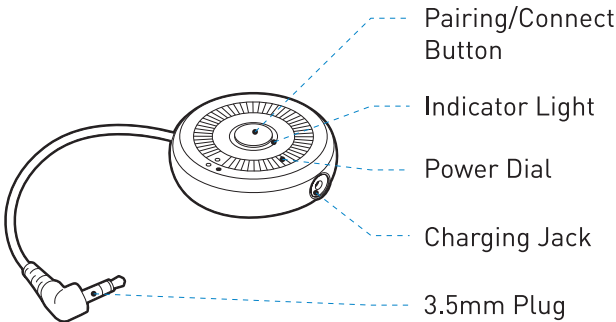

Universal adapter included with Pulsar 590A only or sold separately.

The universal adapter is for **listening only** and can be connected to most audio devices that support a 3.5mm jack, such as laptops, PCs, PDAs, MP3 and DVD players, and home entertainment systems.

CHARGING

Note: Charge for 3 hours before first use.

Desktop Stand Charging



1. Connect AC charger to desktop charging stand and universal adapter.

2. Lift and position earpieces inside headband so **foam ear cushions face each other**.
3. Place headset into desktop charging stand.

Headset indicator light flashes when charging.

AC Charging

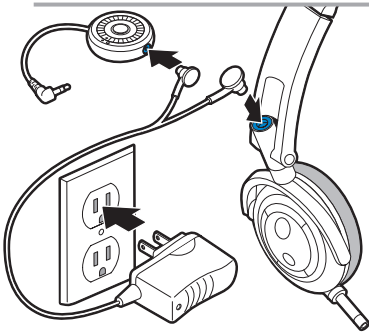

USB Charging

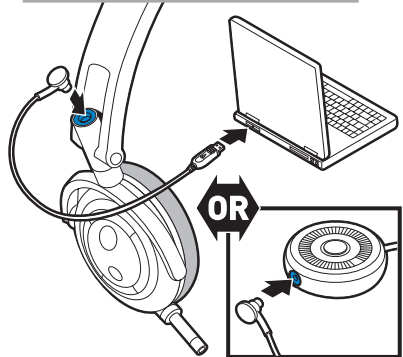

POWERING

Headset

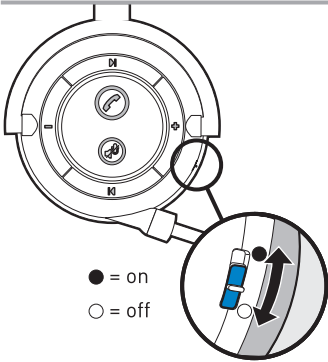

Slide power switch up for "on" and down for "off."

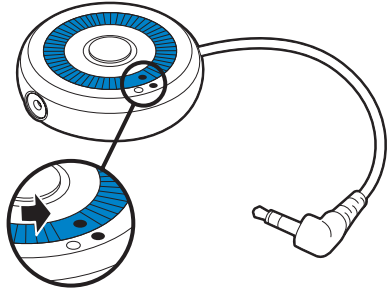

Universal Adapter



To turn on, rotate dial counterclockwise so solid dots are aligned.

To turn off, rotate dial clockwise until the open dot and solid dot are aligned.

INDICATOR LIGHTS

Charging	Flashes red
Fully Charged	Solid blue
Power/Battery Status	3 red flashes =  2 red flashes =  1 red flash = 
Pairing/Connect	Flashes red and blue
Bluetooth Device or Universal Adapter Connected to Headset	Flashes blue

*Flashes red when headset or universal adapter is **initially powered on***

PAIRING

Pairing with Bluetooth® Device

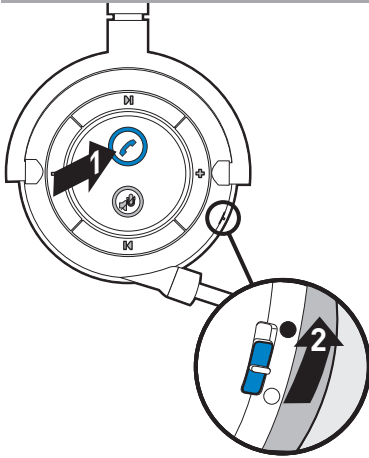

Begin with headset turned off.

1. Press and hold the call control button.
2. Power headset on and when the indicator light flashes red and blue, release the call control button.

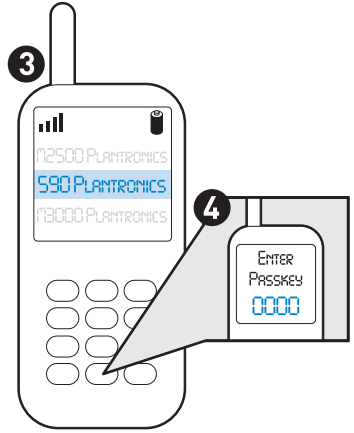

While headset is flashing red and blue:

3. Use the phone menu to search for Bluetooth devices and select "590 Plantronics."
4. When prompted for passkey, enter 0000.

Headset will flash blue when paired successfully.

For set up and pairing instructions with Bluetooth devices other than mobile phones, please consult your Bluetooth device user guide.

PAIRING

Pairing Headset with Universal Adapter

NOTE: The Pulsar 590A headset is paired with the universal adapter at the factory. If adapter and headset continue to flash red rather than blue, connect or pair them again. To reconnect, press the adapter pairing/connect button. To pair again, follow directions below.

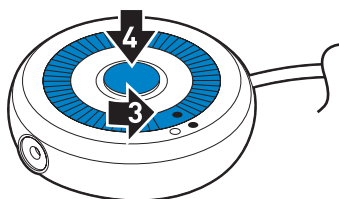
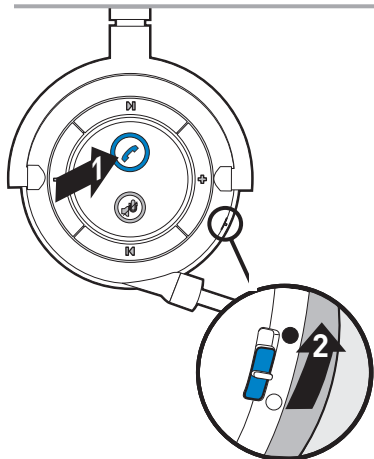

Begin with headset turned off.

1. Press and hold the call control button.
2. Power headset on and when the indicator light flashes red and blue, release the call control button.

While headset is flashing red and blue:

3. Power adapter on.
4. Press and hold the adapter pairing/connect button for 7-10 seconds. When adapter is flashing red and blue, release the button.

Headset and adapter will flash blue when paired successfully.

ADJUSTING FIT

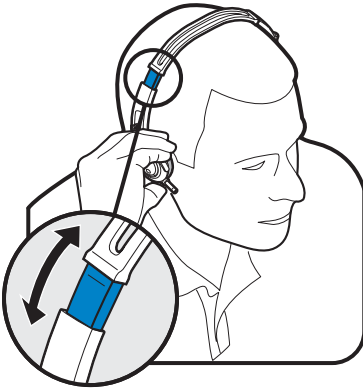

Position headset so that telescoping voice tube is on right ear. Adjust headband if necessary.

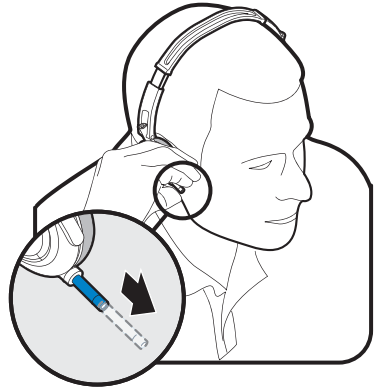

Point tip of telescoping voice tube toward mouth and extend for optimal voice transmission - may require two hands.

IN-FLIGHT AND WIRED USES

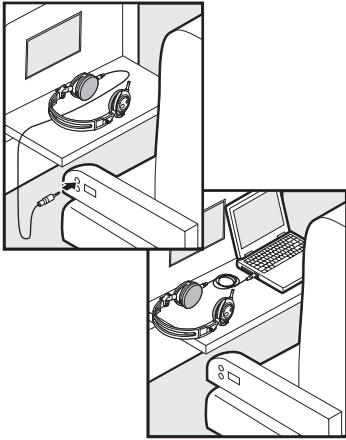

In-flight cable can be used with any 3.5mm audio jack to convert your wireless headset into wired headphones. Headset will not operate when in-flight cable is connected and headset is powered on.

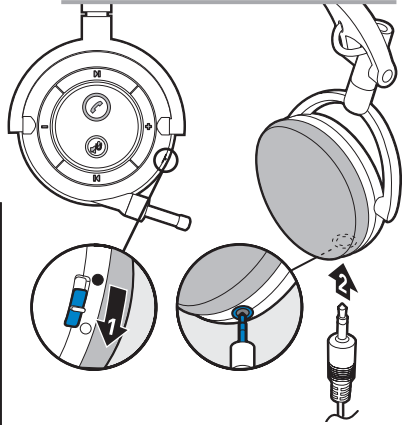

1. Power headset off.
2. Insert in-flight cable into 3.5mm jack on left earpiece.

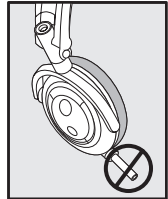

Note: Telescoping voice tube and all headset controls are disabled when in-flight cable is in use. To control volume, use the device connected to the in-flight cable, not the headset.

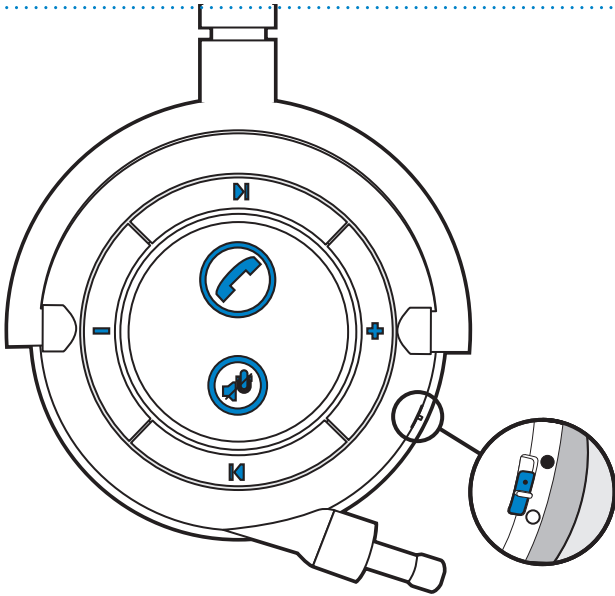

HEADSET CONTROLS







Features

Key	Feature	Action	Tone
	Making/answering/ ending calls	Short key press	High tone
	Switching an active call from headset to phone or phone to headset	Long key press	High tone followed by low tone
	Power On/Off	Slide switch	No tone



HEADSET CONTROLS

Features

Key	Feature	Action	Tone
	Track forward and back*	Short press to skip to next track or to go back to previous track	High tone
	Mute call/audio	Short press to mute/unmute telescoping voice tube or audio sound	Repeating low tone every 60 seconds
	Play and pause*	Short press to pause/resume audio	High tone
	Adjusting volume	Short press for incremental change, hold for continuous change	Mid tone for each adjustment, double low tone at limit

*Only works if Bluetooth device supports Bluetooth Audio/Video Remote Control Profile (AVRCP); does not work when using universal adapter.

Hands-Free Features

Key	Feature	Action	Tone
	Activate last number redial	Double short key press	High tone for each key press
	Activate voice dial	Long key press	High tone followed by low tone
	Call reject	Long key press	High tone followed by low tone

Features must be supported by Bluetooth device or service provider.

TROUBLESHOOTING

Pulsar 590 & 590A

Problem	Solution
My headset does not work with my phone.	See pages 7-8 "Pairing with Bluetooth Device."
Callers cannot hear me.	<ul style="list-style-type: none">• Headset is muted. Press the mute button on the headset to unmute the voice tube.• Be sure headset is paired with audio device. See pages 7-8 "Pairing with Bluetooth Device."
Callers say my voice is too quiet.	Ensure that the telescoping voice tube is fully extended and point the tip toward the corner of your mouth.
I cannot hear caller/dial tone or audio sound.	<ul style="list-style-type: none">• Headset is turned off. Check the power switch and slide up to "on".• Headset is out of range. Walk to within 33 feet (10 meters) of the phone and check the Bluetooth link.• Headset battery is dead. Charge your battery using the AC charger supplied.• Listening volume is too low. Press the volume up button to increase the sound heard in the headset.
Headset doesn't charge in the desktop charging stand.	<ul style="list-style-type: none">• Ensure foam cushions face each other. See page 5 "Charging."• Ensure that headset is completely inserted into the charging stand—if properly inserted, a red indicator light on the headset will slowly flash.
I cannot hear audio when using the in-flight cable.	Headset must be turned off when using the in-flight cable.

Pulsar 590A only

Problem	Solution
I cannot complete pairing with another Bluetooth device.	Universal adapter must be turned off when pairing to another device.
I do not get a sound from my headset when using the universal adapter.	<ul style="list-style-type: none">• It may take up to 30 seconds for the devices to connect and audio to stream.• Press the call control button on the headset or adapter after 30 seconds if there is still no sound.• Check audio mute on the headset. Press the mute button on the headset to unmute.• Check pairing. See page 8 "Pairing with Universal Adapter."• Power headset and universal adapter on/off.• Check that universal adapter is plugged into an active stereo audio source.
Volume is too high / low when listening to audio, but fine when making a phone call.	Check the volume of the audio source device. Adjust volume controls on headset.

PRODUCT SPECIFICATIONS

Listen Time*	Up to 10 hours	Power Requirements	5V DC - 300 mA
Talk Time*	Up to 12 hours	Battery Type	Lithium Ion Polymer
Standby Time*	Approximately 130 hours	Headset Speakers	28 mm Neodymium
Charge Time	2 hours	Speaker Frequency Response	•Telephony 300 Hz to 3600 Hz (CVSD u-Law) •Stereo Audio 20 Hz to 20 kHz(16-bit 48kHz SBC Coding)
Range	Bluetooth standard 33 feet (10 meters)	Impedance	32 +-4 Ohms x1 kHz
Headset Weight	97.7 grams (3.45 ounces)	Distortion	<5% to 19 kHz
Universal Adapter Weight	28.4 grams (1 ounce)	Version	Bluetooth 2.0
Power Requirements	5V DC - 300 mA		

Supports Bluetooth Hands-Free and Headset Profiles, Advanced Audio Distribution Profile (A2 DP), Audio/Video Remote Control Profile (AVRCP), and Generic Audio/Video Distribution Profile (GAVDP). For stereo sound, Bluetooth-enabled devices must support the Advanced Audio Distribution Profile (A2DP).

*Performance may vary by device.

TECHNICAL ASSISTANCE

The Plantronics Technical Assistance Center is ready to assist you! Dial (866) 363-BLUE(2583), or visit the Support section of our website at www.plantronics.com/support.

REGULATORY NOTICES

FCC Requirements Part 15

This device complies with Part 15 of the FCC Rules. Operation is subject to the following two conditions:

1. This device may not cause harmful interference, and
 2. This device must accept any interference received, including interference that may cause undesired operation.
- This equipment has been tested and found to comply with the limits for a Class B digital device, pursuant to Part 15 of the FCC Rules. These limits are designed to provide reasonable protection against harmful interference in a residential installation. This equipment generates, uses, and can radiate radio frequency energy and, if not installed and used in accordance with the instructions, may cause harmful interference to radio communications. However, there is no guarantee that interference will not occur in a particular installation. If this equipment does cause harmful interference to radio or television reception which can be determined by turning the radio or television off and on, the user is encouraged to try to correct interference by one or more of the following measures:
1. Reorient or relocate the receiving antenna.
 2. Increase the separation between the equipment and receiver.
 3. Connect the equipment into an outlet on another circuit.
 4. Consult the dealer or an experienced radio/TV technician for help.

Exposure to RF Radiation

The internal wireless radio operates within the guidelines found in radio frequency safety standards and recommendations, which reflect the consensus of the scientific community. Independent studies have shown that the internal wireless radio is safe for use by consumers. Visit www.plantronics.com for more information.

NOTE: Modifications not expressly approved by Plantronics, Inc. could void the user's authority to operate the equipment.



PLANTRONICS®

SOUND INNOVATION™

Warning!

Use of a headset that covers both ears will impair your ability to hear other sounds. Use of such a headset while operating a motor vehicle or riding a bicycle may create a serious hazard to you and/or others, and is prohibited by law in some regions.

Warranty

Limited Warranty

- This warranty covers defects in materials and workmanship of Mobile Products manufactured, sold or certified by Plantronics which were purchased and used in the United States.
- This warranty lasts for one year from the date of purchase of the Products.
- This warranty extends to you only if you are the end user with the original purchase receipt.
- We will, at our option, repair or replace the Products that do not conform to the warranty. We may use functionally equivalent reconditioned/ refurbished/ remanufactured/ pre-owned or new Products or parts.
- To obtain service in the U.S. contact Plantronics at (866) 363-BLUE (2583).
- THIS IS PLANTRONICS' COMPLETE WARRANTY FOR THE PRODUCTS.
- This warranty gives you specific legal rights, and you may also have other rights which vary from state to state. Please contact your dealer or our service center for the full details of our limited warranty, including items not covered by this limited warranty.

© 2005 Plantronics, Inc. All rights reserved. Plantronics, the logo design, Pulsar and Sound Innovation are trademarks or registered trademarks of Plantronics, Inc. The Bluetooth name and the Bluetooth trademarks are owned by Bluetooth SIG, Inc, and are used by Plantronics, Inc. under license.

Printed in USA. August 2005.

Part #69828-07