

ENGLISH

Canon PowerShot A430 PowerShot A420 DIGITAL CAMERA



Before Using the Camera

Shooting

Playback/Erasing

Print/Transfer Settings

Shooting/Viewing Images on a TV Set **A430**

Customizing the Camera **A430**

Troubleshooting

List of Messages

Appendix

Advanced

Camera User Guide

This guide explains camera features and procedures in detail.

DiGiC II



Exif Print



Main Features

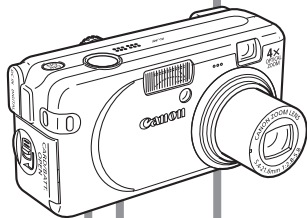

Shooting

- Automatically adjusts shooting settings to match particular conditions (Special Scene mode)
- Changes image colors to create special effects (Color Accent, Color Swap modes)
- **A430** Automatically detects camera orientation with an Intelligent Orientation sensor.

Playback

- Plays movies (**A430** with audio)
- Auto Play

Editing

- Edits movies
- **A430** Records sound memos for still images.

Printing

- Makes printing easy with the Print/Share button
- Also supports non-Canon brand *PictBridge* compliant printers







Uses of Recorded Images

- Effortlessly transfer them to a computer with the Print/Share button

This guide uses illustrations of the PowerShot A430.

Conventions Used in this Guide

Icons appearing below titles indicate the modes in which the procedure can be used. In the example below, the mode dial can be used in the following shooting modes.

-  M (Manual)
-  SCN (Special Scene)
-  M* (Manual)
-  S* (Super Macro)
-  A* (Color Accent)
-  S* (Color Swap)

* Black square icons are modes in the FUNC. menu.

Switching between Focusing Modes

Shooting Mode      SCN

- See Functions Available in Each Shooting Mode (p. 110).

In this guide, the *Basic Camera User Guide* is referred to as the *Basic Guide*, and the *Advanced Camera User Guide* is referred to as the *Advanced Guide*.



This mark denotes issues that may affect the camera's operation.



This mark denotes additional topics that complement the basic operating procedures.

A430

This icon appears for functions and notes that apply only to the PowerShot A430.

You can use SD* memory cards and MultiMediaCards with this camera. These cards are collectively called memory cards in this guide.

* SD stands for Secure Digital, a copyright protection system.

Use of genuine Canon accessories is recommended.

This product is designed to achieve excellent performance when used with genuine Canon accessories. Canon shall not be liable for any damage to this product and/or accidents such as fire, etc., caused by the malfunction of non-genuine Canon accessories (e.g., a leakage and/or explosion of a battery pack). Please note that this warranty does not apply to repairs arising out of the malfunction of non-genuine Canon accessories, although you may request such repairs on a chargeable basis.

Table of Contents

Items marked with a ☆ are lists or charts that summarize camera functions or procedures.

Conventions Used in this Guide	1
Handling Precautions	5
Please Read	5
Safety Precautions	6
Preventing Malfunctions	11
Before Using the Camera—The Components Guide	12
Before Using the Camera—Basic Operations	15
Using the LCD Monitor	15
Information Displayed on the LCD Monitor	16
Using the Viewfinder	19
Indicators	19
Power Saving Function	20
Menus and Settings	21
Menu List	23
Resetting Settings to Their Default Values.	28
Formatting Memory Cards	29
Shooting	30
Changing the Recording Pixels and Compression (Still Images) 30	30
Magnified Close-Up Shooting (Super Macro).	31
Using the Digital Zoom.	32
Continuous Shooting	33
Postcard Date Imprint Mode.	34
Using the Self-Timer.	35
🎬 Movie Shooting.	37
Shooting Panoramic Images (Stitch Assist).	40
Changing the Colors and Shooting	42
Switching between Focusing Modes	46
Shooting Hard-to-Focus Subjects (Focus Lock).	47
Switching between Metering Modes.	47
Adjusting the Exposure Compensation	48
Adjusting the Tone (White Balance)	49



Shooting in a My Colors Mode	51
Adjusting the ISO Speed	53
A430 Setting the Auto Rotate Function	54
Creating an Image Destination (Folder)	55
Resetting the File Number	56
Playback/Erasing	58
Q Magnifying Images	58
Viewing Images in Sets of Nine (Index Playback)	59
Viewing Movies	59
Editing Movies	60
Rotating Images in the Display	62
A430 Attaching Sound Memos to Images	62
Automated Playback (Auto Play)	64
Protecting Images	64
Erasing All Images	65
Print Settings/Transfer Settings	66
Setting the DPOF Print Settings	66
Setting the DPOF Transfer Settings	69
A430 Shooting/Viewing Images on a TV set	71
A430 Customizing the Camera (My Camera Settings)	72
Changing My Camera Settings	72
Troubleshooting	73
Camera	73
When the power is turned on	74
LCD monitor	74
Shooting	75
Shooting Movies	79
Playback	80
Battery	80
A430 TV monitor output	81
Direct print compatible printers	81
List of Messages	82

Appendix.	85
Battery Handling.	85
Handling the Memory Card	87
Replacing the Date Battery	89
Using an AC Adapter Kit (Sold Separately)	90
Using Rechargeable Batteries (Sold Separately)	91
Using an Externally Mounted Flash (Sold Separately)	93
Camera Care and Maintenance	95
Specifications	96
INDEX.	106
☆ Functions Available in Each Shooting Mode	110

Handling Precautions

Please Read

Test Shots

Before you try to photograph important subjects, we highly recommend that you shoot several trial images to confirm that the camera is operating and being operated correctly.

Please note that Canon Inc., its subsidiaries and affiliates, and its distributors are not liable for any consequential damages arising from any malfunction of a camera or accessory, including memory cards, that results in the failure of an image to be recorded or to be recorded in a way that is machine readable.

Warning Against Copyright Infringement

Please note that Canon digital cameras are intended for personal use and should never be used in a manner that infringes upon or contravenes international or domestic copyright laws and regulations. Please be advised that in certain cases the copying of images from performances, exhibitions, or commercial properties by means of a camera or other device may contravene copyright or other legal rights even if the image was shot for personal use.

Warranty Limitations

For information on your camera's warranty, please refer to the Canon European Warranty System (EWS) Booklet supplied with your camera.

For Canon Customer Support contacts, please see rear of the European Warranty System (EWS) Booklet.

Camera Body Temperature

If your camera is used for prolonged periods, the camera body may become warm. Please be aware of this and take care when operating the camera for an extended period.

About the LCD Monitor

The LCD monitor is produced with extremely high-precision manufacturing techniques. More than 99.99% of the pixels operate to specification. Less than 0.01% of the pixels may occasionally misfire or appear as red or black dots. This has no effect on the recorded image and does not constitute a malfunction.

Language Setting

Please see the *Basic Guide* (p. 3) to change the language setting.

Safety Precautions

- Before using the camera, please ensure that you read and understand the safety precautions described below. Always ensure that the camera is operated correctly.
- The safety precautions noted on the following pages are intended to instruct you in the safe and correct operation of the camera and its accessories to prevent injuries or damage to yourself, other persons and equipment.
- Equipment refers to the camera, battery, battery charger or separately sold compact power adapter.

⚠ Warnings

Equipment

- **Do not aim the camera directly into the sun or at other intense light sources that could damage your eyesight.**
- **Store this equipment out of the reach of children and infants. Accidental damage by a child could result in serious injury.**
 - Wrist strap: Placement of the strap around the child's neck could result in asphyxiation.
 - Memory card: It may be swallowed accidentally. If this occurs, contact a doctor immediately.

- **Do not attempt to disassemble or alter any part of the equipment that is not expressly described in this guide.**
- **To avoid the risk of high-voltage electrical shock, do not touch the flash portion of the camera if it has been damaged.**
- **Stop operating the equipment immediately if it emits smoke or noxious fumes.**
- **Do not allow the equipment to come into contact with, or become immersed in, water or other liquids. If the exterior comes into contact with liquids or salt air, wipe it dry with a soft, absorbent cloth.**

Continued use of the equipment may result in fire or electrical shock. Immediately turn the camera power off and remove the camera battery or unplug the power cord from the power outlet. Please consult your camera distributor or the closest Canon Customer Support Help Desk.

- **Do not use substances containing alcohol, benzene, thinners or other flammable substances to clean or maintain the equipment.**
- **Do not cut, damage, alter or place heavy items on the power cord.**
- **Use only recommended power accessories.**
- **Remove the power cord on a regular periodic basis and wipe away the dust and dirt that collects on the plug, the exterior of the power outlet and the surrounding area.**
- **Do not handle the power cord if your hands are wet.**

Continued use of the equipment may result in fire or electrical shock.

Battery

- Do not place the battery near a heat source or expose it to direct flame or heat.
- The battery should not be immersed in water or sea water.
- Do not attempt to disassemble, alter or apply heat to the battery.
- Avoid dropping or subjecting the batteries to severe impacts that could damage the casing.
- Use only recommended batteries and accessories.

Use of batteries not expressly recommended for this equipment may cause explosions or leaks, resulting in fire, injury and damage to the surroundings. In the event that a battery leaks and the eyes, mouth, skin or clothing contact these substances, immediately flush with water and seek medical assistance.

- Disconnect the battery charger and compact power adapter from both the camera and the power outlet after recharging or when they are not in use to avoid fire and other hazards.
- Do not place anything, such as tablecloths, carpets, bedding or cushions, on top of the battery charger while it is charging.

Continued use over a long period may cause the units to overheat and distort, resulting in fire.

- Please use Canon AA-size NiMH batteries and charger recommended for use with these batteries.
- The compact power adapter are designed for exclusive use with your camera. Do not use it with other products or batteries.

There is a risk of overheating and distortion which could result in fire or electrical shock.

- Before you discard a battery, cover the terminals with tape or other insulators to prevent direct contact with other objects.

Contact with the metallic components of other materials in waste containers may lead to fire or explosions.

Others

- **Do not trigger the flash in close proximity to human or animal eyes. Exposure to the intense light produced by the flash may damage eyesight.**

In particular, remain at least one meter (39 inches) away from infants when using the flash.

- **Keep objects that are sensitive to magnetic fields (such as credit cards) away from the speaker of the camera (PowerShot A430 only).**

Such items may lose data or stop working.

⚠ Cautions

Equipment

- **Be careful not to bang the camera or subject it to strong impacts or shocks that could lead to injury or damage the equipment when wearing or holding it by the strap.**

- **Do not store the equipment in humid or dusty areas.**
- **Do not allow metal objects (such as pins or keys) or dirt to contact the charger terminals or plug.**

Such conditions could lead to fire, electrical shock or other damage.

- **Avoid using, placing or storing the equipment in places subject to strong sunlight or high temperatures, such as the dashboard or trunk (boot) of a car.**
- **Ensure that the battery charger is plugged into a power outlet of the specified rating, not over the specified rating. Do not use if the power cord or plug are damaged, or if not fully plugged into the outlet.**
- **Do not use in locations with poor ventilation.**

The above-mentioned can cause leakage, overheating or explosion, resulting in fire, burns or other injuries. High temperatures may also cause deformation of the casing.

- **When not using the camera for extended periods of time, remove the battery from the camera or battery charger and store the equipment in a safe place.**

Storing the camera for extended periods with batteries installed will cause battery leakage and damage the camera.

Flash

- **Do not operate the flash with dirt, dust or other items stuck to the surface of the flash.**
- **Be careful not to cover the flash with your fingers or clothing when shooting.**

The flash may be damaged and emit smoke or noise. The resulting heat build-up could damage the flash.

- **Do not touch the surface of the flash after taking several pictures in rapid succession.**

Doing so could result in burns.

Preventing Malfunctions

Avoid Strong Magnetic Fields

- **Never place the camera in close proximity to electric motors or other equipment generating strong electromagnetic fields.**

Exposure to strong magnetic fields may cause malfunctions or corrupt image data.

Avoid Condensation Related Problems

- **When moving the equipment rapidly between hot and cold temperatures, you can avoid condensation by placing the equipment in an airtight, resealable plastic bag and letting it adjust to temperature changes slowly before removing it from the bag.**

Moving the equipment rapidly between hot and cold temperatures may cause condensation (water droplets) to form on its external and internal surfaces.

If Condensation Forms Inside the Camera

- **Stop using the camera immediately.**

Continued use may damage the equipment. Remove the memory card and battery or compact power adapter from the camera and wait until the moisture evaporates completely before resuming use.

Before Using the Camera—The Components Guide

Front View

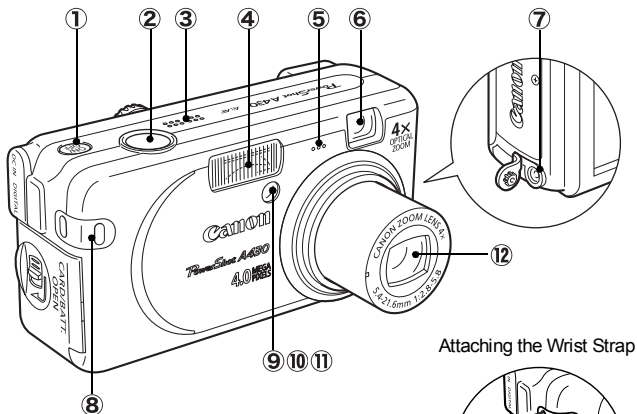

Attaching the Wrist Strap

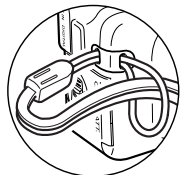

- ① Power Button (*Basic Guide* p. 2)
- ② Shutter Button (*Basic Guide* p. 4)
- ③ **A430** Speaker
- ④ Flash (*Basic Guide* p. 8)
- ⑤ **A430** Microphone (p. 62)
- ⑥ Viewfinder Window (p. 19)
- ⑦ **A430** A/V OUT (Audio/Video output) Terminal (p. 71)
- ⑧ Wrist Strap Mount
- ⑨ AF-assist Beam (p. 24)
- ⑩ Red-Eye Reduction Lamp (*Basic Guide* p. 8)
- ⑪ Self-Timer Lamp (p. 35)
- ⑫ Lens

Back View

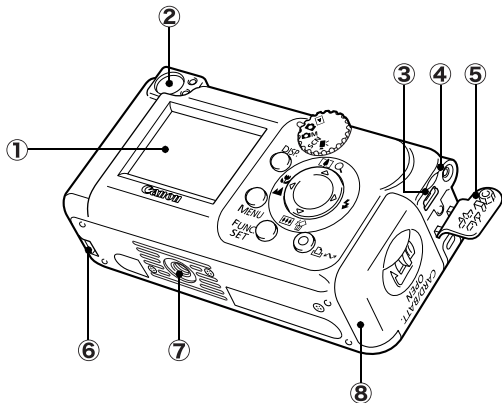

- ① LCD Monitor (p. 15)
- ② Viewfinder (p. 19)
- ③ DIGITAL Terminal (*Basic Guide* p. 17)
- ④ DC Coupler Terminal (p. 90)
- ⑤ Terminal Cover
- ⑥ Coin Battery Holder (p. 89)
- ⑦ Tripod Socket
- ⑧ Memory Card Slot/Battery Cover (*Basic Guide* p. 1)

Operation Panel

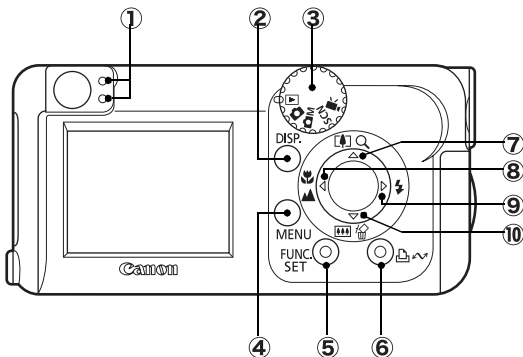

- ① Indicator (p. 19)
- ② **DISP.** (Display) Button (p. 15)
- ③ Mode Dial (*Basic Guide* p. 5)
- ④ **MENU** Button (p. 22)
- ⑤ **FUNC./SET** (Function/Set) Button (p. 21)
- ⑥ (Print/Share) Button (*Basic Guide* p. 13)
- ⑦ (Telephoto) (when shooting)/ (Magnify) (when playing)/ button (*Basic Guide* p. 8/p. 32, 58)
- ⑧ (Macro)/ (Infinity)/ button (*Basic Guide* p. 9)
- ⑨ (Flash)/ button (*Basic Guide* p. 8)
- ⑩ (Wide Angle) (when shooting)/ (Single Image Erase) (when playing)/ button (*Basic Guide* p. 8, 10, p. 32)

Using the LCD Monitor



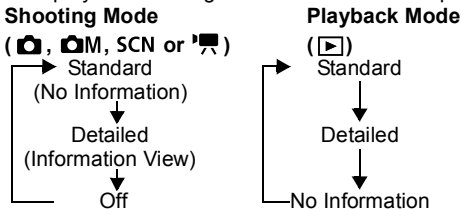

1 Press the DISP. button.

- The display mode changes as follows with each press.



- In the shooting modes, the shooting information displays for approximately 6 sec. when changing modes, or when the  or  button is pressed, regardless of the selected display mode.



- The LCD monitor on or off setting is remembered even after the camera power is turned off.
- The LCD monitor does not shut off in the  (Super Macro),  (Color Accent),  (Color Swap),  (Stitch Assist) or  (Movie) mode.
- The LCD monitor will not switch to the detailed display in the index playback mode (p. 59).

LCD Monitor Brightness

The brightness of the LCD monitor can be adjusted to better suit the shooting conditions.

You can change the brightness of the LCD monitor using the Set up menu (p. 25).

Night Display

When shooting in dark conditions, the camera automatically brightens the LCD monitor to suit the brightness of the subject*, making it easier to frame the subject.

* The movements of the subject will appear irregular in the LCD monitor. The recorded image, however, will not be affected. The brightness of the image displayed in the monitor, and the brightness of the actual image recorded will be different.

Information Displayed on the LCD Monitor



Shooting mode

The diagram shows a camera's LCD monitor in shooting mode, displaying a cityscape scene. Various information overlays are shown around the monitor, each with a callout line pointing to its location on the screen. The information is organized into several boxes:

- Top Left:**
 - [] * Spot Frame
 - * AF Frame (p. 46)
 - ▣ * Low Battery (p. 85)
- Top Right:**
 - Macro/Infinity (Basic Guide p. 9)
 - Flash (Basic Guide p. 8)
 - (Red)*
 - Movie Recording (p. 37)
 - Auto Rotate (p. 54)
- Right Side:**
 - Zoom Magnification (p. 32)*
 - Folder Creation (p. 55)
 - Grid Lines* (p. 24)
 - Stills: Recordable Shots
 - Movies: Remaining Time/ Elapsed Time
- Bottom Left:**
 - Shooting Mode (Basic Guide p. 5/p. 31, 37, 40, 51)
 - Exposure Compensation (p. 48)
 - ISO Speed (p. 53)
 - White Balance (p. 49)
 - Shooting Method (p. 33, 35)
 - My Colors (p. 51)
- Bottom Right:**
 - Recording Pixels (p. 30)
 - Compression (p. 30)
 - Recording Pixels/ Frame Rate (Movie) (p. 39)
 - Camera Shake Warning (p. 74)

* Appears even if the LCD monitor is set to Standard (No Information)



- If the indicator blinks orange and the camera shake icon  displays, it may indicate slow shutter speed due to insufficient lighting. Increase the ISO speed (p. 53), select a setting other than  (Flash off), or attach the camera to a tripod or other device.
- During shooting, you can display a grid to help you determine if your camera is level (p. 24).

Playback Mode

Standard

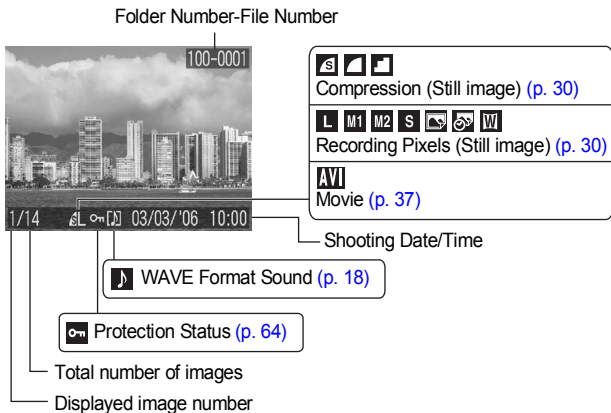

Detailed



White Balance (p. 49)

My Colors (p. 51)

ISO Speed (p. 53)

Recording Pixels/
Frame Rate (Movies) (p. 39)

Shooting Mode (*Basic Guide* p. 6/
p. 31, 37, 40, 51)

Exposure Compensation (p. 48)

Flash (*Basic Guide* p. 8)

Metering Mode (p. 47)

Macro/Infinity (*Basic Guide* p. 9)

Recording Time (Movie) (p. 37)

The following information may also be displayed with some images.

	A sound file in a format other than the WAVE format is attached, or the file format is not recognized.
	JPEG image not conforming to Design rule for Camera File System Standards
	RAW image
	Unrecognized data type



Information for images shot on other cameras may not display correctly.

Using the Viewfinder

The viewfinder can be used to conserve power by turning the LCD monitor off (p. 15) while shooting.

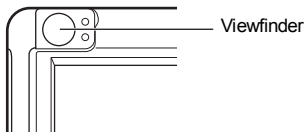

Indicators

The indicators light or blink under the following conditions.



Never do the following while an indicator is lit. These actions may corrupt image data.

- Shake or jolt the camera
- Shut off the power, or open the memory card slot/battery cover

● Upper Indicator

- Green:** Ready to shoot
- Blinking Green:** Image recording/reading/erasing/transferring (when connected to a computer)
- Orange:** Ready to shoot (flash on)
- Blinking Orange:** Ready to shoot (camera shake warning)/
Flash is charging

● Lower Indicator

- Yellow:** Macro mode/infinity mode
- Blinking Yellow:** Focusing difficulty (camera beeps once)

Power Saving Function

This camera is equipped with a power saving function. The power will shut off in the following circumstances. Press the power button again to restore power.

Shooting Mode	Powers down approximately 3 minutes after the last control is accessed on the camera. The LCD monitor automatically turns off 1 minute* after the last control is accessed even if [Auto Power Down] is set to [Off]. Press any button other than the power button (A430) or change the camera orientation with the Power Shot A430) to turn the LCD monitor back on.
Playback Mode or Connected to a Printer	Powers down approximately 5 minutes after the last control is accessed on the camera.

* Default Setting (time can be changed).



- The power saving function will not activate during Auto Play or while the camera is connected to a computer.
- The power saving function settings can be changed (p. 26).

Menus and Settings

Menus are used to set the shooting and playback settings as well as such camera settings as the date/time and electronic beep. The following menus are available.

- **FUNC. Menu**

- **Rec., Play, Print, Set up, and A430 My Camera Menus**

FUNC. Menu

This menu sets many of the common shooting functions.

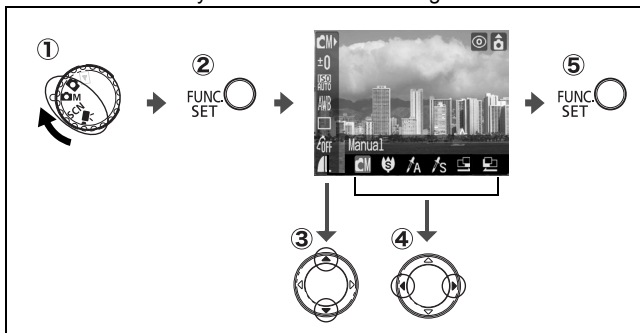

- ① **Set the camera to the shooting mode.**
- ② **Press the FUNC./SET button.**
- ③ **Use the ▲ or ▼ button to select a menu item.**
Some items may not be selectable in some shooting modes.
- ④ **Use the ◀ or ▶ button to select an option for the menu item.**

You can select further options with the **MENU** button for some options.

After selecting an option, you can press the shutter button to shoot immediately. After shooting, this menu will appear again, allowing you to adjust the settings easily.

- ⑤ **Press the FUNC./SET button.**

Rec., Play, Print, Set up, and **A430** My Camera Menu

Convenient settings for shooting, playback or printing can be set with these menus.

① MENU →

② You can switch between menus with the button when this part is selected.

③ ④























⑤ MENU

* This example shows the Rec. menu.
* In playback mode, the Play menu, Print menu, Set up menu, and **A430** My Camera menu displays.

- ① **Press the MENU button.**
- ② **Use the ◀ or ▶ button to switch between menus.**
- ③ **Use the ▲ or ▼ button to select menu items.**
Some items may not be selectable in some shooting modes.
- ④ **Use the ◀ or ▶ button to select an option.**
Menu items followed by an ellipsis (...) can only be set after pressing the **FUNC./SET** button to display the next menu.
Press the **FUNC./SET** button or **MENU** button again to confirm the setting.
- ⑤ **Press the MENU button.**











Menu List

FUNC. Menu

	Menu Item	Reference Page
	Manual Mode	
	Manual	<i>Basic Guide</i> p. 6
	Super Macro	p. 31
	Color Accent	p. 42
	Color Swap	p. 43
	Stitch Assist (Left to Right)	p. 40
	Stitch Assist (Right to Left)	
	Special Scene Mode	<i>Basic Guide</i> p. 7
	Movie Mode	p. 37
	Exposure Compensation	p. 48
	ISO Speed	p. 53
	White Balance	p. 49
	Drive Mode (Shooting Method)	
	Single	p. 33
	Continuous Shooting	
	Self-Timer (10-sec.)	p. 35
	Self-Timer (2-sec.)	
	Self-Timer (Custom)	
	My Colors	p. 51
	Recording Pixels (Still Image)	p. 30
	Compression (Still Image)	p. 30
	Recording Pixels/Frame Rate (Movie)	p. 39







Rec. Menu

*Default setting

Menu Item	Options	Reference Page
 AiAF	On*/Off	p. 46
 Metering Mode	 * Evaluative,  Center-Weighted Average,  Spot	p. 47
 AF-assist Beam	On*/Off	-
 Digital Zoom	On/Off* (On in standard movie mode.)	p. 32
 Review	Off/2*–10 seconds/Hold	<i>Basic Guide</i> p. 5
 Save Original	On/Off*	p. 45
 Grid Lines* ¹	On/Off*	p. 24 * ¹
 Date Stamp	Off*/Date/Date & Time	p. 34

*1 Allows you to display a grid (9 sections) on the LCD monitor to help in determining the X- and Y-axis of the subject and composing the shot. The grid lines will not be recorded in the image.

Play Menu



Menu Item	Reference Page
 Auto Play	p. 64
 Protect	p. 64
 Rotate	p. 62
 Erase All	p. 65
 A430 Sound Memo	p. 62
 Transfer Order	p. 69













Print Menu



Menu Item	Reference Page
Print	p. 66
Select Images & Qty.	p. 66
Select All Images	p. 67
Clear All Selections	p. 67
Print Settings	p. 68

Set up Menu

*Default setting

Menu Item	Options	Reference Page
 Mute	On/Off*	Set to [On] to silence all sounds except the warning that sounds when the memory card slot/battery cover is open while data is being saved onto the memory card. (<i>Basic Guide</i> p. 2).
 A430 Volume	Off/1/2*/3/4/5	Adjusts the volume of the start-up, operation, self-timer, shutter, and playback sounds. The volume cannot be adjusted if [Mute] is set to [On].
Start-up Vol.		Adjusts the volume of the start-up sound when the camera is turned on.
Operation Vol.		Adjusts the volume of the beeps that sound when any button other than the shutter button is pressed during operation.
Selftimer Vol.		Adjusts the volume of the self-timer sound played 2 sec. before the shutter is released.
Shutter Volume		Adjusts the volume of the sound played when the shutter releases. The shutter sound does not play while a movie is recording.
Playback Vol.		Adjusts the volume of movie sounds and sound memos.
 LCD Brightness	-7 to 0 to +7*	Use the ◀ or ▶ button to adjust the brightness. If you press the ▲ or ▼ button, the display returns to the Set up menu. You can check the brightness in the LCD monitor while you are adjusting the setting.

 Power Saving		p. 20
Auto Power Down	On*/Off	Sets whether or not the camera automatically powers down after a set period of time elapses without the camera being operated.
Display Off	10 sec./20 sec./30 sec./1 min.*/2 min./3min.	Sets the length of time before the LCD monitor turns off when no camera operation is performed.
 Date/Time		<i>Basic Guide</i> (p. 2)
 Format		p. 29
 File Number	Continuous*/Auto Reset	p. 57
 Create Folder		p. 55
Create New Folder	Check mark (On)/No check mark (Off)	Creates a folder for the next shooting session.
Auto Create	Off*/Daily/Monday-Sunday/Monthly	You can also set a creation time.
 A430 Auto Rotate	On*/Off	p. 54
 Lens Retract	1 min.*/0 sec.	Adjusts the timing it takes for the lens to retract after entering Playback mode from Shooting mode.
 Language		<i>Basic Guide</i> (p. 3)
 A430 Video System	NTSC/PAL	p. 71
 Print Method	Auto*/  (PictBridge connection)	See below ^{*2}
 Reset All		p. 28

*2 Allows you to switch the connection method of the printer. There is no need to switch under normal circumstances, but when borderless printing images taken in  (Wide) recording pixels on an entire side of wide size paper with the SELPHY CP710/CP510 Canon Compact Photo Printer, select . This setting is remembered even after turning the power off, so be sure to switch back to Auto when printing image sizes other than .

A430 My Camera Menu

*Default setting

Menu Item	Options	Summary	Reference Page
Start-up Image	Off/On*	Select whether to display the set start-up screen when the camera is turned on	p. 72
Start-up Sound	Off/On*	Select whether to play the set start-up sound when the camera is turned on.	p. 72
Operation Sound	Off/On*	Select whether to activate operation sounds when any button other than the shutter button is pressed.	p. 72
Selftimer Sound	Off/On*	Select whether to have a set sound notify you 2 sec. before a self-timed shooting.	p. 72
Shutter Sound	Off/On*	Select whether to activate the shutter sound when the shutter button is pressed fully.	p. 72

Resetting Settings to Their Default Values





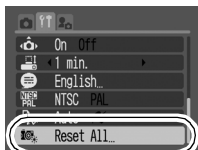

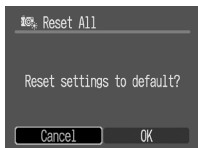

1 (Set up) Menu → (Reset All).

See *Menus and Settings* (p. 22)



2 Select [OK] and press the **FUNC./SET** button.



- Settings cannot be reset when the camera is connected to a computer or to a printer.
- The following cannot be reset.
 - Shooting mode
 - The  (Date/Time) and  (Language) options in the  (Set up) menu (p. 26)
 -   (Video System) (p. 26)
 - White balance data recorded with the custom white balance function (p. 50)
 - Colors specified in the  (Color Accent) (p. 42) or  (Color Swap) (p. 43) modes
 -  Newly added My Camera settings (p. 72)

Formatting Memory Cards

You should always format a new memory card or one from which you wish to erase all images and other data.



Please note that formatting (initializing) a memory card erases all data, including protected images and other file types.

1

[F] (Set up) Menu → **[F] (Format)** → **FUNC./SET** button.

See *Menus and Settings* (p. 22).

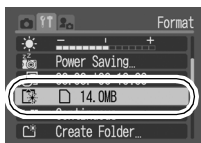

2

Select [OK] and press the FUNC./SET button.

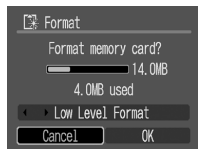

- To perform a low level format, use the **▲** button to select [Low Level Format] and the **◀** or **▶** button to add a check mark.
- If [Low Level Format] is selected, you can cancel formatting partway by pressing the **FUNC./SET** button. You can still use the memory card without problem even if formatting was halted partway, but the data is erased completely.



Low Level Format

You should select the [Low Level Format] option if you suspect the read/write speed of a memory card has dropped. A low level format may require 2 to 3 minutes with some memory cards.

Changing the Recording Pixels and Compression (Still Images)

Shooting Mode   

1 FUNC. Menu → * (Compression/Recording Pixels).

See *Menus and Settings* (p. 21).

- Use the ◀ or ▶ button to select recording pixels settings.

* Default setting.





2 Press the Menu button.

- Use the ◀ or ▶ button to select compression and press the FUNC./SET button.







Approximate Values for Recording Pixels

Recording Pixels		Purpose	
L (Large)	2272 × 1704 pixels	High ↑ ↓ Low	Print up to A4-size prints* 210 × 297 mm (8.3 × 11.7 in.)
			Print up to Letter-size prints* 216 × 279 mm (8.5 × 11 in.)
M1 (Medium 1)	1600 × 1200 pixels		Print postcard-size prints 148 × 100 mm (5.8 × 3.9 in.)
			Print L-size prints 119 × 89 mm (4.7 × 3.5 in.)
M2 (Medium 2)	1024 × 768 pixels	Print credit card-size prints	
S (Small)	640 × 480 pixels	Print on wide size paper (Send images as e-mail attachments Shoot more images)	

 (Postcard Date Imprint Mode)	1600 × 1200 pixels	When printing to postcards (p. 34), the compression rate is set to  (Fine).
 (Wide)	2272 × 1280 pixels	Print on wide paper (Records at a 16:9 height-to-width aspect ratio. Portions not recorded are left black.)

* Paper sizes vary according to region.



Approximate Values for Compression Settings

Compression		Purpose
 Superfine	High Quality	Shoot higher quality images
 Fine	  Normal	Shoot normal quality images
 Normal		Shoot more images



- See *Image Data Sizes (Estimated)* (p. 103).
- See *Memory Cards and Estimated Capacities* (p. 102).

Magnified Close-Up Shooting (Super Macro)

Shooting Mode  ()

You can shoot a subject from as close as 1 cm (0.39 in.) (minimum focal distance) with an area of 17 × 13 mm (0.67 × 0.51 in.) at the maximum wide angle setting.

1 FUNC. Menu → (Super Macro).

See *Menus and Settings* (p. 21).



Using the Digital Zoom

Shooting Mode



By combining the digital and optical zooms, you can shoot with images zoomed.

PowerShot A430

- Still images: approximately 14x max.
(Super macro: approximately 3.6x max.)
- Movies (standard): approximately 7.9x max.

PowerShot A420

- Still images: approximately 11x max.
(Super macro: approximately 3.6x max.)
- Movies (standard): approximately 6.4x max.



- The digital zoom cannot be used when the LCD monitor is turned off.
- The digital zoom cannot be used with (Postcard Date Imprint Mode) or (Wide) recording pixels.

1

(Rec.) Menu → (Digital Zoom) → [On].

See *Menus and Settings* (p. 22).

- [On] is the default setting for Super Macro and Movie (standard).



2

Press button and shoot.

- The combined digital and optical zoom setting will display in the LCD monitor.
- When you press the button, the zoom stops when the lens reaches the maximum optical telephoto setting (when shooting still images).
Press the button again to activate the digital zoom and further zoom the image digitally.
- Press the button to zoom out.



- Images become coarser the more they are digitally zoomed.
- When shooting movies digital zoom can be used in (standard) only.

Continuous Shooting

Shooting Mode    

In this mode, the camera shoots continuously while the shutter button is held down. In addition, continuous shooting is possible (p. 102) at a consistent interval (smooth continuous shooting) with a recommended memory card* until the memory card is full.

* A super high-speed SDC-512MSH memory card (sold separately) that has been low level formatted (p. 29) before shooting is recommended.

- This reflects standard shooting criteria established by Canon. Actual results may vary according to the subject and shooting conditions.
- Even if continuous shooting suddenly stops, the memory card may not be full.

1 FUNC./Menu → * (Drive Mode) → .

See *Menus and Settings* (p. 21).



* Default setting.

2 Shoot.

- The camera will continue to record successive images while the shutter button is held down. Recording will cease when the shutter button is released.

To Cancel Continuous Shooting

FUNC. Menu →  → .



- The interval between shots may lengthen if the internal memory becomes full.
- If the flash fires, the interval between shots may lengthen.

Postcard Date Imprint Mode

Shooting Mode



You can shoot images with the optimal settings for postcards by composing them inside the print area (width-to-height ratio of approximately 3:2) shown in the LCD monitor.

1 FUNC. Menu → [M] * (Compression/Recording Pixels) → [Postcard].

See *Menus and Settings* (p. 21).

- The recording pixels are set to **M1** (1600 × 1200) and the compression to [Fine].
- When you press the shutter button halfway, the area outside the size of the postcard that will not get printed grays out.

* Default setting.



The digital zoom cannot be used in this mode.



For printing instructions, refer to the *Direct Print User Guide*.

Embedding the Date in the Image Data

You can embed the date in image data when [Postcard Date Imprint Mode] is selected.

1 [Rec.] Menu → [Date Stamp] → [Date]/[Date & Time].

See *Menus and Settings* (p. 22).

In the LCD monitor

[Off] : [Off]

[Date] : [Date]/[Date & Time]







- Ensure that the camera's date/time is set beforehand (p. 26).
- The date stamp cannot be deleted from the image data once it has been set.

Using the Self-Timer







Shooting Mode



You can set the shutter to a 10 sec. () or 2 sec. delay (), or to a custom delay time and number of shots () Custom Timer), for shooting after the shutter button is pressed.

1 FUNC. Menu → * (Drive Mode) → //.

See Menus and Settings (p. 21).

- The following occurs with each option.
 - : 2 sec. before the shutter releases, the self-timer sound and lamp will speed up.
 - : The self-timer sound will play when the shutter button is pressed and the shutter will release 2 sec. later.
 - : You can change the delay time and number of shots (p. 36). , ,  and  modes cannot be set.

* Default setting.



2 Shoot.

- When the shutter button is pressed fully, the self-timer lamp will blink (when using Red-Eye Reduction, it will light before 2 sec.).

To Cancel the Self-Timer

Select  in step1.



Turning off the self-timer sound (p. 25).

Changing the Delay Time and Number of Shots (📷).

You can change the delay time (0–10, 15, 20, 30 sec.) and number of shots (1–10).

1 **FUNC. Menu** → **📷 (Drive Mode)** → **📷**.

See *Menus and Settings* (p. 22).



2 **Press the MENU button.**

- Use the ▲ or ▼ to select the [Delay]/[Shots] and use the ◀ or ▶ to change settings, then press the **FUNC./SET** button.
- The self-timer sound will behave as follows.
 - If a delay time of over 2 sec. has been specified, the self-timer sound will start and play rapidly 2 sec. before the specified delay.
 - If multiple shots have been specified for the [Shots] option, the sound will play for the first shot only.





- If the [Shots] option is set to 2 or more shots, the following occurs.
- The exposure and white balance are locked at the settings selected for the first shot.
 - If the flash fires, the interval between shots may lengthen.
 - The interval between shots may lengthen if the internal memory becomes full.
 - Shooting will automatically cease if the memory card becomes full.

The following movie modes are available.

A430 You can record movies with sound.



 **Standard** You can select the recording pixels/frame rate and record*1. The digital zoom can be used while shooting in this mode (p. 32).

- Recording Pixels/Frame Rate:  (640 × 480) 10 frames/sec.],  (320 × 240) 30 frames/sec.]
- PowerShot A430: Max. Clip Size: 1 GB*2
PowerShot A420: Max. Clip Length: 3 minutes



 **Compact** Since the recording pixels are low, this mode is convenient for sending movies as e-mail attachments or when the memory card capacity is low.

- Recording Pixels/Frame Rate:  (160 × 120) 15 frames/sec.]
- Max. Clip Length: 3 minutes

 **Color Accent** You can shoot with all other colors, other than the color specified in the LCD monitor, in black and white (p. 42).*1
As with the Standard mode, you can select the recording pixels/frame rate and record.

- Recording Pixels/Frame Rate:  (640 × 480) 10 frames/sec.],  (320 × 240) 30 frames/sec.]
- PowerShot A430: Max. Clip Size: 1 GB*2
PowerShot A420: Max. Clip Length: 3 minutes

 **Color Swap** You can change a specified color on the LCD monitor into another (p. 43).*1
As with the Standard mode, you can select the recording pixels/frame rate and record.

- Recording Pixels/Frame Rate:  (640 × 480) 10 frames/sec.],  (320 × 240) 30 frames/sec.]
- PowerShot A430: Max. Clip Size: 1 GB*2
PowerShot A420: Max. Clip Length: 3 minutes



• The recording time will vary according to the capacity of the memory card you use (p. 102).

*1 you can record until the memory card is full (when a super high-speed memory card is used, such as the recommended SDC-512MSH).

*2 Even if the clip size has not reached 1 GB, recording will stop at the moment the clip length reaches 1 hour.

1 FUNC. Menu → * (Standard).

See *Menus and Settings* (p. 21).

- Use the ◀ or ▶ button to select a movie mode and press the **FUNC./SET** button.
- In  (Standard),  (Color Accent), or  (Color Swap) modes, you can change the recording pixels/frame rate (p. 39).

* Default setting.



2 Shoot.

- Pressing the shutter button halfway automatically sets the exposure, focus and white balance settings.
- Pressing the shutter button fully starts recording video.
- **A430** Recording will include sound simultaneously.
- During shooting the recording time and a red circle appear on the LCD monitor.
- Pressing the shutter button fully again stops recording. Recording will stop automatically under the following circumstances.
 - When the maximum recording capacity or time is reached
 - When the internal memory and the memory card becomes full



- You are recommended to use a memory card that has been formatted in your camera to shoot movies (p. 29). The card supplied with the camera may be used without further formatting.
- The focus and zoom settings remain fixed for subsequent frames at the values selected for the first frame.

- A430** ● Be careful of the following while recording.
- Try not to touch the microphone.
 - Do not press any buttons other than the shutter button. The sound that the buttons make when pressed will be recorded in the movie.
 - The camera will automatically adjust the exposure and white balance to suit the shooting conditions during a recording. Please note, however, that the sounds made by the camera while automatically adjusting the exposure may also be recorded.



- Before recording, you can set the white balance (p. 49).
- QuickTime 3.0 or later is required to play back movies (Data type: AVI/Compression method: Motion JPEG) on a computer. QuickTime (for Windows) is included on the Canon Digital Camera Solution Disk. On the Macintosh platform, this program is standard with Mac OS X or later.

Changing Recording Pixels and Frame Rates (Movies)

You can change the recording pixels/frame rate mode when the movie shooting mode is set to (Standard), (Color Accent), or (Color Swap).

1

FUNC. Menu → * (Recording Pixels/Frame Rate).

See *Menus and Settings* (p. 21).







- Use the ◀ or ▶ button to select the recording pixels/frame rate and press the **FUNC./SET** button.

* Default setting.



Recording Pixels/Frame Rates

Frame rates indicate the number of frames recorded or played back each second. The higher the frame rate, the smoother the appearance of motion.

		Recording Pixels	Frame Rate
 Standard	 640	640 × 480 pixels	10 frames/sec.
 Color Accent	 320	320 × 240 pixels	30 frames/sec.
 Color Swap			
 Compact*	 160	160 × 120 pixels	15 frames/sec.

* The recording pixels/frame rate are fixed in the  (Compact) mode.



- See *Image Data Sizes (Estimated)* (p. 103).
- See *Memory Cards and Estimated Capacities* (p. 102).

Shooting Panoramic Images (Stitch Assist)

Shooting Mode   

Stitch Assist can be used to shoot overlapping images that can later be merged (stitched) to create one panoramic image on a computer.

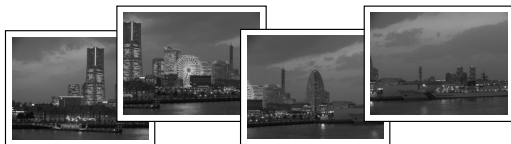



The overlapping seams of several adjacent images can be joined into a single panoramic image.



1 **FUNC. Menu** → / (**Stitch Assist**).

See *Menus and Settings* (p. 21).

- You can select from the following two shooting directions.
 -  Left to right horizontally
 -  Right to left horizontally



2 **Shoot the first frame in the sequence.**

- The exposure and white balance are set and locked with the first image.



3 **Compose the second image so that it overlaps a portion of the first and shoot.**

- Use the ◀ or ▶ button to return the previous image or retake the recorded images.
- Minor discrepancies in the overlapping portions can be corrected when the images are stitched together.

4 **Repeat the procedure for additional images.**

- A sequence may contain up to 26 images.
- Press the **FUNC./SET** button after the last shot.



- The settings for the first image are applied to the second image onward.

A430

- You cannot display the images on a TV while shooting in Stitch Assist mode.







Use PhotoStitch, a supplied program, to merge the images on a computer.

Changing the Colors and Shooting

Shooting Mode      

You can easily change the colors in an image when it is shot for both stills and movies, allowing you to enjoy producing various effects. Depending on the shooting conditions, however, the images may appear rough or you may not get the expected color. Before photographing important subjects, we recommend taking trial shots and checking the results. By setting the [Save Original] function (p. 45) to [On] when shooting stills, you can also record both the altered image and the original, unaltered image.

 	Color Accent	Shoot with all colors, with the exception of the color specified in the LCD monitor, in black and white.
 	Color Swap	Specify a color in the LCD monitor, and shoot with another color replacing the one specified. The specified color can only be swapped with one other color.



Depending on the Special Scene mode, the ISO speed may increase, increasing the amount of noise in the image.

Shooting with Color Accent Mode

1 FUNC. Menu →  **(Color Accent: still image) /  (Color Accent: movie) → FUNC./SET button.**

See *Menus and Settings* (p. 21).



Still images



Movies

2 Press the DISP. button.

- The camera will switch to color input mode, and the display will alternate between the original image and the color accent image (using the previously set color).



3 Aim the camera so that the color you wish to retain appears at the center of the LCD monitor and press the ◀ button.

- Only one color can be specified.
- You can use the ▲ or ▼ button to specify the range of the colors that are retained.
 - 5: Only takes the color that you want to retain.
 - +5: Also takes colors close to the one that you want to retain.

4 Press the DISP. button.

- This completes the setting.



- The default Color Accent is green.
- You may not obtain the expected results after color input mode if you use the flash.
- The specified Color Accent is retained even if the camera's power is turned off.

Shooting with Color Swap Mode

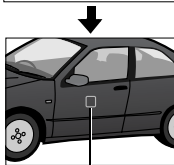
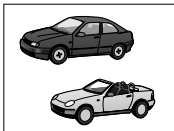

Original Color
(Before Swapping)



Desired Color
(After Swapping)

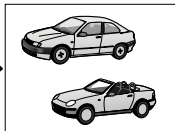

1 FUNC. Menu → **[F/S]** (**Color Swap: still image**)/
[F/S] (**Color Swap: movie**) → **FUNC./SET** button.

See *Menus and Settings* (p. 21).



Still images



Movies

2 Press the DISP. button.

- The camera will switch to color input mode, and the display will alternate between the original image and the color swap image (using the previously set color).



3 Aim the camera so that the color you wish to change appears at the center of the LCD monitor and press the ◀ button.

- Only one color can be specified.
- You can use the ▲ or ▼ button to specify the range of the colors that are retained.
 - 5: Only takes the color that you want to change.
 - +5: Also takes colors close to the one that you want to change.

4 Aim the camera so that the desired color appears at the center of the LCD monitor and press the ▶ button.

- Only one color can be specified.

5 Press the DISP. button.

- This completes the setting.



- The default setting for Color Swap changes green into white.



- You may not obtain the expected results after color input mode if you use the flash.
- The colors specified in the Color Swap mode are retained even if the camera's power is turned off.

Saving Original Images

Not only can you save images with altered colors when shooting still images with the Color Accent or Color Swap modes, but you can also choose to save the original images (before the color change).

1 (Rec.) → Menu (Save Original) → On/Off*.

See *Menus and Settings* (p. 22).

- If [On] is selected, the images will be saved as consecutive file numbers. The original image will be the lower file number, while the image shot in Color Accent or Color Swap mode will be the higher file number.



* Default setting





If (Save Original) is set to [On]

- Only the image set with Color Accent or Color Swap is displayed on the LCD monitor during shooting.
- The image displayed on the LCD monitor immediately after shooting is the one shot with Color Accent or Color Swap. As erasing the image at this time will cause the original image to be erased at the same time, be careful.
- As two images are saved with each shot, the number of recordable shots displayed on the LCD monitor will be half the number that is displayed when (Save Original) is set to [Off].

Switching between Focusing Modes



Shooting Mode     

The AF frame indicates the area of the composition on which the camera focuses. You can set the AF frame in the following ways.

 PowerShot A430	On	The camera detects the subject and highlights the AF frames, from 9 available points, that it will use to determine the focus.
 PowerShot A420	On	The camera detects the subject and highlights the AF frames, from 5 available points, that it will use to determine the focus.
	Off	The camera focuses using the center AF frame. This is convenient for focusing on a specific part of a subject with greater certainty.

1 (Rec.) Menu → (AiAF) → [On]*/[Off].

See *Menus and Settings* (p. 22).

-  (Fireworks) and  (Kids&Pets) modes cannot be set.

* Default setting



- The focus is locked to the center AF frame when the digital zoom is used.
- The AF frame will display as follows (when the LCD monitor is on).
 - AiAF Set to [On]
 - Green Frame: Shooting preparations complete (focused AF frame)
 - No Frame: Focusing difficulty
 - AiAF Set to [Off] (single, centered AF frame)
 - Green Frame: Shooting preparations complete
 - Yellow Frame: Focusing difficulty

Shooting Hard-to-Focus Subjects (Focus Lock)

Shooting Mode    

It may be difficult to focus on the following types of subjects.

- Subjects with extremely low contrast to the surroundings
- Scenes with a mixture of near and far subjects
- Subjects with extremely bright objects at the center of the composition
- Subjects that are moving quickly
- Subjects through glass: Try to shoot as close to the glass as possible to reduce the chances of light reflecting back off the glass.

1 Aim the camera so that an object at the same focal distance as the main subject is centered in the viewfinder or in the AF frame displayed on the LCD monitor.

2 Press the shutter button halfway.

3 Re-aim the camera to compose the shot as desired and press the shutter button fully.



When shooting with the focus lock using the LCD monitor, setting [AiAF] to [Off] (p. 24) in the  (Rec.) menu is recommended since the camera focuses using the center AF frame only.

Switching between Metering Modes



Shooting Mode   

1  (Rec.) Menu →  (Light Metering) →  /  / .

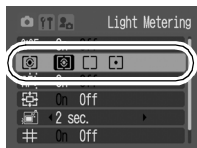
See *Menus and Settings* (p. 22)



Metering Methods

	Evaluative	Appropriate for standard shooting conditions, including backlit scenes. The camera divides images into several zones for metering. It evaluates complex lighting conditions, such as the position of the subject, the brightness, the direct light, and the backlighting, and adjusts the settings to the correct exposure for the main subject.
	Center Weighted Average	Averages the light metered from the entire frame, but gives greater weight to the subject matter at the center.
	Spot	Meters the area within the spot at the center of the LCD monitor. Use this setting when you want to set the exposure on the subject in the center of the monitor.

Adjusting the Exposure Compensation

Shooting Mode      

Adjust the exposure compensation setting to avoid making the subject too dark when it is backlit or shot against a bright background or to avoid making lights appear too bright in night shots.

1 FUNC. Menu → * (Exposure Compensation).

See *Menus and Settings* (p. 21).

- Use the ◀ or ▶ button to adjust the exposure compensation and press the **FUNC./SET** button.



* Default setting.



To Cancel the Exposure Compensation

Restore the compensation value to [0].



Exposure compensation is not available in the  (Color Accent) or  (Color Swap) modes.

Adjusting the Tone (White Balance)

Shooting Mode



Normally, the **AWB** (Auto) white balance setting selects an optimal white balance. When the **AWB** (Auto) setting cannot produce natural looking colors, change the white balance using a setting appropriate to the light source.

1 FUNC. Menu → **AWB** * (Auto).

See *Menus and Settings* (p. 21).

- Use the ◀ or ▶ button to select a white balance setting and press the **FUNC./SET** button.



* Default setting.

White Balance Settings

	Auto	Settings are automatically set by the camera
	Day Light	For recording outdoors on a bright day
	Cloudy	For recording under overcast, shady or twilight skies
	Tungsten	For recording under tungsten and bulb-type 3-wavelength fluorescent lighting
	Fluorescent	For recording under warm-white, cool-white or warm-white (3-wavelength) fluorescent lighting
	Fluorescent H	For recording under daylight fluorescent, or daylight fluorescent-type 3-wavelength lighting
	Custom	For recording with the optimal white balance data memorized in the camera from a white-colored object, such as white paper or cloth



This setting cannot be adjusted when the **Se** (Sepia) or **BW** (B/W) photo effects are selected.

Using the Custom White Balance

You can set a custom white balance to obtain the optimal setting for the shooting conditions by having the camera evaluate an object, such as a piece of white paper or cloth that you wish to establish as the standard white color.

In particular, take a custom white balance reading for the following situations that are difficult for the **AWB** (Auto) setting to detect correctly.

- Shooting close-ups
- Shooting subjects of monotone color (such as sky, sea or forest)
- Shooting with a peculiar source of light (such as a mercury-vapor lamp)

1 **FUNC. Menu** → **AWB** **(Auto)** → **(Custom)**.

See *Menus and Settings* (p. 21).



2 **Aim the camera at a piece of white paper or cloth and press the MENU button.**

- If you are viewing it with the LCD monitor, ensure that the center frame is completely filled with the white image. If you are using the optical viewfinder, ensure that the entire field is filled.



- You are recommended to set the shooting mode to **M** (Manual) and the exposure compensation setting to zero (± 0) before setting a custom white balance.

The correct white balance may not be obtained when the exposure setting is incorrect (image appears completely black or white).

- Shoot with the same settings as when reading the white balance data. If the settings differ, the optimal white balance may not be set. In particular, the following should not be changed.



- ISO Speed
- Flash

Setting the flash to on, on (with Red-Eye Reduction), or off is recommended. If the flash fires when reading the white balance data with the flash set to (Auto) or (Auto with Red-Eye Reduction), make sure that you also use the flash when you shoot.

- Since the white balance data cannot be read in Stitch Assist mode, preset the white balance before selecting [Stitch Assist] in the FUNC. menu.
- The camera will retain the custom white balance setting that you record even if you reset the camera to the default settings (p. 28).

Shooting in a My Colors Mode

Shooting Mode



You can alter the overall impression of an image and shoot.





My Colors Settings

	My Colors Off	Records normally.
	Vivid	Emphasizes the contrast and color saturation to record bold colors.
	Neutral	Tones down the contrast and color saturation to record neutral hues.
	Sepia	Records in sepia tones.
	B/W	Records in black and white.
	Positive Film	Produces intense natural-appearing colors like those obtained with positive film.
	Lighter Skin Tone*	Makes skin tones lighter.
	Darker Skin Tone*	Makes skin tones darker.
	Custom Color	Customize contrast, sharpness, and saturation, and red, green, blue, and skin tone* balance. Use to make subtle adjustments, such as making blue colors more vivid and face colors brighter.

* The skin colors of non-human subjects may also be altered. Also you may not obtain the expected results depending on the skin color.

1 FUNC. Menu → * (My Colors Off).

See *Menus and Settings* (p. 21).

- Use the ◀ or ▶ button to select a My Colors mode.
- To select  (B/W), select  * (Sepia) and press the Menu button. Pressing the Menu button again brings back the  (Sepia) option.
-  Mode
Set the camera to a custom color mode and begin shooting (below).
- Other than  Mode
Press the FUNC./SET button to return to the shooting screen and begin shooting.

* Default setting.



2 Shoot.



The ISO speed will increase with some settings, which may increase the noise in the image.

Setting the Camera to a Custom Color Mode

You can adjust the contrast, sharpness, saturation, red, green, blue, or skin tone balance and shoot.

1 (Custom Color) → Menu button.

See *Menus and Settings* (p. 22).



2 Use the ▲ or ▼ button to select [Contrast], [Sharpness], [Saturation], [Red], [Green], [Blue], or [Skin Tone] and the ◀ or ▶ button to adjust the color balance.

- The altered color will display.





Select an item to adjust.

Adjust the selected item.

3 Press the FUNC./SET button.

- This completes the setting.
- If you press the **Menu** button at this point, you will return to the screen where you can select a My Colors mode.

Adjusting the ISO Speed

Shooting Mode   

Raise the ISO speed when you wish to reduce the effects of camera shake, turn the flash off when shooting in a dark area, or use a fast shutter speed.

1 FUNC. Menu → * (ISO Speed).



See *Menus and Settings* (p. 21).

- Use the ◀ or ▶ button to select an ISO speed and press the **FUNC./SET** button.
- The AUTO setting selects the optimal speed.

* Default setting.



A430 Setting the Auto Rotate Function



Shooting Mode   

Playback Mode 

Your camera is equipped with an Intelligent Orientation sensor that detects the orientation of an image shot with the camera held vertically and automatically rotates it to the correct orientation when viewing it in the LCD monitor.

1 (Set up) Menu → (Auto Rotate) → [On]*/[Off].

See *Menus and Settings* (p. 22).

- When the Auto Rotate function is set to [On] and the LCD monitor is set to the detailed display mode, the  (normal),  (right end is down) or  (left end is down) will appear in the display.

* Default setting



- This function may not operate correctly when the camera is pointed straight up or down. Check that the arrow  is pointing in the right direction. If it is not, set the Auto Rotate function to [Off].
- Even if the Auto Rotate function is set to [On], the orientation of images downloaded to a computer will depend upon the software used to download the images.



- When the camera is held vertically to shoot, the Intelligent Orientation sensor judges the upper end to be "up" and the lower end to be "down". It then regulates the optimal white balance, exposure, and focus for vertical photography. This function operates regardless of the on/off status of the Auto Rotate function.
- The Auto Rotate function can be set for the shooting and playback modes separately.
 - When the Auto Rotate function is set to [On] in shooting mode, the orientation of the camera is recorded when the shot is taken. Therefore, the image is automatically rotated during playback mode based on the orientation of the camera during shooting.



- When the Auto Rotate function is set to [On] in playback mode, images will be rotated to their correct orientation in the LCD monitor regardless of the camera's orientation when shooting.

Creating an Image Destination (Folder)

Shooting Mode    

Playback Mode 

You can create a new folder at any time and the recorded images will be automatically saved to that folder.

Create New Folder	Creates a new folder the next time you shoot images. To create an additional folder, insert another check mark.
Auto Create	To create a new folder the next time you shoot after a specified date and time, specify a date and time (p. 56).

1 (Set up) Menu → (Create Folder).

See *Menus and Settings* (p. 22).

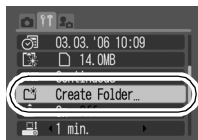

Create a folder the next time you shoot.

2 Place a check mark beside [Create New Folder] → Menu button.

-  displays in the LCD monitor. The symbol will cease to display after the new folder is created.

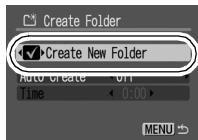

Setting the Day or Time for Automatic Folder Creation

- 2** Use the ◀ or ▶ button to select a day for the [Auto Create] option and a time in the [Time] option ▶ Menu button.

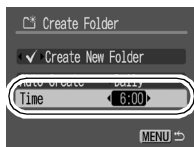

-  displays when the specified time arrives. The symbol will cease to display after the new folder is created.



Up to 2000 images can be saved into one folder. A new folder will automatically be created when you record more than that number.

Resetting the File Number

Shooting Mode    

Playback Mode 

The images you shoot are automatically assigned file numbers. You can select how the file number is assigned.

- 1**  (Set up) Menu ▶  (File Numbering) ▶ [Auto Reset]/[Continuous].*

See *Menus and Settings* (p. 22).



* Default setting.

File No. Reset Function

Continuous



A number one higher than the last one recorded is assigned to the next image. This is convenient for managing all your images together on a computer because you avoid file name duplication when changing folders or memory cards.*

Auto Reset	The image and folder number are reset to the starting value (100-0001).* This is convenient for managing images on a folder-by-folder basis.
-------------------	--

* When a blank memory card is used. If a memory card with recorded data is used, the 7-digit number for the last recorded folder and image is compared with the last one on the card, and the larger of the two is utilized as the basis for new images.

File and Folder Numbers

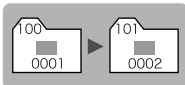
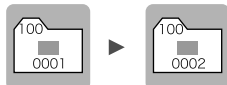
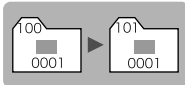
Recorded images are assigned consecutive file numbers starting with 0001 and ranging up to 9999, while folders are assigned numbers starting with 100 and ranging up to 999. Up to 2,000 images can be saved into a single folder.

	New Folder Created	Memory Card Exchanged for Another
Continuous	Memory Card 1 	Memory Card 1 Memory Card 2 
Auto Reset	Memory Card 1 	Memory Card 1 Memory Card 2 

- Images may be saved to a new folder when there is insufficient free space even if the total number of images in a folder is less than 2,000 because the following types of image are always saved together into the same folder.
 - images from continuous shooting
 - Self-timer images (custom)
 - Stitch Assist mode images
 - Color Accent/Color Swap still images (with [Save Original] set to [On])
- Images cannot be played back when the folder numbers are duplicated or image numbers are duplicated within folders.
- Please refer to the *Software Starter Guide* for information regarding folder structures or image types.

→ See the *Basic Guide* (p. 10)

Q Magnifying Images



1 Press the **Q** button.

- **SET**  will display and a magnified portion of the image will display.
- You can change the magnification level with the **▲** or **▼** button.
- Images can be magnified up to a factor of approximately 10x.



Approximate Location of the Magnified Area

2 Press the **FUNC./SET** button and use the **◀**, **▶**, **▲** or **▼** button to move around the image.

- **SET**  will display.
- If you press the **FUNC./SET** button once more, the camera switches to image advance mode and **SET**  will display. You can use the **◀** or **▶** button to advance to the next or previous image at the same level of magnification. The image advance mode cancels when you press the **FUNC./SET** button again.

To Cancel the Magnified Display

Press the zoom lever toward **▼**. (You can also cancel it immediately by pressing the **MENU** button or holding down the **FUNC./SET** button for more than 1 sec.)



Movie frames and index playback images cannot be magnified.

Viewing Images in Sets of Nine (Index Playback)

1 Display an image by pressing the **FUNC./SET** button at least 1 second.

- Up to nine images can be viewed at once in index playback.
- Use the ◀, ▶, ▲ or ▼ button to change the image selection.



To Return to Single Image Playback

Press the **FUNC./SET** button at least 1 second.

Viewing Movies

! Movies cannot be played in the index playback mode.

1 Display a movie and press the **FUNC./SET** button.



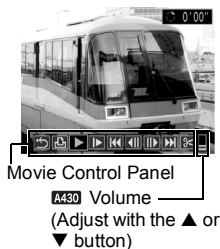





- Images with a **SET**  icon are movies.



2 Select **▶ (Play)** and press the **FUNC./SET** button.

- The movie will pause if you press the **FUNC./SET** button during playback. It will resume when you press the button again.
- When playback ends, the movie stops at the last frame displayed. Press the **FUNC./SET** button to display the movie control panel.

Operating the Movie Control Panel

	Exit (Single image playback)
	Print (Only appears when connected to a printer. For details, refer to your Direct Print documentation.)
	Play
	Slow Motion Playback (You can use the ◀ button to slow down or the ▶ button to speed up playback.)
	Displays the first frame
	Previous Frame (Rewinds if the FUNC./SET button is held down)
	Next Frame (Fast Forwards if the FUNC./SET button is held down)
	Displays the last frame
	Edit (Switches to movie editing mode) (p. 60)



- **A430** Use the television's controls to adjust the volume when playing a movie on a TV set (p. 71).
- **A430** The sound cannot be played in slow motion playback.

Editing Movies

You can delete portions of recorded movies.



Protected movies and movies 1 second or less in duration cannot be edited.

1



Select  (Edit) in the movie control panel and press the **FUNC./SET button.**



- The movie editing panel and the movie editing bar will display.

Movie Editing Panel



Movie Editing Bar

2 Use the ▲ or ▼ button to select  (Cut Beginning) or  (Cut End) and the ◀ or ▶ button to specify the point (↓) at which to cut.

- To check a temporarily edited movie, select  (Play) and press the **FUNC./SET** button.
- Selecting  (Exit) cancels the edit and restores the movie control panel.

3 Select  (Save) and press the **FUNC./SET button.**

4 Select [New File] or [Overwrite] and press the **FUNC./SET button.**

- [New File] saves the edited movie under a new file name. The pre-edit data is left unchanged. Note, if you press the **FUNC./SET** button while saving the movie, saving is canceled.
- [Overwrite] saves the edited movie with its original name. The pre-edit data is lost.
- When there is not enough space left on the memory card, only [Overwrite] can be selected.



It may take approximately 3 minutes to save an edited movie. If the battery runs out of charge partway through, edited movie clips cannot be saved. When editing movies, it is recommended that you use two new size-AA alkaline batteries, two fully charged size-AA NiMH batteries, or the separately sold AC Adapter Kit ACK800 (p. 90).

Rotating Images in the Display

Images can be rotated clockwise 90° or 270° in the display.



Original

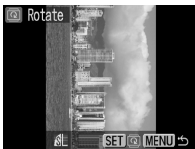

90°



270°

1 (Play) Menu .

See *Menus and Settings* (p. 22).



2 Use the or button to select an image to rotate and press the FUNC./SET button to rotate it.

- Cycle through the 90°/270°/original orientations with each press of the **FUNC./SET** button.
- Images can be rotated in index playback.



- Movies cannot be rotated.
- When images are downloaded to a computer, the orientation of images rotated by the camera will depend upon the software used to download the images.

A430 Attaching Sound Memos to Images

In playback mode (including single image playback and index playback), you can attach sound memos (up to 1 minute) to an image. The sound data is saved in the WAVE format.

1 (Play) Menu .

See *Menus and Settings* (p. 22).





2 Use the or button to select an image to attach a sound memo to and press the **FUNC./SET** button.

● The sound memo control panel will display.





3 Select (Record) and press the **FUNC./SET** button.

- The elapsed time and the remaining time display.
- Pressing the **FUNC./SET** button pauses the recording. Pressing it again resumes recording.
- Up to 1 minute of recordings can be added to any one image.



Sound Memo Panel
Elapsed Time/
Remaining Time
Volume
(Adjust with the  or  button)

Sound Memo Panel

	Exit
	Record
	Pause
	Play
	Erase
	Select [Erase] in the confirmation screen and press the FUNC./SET button.



- You cannot attach sound memos to movies.
- Sound memos for protected images cannot be erased.

Automated Playback (Auto Play)

All the images on a memory card can be displayed automatically. The displaying time is 3 seconds.

1 (Play) Menu → → **FUNC./SET** button.

See *Menus and Settings* (p. 22).

- The Auto Play starts.
- Following functions are available during automated playback:
 - Pausing/resuming the Auto Play: press the **FUNC./SET** button
 - Fast forward/rewind the Auto Play: press the ◀ or ▶ button (continue to hold the button to advance more rapidly)
 - Stopping the Auto Play: press the **MENU** button.



Protecting Images

You can protect important images and movies from accidental erasure.

1 (Play) Menu → .

See *Menus and Settings* (p. 22).

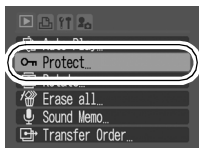

2 Select an image you want to protect using the ◀ or ▶ button, and press the FUNC./SET button.

- Pressing the FUNC./SET button again cancels the setting.
- You can also protect images in the index playback mode.



Protection Icon

Erasing All Images

- Please note that erased images cannot be recovered. Exercise adequate caution before erasing an image.
- Protected images cannot be erased with this function.

1 (Play) Menu .

See *Menus and Settings* (p. 22).

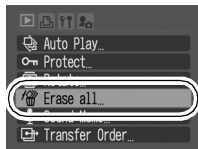

2 Select [OK] and press the FUNC./SET button.

- To exit instead of erasing, select [Cancel].



Please format the memory card when you want to erase not only image data but also all the data contained on the card (p. 29).

Setting the DPOF Print Settings

You can select images on a memory card for printing and specify the number of print copies in advance using the camera. The settings used on the camera comply with the Digital Print Order Format (DPOF) standards. This is extremely convenient for printing on a direct print compatible printer, or for sending the images to a photo developing service that supports DPOF. These settings are compliant with DPOF (Digital Print Order Format).

The **▲** icon may display for a memory card with print settings set by a different DPOF-compliant camera. These settings will be overwritten by those set by your camera.

Single Images

1 (Play) Menu → (Print) Menu → [Select Images & Qty.]



See *Menus and Settings* (p. 22).

- Selecting [Clear All Selections] cancels all print settings for the images.



2 Select images for printing.

- As shown below, selection methods differ for the Print Type settings (p. 68).

-  (Standard)/ (Both)

Select an image, press the **FUNC./SET** button and use the ▲ or ▼ button to select the number of print copies (up to 99).

Number of Print Copies





-  (Index)

Select an image and then press the **FUNC./SET** button to select or deselect it.



Index Print Selection



- You can also select images in the index playback mode.
- If the camera is connected to a printer, the  button lights blue during image selection. Printing starts after pressing the **FUNC./SET** button once the  button is pressed and [Print] selection is confirmed.

All the Images on a Memory Card

1 (Play) Menu → (Print) Menu → [Select All Images].

- One copy of every image will be set to print.
- Selecting [Clear All Selections] cancels all print settings for the images.
- If the camera is connected to a printer, the  button lights blue after the **FUNC./SET** button is pressed. Printing starts after pressing the **FUNC./SET** button once the  button is pressed and [Print] selection is confirmed.



2 Use the ◀ or ▶ button to select [OK] and press the **FUNC./SET** button.



- The output of some printers or photo developing services may not reflect the specified print settings.
- Print settings cannot be set for movies.









- The images are printed in order from oldest to newest by the date and time they were shot.
- A maximum of 998 images can be selected.
- When [Print Type] is set to [Both], the number of copies can be set. When it is set to [Index], the number of copies cannot be set (only one copy will be printed).

Setting the Print Style

Specify the print style before selecting the image to print. The following print settings can be selected.

*Default setting

 Print Type	 Standard*	Prints one image per page.
	 Index	Prints the selected images together at a reduced size in an index format.
	 Both	Prints the images in both the standard and index formats.
 Date (On/Off*)	Adds the date to the print.	
 File No. (On/Off*)	Adds the file number to the print.	
 Clear DPOF data (On*/Off)	Clears all print style settings after printing is complete.	

1 (Print) Menu → [Print Settings]

See *Menus and Settings* (p. 22).



2 **Select [Print Type], [Date], [File No.], or [Clear DPOF data] and then select the settings.**

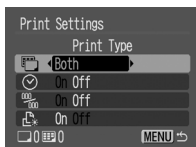



- The Date and File No. settings will change according to the Print Type as follows. However, the printable information may vary between printers.
 - Index
[Date] and [File No.] cannot be set to [On] at the same time.
 - Standard or Both
[Date] and [File No.] can be set at the same time.
- Embedded dates in  (Postcard Date Imprint mode) (p. 34) print out even when [Date] is set to [Off].
- Do not set the date in the DPOF print settings when printing images that have had the date embedded with the [Date Stamp] function. This may cause the date to be printed twice.
- Dates print in the style specified in the [Date/Time] menu (p. 26).

Setting the DPOF Transfer Settings

You can use the camera to specify settings for images before downloading to a computer. Refer to the *Software Starter Guide* for instructions on how to transfer images to your computer.

The settings used on the camera comply with the Digital Print Order Format (DPOF) standards.

The  icon may display for a memory card with transfer settings set by a different DPOF-compliant camera. These settings will be overwritten by those set by your camera.

1 (Play) Menu .

See *Menus and Settings* (p. 22).



Single Images

2 Select [Order] and press the FUNC./SET button.

- Selecting [Reset] cancels all transfer order settings.



3 Use the ◀ or ▶ button to select an image to transfer and press the FUNC./SET button.

- Pressing the FUNC./SET button again deselects the setting.
- You can also select images in the index playback mode (p. 59).

Transfer Selection



All the Images on a Memory Card

2 Select [Mark all] and press the FUNC./SET button.

- Selecting [Reset] cancels all transfer order settings.

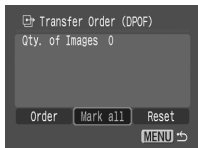

3 Select [OK] and press the FUNC./SET button.



- The images are transferred in order from oldest to newest by the date and time they were shot.
- A maximum of 998 images can be selected.

A430 Shooting/Viewing Images on a TV set

You can use a video-compatible television as a monitor to shoot or play back images when it is connected to the camera with the supplied AV Cable.

1 Turn off the Camera and the TV.

2 Connect the AV cable to the camera's A/V OUT terminal.

- Open the terminal cover by slipping a fingernail under the right edge and plug the AV cable in all the way.

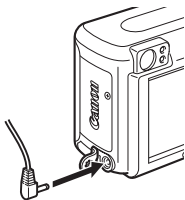

3 Plug the other ends of the AV cable to the VIDEO IN and AUDIO IN jacks on the TV.

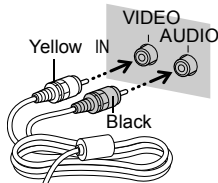

4 Turn on the TV and switch it to Video mode.

5 Turn on the camera.



The video output signal can be switched (NTSC or PAL) to accommodate different regional standards (p. 22, 26). The default setting varies between regions.

- NTSC: Japan, U.S.A., Canada, Taiwan and others
 - PAL: Europe, Asia (excluding Taiwan), Oceania and others
- If the video system is set incorrectly, the camera output may not display properly.

My Camera allows you to customize the start-up image and start-up, operation, self-timer and shutter sounds. You can use the supplied software to register image and sound settings on your computer to the camera.

Changing My Camera Settings

1 (My Camera) Menu → Menu Item.

See *Menus and Settings* (p. 22).



2 Use the ◀ or ▶ button to select the contents you wish to set.

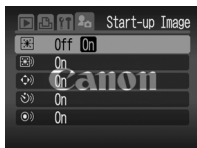

- For details on changing and registering My Camera settings, refer to the supplied *Software Starter Guide*.
- A computer is required to return My Camera settings to defaults. Use the supplied software (ZoomBrowser EX/ImageBrowser) to register the default settings to the camera.



When new My Camera settings are registered, previously registered settings are erased.

Camera

Camera will not operate.

Power is not turned on.	● Press the power button for a moment (<i>Basic Guide</i> p. 2).
Memory card slot/battery cover is open.	● Confirm that the memory card slot/ battery cover is securely closed (<i>Basic Guide</i> p. 1).
Batteries are loaded in the wrong direction.	● Put batteries back into the camera in the correct direction (<i>Basic Guide</i> p. 1).
Batteries are not the right type.	● Use only unused AA-size alkaline batteries or Canon AA-size NiMH batteries. (<i>Basic Guide</i> p. 1).
Insufficient battery voltage ("Change the batteries" message displays).	● Insert the two unused or fully charged AA-size NiMH batteries into the camera (<i>Basic Guide</i> p. 1). ● Use the AC Adapter Kit ACK800 (sold separately) (p. 90).
Poor contact between camera and battery terminals.	● Polish the terminals with a soft cotton swab before charging or using the battery (p. 85). ● Reinsert the batteries several times.

A430 Sounds come from the inside of the camera.

The camera's horizontal/ vertical orientation was changed.	● The camera's orientation mechanism is operating. There is no malfunction.
--	---

When the power is turned on

"Card locked!" message appears.

The SD memory card's write protect tab is set to "Write protect".

- When recording to, erasing from or formatting the memory card, slide the tab upward (p. 87).

The Date/Time menu appears.

The lithium coin battery charge is low.

- Replace it (p. 89).

LCD monitor

The display darkens.

The image in the LCD monitor will darken in strong sunlight or bright light.

- This is a normal occurrence in devices containing CCDs and does not constitute a malfunction. (This image will not be recorded when shooting still photos, but it will be recorded when shooting movies.)

Display flickers.

Display flickers when shot under fluorescent lighting.

- This is not a camera malfunction. (Flickering is recorded in movies, but not in still images.)

A bar of light (red, purple) appears on the LCD monitor.

Subject is too bright.

- This is a normal occurrence in devices containing CCDs and does not constitute a malfunction. This bar of light will not be recorded when shooting still photos, but it will be recorded when shooting movies.

appears.

A slow shutter speed has likely been selected because of insufficient lighting.

- Raise the ISO speed, set the flash to anything other than  (Flash off), or affix the camera to a tripod to shoot (*Basic Guide* p. 8).

▲ appears.

The symbol will display when using a memory card that had print settings or transfer settings set by other DPOF-compliant cameras.

- Be careful when making changes to the print or transfer settings with other DPOF cameras, because all such settings will be overwritten by your camera (p. 66).

Noise displays./Subject's movements are irregular.



The camera automatically brightened the image displayed on the LCD monitor to make it easier to see when shooting in a dark area (p. 15).

- There is no effect on the recorded image.

Shooting

Camera will not record.

Mode switch is set to  (playback).

- Set the mode switch to , , **SCN** or  (*Basic Guide* p. 6).

Flash is charging.

- The indicator will light orange when it is charged. You can then press the shutter button.

Memory card is full.

- Insert a new memory card (*Basic Guide* p. 1).
- If required, download the images to a computer and erase them from the memory card to make space (*Basic Guide* p. 10, p. 65).

Memory card is not formatted correctly.

- Format the memory card (p. 29).
- If reformatting does not work, the memory card logic circuits may be damaged. Consult the nearest Canon Customer Support Help Desk.

SD memory card is write protected.

- Slide the write protect tab of the SD memory card upward (p. 87).

Image Seen in Viewfinder vs. Recorded Image

Usually the recorded image contains more of the scene than is seen in the viewfinder.

- Confirm the actual image size with the LCD monitor. As there can be a noticeable difference, use the LCD monitor when in macro and super macro mode (p. 15).

Image is blurred or out of focus.

AF-assist Beam is set to [Off].

- In dark places where it is difficult for the camera to focus, the AF-assist Beam will emit to assist focusing. As the AF-assist Beam will not function when turned off, set it [On] to activate it (p. 24). Take care not to obstruct the AF-assist Beam with your hand when used.

The camera moves when the shutter button is pressed.

- Setting the self-timer to  (2 seconds) delays the shutter release for 2 seconds and allows the camera to stop shaking, thus preventing a blurred image (p. 35). Even better results can be obtained by placing the camera on a stable surface or by using a tripod to shoot.

Subject is out of focal range.

- Shoot with the subject at the correct shooting distance (p. 96).
- Use the Infinity mode to shoot distant subjects (*Basic Guide* p. 9).

The subject is hard to focus on.

- Use the focus lock to shoot (p. 47).

Subject in recorded image is too dark.

Insufficient light for shooting.

- Set the flash to on  (On) (*Basic Guide* p. 8).

There is a difference in brightness between the background and the subject.

- Set the exposure compensation to a positive (+) setting (p. 48).
- Use the spot metering function (p. 47).

Subject is too far away for flash to reach.

- Shoot within correct shooting distance of the subject when using the internal flash (p. 97).
- Raise the ISO speed and then shoot (p. 53).

Subject in recorded image is too bright, or image flashes white.

Subject is too close, making the flash too strong.

- Shoot within correct shooting distance of the subject when using the internal flash (p. 97)

Subject is bright in contrast to the background.

- Set the exposure compensation to a negative (-) setting (p. 48).
- Use the spot metering function (p. 47).

Light is shining directly on the subject or reflected off the subject into the camera.

- Change the shooting angle.

Flash is set to on.







- Set the flash to off  (Flash off) (*Basic Guide* p. 8).

Image contains noise.

ISO speed is too high.

- Higher ISO speeds increase image noise. To take clean images, use as low an ISO speed as possible (p. 53).
- In Auto mode,  (Color Accent) and  (Color Swap) modes of  M mode, and  (Night Snapshot),  (Kids&Pets), and  (Indoor) modes of Special Scene mode, the ISO speed increases and noise may occur.

White dots appear on the image.

Light is reflected back from the eyes when the flash is used in dark areas.

- This is a phenomenon that occurs with digital cameras and does not constitute a malfunction.

Eyes appear red.

Light reflecting back from eyes can make them appear red when the flash is used in dark areas.

- Under these conditions, use the  red-eye reduction mode (*Basic Guide* p. 8). For this mode to be effective, the subject must be looking right at the red-eye reduction lamp. Try asking them to look directly at the lamp.
- Even better results can be obtained by increasing the lighting in indoor settings or approaching closer to the subject. The shutter will not activate for approximately 1 second after the red-eye reduction lamp fires in order to improve the effect.

Continuous shooting slows down.

The memory card's performance has dropped.

- To enhance the continuous shooting performance, you are recommended to format the memory card in the camera after you save all its images to your computer (*Basic Guide* p. 18, p. 29).

Recording images to memory card takes a long time.

Memory card was formatted in another device.

- Use a memory card formatted in your camera (p. 29).

Lens will not retract.

Memory card slot/battery cover was opened with power on.

- First close the memory card slot/battery cover, turn the power on, and then turn the power off again (*Basic Guide* p. 1).

Shooting Movies

The recording time may not display properly or filming may stop unexpectedly.

The following types of memory cards are used.

- Slow recording cards.
- Cards formatted on a different camera or a computer.
- Cards which have had images recorded and erased repeatedly.

- Although the recording time may not display properly during shooting, the movie will be recorded correctly on the memory card. Recording time will display properly if you format the memory card in this camera (excluding slow recording memory cards) (p. 29).

"!" displayed on the LCD monitor in red and shooting automatically stopped.

Free space in the camera's built-in memory became too scarce.

- Try the following procedures.
 - Format the card with a low level format before filming (p. 29).
 - Lower the recording pixels/frame rate (p. 39).
 - Use a high-speed memory card (SDC-512MSH, etc.).

Zoom does not operate.

Zoom button was pressed while shooting in movie mode.

- Operate the zoom before shooting in movie mode (*Basic Guide* p. 8). However you can use the digital zoom while shooting in movie mode ( Standard mode only) (p. 32).

Playback

Cannot play back.

You attempted to play back images shot with another camera or images edited with a computer.

- Computer images that cannot be played back will play back if they are added to the camera using the bundled software program ZoomBrowser EX or ImageBrowser.

File name was changed with a computer or file location was changed.

- Set the file name or location to a file format compatible with the camera. (Refer to the *Software Starter Guide* for details).

Movies cannot be edited.

Some movies shot with another camera cannot be edited.

Movies do not play back correctly.

Movies recorded with high recording pixels/frame rates may momentarily stop playing if played on slow reading memory cards.

You may experience frame dropping when playing back a movie on a computer with insufficient system resources.

Reading images from memory card is slow.

Memory card was formatted in another device.

- Use a memory card formatted in your camera (p. 29).

Battery

Battery consumed quickly.

Batteries are not the right type.

- Use only unused AA-size alkaline batteries or fully charged Canon AA-size NiMH batteries. See *Battery Handling* (p. 85).

The batteries are cold. Battery performance deteriorates at low temperatures.

- If shooting in a cold area, keep the batteries warm (by placing them in an inner pocket, etc.) until ready to use them.

Battery terminals are dirty.

- Wipe them well with a dry cloth before use.
- Reinsert the batteries several times.

Canon AA-size NiMH batteries consumed quickly.

The batteries have not been used for over a year.

- If batteries are rechargeable: Performance should return to normal after several charging cycles.

Battery life exceeded.

- Replace the batteries with the unused batteries.

A430 TV monitor output

Image not showing on TV monitor.

Incorrect video system setting.

- Set the video system to the appropriate setting, NTSC or PAL, for your TV (p. 22).

Shooting in Stitch Assist mode.

- The output will not appear on a TV in Stitch Assist mode. Shoot in a different mode (Basic Guide p. 5).

Direct print compatible printers

Cannot print.



Camera and printer are not properly connected.

- Make sure the camera and printer are connected properly with the specified cable.

Printer is not turned on.

- Turn on the printer.

Print connection method is incorrect.

- Select [Auto] for ( Print Method) under the  (Set up) menu (p. 26).

List of Messages

The following messages may appear on the LCD monitor during shooting or playback. Please refer to the *Direct Print User Guide* for the messages that display during a printer connection.

Busy...

- Image is being recorded to, or read from, memory card. The playback mode is starting up.

No memory card

- You turned on the camera without a memory card installed.

Card locked!

- The SD card is write-protected.

Cannot record

- You attempted to shoot an image without a memory card.
A430 You attempted to record a sound memo on a movie.

Memory card error

- Memory card has experienced an anomaly.

Memory card full

- Memory card is full of images and no more can be recorded or saved. Or no more image settings can be recorded.
A430 No more sound memos can be recorded.

Naming error!

- The image could not be created because there is an image with the same name as the folder that the camera is attempting to create, or the highest possible file number has already been reached. In the **[1]** Set up Menu, set the File Numbering option to [Auto Reset]. Save all the images you wish to retain onto a computer, then reformat the memory card. Please note that formatting will erase all the existing images and other data.

Change the batteries.

- Battery charge is insufficient to operate the camera. Replace with unused AA-size alkaline batteries or fully charged Canon AA-size NiMH batteries (be sure to replace all the batteries at the same time).

No image.

- No images recorded on memory card.

Image too large.

- You attempted to play back an image larger than 4992 × 3328 pixels or with a large data size.

Incompatible JPEG format.

- You attempted to play back an incompatible JPEG image.

Corrupted data.

- You attempted to play back an image with corrupted data.

RAW

- You attempted to play back a RAW image.

Unidentified Image

- You attempted to play back an image that was recorded in a special data type (proprietary data type used by the camera of another manufacturer, etc.) or a movie clip recorded by another camera.

Cannot magnify!

- You attempted to magnify an image recorded in a different camera or data type, an image edited with a computer, or a movie.

Cannot rotate

- You attempted to rotate an image recorded in a different camera or data type, an image edited with a computer, or a movie.

A430 Incompatible WAVE format.

- A sound memo cannot be added to this image because the data type of the existing sound memo is incorrect.

A430 Cannot transfer!

- When transferring images to your computer using the Direct Transfer menu, you attempted to select an image with corrupted data or an image taken with another camera. You may have also attempted to select a movie when [Wallpaper] was selected in the Direct Transfer menu.

Protected!

- You attempted to erase or edit a protected image or movie.
 A430 You attempted to erase or add a protected sound memo.

Too many marks.

- Too many images have been marked with print settings or transfer settings. Cannot process any more.

Cannot complete!

- Could not save the print or transfer settings.

Unselectable image.

- You attempted to set the print settings for a non-JPEG image.

Communication error

- The computer was unable to download the image due to the large amount of images (approx. 1000) stored on the memory card.

Lens error, restart camera

- Camera detected an error while moving the lens and cut the power automatically. This error message may appear if you press on the lens while it is moving or power up the camera in a dusty or sandy environment. Power up the camera again and shoot or playback images. Take the camera to a service center if this message appears frequently because there may be a problem with the lens.

Exx

- (xx: number) Camera detected an error. Turn the power off and then back on, then shoot or play back. A problem exists if the error code reappears. Note the number and contact your Canon Customer Support Help Desk. If an error code displays directly after taking a picture, the shot may not have been recorded. Check image in playback mode.
-

Battery Handling

Battery Charge

The following icon and message will display.



The battery charge is low. If you plan to use the camera for an extended period of time, replace the battery as soon as possible.

Change the batteries

Battery charge is insufficient to operate the camera. Replace the battery immediately.

Battery Handling Precautions

- **Use AA-size alkaline or Canon AA-size NiMH batteries (sold separately) only.**
While it is possible to use AA-size nickel-cadmium batteries, performance is unreliable and their use is not recommended.
- **The operating time of the batteries you purchase may not be as long as the batteries that came with the camera.**
The performance of alkaline batteries may differ according to brand.
- **If you are using the camera in cold areas or for a long time, we recommend using Canon's AA-size NiMH Battery Kit (sold separately).**
Camera operating time may shorten at low temperatures when alkaline batteries are used. Also due to their specifications, alkaline batteries may expire faster than NiMH batteries.
- **Never mix new batteries together with batteries that have been used in other devices.**
The partially used batteries may leak.
- **Be careful to load the batteries with their positive (⊕) and negative (⊖) ends in the right direction.**
- **Never mix batteries of different types or from different manufacturers. All two batteries should be identical.**

- **Before inserting the batteries, wipe the battery terminals well with a dry cloth.**

Oil from one's skin or dirtiness may cause a considerable reduction in the number of recordable images or reduce usage time.

- **Battery performance deteriorates at low temperatures, and the battery icon  may display more quickly.**

If you are using the camera in cold areas and batteries are running down faster than they should, you may be able to restore performance by placing batteries in an inner pocket to warm them up prior to use.

- **Be careful that you don't put the batteries into a pocket together with a metal key chain or other metallic objects, as these objects may cause batteries to short-circuit.**
- **If you do not plan to use the camera for a long time, remove the batteries from the camera and store them in a safe place.** Batteries may leak and damage the camera if left installed during prolonged periods of non-use.

Warning

Never use damaged batteries or batteries whose outer seal is completely or partially missing or peeled off, as there is risk that such batteries may leak, overheat, or burst.

Always check the seals on store-bought batteries before loading them, as some batteries may come with defective seals. Do not use batteries with defective seals.

Never use batteries that look like this.



Batteries with all or part of the seal (electrical insulation sheath) peeled off.



The positive electrode (plus terminal) is flat.



The negative terminal is correctly formed (protruding from the metal base), but the seal does not extend up over the edge of the metal base.

Handling the Memory Card

SD Memory Card (Sold Separately) Write Protect Tab

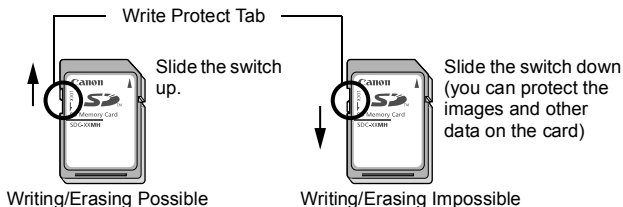

Cautions When Handling

- **Memory cards are high-precision electronic devices. Do not bend them, apply force to them, or subject them to shocks or vibration.**
- **Do not attempt to disassemble or alter the memory card.**
- **Do not allow dirt, water or foreign objects to contact the terminals on the back of the card. Do not touch the terminals with your hands or metal objects.**
- **Do not peel away the original label on the memory card or cover it with another label or sticker.**
- **When writing on the memory card, do not use a pencil or ball-point pen. Only use a soft point pen (e.g. felt-tip pen).**
- **Do not use or store memory cards in the following locations.**
 - Locations subject to dust or sand
 - Locations subject to high humidity and high temperatures
- **Since some or all of the data recorded on the memory card may be corrupted or erased by electrical noise, static electricity or card/camera malfunction, making a backup copy of important data is recommended.**

Formatting

- **Please note that formatting (initializing) an memory card erases all data, including protected images and other file types.**
- **You are recommended to use memory cards that have been formatted in your camera.**
 - The card supplied with the camera may be used without further formatting.
 - When the camera is malfunctioning, a corrupted memory card might be the cause. Reformatting the memory card may solve the problem.
 - When a non-Canon brand memory card is malfunctioning, reformatting it may solve the problem.
 - Memory cards formatted in other cameras, computers, or peripheral devices may not operate correctly in this camera. When that happens, reformat the memory card with this camera.
- **If formatting in the camera does not work properly, turn the camera off and re-insert the memory card. Then turn the camera back on and format again.**

Replacing the Date Battery

If the LCD monitor displays the Date/Time menu when you turn on the camera, this means that the date battery has run down and the clock has stopped running. Please purchase a replacement battery (lithium coin battery CR1220) and install it as follows.

The date battery is preinstalled at the factory and may therefore expire earlier than its rated lifespan after the camera has been purchased.



Be particularly careful to keep the date batteries out of the reach of children. Seek medical assistance immediately if a child swallows a battery since corrosive battery fluids could damage the stomach or intestinal wall.

1 Be sure that the camera is turned off.

2 Remove the battery holder.

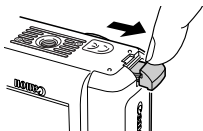

3 Pull out the battery in the direction as shown with arrow.

(-) Negative end



4 Insert the new date battery into the holder with the negative end (-) facing up.

5 Replace the date battery holder back into its original position.

6 Set the date and time when the Date/Time menu is displayed on the LCD monitor (*Basic Guide* p. 2).



The LCD monitor also displays the Date/Time menu the very first time you turn on the camera. This is normal, and you don't need to replace the date battery.

Using an AC Adapter Kit (Sold Separately)

It is best to power the camera with AC Adapter Kit ACK800 (sold separately) when you are using it for long periods of time or connecting it to a computer.



Turn the camera power off before connecting or disconnecting the compact power adapter.

1

Connect the power cord to the compact power adapter first and then plug the other end into the power outlet.

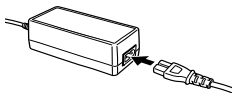

2

Open the terminal cover and attach the cord to the DC IN terminal.

- Please unplug the adapter from the power outlet when you have finished using the camera.

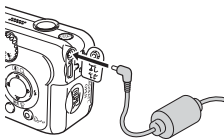

- Please do not attempt to use any AC adapter other than AC Adapter Kit ACK800 with your camera. Use of a different adapter may result in damage to the camera or to the adapter kit.
- Do not connect the AC Adapter Kit ACK800 to any other devices. It could cause smoke and fire, or damage the compact power adapter.

Using Rechargeable Batteries (Sold Separately)

Battery and Charger Kit CBK4-300*

Included are the battery charger and four rechargeable AA-size NiMH (nickel metal hydride) batteries. Charge the batteries as shown below.

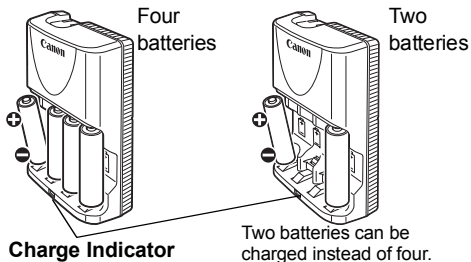

- Insert the batteries into the charger before plugging the charger into a power outlet.
- The indicator blinks while charging, then remains lit when charging is finished.

* The Battery and Charger Kit CBK4-200 can also be used.



Four batteries are supplied with the Battery and Charger Kit CBK4-300. However, only two batteries are used for this camera.



- The Battery Charger CB-5AH can only be used with Canon AA-size NiMH batteries NB-3AH and NB-2AH. (The Battery Charger CB-4AH can only be used with Canon AA-size NiMH batteries NB-2AH.) Do not attempt to charge any other types of batteries, and do not attempt to charge NB-3AH or NB-2AH batteries in any other chargers.
- Do not mix batteries with different purchase dates or different charge states. When recharging batteries from the camera, always recharge both of them at the same time.
- Do not attempt to recharge fully charged batteries, as doing so may reduce or impair battery performance. Also, do not charge batteries for more than 24 consecutive hours.



- Do not recharge batteries in enclosed areas that tend to retain heat.
- Repeatedly recharging batteries before they become fully depleted may cause batteries to lose capacity. Do not recharge the batteries until the LCD monitor displays the "Change the batteries" message.
- Wipe the battery terminals well with a dry cloth in the following situations, as the terminals may be soiled with oil from one's skin or dirt:
 - If the battery usage time has considerably diminished.
 - If the number of recordable images has considerably diminished.
 - When charging the batteries (insert and remove the batteries two or three times before charging)
 - When charging completes in a matter of a few minutes (the battery charger indicator remains lit)
- You may not be able to fully charge the batteries due to their specifications right after purchase or after long periods of non-use. If this happens, use the batteries until their charge is depleted before charging them again. After doing this several times, battery performance will be restored.
- Since storing a fully charged battery for long periods of time (about one year) can shorten its lifecycle or affect performance, you are recommended to use the battery in the camera until it is completely discharged and to store it at normal temperature (0 - 30 °C (32 - 86 °F) or less). If you do not use the battery for long periods of time, charge it fully and discharge it fully in the camera at least once a year before returning it to storage.
- If battery usage time is considerably low despite their terminals' being wiped and the battery charger's indicator remaining lit, it is possible that the batteries have reached the end of their lifespan. Switch to different, unused batteries. If you are purchasing new batteries, look for Canon AA-size NiMH NB4-300 (NB-3AH set of 4) batteries.
- Leaving batteries in the camera or charger may damage it causing battery leakage. Remove batteries from the camera or charger and store in a dry cool location when not in use.



- It takes approximately 2 hours when two batteries are loaded one at each end of the charger and approximately 4 hours 40 minutes with four for the charger to fully recharge them (as determined by testing at Canon facilities). Please do not charge batteries in areas where the temperature is outside the range of 0 to 35 °C (32 to 95 °F).
- Charging time varies according to ambient temperature and to the batteries' initial charge state.
- The battery charger may emit noise while charging. This is not a malfunction.
- You can also use Battery/Charger Kit CBK100 or CBK4-200.

Using an Externally Mounted Flash (Sold Separately)

High-Power Flash HF-DC1

This flash is used to supplement the camera's built-in flash when the subject is too far away for proper illumination. Use the following procedures to affix the camera and High-Power Flash to the supporting bracket.

Please read the instructions accompanying the flash along with this explanation.

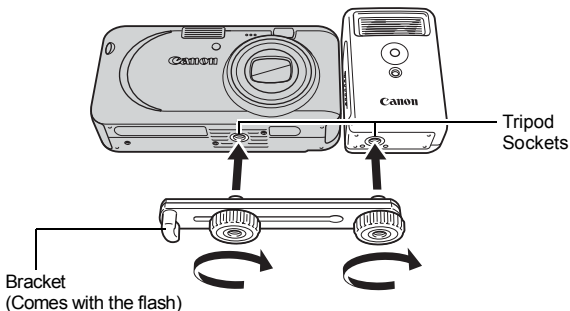



- The flash charge time will lengthen as the battery charge gets weaker. Always set the power/mode switch to [OFF] when you finish using the flash.
- Be careful not to touch the flash window or sensor windows with your fingers while the flash is in use.
- The flash may fire if another flash is being used in close proximity.
- The High-Power Flash may not fire outdoors in daylight or when there are no reflective items.
- For continuous shooting, although the flash fires for the first shot, it does not fire for subsequent shots.
- Fasten the attachment screws securely so that they do not loosen. Failure to do so may lead to the dropping of the camera and flash resulting in damage to both.



- Before attaching the bracket to the flash, check that the lithium battery (CR123A or DL123) is installed.
- To illuminate the subjects properly, install the flash so that it is up against the side of the camera and parallel with the camera's front panel.
- A tripod can be used even when the flash is attached.

Batteries

● Charge becomes Severely Limited

If the battery usage time has considerably diminished, wipe the battery terminals well with a dry cloth. The terminals may be soiled with oil from one's skin or other dirt.

● Usage in Cold Temperatures (Less than 0°C/32°F)

Get a spare generic lithium ion battery (CR123A or DL123). You are recommended to place the spare battery in your pocket to warm it up before switching it for the battery in the flash.

● Non-Use over Extended Periods

Leaving batteries in the High-Power Flash could allow the battery fluid to leak, damaging the product. Remove the batteries from the High-Power Flash and store them in a cool, dry place.

Camera Care and Maintenance

Never use thinners, benzine, synthetic cleansers or water to clean the camera. These substances may distort or damage the equipment.

Camera Body

Gently wipe dirt off the camera body with a soft cloth or eyeglass lens wiper.

Lens

First use a lens blower brush to remove dust and dirt, then remove any remaining dirt by wiping the lens lightly with a soft cloth.



Never use synthetic cleansers on the camera body or lens. If dirt remains, contact the closest Canon Customer Support Help Desk as listed on rear of the European Warranty System (EWS) Booklet.

Viewfinder and LCD Monitor

Use a lens blower brush to remove dust and dirt. If necessary, gently wipe with a soft cloth or an eyeglass lens wiper to remove stubborn dirt.



Never rub or press strongly on the LCD monitor. These actions may damage it or lead to other problems.

Specifications

All data is based on Canon's standard testing methods. Subject to change without notice.

PowerShot A430/PowerShot A420

(W): wide angle (T): telephoto

Camera Effective Pixels	Approx. 4.0 million
Image Sensor	1/3-inch type CCD (Total number of pixels: Approx. 4.2 million)
Lens	PowerShot A430: 5.4 (W) - 21.6 (T) mm (35mm film equivalent: 39 (W) - 156 (T) mm) f/2.8 (W) - f/5.8 (T) PowerShot A420: 5.4 (W) - 17.3 (T) mm (35mm film equivalent: 39 (W) - 125 (T) mm) f/2.8 (W) - f/5.1 (T)
Digital Zoom	PowerShot A430: Still Images: Approx. 3.6x (Up to approx. 14x in combination with the optical zoom) Movies (available in Standard mode only): Approx. 2.0 (Up to approx. 7.9 in combination with the optical zoom). PowerShot A420: Still Images: Approx. 3.6x (Up to approx. 11x in combination with the optical zoom) Movies (available in Standard mode only): Approx. 2.0 (Up to approx. 6.4 in combination with the optical zoom).
Optical Viewfinder	Real-image zoom viewfinder
LCD Monitor	1.8-inch, low-temperature polycrystalline silicon TFT color LCD, approx. 77,000 pixels (Picture coverage 100%)
AF System	TTL autofocus PowerShot A430: Focusing frame: 9-point AiAF/1-point AF (fixed to center) TTL autofocus PowerShot A420: Focusing frame: 5-point AiAF/1-point AF (fixed to center)

Shooting Distance (From the front of the lens)	Normal: 47 cm (1.5 ft.) – infinity Macro: 5 – 47 cm (W)/25 – 47 cm (T) (2.0 in. – 1.5 ft. (W)/9.8 in. – 1.5 ft. (T)) Super Macro: 1 – 5 cm (W) (0.39 in. – 2.0 in) (W) Infinity: 3 m (9.8 ft.) – infinity
Shutter	Mechanical shutter + electronic shutter
Shutter Speeds	1 – 1/2000 sec. The shutter speed varies according to the shooting mode. Slow shutter speeds of 1 to 1/6 sec. operate with noise reduction.
Metering System	Evaluative, Center-weighted average, or Spot (fixed to center)
Exposure Compensation	± 2 stops in 1/3-stop increments
ISO Speed	Auto*, ISO 64/100/200/400 equivalent * Camera automatically sets the optimal speed for each shooting mode.
White Balance	Auto, pre-set (available settings: Day Light, Cloudy, Tungsten, Fluorescent or Fluorescent H), or custom
Built-in Flash	Auto, auto with red-eye reduction, flash on with red-eye reduction, flash on, flash off, and slow synchro
Flash Range	Normal: 47 cm – 3.0 m (W)/47 cm – 2.0 m (T) (1.5 – 9.8 ft. (W)/1.5 – 6.6 ft. (T)) Macro: 30 – 47 cm (12 in. – 1.5 ft.) (W/T) (When ISO speed is set to AUTO.)
Shooting Modes (Still images) (Movie)	Auto, Manual, Super macro* ¹ , Color Accent* ¹ , Color Swap* ¹ , Special Scene* ² , Stitch assist* ¹ Standard, Compact, Color Accent, Color Swap * ¹ Selectable in Manual mode. * ² Portrait, Night Snapshot, Kids&Pets, Indoor, Foliage, Snow, Beach, Fireworks
Continuous Shooting	PowerShot A430: Approx. 2.3 shots/sec. (Large/Fine mode) PowerShot A420: Approx. 2.3 shots/sec. (Large/Fine mode)
Self-timer	Activates shutter after an approx. 10-sec./ approx. 2-sec. delay or a Custom Timer

Recording Media	SD memory card/MultiMediaCard This camera has been tested with memory cards up to 2 GB. All memory card functions cannot be guaranteed.
File Format	Design rule for camera file system and DPOF compliant
Data Type (Still images)	Exif 2.2 (JPEG)*1
(Movies)	AVI (Image data: Motion JPEG) For PowerShot A430 only: Sound Data: WAVE (monaural)
Compression	Superfine, Fine, Normal
Number of Recording Pixels (Still Images)	Large: 2272 × 1704 pixels Medium 1: 1600 × 1200 pixels Medium 2: 1024 × 768 pixels Small: 640 × 480 pixels Postcard Date Imprint Mode: 1600 × 1200 pixels Wide: 2272 × 1280 pixels
Number of Recording Pixels (Movies)	Standard, Color Accent, Color Swap: 640 × 480 pixels (10 frames/sec.) 320 × 240 pixels (30 frames/sec.) Recording can continue until the memory card is full* PowerShot A430: Max. Clip Size at one time: 1 GB** PowerShot A420: Max. Clip Length at one time: 3 minutes Compact: 160 × 120 pixels (15 frames/sec.) PowerShot A430: Max. Clip Length at one time: 3 minutes** PowerShot A420: Max. Clip Length at one time: 3 minutes
	* Using super high-speed memory cards (SDC-512MSH recommended).
	** Even if the clip size has not reached 1 GB, recording will stop at the moment the clip length reaches 1 hour. Depending on the volume and data writing speed of the memory card, recording may stop before reaching 1 hour or before the recorded data volume has reached 1 GB.

Playback Modes	Single, Index (9 thumbnail images), Magnified (approx. 10x (max.) on LCD monitor; images can be sent in the magnified state), Auto Play, Movie, or Sound Memo (approx. 1 minute (max.) record/play on PowerShot A430 only)
Direct Print	<i>PictBridge</i> compliant, <i>Canon Direct Print</i> , and <i>Bubble Jet Direct</i> compatible
My Camera settings	For PowerShot A430 only: Start-up image, start-up sound, operation sound, self-timer sound, and shutter sound
Interface	USB (mini-B), PTP (Picture Transfer Protocol) For PowerShot A430 only: Audio/Video output (NTSC or PAL selectable, monaural audio)
Power Source	Two AA alkaline batteries (included in the camera kit) Two AA NiMH batteries (NB-3AH) (sold separately) AC Adapter Kit ACK800 (sold separately)
Operating Temperatures	0 – 40 °C (32 – 104 °F)
Operating Humidity	10 – 90%
Dimensions	PowerShot A430: 103.0 × 51.8 × 40.2 mm (4.06 × 2.04 × 1.58 in.) PowerShot A420: 103.3 × 51.8 × 40.2 mm (4.07 × 2.04 × 1.58 in.)
Weight (camera body only)	PowerShot A430: Approx. 160 g (5.64 oz.) PowerShot A420: Approx. 150 g (5.29 oz.)

*1 This digital camera supports Exif 2.2 (also called "ExifPrint"). ExifPrint is a standard for enhancing the communication between digital cameras and printers. By connecting to an ExifPrint-compliant printer, the camera's image data at the time of shooting is used and optimized, yielding extremely high quality prints.

Battery Capacity

PowerShot A430

	Number of Images Shot		Playback Time
	LCD Monitor ON (Based on the CIPA standard)	LCD Monitor Off	
AA Alkaline Batteries (included with the camera)	Approx. 90 images	Approx. 600 images	Approx. 10 hours
AA NiMH Battery (NB-3AH) (full charge)	Approx. 360 images	Approx. 1000 images	Approx. 12 hours

PowerShot A420

	Number of Images Shot		Playback Time
	LCD Monitor ON (Based on the CIPA standard)	LCD Monitor Off	
AA Alkaline Batteries (included with the camera)	Approx. 90 images	Approx. 600 images	Approx. 10 hours
AA NiMH Battery (NB-3AH) (full charge)	Approx. 360 images	Approx. 1000 images	Approx. 12 hours

- The actual figures will vary according to the shooting conditions and settings.
- Movie data is excluded.
- At low temperatures, the battery performance may diminish and the low battery icon may appear very rapidly. In such a case, the performance can be improved by warming the batteries in your pocket before use.

Test Conditions

Shooting: Normal temperature ($23\text{ }^{\circ}\text{C} \pm 2\text{ }^{\circ}\text{C}/73\text{ }^{\circ}\text{F} \pm 3.6\text{ }^{\circ}\text{F}$), normal relative humidity ($50\% \pm 20\%$), alternating max. wide angle and max. telephoto shots at 30 second intervals with the flash fired once every two shots and the camera power turned off after every tenth shot. Power is left off for a sufficient amount of time*, then the power is turned back on and the testing procedure is repeated.

- A Canon-brand memory card is used.

* Until the battery returns to normal temperature

















Playback: Normal temperature ($23\text{ }^{\circ}\text{C} \pm 2\text{ }^{\circ}\text{C}/73\text{ }^{\circ}\text{F} \pm 3.6\text{ }^{\circ}\text{F}$), normal relative humidity ($50\% \pm 20\%$), continuous playback at 3 seconds per image.



See *Battery Handling Precautions* (p. 85).

Memory Cards and Estimated Capacities

: Card included with the camera







Recording Pixels	Compression	16 MB	SDC-128M	SDC-512MSH
L (Large) 2272 × 1704 pixels		7	61	237
		13	109	425
		26	217	839
M1 (Middle 1) 1600 × 1200 pixels		14	121	471
		26	217	839
		50	411	1590
M2 (Middle 2) 1024 × 768 pixels		25	211	816
		45	372	1438
		80	652	2518
S (Small) 640 × 480 pixels		56	460	1777
		88	711	2747
		138	1118	4317
 (PostCard Date Imprint Mode) 1600 × 1200 pixels		26	217	839
W (Wide) 2272 × 1280 pixels		9	81	317
		17	144	559
		34	279*	1078

 Capable of smooth continuous shooting (p. 33). This reflects standard shooting criteria established by Canon. Actual results may vary according to the subject and shooting conditions.

* Smooth continuous shooting only available when card has been formatted with a low level format.

Movie

: Card included with the camera

		Recording Pixels/ Frame Rate	16 MB	SDC-128M	SDC-512MSH
 Standard		640 × 480 pixels/ 10 frames/sec.	23 sec.	3 min. 10 sec.	12 min. 16 sec.
 Color Accent					
 Color Switch		320 × 240 pixels/ 30 frames/sec.	22 sec.	3 min. 1 sec.	11 min. 42 sec.
 Compact		160 × 120 pixels/ 15 frames/sec.	1 min. 47 sec.	14 min. 29 sec.	55 min. 57 sec.





















Maximum movie clip length:    : 1 hour,  : 3 min (3 min. for all modes with the PowerShot A420). The figures indicate the maximum continuous recording time.

Image Data Sizes (Estimated)

Recording Pixels	Compression		
	 (Super Fine)	 (Fine)	 (Normal)
 (Large) 2272 × 1704 pixels	2002 KB	1116 KB	556 KB
 (Middle 1) 1600 × 1200 pixels	1002 KB	558 KB	278 KB
 (Middle 2) 1024 × 768 pixels	570 KB	320 KB	170 KB
 (Small) 640 × 480 pixels	249 KB	150 KB	84 KB
 (PostCard Date Imprint Mode) 1600 × 1200 pixels	–	558 KB	–
 (Wide) 2272 × 1280 pixels	1495 KB	835 KB	418 KB

		Recording Pixels	Frame Rate	File size
 Standard		640 × 480 pixels	10 frames/sec.	660 KB/sec.
 Color Accent		320 × 240 pixels	30 frames/sec.	660 KB/sec.
 Color Switch				
 Compact		160 × 120 pixels	15 frames/sec.	120 KB/sec.

MultiMediaCard

Interface	Compatible with MultiMediaCard standards
Dimensions	32.0 × 24.0 × 1.4 mm (1.3 × 0.9 × 0.1 in.)
Weight	Approx. 1.5 g (0.05 oz.)

SD Memory Card (Sold Separately)

Interface	Compatible with SD memory card standards
Dimensions	32.0 × 24.0 × 2.1 mm (1.3 × 0.9 × 0.1 in.)
Weight	Approx. 2 g (0.07 oz.)

NiMH Battery NB-3AH (Sold Separately)

(Included with the separately sold NiMH NB4-300 or the Battery/Charger Kit CBK4-300)

Type	Nickel metal hydride battery
Nominal Voltage	1.2 V DC
Typical Capacity	2500 mAh (Lowest: 2300 mAh)
Cycle Life	Approx. 300 (estimated)
Operating Temperatures	0 – 40 °C (32 – 104 °F)
Dimensions	Diameter: 14.5 mm (0.6 in.) Length: 50.0 mm (2.0 in.)
Weight	Approx. 30 g (1.06 oz.)

Battery Charger CB-5AH (Sold Separately)

(Included with the separately sold Battery/Charger Kit CBK4-300)

Rated Input	100 - 240 V AC (50/60 Hz) 16 VA (100 V) - 21 VA (240 V)
Rated Output	565 mA* ¹ , 1275 mA* ²
Charging Time	Approx. 4 hours 40 minutes* ¹ Approx. 2 hour* ²
Operating Temperatures	0 – 35 °C (32 – 95 °F)
Dimensions	65.0 × 105.0 × 27.5 mm (2.56 × 4.13 × 1.08 in.)
Weight (Including the compact power adapter cable)	Approx. 95 g (3.35 oz.)

*1 To charge four NB-3AH NiMH Batteries

*2 To charge two NB-3AH NiMH Batteries loaded one at each end of the battery charger

Compact Power Adapter CA-PS800 (Sold Separately)

(Included with the separately sold AC Adapter Kit ACK800)

Rated Input	100 – 240 V AC (50/ 60 Hz) 16 VA (100 V) – 20 VA (240 V)
Rated Output	3.2 V DC, 2.0 A
Operating Temperatures	0 – 40 °C (32 – 104 °F)
Dimensions	42.6 × 104.0 × 31.4 mm (1.68 × 4.09 × 1.24 in.)
Weight	Approx. 180 g (6.35 oz.)

INDEX

A

- AC Adapter Kit ACK800..... 90
- AF 46
- AF Frame 16
- AF-assist Beam..... 24
- AiAF 46
- Auto Play (Slide Show) 64
- Auto Rotate Function 54

B

- Battery
 - Battery Capacity 100
 - Handling..... 85
 - Installing..... *Basic Guide*: p. 1
- Battery Charger CB-5AH 105

C

- Color Accent 42
- Color Swap 43
- Compact Power Adapter
 - CA-PS800..... 105
- Compression..... 31
- Continuous Shooting 33
- Create Folder 55
- Custom White Balance 50

D

- Date Battery 89
- Date/Time
 - *Basic Guide*: p. 2, 26
- Design Rule for Camera File System..... 98
- DIGITAL Terminal 13
- Digital Zoom..... 32
- Direct Interface Cable
 - *Basic Guide*: p. 13
- Direct Transfer
 - *Basic Guide*: p. 20
- Download images to a computer
 - *Basic Guide*: p. 14
- DPOF
 - Transfer Order 24, 69

DPOF Print Order

- Print Settings 66
- Print Style..... 68

E

- Erasing
 - All Images 65
 - Single Images
 - *Basic Guide*: p. 10
- Exposure 48

F

- File Number..... 17, 56
- Flash *Basic Guide*: p. 8, 12
- Focus lock 47
- Focusing..... 46
- FUNC. Menu 21
- FUNC./SET 14, 21

H

- HF-DC1 93

I

- Image Data Sizes
 - (Estimated)..... 103
- Image Destination 55
- Index Playback..... 59
- Indicator..... 14, 19
- Infinity..... *Basic Guide*: p. 9, 14
- Interface Cable
 - *Basic Guide*: p. 17
- ISO Speed..... 53

L

- Language 26
- LCD Monitor
 - Information Displayed 16
 - Night Display 15
 - Using the LCD Monitor 15
- Lens Retract..... 26

M

- Macro *Basic Guide*: p. 9, 14

Magnifying	58
Memory Card	
Estimated Capacities.....	102
Formatting	29
Handling	87
Installing	<i>Basic Guide: p. 1</i>
Memory Cards	102
Menu.....	21, 23
FUNC. Menu	23
Menu List.....	23
Menus and Settings.....	21
My Camera.....	27
Play Menu	24
Rec. Menu	24
Set up Menu	25
Messages	82
Metering Modes.....	47
Mode Dial .	<i>Basic Guide: p. 5, 14</i>
Movie	
Editing	60
Playback.....	59
Shooting	37
Viewing.....	59
Mute.....	25
My Camera Settings.....	72
My Colors	51
N	
NB-3AH	104
O	
Operation Sound	27
P	
Play Menu.....	24
Playback Mode	
.....	<i>Basic Guide: p. 10</i>
Postcard Date Imprint Mode...	34
Power Button.....	12
Power Saving Function.....	20
Print Menu	24
Print Method	26
Print/Share Button	14
Printing ...	<i>Basic Guide: p. 13, 66</i>
Protect.....	64

R	
Rec. Menu.....	24
Recording Pixels.....	30
Red-Eye Reduction	
.....	<i>Basic Guide: p. 8</i>
Reset All.....	28
Resetting the File Number	56
Review	24
Rotate	62
S	
Self-Timer	35
Selftimer Sound	27
Set up Menu.....	25
Shooting Mode	
Auto	<i>Basic Guide: p. 5</i>
Color Accent Mode	42
Color Swap Mode	43
Functions Available in Each	
Shooting Mode	110
Manual	<i>Basic Guide: p. 6</i>
Movie	37
Special Scene	
.....	<i>Basic Guide: p. 7</i>
Stitch Assist	40
Super Macro	31
Shutter Button	12
Shutter Sound.....	27
Slide Show	64
Smooth Continuous Shooting	33
Sound Memos.....	62
Spot Frame	16, 48
Start-up Image	27
Start-up Sound.....	27
Stitch Assist	40
Super Macro	31
System Requirements	
.....	<i>Basic Guide: p. 15</i>
T	
Telephoto.....	14
Terminal Cover	13
V	
Video System.....	26

W

White Balance.....	49
Wide Angle	<i>Basic Guide</i> : p. 8, 14
Wrist Strap	12

Disclaimer

- While every effort has been made to ensure that the information contained in this guide is accurate and complete, no liability can be accepted for any errors or omissions.
- Canon reserves the right to change the specifications of the hardware and software described herein at anytime without prior notice.
- No part of this guide may be reproduced, transmitted, transcribed, stored in a retrieval system, or translated into any language in any form, by any means, without the prior written permission of Canon.
- Canon makes no warranties for damages resulting from corrupted or lost data due to a mistaken operation or malfunction of the camera, the software, SD memory cards (SD cards), personal computers, peripheral devices, or use of non-Canon SD cards.

Trademark Acknowledgments

- Canon, PowerShot, PIXMA and SELPHY are trademarks of Canon Inc.
- Macintosh, Mac OS and QuickTime are trademarks of Apple Computer Inc., registered in the United States and/or other countries.
- Microsoft® and Windows® are either registered trademarks or trademarks of Microsoft Corporation in the United States and/or other countries.
- SD is a trademark.
- Other names and products not mentioned above may be registered trademarks or trademarks of their respective companies.

Functions Available in Each Shooting Mode

The chart below is a reference for the settings available for various shooting conditions. The settings selected in each shooting mode are saved after you finish shooting.



Function													Page
Recording Pixels	Large		○*	○*	○*	○*	○*	△*	○*	○	○	—	p. 30
	Medium 1		○	○	○	○	○	△	○	○	○	—	
	Medium 2		○	○	○	○	○	△	○	○	○	—	
	Small		○	○	○	○	○	△	○	○	○	—	
	Postcard		○	○	○	○	○	—	○	○	○	—	
	Wide		○	○	○	○	○	—	○	○	○	—	
Compression	Super Fine		○	○	○	○	○	△	○	○	○	—	p. 30
	Fine		○*	○*	○*	○*	○*	△*	○*	○	○	—	
	Normal		○	○	○	○	○	△	○	○	○	—	
Recording Pixels (Movie)/ Frame Rate			—	—	—	—	—	—	—	—	○ ⁽¹⁾	p. 39	
Flash ⁽²⁾	Auto		○	○	—	○	○	—	○	○	○	—	Basic Guide p. 8
	Auto with Red-Eye Reduction		○*	○*	—	○	○	—	○	○	○	—	
	On with Red-Eye Reduction		—	—	—	—	—	—	○	○	○	—	
	On		—	○	—	○	○	△	○	○	○	—	
	Off		○	○	○*	○*	○*	△*	○	○	○	—	
	Slow Synchro		—	○	—	○	○	△	—	○	○	—	
Macro Mode			○	○	—	○	○	△	○ ⁽³⁾	○	○	Basic Guide p. 9	
Infinity Mode			—	○	—	○	○	△	○ ⁽³⁾	○	○		
Shooting Method	Single		○*	○*	○*	○*	○*	△*	○*	○*	○*	—	p. 33 p. 35
	Continuous Shooting		—	○	○	—	—	—	○	○	○	—	
	10-sec. Self-Timer		○	○	○	○	○	△	○	○	○	—	
	2-sec. Self-Timer		○	○	○	○	○	△	○	○	○	—	
	Custom Timer		○	○	○	—	—	—	○	○	○	—	
Date Stamp			○	○	○	○	○	—	○	○	○	p. 34	
Autofocus Modes			—	○	○	○	○	—	○ ⁽³⁾	○	○	p. 46	

Function	📷		📷M				SCN				📽	Page
	📷	📷M	📷	📷M	📷S	📷	📷	📷	📷	📷		
AF-assist Beam	○	○	○	○	○	△	○ ⁽⁴⁾	○	○	p. 24		
Digital Zoom	○	○	○	—	—	—	○	○ ⁽⁵⁾	○	p. 32		
Metering Method	Evaluative	—	○*	○*	—	—	—	—	—	p. 47		
	Center-Weighted Average	—	○	○	—	—	—	—	—			
	Spot	—	○	○	—	—	—	—	—			
Exposure Compensation	—	○	○	—	—	△	○	—	—	p. 48		
White Balance ⁽⁷⁾	—	○	○	—	—	△	— ⁽⁸⁾	○ ⁽⁶⁾	—	p. 49		
My Colors	—	○	○	—	—	○	—	○ ⁽⁶⁾	—	p. 51		
A430 Auto Rotate	○	○	○	○	○	○	○	—	—	p. 54		
ISO Speed	— ⁽⁸⁾	○ ⁽⁹⁾	○ ⁽⁹⁾	— ⁽⁸⁾	— ⁽⁸⁾	— ⁽⁸⁾	— ⁽⁸⁾	— ⁽⁸⁾	— ⁽⁸⁾	p. 53		
Grid Lines	○	○	○	○	○	—	○	○	○	p. 24		

* Default setting ○ Setting available △ Setting can only be selected for the first image.

-  (Shaded Area): Setting is remembered even when the camera power is shut off.
- With the exception of the [Date/Time], [Language], and [Video System (PowerShot A430 only)] settings, all the other menu settings and changes made with the camera buttons can be reset to the default values in a single operation (p. 28).



(1) The recording pixels/frame rates for the  (Movie) mode are as follows.

		📽	📷M	📷S	📷
Recording Pixels/ Frame Rate		640 × 480 pixels/ 10 frames/sec.	○*	—	—
		320 × 240 pixels/ 30 frames/sec.	○	—	—
		160 × 120 pixels/ 15 frames/sec.	—	—	○

(2) The default flash setting is Auto with Red-Eye Reduction in the     modes, Auto in the   modes, and Off in the   modes.



- The flash cannot be set in  mode.

- When the flash fires in  mode, the camera will automatically use Slow Synchro mode.

(3) You cannot switch between the Macro/Infinity modes when the camera is in the   modes.

(4) AF cannot be selected in the  modes.

(5)  only is available.

(6) This cannot be set in  or  modes.

(7) This cannot be set when My Colors is set to Sepia or B/W.

(8) Automatically set by the camera.

(9) Default setting is ISO AUTO.



Canon