

ENGLISH

Canon

PowerShot S3 IS

DIGITAL CAMERA



Before Using the Camera

Shooting

Using the Mode Dial

Advanced Shooting Functions

Playback/Erasing

Print Settings/Transfer Settings

Viewing Images on a TV set

Customizing the Camera

Troubleshooting/List of Messages

Appendix

Advanced

Camera User Guide

This guide explains camera features and procedures in detail.



Main Features

Shooting

- Automatically adjusts shooting settings to match particular conditions
- Reduces blurriness with an image stabilizer function
- Shoot in high-speed ISO with reduced blurriness from hand or subject movement
- Shoot movies in any mode by pressing the movie button
- Shoots movies with stereo sound
- Automatically detects camera orientation with an Intelligent Orientation sensor
- Attach the separately sold wide converter, tele-converter lens, or close-up lens to shoot

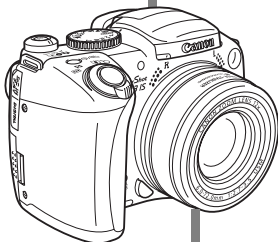

Playback

- Plays movies with stereo sound
- Auto plays slide shows

Editing

- Adds effects to still images with My Colors
- Records sound memos for still images
- Edits movies
- Records sound only (sound recorder)

Printing













- Makes printing easy with the Print/Share button
- Also supports non-Canon PictBridge compliant printers

Uses of Recorded Images

- Effortlessly transfer them to a computer with the Print/Share button

Conventions Used in this Guide



Icons appearing below titles indicate the modes in which the procedure can be used. In the example below, the mode dial can be used in the following shooting modes.

-  (Auto)
-  (Portrait)
-  (Landscape)
-  (Night Scene)
-  (Sports)
-  (Special Scene)
-  (Stitch Assist)
-  (Movie)
-  (Program AE)
-  (Shutter-speed priority AE)
-  (Aperture-priority AE)
-  (Manual)

Movie Shooting

Shooting Mode         **P** **Tv** **Av** **M**

- See Functions Available in Each Shooting Mode ([p. 161](#)).

-  This mark denotes issues that may affect the camera's operation.
-  This mark denotes additional topics that complement the basic operating procedures.

You can use SD* memory cards and MultiMediaCards with this camera. These cards are collectively called memory cards in this guide.

* SD stands for Secure Digital, a copyright protection system.

Use of genuine Canon accessories is recommended.

This product is designed to achieve excellent performance when used with genuine Canon accessories. Canon shall not be liable for any damage to this product and/or accidents such as fire, etc., caused by the malfunction of non-genuine Canon accessories (e.g., a leakage and/or explosion of a battery pack). Please note that this warranty does not apply to repairs arising out of the malfunction of non-genuine Canon accessories, although you may request such repairs on a chargeable basis.



Contents

Items marked with a ☆ are lists or charts that summarize camera functions or procedures.

Conventions Used in this Guide	1
Handling Precautions	5
Please Read	5
Safety Precautions	6
Preventing Malfunctions	11
Before Using the Camera - The Components Guide	12
Before Using the Camera - Operations	16
Using the LCD Monitor and the Viewfinder	16
Customizing Display Information	17
Information Displayed on the LCD Monitor	20
Power Saving Function	23
Setting the World Clock	24
☆ Menus and Settings	26
☆ Menu List	28
Resetting Settings to Their Default Values	34
Formatting Memory Cards	35
Shooting	36
Changing the Recording Pixels and Compression (Still Images)	36
Setting the Slow Synchro	38
Setting the Image Stabilizer Function	39
Magnified Close-Up Shooting (Super Macro)	40
Using the Digital Zoom	41
📷 Continuous Shooting	42
🕒 Using the Self-Timer	43
Using the Mode Dial	46
🎬 Movie Shooting	46
📷 Shooting Panoramic Images (Stitch Assist)	51
SCN Changing the Colors and Shooting	53

Shooting in the Creative Zone	57
P Program AE	
Tv Setting the Shutter Speed	
Av Setting the Aperture	
M Manually Setting the Shutter Speed and Aperture	

Advanced Shooting Functions 61

 Registering Settings to the Shortcut Button	61
 Selecting an AF Frame	63
Shooting Hard-to-Focus Subjects (Focus Lock, AF Lock, Manual Focus)	64
Switching between Focus Settings	67
Focus Bracketing (Focus-BKT Mode)	68
ISO Adjusting the ISO Speed	69
Locking the Exposure Setting (AE Lock)	70
Shooting with FE Lock	72
Switching between Metering Modes	73
Adjusting the Exposure Compensation	75
Auto Exposure Bracketing (AEB Mode)	76
Adjusting the Tone (White Balance)	77
Shooting in a My Colors Mode	80
⚡ Switching between Flash Adjustment Settings	82
Compensating the Flash Adjustment/Flash Output	82
Switching the Timing at which the Flash Fires	83
Shooting Images at Set Intervals (Intervalometer)	84
C Saving Custom Settings	86
Setting the Auto Rotate Function	87
Creating an Image Destination (Folder)	88
Resetting the File Number	90

Playback/Erasing 92

🔍 Viewing Magnified Images	92
 Viewing Images in Sets of Nine (Index Playback)	93
 Jumping to Images	94
Viewing Movies	95
Editing Movies	96
Rotating Images in the Display	98
Applying Effects and Playing Back	99
Adding My Colors Effects	100
🎤 Attaching Sound Memos to Images	102
Sound-Only Recording (Sound Recorder)	103

Automated Playback (Slide Shows)	105
Protecting Images	109
Erasing All Images	110
Print Settings/Transfer Settings	111
Setting the DPOF Print Settings	111
Setting the DPOF Transfer Settings	114
Shooting/Viewing Images on a TV set	116
Customizing the Camera (My Camera Settings)	117
Troubleshooting	120
Camera	120
When the power is turned on	121
LCD monitor/Viewfinder	121
Shooting	122
Shooting Movies	126
Playback	126
Battery	127
TV monitor output	128
Direct print compatible printers	128
List of Messages	129
Appendix	132
Battery Handling	132
Handling the Memory Card	133
Replacing the Date Battery	135
Using Rechargeable Batteries (Sold Separately)	136
Using Conversion Lenses (Sold Separately)	140
Using an Externally Mounted Flash (Sold Separately)	143
Camera Care and Maintenance	145
Specifications	146
INDEX	157
☆ Functions Available in Each Shooting Mode	161

Handling Precautions

Please Read

Test Shots

Before you try to photograph important subjects, we highly recommend that you shoot several trial images to confirm that the camera is operating and being operated correctly.

Please note that Canon Inc., its subsidiaries and affiliates, and its distributors are not liable for any consequential damages arising from any malfunction of a camera or accessory, including memory cards, that results in the failure of an image to be recorded or to be recorded in a way that is machine readable.

Warning Against Copyright Infringement

Please note that Canon digital cameras are intended for personal use and should never be used in a manner that infringes upon or contravenes international or domestic copyright laws and regulations. Please be advised that in certain cases the copying of images from performances, exhibitions, or commercial properties by means of a camera or other device may contravene copyright or other legal rights even if the image was shot for personal use.

Warranty Limitations

For information on your camera's warranty, please refer to the Canon European Warranty System (EWS) Booklet supplied with your camera.

For Canon Customer Support contacts, please see rear of the European Warranty System (EWS) Booklet.

Precautions

Camera Body Temperature

If your camera is used for prolonged periods, the camera body may become warm. Please be aware of this and take care when operating the camera for an extended period.

About the LCD Monitor and Viewfinder

The LCD monitor is produced with extremely high-precision manufacturing techniques. More than 99.99% of the pixels operate to specification. Less than 0.01% of the pixels may occasionally misfire or appear as red or black dots. This has no effect on the recorded image and does not constitute a malfunction.

Video Format

Please set the camera's video signal format to the one used in your region before using it with a TV monitor (p. 116).

Language Setting

Please see the *Basic Guide* (p. 5) to change the language setting.

Safety Precautions

- Before using the camera, please ensure that you read and understand the safety precautions described below. Always ensure that the camera is operated correctly.
- The safety precautions noted on the following pages are intended to instruct you in the safe and correct operation of the camera and its accessories to prevent injuries or damage to yourself, other persons and equipment.
- Equipment refers to the camera, battery, battery charger (sold separately), compact power adapter (sold separately) or Externally Mounted Flash (sold separately).

Warnings

Equipment

- **Store this equipment out of the reach of children and infants. Accidental damage by a child could result in serious injury.**
 - Neck strap: Placement of the strap around the child's neck could result in asphyxiation.
 - Memory card: If swallowed accidentally, contact a doctor immediately.

- **Do not attempt to disassemble or alter any part of the equipment that is not expressly described in this guide.**
- **To avoid the risk of high-voltage electrical shock, do not touch the flash portion of the camera if it has been damaged.**
- **Stop operating the equipment immediately if it emits smoke or noxious fumes.**
- **Do not allow the equipment to come into contact with, or become immersed in, water or other liquids. If the exterior comes into contact with liquids or salt air, wipe it dry with a soft, absorbent cloth.**

Continued use of the equipment may result in fire or electrical shock.

Immediately turn the camera power off and remove the camera battery or unplug the power cord from the power outlet. Please consult your camera distributor or the closest Canon Customer Support Help Desk.

- **Do not use substances containing alcohol, benzene, thinners or other flammable substances to clean or maintain the equipment.**
- **Do not cut, damage, alter or place heavy items on the power cord.**
- **Use only recommended power accessories.**
- **Remove the power cord on a regular periodic basis and wipe away the dust and dirt that collects on the plug, the exterior of the power outlet and the surrounding area.**
- **Do not handle the power cord if your hands are wet.**

Continued use of the equipment may result in fire or electrical shock.

Battery

- **Do not place the battery near a heat source or expose it to direct flame or heat.**
- **The battery should not be immersed in water.**
- **Do not attempt to disassemble, alter or apply heat to the battery.**
- **Avoid dropping or subjecting the batteries to severe impacts that could damage the casing.**
- **Use only recommended batteries and accessories.**

Use of batteries not expressly recommended for this equipment may cause explosions or leaks, resulting in fire, injury and damage to the surroundings. In the event that a battery leaks and the eyes, mouth, skin or clothing contact these substances, immediately flush with water and seek medical assistance.

- **Disconnect the battery charger and compact power adapter from both the camera and the power outlet after recharging or when they are not in use to avoid fire and other hazards.**
- **Do not place anything, such as tablecloths, carpets, bedding or cushions, on top of the battery charger while it is charging.**

Continued use over a long period may cause the units to overheat and distort, resulting in fire.

- **Please use Canon AA-size NiMH batteries and charger recommended for use with these batteries.**
- **The compact power adapter are designed for exclusive use with your camera. Do not use it with other products or batteries.**

There is a risk of overheating and distortion which could result in fire or electrical shock.

- **Before you discard a battery, cover the terminals with tape or other insulators to prevent direct contact with other objects.**

Contact with the metallic components of other materials in waste containers may lead to fire or explosions.

Others

- **Do not trigger the flash in close proximity to human or animal eyes. Exposure to the intense light produced by the flash may damage eyesight.**

In particular, remain at least one meter (39 inches) away from infants when using the flash.

- **Keep objects that are sensitive to magnetic fields (such as credit cards) away from the speaker of the camera.**

Such items may lose data or stop working.

- **When using the optional Canon Wide Converter, Tele Converter, Close-up Lens, or Conversion Lens Adaptor, be sure to attach them firmly.**

If the lens becomes loose and falls off, it may crack, and the shards of glass may lead to cuts.

⚠ Cautions

Equipment

- **Do not get the camera caught on other objects or subject it to strong impacts or shocks when wearing or holding it by the neck strap.**

Doing so may result in injury or damage to the camera.

- **Do not store the equipment in humid or dusty areas.**
- **Do not allow metal objects (such as pins or keys) or dirt to contact the charger terminals or plug.**

Such conditions could lead to fire, electrical shock or other damage.

- **Avoid using, placing or storing the equipment in places subject to strong sunlight or high temperatures, such as the dashboard or trunk (boot) of a car.**
- **Do not use the camera in such a way that would cause it to exceed the rating of the power outlet or wiring. Do not use if the power cord or plug are damaged, or if not fully plugged into the outlet.**
- **Do not use in locations with poor ventilation.**

The above-mentioned can cause leakage, overheating or explosion, resulting in fire, burns or other injuries. High temperatures may also cause deformation of the casing.

- **When not using the camera for extended periods of time, remove the battery from the camera or battery charger and store the equipment in a safe place.**

Storing the camera for extended periods with batteries installed will cause battery leakage and damage the camera.

Flash

- **Do not operate the flash with dirt, dust or other items stuck to the surface of the flash.**
- **Be careful not to cover the flash with your fingers or clothing when shooting.**

The flash may be damaged and emit smoke or noise. The resulting heat build-up could damage the flash.

- **Do not touch the surface of the flash after taking several pictures in rapid succession.**

Doing so could result in burns.

Preventing Malfunctions

Avoid Strong Magnetic Fields

- **Never place the camera in close proximity to electric motors or other equipment generating strong electromagnetic fields.**

Exposure to strong magnetic fields may cause malfunctions or corrupt image data.

Avoid Condensation Related Problems

- **When moving the equipment rapidly between hot and cold temperatures, you can avoid condensation by placing the equipment in an airtight, resealable plastic bag and letting it adjust to temperature changes slowly before removing it from the bag.**

Moving the equipment rapidly between hot and cold temperatures may cause condensation (water droplets) to form on its external and internal surfaces.

If Condensation Forms Inside the Camera

- **Stop using the camera immediately.**

Continued use may damage the equipment. Remove the memory card and battery or compact power adapter from the camera and wait until the moisture evaporates completely before resuming use.

Before Using the Camera - The Components Guide

Front View

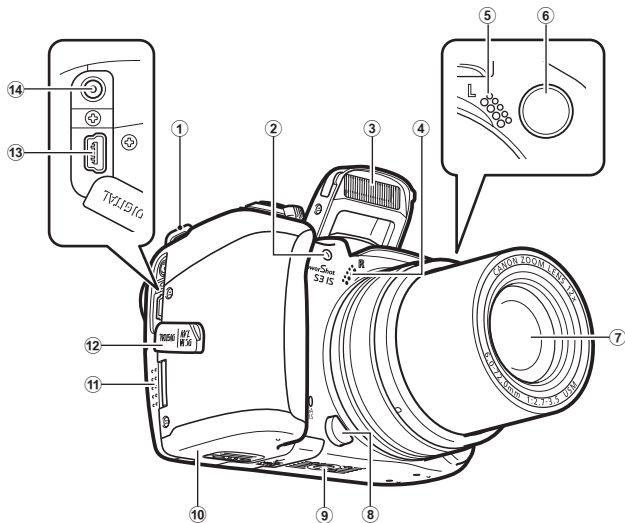

- ① Neck Strap Mounts
- ② Self-timer Lamp/Tally Lamp/Red-eye Reduction Lamp (pp. 43, 46, 28)
- ③ Flash (*Basic Guide* p. 11)
- ④ Microphone (R) (pp. 102, 103)
- ⑤ Microphone (L) (pp. 102, 103)
- ⑥ AF-assist Beam (p. 28)
- ⑦ Lens
- ⑧ Ring Release Button (p. 141)
- ⑨ Tripod Socket (p. 143)
- ⑩ Battery Cover (*Basic Guide* p. 1)
- ⑪ Memory Card Slot Cover (*Basic Guide* p. 1)
- ⑫ Terminal Cover
- ⑬ DIGITAL Terminal (*Basic Guide* p. 21)
- ⑭ DC IN Terminal (p. 139)

Attaching the Neck Strap

Attach the strap as illustrated. Check that the strap does not come loose from the strap mount when pulled. Perform the same steps on the other side of the camera.

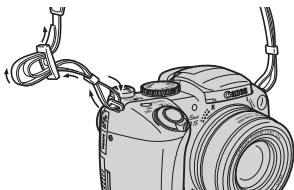

Avoid waving the camera about and getting it caught on other items when the camera is suspended from the strap.

Attaching the Lens Cap

Fit the lens cap over the lens casing so that it covers the entire lens. Always replace the lens cap after use.

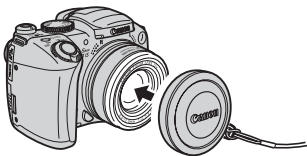

- Attach the lens cap cord to the strap.
- Remove the lens cap before turning on the camera's power.

Back View

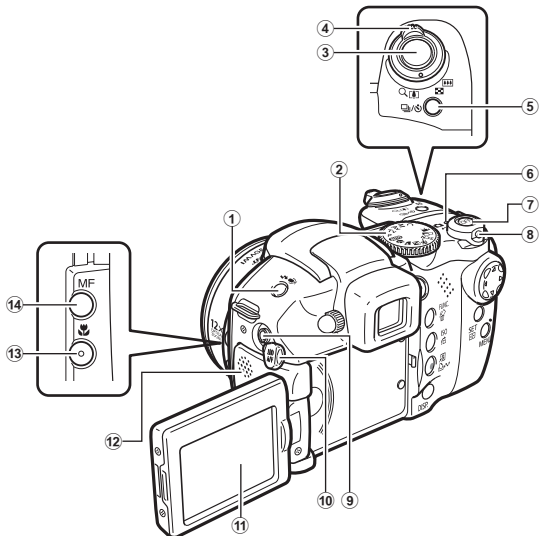

- ① (Flash)/ (Microphone) Button (pp. 102, 103, *Basic Guide* p. 11)
- ② Mode Dial (p. 46, *Basic Guide* p. 8)
- ③ Shutter Button (*Basic Guide* p. 6)
- ④ Zoom Lever
Shooting: (Telephoto)/ (Wide Angle) (p. 41, *Basic Guide* p. 10)
Playback: (Zoom in)/ (Zoom out) (p. 92)
- ⑤ (Continuous)/ (Self-timer) Button (pp. 42, 43)
- ⑥ Power/Mode Indicator
Orange: Shooting mode Green: Playback mode/Printer connection
Yellow: Computer connection
- ⑦ OFF Button
- ⑧ Mode Lever (*Basic Guide* p. 3)
- ⑨ A/V OUT (audio/video output) terminal (p. 116)
- ⑩ Terminal Cover
- ⑪ LCD Monitor (*Basic Guide* p. 2)
- ⑫ Speaker
- ⑬ (Macro) Button (*Basic Guide* p. 12)
- ⑭ MF (Manual Focus) Button (p. 66)

Operation Panel

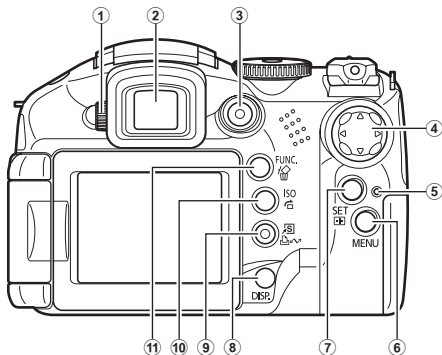

- ① Diopter Adjustment Dial (p. 16)
- ② Viewfinder (p. 16)
- ③ Movie Button (p. 46, *Basic Guide* p. 7)
- ④ Omni Selector
 - ▲(Up) ▼(Down)
 - ◀(Left) ▶(Right)
- ⑤ Indicator
 - Blinking Red: Recording to memory card/Reading memory card/ Erasing from memory card/Transmitting data (during a computer connection)
- ⑥ MENU Button (p. 26, *Basic Guide* p. 16)
- ⑦ SET/ \square (AF Frame Selector) Button (p. 63, *Basic Guide* p. 15)
- ⑧ DISP. Button (p. 16)
- ⑨ \square (Shortcut)/ \square (Print/Share) Button (p. 61, *Basic Guide* pp. 17, 24)
- ⑩ ISO (ISO Speed)/ \square (Jump) Button (pp. 69, 94)
- ⑪ FUNC. (Function)/ \square (Single Image Erase) Button (p. 26, *Basic Guide* pp. 15, 14)

Before Using the Camera - Operations

Using the LCD Monitor and the Viewfinder

Pressing the **DISP.** button switches the display mode.

The screens that are displayed are based on the [Custom Display] settings (p. 17).

Also, closing the LCD monitor causes the viewfinder to display.

1 Press the **DISP.** button.

- The display mode changes as follows.

Shooting Mode (📷)

Playback Mode (▶)

When the LCD monitor is opened.
(Default setting)

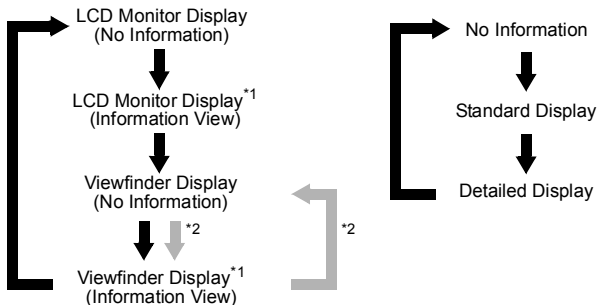

*1 Shooting information, grid lines, and a histogram (**P**, **Tv**, **Av**, and **M** only) are displayed with the default settings.

*2 When the LCD monitor is closed.

- In the shooting modes, the shooting information displays for approximately 6 sec. when settings such as the flash setting are changed, regardless of the selected display mode.
- You can adjust the brightness for the LCD monitor (or viewfinder) (p. 31).
- If the surroundings are too bright (for example, when you are shooting outdoors) and images on the LCD monitor are not clear, use the viewfinder for shooting. Adjust the viewfinder focus (p. 20) with the diopter adjustment dial (p. 15) so the displayed information appears clearly.



- The LCD monitor and viewfinder display settings are remembered even after the camera power is turned off.
- The LCD monitor will not switch to the detailed display in the index playback mode (p. 93).

Customizing Display Information

You can select whether or not to display the following information on the LCD monitor and viewfinder in the current shooting mode, and switch between displays by pressing the **DISP.** button.

- Shooting info.
- Grid Lines
- Histogram* (p. 19)

* **P**, **Tv**, **Av**, and **M** only

1 [Rec.] Menu → [Custom Display].

See *Menus and Settings* (p. 27)

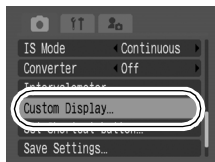

2 [LCD/Viewfinder] → [TV]* / [LV]* / [FV]* / [2]*

- Using the **▲**, **▼**, **◀**, and **▶** buttons, select the LCD monitor or viewfinder you wish to display information for when the **DISP.** button is pressed, and press the **SET** button to place a ✓ mark.
- You cannot disable the display setting of the currently selected display location.
- Display locations marked with  do not display even when the **DISP.** button is pressed.



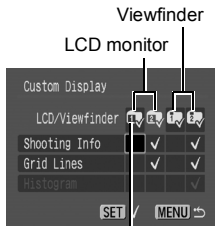

* Default settings.



Currently selected display location

3 [Shooting Info]*/[Grid Lines]*/[Histogram]*.

- Using the ▲, ▼, ◀, and ▶ buttons, select the items you wish to display on the LCD monitor or viewfinder, and press the **SET** button to place a ✓ mark.
- Display locations with no ✓ marks will not have any information displayed.
- Even though items that are greyed out can be set, they will not display in this shooting mode.

* Default setting: , : No Information
, : Displays shooting information, grid lines, and a histogram

Does not display when the DISP. button is pressed

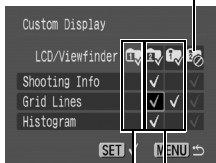

Items with ✓ marks are displayed
No Information



If you press the shutter button halfway and return to the shooting screen from the custom display settings screen, the settings will not be saved.

Histogram

The histogram is a graph that allows you to judge the brightness of an image, and you can display it in the **P**, **Tv**, **Av**, and **M** modes to confirm the brightness while shooting. The greater the bias toward the left in the graph, the darker the image. The greater the bias toward the right, the brighter the image. If the image is too dark, adjust the exposure compensation to a positive value. Similarly, adjust the exposure compensation to a negative value if the image is too bright (p. 75).

Sample Histograms



Dark Image



Balanced Image



Bright Image



In addition to adjusting the exposure compensation, you can also decrease the shutter speed and aperture value to create a brighter image. Similarly, you can increase the shutter speed and aperture value to create a darker image.

Night Display

When shooting in dark conditions, the camera automatically brightens the LCD monitor or viewfinder to suit the brightness of the subject*, making it easier to frame the subject.

* Noise will appear and the movements of the subject will appear irregular in the LCD monitor. The recorded image, however, will not be affected. The brightness of the image displayed in the monitor and the brightness of the actual image recorded will differ. (This function cannot be disabled.)

Information Displayed on the LCD Monitor

Shooting mode

The diagram shows a camera's LCD monitor in shooting mode, displaying a central image of a building. Various information panels are overlaid on the screen, with callouts pointing to their locations:

- Top Left:** Spot Frame (with brackets) and AF Frame (with a square).
- Top Center:** Low Battery (with a battery icon).
- Top Right:** ISO Speed (with ISO values: 80, 100, 200, 400, 800, HI).
- Right Side (Vertical Strip):** Drive Mode, Macro/Super Macro, Flash, Auto Rotate, Rec (Red) Movie Recording, Shooting Modes, Save Settings, Wind Filter (OFF), Time Zone, Folder Creation, Shooting prohibited, AE Lock/FE Lock, Shutter Speeds, Aperture value, Manual Focus, Exposure Shift Bar (Movie), Image Stabilizer, Int. Intervalometer, and AFL AF Lock.
- Bottom Left:** Exposure Compensation (-2 to +2), White Balance (WB), My Colors, Bracket, Flash Adjust, Flash Output, Metering Method, Movie Recording Pixels/Frame Rate, Compression, Recording Pixels (L, M1, M2, S, W), and Camera Shake Warning (Red).
- Bottom Center:** Histogram, Stills: Recordable Shots, and Movies: Remaining Time/Elapsed Time.
- Bottom Right:** Buffer Warning.
- Center:** Grid Lines, Zoom Magnification, Zoom Bar, Focus range (rough guide), and the 'M' mode indicator.

- *1 Appears even if the LCD monitor is set to display no information.
- *2 Appears when selected in [Custom Display] (p. 17).
- *3 This is not normally displayed. It appears when remaining available internal memory (buffer) is half or less during movie recording.
When the buffer warning indicates full, shooting or recording may be stopped.
- *4 "0" appears in red when no more recording space is available for either still images at the current number of recordable images, or movies. When both recording capacities are full, the "Memory card full" message appears.



- Even in the no information display mode, shooting information appears for approximately 6 seconds when changing shooting settings. (Shooting information may not appear depending on the camera settings at that time.)
- The "Raise the flash" message, (camera shake warning), or (flash warning) icon appears in red on the LCD monitor (or viewfinder) in low light conditions while the camera is preparing to shoot. Use one of the following shooting methods.
 - Turn the Image Stabilizer function on (p. 39)
 - Raise the ISO speed
 - Raise the flash to enable automatic or normal firing
 - Fix the camera to a tripod

Playback Mode

Standard

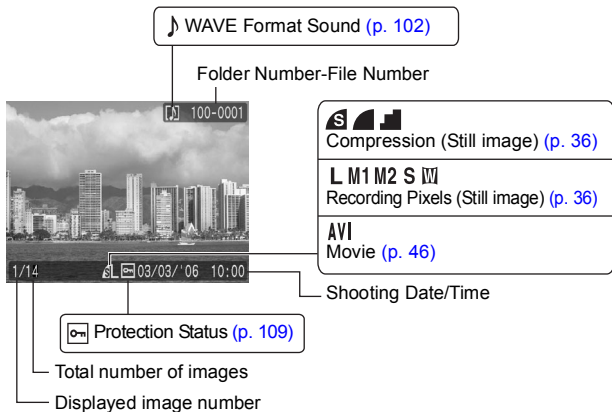



- Information for images shot on other cameras may not display correctly.
- **Overexposure Warning**
In the following cases, overexposed portions of the image blink.
 - When reviewing an image right after shooting in the LCD monitor (information view) or in the viewfinder (information view)
 - When using the detailed display mode of the Playback mode

Power Saving Function

This camera is equipped with a power saving function. The power will shut off in the following circumstances. Press the power button again to restore power.

Shooting Mode	Powers down approximately 3 minutes after the last control is input on the camera. [Display Off] activates and the LCD (or viewfinder) automatically turns off 1 minute after the last control is input, even if [Auto Power Down] is set to [Off]. (To turn the LCD monitor back on, press any button other than the OFF button, or change the vertical or horizontal orientation.)
Playback Mode or Connected to a Printer	Powers down approximately 5 minutes after the last control is input on the camera.

* Default setting (time can be changed).



- Please note that when the power is turned off with the power saving function, small amounts of power are still consumed.
- The power saving function does not activate during automatic slide show playback or while the camera is connected to a computer.
- The power saving function settings can be changed ([p. 31](#)).

Setting the World Clock

When traveling abroad, you can record images with local dates and times simply by switching the time zone setting if you pre-register the destination time zones. You can enjoy the convenience of not having to switch the Date/Time settings.

Setting the Home/World Time Zones

- 1**  (Set up) Menu → [Time Zone].
See *Menus and Settings* (p. 27)

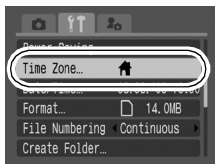

- 2**  (Home) → **SET** button.



- 3** Use the ◀ or ▶ button to select a home time zone from the map → **SET** button.

- To set the daylight saving option, use the ▲ or ▼ button to display . The time will advance by 1 hour.

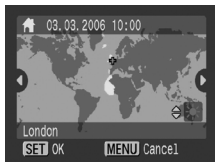

- 4**  (World) → **SET** button → select a destination time zone as same as step 3.

Switching to the Destination Time Zone

1  (Set up) Menu → [Time Zone].

See *Menus and Settings* (p. 27)

2 Use the ◀ or ▶ button to select  (World) → **MENU** button.

- To change the destination time zone, use the SET button.
-



If you do not select a home time zone beforehand, you cannot configure the destination time.



If you change the date and time when the World option is selected, the Home date and time will also change automatically.

Menus and Settings

Menus are used to set the shooting, printing and playback settings as well as such camera settings as the date/time and electronic beep. The following menus are available.

- **FUNC.** Menu
- Rec., Play, Print, Set up, and My Camera Menus

FUNC. Menu

This menu sets many of the common shooting functions.

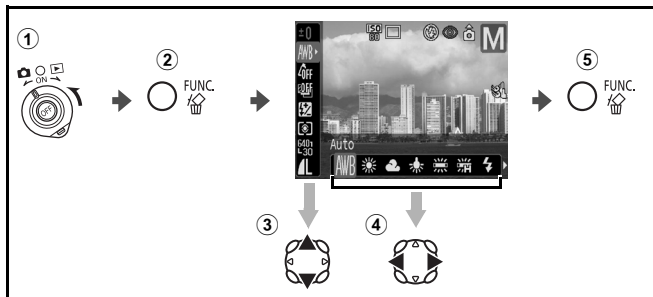

1 Set the camera to the shooting mode.

2 Press the **FUNC.** button.

3 Use the **▲** or **▼** button to select a menu item.

Some items may not be selectable in some shooting modes.

4 Use the **◀** or **▶** button to select an option for the menu item.

You can select further options with the **SET** button for some options.

After selecting an option, you can press the shutter button to shoot immediately. After shooting, this menu will appear again, allowing you to adjust the settings easily.

5 Press the **FUNC.** button.

Rec., Play, Print, Set up, and My Camera Menus



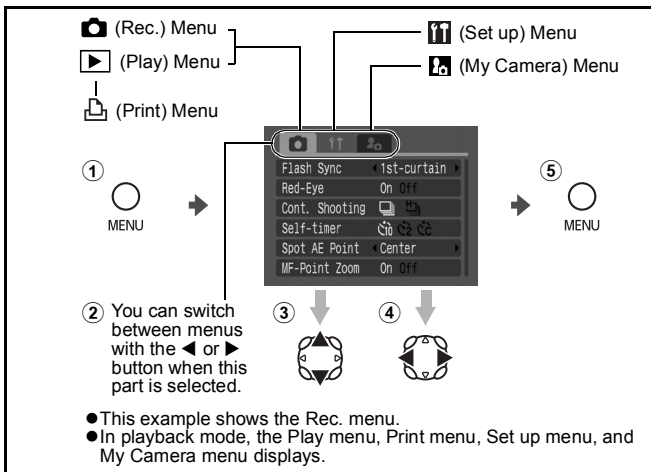





Convenient settings for shooting, playback or printing can be set with these menus.







- ① Press the **MENU** button.
- ② Use the ◀ or ▶ button to switch between menus.
You can also use the zoom lever to switch between menus.
- ③ Use the ▲ or ▼ button to select menu items.
Some items may not be selectable in some shooting modes.
- ④ Use the ◀ or ▶ button to select an option.
Menu items followed by an ellipsis (...) can only be set after pressing the **SET** button to display the next menu. Press the **SET** button again to confirm the setting.
- ⑤ Press the **MENU** button.

Menu List

FUNC. Menu

Menu Item	Reference Page
 Exposure Compensation	p. 75
 White Balance	p. 77
 My Colors	p. 80
 Bracket	pp. 68, 76
 Flash Exposure Compensation/Flash Output	p. 82
 Metering Mode	p. 73
 Movie Recording Pixels/Frame Rate	p. 48
 Recording Pixels (Still Image)	p. 36
 Compression (Still Image)	p. 36

Rec. Menu

Menu Item	Options	Reference Page
Flash Sync	1st-curtain ^{*1} /2nd-curtain	p. 83
Slow Synchro	Auto ^{*1} /Manual	p. 38
Flash Adjust	On ^{*1} /Off	p. 82
Red-eye	On ^{*1} /Off	<i>Basic</i> p. 12
Cont. Shooting	 (Standard Continuous Mode) ^{*1} /  (High-Speed Continuous Mode)	p. 42
Self-timer	 (10 sec.) ^{*1} /  (2 sec.)/  (Custom)	p. 43
Spot AE Point	Center ^{*1} /AF Point	p. 73
Safety Shift	On/Off ^{*1}	p. 60
MF-Point Zoom	On ^{*1} /Off	p. 66
AF Mode	Continuous ^{*1} /Single	p. 67
AF-assist Beam	On ^{*1} /Off	p. 12
Tally Lamp	On ^{*1} /Off	p. 46

Menu Item	Options		Reference Page
Digital Zoom	On/Off ^{*1} ([On] is the default setting for Movie mode)		p. 41
Review	Off / 2 ^{*1} to 10 sec. / Hold		Basic p. 7
Save Original	On/Off ^{*1}		p. 56
Reverse Disp.	On ^{*1} /Off		Basic p. 2
IS Mode	Off/Continuous ^{*1} /Shoot Only ^{*2} /Panning ^{*2}		p. 39
Converter	Off ^{*1} /WC-DC58A/TC-DC58B		p. 143
Intervalometer	Shooting interval: 1 ^{*1} to 60 min. Number of images: 2 ^{*1} to 100 shots		p. 84
Custom Display Settings	LCD/Viewfinder	LCD monitor 1, 2 Viewfinder 1, 2	p. 17
		On ^{*4} /Off	
	Shooting info.	On ^{*5} /Off ^{*6}	
	Grid Lines ^{*3}	On ^{*5} /Off ^{*6}	
	Histogram	On ^{*5} /Off ^{*6}	
Set Shortcut button	-		p. 61
Save Settings	-		p. 86

*1 Default setting

*2 Cannot be set in .









*3 Allows you to display a grid (9 sections) on the LCD monitor to help in determining the X- and Y-axis of the subject and composing the shot.
The grid lines will not be recorded in the image.

*4 Default setting for all display locations

*5 Default setting for LCD Monitor 2 and Viewfinder 2

*6 Default setting for LCD Monitor 1 and Viewfinder 1



Play Menu

Menu Item	Reference Page
 Transition	p. 99
 Slide Show	p. 105
 My Colors	p. 100
 Sound Recorder	p. 103
 Protect	p. 109
 Rotate	p. 98
 Erase all	p. 110
 Transfer Order	p. 114

Print Menu



Menu Item	Reference Page
Print	–
Select Images & Qty.	p. 111
Select All Images	p. 112
Clear All Selections	p. 113
Print Settings	p. 113

Set up Menu





Menu Item	Options	Summary/Reference Page
Mute	On/Off ^{*1}	Mutes all sounds except warnings when set to [On] (<i>Basic</i> p. 4).
Volume		Adjusts the volume of the start-up, operation, self-timer, shutter, and playback sounds. The volume cannot be adjusted if [Mute] is set to [On].
Start-up Vol.		Adjusts the volume of the start-up sound when the camera is turned on.
Operation Vol.		Adjusts the volume of the operation sound that plays when any button other than the shutter button is pressed during operation.
Selftimer Vol.		Adjusts the volume of the self-timer sound played 2 sec. before the shutter is released.
Shutter Volume		Adjusts the volume of the sound played when the shutter releases. The shutter sound does not play while a movie is recording.
Playback Vol.		Adjusts the volume of movie sounds, sound memos and sound recorder.
Audio		Sets microphone level, wind filter cut and sampling rate (p. 50).
LCD Brightness	 (Normal) ^{*1} /  (Bright)	Adjusts the brightness for the LCD monitor and viewfinder separately. (Display the location you wish to adjust the brightness for, and then configure the settings.)
Power Saving		p. 23
Auto Power Down	On ^{*1} /Off	Sets whether or not the camera automatically powers down after a set period of time elapses without the camera being operated.
Display Off	10 sec./20 sec./ 30 sec./1 min. ^{*1} / 2 min./3 min.	Sets the length of time before the LCD monitor (or viewfinder) turns off when no camera operation is performed.
Time Zone	Home ^{*1} /World	p. 24
Date/Time		<i>Basic</i> p. 4
Format		p. 35

Menu Item	Options	Summary/Reference Page
File Number	Continuous ^{*1} /Auto Reset	p. 90
Create Folder		p. 88
Create New Folder	Check mark (On)/ No check mark (Off)	Creates a folder for the next shooting session.
Auto Create	Off ^{*1} /Daily/ Mon.-Sun./Monthly	You can also set a creation time.
Auto Rotate	On ^{*1} /Off	p. 87
Distance Units	m/cm ^{*1} or ft/in	Sets the unit of measurement of the distance displayed for the MF indicator and the focus range.
Language		Basic p. 5
Video System	NTSC ^{*1} / PAL	p. 116
Print Method	Auto ^{*1} /  (PictBridge connection)	See below ^{*2}
Reset All		p. 34

*1 Default setting

*2 Allows you to switch the connection method of the printer. There is no need to change settings under normal circumstances, but when printing images taken in  (Wide) recording pixels on an entire side of wide size paper with the SELPHY CP710/CP510 Canon Compact Photo Printer, select . This setting is remembered even after turning the power off, so be sure to switch back to [Auto] when printing image sizes other than  (however, this method cannot be changed while connected to a printer).

My Camera Menu

Menu Item	Options	Reference Page
Theme	Selects a common theme for each My Camera settings item.	p. 117
Start-up Image	Sets the start-up image when you turn on the camera.	
Start-up Sound	Sets the start-up sound when you turn on the camera.	
Operation Sound	Sets the sound when any button other than the shutter button is pressed.	
Selftimer Sound	Sets the sound informing you that the photo will be taken in 2 seconds.	
Shutter Sound	Sets the sound played when the shutter button is pressed all the way down. The shutter sound does not play when a movie is recording.	
My Camera Menu Contents	 (Off) /  * /  / 	

* Default setting

Resetting Settings to Their Default Values

- 1**  (Set up) Menu → [Reset All].
See *Menus and Settings* (p. 27)

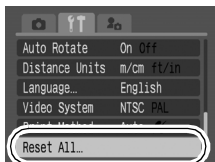

- 2** [OK] → **SET** button.



- Settings cannot be reset when the camera is connected to a computer or printer.
- The following settings cannot be reset to default:
 - [Date/Time], [Language], [Time Zone] and [Video System] options in the [ (Set up)] menu (p. 32)
 - Colors specified in the Color Accent (p. 53) or Color Swap (p. 54) modes of the SCN mode
 - C Mode Settings (p. 86)
 - White balance data set with the custom white balance function (p. 78)
 - Newly registered My Camera settings (p. 117)
- When the camera is in shooting mode and the mode dial is set to **C**, only the settings saved for **C** mode will return to default settings. This is the only way to return **C** mode settings to defaults.

Formatting Memory Cards

You should always format a new memory card or one from which you wish to erase all images and other data.

- Please note that formatting (initializing) a memory card erases all data, including protected images and other file types.
- When the  icon is displayed, audio only data exists. Exercise adequate caution before formatting the memory card.

1  (Set up) Menu → [Format].
See *Menus and Settings* (p. 27)

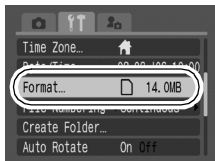

2 [OK] → **SET** button.

- To perform a low level format, use the ▲ or ▼ button to select [Low Level Format] and the ◀ or ▶ button to add a check mark.
- If [Low Level Format] is selected, you can cancel formatting partway by pressing the **SET** button. You can still use the memory card without problem even if formatting was halted partway, but the data is erased completely.

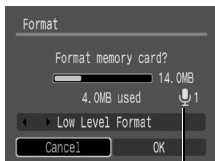

Displays when audio only data is present (p. 102)



Low Level Format

You should select the [Low Level Format] option if you suspect the read/write speed of a memory card has dropped. A low level format may require 2 to 3 minutes with some memory cards.

Approximate Values for Recording Pixels

Recording Pixels		Purpose
Display	Pixels	
L L (Large)	2816 × 2112 pixels	Large ↑ ↓ Small
M1 M1 (Medium 1)	2272 × 1704 pixels	
M2 M2 (Medium 2)	1600 × 1200 pixels	
S S (Small)	640 × 480 pixels	
W (Widescreen)	2816 × 1584 pixels	Print wide size prints (Images are recorded with 16:9 aspect ratios. Areas not recorded will not display as black bars on the LCD monitor.)

Approximate Values for Compression Settings

Compression		Purpose
S Superfine	High Quality ↑ ↓ Normal	
F Fine		
N Normal		



- See Image Data Sizes (Estimated) (p. 152)
- See Memory Cards and Estimated Capacities (p. 151)

Setting the Slow Synchro

Shooting Mode **P Av**

The flash timing is adjusted to slow shutter speeds. This reduces the chance that only the background will appear dark when a person is shot against a twilight background or night scene, or when an interior shot is taken.

- 1**  (Rec.) Menu →
[Slow Synchro] → [On]/[Off]*.
See *Menus and Settings* (p. 27)

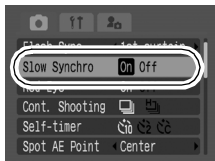

* Default setting.





- The fastest shutter speed for flash synchronization is 1/500 second. The camera automatically resets the shutter speed to 1/500 second if a faster speed is selected.
- When [Slow Synchro] set to [On], camera shake may become a factor even if [IS Mode] is set to [Continuous]. Use of a tripod is recommended.

Setting the Image Stabilizer Function

Shooting Mode **AUTO**       **P** Tv Av M

The image stabilizer function allows you to minimize the camera shake effect (blurred images) when you shoot distant subjects that have been magnified or when you shoot in dark conditions.

Types of Image Stabilization

Continuous	You can check the effect of the IS mode on image blur on the LCD monitor (or viewfinder) since the IS mode runs continually. This makes it easier to compose images and focus on subjects.
Shoot Only	IS mode is only activated when the shutter button is pressed, so subjects will be captured with reduced blur even if their movements the LCD monitor (or viewfinder) are not smooth. This option is not available in the  mode.
Panning	This option only stabilizes the effect of up and down camera motions on the image. This option is recommended for shooting objects moving horizontally. This option is not available in the  mode.







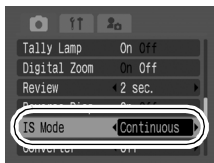

- 1**  (Rec.) Menu → [IS Mode] → [Continuous]*/[Shoot Only]/[Panning]/[Off].

See *Menus and Settings* (p. 27)

* Default setting.



The following icons appear on the LCD monitor (or viewfinder) if it is set to Information View display.

[Continuous]	[Shoot Only]	[Panning]		Reference Page
			With no lens converter	—
			With separately sold tele-converter mounted	p. 143
			With separately sold wide converter mounted	p. 143



- Camera shake may not be fully corrected when shooting with slow shutter speeds, such as with evening shots. Use of a tripod is recommended.
- If camera shake is too strong, it may not be fully corrected.
- Hold the camera horizontally while panning (stabilization does not work when the camera is held vertically).

Magnified Close-Up Shooting (Super Macro)

Shooting Mode SCN (A/S) P Tv Av M

This mode allows even closer shooting of the subject than standard Macro mode, magnifying the subject further. In addition, the background can be shot differently from the standard macro shooting effects.

Shooting is possible when the distance from the front of the lens to the subject is in the following range:

0 to 10 cm (0 to 3.9 in.) (maximum wide angle, zoom not available)

1 Hold down the button to display on the LCD monitor (or viewfinder).

- Pressing the  button again cancels the Super Macro mode (Macro mode is also canceled).
- The image area when the camera is as close as possible to the subject is 22×16 mm (0.87×0.63 in.) (maximum wide angle).



Zoomed 0 cm away from the flower

Using the Digital Zoom

Shooting Mode **AUTO** **P Tv Av M**

* Cannot be set in and modes.

You can combine digital zoom with optical zoom to magnify and shoot.

- Still Images: approx. 48x max.
- Movies: approx. 48x max.

The digital zoom cannot be used with **W** (Wide).

1 (Rec.) Menu → [Digital Zoom] → [On]/[Off]*.

See *Menus and Settings* (p. 27)

- [On] is the default setting for movie shooting.

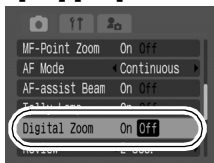

* Default setting.

2 Turn the zoom lever toward and shoot the image.

- When you press the button, the zoom stops when the lens reaches the maximum optical telephoto setting (when shooting still images). Press the button again to activate the digital zoom and digitally zoom the image further.
- Press the button to zoom out.

Optical zoom (White)

Digital zoom (Blue)



Approximately
2 seconds later



Combined optical and
digital zoom



Images become coarser the more they are digitally zoomed.

Continuous Shooting

Shooting Mode





* Cannot be set in  and  modes.

In this mode, the camera shoots continuously while the shutter button is held down.

In addition, continuous shooting is possible (p. 151) at a consistent interval (smooth continuous shooting) with a recommended memory card*¹ until the memory card is full.*²

- Even if continuous shooting suddenly stops, the memory card may not be full.



	Standard Continuous Mode Approx. 1.5 shots/second* ² * ³	Recommended when you want to confirm the subject during continuous shooting.
	High-Speed Continuous Shooting Approx. 2.3 shots/second* ² * ³	Recommended when you want the briefest shutter interval during continuous shooting.

*¹ A super high-speed SDC-512MSH memory card (sold separately) that has been low level formatted (p. 35) before shooting is recommended.

*² This reflects standard shooting criteria established by Canon. Actual results may vary according to the subject and shooting conditions.

*³ When using Large/Fine mode.

1 Press the to display .

-  is the default setting for  (however,  (High-Speed Continuous Shooting) cannot be set).

2 Shooting.

- The camera will continue to record successive images while the shutter button is held down.
Recording will cease when the shutter button is released.

To Cancel Continuous Shooting: Press the  button to display .



- The interval between shots may lengthen if the internal memory becomes full.
- If the flash fires, the interval between shots may lengthen.

Selecting a Continuous Shooting Method

Select either standard or high-speed continuous shooting.

- 1  (Rec.) Menu →
[Cont. Shooting] →  / .
See *Menus and Settings* (p. 27)

- Select a mode that supports continuous shooting.

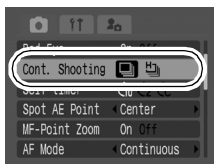







- 2 Press the **MENU** button.

 Continuous shooting is canceled when you turn the camera off, although the continuous shooting selection is retained.

Using the Self-Timer



Shooting Mode          

You can set the shutter to a 10 sec. () or 2 sec. delay (), or to a custom delay time and number of shots (: Custom Timer), for shooting after the shutter button is pressed.

- 1 Press the  to display , , or .

- 2 Shoot.



- When the shutter button is pressed fully, the self-timer lamp will blink (when using Red-Eye Reduction, it will light before 2 sec.).

To Cancel the Self-Timer: Press the  button to display .

 You can change the self-timer sound (pp. 33, 117).



Changing the Self-Timer Countdown Time



1  (Rec.) Menu → [Self-timer] → *1/.

See *Menus and Settings* (p. 27)

● The following occurs.

- : 2 sec. before the shutter releases, the self-timer sound and lamp will speed up*2.
- : The self-timer sound will play when the shutter button is pressed and the shutter will release 2 sec. later.

*1 Default setting.

*2 May differ depending on My Camera settings.

Changing the Delay Time and Number of Shots (📷)

You can change the delay time (0-10, 15, 20, 30 sec.) and number of shots (1-10). However, the settings cannot be made for the **A** (Color Accent), **S** (Color Swap), **Stitch Assist** or **Movie** in the SCN mode.

1 **📷 (Rec.) Menu** → **[Self-timer]**



See *Menus and Settings* (p. 27)

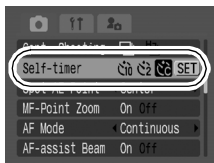

2 **Select [Delay]* or [Shots]*** → **SET** button.

- The self-timer sound will behave as follows.
 - If 2 or more seconds have been specified, the self-timer sound will speed up 2 seconds before shooting.
 - If multiple shots have been specified for the [Shots] option, the sound will play for the first shot only.
- * Default settings are 10 sec., 3 shots

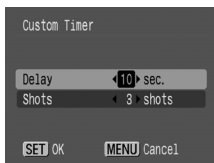

If the [Shots] option is set to 2 or more shots, the following occurs.

- The exposure and white balance are fixed at the settings selected for the first shot.
- If the flash fires, the interval between shots may lengthen.
- The interval between shots may lengthen if the internal memory becomes full.
- Shooting will automatically cease if the memory card becomes full.

Using the Mode Dial

Movie Shooting

Shooting Mode

AUTO     P Tv Av M

No matter what position the mode dial is in, you can shoot movies*¹ with just a push of the Movie button.

You can select the movie recording pixels and frame rate (p. 48) and shoot with color effects such as Color Accent, Color Swap, and My Colors.

- Max. Clip Size: 1 GB*²

*¹ You can record until the memory card is full (when a super high-speed memory card is used, such as the recommended SDC-512MSH).

*² Even if the clip size has not reached 1 GB, recording will stop at the moment the clip length reaches 1 hour. Depending on the storage capacity of the memory card and the speed at which the data is written, recording will stop before reaching 1 GB or 1 hour.

1 Press the Movie button to shoot.

- Shooting starts when the Movie button is pressed.
- Recording will include sound.
- During shooting, the recording time (in seconds) and "● Rec." appear on the LCD monitor (or viewfinder).
- The tally lamp blinks red during movie recording and turns off when the recording session is over. When [Tally Lamp] is set to [Off] in the Rec. menu, the lamp does not blink (p. 28).
- Pressing the Movie button again stops recording. Recording will stop automatically under the following circumstances.
 - When the maximum recording time elapses
 - When the internal memory and the memory card becomes full
- When shooting with the Color Accent or the Color Swap, be sure to specify them in SCN mode beforehand (p. 53).
- Even if you shoot movies with the recording pixels for still images set to **[W]**, the aspect ratio of the recorded movie will be the usual 4:3 screen.





- You are recommended to use a memory card that has been formatted in your camera to shoot movies (p. 35). The card supplied with the camera may be used without further formatting.
- Be careful of the following while recording.
 - Try not to touch the microphone.
 - If you press any buttons other than the Movie button, the sound that the buttons make when pressed will be recorded in the movie.
 - The camera will automatically adjust the exposure and white balance to suit the shooting conditions during a recording. Please note, however, that the sounds made by the camera while automatically adjusting the exposure may also be recorded.
- Images of $\frac{320}{60}$ recorded with this camera may not play back properly on other cameras.



- When you press the MF button, AF lock is set at the current focus condition. MF displays on the LCD (or viewfinder). Press the MF button again to release the setting. When AF lock has been registered to the shortcut button, AF can be readjusted and locked while shooting movies by pressing the $\frac{AF}{S}$ button (AF appears on the screen).
- You can set the AE lock (p. 70) and exposure shift while shooting movies (you can also set them before shooting when the mode dial is set to $\frac{P}{A}$).
 1. Press the **ISO** button
The exposure will lock (AE lock) and the exposure shift bar will appear in the LCD monitor (or viewfinder).
 2. Use the ◀ or ▶ button to adjust the exposure.
Press the **ISO** button again to release the setting. Also, the setting will be canceled if you press the **MENU** button or change the white balance, My Colors, or shooting mode settings.
When AE lock has been registered to the shortcut button, AE can be readjusted and locked while shooting movies by pressing the $\frac{AF}{S}$ button (AF appears on the screen). You cannot perform this operation, however, when the exposure shift bar is displayed on the screen.



- When movie recording is stopped in any mode dial position except , the still image settings return to the settings before movie shooting began. AE lock (p. 70) and exposure shift, however, are disabled.
- QuickTime 3.0 or later is required to play back movies (Data type: AVI/Compression method: Motion JPEG) on a computer. QuickTime (for Windows) is included on the Canon Digital Camera Solution Disk. On the Macintosh platform, this program is standard with Mac OS X or later.

Changing Movie Recording Pixels and Frame Rates

You can change the movie recording pixels and frame rate in any shooting mode.

1 FUNC. button → * / / / /

(Recording Pixels/Frame Rate).

See *Menus and Settings* (p. 26)

- Use the ◀ or ▶ button to select the recording pixels/frame rate and press the **FUNC.** button.





* Default setting.



Remaining Time (Sec.)

Movie Recording Pixels/Frame Rates

Frame rates indicate the number of frames recorded or played back each second. The higher the frame rate, the smoother the appearance of motion.

	Recording Pixels	Frame Rate
	640 × 480 pixels	30 frames/sec.
	640 × 480 pixels	15 frames/sec.
	320 × 240 pixels	60 frames/sec.
	320 × 240 pixels	30 frames/sec.
	320 × 240 pixels	15 frames/sec.



- See Image Data Sizes (Estimated) (p. 152)
- See Memory Cards and Estimated Capacities (p. 151)

Shooting Still Images while Shooting a Movie

Shooting Mode          

You can shoot a high quality still image* while shooting a movie.

* The recording pixels and compression are the same as those set for still images (excluding ).





1 While shooting a movie, press the shutter button halfway to focus.

Press the shutter halfway so the camera can focus and set exposure for the still image. During this process, movie shooting continues.

2 Press the shutter button all the way to shoot the image.

- The movie goes black for an instant while the still image is shot, and then returns to normal. However, sound recording continues uninterrupted.
- The shutter sound is also recorded (and cannot be disabled).



- The flash will not fire.
- The recording pixels of still images taken while shooting movies are fixed at  (Large) regardless of being set to .
- Continuous shooting of still images is not available.
- Movie shooting may stop when shooting a still image if there is insufficient internal memory available.
- The following icons appear if the recording speed of the storage media is too slow or if there is insufficient internal memory available, in which case a still image cannot be shot.
 -  : While this is blinking, writing is in progress. Shooting is again possible when it stops blinking and stays lit.
 -  : Internal memory is full, so shooting is disabled.

Changing the Sound Mode

Shooting Mode **AUTO**     SCN   **P** Tv Av M

Microphone level (sound recording level), wind filter and sampling rate can be changed.

- 1**  (Set up) menu → [Audio].
See *Menus and Settings* (p. 27)



- 2** [Mic Level] → set the sound recording level with the ◀ or ▶ button.

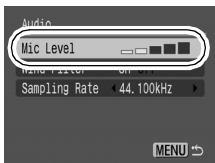

- 3** [Wind Filter] → [On]*/[Off].
 - This suppresses noise when the wind is strong.
 - When set to On,  displays in the LCD monitor (or viewfinder).
- * Default setting.



4 [Sampling Rate] → [44.100 kHz]/[11.025 kHz]/[22.050 kHz].

- The sound quality increases in the order of the following settings, but the required memory also increases.

11.025 kHz, 22.050 kHz, and 44.100 kHz

* Default setting.

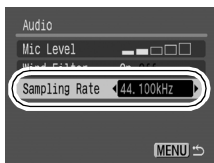

- Even if the recording volume becomes too loud, it automatically adjusts to avoid distortion of loud sounds.
- Wind filter suppresses noise that occurs in locations with strong wind. However, unnatural sound can result when used to record in locations with no wind.

Shooting Panoramic Images (Stitch Assist)

Shooting Mode 

Stitch Assist can be used to shoot overlapping images that can later be merged (stitched) to create one panoramic image on a computer.



The overlapping seams of several adjacent images can be joined into a single panoramic image.



1 Use the ◀ or ▶ button to select the shooting sequence.

- You can select from the following 5 shooting directions.
 - Left to right horizontally
 - Right to left horizontally
 - Vertically, bottom to top
 - Vertically, top to bottom
 - Clockwise starting at the top left



2 Shoot the first frame the sequence.

- The exposure and white balance are set and locked with the first image.

3 Compose the second image so that it overlaps a portion of the first and shoot.

- Use the ▲, ▼, ◀ or ▶ button to return the previous image or retake the recorded images.
- Minor discrepancies in the overlapping portions can be corrected when the images are stitched together.



4 Repeat the procedure for additional images.

- A sequence may contain up to 26 images.
- Press the **SET** button after the last shot.



- You cannot display the images on a TV while shooting in Stitch Assist mode.
- The settings for the first image are applied to the second image onward.





Use PhotoStitch, a supplied program, to merge the images on a computer.

SCN Changing the Colors and Shooting

Shooting Mode SCN (A/S)

You can easily change the colors in an image when it is shot for both stills and movies, allowing you to enjoy producing various effects. Depending on the shooting conditions, however, the images may appear rough, or you may not get the expected color. Before photographing important subjects, we recommend taking trial shots and checking the results. By setting the [Save Original] function (p. 56) to [On] when shooting stills, you can also record both the altered image and the original, unaltered image.

	Color Accent	Shoot with all colors, with the exception of the color specified in the LCD monitor, in black and white.
	Color Swap	Specify a color in the LCD monitor, and shoot with another color replacing the one specified. The specified color can only be swapped with one other color.

 Depending on scene being shot, the ISO speed may increase, increasing the amount of noise in the image.

Shooting with Color Accent Mode

1 Use the ◀ or ▶ button to select  (Color Accent) → SET button.

- The camera will switch to color input mode, and the display will alternate between the original image and the Color Accent image (using the previously set color).



2 Aim the camera so that the color you wish to retain appears at the center of the LCD monitor (or viewfinder) and press the ◀ button.

- Only one color can be specified.
- You can use the ▲ or ▼ button to specify the range of the colors that are retained.
 - 5: Only takes the color that you want to retain.
 - +5: Also takes colors close to the one that you want to retain.

3 Complete the setting with the **SET** button, and shoot.

- This completes the setting.
- When you press the Movie button, you can shoot movies in Color Accent mode.



- The default Color Accent is green.
- You may not obtain the expected results after color input mode if you use the flash.
- The specified Color Accent is retained even if the camera's power is turned off.

Shooting with Color Swap Mode

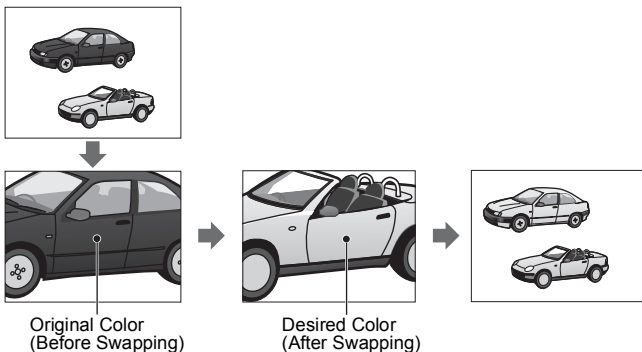

1 Use the ◀ or ▶ button to select (Color Swap) ▶ **SET** button.

- The camera will switch to color input mode, and the display will alternate between the original image and the color swap image (using the previously set color).



2 Aim the camera so that the color you wish to change appears at the center of the LCD monitor (or viewfinder) and press the ◀ button.

- Only one color can be specified.
- You can use the ▲ or ▼ button to specify the range of the colors that are retained.
 - 5: Only takes the color that you want to change.
 - +5: Also takes colors close to the one that you want to change.

3 Aim the camera so that the desired color appears at the center of the LCD monitor (or viewfinder) and press the ▶ button.

- Only one color can be specified.

4 Complete the setting with the SET button, and shoot.

- This completes the setting.
- When you press the Movie button, you can shoot movies in Color Swap mode.



- The default setting for Color Swap changes green into white.
- You may not obtain the expected results after color input mode if you use the flash.
- The colors specified in the Color Swap mode are retained even if the camera's power is turned off.

Saving Original Images

Not only can you save images with altered colors when shooting still images with the Color Accent or Color Swap modes, but you can also choose to save the original images (before the color change).

1 (Rec.) menu → [Save Original] → [On]/[Off]*.

See *Menus and Settings* (p. 27)

- If [On] is selected, the images will be saved as consecutive file numbers. The original image will be the lower file number, while the image shot in Color Accent or Color Swap mode will be the higher file number.

* Default setting.



If [Save Original] is set to [On]



- Only the image set with Color Accent or Color Swap is displayed on the LCD monitor (or viewfinder) during shooting.
- The image displayed on the LCD monitor (or viewfinder) immediately after shooting is the one shot with Color Accent or Color Swap (pp. 53, 54). As erasing the image at this time will cause the original image to be erased at the same time, be careful.
- As two images are saved with each shot, the number of recordable shots displayed on the LCD monitor (or viewfinder) will be half the number that is displayed when [Save Original] is set to [Off].

Shooting in the Creative Zone

Shooting Mode **P Tv Av M**

You can freely select camera settings such as the shutter speed and aperture value to suit your shooting purposes. After settings are made, shooting procedures are the same as for **AUTO** Auto Mode (*Basic Guide* p. 6).



- For information on the relation between the aperture value and shutter speed see [p. 58](#).
- Please note that camera shake becomes a factor at low shutter speeds and with larger aperture values. If  (camera shake warning) appears in the LCD monitor (or viewfinder), try the following steps to resolve the problem.
 - Use the  (image stabilizer) function.
 - Raise the ISO speed.
 - Raise the flash to enable firing.
 - Use a tripod.

P Program AE

Shooting Mode **P**

Use the program AE mode to have the camera automatically set the shutter speed and aperture value to match the brightness of the scene.

- When a correct exposure cannot be obtained, the shutter speed and aperture values are shown in red on the LCD monitor when the button is pressed halfway. Use the following shooting methods obtain the correct exposure and make them show in white.
 - Use the flash (raise the flash).
 - Adjust the ISO Speed.
 - Change the metering mode.



You can change the combinations of shutter speeds and aperture values without altering the exposure ([p. 70](#)).

Tv Setting the Shutter Speed

Shooting Mode **Tv**

When you set the shutter speed in the shutter speed-priority AE mode, the camera automatically selects an aperture value to match the brightness. Faster shutter speeds allow you to catch an instantaneous image of a moving subject, while slower speeds create a flowing effect and allow you to shoot without a flash in dark areas.

1 Use the ◀ or ▶ button to select the shutter speed, then shoot.



- If the aperture value is shown in red, the image is underexposed (insufficient light) or overexposed (too much light). Use the ◀ or ▶ button to adjust the shutter speed until the aperture value shows in white.
- The nature of CCD image sensors is such that noise in the recorded image increases at slow shutter speeds. This camera, however, applies special processing to images shot at shutter speeds slower than 1.3 seconds to eliminate the noise, thereby producing high-quality images (Nevertheless, a certain amount of processing time may be required before the next image can be shot).



- The aperture value and shutter speed change according to the zoom state as follows.

	Aperture value	Shutter Speed (seconds)
Maximum Wide Angle *1	F 2.7 – 3.5	to 1/1600
	F 4.0 – 5.0	to 1/2000
	F 5.6 – 7.1	to 1/2500
	F 8.0	to 1/3200
Maximum Telephoto *2	F 3.5 – 4.5	to 1/1600
	F 5.0 – 6.3	to 1/2000
	F 7.1 – 8.0	to 1/2500

*1 Maximum wide angle setting

*2 Maximum telephoto setting

- The fastest shutter speed for flash synchronization is 1/500 second. The camera automatically resets the shutter speed to 1/500 second if a faster speed is selected.

Shutter Speed Display

- The numbers in the table below indicate the shutter speed in seconds. 1/160 indicates 1/160 second. Also, quote marks indicate the decimal place, so that 0"3 indicates 0.3 second and 2" indicates 2 seconds.

15"	13"	10"	8"	6"	5"	4"	3"2	2"5	2"	1"6	1"3	1"	0"8	0"6
0"5	0"4	0"3	1/4	1/5	1/6	1/8	1/10	1/13	1/15	1/20	1/25			
1/30	1/40	1/50	1/60	1/80	1/100	1/125	1/160	1/200	1/250					
1/320	1/400	1/500	1/640	1/800	1/1000	1/1250	1/1600							
1/2000	1/2500	1/3200												

- You can change the combinations of shutter speeds and aperture values without altering the exposure (p. 70).

Av Setting the Aperture

Shooting Mode **Av**

The aperture adjusts the amount of light entering through the lens. When you set the aperture in the aperture-priority AE mode, the camera automatically selects a shutter speed to match the brightness. Selecting a lower aperture value (opening the aperture) allows you to blur the background and create a beautiful portrait. A higher aperture value (closing it) brings the entire range from foreground to background into focus. The larger the aperture value, the greater the range of the image brought into clear focus.

1 Use the ◀ or ▶ button to select the aperture value, then shoot.



- If the shutter speed is shown in red, the image is underexposed (insufficient light) or overexposed (too much light). Adjust the aperture value using the ◀ or ▶ button until the shutter speed display turns to white.
- Some aperture values cannot be selected depending on the zoom position.



In this mode, the maximum shutter speed with synchronized flash is 1/500 second. The aperture value setting may therefore be changed automatically to match the synchronized flash speed even if its value was set previously.

Aperture Setting Display

- The larger the aperture value the smaller the lens opening, allowing less light to enter the camera.

F2.7 F3.2 F3.5 F4.0 F4.5 F5.0 F5.6 F6.3 F7.1 F8.0

- You can change the combinations of shutter speeds and aperture values without altering the exposure (p. 70).

Safety Shift

With **Tv** and **Av** modes, if [Safety Shift] is turned [On] in the Rec. menu, the shutter speed or aperture value is automatically adjusted for the correct exposure when it cannot be otherwise obtained.

- Safety Shift is disabled when the flash is enabled.

M Manually Setting the Shutter Speed and Aperture

Shooting Mode **M**

You can manually set the shutter speed and aperture to shoot images.

- 1** Use the ◀ or ▶ button to select the shutter speed, and use the ▲ or ▼ button to select the aperture value, then shoot.

- When you press the shutter button halfway, the difference between the standard exposure* and the selected exposure appears on the LCD monitor (or viewfinder). If the difference is more than 2 stops, "-2" or "+2" appears on the LCD monitor (or viewfinder) in red.

* The standard exposure is calculated by measuring the brightness according to the selected metering method.



- If the zoom is adjusted after these values are set, the aperture value or the shutter speed may change in accordance with the zoom position.
- The brightness of the LCD monitor (or viewfinder) matches the selected shutter speed and aperture value. When you select a fast shutter speed or shoot a subject in a dark place, raise the flash, and then set it to (Flash On with red-eye reduction) or (Flash On), the image will always be bright.

Advanced Shooting Functions

Registering Settings to the Shortcut Button

Shooting Mode      SCN   P Tv Av M

One frequently used function can be registered to the  (Shortcut) button.

You can register the following functions. However, not all functions can be registered depending on the shooting mode.

- Recording Pixels (Still image)^{*1} (p. 36)
- Metering System (p. 73)
- My Colors^{*3} (p. 80)
- AE Lock (p. 70)
- Display Off (p. 23)
- Movie Recording Pixels/Frame Rate (Movie) (p. 48)
- White Balance^{*2} (p. 77)
- Image Stabilizer Function (p. 39)
- AF Lock (p. 65)
- Create New Folder (p. 88)

*1 Default setting.

*2 A custom white balance can be used once a custom white balance reading has been taken.

*3 A custom photo effect can be used once a custom effect has been set.

Registering a Function

1 (Rec.) Menu → [Set Shortcut button].

See *Menus and Settings* (p. 27)

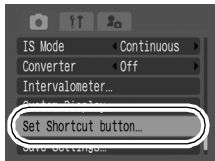

2 Use the ▲, ▼, ◀ or ▶ button to select the function you wish to register → SET button.

- If an "x" mark appears on the lower right of the icon, you can still register this function but the current shooting mode will be retained and pressing the shortcut button will not activate the function.



Using the Shortcut Button

1 Press the button.

- The registered function is activated and its icon appears on the LCD monitor or viewfinder (except in the Display Off setting).
- Each press of the  button cycles between setting values of the registered function.
- Functions that are not available in the current shooting mode will not appear even if they are registered.



Selecting an AF Frame



Shooting Mode **P Tv Av M**

The AF frame indicates the area of the composition on which the camera focuses and can be set manually to the desired area. This is convenient for focusing accurately on your chosen subject to obtain the composition you desire.

1 Press the button.

- The AF frame appears in green.

2 Use the **▲**, **▼**, **◀** or **▶** button to move the AF frame to the desired area, then press the button.

- You can immediately shoot the image using the selected AF frame by pressing the shutter button instead of pressing the  button.
- The AF frame will move back to its original position (Center) if you hold down the  button.



- The focus is locked to the center AF frame when the digital zoom is used.
- The AF frame appears as follows when the shutter button is pressed halfway.
 - Green: Shooting preparations complete
 - Yellow: Focusing difficulty
- When the Spot AE Point is selected as the light metering mode, you can use the selected Spot AE Point as the AF frame ([p. 73](#)).
- The position of the AF frame returns to the center once the power is turned off.

Shooting Hard-to-Focus Subjects (Focus Lock, AF Lock, Manual Focus)

Shooting Mode      SCN*   P Tv Av M

*The  shooting mode cannot be used.

It may be difficult to focus on the following types of subjects.

- Subjects with extremely low contrast to the surroundings
- Scenes with a mixture of near and far subjects
- Subjects with extremely bright objects at the center of the composition
- Subjects that are moving quickly
- Subjects through glass: Try to shoot as close to the glass as possible to reduce the chances of light reflecting back off the glass.

Shooting with the Focus Lock

1 Aim the camera so that an object at the same focal distance as the main subject is centered in the viewfinder or in the AF frame displayed on the LCD monitor (or viewfinder).

2 Press the shutter button halfway.

3 Re-aim the camera to compose the shot as desired and press the shutter button fully.

Shooting with the AF Lock

* **AUTO** and  mode cannot be set.

1 Aim the camera so that an object at the same focal distance as the main subject is centered in the AF frame.



2 Press the shutter button halfway and press the **MF** button.

- **MF** and the MF indicator will appear on the LCD monitor (or viewfinder).

3 Re-aim the camera to compose the shot as desired and shoot.

To Release the AF Lock: Press the MF button.





- The AF lock is convenient because you can let go of the shutter button to compose the image. Moreover, the AF lock is still effective after the picture is taken, allowing you to capture a second image with the same focus.
- Because  (Stitch Assist) does not display the AF frame, aim the camera to focus on the subject.
- When you register  to the shortcut button (p. 61), the focus is adjusted and locked with a press of the shortcut button, and you can immediately begin shooting by pressing the shutter or Movie button ( appears on the LCD (or viewfinder) when using AF lock).



Shooting in Manual Focus Mode

The focus can be manually set.

* **AUTO** and  mode cannot be set.

1 Use the or button to adjust the focus while holding down the **MF** button.

-  and the MF indicator are displayed.
- When the  (Rec.) menu's [MF-Point Zoom] is set to [On] (p. 28), the portion of the image in the AF frame will appear magnified*.

* However, when using  (Stitch Assist),  (Movie), digital zoom or while displaying the image on a TV, the display magnification is not available.

* Can also be set so that the image displayed is not magnified (p. 28).

- The MF indicator shows approximate figures. Use them as a shooting guideline only.
- After setting the focus, pressing the **SET** button causes the camera to automatically refocus more precisely at a point near the current focusing point.



MF Indicator

To Cancel the Manual Focus: Press the **MF** button.



You can change distance units displayed on the MF indicator (p. 32).

Switching between Focus Settings

Shooting Mode **AUTO**    SCN  **P** Tv Av M

*In  mode only [Single] is available.

You can switch between focus settings to shoot.

Continuous	The camera is continually focusing on whatever it is aimed even when the shutter button is not pressed, allowing you to shoot without missing opportunities. This is the default setting.
Single	The camera only focuses when the shutter button is pressed halfway, conserving battery power.

1  (Rec.) Menu → [AF Mode] →
[Continuous]*/[Single].
See *Menus and Settings* (p. 27)

* Default setting.

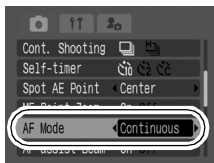

Focus Bracketing (Focus-BKT Mode)

Shooting Mode **P Tv Av M**

The camera automatically takes three shots: one at the manual focus position, and one each with focus positions preset nearer and farther.

The nearer and farther focus positions can be set in three steps: large, medium and small.

 The three shots are taken at the same interval as high-speed continuous shooting, and the images are shot with the focus position changing in the following order; current position, farther and nearer.

Continuous Shooting (p. 42)

1 FUNC. Menu → * (BKT-OFF)
→  (Focus-BKT) → **SET**
button.

See *Menus and Settings* (p. 26)

* Default setting.



2 Set the amount of focus position offset with the ◀ or ▶ button.

- Press the ▶ button to broaden or the ◀ button to narrow the focusing distance from the center.



3 Press the **FUNC.** button and shoot the image with the manual focus (p. 66).

-  The Focus-BKT mode is not available when shooting with the flash on. Only one image at the manual focus position will be taken.
- Three images are shot continuously regardless of the continuous shooting setting (p. 42).

ISO Adjusting the ISO Speed

Shooting Mode **AUTO P Tv Av M**

Raise the ISO speed when you wish to reduce the effects of shaking hands and shoot with the flash off in a dark area or when you wish to reduce the effects of a moving subject and raise the shutter speed.

1 Press the ISO button to switch settings.

- Cycle through the **ISO_{HI}** (High ISO Auto) → **ISO₈₀** → **ISO₁₀₀** → **ISO₂₀₀** → **ISO₄₀₀** → **ISO₈₀₀** → **ISO_{AUTO}** (does not display) with each press of the button.
- When Auto is selected, the optimal speed is selected based on the brightness of the environment at the time of shooting. The speed is automatically increased in dark places, increasing the shutter speed and reducing shaking effects.
- When **ISO_{HI}** is selected, a speed higher than when using Auto is selected. The shutter speed increases even more, and blurriness from hand or subject movement in a scene is less than when taken in Auto. There may be an increase in noise, however, when compared to Auto.

ISO Speed Settings

	AUTO	P	Tv	Av	M
Auto	○*	○*	○*	○*	-
High ISO Auto	○	○	-	-	-
ISO80	-	○	○	○	○*
ISO100	-	○	○	○	○
ISO200	-	○	○	○	○
ISO400	-	○	○	○	○
ISO800	-	○	○	○	○

○: Available * : Default setting

Locking the Exposure Setting (AE Lock)

Shooting Mode 

You can set the exposure and focus separately. This is effective when the contrast is too strong between the subject and background or when a subject is backlit.







You must set the flash to . The AE lock cannot be set if the flash fires.

1 Focus on the part of the subject on which you wish to lock the exposure setting.

2 Press the shutter button halfway and press the **ISO** button.

- The  will display.

3 Re-aim the camera to compose the shot as desired and press the shutter button fully.

To Release the AE Lock: Press anything except the , ,  or  button.



- AE lock can also be set and released in  mode (p. 46).
- You can use the FE lock when using the flash.

Changing shutter speed and aperture value combinations



Automatically selected combinations of shutter speeds and aperture values can be freely changed without altering the exposure (Program Shift).





- 1** Turn the mode dial to **P**, **Tv**, or **Av**.
- 2** Focus on the subject on which you wish to lock the exposure.
- 3** Press the **ISO** button while pressing the shutter button halfway.
 - The exposure setting locks and ***** appears on the LCD monitor (or viewfinder).
- 4** Press the **◀** or **▶** button until the desired shutter speed or aperture value is reached.
- 5** Recompose the image and shoot.
 - The setting will cancel after the shot is taken.

Shooting with FE Lock

Shooting Mode **P Tv Av**

You can obtain the correct exposure regardless of the location of your subject in the composition.



- 1** Raise the flash.
- 2** Press the  button and set it to  (flash on).
- 3** Focus on the part of the subject on which you wish to lock the flash exposure setting.
- 4** Press the shutter button halfway and press the **ISO** button.
 - The flash will pre-fire and  will display.
- 5** Re-aim the camera to compose the shot as desired and press the shutter button fully.



To Release the FE Lock: Press anything except the , ,  or  button.

Switching between Metering Modes

Shooting Mode **P Tv Av M**

Metering Methods

	Evaluative	The camera divides images into several zones for light metering. The camera evaluates complex lighting conditions, such as the position of the subject, the brightness, the background, the direct light, and the backlighting, and adjusts the settings to the correct exposure for the main subject.
	Center-Weighted Average	Averages the light metered from the entire frame, but gives greater weight to the subject matter at the center.
	Spot AE Point	Meters the area within the spot AE point frame.
	Center	Locks the spot metering frame to the center of the LCD monitor (or viewfinder).
	AF Point	Moves the spot AE point to the AF frame.

1 FUNC. Menu → * (Evaluative)  (Center-Weighted Average)  (Spot AE Point).

See *Menus and Settings* (p. 26)

* Default setting.

- Use the ◀ or ▶ button to adjust the exposure compensation and press the **FUNC.** button.

Moving the Spot AE Point to the AF Frame/ Centering the Spot AE Point

- 1**  (Rec.) Menu → [Spot AE Point] → [Center]* or [AF Point].

See *Menus and Settings* (p. 26)

- When [Spot AE Point] is set to [Center], the spot AE point frame  appears at the center of the LCD monitor (or viewfinder). The AF frame can be repositioned (p. 63).
- With [AF Point], one AE point appears within the AF frame. This frame can be moved as one piece.

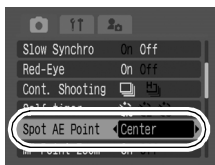

 Spot AE Point
 AF Frame

* Default setting.

Adjusting the Exposure Compensation

Shooting Mode     SCN*  P Tv Av

*Cannot be set in  and  modes.

Adjust the exposure compensation setting to avoid making a subject too dark when it is backlit or shot against a bright background, or to avoid making lights appear too bright in night shots.

1 FUNC. Menu → * (Exposure Compensation).

See *Menus and Settings* (p. 26)

- Use the ◀ or ▶ button to adjust the exposure compensation and press the **FUNC.** button.

* Default setting.



To Cancel the Exposure Compensation: Restore the compensation value to [0].



In  mode, the exposure shift can be set/canceled (p. 46).

Auto Exposure Bracketing (AEB Mode)

Shooting Mode **P Tv Av**

The camera automatically takes three shots: one with standard exposure and one each with positive and negative compensation.



- The three shots are taken at the same interval as high-speed continuous shooting in the following order: standard exposure, underexposure and overexposure. Continuous Shooting (p. 42)
- AEB settings can be combined with exposure compensation settings (p. 75) to extend the adjustment range.

1 FUNC. Menu → * (BKT-OFF)

→  (AEB).

See Menus and Settings (p. 26)

* Default setting.



2 Press the **SET** button and adjust the compensation range with the ◀ or ▶ button.

- The compensation range can be adjusted in 1/3 increments from -2 to +2 with the exposure at the time of shooting at the center.



To Cancel the AEB Mode: Select the  (BKT-OFF).



- The AEB mode cannot be used for flash photography. If the flash fires, only one standard exposure image gets recorded.
- Three images are shot continuously regardless of the continuous shooting setting (p. 42).

Adjusting the Tone (White Balance)

Shooting Mode



Normally, the (Auto) white balance setting selects an optimal white balance. When the (Auto) setting cannot produce natural looking colors, change the white balance using a setting appropriate to the light source.

White Balance Settings

	Auto	Settings are automatically set by the camera
	Day Light	For recording outdoors on a bright day
	Cloudy	For recording under overcast, shady or twilight skies
	Tungsten	For recording under tungsten and bulb-type 3-wavelength fluorescent lighting
	Fluorescent	For recording under warm-white, cool-white or warmwhite (3-wavelength) fluorescent lighting
	Fluorescent H	For recording under daylight fluorescent, or daylight fluorescent-type 3-wavelength lighting
	Flash	When using the flash (cannot be set in (Sports) or (Movie) mode)
	Custom	For recording with the optimal white balance data memorized in the camera from a white-colored object, such as white paper or cloth

1 FUNC. Menu → * (Auto).

See *Menus and Settings* (p. 26)

- Use the ◀ or ▶ button to select a white balance setting and press the **FUNC.** button.

* Default setting.



This setting cannot be adjusted when the (Sepia) or (B/W) photo effects are selected (p. 80).

Using the Custom White Balance

You can set a custom white balance to obtain the optimal setting for the shooting conditions by having the camera evaluate an object, such as a piece of white paper or cloth that you wish to establish as the standard white color.

In particular, take a custom white balance reading for the following situations that are difficult for the  (Auto) setting to detect correctly.

- Shooting close-ups
- Shooting subjects of monotone color (such as sky, sea or forest)
- Shooting with a peculiar source of light (such as a mercury-vapor lamp)

1 FUNC. Menu → * (Auto) → 
(Custom).

See *Menus and Settings* (p. 26)



* Default setting.

2 Aim the camera at a piece of white paper or cloth and press the **SET** button.

- Aim the camera so that the white reference paper or cloth completely fills the center of the frame.















- You are recommended to set the shooting mode to **P** and the exposure compensation setting to zero (± 0) before setting a custom white balance. The correct white balance may not be obtained when the exposure setting is incorrect (image appears completely black or white).
- Shoot with the same settings as when reading the white balance data. If the settings differ, the optimal white balance may not be set. In particular, the following should not be changed.
 - ISO Speed
 - Flash: Setting the flash to on or off is recommended. If the flash fires when reading the white balance data with the flash set to Auto or Auto with Red- Eye Reduction, make sure that you also use the flash when you shoot.
- Since the white balance data cannot be read in Stitch Assist mode, preset the white balance in another shooting mode beforehand.
- The camera will retain the custom white balance setting that you record even if you reset the camera to the default settings (p. 34).

Shooting in a My Colors Mode

Shooting Mode   **P** Tv Av M

You can alter the overall impression of an image and shoot.

My Colors Settings

	My Colors Off	Records normally.
	Vivid	Emphasizes the contrast and color saturation to record bold colors.
	Neutral	Tones down the contrast and color saturation to record neutral hues.
	Sepia	Records in sepia tones.
	B/W	Records in black and white.
	Positive Film	Produces intense natural-appearing colors like those obtained with positive film.
	Lighter Skin Tone*	Makes skin tones lighter.
	Darker Skin Tone*	Makes skin tones darker.
	Vivid Blue	Emphasize blue tints. Use to make blue subjects, such as the sky or ocean, more vivid.
	Vivid Green	Emphasize green tints. Use to make green subjects, such as mountains, new growth, flowers and lawns, more vivid.
	Vivid Red	Emphasize red tints. Use to make red subjects, such as flowers or cars, more vivid.
	Custom Color	Customize contrast, sharpness, and saturation, and red, green, blue, and skin tone* balance. Use to make subtle adjustments, such as making blue colors more vivid and face colors brighter.

* If the image contains colors that are the same as human skin, those colors will also be changed.

Also you may not obtain the expected results depending on the skin color.

1 FUNC. Menu → * (My Colors Off).

See *Menus and Settings* (p. 26)

- Use the ◀ or ▶ button to select a My Colors mode.



- **CC** Mode
Setting the Camera to a Custom Color Mode (p. 81).
 - Other than **CC** Mode
Press the **FUNC.** button to return to the shooting screen and begin shooting.
- * Default setting.

 The ISO speed will increase with some settings, which may increase the noise in the image.

Setting the Camera to a Custom Color Mode

You can adjust the contrast, sharpness, saturation, red, green, blue, or skin tone balance and shoot.

- 1** **CC** (Custom Color) → **SET** button.

See *Menus and Settings* (p. 26)



- 2** Use the ▲ or ▼ button to select [Contrast], [Sharpness], [Saturation], [Red], [Green], [Blue], or [Skin Tone] and the ◀ or ▶ button to make adjustments.

- The altered color will display.



Select an item to adjust.

Adjust the selected item.

- 3** Press the **SET** button.

- This completes the setting.

⚡ Switching between Flash Adjustment Settings

Shooting Mode **Tv Av**

Although the built-in flash will fire with automatic flash adjustments (except in the **M** mode), it is also possible to set it so that it fires without any adjustments.

- 1  (Rec.) Menu → [Flash Adjust]
→ [Auto]*/[Manual].



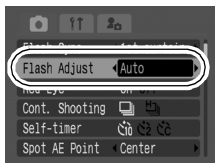

See *Menus and Settings* (p. 27)



* Default setting.

Compensating the Flash Adjustment/Flash Output

Shooting Mode    **P Tv Av M**

Flash Exposure Compensation	<ul style="list-style-type: none">• When the shooting mode is set to , , , , P or when [Flash Adjust] is set to [Auto] in Tv or Av mode, settings can be adjusted in 1/3-stop increments in the range of -2 to +2 stops.• You can combine the flash exposure compensation with the camera's exposure compensation function to achieve creative effects which compensate for background exposure.
Flash Output	<ul style="list-style-type: none">• When Shooting mode is set to M or when [Flash Adjust] is set to [Manual] in Tv or Av mode, the flash output can be controlled in three steps, starting from FULL, when shooting.

1 FUNC. Menu → [Flash]/ [Flash Output].

See Menus and Settings (p. 26)

- Adjust the compensation/output using the ◀ or ▶ button and press the FUNC. button.



e.g. [Flash Adjust]
set to [Auto]



e.g. [Flash Adjust]
set to [Manual]

Switching the Timing at which the Flash Fires

Shooting Mode **P Tv Av M**

1st-curtain	The flash fires right after the shutter opens, regardless of the shutter speed. Usually, the 1st-curtain is used when shooting.
2nd-curtain	The flash fires right before the shutter closes. Compared with the 1st-curtain, the flash fires later and allows you to shoot images in which, for example, a car's taillights seem to trail off behind.

1 [Rec.] → [Flash Sync] → [1st-curtain]* / [2nd-curtain].

See Menus and Settings (p. 27)



Image shot with the
1st-curtain setting



Image shot with the
2nd-curtain setting

* Default setting.

Shooting Images at Set Intervals (Intervalometer)

Shooting Mode **P Tv Av M**

You can shoot images at a set interval. This function can be used for fixed-point observation of plants and blooming flowers. The shooting interval time can be set from 1* to 60 minutes and 2* to 100 images can be shot.

* Default setting



Since the camera may shoot continuously for an extended period of time, the use of the Compact Power Adapter CA-PS700 (sold separately) is recommended (p. 139).

1 (Rec.) Menu → [Intervalometer].

See Menus and Settings (p. 27)



2 [Interval Time] and [No. of shots] → SET button.

- If you press the ◀ or ▶ button continuously, the number of shots changes in units of 5 shots at a time.
- The maximum number of shots* is determined by the available space on the memory card.
 - * The maximum number of shots may be reduced according to the images already shot.
- The camera exits the menu screen and **Int.** appears at the lower right of the LCD monitor (or viewfinder).

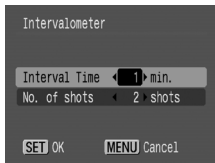

3 Press the shutter button.

- The first image is shot and the interval shooting session starts. Once the first image is shot, the power is turned off until the next shot, and the LCD monitor (or viewfinder) turns off. (The power automatically turns on immediately before the next shot.)
 - Once the set number of shots is taken the camera automatically powers down regardless of the power saving function settings.
 - If the following operations are accessed while the interval shooting is in process, the interval shooting session will be canceled.
 - Turning the mode dial while the camera is waiting to shoot the next image
 - Opening the memory card slot or battery cover
 - Operating the mode lever
 - Turning off the power
-



- Once the interval shooting session is started, all operation buttons become inactive.
- The lens stays extended until the next image is shot.
- Images are not displayed on the LCD monitor (or viewfinder) right after being shot.
- Interval shooting is not available when the date and time are not set.
- AEB mode and the Focus-BKT mode settings cannot be set.
- Only the first image is shot with the self-timer.

C Saving Custom Settings

Shooting Mode **P Tv Av M C**

You can save frequently used shooting modes and various shooting settings to the **C** (Custom) mode. When necessary, you can then shoot images with previously saved settings by simply turning the mode dial to **C**. Settings that are not memorized when the shooting mode is changed or when the power is turned off (such as continuous shooting or self-timer) are also remembered.

1 Switch to the shooting mode you wish to save and set the settings.

- To change some of the settings saved in **C** (other than shooting mode), select **C**.
- Functions which can be saved in **C**
 - Shooting mode (**P**, **Tv**, **Av**, **M**)
 - Items which can be set in **P**, **Tv**, **Av** and **M** modes (p. 161)
 - Rec. menu settings
 - Zoom location
 - Manual focus location

2 (Rec.) Menu → [Save Settings].

See *Menus and Settings* (p. 27)

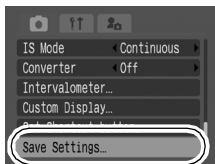

3 [OK] → SET button.



- The setting contents do not influence other shooting modes.
- Saved settings can be reset (p. 34).

Setting the Auto Rotate Function



Shooting Mode **AUTO**     **SCN**  **P Tv Av M**

Playback Mode 

Your camera is equipped with an Intelligent Orientation sensor that detects the orientation of an image shot with the camera held vertically and automatically rotates it to the correct orientation when viewing it in the LCD monitor (or viewfinder).

1 (Set up) Menu → [Auto Rotate] → [On]^{*}/[Off].

See *Menus and Settings* (p. 27)

- When the Auto Rotate function is set to [On] and the LCD monitor (or viewfinder) is set to the detailed display mode, the  (normal),  (right end is down) or  (left end is down) will appear in the display.

* Default setting.



- This function may not operate correctly when the camera is pointed straight up or down. Check that the arrow  is pointing in the right direction. If it is not, set the Auto Rotate function to [Off].
- Even if the Auto Rotate function is set to [On], the orientation of images downloaded to a computer will depend upon the software used to download the images.



- When the camera is held vertically to shoot, the Intelligent Orientation sensor judges the upper end to be "up" and the lower end to be "down". It then regulates the optimal white balance, exposure, and focus for vertical photography. This function operates regardless of the on/off status of the Auto Rotate function.
- The Auto Rotate function can be set for the shooting and playback modes separately.
 - When the Auto Rotate function is set to [On] in shooting mode, the orientation of the camera is recorded when the shot is taken. Therefore, the image is automatically rotated during playback mode based on the orientation of the camera during shooting.
 - When the Auto Rotate function is set to [On] in playback mode, images will be rotated to their correct orientation in the LCD monitor (or viewfinder) regardless of the camera's orientation when shooting.

Creating an Image Destination (Folder)



You can create a new folder at any time and the recorded images will be automatically saved to that folder.

Create New Folder	Creates a new folder the next time you shoot images. To create an additional folder, insert another check mark.
Auto Create	To create a new folder the next time you shoot after a specified date and time, specify a date and time (p. 89).

1 [i] (Set up) Menu → [Create Folder].

See *Menus and Settings* (p. 27)

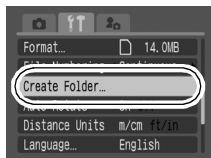

Create a Folder the Next Time You Shoot

- 2** Use the ◀ or ▶ to place a check mark beside [Create New Folder] → **Menu button.**

-  displays in the LCD monitor (or viewfinder). The symbol will cease to display after the new folder is created.

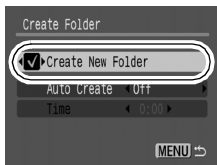

Setting the Day or Time for Automatic Folder Creation

- 3** Select a day for the [Auto Create] option and a time in the [Time] option → **Menu button.**

-  displays in the LCD monitor (or viewfinder) when the specified time arrives. The symbol will cease to display after the new folder is created.

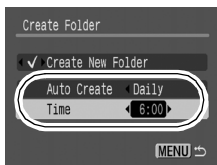

Up to 2000 images can be saved into one folder. A new folder will automatically be created when you record more than that number.

Resetting the File Number

Shooting Mode

AUTO



SCN



P

Tv

Av

M

Playback Mode



The images you shoot are automatically assigned file numbers. You can select how the file number is assigned.

- 1  (Set up) Menu → [File Numbering] → [Continuous]^{*1} / [Auto Reset].

See *Menus and Settings* (p. 27)

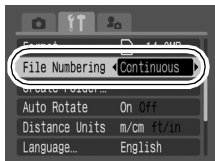

*1 Default setting.

File No. Reset Function

Continuous	A number one higher than the last one recorded is assigned to the next image. This is convenient for managing all your images together on a computer because you avoid file name duplication when changing folders or memory cards. ^{*2}
Auto Reset	The image and folder number are reset to the starting value (100-0001) ^{*2} . This is convenient for managing images on a folder-by-folder basis.

*2 When a blank memory card is used. If a memory card with recorded data is used, the 7-digit number for the last recorded folder and image is compared with the last one on the card, and the larger of the two is utilized as the basis for new images.

File and Folder Numbers

Recorded images are assigned consecutive file numbers starting with 0001 and ranging up to 9999, while folders are assigned numbers starting with 100 and ranging up to 999. Up to 2,000 images can be saved into a single folder.

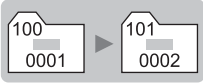
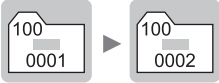
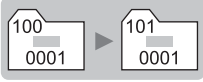
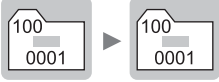
	New Folder Created	Created Memory Card Exchanged for Another
Continuous	Memory Card 1 	Memory Card 1 Memory Card 2 
Auto Reset	Memory Card 1 	Memory Card 1 Memory Card 2 

- Images may be saved to a new folder when there is insufficient free space even if the total number of images in a folder is less than 2,000 because the following types of images are always saved together into the same folder.
 - Continuous shooting
 - Self-timer images (📷 (custom))
 - Movies (still images of movies)
 - Stitch Assist mode images
 - Color Accent/Color Swap still images (with [Save Original] set to [On])
 - Focus Bracketing
 - AEB shooting
- Images cannot be played back when the folder numbers are duplicated or image numbers are duplicated within folders.
- Please refer to the *Software Starter Guide* for information regarding folder structures or image types.

Playback/Erasing

See the *Basic Guide* (p. 14).

🔍 Viewing Magnified Images

1 Press the 🔍 button.

- **SET** 🔍 will display and a magnified portion of the image will display.
- You can change the magnification level with the zoom lever.
- Images can be magnified up to a factor of approximately 10x.



Approximate Location of the Magnified Area

2 Use the ▲, ▼, ◀ or ▶ button to move around the image.

- If you press the **SET** button once more, the camera switches to image advance mode and **SET** ⏮ will display. You can use the ◀ or ▶ button to advance to the next or previous image at the same level of magnification. The image advance mode cancels when you press the **SET** button again.

To Cancel the Magnified Display: Turn the zoom lever toward 📏.
(You can also cancel it immediately by pressing the **MENU** button.)



Movie frames and index playback images cannot be magnified.

Viewing Images in Sets of Nine (Index Playback)

1 Turn the zoom lever toward



- Up to nine images can be viewed at once in index playback.
- Use the ▲, ▼, ◀ or ▶ button to change the image selection.



Selected Image

Movie

Switch the display nine images at a time

If you turn the zoom lever towards  during index playback, the jump bar appears and you can switch between the sets of nine images.

- View the previous or next nine images using ◀ or ▶ button.
- Hold the **SET** button down and press the ◀ or ▶ button to jump to the first or last set.







Jump Bar

To Cancel the Magnified Display: Turn the zoom lever toward .

Jumping to Images

When you have many images recorded onto a memory card, it is handy to use the four search keys below to jump over images to find the object of your search.

	Jump 10 Images	Jumps over 10 images at a time.
	Jump 100 Images	Jumps over 100 images at a time.
	Jump Shot Date	Jumps to the first image with the next shooting date.
	Jump to Movie	Jumps to a movie.
	Jump to Folder	Displays the first image in each folder.

1 In Single Image playback mode, press the button.

- The camera will switch to jump search mode.
- The screen sample will vary slightly according to the search key.



Position of currently displayed image

Number of images matching search key.

2 Use the or button to select a search key and press the or button.

To Return to Single Image Playback: Press the **MENU** button.

Viewing Movies



 Movies cannot be played in the index playback mode.

1 Display a movie and press the **SET** button.

- Images with a  icon are movies.













Movie Control Panel

Speaker volume
(Adjust with the  or
 button)

2 Select (Play) and press the **SET** button.

- The movie will pause if you press the **SET** button during playback. It will resume when you press the button again.
- When playback ends, the movie stops at the last frame displayed. Press the **SET** button to display the movie control panel.

Operating the Movie Control Panel

	Exit (Single image playback)
	Print (Only appears when connected to a printer. For details, refer to your Direct Print documentation.)
	Play
	Slow Motion Playback (You can use the  button to slow down or the  button to speed up playback.)
	Displays the first frame
	Previous Frame (Rewinds if the SET button is held down)
	Next Frame (Fast Forwards if the SET button is held down)
	Displays the last frame
	Edit (Switches to movie editing mode) (p. 96)



- Use the television's controls to adjust the volume when playing a movie on a TV set (p. 116).
- The sound cannot be played in slow motion playback.

Editing Movies

You can delete portions of recorded movies.

! Movies that are protected or less than 1 second long cannot be edited.

1 Select  (Edit) in the movie control panel and press the **SET** button.







- The movie editing panel and the movie editing bar will display.



Movie Editing Panel



Movie Editing Bar

Counter

2 Use the  or  button to select  (Cut Beginning) or  (Cut End) and the  or  button to specify the point () at which to cut.

- To check a temporarily edited movie, select  (Play) and press the **SET** button.
- Selecting ( Exit) cancels the edit and restores the movie control panel.

3 Select  (Save) and press the **SET** button.

4 Select [New File] or [Overwrite] and press the **SET** button.

- [New File] saves the edited movie under a new file name. The pre-edit data is left unchanged. Note, if you press the **SET** button while saving the movie, saving is canceled.
- [Overwrite] saves the edited movie with its original name. The pre-edit data is lost.
- When there is not enough space left on the memory card, only [Overwrite] can be selected, and ▲ appears on the counter of the movie editing bar



It may take approximately 3 minutes to save an edited movie. If the battery runs out of charge partway through, edited movieclips cannot be saved. When editing movies, it is recommended to use new size-AA alkaline batteries, fully charged size-AA NiMH batteries, or the separately sold Compact Power Adapter CA-PS700 (p. 139).

Rotating Images in the Display

Images can be rotated clockwise 90° or 270° in the display.

Original



90°



270°



1 (Play) Menu → .

See *Menus and Settings* (p. 27)



2 Use the ◀ or ▶ button to select an image to rotate and press the **SET** button to rotate it.



- Cycle through the 90° → 270° → original orientations with each press of the **SET** button.
- Images can be rotated in index playback.





- Movies cannot be rotated.
- When images are downloaded to a computer, the orientation of images rotated by the camera will depend upon the software used to download the images.

Applying Effects and Playing Back

You can apply such effects as fade in, and then play back your movies.

 Off	Play back the movie without applying effects.
	Allows you to apply a fade (fade-in) while transitioning between scenes.
	Allows you to apply a movement effect that transitions scenes right with the ◀ button and left with the ▶ button.

1  (Play) Menu →  → Off /  *



See *Menus and Settings* (p. 27)



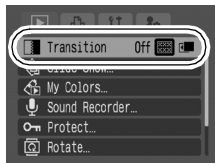







* Default setting.



 The transition effect will not display when an image is switched while the camera is reading an image from the memory card.

Adding My Colors Effects

You can add effects to recorded images (stills only) using the My Colors function. The following selection of My Colors effects is available. For details, see [p. 80](#).

 Vivid	 Lighter Skin Tone
 Neutral	 Darker Skin Tone
 Sepia	 Vivid Blue
 B/W	 Vivid Green
 Positive Film	 Vivid Red

1 (Play) Menu → .

See *Menus and Settings* ([p. 27](#))

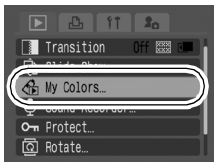

2 Use the or button to select an image, and press the **SET** button.



3 Use the or button to select the My Colors type, and press the **SET** button.

- The displayed image will reflect the My Colors effect.
- You can turn the zoom lever toward  to check the image at a higher magnification. While the image is zoomed, you can press the **SET** button to switch between the image transformed with the My Colors effect and the original non-transformed image.



4 Select [OK], and press the **SET** button.

- The newly saved image transformed with the My Colors effect will be the last one in the list.
- To continue adding effects to other images, repeat the procedures from Step 2 onward.



5 Press the **MENU** button and select [Yes] or [No], then press the **SET** button.

- Selecting [Yes] displays the image transformed with the My Colors effect, while [No] returns you to the Play menu.



- The My Colors function will not work if there is insufficient space on the memory card.
- Although My Colors effects can be added any number of times to an image, the image quality will gradually deteriorate with each application and the intended colors may not be achieved.
- Color in images taken using My Colors (p. 80) in shooting mode and images edited with the My Colors function in playback mode may differ slightly.

🎤 Attaching Sound Memos to Images

In Playback mode (including single image playback, index playback, magnified playback and the review immediately after shooting in Shooting mode) you can attach sound memos (up to 1 minute) to an image. The sound data is saved in WAVE format (stereo).

1 Press the 🎤 button while playing back images.

The sound memo control panel will display.

2 Use the ◀ or ▶ button to select **🔴** (Record) and press the **SET** button.

- The elapsed time and the remaining time display.
- Pressing the **SET** button pauses the recording. Pressing it again resumes recording.
- Up to 1 minute of recordings can be added to any one image.
- The sound mode can be changed (p. 50).



Sound Memo Panel

Elapsed Time/
Remaining Time

Volume
(Adjust with the ▲ or ▼ button)

Sound Memo Panel

	Exit
	Record
	Pause
	Play
	Erase Select [Erase] in the confirmation screen and press the SET button.



- You cannot attach sound memos to movies.
- Sound memos for protected images cannot be erased (p. 109).

Sound-Only Recording (Sound Recorder)

You can record sound (stereo) only, without images, for up to two hours at one time.

1 (Play) Menu → .

See *Menus and Settings* (p. 27)



2 Use the or button to select (Record) from the Sound Control Panel and press the **SET** button.

- The recording starts and the elapsed time is displayed.
- The sound mode can be changed (p. 50).
- When you press the **SET** button, recording stops. Press the **SET** button again to start a new recording.

Pressing the shutter button halfway, or pressing the movie button will also stop recording.

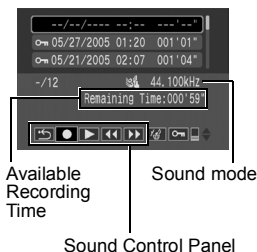

- The maximum recording time depends on the space available on the memory card, and the sound mode.
- Recording stops when the memory card is full.
- From the Playback mode, the Sound Control Panel can be displayed by holding the  button.

Sound Playback

1 (Play) Menu → .

See *Menus and Settings* (p. 27)





2 Use the ▲ or ▼ button to select a sound and select with the ◀ or ▶ button, and press the **SET** button.

The sound plays.

 (Exit): Returns to the Play menu.



 (Record): Records sound.

 (Play): Plays sound.

 (Rewind): Hold the **SET** button to rewind (no sound plays).

 (Fast Forward): Hold the **SET** button to fast forward (no sound plays)

 (Erase): Press the **SET** button, press the ◀ or ▶ button to select [Erase], and press the **SET** button again to erase the selected sound. If you select [Erase All] and press the **SET** button, a confirmation screen displays. Press the ◀ or ▶ button to select [OK] and press the **SET** button to erase all unprotected sound.

 (Protect): Press the **SET** button to protect the selected sound from erasure ( appears). To remove protection, press the **SET** button again.

 (Volume): Press the ▲ or ▼ button to adjust the volume.

- Play volume can be adjusted with [Volume] on the [(Setup)] menu (p. 31).

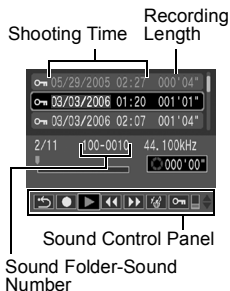



For details on the sound number and folder number, refer to the *Software Starter Guide*.

Automated Playback (Slide Shows)

The images on a memory card can be displayed automatically.

* Slide show image settings are based on DPOF standards (p. 111).

Types of Slide Shows

	All Images	Plays all images on the memory card in order.
	Date	Starts the slide show from the specified date, in the order taken.
	Folders	Uses the images in the specified folder, and displays them in their folder order.
	Movies	Uses all the movies on the specified memory card.
	Still Images	Uses all the images on the specified memory card.
	Custom 1-3	Mark only the images that you would like to see in the slide show and save the selections in [Custom 1], [Custom 2], or [Custom 3] (p. 108).

1 (Play) Menu

See *Menus and Settings* (p. 27)



2 Select from , , , , , or to .

- For and : Select the date or folder to play images from (p. 107).
- For to : Select the images to play (p. 108).
- To add effects and play back, select [Effect] with the button, and select the type of effect with the or button (p. 106).







3 [Start] → SET button.

- The following can be performed during automated playback.
 - Pause/resume the slide show: Press the **SET** button
 - Move on to next/go back to previous: Press the ◀ or ▶ button (Hold the button down to go faster)
 - Stop the slide show: Press the **MENU** button



Types of Effects

When the following screen appears, you can apply effects to your slide show.

	Playback begins automatically without using effects.
 *	Applies a down-up fade of the image, the image appears from the bottom up.
	At first, a cross appears on the image and the image appears gradually.
	The image gradually appears horizontally.

* Default setting.



During single image playback, simultaneously pressing the **SET** and  buttons begins a slide show from the first image. However, if you do this when the last taken image is displayed, playback begins by the first image taken the same day as the one displayed.

Select the date/folder to play images from (, )

1 Select  or  → **SET** button.

2 Use the ◀ or ▶ button to select the date or folder to play images from → **MENU** button.



Date

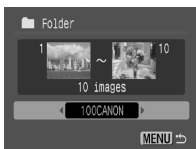

Folder

Select images for the Slide Show (1 to 3)

Select only the images that you wish to play back and save them as a slide show (Custom 1, 2 or 3). Up to 998 images can be selected. They will be played back in their order of selection.

1 Select 1 to 3 → SET button.

- Only the 1 icon will display at first. When you set 1, the icon will change to 1✓ and 2 will display. 2 and 3 will change in the same way when they are set.

2 Use the ◀ or ▶ button to move between images for playback and the SET button to select or deselect them.

- You can also select images in the index playback mode.
- Pressing the MENU button cancels the setting.

Check mark indicating selection
Number indicating the selection order



Selecting All Images

1. After selecting 1 to 3 in step 1 (p. 108), use the ▲ button to select [Mark all] and press the SET button.
2. Use the ▲ button to select [Mark all], press the SET button.
3. Use the ▶ button to select [OK] and press the SET button. To deselect all images, select [Reset].

Adjusting the Play Time and Repeat Settings

● Play Time

Sets the duration that each image displays. Choose between 3* – 10 seconds, 15 seconds and 30 seconds. (Displaying time can vary slightly depending on the image.)

* Default setting.

● Repeat

Sets whether the slide show stops when all the slides have been displayed or continues until stopped.

1 [Set up] → **SET** button.

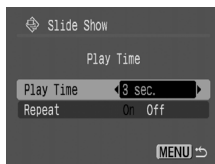

2 Select [Play Time] or [Repeat] and then the desired option.

- Pressing the **MENU** button cancels the setting.



Protecting Images

You can protect important images and movies from accidental erasure.

1  (Play) Menu → .

See *Menus and Settings* (p. 27)

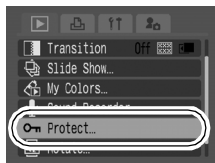

2 Select an image you want to protect using the ◀ or ▶ button.

- Pressing the **SET** button again cancels the setting.
- You can also protect images in the index playback mode.



Protection Icon

Please note that formatting (initializing) a memory card erases all data (p. 35), including protected images and other file types. Please check the contents of a memory card before formatting it.

Erasing All Images

- Please note that erased images cannot be recovered. Exercise adequate caution before erasing an image.
- Protected images cannot be erased with this function.

1 (Play) Menu → .

See *Menus and Settings* (p. 27)



2 [OK] → **SET** button.

- To exit instead of erasing, select [Cancel].



 Please format the memory card when you want to erase not only image data but also all the data contained on the card (p. 35).

Print Settings/Transfer Settings

Setting the DPOF Print Settings

You can select images on a memory card for printing and specify the number of print copies in advance using the camera. The settings used on the camera comply with the Digital Print Order Format (DPOF) standards. This is extremely convenient for printing on a direct print compatible printer, or for sending the images to a photo developing service that supports DPOF. These settings are compliant with DPOF (Digital Print Order Format).

The  icon may display for a memory card with print settings set by a different DPOF-compliant camera. These settings will be overwritten by those set by your camera.



Single Images

- 1  (Play) Menu →  (Print) Menu → [Select Images & Qty.].
See Menus and Settings (p. 27)

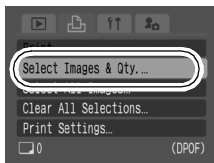
- Selecting [Clear All Selections] cancels all print settings for the images.





- 2 Using the  or  button to select images for printing.

- As shown below, selection methods differ for the Print Type settings (p. 113).
 -  (Standard)/ (Both)
Select an image and press the **SET** button to select or deselect it.

Number of Print Copies





-  **(Index)**
Select an image and press the **SET** button to select or deselect it.
- You can also select images in the index playback mode.
- If the camera is connected to a printer, the  button lights blue during image selection. Printing starts after pressing the **SET** button once the  button is pressed and [Print] selection is confirmed.

Index Print Selection



All the Images on a Memory Card

1 (Play) Menu → (Print) Menu → [Select All Images].

- One copy of every image will be set to print.
- Selecting [Clear All Selections] cancels all print settings for the images.
- If the camera is connected to a printer, the  button lights blue after the **SET** button is pressed. Printing starts after pressing the **SET** button once the  button is pressed and [Print] selection is confirmed.

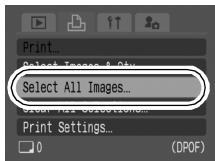

2 [OK] → **SET** button.



- The output of some printers or photo developing services may not reflect the specified print settings.
- Print settings cannot be set for movies.



- The images are printed in order from oldest to newest by the date and time they were shot.
- A maximum of 998 images can be selected.
- When [Print Type] is set to [Both], the number of copies can be set. When it is set to [Index], the number of copies cannot be set (only one copy will be printed).

Setting the Print Style

Specify the print style before selecting the image to print.
The following print settings can be selected.

* Default setting

Print Type	<input checked="" type="checkbox"/> Standard*	Prints one image per page.
	<input type="checkbox"/> Index	Prints the selected images together at a reduced size in an index format.
	<input type="checkbox"/> Both	Prints the images in both the standard and index formats.
Date (On/Off*)		Adds the date to the print.
File No. (On/Off*)		Adds the file number to the print.
Clear DPOF data (On*/Off)		Clears all print style settings after printing is complete.

- 1** (Play) Mode → (Print) Menu → [Print Settings].
See *Menus and Settings* (p. 27)

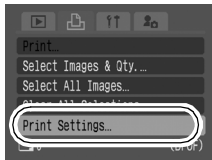

- 2** Select [Print Type], [Date], [File No.], or [Clear DPOF data] and then select the settings.

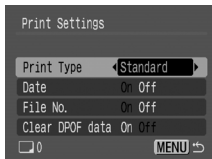





- The Date and File No. settings will change according to the Print Type as follows. However, the printable information may vary between printers.
 - Index
[Date] and [File No.] cannot be set to [On] at the same time.
 - Standard or Both
[Date] and [File No.] can be set at the same time.
- Do not set the date in the DPOF print settings when printing images that have had the date embedded with the [Date Stamp] function. This may cause the date to be printed twice.
- Dates print in the style specified in the [Date/Time] menu (p. 31).

Setting the DPOF Transfer Settings

You can use the camera to specify settings for images before downloading to a computer. Refer to the *Software Starter Guide* for instructions on how to transfer images to your computer.

The settings used on the camera comply with the Digital Print Order Format (DPOF) standards.

The  icon may display for a memory card with transfer settings set by a different DPOF-compliant camera. These settings will be overwritten by those set by your camera.

1  (Play) Menu → .

See *Menus and Settings* (p. 27)



Single Images

2 [Order] → **SET** button.

- Selecting [Reset] cancels all transfer order settings.

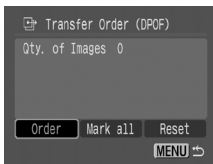

3 Use the ◀ or ▶ button to select an image to transfer → **SET** button.

- Pressing the **SET** button again deselects the setting.
- You can also select images in the index playback mode (p. 93).

Transfer Selection



All the Images on a Memory Card

2 Select [Mark all] and press the **SET** button.

- Selecting [Reset] cancels all transfer order settings.

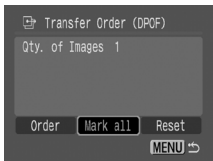

3 Select [OK] and press the **SET** button.



- The images are transferred in order from oldest to newest by the date and time they were shot.
- A maximum of 998 images can be selected.

Shooting/Viewing Images on a TV set

You can use a video-compatible television as a monitor to shoot or play back images when it is connected to the camera with the supplied Stereo/Video Cable STV-250N.

1 Turn off the camera and the TV.

2 Connect the Stereo/Video Cable to the camera's A/V OUT terminal.

- With your fingernail on the left edge of the camera's A/V OUT terminal cover, pull it forward to open it, and plug the Stereo/Video Cable in all the way.

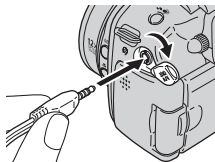

3 Plug the other ends of the Stereo/Video Cable into the VIDEO IN and AUDIO IN jacks on the TV.

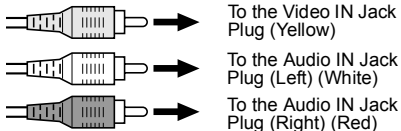

4 Turn on the TV and switch it to Video mode.

5 Power on the camera.





- The video output signal can be switched (NTSC or PAL) to accommodate different regional standards (p. 32). The default setting varies between regions.
 - NTSC: Japan, U.S.A., Canada, Taiwan and others
 - PAL: Europe, Asia (excluding Taiwan), Oceania and others
- If the video system is set incorrectly, the camera output may not display properly.

Customizing the Camera (My Camera Settings)

My Camera allows you to customize the start-up image and the startup, operation, self-timer, and shutter sounds. You can change and register these settings, enabling you to customize the camera to suit your own tastes.

Changing My Camera Settings

- 1  (Playback) Mode →
 (My Camera) Menu →
Menu Item.

See *Menus and Settings* (p. 27)

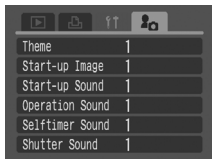

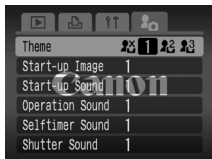

- 2 Use the ◀ or ▶ button to select the contents you wish to set.

Select [Theme] to set all to the same settings.



Registering My Camera Settings

Images recorded onto the memory card and newly recorded sounds can be added as My Camera settings to the  and  menu items. You can also use the supplied software to upload your computer's images and sounds to the camera.

-  A computer is required to restore the My Camera settings to the defaults. Use the supplied software (ZoomBrowser EX/ImageBrowser) to restore the default settings to the camera.

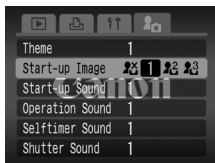

- 1**  mode →  (My Camera)
Menu → Menu Item to register.
See Menus and Settings (p. 27)

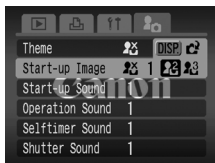

- 2** Select  or  and press **DISP.** button.



- 3** Select an image or record a sound.

- Start-up Image
Select the image you wish to register and press the **SET** button.
- Start-up, Operation, Self-timer and Shutter Sounds
Select  (Record) and press the **SET** button. After recording, select  (Register Sound) and press the **SET** button.
 - Recording will automatically stop when the recording time elapses.
 - To play it, select  (Play).
 - To exit instead of registering, press  (Exit).



4 Select [OK] and press the **SET** button.

- To cancel registering, select [Cancel].



- The following cannot be registered as My Camera settings.
 - Movies
 - Sounds recorded with the sound memo function (p. 102) and sound recorder (p. 103)
- The prior setting is erased when a new My Camera setting is added.



See the supplied *Software Starter Guide* for more information on creating and adding to the My Camera data.

Troubleshooting

Camera

Camera will not operate.

Power is not turned on.	<ul style="list-style-type: none">● Press the power button for a moment (<i>Basic Guide</i> p. 3).
Memory card slot or battery cover is open.	<ul style="list-style-type: none">● Confirm that the memory card slot cover or battery cover is securely closed (<i>Basic Guide</i> p. 1).
Batteries are loaded in the wrong direction.	<ul style="list-style-type: none">● Put batteries back into the camera in the correct direction (<i>Basic Guide</i> p. 1).
Batteries are not the right type.	<ul style="list-style-type: none">● Use only unused AA-size alkaline batteries or Canon AA-size NiMH batteries. (<i>Basic Guide</i> p. 1).
Insufficient battery voltage ("Change the batteries" message displays).	<ul style="list-style-type: none">● Insert the four unused or fully charged AA-size NiMH batteries into the camera (<i>Basic Guide</i> p. 1).● Use the Compact Power Adapter (sold separately) (p. 139).
Poor contact between camera and battery terminals.	<ul style="list-style-type: none">● Polish the terminals with a soft cotton swab before charging or using the battery (p. 132).● Reinsert the batteries several times.

Sounds come from the inside of the camera.

The camera's horizontal/vertical orientation was changed.	<ul style="list-style-type: none">● The camera's orientation mechanism is operating. There is no malfunction.
---	---

When the power is turned on

"Card locked!" message appears.

The SD memory card's write protect tab is set to "Write protect".

- When recording to, erasing from or formatting the memory card, slide the tab upward (p. 133).

The Date/Time menu appears.

The lithium coin battery charge is low.

- Replace it (p. 135).

LCD monitor/Viewfinder

The display darkens.

The image in the LCD monitor will darken in strong sunlight or bright light.

- This is a normal occurrence in devices containing CCDs and does not constitute a malfunction. (This image will not be recorded when shooting still photos, but it will be recorded when shooting movies.)

Display flickers.

Display flickers when shot under fluorescent lighting.

- This is not a camera malfunction. (Flickering is recorded in movies, but not in still images.)

A bar of light (red, purple) appears on the LCD monitor.

Subject is too bright.

- This is a normal occurrence in devices containing CCDs and does not constitute a malfunction. This bar of light will not be recorded when shooting still photos, but it will be recorded when shooting movies.

appears.

A slow shutter speed has likely been selected because of insufficient lighting.

- Turn the Image Stabilizer function on (p. 39).
- Increase the ISO speed (p. 69), enable the flash, or use a tripod to stabilize the camera (*Basic Guide* p. 11).

appears.

The symbol will display when using a memory card that had print settings or transfer settings set by other DPOF-compliant cameras.

- Be careful when making changes to the print or transfer settings with other DPOF cameras, because all such settings will be overwritten by your camera (pp. 105, 111, 114).

Noise displays./Subject's movements are irregular.

The camera automatically brightened the image displayed on the LCD monitor (or viewfinder) to make it easier to see when shooting in a dark area (p. 19).

- There is no effect on the recorded image.

Shooting

Camera will not record.

Camera is in Playback or computer/printer connection mode.

- Turn the mode lever to the left or press the shutter button halfway to switch to Shooting mode.
- During a computer or printer connection, disconnect the interface cable before switching the camera to Shooting mode.

Flash is charging. (Blinking white  on LCD monitor/in viewfinder).

- Wait until  stops blinking and lights steadily, signaling that the flash is charged, then press the shutter button.

Memory card full.

- Insert a new memory card (*Basic Guide* p. 1).
- If required, download the images to a computer and erase them from the memory card to make space.

Memory card is not formatted correctly.

- Format the memory card (p. 35).
- If reformatting does not work, the memory card logic circuits may be damaged. Consult the nearest Canon Customer Support Help Desk.

SD memory card is write protected.

- Slide the write protect tab of the SD memory card upward (p. 133).

Image is blurred or out of focus.

AF-assist Beam is set to [Off].	<ul style="list-style-type: none">● In dark places where it is difficult for the camera to focus, the AF-assist Beam will emit to assist focusing. As the AF-assist Beam will not function when turned off, set it [On] to activate it (p. 28). Take care not to obstruct the AF-assist Beam with your hand when used.
The camera moves when the shutter button is pressed.	<ul style="list-style-type: none">● Set the image stabilizer function to any other setting than [Off] (p. 39).● Increase the ISO speed to increase the shutter speed.● Setting the self-timer to  (2 seconds) delays the shutter release for 2 seconds and allows the camera to stop shaking, thus preventing a blurred image (p. 43).● Even better results can be obtained by placing the camera on a stable surface or by using a tripod to shoot.
Subject is out of focal range.	<ul style="list-style-type: none">● Shoot with the subject at the correct shooting distance (p. 146).
The subject is hard to focus on.	<ul style="list-style-type: none">● Use the focus lock, AF lock or manual focus to shoot (p. 64).

Subject in recorded image is too dark.

Subject is too close, making the flash too strong.	<ul style="list-style-type: none">● Raise the flash and set it so that it always fires (<i>Basic Guide</i> p. 11).
Subject is under exposed due to the surrounding area being too bright.	<ul style="list-style-type: none">● Set the exposure compensation to a positive (+) setting (p. 75).● Use the AE lock or spot metering function (pp. 70, 73).
Subject is too far away for flash to reach.	<ul style="list-style-type: none">● Shoot within correct shooting distance of the subject when using the internal flash (p. 147).● Raise the ISO speed and then shoot (p. 69).

Subject in recorded image is too bright, or image flashes white.







Subject is too close, making the flash too strong.	<ul style="list-style-type: none">● Shoot within correct shooting distance of the subject when using the internal flash (p. 147).
Subject is over exposed due to the surrounding area being too dark.	<ul style="list-style-type: none">● Set the exposure compensation to a negative (-) setting (p. 75).● Use the AE lock or the spot metering function (pp. 70, 73).
Light is shining directly on the subject or reflected off the subject into the camera.	<ul style="list-style-type: none">● Change the shooting angle.
Flash is set to on.	<ul style="list-style-type: none">● Push down the flash to off  (Flash off) (<i>Basic Guide</i> p. 11).

Image contains noise.

ISO speed is too high.	<ul style="list-style-type: none">● Selecting high ISO speeds or  (High ISO Auto) may increase the amount of noise in an image. When picture quality is the priority, select lower ISO speeds (p. 69).● In , ,  and  modes of Special Scene mode, the ISO speed increases and noise may occur.
------------------------	--

White dots appear on the image.

Light from the flash has reflected off dust particles or insects in the air. When shooting at the maximum wide angle.	<ul style="list-style-type: none">● This is a phenomenon that occurs with digital cameras and does not constitute a malfunction.
---	--

Eyes appear red.

Light reflecting back from eyes can make them appear red when the flash is used in dark areas.	<ul style="list-style-type: none">● Under these conditions, use the  red-eye reduction mode (<i>Basic Guide</i> p. 11). For this mode to be effective, the subject must be looking right at the red-eye reduction lamp. Try asking them to look directly at the lamp.● Even better results can be obtained by increasing the lighting in indoor settings or approaching closer to the subject.
--	--

Continuous shooting slows down.

The memory card's performance has dropped.

- To enhance the continuous shooting performance, you are recommended to format the memory card in the camera after you save all its images to your computer (p. 35).

Recording images to memory card takes a long time.

Memory card was formatted in another device.

- Use a memory card formatted in your camera (p. 35).

Lens will not retract.

Memory card slot cover or battery cover was opened with power on.

- First close the memory card slot cover or battery cover, turn the power on, and then turn the power off again (*Basic Guide* p. 1).

Interval shooting session is in progress.

- The lens will automatically retract when the specified number of images are taken.

The mode was switched from shooting to playback mode.

- The lens will not retract in this case. To retract the lens, turn the mode lever to the left again.

Shooting Movies

The recording time may not display properly or filming may stop unexpectedly.

The following types of memory cards are used.

- Slow recording cards.
- Cards formatted on a different camera or a computer.
- Cards which have had images recorded and erased repeatedly.

- Although the recording time may not display properly during shooting, the movie will be recorded correctly on the memory card. Recording time will display properly if you format the memory card in this camera (excluding slow recording memory cards) (p. 35).

"Buffer Warning" (p. 20) displays frequently on the LCD monitor.

When the camera's internal memory is low, the "Buffer Warning" displays until it is full, and shooting will automatically stop.

- Try the following procedures.
 - Format the card with a low level format before filming (p. 35).
 - Lower the recording pixels/frame rate (p. 48).
 - Use a high-speed memory card (SDC-512MSH, etc.).

Playback

Cannot play back.

You attempted to play back images shot with another camera or images edited with a computer.

- Computer images that cannot be played back will play back if they are added to the camera using the bundled software program ZoomBrowser EX or ImageBrowser.

File name was changed with a computer or file location was changed.

- Set the file name or location to a file format compatible with the camera. (Refer to the *Software Starter Guide* for details).

Movies cannot be edited.

Some movies shot with another camera cannot be edited.

Movies do not play back correctly.

Movies recorded with large recording pixels and high frame rates may momentarily stop playing if played on slow reading memory cards.

You may experience frame dropping when playing back a movie on a computer with insufficient system resources.

$\frac{320}{60}$ Images shot with this camera may not play back properly on other cameras.

Movies recorded at $\frac{320}{60}$ setting and with the video signal set to the PAL format, may play back with a frame rate lower than the recorded one when output to a TV or video. You can play every frame by using the slow motion playback.

- To check the images at the original frame rate, you are recommended to play the movie back on the camera's LCD monitor or viewfinder or on a computer.

Reading images from memory card is slow.

Memory card was formatted in another device.

- Use a memory card formatted in your camera (p. 35).

Battery

Batteries consumed quickly.

Batteries are not the right type.

- Use only unused AA-size alkaline batteries or fully charged Canon AA-size NiMH batteries. See Battery Handling (*Basic Guide* p. 1).

The batteries are cold. Battery performance deteriorates at low temperatures.

- If shooting in a cold area, keep the batteries warm (by placing them in an inner pocket, etc.) until ready to use them.

Battery terminals are dirty.

- Wipe them well with a dry cloth before use.
- Reinsert the batteries several times.

Canon AA-size NiMH batteries consumed quickly.

The batteries have not been used for over a year.

- If batteries are rechargeable: Performance should return to normal after several charging cycles.

Battery life exceeded.

- Replace all 4 batteries with new ones.

TV monitor output

Image not showing on TV monitor.

Incorrect video system setting.	<ul style="list-style-type: none">● Set the video system to the appropriate setting, NTSC or PAL, for your TV (p. 32).
Shooting in Stitch Assist mode.	<ul style="list-style-type: none">● The output will not appear on a TV in Stitch Assist mode. Shoot in a different mode (<i>Basic Guide</i> p. 8).

Direct print compatible printers

Cannot print.

Camera and printer are not properly connected.	<ul style="list-style-type: none">● Make sure the camera and printer are connected properly with the specified cable.
Printer is not turned on.	<ul style="list-style-type: none">● Turn on the printer.
Print connection method is incorrect.	<ul style="list-style-type: none">● Select [Auto] for [Print Method] under the  (Set up) menu (p. 32).

List of Messages

The following messages may appear on the LCD monitor (or viewfinder) during shooting or playback. Please refer to the *Direct Print User Guide* for the messages that display during a printer connection.

Busy...

Image is being recorded to, or read from, memory card.
The playback mode is starting up.
Resetting all the camera and menu settings to default.

No memory card

You turned on the camera without a memory card installed.

Card locked!

The SD card is write-protected. (p. 133)

Cannot record

You attempted to shoot an image without a memory card installed.

Memory card error

Memory card has experienced an anomaly.

Memory card full

Memory card is full of images and no more can be recorded or saved. Or no more image settings can be recorded. Or no more sound memos and sound recorder can be recorded.

Naming error!

The image could not be created because there is an image with the same name as the folder that the camera is attempting to create, or the highest possible file number has already been reached. In the Set up Menu, set the File Numbering option to [Auto Reset]. Save all the images you wish to retain onto a computer, then reformat the memory card (p. 35). Please note that formatting will erase all the existing images and other data.

Change the batteries.

Battery charge is insufficient to operate the camera. Replace all 4 batteries immediately with unused AA-size alkaline batteries or fully charged Canon AA-size NiMH batteries.

No image.

No images recorded on memory card.

Image too large.

You attempted to play back an image larger than 4992 × 3328 pixels or with a large data size.

Incompatible JPEG format.

You attempted to play back an incompatible JPEG image.

Corrupted data.

You attempted to play back an image with corrupted data.

RAW

You attempted to play back a RAW image.

Unidentified Image

You attempted to play back an image that was recorded in a special data type (proprietary data type used by the camera of another manufacturer, etc.) or a movie clip recorded by another camera.

Cannot magnify!

You attempted to magnify an image recorded in a different camera or data type, an image edited with a computer, or a movie.

Cannot rotate

You attempted to rotate an image recorded in a different camera or data type, an image edited with a computer, or a movie.

Incompatible WAVE format.

A sound memo cannot be added to this image because the data type of the existing sound memo or audio is incorrect.

Cannot register this image!

You attempted to register an image recorded in a different camera or a movie as a start-up image.

Cannot modify image

You attempted to apply a My Colors effect to a movie or an image recorded in a different camera.

Cannot transfer!

When transferring images to your computer using the Direct Transfer screen, you attempted to select an image with corrupted data or an image taken with another camera. You may have also attempted to select a movie when [Wallpaper] was selected in the Direct Transfer menu.

Protected!

You attempted to erase or edit a protected image, movie or sound.

Too many marks

Too many images have been marked with print settings, transfer settings, or slide shows. Cannot process any more.

Cannot complete!

Could not completely save the print, transfer or slide show settings.

Unselectable image.

You attempted to set the print settings for a non-JPEG image.

Cannot edit

The file specified for slide show playback is damaged.

Communication error

The computer was unable to download the image due to the large amount of images (approx. 1000) stored on the memory card.

Lens error, restart camera

Camera detected an error while moving the lens and cut the power automatically. This error message may appear if you press on the lens while it is moving or power up the camera in a dusty or sandy environment. Power up the camera again and shoot or playback images. Take the camera to a service center if this message appears frequently because there may be a problem with the lens.

Exx

(xx: number) Camera detected an error. Turn the power off and then back on, then shoot or play back. A problem exists if the error code reappears. Note the number and contact your Canon Customer Support Help Desk. If an error code displays directly after taking a picture, the shot may not have been recorded. Check image in playback mode.

Battery Handling

Battery Charge

The following icon and message will display.



The battery charge is low. If you plan to use the camera for an extended period of time, replace the battery as soon as possible.

Change the batteries

Battery charge is insufficient to operate the camera. Replace the battery immediately.

Battery Handling Precautions

- **Use AA-size alkaline or Canon AA-size NiMH batteries (sold separately) only.**
While it is possible to use AA-size nickel-cadmium batteries, performance is unreliable and their use is not recommended.
- **The operating time of the batteries you purchase may not be as long as the batteries that came with the camera.**
The performance of alkaline batteries may differ according to brand.
- **If you are using the camera in cold areas or for a long time, we recommend using Canon's AA-size NiMH Battery Kit (sold separately).**
Camera operating time may shorten at low temperatures when alkaline batteries are used. Also due to their specifications, alkaline batteries may expire faster than NiMH batteries.
- **Never mix new batteries together with batteries that have been used in other devices.**
The partially used batteries may leak.
- **Be careful to load the batteries with their positive (+) and negative (-) ends in the right direction.**
- **Never mix batteries of different types or from different manufacturers. All four batteries should be identical.**
- **Before inserting the batteries, wipe the battery terminals well with a dry cloth.**
Oil from one's skin or dirtiness may cause a considerable reduction in the number of recordable images or reduce usage time.
- **Battery performance deteriorates at low temperatures, and the battery icon  may display more quickly.**
If you are using the camera in cold areas and batteries are running down faster than they should, you may be able to restore performance by placing batteries in an inner pocket to warm them up prior to use.

- Be careful that you don't put the batteries into a pocket together with a metal key chain or other metallic objects, as these objects may cause batteries to short-circuit.
- If you do not plan to use the camera for a long time, remove the batteries from the camera and store them in a safe place.
Batteries may leak and damage the camera if left installed during prolonged periods of non-use.

⚠ Warning

Never use damaged batteries or batteries whose outer seal is completely or partially missing or peeled off, as there is risk that such batteries may leak, overheat, or burst.

Always check the seals on store-bought batteries before loading them, as some batteries may come with defective seals. Do not use batteries with defective seals.

Never use batteries that look like this.

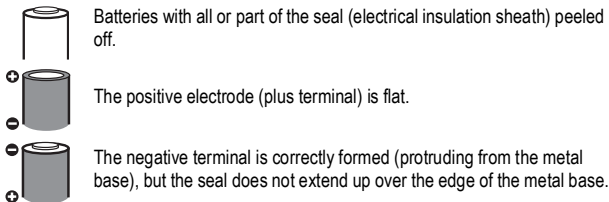

Handling the Memory Card

SD Memory Card (Sold Separately) Write Protect Tab

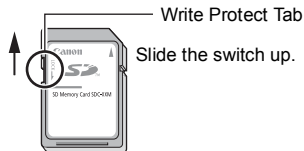

Writing/Erasing Possible

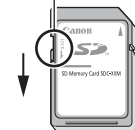

Slide the switch down (you can protect the images and other data on the card)

Writing/Erasing Impossible

Cautions When Handling

- Memory cards are high-precision electronic devices. Do not bend them, apply force to them, or subject them to shocks or vibration.
- Do not attempt to disassemble or alter the memory card.
- Do not allow dirt, water or foreign objects to contact the terminals on the back of the card. Do not touch the terminals with your hands or metal objects.
- Do not peel away the original label on the memory card or cover it with another label or sticker.
- When writing on the memory card, do not use a pencil or ball-point pen. Only use a soft point pen (e.g. felt-tip pen).
- Do not use or store memory cards in the following locations.
 - Locations subject to dust or sand
 - Locations subject to high humidity and high temperatures
- Since some or all of the data recorded on the memory card may be corrupted or erased by electrical noise, static electricity or card/camera malfunction, making a backup copy of important data is recommended.

Formatting

- Please note that formatting (initializing) an memory card erases all data, including protected images and other file types.
- You are recommended to use memory cards that have been formatted in your camera.
 - The card supplied with the camera may be used without further formatting.
 - When the camera is malfunctioning, a corrupted memory card might be the cause. Reformatting the memory card may solve the problem.
 - When a non-Canon brand memory card is malfunctioning, reformatting it may solve the problem.
 - Memory cards formatted in other cameras, computers, or peripheral devices may not operate correctly in this camera. When that happens, reformat the memory card with this camera.
- If formatting in the camera does not work properly, turn the camera off and re-insert the memory card. Then turn the camera back on and format again.

Replacing the Date Battery

If the LCD monitor (or viewfinder) displays the Date/Time menu when you turn on the camera, this means that the date battery has run down and the clock has stopped running. Please purchase a replacement battery (lithium coin battery CR1220) and install it as follows.

The date battery is preinstalled at the factory and may therefore expire earlier than its rated lifespan after the camera has been purchased.

 Be particularly careful to keep the date batteries out of the reach of children. Seek medical assistance immediately if a child swallows a battery since corrosive battery fluids could damage the stomach or intestinal wall.

1 Turn off the power and open the battery cover (*Basic Guide* p. 1).

2 Remove the AA-size batteries, then pull out the battery holder by hooking your fingernail under the bottom of the battery holder edge.

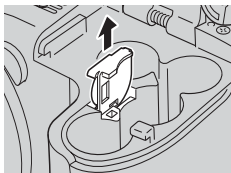

3 Remove the old date battery and place a new date battery into the date battery holder with the positive terminal (+) facing upward.

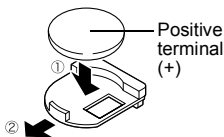

4 Replace the date battery holder, replace the AA-size batteries and close the battery cover.

5 Set the date and time when the Date/Time menu is displayed on the LCD monitor (or viewfinder) (*Basic Guide* p. 4).



The LCD monitor also displays the Date/Time menu the very first time you turn on the camera. This is normal, and you don't need to replace the date battery.

Using Rechargeable Batteries (Sold Separately)

Using Rechargeable Batteries

Battery and Charger Kit CBK4-300

Included are the battery charger and four rechargeable AA-size NiMH (nickel metal hydride) batteries. Charge the batteries as shown below.

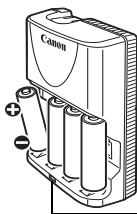

Charge Indicator

- Insert the batteries into the charger before plugging the charger into a power outlet.
- Do not insert additional batteries into the charger once charging begins.

The indicator blinks while charging, then remains lit when charging is finished.



- The Battery Charger CB-5AH/CB-5AHE can only be used with Canon AA-size NiMH batteries NB-3AH and NB-2AH. Do not attempt to charge any other types of batteries.
- Do not mix batteries with different purchase dates or different charge states. When recharging batteries, always recharge all 4 of them at the same time.
- Do not attempt to recharge fully charged batteries, as doing so may reduce or impair battery performance. Also, do not charge batteries for more than 24 consecutive hours.
- Do not recharge batteries in enclosed areas that tend to retain heat.
- Repeatedly recharging batteries before they become fully depleted may cause batteries to lose capacity. Do not recharge the batteries until the LCD monitor (or viewfinder) displays the "Change the batteries" message.
- Wipe the battery terminals well with a dry cloth in the following situations, as the terminals may be soiled with oil from one's skin or dirt:
 - If the battery usage time has considerably diminished.
 - If the number of recordable images has considerably diminished.
 - When charging the batteries (insert and remove the batteries two or three times before charging)
 - When charging completes in a matter of a few minutes (the battery charger indicator remains lit)
- You may not be able to fully charge the batteries due to their specifications right after purchase or after long periods of non-use. If this happens, use the batteries until their charge is depleted before charging them again. After doing this several times, battery performance will be restored.
- Since storing a fully charged battery for long periods of time (about one year) can shorten its lifecycle or affect performance, you are recommended to use the battery in the camera until it is completely discharged and to store it at normal temperature (0 - 30 °C (32 - 86 °F) or less). If you do not use the battery for long periods of time, charge it fully and discharge it fully in the camera at least once a year before returning it to storage.

Continued on next page

- If battery usage time is considerably low despite their terminals' being wiped and the battery charger's indicator remaining lit, it is possible that the batteries have reached the end of their lifespan. Switch to different, unused batteries. If you are purchasing new batteries, look for Canon AA-size NiMH NB4-300 (NB-3AH set of 4) batteries.
- Leaving batteries in the camera or charger may damage it causing battery leakage. Remove batteries from the camera or charger and store in a dry cool location when not in use.



- It takes approximately 4 hours 40 minutes for the charger to fully recharge them (as determined by testing at Canon facilities). Please do not charge batteries in areas where the temperature is outside the range of 0 to 35 °C (32 to 95 °F).
- Charging time varies according to ambient temperature and to the batteries' initial charge state.
- The battery charger may emit noise while charging. This is not a malfunction.
- You can also use Battery/Charger Kit CBK4-200.

Using a Compact Power Adapter Kit (Sold Separately)

You should use the separately sold Compact Power Adapter CA-PS700 when using the camera for long periods of continuous use or for connecting to a computer or printer.



Turn the camera power off (*Basic Guide* p. 3) before connecting or disconnecting the compact power adapter.

- 1 Connect the power cord to the compact power adapter first and then plug the other end into the power outlet.**

Plug in the power cord firmly as far as it will go.

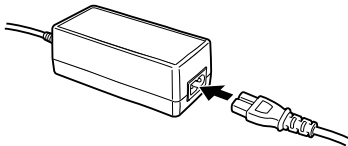

- 2 Open the terminal cover and connect the DC plug of the compact power adapter to the camera's DC IN terminal.**

Always disconnect and unplug the compact power adapter after use.

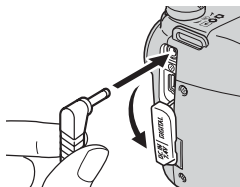

Using Conversion Lenses (Sold Separately)

When attaching the Wide Converter WC-DC58A, Tele-converter TC-DC58B, and Close-up Lens 500D (58 mm) (each sold separately) you also need the Conversion Lens Adaptor LA-DC58E (included with the separately sold Lens Adaptor/Hood Kit LAH-DC20).



- When attaching the wide converter, tele-converter or close-up lens, be sure to screw it on securely. If they come loose, they may fall from the lens adapter, posing risk of injury from shattered glass.
- Never look into the sun or into strong light through the wide converter, tele-converter or close-up lens as this can result in blindness or impairment of vision.
- If the built-in flash is used with the lens hood attached, the outer edges of shot images (especially the lower right) may be darkened.
- When using the wide converter, set the camera to the maximum wide angle.
- When using the tele-converter, set the camera near the maximum telephoto. At other zoom settings, the image will appear as if its corners have been cut off.

Wide Converter WC-DC58A

Use this converter for taking wide-angle shots. The wide converter changes the focal length of the camera body's lens by a factor of approximately 0.75x (the thread diameter is 58 mm).

Tele-converter TC-DC58B

This lens is used for taking telephoto shots. The lens changes the focal length of the camera body's lens by a factor of approximately 1.5x. (the thread diameter is 58 mm).



It is not possible to attach a lens hood or filter to the wide converter or tele-converter.

Close-up Lens 500D (58 mm)

This lens makes macro shooting easy. You can take normal shots 28 to 50 cm (11 in. - 1.6 ft.) between the front of the lens and the subject with wide-angle and 35 to 50 cm (1.1 - 1.6 ft.) with telephoto in macro mode.

Shooting Area

	Distance between the front of the lens and the subject	Shooting area
Wide	28 cm (11.0 in.)	276 × 207 mm (11 × 8.1 in.)
Tele	35 cm (1.1 ft.)	34 × 26 mm (1.3 × 1.0 in.)

Lens Adapter/Hood Kit LAH-DC20

- Conversion Lens Adapter LA-DC58E

This is a lens adapter required for attaching the wide converter, tele-converter and close-up lens (58 mm thread diameter).

- Lens Hood LH-DC40

We recommend attaching the lens hood to prevent light from outside of the screen from entering the lens when shooting with wide-angle and backlight without a flash.

Attaching a Lens/Lens Hood

1 Be sure that the camera is turned off.

2 Press the ring release button and hold it down, and turn the ring in the direction of the arrow (①). When the ● mark on the camera and the ● mark on the ring are aligned, pull off the ring (②).

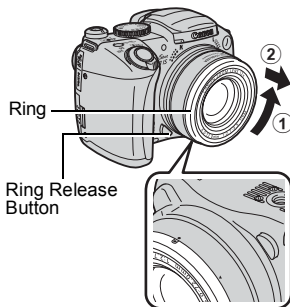

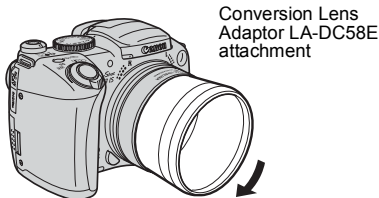

-
- 3** Align the ● mark on the conversion lens adapter with the ● mark on the camera, and turn the adapter in the direction of the arrows as far as the ▲ mark on the camera.

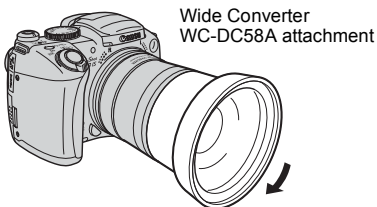

- To remove the conversion lens adapter (lens hood or conversion lens), turn the adapter in the opposite direction with holding down the ring release button.

-
- 4** Set the lens or lens hood on the adapter, and turn it in the indicated direction to attach it securely.



-
- !**
- Completely remove all dust and dirt from conversion lenses with a lens blower brush before use. The camera may focus on any dirt that remains.
 - Be careful when handling the lenses since it is easy to get finger prints on them.
 - Be careful not to drop the camera or adapter when removing the ring.
 - When using these lens attachments, you should not shoot images in  (Stitch Assist) mode. It will not be possible to use the PhotoStitch software from your computer to accurately stitch the images together.

Converter Settings

Set the camera appropriately after attaching the Wide Converter WC-DC58A or the Tele-converter TC-DC58B (no setting is needed for the 500D Close-Up lens).

1  (Rec.) Menu → [Converter] → [Off]*/[WC-DC58A]/[TC-DC58B].

See *Menus and Settings* (p. 27)

- Select the attached converter.

* Default setting.



When you remove the converter from the camera, return the converter setting to [Off].

Using an Externally Mounted Flash (Sold Separately)

High-Power Flash HF-DC1

This flash is used to supplement the camera's built-in flash when the subject is too far away for proper illumination. Use the following procedures to affix the camera and High-Power Flash to the supporting bracket.

Please read the instructions accompanying the flash along with this explanation.

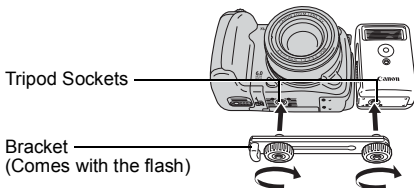



- The High-Power Flash will not fire in the **M**, **Tv**, or **Av** shooting mode when the automatic flash control is turned off (p. 82).
- The flash charge time will lengthen as the battery charge gets weaker. Always set the power/mode switch to [OFF] when you finish using the flash.
- Be careful not to touch the flash window or sensor windows with your fingers while the flash is in use.
- The flash may fire if another flash is being used in close proximity.
- The High-Power Flash may not fire outdoors in daylight or when there are no reflective items.
- For continuous shooting, although the flash fires for the first shot, it does not fire for subsequent shots.
- Fasten the attachment screws securely so that they do not loosen. Failure to do so may lead to the dropping of the camera and flash resulting in damage to both.



- Before attaching the bracket to the flash, check that the lithium battery (CR123A or DL123) is installed.
- To illuminate the subjects properly, install the flash so that it is up against the side of the camera and parallel with the camera's front panel.
- A tripod can be used even when the flash is attached.

Batteries

● Charge becomes Severely Limited

If the battery usage time has considerably diminished, wipe the battery terminals well with a dry cloth. The terminals may be soiled with oil from one's skin or other dirt.

● Usage in Cold Temperatures (Less than 0°C/32°F)

Get a spare generic lithium battery (CR123A or DL123). You are recommended to place the spare battery in your pocket to warm it up before switching it for the battery in the flash.

● Non-Use over Extended Periods

Leaving batteries in the High-Power Flash could allow the battery fluid to leak, damaging the product. Remove the batteries from the High-Power Flash and store them in a cool, dry place.

Camera Care and Maintenance

If the camera, lenses, viewfinder or LCD monitor become dirty, use the following cleaning methods.

Never use thinners, benzine, synthetic cleansers or water to clean the camera. These substances may distort or damage the equipment.

Camera Body

Gently wipe dirt off the camera body with a soft cloth or eyeglass lens wiper.

Lens

First use a lens blower brush to remove dust and dirt, then remove any remaining dirt by wiping the lens lightly with a soft cloth.



Never use synthetic cleansers on the camera body or lens. If dirt remains, contact the closest Canon Customer Support Help Desk as listed on the rear of the European Warranty System (EWS) Booklet.

Viewfinder and LCD Monitor

Use a lens blower brush to remove dust and dirt. If necessary, gently wipe with a soft cloth or an eyeglass lens wiper to remove stubborn dirt.



Never rub or press strongly on the LCD monitor. These actions may damage it or lead to other problems.

Specifications

All data is based on Canon's standard testing methods. Subject to change without notice.

PowerShot S3 IS

Camera Effective Pixels	Approx. 6.0 million
Image Sensor	1/2.5 -inch type CCD (Total number of pixels: Approx 6.2 million)
Lens	6.0 (W) - 72.0 (T) mm (35mm film equivalent: 36 - 432 mm) f/2.7 (W) - f/3.5 (T)
Digital Zoom	Approx. 4.0x (Up to approx. 48x in combination with the optical zoom)
Viewfinder	Color LCD viewfinder Picture coverage rate 100% Dioptric Adjustment -5.5 - +1.5 m ⁻¹ (dpt.)
LCD Monitor	2.0 inch, low-temperature polycrystalline silicon TFT (vari-angle type) color LCD (Approx. 115,000 pixels, picture coverage 100%)
AF System	TTL autofocus (continuous or single) Focus lock and Manual focus are available Focusing frame: 1-point AF (fixed to center or FlexiZone AF)
Shooting Distance (from tip of lens)	Normal AF: 50 cm (1.6 ft.) - infinity (W)/ 90 cm (3.0 ft.) - infinity (T) Macro: 10 - 50 cm (3.9 in. - 1.6 ft. (W)) Super Macro: 0 - 10 cm (0 - 3.9 in.) (W only)
Shutter	Mechanical shutter + electronic shutter
Shutter Speeds	15 - 1/3200 sec. <ul style="list-style-type: none">• The shutter speed varies according to the shooting mode.• Shutter speeds of 15 to 1.3 sec. are available in Shutter priority mode or Manual mode.• Slow shutter speeds of 15 to 1.3 sec. or slower operate with noise reduction.
Light Metering System	Evaluative, Center-weighted average or Spot (Center or AF-point)

(W): wide angle (T): telephoto

Exposure Compensation	± 2.0 stops in 1/3-stop increments Auto exposure bracketing (AEB) and Safety Shift is available.
ISO Speed	Auto*, High ISO Auto*, ISO 80/100/200/400/800 equivalent * The camera automatically selects the optimal speed when Auto or High ISO Auto is set.
White Balance	TTL auto, Daylight, Cloudy, Tungsten, Fluorescent, Fluorescent H, Flash or custom
Built-in Flash	Auto*, on*, off * Red-eye reduction is available. FE lock, Slow synchro and 1st-curtain/2nd-curtain flash are available.
Flash Range	Normal: 50 cm - 5.2 m (1.6 - 17 ft.) (W)/ 90 cm - 4.0 m (3.0 - 13 ft.) (T) Macro: 30 - 50 cm (12 in. - 1.6 ft.) (W) (ISO speed = Auto)
Flash Exposure Compensation	± 2.0 stops in 1/3-stop increments
Flash Output*	3 stops * Can be set when flash exposure setting is [Off]
Shooting Modes	Auto Creative zone: Program, Shutter-speed priority, Aperture priority, Manual, Custom Image zone: Portrait, Landscape, Night scene, Sports, Special Scene*, Stitch Assist, Movie * Foliage, Snow, Beach, Fireworks, Color Swap, Color Accent, Night Snapshot, Indoor
Continuous shooting	Approx. 1.5 shots/sec. (Large/Fine mode) Approx. 2.3 shots/sec. (High-speed continuous shooting, Large/Fine mode)
Intervalometer	Shooting interval: approx. 1 - 60 min. (1-min. increments) Number of shots: 2 - 100 shots (Maximum number of shots varies according to memory card capacity.)
Self-timer	Activates shutter after an approx. 10-sec./approx. 2- sec. delay, Custom Timer
PC-controlled Shooting	Available (USB connection only. Exclusive software program is included in the camera kit.)
Recording Media	SD memory card/MultiMediaCard

(W): wide angle (T): telephoto

File Format	Design rule for camera file system and DPOF compliant
Number of Recording Pixels (Still Images)	Exif 2.2 (JPEG) ^{*1} Sound Memo, Sound Recorder: WAVE (stereo)
(Movies)	AVI (Image data: Motion JPEG; Audio data: WAVE (stereo))
Compression	Super fine, Fine, Normal
Recording Pixels (Still Images)	Large: 2816 × 2112 pixels Medium 1: 2272 × 1704 pixels Medium 2: 1600 × 1200 pixels Small: 640 × 480 pixels Wide: 2816 × 1584 pixels
Movie Recording Pixels/ Frame Rate	640 × 480 pixels (30 frames/sec.) 640 × 480 pixels (15 frames/sec.) 320 × 240 pixels (60 frames/sec.) 320 × 240 pixels (30 frames/sec.) 320 × 240 pixels (15 frames/sec.) Recording can continue until the memory card is full* (Max. Clip Size at one time: 1 GB)** * Using super high-speed memory cards (SDC-512MSH recommended). ** Even if the clip size has not reached 1 GB, recording will stop at the moment the clip length reaches 1 hour. Depending on the volume and data writing speed of the memory card, recording will stop before reaching 1 hour or before the recorded data volume has reached 1 GB.
Audio	Sampling frequency: 44.100/11.025/22.050 kHz Quantization bit: 16 bit
Playback Modes	Single (histogram displayable), Index (9 thumbnail images) Magnified (approx. 10x max. in LCD monitor or viewfinder, forward or reverse selection through magnified images possible), Jump (it is possible to jump to every tenth or hundredth image, to the first image of each shooting date, to movies or to the first image in each folder. In index playback mode, it displays 9 images at once.), Slide Show, My Colors Sound memos (up to 1 min. recording/playback) Movie (editing/slow-motion playback possible) Sound recorder (up to 2 hrs. of recording/playback of sound only)

(W): wide angle (T): telephoto

Custom Display Function	Display location: LCD monitor (2), viewfinder (2) Displayed information: shooting info*, grid lines*, histogram* * You can enable/disable display of this information for each of the display locations.
Direct Print	PictBridge compliant, Canon Direct Print, and Bubble Jet Direct compatible
My Camera settings	Start-up image, start-up sound, operation sound, self-timer sound, and shutter sound
Interface	USB 2.0 Hi-Speed (mini-B), PTP [Picture Transfer Protocol] Audio/Video output (NTSC or PAL selectable, stereo audio)
Power Source	AA alkaline batteries (included in the camera kit) AA NiMH batteries (NB4-300) (sold separately) Compact Power Adapter (CA-PS700) (sold separately)
Operating Temperatures	0 - 40 °C (32 - 104 °F)
Operating Humidity	10 - 90%
Dimensions (excluding protrusions)	113.4 × 78.0 × 75.5 mm (4.46 × 3.07 × 2.97 in.)
Weight (camera body only)	Approx. 410 g (14.5 oz.)

(W): wide angle (T): telephoto

*1 This digital camera supports Exif 2.2 (also called "Exif Print"). Exif Print is a standard for enhancing the communication between digital cameras and printers. By connecting to an Exif Print-compliant printer, the camera's image data at the time of shooting is used and optimized, yielding extremely high quality prints.

Battery Capacity

	Number of Images Shot		Playback Time
	LCD Monitor ON (Based on the CIPA standard)	Viewfinder ON	
AA Alkaline Batteries (included with the camera)	Approx. 110 images	Approx. 110 images	Approx. 13 hours
AA NiMH Battery (NB-3AH) (full charge)	Approx. 550 images	Approx. 570 images	Approx. 15 hours

- The actual figures will vary according to the shooting conditions and settings.
- Movie data is excluded.
- At low temperatures, the battery performance may diminish and the low battery icon may appear very rapidly. In such a case, the performance can be improved by warming the batteries in your pocket before use.

Test Conditions

Shooting: Normal temperature ($23\text{ }^{\circ}\text{C} \pm 2\text{ }^{\circ}\text{C}/73\text{ }^{\circ}\text{F} \pm 3.6\text{ }^{\circ}\text{F}$), normal relative humidity ($50\% \pm 20\%$), alternating max. wide angle and max. telephoto shots at 30 second intervals with the flash fired once every two shots and the camera power turned off after every tenth shot. Power is left off for a sufficient amount of time*, then the power is turned back on and the testing procedure is repeated.

- A Canon-brand memory card is used.

* Until the battery returns to normal temperature

Playback: Normal temperature ($23\text{ }^{\circ}\text{C} \pm 2\text{ }^{\circ}\text{C}/73\text{ }^{\circ}\text{F} \pm 3.6\text{ }^{\circ}\text{F}$), normal relative humidity ($50\% \pm 20\%$), continuous playback at 3 seconds per image.



















See Battery Handling Precautions (p. 132).

Memory Cards and Estimated Capacities

Still Images

 : Card included with the camera





		16MB	SDC-128M	SDC-512MSH
L (Large) 2816 × 2112 pixels		4	45	176
		8	75	292
		17	156	603
M1 (Medium 1) 2272 × 1704 pixels		6	61	237
		12	109	425
		24	217	839
M2 (Medium 1) 1600 × 1200 pixels		13	121	471
		24	217	839
		46	411	1590
S (Small) 640 × 480 pixels		52	460	1777
		80	711	2747
		127	1118	4317
W (Wide) 2816 × 1584 pixels		6	60	235*
		11	101	392
		23	205	794

 Capable of smooth continuous shooting (p. 42). (Only available when card has been formatted with a low level format.)

* This reflects standard shooting criteria established by Canon. Actual results may vary according to the subject and shooting conditions.

Movies









: Card included with the camera

Modes	Recording Pixels/ Frame Rate	16MB	SDC-128M	SDC-512MSH
	640 × 480 pixels/ 30 frames/sec.	6 sec.	1 min. 4 sec.	4 min. 9 sec.
	640 × 480 pixels/ 15 frames/sec.	14 sec.	2 min. 7 sec.	8 min. 14 sec.
	320 × 240 pixels/ 60 frames/sec.	10 sec.	1 min. 32 sec.	5 min. 59 sec.
	320 × 240 pixels/ 30 frames/sec.	20 sec.	3 min. 1 sec.	11 min. 42 sec.
	320 × 240 pixels/ 15 frames/sec.	40 sec.	5 min. 55 sec.	22 min. 53 sec.





* The durations shown on the table are the maximum recording lengths when the audio sampling rate set to 44.100kHz and shooting takes place continuously.

Image Data Sizes (Estimated)

Still Images

Recording Pixels		Compression		
				
	2816 × 2112 pixels	2720 KB	1620 KB	780 KB
	2272 × 1704 pixels	2002 KB	1116 KB	556 KB
	1600 × 1200 pixels	1002 KB	558 KB	278 KB
	640 × 480 pixels	249 KB	150 KB	84 KB
	2816 × 1584 pixels	2026 KB	1210 KB	585 KB

Movies

Modes	Recording Pixels	Frame Rate	File size
	640 × 480 pixels	30 frames/sec.	1980 KB/sec.
	640 × 480 pixels	15 frames/sec.	990 KB/sec.
	320 × 240 pixels	30 frames/sec.	660 KB/sec.
	320 × 240 pixels	15 frames/sec.	330 KB/sec.
	320 × 240 pixels	60 frames/sec.	1320 KB/sec.

SD Memory Card (Sold Separately)

Interface	Compatible with SD memory card standards
Dimensions	32.0 × 24.0 × 2.1 mm (1.3 × 0.9 × 0.1 in.)
Weight	Approx. 2 g (0.07 oz.)

MultiMediaCard

Interface	Compatible with MultiMediaCard standards
Dimensions	32.0 × 24.0 × 1.4 mm (1.3 × 0.9 × 0.1 in.)
Weight	Approx. 1.5 g (0.05 oz.)

Compact Power Adapter CA-PS700 (Sold Separately)

Rated Input	AC 100 - 240 V (50 / 60 Hz)
Rated Output	DC 7.4 V / 2.0 A
Operating Temperatures	0 - 40 °C (32 - 104 °F)
Dimensions	112.0 × 29.0 × 45.0 mm (4.4 × 1.1 × 1.8 in.) (camera body only)
Weight	Approx. 185 g (6.5 oz.)

Battery Charger CB-5AH/CB-5AHE (Sold Separately)

(Included with the separately sold Battery/Charger Kit CBK4-300)

Rated Input	AC 100 - 240 V (50 / 60 Hz) 16 VA (100 V) - 21 VA (240 V)
Rated Output	565 mA ^{*1} , 1275 mA ^{*2}
Charging time	Approx. 4 hours 40 min. ^{*1} , Approx. 2 hours ^{*2}
Operating Temperatures	0 - 35 °C (32 - 95 °F)
Dimensions	65.0 × 105.0 × 27.5 mm (2.6 × 4.1 × 1.1 in.)
Weight	Approx. 95 g (3.4 oz.)

*1 When using 4 NiMH NB-3AH batteries.

*2 When using 2 NiMH NB-3AH batteries, one at each end of the charger.

NiMH Battery NB-3AH (Sold Separately)

(Included with the separately sold NiMH NB4-300 or the Battery/
Charger Kit CBK4-300)

Type	AA-size rechargeable nickel hydride battery
Nominal Voltage	DC 1.2 V
Typical Capacity	2500 mAh (Lowest: 2300 mAh)
Cycle Life	Approx. 300 (estimated)
Temperatures	0 - 40 °C (32 - 104 °F)
Dimensions	Diameter: 14.5 mm (0.6 in.) Length: 50.0 mm (2.0 in.)
Weight	Approx. 30 g (1.06 oz.)

Wide Converter WC-DC58A (Sold Separately)

Magnification	Approx. 0.75
Focal Length	27 mm (35mm film equivalent)
Lens composition	3 elements in 3 groups
Shooting Distance (from tip of lens)	28 cm - infinity (11 in. - infinity)
Thread Diameter	58 mm standard filter thread (Conversion Lens Adapter LA-DC58E is required for mounting to PowerShot S3 IS)
Dimensions	Diameter: 79.0 mm (3.1 in.) Length: 39.3 mm (1.5 in.)
Weight	Approx. 170 g (6.0 oz.)

Tele-converter TC-DC58B (Sold Separately)

Magnification	Approx. 1.5
Focal Length	648 mm (35mm film equivalent)
Lens composition	5 elements in 3 groups
Shooting Distance (from tip of lens)	2.0 m (6.6 ft.) - infinity
Thread Diameter	58 mm standard filter thread (Conversion Lens Adapter LA-DC58E is required for mounting to PowerShot S3 IS)
Dimensions	Diameter: 72.0 mm (2.8 in.) Length: 64.8 mm (2.6 in.)
Weight	Approx. 170 g (6.0 oz.)

Conversion Lens Adapter LA-DC58E

(Included with the separately sold Lens Adapter/Hood Set LAH-DC20)

Thread Diameter	58 mm standard filter thread
Dimensions	Diameter: 63.0 mm (2.5 in.) Length: 43.1 mm (1.7 in.)
Weight	Approx. 19 g (0.67 oz.)

Lens Hood LH-DC40

(Included with the separately sold Lens Adapter/Hood Set LAH-DC20)

Thread Diameter	58 mm standard filter thread
Dimensions	Diameter: 79.0 mm (3.1 in.) Length: 31.5 mm (1.2 in.)
Weight	Approx. 19 g (0.67 oz.)

Close-up Lens 500D (58 mm) (Sold Separately)

Shooting distance (from tip of lens)	28 - 50 cm (11 in. - 1.6 ft.) (W) 35 - 50 cm (1.1 - 1.6 ft.) (T)
Thread diameter:	58 mm standard filter thread (Conversion Lens Adapter LA-DC58E is required for mounting to PowerShot S3 IS)
Dimensions:	Diameter: 60 mm (2.4 in.) Length: 10.5 mm (1.7 in.)
Weight:	Approx. 60 g (2.1 oz.)

INDEX

A

Adjusting the Exposure Compensation	75
AE Lock	70
AEB Mode	76
AF Frame (☒)	63
AF Lock	64
AF Mode	67
AF-assist Beam	12, 28
Aperture Value	59
Audio	50
Auto Power Down	23, 31
Auto Rotate	32, 87
Automated Playback (Slide Shows)	105

C

Camera Care	145
Color Accent Mode	53
Color Swap Mode	54
Compression	36
Continuous Shooting	42
Creative Zone	57

D

Date/Time	31
DCF	22, 148
Detailed Display	22
DIGITAL Terminal	12
Digital Zoom	29, 41
DISP.	15
Display Off	31
DPOF	111
Print Settings	111
Transfer Settings	114

E

Effects (Playback)	99
Erasing	
Erasing All Images	110
Erasing All Images	110

F

FE Lock	72
File Number	21, 32, 90
Flash	12
Flash Adjustment	82
Flash Sync	28, 83
Focus	64
Focus Bracketing	68
Focus Lock	64
Folder	88
Format	31, 35
Frame Rates	48
FUNC.	15

G

Grid Line	20, 29
-----------------	--------

H

Histograms	19
------------------	----

I

Intervalometer	29, 84
ISO Speed	69

J

Jumping (☒)	94
-------------------	----

L

Language	32
LCD Brightness	31
LCD Monitor	14
List of Messages	129

M

Magnified Images (Q)	92
Manual Aperture	60
Manual Focus (MF)	66
Memory Card	
Format	35
MENU	15

Menu

Menu Item	28
My Camera Menu	33
Play Menu	30
Print Menu	30
Rec. Menu	28
Set up Menu	31

Metering Mode	28, 73
---------------	--------

MF	66
----	----

MF-Point Zoom	28, 66
---------------	--------

Mic Level	50
-----------	----

Microphone	12
------------	----

Movie

Shooting	46
----------	----

Mute	31
------	----

My Camera Menu	33
----------------	----

My Camera Settings	117
--------------------	-----

My Colors	80, 100
-----------	---------

N

Night Display	19
---------------	----

O

Omni Selector	15
---------------	----

Operation Sound	31, 33
-----------------	--------

Overexposure Warning	23
----------------------	----

P

Panoramic Image	51
-----------------	----

Playback

Viewing Images on a TV set	116
-------------------------------	-----

Playback Vol.	31
---------------	----

Power Saving	23, 31
--------------	--------

Printing

Print Order	111
-------------	-----

Print/Share (🖨️)	15
------------------	----

Program AE	57
------------	----

Protecting	109
------------	-----

R

Recording Pixels	36
------------------	----

Recording Volume	51
------------------	----

Red-eye Reduction	12, 28
-------------------	--------

Reset All	34
-----------	----

Review	29
--------	----

Using a TV	116
------------	-----

Rotating	98
----------	----

S

Safety Shift	60
--------------	----

Sampling Rate	51
---------------	----

Save Settings	86
---------------	----

SD memory cards	1
-----------------	---

Self-Timer (⌚)	28, 43
----------------	--------

Selftimer Sound	33
-----------------	----

Set Shortcut button	29, 62
---------------------	--------

Shooting Mode	16
---------------	----

Shortcut Button (🔑)	61
---------------------	----

Shutter Button	14
----------------	----

Shutter Sound	31, 33
---------------	--------

Shutter Speed-priority

AE Mode (Tv)	58
--------------	----

Shutter Speed	59
---------------	----

Slide Shows	105
-------------	-----

Slow Synchro	28, 38
--------------	--------

Smooth Continuous Shooting .	42
Sound Memos (🎤)	102
Sound Mode	50
Sound Recorder	103
Speaker	14
Start-up Image	33
Start-up Sound	31, 33
Stitch Assist	51
Super Macro	40

T

Tally Lamp	12
Telephoto (📷)	14, 41, 92
Terminal Cover	14
Time Zone	24

V

Video Output Signal	116
Video System	32
Viewfinder	15
Volume	31

W

White Balance	77
Wind Filter	50
World Clock	24

Z

Zoom	14, 41, 92
----------------	------------

Disclaimer

- While every effort has been made to ensure that the information contained in this guide is accurate and complete, no liability can be accepted for any errors or omissions.
- Canon reserves the right to change the specifications of the hardware and software described herein at anytime without prior notice.
- No part of this guide may be reproduced, transmitted, transcribed, stored in a retrieval system, or translated into any language in any form, by any means, without the prior written permission of Canon.
- Canon makes no warranties for damages resulting from corrupted or lost data due to a mistaken operation or malfunction of the camera, the software, SD memory cards (SD cards), personal computers, peripheral devices, or use of non-Canon SD cards.

Trademark Acknowledgments

- Macintosh, Mac OS and QuickTime are trademarks of Apple Computer Inc., registered in the United States and/or other countries.
- Microsoft® and Windows® are either registered trademarks or trademarks of Microsoft Corporation in the United States and/or other countries.
- SD is a trademark.
- Other names and products not mentioned above may be registered trademarks or trademarks of their respective companies.

Copyright © 2006 Canon Inc. All rights reserved.

Functions Available in Each Shooting Mode

The chart below is a reference for the settings available for various shooting conditions. The settings selected in each shooting mode are saved after you finish shooting.

You can shoot with the settings saved in the **C** mode (p. 86).

		AUTO	SCN				P	Tv	Av	M
Recording Pixels (Still Image) p. 36	Large	L	●	●	●	▲	●	●	●	●
	Medium 1	M1	○	○	○	△	○	○	○	○
	Medium 2	M2	○	○	○	△	○	○	○	○
	Small	S	○	○	○	△	○	○	○	○
	Wide	W	○	○	○	-	○	○	○	○
Compression p. 36	Super Fine		○	○	○	△	○	○	○	○
	Fine		●	●	●	▲	●	●	●	●
	Normal		○	○	○	△	○	○	○	○
Movie Recording Pixels/Frame Rate ⁽¹⁾ p. 48			○	○	○	△	○	○	○	○
Flash Basic p. 11	Auto		●	● ⁽²⁾	● ⁽³⁾	-	-	●	-	-
	On		-	○ ⁽²⁾	○ ⁽³⁾	△	-	○	○	○
	Off		○	○	○	△	-	○	○	○
Red-Eye Reduction Basic p. 11			●	● ⁽²⁾	● ⁽³⁾	▲	-	●	●	●
Slow Synchro p. 38			-	- ⁽⁴⁾	● ⁽⁵⁾	△	-	○	-	○
Flash Adjust p. 82			● ⁽⁶⁾	● ⁽⁶⁾ ⁽⁷⁾	● ⁽⁶⁾	● ⁽⁶⁾	-	● ⁽⁶⁾	●	●
Flash firing p. 83	1st-curtain		●	● ⁽²⁾	● ⁽³⁾	●	-	●	●	●
	2nd-curtain		-	-	-	-	-	○	○	○
Drive Mode pp. 42, 43	Single		●	●	● ⁽⁸⁾	●	●	●	●	●
	Standard Continuous Mode p. 42		-	● ⁽⁷⁾	●	-	-	●	●	●
	High-speed continuous shooting p. 43		-	○ ⁽⁷⁾	○ ⁽³⁾	-	-	○	○	○
	10-sec. self-timer p. 42		●	●	● ⁽³⁾	●	●	●	●	●
	2-sec. self-timer		○	○	○ ⁽³⁾	○	○	○	○	○
	Custom Timer		○	○ ⁽⁷⁾	○ ⁽³⁾	-	-	○	○	○
Intervalometer p. 84			-	-	-	-	-	○	○	○

		AUTO	SCN			P	Tv	Av	M
AF Frame p. 63	Center Point	●	●	●	●	●	●	●	●
	Manual	-	-	-	-	○	○	○	○
AF Lock p. 65		-	○(2)	○	○	○	○	○	○
Manual Focus p. 66		-	○(2)	○(3)	○	○	○	○	○
MF-Point Zoom p. 66		-	●(2)	●(3)	-	-	●	●	●
AF-assist Beam p. 28		●	●(2)	●(3)	●	●	●	●	●
Macro Basic p. 12	Macro	○	○(2)	○(9)	○	-	○	○	○
	Super Macro	-	○(10)	-	-	○	○	○	○
Digital Zoom p. 41		○	○(7)	○	-	●	○	○	○
Safety Shift p. 60		-	-	-	-	-	-	○	-
Exposure Compensation p. 75		-	○(7)	○	△	- (11)	○	○	○
ISO Speed p. 69	ISO	○(12)	- (13)	- (13)	- (13)	- (13)	○	○(14)	○(15)
White Balance ⁽¹⁶⁾ p. 77		WB	- (13)	- (13)	○(18)	△(17)	○(18)	○	○
Metering Method p. 73	Evaluative	●	●	●	▲	●	●	●	●
	Center-Weighted Average Metering	-	-	-	-	-	○	○	○
	Spot	-	-	-	-	-	○	○	○
	Center	-	-	-	-	-	●	●	●
	AF Point	-	-	-	-	-	○	○	○
AE Lock/FE Lock pp. 70, 72		-	-	-	-	○(19)	○	○	-
Bracket	AEB p. 76	-	-	-	-	-	○	○	-
	Focus-BKT p. 68	-	-	-	-	-	○	○	○
My Color p. 80		-	-	-	△	○(20)	○	○	○
Focus Settings p. 67	Continuous	●	●(2)	●	▲	●	●	●	●
	Single	○	○	○(3)	△	-	○	○	○
Save Original p. 56		-	○(10)	-	-	-	-	-	-
Reverse Disp. p. 29		○	○	○	-	○	○	○	○
Custom Display pp. 17, 29		○	○	○	○	○	○	○	○
Grid Lines pp. 17, 29		○	○	○	○(21)	○	○	○	○
Histogram pp. 17, 29		○(21)	○(21)	○(21)	○(21)	○(21)	○	○	○
Auto Rotate p. 87		●	●	●	●	-	●	●	●





















○: Setting available (●: Default setting) △: Setting can only be selected for the first image.
 (▲: Default setting) - : Setting selection is not possible.

● Setting is remembered even when the camera power is shut off.

● With the exception of the [Time Zone], [Date/Time], [Language], and [Video System] settings, all the other menu settings and changes made with the camera buttons can be reset to the default values in a single operation (p. 34).

(1) The following are the recording pixels and frame rates for  (Movie).

Movie Recording Pixels/Frame Rate	640 × 480 pixels × 30 frames/sec.	●
	640 × 480 pixels × 15 frames/sec.	○
	320 × 240 pixels × 60 frames/sec.	○
	320 × 240 pixels × 30 frames/sec.	○
	320 × 240 pixels × 15 frames/sec.	○

- (2) This cannot be set in  mode.
- (3) This cannot be set in  mode.
- (4) [On] only in Night Scene mode ([Off] cannot be set).
- (5) [Off] cannot be set. Also [On] cannot be set in the  or  modes.
- (6) [Off] cannot be set.
- (7) This cannot be set in  or  modes.
- (8) Continuous shooting is the default setting in .
- (9) This cannot be set in  or  modes.
- (10) Only  and  can be set.
- (11) Exposure shift can be set after AE lock.
- (12) Only switching between  and  is available.
- (13) Automatically set by the camera.
- (14)  cannot be set.
- (15)  or  cannot be set.
- (16) This cannot be set when My Colors is set to Sepia or B/W.
- (17) White balance data cannot be read in Manual.
- (18)  cannot be set in  or  mode.
- (19) FE lock cannot be selected in the  modes.
- (20) Custom Color cannot be set.
- (21) This can be set, but cannot be displayed.

Canon