

Nikon

DIGITAL CAMERA

COOLPIX L18/L16

User's Manual

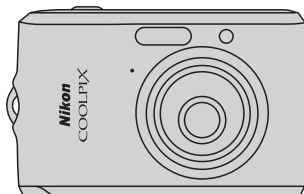

En

Trademark Information

- Microsoft, Windows and Windows Vista are either registered trademarks or trademarks of Microsoft Corporation in the United States and/or other countries.
- Macintosh, Mac OS, and QuickTime are trademarks of Apple Inc.
- Adobe and Acrobat are registered trademarks of Adobe Systems Inc.
- The SD logo is a trademark of the SD Card Association.
- PictBridge is a trademark.
- All other trade names mentioned in this manual or the other documentation provided with your Nikon product are trademarks or registered trademarks of their respective holders.

Introduction

First Steps



Basic Photography and Playback: Easy Auto Mode



Auto Mode



Shooting Suited for the Scene



More on Playback



Movies

Connecting to Televisions, Computers and Printers

MENU Shooting, Playback and Setup Menus

Technical Notes

For Your Safety

To prevent damage to your Nikon product or injury to yourself or to others, read the following safety precautions in their entirety before using this equipment. Keep these safety instructions where all those who use the product will read them. The consequences that could result from failure to observe the precautions listed in this section are indicated by the following symbol:



This icon marks warnings, information that should be read before using this Nikon product to prevent possible injury.

WARNINGS

Turn off in the Event of Malfunction

Should you notice smoke or an unusual smell coming from the camera or AC adapter, unplug the AC adapter and remove the batteries immediately, taking care to avoid burns. Continued operation could result in injury. After removing or disconnecting the power source, take the equipment to a Nikon-authorized service representative for inspection.

Do not Disassemble

Touching the product's internal parts could result in injury. Repairs should be performed only by qualified technicians. Should the camera break open as the result of a fall or other accident, take the product to a Nikon-authorized service representative for inspection after unplugging the product and/or removing the batteries.

Do not use the Camera or AC Adapter in the Presence of Flammable Gas

Do not use electronic equipment in the presence of flammable gas, as this could result in explosion or fire.

Handle the Camera Strap with Care

Never place the strap around the neck of an infant or child.

Keep out of Reach of Children

Particular care should be taken to prevent infants from putting the batteries or other small parts into their mouths.

Observe caution when handling batteries

Batteries may leak or explode if improperly handled. Observe the following precautions when handling batteries for use in this product:

- Before replacing the batteries, turn the product off. If you are using an AC adapter, be sure it is unplugged.
- Use only the batteries approved for use in this product (🔋 12). Do not combine old and new batteries or batteries of different makes or types.
- If Nikon rechargeable EN-MH1 NiMH batteries are purchased separately, charge and use each of them as a set. Do not combine batteries from different pairs.
- Insert batteries in the correct orientation.
- Do not short or disassemble batteries or attempt to remove or break battery insulation or casing.
- Do not expose batteries to flame or to excessive heat.
- Do not immerse in or expose to water.
- Do not transport or store with metal objects such as necklaces or hairpins.
- Batteries are prone to leakage when fully discharged. To avoid damage to the product, be sure to remove the batteries when no charge remains.
- Discontinue use immediately should you notice any change in the batteries, such as discoloration or deformation.

Observe the following precautions when handling the Battery Charger MH-71 (available separately)

- If liquid from damaged batteries comes in contact with clothing or skin, rinse immediately with plenty of water.
- Keep Dry. Failure to observe this precaution could result in fire or electric shock.
- Dust on or near the metal parts of the plug should be removed with a dry cloth. Continued use could result in fire.
- Do not handle the power cable or go near the battery charger during lightning storms. Failure to observe this precaution could result in electric shock.
- Do not damage, modify, forcibly tug or bend the power cable, place it under heavy objects, or expose it to heat or flame. Should the insulation be damaged and the wires become exposed, take it to a Nikon-authorized service representative for inspection. Failure to observe these precautions could result in fire or electric shock.
- Do not handle the plug or battery charger with wet hands. Failure to observe this precaution could result in electric shock.

 **Use appropriate cables**

When connecting cables to the input and output jacks, use only the cables provided or sold by Nikon for the purpose, to maintain compliance with product regulations.

 **Handle moving parts with care**

Be careful that your fingers or other objects are not pinched by the lens cover or other moving parts.

 **CD-ROMs**

The CD-ROMs supplied with this device should not be played back on audio CD equipment. Playing CD-ROMs on an audio CD player could cause hearing loss or damage the equipment.

 **Observe caution when using the flash**

Using the flash close to your subject's eyes could cause temporary visual impairment. Particular care should be observed if photographing infants, when the flash should be no less than one meter (39 in.) from the subject.

 **Do not operate the flash with the flash window touching a person or object**

Failure to observe this precaution could result in burns or fire.

 **Avoid contact with liquid crystal**

Should the monitor break, care should be taken to avoid injury caused by broken glass and to prevent liquid crystal from the monitor touching the skin or entering the eyes or mouth.

Notices

Notice for customers in the U.S.A.

FCC RF Interference Statement

This equipment was tested and found to comply with the limits for a Class B digital device, pursuant to Part 15 of the FCC rules. These limits are designed to provide reasonable protection against harmful interference in a residential installation. This equipment generates, uses, and can radiate radio frequency energy and, if not installed and used in accordance with the instructions, may cause harmful interference to radio communications. However, there is no guarantee that interference will not occur in a particular installation. If this equipment does cause harmful interference to radio or television reception, which can be determined by turning the equipment off and on, the user is encouraged to try to correct the interference by one or more of the following measures:

- Reorient or relocate the receiving antenna.
- Increase the separation between the equipment and receiver.
- Connect the equipment into an outlet on a circuit different from that to which the receiver is connected.
- Consult the dealer or an experienced radio/television technician for help.

CAUTIONS

Modifications

The FCC requires the user to be notified that any changes or modifications made to this device that are not expressly approved by Nikon Corporation may void the user's authority to operate the equipment.

Interface Cables

Use the interface cables sold or provided by Nikon for your equipment. Using other interface cables may exceed the limits of Class B Part 15 of the FCC rules.

Notice for customers in the State of California

WARNING: Handling the cord on this product will expose you to lead, a chemical known to the State of California to cause birth defects or other reproductive harm. *Wash hands after handling.*

Nikon Inc.,

1300 Walt Whitman Road Melville,
New York 11747-3064 USA

Tel: 631-547-4200

FC *Nikon*
COOLPIX L18/L16

Notice for customers in Canada

CAUTION

This Class B digital apparatus complies with Canadian ICES-003.

ATTENTION

Cet appareil numérique de la classe B est conforme à la norme NMB-003 du Canada.

Symbol for Separate Collection in European Countries



This symbol indicates that this product is to be collected separately.







The following apply only to users in European countries:

- This product is designated for separate collection at an appropriate collection point. Do not dispose of as household waste.
- For more information, contact the retailer or the local authorities in charge of waste management.

Table of Contents

For Your Safety	ii
WARNINGS.....	ii
Notices.....	v
Introduction	1
About This Manual	1
Information and Precautions	2
Parts of the Camera	4
The Camera Body	4
The Monitor.....	6
Basic Operations.....	8
The Shooting Mode Button	8
The  (Playback) Button.....	8
The Multi Selector.....	9
The MENU Button.....	10
Help Displays.....	11
Attaching the Camera Strap	11
Shutter-release Button	11
First Steps	12
Insert the Batteries.....	12
Supported Batteries	12
Turning On and Off the Camera.....	12
Setting Display Language, Date and Time	14
Inserting Memory Cards	16
Removing Memory Cards.....	17
 Basic Photography and Playback: Easy Auto Mode	18
Step 1 Turn the Camera On and Select  (Easy Auto) Mode	18
Step 2 Frame a Picture	20
Step 3 Focus and Shoot	22
Step 4 Viewing and Deleting Pictures	24
Using the Flash.....	26
Setting the Flash Mode.....	26
Taking Pictures with the Self-timer	28
Macro Mode	29
Exposure Compensation	30

 Auto Mode.....	31
Shooting in the Auto Mode.....	31
<hr/>	
 Shooting Suited for the Scene.....	32
Shooting in the Scene Mode	32
Setting the Scene Mode.....	32
Features	33
<hr/>	
 More on Playback.....	40
Viewing Multiple Pictures: Thumbnail Playback	40
Taking a Closer Look: Playback Zoom	41
Editing Pictures.....	42
Enhancing Brightness and Contrast: D-Lighting.....	43
Creating a Cropped Copy: Crop	44
 Resizing Pictures: Small Picture	45
<hr/>	
 Movies	46
Recording Movies	46
The Movie Menu.....	47
Selecting Movie Options.....	47
Movie Playback.....	48
Deleting Movie Files.....	48

Connecting to Televisions, Computers and Printers	49
Connecting to a TV	49
Connecting to a Computer	50
Before Connecting the Camera	50
Transferring Pictures from the Camera to a Computer	51
Connecting to a Printer	54
Connecting the Camera and Printer	55
Printing Pictures One at a Time	56
Printing Multiple Pictures	57
Creating a DPOF Print Order: Print Set	60

























MENU Shooting, Playback and Setup Menus	62
Shooting Options: The Shooting Menu	62
Displaying the Shooting Menu	62
 Image Mode	63
 White Balance	65
 Continuous	67
 Color Options	68
Restrictions on Camera Settings	69
Playback Options: The Playback Menu	70
Displaying the Playback Menu	70
 Slide Show	72
 Delete	73

Table of Contents

Basic Camera Setup: The Setup Menu	74
Displaying the Setup Menu.....	75
 Menus.....	76
 Welcome Screen.....	76
 Date.....	77
 Monitor Settings.....	80
 Date Imprint.....	81
 Anti-shake AE.....	82
 AF Assist.....	83
 Sound Settings.....	83
 Auto Off.....	84
 Format Memory/  Format Card.....	85
 Language.....	86
 Video mode.....	86
 Reset All.....	87
 Battery type.....	89
 Protect.....	89
 Copy.....	89
 Ver. Firmware Version.....	90

Technical Notes	91
Optional Accessories	91
Approved Memory Cards.....	91
Image File and Folder Names	92
Caring for the Camera	93
Cleaning.....	95
Storage.....	95
Error Messages	96
Troubleshooting	99
Specifications	104
Supported Standards	107
Index	108

About This Manual

Thank you for your purchase of a Nikon COOLPIX L18/COOLPIX L16 digital camera. This manual was written to help you enjoy taking pictures with your Nikon digital camera. Read this manual thoroughly before use, and keep it where all those who use the product will read it.

Symbols and Conventions

To make it easier to find the information you need, the following symbols and conventions are used:



This icon marks cautions, information that should be read before use to prevent damage to the camera.



This icon marks tips, additional information that may be helpful when using the camera.



This icon marks notes, information that should be read before using the camera.



This icon indicates that more information is available elsewhere in this manual or in the *Quick Start Guide*.

Notations

- A Secure Digital (SD) memory card is referred to as a “memory card.”
- The setting at the time of purchase is referred to as the “default setting.”
- The names of menu items displayed in the camera monitor, and the names of buttons or messages displayed in the computer monitor appear in bold.

Screen Samples

In this manual, images are sometimes omitted from monitor display samples so that monitor indicators can be more clearly shown.

Illustrations and Screen Display

- Illustrations and text displays shown in this manual may differ from actual display.
- Illustrations and text displays shown in this manual are for COOLPIX L18.

Product Names

In this manual, the product names “COOLPIX L18” and “COOLPIX L16” may sometimes be abbreviated as “L18” and “L16”.

Memory Cards

Pictures taken with this camera can be stored in the camera’s internal memory or on removable memory cards. If a memory card is inserted, all new pictures will be stored on the memory card and delete, playback and format operations will apply only to the pictures on the memory card. The memory card must be removed before the internal memory can be formatted or used to store, delete or view pictures.

Information and Precautions

Life-Long Learning

As part of Nikon's "Life-Long Learning" commitment to ongoing product support and education, continually updated information is available online at the following sites:

- For users in the U.S.A.: <http://www.nikonusa.com/>
- For users in Europe and Africa: <http://www.europe-nikon.com/support/>
- For users in Asia, Oceania, and the Middle East: <http://www.nikon-asia.com/>

Visit these sites to keep up-to-date with the latest product information, tips, answers to frequently asked questions (FAQs), and general advice on digital imaging and photography. Additional information may be available from the Nikon representative in your area. See the URL below for contact information:

<http://nikonimaging.com/>

Use Only Nikon Brand Electronic Accessories

Nikon COOLPIX cameras are designed to the highest standards and include complex electronic circuitry. Only Nikon brand electronic accessories (including battery chargers, batteries and AC adapters) certified by Nikon specifically for use with this Nikon digital camera are engineered and proven to operate within the operational and safety requirements of this electronic circuitry.

THE USE OF NON-NIKON ELECTRONIC ACCESSORIES COULD DAMAGE THE CAMERA AND MAY VOID YOUR NIKON WARRANTY.

For more information about Nikon brand accessories, contact a local authorized Nikon dealer.

Before Taking Important Pictures

Before taking pictures on important occasions (such as at weddings or before taking the camera on a trip), take a test shot to ensure that the camera is functioning normally. Nikon will not be held liable for damages or lost profits that may result from product malfunction.

About the Manuals

- No part of the manuals included with this product may be reproduced, transmitted, transcribed, stored in a retrieval system, or translated into any language in any form, by any means, without Nikon's prior written permission.
- Nikon reserves the right to change the specifications of the hardware and software described in these manuals at any time and without prior notice.
- Nikon will not be held liable for any damages resulting from the use of this product.
- While every effort was made to ensure that the information in these manuals is accurate and complete, we would appreciate it were you to bring any errors or omissions to the attention of the Nikon representative in your area (address provided separately).

Notice Concerning Prohibition of Copying or Reproduction

Note that simply being in possession of material that was digitally copied or reproduced by means of a scanner, digital camera or other device may be punishable by law.

- **Items prohibited by law from being copied or reproduced**

Do not copy or reproduce paper money, coins, securities, government bonds or local government bonds, even if such copies or reproductions are stamped "Sample." The copying or reproduction of paper money, coins, or securities which are circulated in a foreign country is prohibited. Unless the prior permission of the government was obtained, the copying or reproduction of unused postage stamps or post cards issued by the government is prohibited. The copying or reproduction of stamps issued by the government and of certified documents stipulated by law is prohibited.

- **Cautions on certain copies and reproductions**

The government has issued cautions on copies or reproductions of securities issued by private companies (shares, bills, checks, gift certificates, etc.), commuter passes or coupon tickets, except when a minimum of necessary copies are to be provided for business use by a company. Also, do not copy or reproduce passports issued by the government, licenses issued by public agencies and private groups, ID cards and tickets, such as passes and meal coupons.

- **Comply with copyright notices**

The copying or reproduction of copyrighted creative works such as books, music, paintings, woodcut prints, maps, drawings, movies and photographs is governed by national and international copyright laws. Do not use this product for the purpose of making illegal copies or to infringe copyright laws.

Disposing of Data Storage Devices

Please note that deleting images or formatting data storage devices such as memory cards or built-in camera memory does not completely erase the original image data. Deleted files can sometimes be recovered from discarded storage devices using commercially available software, potentially resulting in the malicious use of personal image data. Ensuring the privacy of such data is the user's responsibility.

Before discarding a data storage device or transferring ownership to another person, erase all data using commercial deletion software, or format the device and then completely refill it with images containing no private information (for example, pictures of empty sky). Be sure to also replace any pictures selected for the welcome screen (📷 76). Care should be taken to avoid injury or damage to property when physically destroying data storage devices.

Parts of the Camera

The Camera Body

COOLPIX L18 is taken for this manual to explain the operations.

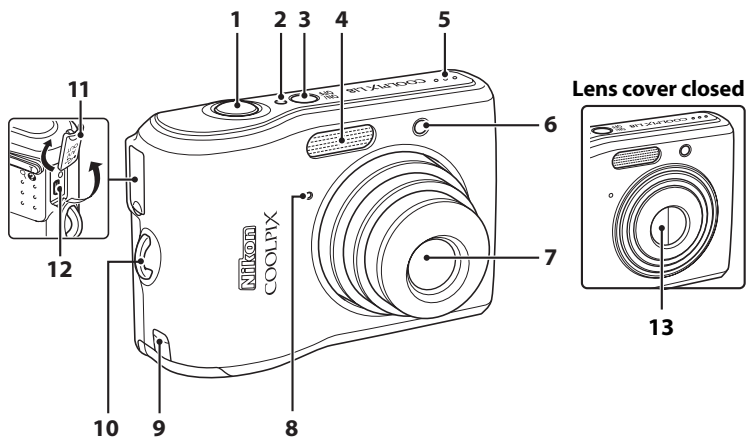

1	Shutter-release button.....	22	8	Built-in microphone.....	46
2	Power-on lamp.....	12	9	Power connector cover for optional AC adapter.....	91
3	Power switch.....	18	10	Eyelet for camera strap.....	11
4	Built-in flash.....	26	11	Connector cover.....	49, 51, 55
5	Speaker.....	48	12	Cable connector.....	49, 51, 55
6	Self-timer lamp.....	28, 94	13	Lens cover.....	93
	AF-assist illuminator.....	23, 33, 83, 94			
7	Lens.....	93, 104			

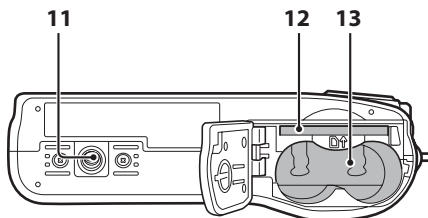
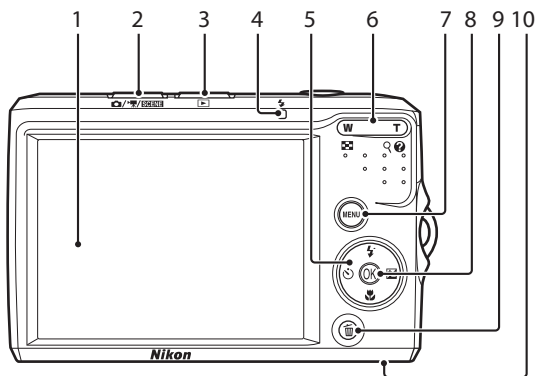

1	Monitor	6	7	MENU button	10, 47, 62, 70
2	Shooting mode button.....	8	8	OK (apply selection) button.....	9
3	▶ (playback) button.....	8	9	⌫ (delete) button.....	24, 25, 48
4	Flash lamp	27	10	Battery-chamber/ memory card slot cover.....	12, 16
5	Multi selector.....	9	11	Tripod socket	
6	Zoom buttons	20	12	SD card slot.....	16
	W : Zoom out.....	20	13	Battery-chamber.....	12
	T : Zoom in.....	20			
	📷 : Thumbnail playback.....	40			
	🔍 : Playback zoom.....	41			
	❓ : Help	11			

The Monitor

The following indicators may appear in the monitor during shooting and playback (actual display varies with current camera settings). They will display only for a few seconds (⏏ 80).

Shooting

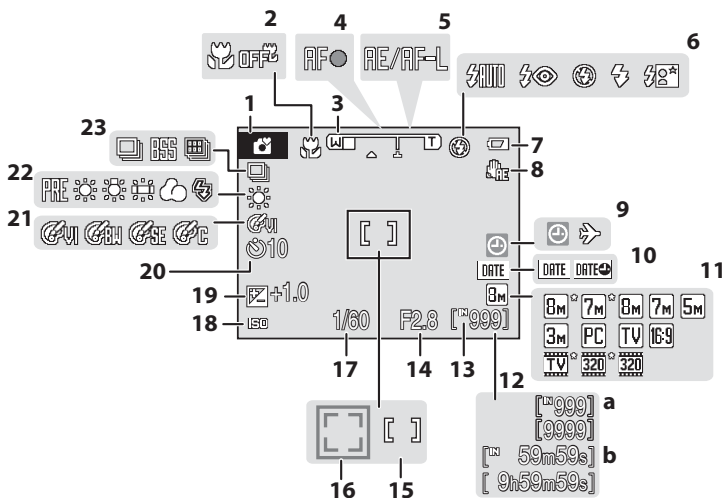

1	Shooting mode ¹	18, 31, 32, 46	12	a	Number of exposures remaining (still pictures)	18
2	Macro mode.....	29	13	b	Movie length.....	46
3	Zoom indicator.....	20, 29	14		Internal memory indicator.....	19
4	Focus indicator.....	22	15		Aperture.....	22
5	Exposure Lock.....	39	16		Focus area.....	20, 22
6	Flash mode.....	26	17		Focus area (Face Priority).....	20, 22
7	Battery level indicator.....	18	18		Shutter speed.....	22
8	Anti-shake AE icon.....	82	19		ISO sensitivity.....	27
9	"Date not set" indicator.....	96	20		Exposure compensation value.....	30
10	Time zone indicator.....	77	21		Self-timer indicator.....	28
11	Date imprint.....	81	22		Color options.....	68
	Image mode ²	63	23		White balance mode.....	65
	Movie options.....	47			Continuous shooting mode.....	67

¹ Differs according to the current shooting mode. Refer to the sections on each mode for details.

² **8M** and **8m** are displayed on L18, and **7M** and **7m** are displayed on L16.

Playback

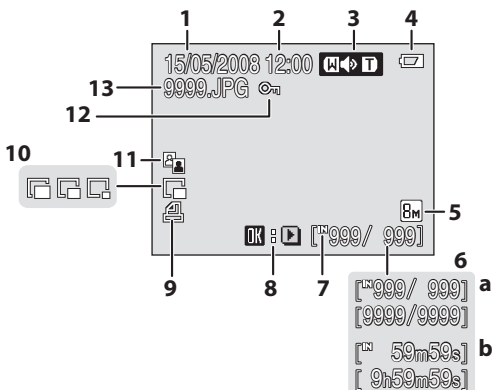

1	Date of recording.....	14	7	Internal memory indicator.....	19
2	Time of recording.....	14	8	Movie playback indicator.....	48
3	Volume indicator.....	48	9	Print-order icon.....	60
4	Battery level indicator.....	18	10	Small picture.....	45
5	Image mode.....	63	11	D-Lighting icon.....	43
	Movie options.....	47	12	Protect icon.....	89
6	a Current frame number/ total number of frames.....	24	13	File number and type.....	92
	b Movie length.....	48			

Basic Operations

The Shooting Mode Button

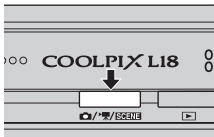

- Press the shooting mode button in playback mode to enter shooting mode.
- Press the shooting mode button in shooting mode to display the shooting-mode selection menu.

The Shooting-mode Selection Menu

In the shooting-mode selection menu, use the multi selector to select the shooting mode.

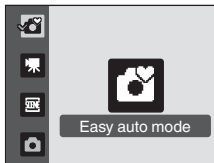

- Easy auto mode (18)
- Movie (46)
- Scene (32)
- Auto mode (31)

- The shooting-mode selection menu is continuously displayed until you select the shooting mode and press **OK** to determine the mode, or you press the shooting mode button again.
- To return to the shooting mode while the shooting-mode selection menu is displayed, press the shooting mode button again.

The (Playback) Button

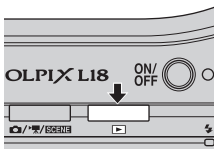





- Press  in shooting mode to enter playback mode.

The Multi Selector

This section describes standard uses of the multi selector to select modes, select menu options and to apply selection.

For Shooting

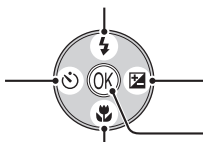

Display  (flash mode) () menu or move cursor up.

Display  (self-timer) () menu.



Display  (exposure compensation) () menu.

Apply selection.

Display  (macro mode) () menu or move cursor down.

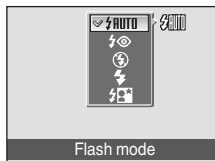

For the Playback Mode

Display the previous picture.

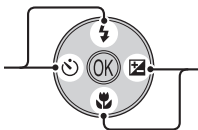

Display the next picture.



For the Menu Screen

Move cursor up.

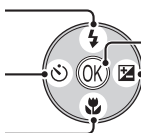

Apply selection (Go to the next screen).

Return to the previous screen.

Go to the next screen (Apply selection).

Move cursor down.

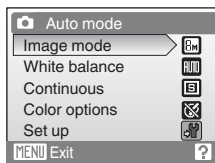

Notes on the Multi Selector

Multiple operations are available with the multi selector but no detailed operation is described here. In the manual, the button indicating up, down, left and right of the multi selector is shown as ▲, ▼, ◀ and ▶.

The MENU Button

Press **MENU** to display the menu for the selected mode. Use the multi selector to navigate the menus (Ⓜ 9).

To exit the menu display, press **MENU** again.

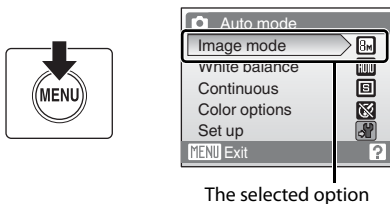

The selected option

Displayed when the menu contains two or more pages

Displayed when there are more previous menu items

Displayed when there are one or more menu items to follow

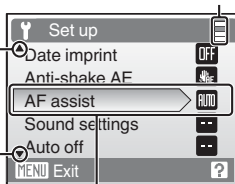

Press the multi selector ► or Ⓜ to proceed to the next set of options.

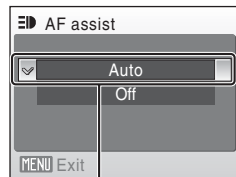

Press the multi selector ► or Ⓜ to apply selection.

Help Displays

Press **T** (?) when (?) is displayed at the lower right of the menu screen to view a description of the currently selected menu option.

To return to the original menu, press **T** (?) again.

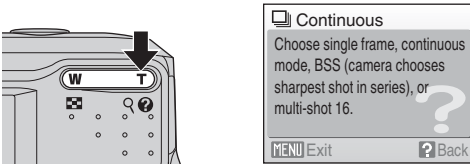

Attaching the Camera Strap

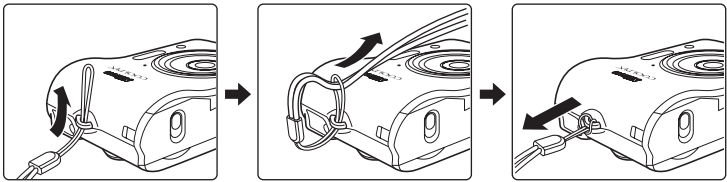

Shutter-release Button

The camera features a two-stage shutter-release button. To set focus and exposure, press the shutter-release button halfway, stopping when you feel resistance. Focus and exposure lock while the shutter-release button is held in this position. To release the shutter and take a picture, press the shutter-release button the rest of the way down. Do not use force when pressing the shutter-release button, as this may result in camera shake and blurred pictures.



Press the shutter-release button halfway to set focus and exposure.

Press the shutter-release button the rest of the way down to take picture.

Insert the Batteries

1 Open the battery-chamber/memory card slot cover.

- Hold the camera upside down to prevent the batteries from falling out.

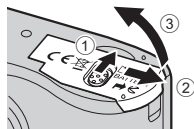

2 Insert the batteries.

- Insert the batteries correctly as shown at right.

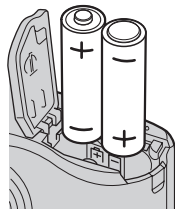

3 Close the battery-chamber/memory card slot cover.



Supported Batteries

This camera uses the following size AA batteries.

- Two LR6 alkaline batteries (batteries supplied)
- Two FR6/L91 lithium batteries
- Two ZR6 oxyride batteries
- Two Nikon EN-MH1 rechargeable nickel-metal hydride batteries (available separately)

Turning On and Off the Camera

To turn on the camera, press the power switch. The power-on lamp (green) will light for a moment and the monitor will turn on.

To turn off the camera, press the power switch again.

When the camera turns off, both the power-on lamp and monitor will turn off.

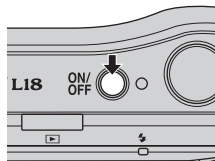

✓ Replacing Batteries

Turn the camera off and make sure that the power-on lamp and the monitor have gone out before opening the battery-chamber/memory card slot cover.

✓ Additional Precautions Regarding Batteries

- Read and follow the warnings and cautions (📖 iii, 94).
- Do not combine old and new batteries or batteries of different makes or types.
- Batteries with the following defects cannot be used:

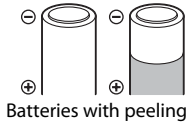

Batteries with peeling



Batteries with insulation that does not cover the area around the negative terminal.

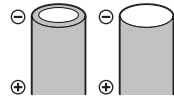

Batteries with a flat negative terminal

✓ Battery Type

To improve battery performance, select the type of battery currently inserted in the camera in the setup menu. The default setting is the type of battery supplied with purchase. If your camera was purchased in Europe and alkaline batteries were supplied, change the setting to **Alkaline**. When any other type of battery is used, turn the camera on and change the setting (📖 89).

📎 Alkaline Batteries

Performance of alkaline batteries may vary greatly depending on the manufacturer. Choose a reliable brand.

📎 Alternative Power Resources

To power the camera continuously for extended periods, use an EH-65A AC adapter (available separately) (📖 91). **Do not, under any circumstances, use another make or model of AC adapter.** Failure to observe this precaution could result in overheating or in damage to the camera.

💡 Power Saving Function in Shooting Mode

If no operations are performed for about five seconds, the monitor will dim to save power. Using any of the camera controls will reactivate the display. The monitor turns off if no operations are performed for thirty seconds (default setting). The camera enters standby mode.

After a further three minutes, the camera will turn off automatically (📖 84).

Setting Display Language, Date and Time

A language-selection dialog and date menu are displayed the first time the camera is turned on.

1 Press the power switch to turn on the camera.

The power-on lamp (green) will light for a moment and the monitor will turn on.

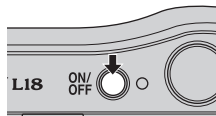

2 Use the multi selector to choose the desired language and press **OK**.

For information on using the multi selector, see "The Multi Selector" (📖 9).



3 Choose **Yes** and press **OK**.

If **No** is selected, the date and time will not be set. Proceed to step 8.

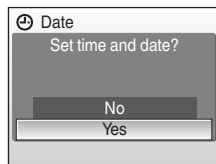

4 Press **OK**.

The home time zone menu is displayed.

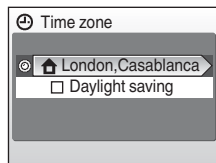

5 Select your home time zone (📖 79) and press **OK**.

The date menu is displayed.

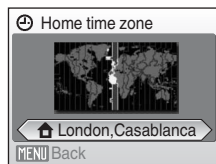

Daylight Saving Time

If daylight saving time is in effect, turn on **Daylight saving** in the time zone menu in Step 4 and set the date.

- 1 Before pressing **▶**, press the multi selector **▼** to choose **Daylight saving**.
- 2 Press **OK** to enable daylight saving time (✓). Pressing **OK** toggles the daylight saving time option on and off.
- 3 Press the multi selector **▲**, and then press **▶** to proceed to step 5.

6 Change the date and time.

- Press ▲ or ▼ to edit the highlighted item.
- Press the multi selector ◀ or ▶ to change the highlighted item. The highlight moves in the order of day (D), month (M) and year (Y) or vice versa (the order of highlight movement may differ in some areas).

After editing the minutes, press the multi selector ▶. The row for setting the order in which the date is displayed will blink.

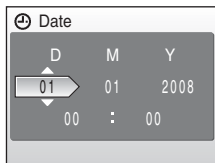

7 Choose the order in which the day, month, and year are displayed and press OK or ▶.

The settings are applied.

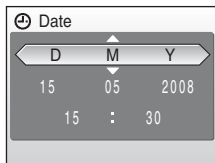

8 Press the shooting mode button to exit the screen.

The shooting-mode selection menu will be displayed.

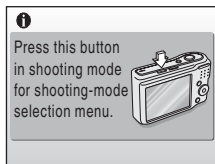

9 When Easy auto mode is displayed, press OK.

- The camera enters the shooting mode and you can take pictures in Easy auto mode (📖 18).
- Press the multi selector ▲ or ▼ before OK button, to switch to another shooting mode.

See "Shooting in the Auto Mode" (📖 31), "Shooting in the Scene Mode" (📖 32), "Recording Movies" (📖 46) for more information.

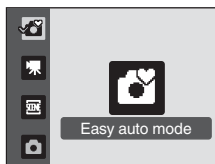

🔍 Change the selected date and time

- To change the date and time, select **Date** from **Date** (📖 77) in the setup menu (📖 74) and perform step 6 & 7 above.
- To change the time zone and the daylight saving settings, select **Time zone** from **Date** in the setup menu (📖 77, 78).

Inserting Memory Cards

Pictures are stored in the camera's internal memory (21 MB) or on removable Secure Digital (SD) memory cards (available separately) (8 91).

If a memory card is inserted in the camera, pictures are automatically stored on the memory card and pictures recorded to the memory card can be played back, deleted or transferred. Remove the memory card to store pictures in the internal memory, or play back, delete or transfer pictures from the internal memory.

First Steps

- 1** Turn the camera off and open the battery-chamber/memory card slot cover.

Make sure that the camera is off (the power-on lamp and the monitor are off) before opening the battery-chamber/memory card slot cover.

Hold the camera upside down to prevent the batteries from falling out.

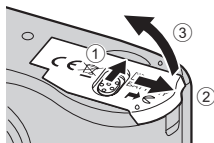

- 2** Insert the memory card.

Slide the memory card in correctly until it clicks into place.

Close the battery-chamber/memory card slot cover.

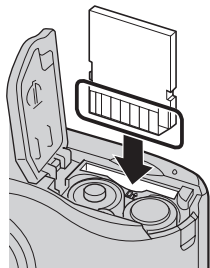

Inserting Memory Cards

Inserting the memory card upside down or backwards could damage the camera or the memory card. Make sure that the memory card is correctly oriented.

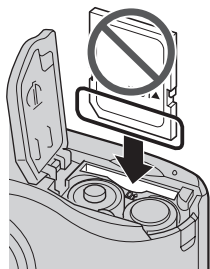

Removing Memory Cards

Before removing memory cards, **turn the camera off** and confirm that the power-on lamp and the monitor are off. Open the battery-chamber/memory card slot cover and press the card in ① to partially eject the card ②. The card can then be removed by hand.

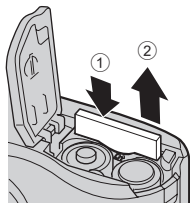

✓ Formatting Memory Cards

If the message at right is displayed, the memory card must be formatted before use (85). Note that **formatting permanently deletes all pictures** and other data on the memory card. Be sure to make copies of any pictures you wish to keep before formatting the memory card.

Use the multi selector to choose **Yes** and press **OK**. A confirmation dialog is displayed. To start formatting, choose **Format** and press **OK**.

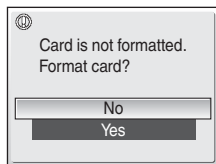

- **Do not turn the camera off or open the battery-chamber/memory card slot cover until formatting is complete.**
- The first time you insert the memory cards used in other devices into the COOLPIX L18/COOLPIX L16, be sure to format them (85).

✓ The Write Protect Switch

Memory cards are equipped with a write protect switch. Pictures cannot be recorded or deleted and the memory card cannot be formatted when this switch is in the "lock" position. Unlock by sliding the switch to the "write" position.

Write protect switch

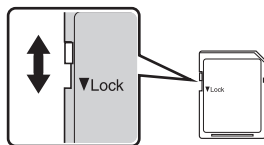

✓ Memory Cards

- Use only Secure Digital memory cards.
- Do not perform the following during formatting, while data is being written to or deleted from the memory card, or during data transfer to a computer. Failure to observe this precaution could result in the loss of data or in damage to the camera or memory card:
 - Eject the memory card
 - Remove the battery
 - Turn off the camera
 - Disconnect the AC adapter
- Do not disassemble or modify.
- Do not drop, bend, or expose to water or strong physical shocks.
- Do not touch the metal terminals with your fingers or metal objects.
- Do not affix labels or stickers to the memory card.
- Do not leave in direct sunlight, closed vehicles or areas exposed to high temperatures.
- Do not expose to humidity, dust, or to corrosive gases.

Step 1 Turn the Camera On and Select (Easy Auto) Mode

This section describes how to take pictures in  (easy auto) mode, an automatic, “point-and-shoot” mode recommended for first-time users of digital cameras.

1 Press the power switch to turn on the camera.

The power-on lamp (green) will light for a moment and the monitor will turn on. In this step, the lens will also open.

Proceed to step 4 when  is displayed.

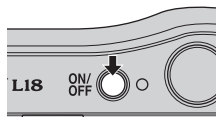

2 Press the shooting mode button.

The shooting-mode selection menu will be displayed.

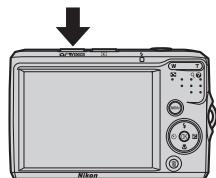

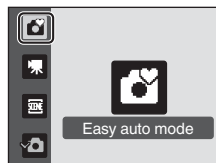

3 Press the multi selector or to choose and press .

The camera enters  (easy auto) mode.



4 Check the battery level and number of exposures remaining.

Battery Level

Monitor	Description
NO INDICATOR	Batteries fully charged.
	Batteries low; prepare to replace batteries.
 Battery exhausted.	Cannot take pictures. Replace batteries.

Battery level indicator

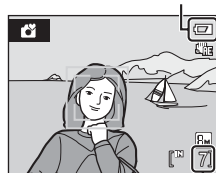

Number of exposures remaining

Number of Exposures Remaining

The number of pictures that can be stored will be displayed.

The number of pictures that can be stored depends on the capacity of the memory or memory card and image mode setting ( 64).

Indicators Displayed in (Easy Auto) Mode



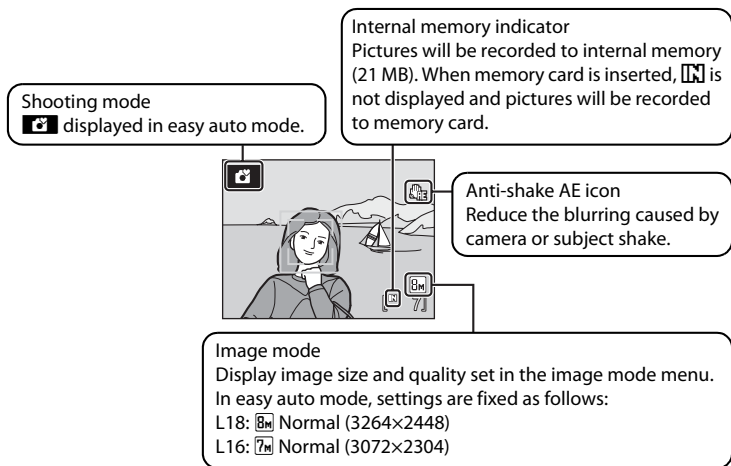



The information on indicators in the monitor during shooting and playback will display only for a few seconds ( 80).



Easy auto mode

- If you direct the camera to the human face (front side), the camera automatically recognizes the face and focuses on the face so that you can take pictures in Face Priority.
- In this mode, the camera automatically activates the D-lighting ( 43) which brightens the darker portion of the subjects in taking pictures and records the images.

Available Functions in (Easy Auto) Mode

In  (easy auto) mode, macro mode ( 29) and exposure compensation ( 30) can be applied and pictures can be taken using the flash mode ( 26) and self-timer ( 28). Pressing MENU in  (easy auto) mode displays the setup menu ( 74).

Anti-shake AE

When **Anti-shake AE** ( 82) is set to **Auto** (default setting), detecting the camera shake or subject movement in shooting still pictures increases the shutter speed to reduce the effects of camera or subject shake.

Step 2 Frame a Picture

1 Ready the camera.

Hold the camera steadily in both hands, keeping your fingers and other objects away from the lens, flash, self-timer lamp and built-in microphone.

When taking pictures in “tall” orientation, turn the camera so that the built-in flash is above the lens.

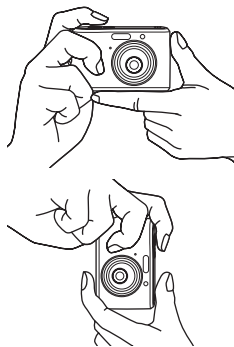

2 Frame the picture.

When the camera recognizes a face (front view), that face will be framed by a yellow double border (by default). If more than one face is recognized, the face nearest to the camera will be framed by a double border and the rest by a single border.

Up to five faces can be recognized.

Focus area, focusing on the center of the monitor will appear when shooting non-human subjects or when no faces are recognized.

Position the main subject near the center of the monitor.



Using the Zoom

Use the zoom buttons to activate zoom.

Press **T** (Q) to zoom in so that the subject fills a larger area of the frame. Press **W** (R) to zoom out, increasing the area visible in the frame.

Zoom indicator displayed when the zoom buttons are pressed.

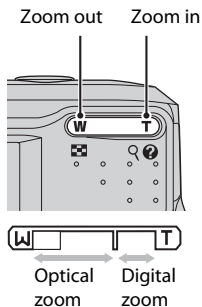

Digital Zoom

When the camera is zoomed in to the maximum magnification (3×), holding down **T** (Q) triggers digital zoom. The subject is magnified up to 4×, for a total magnification of 12×.

The focus area is not displayed when digital zoom is in effect, and focus will be in the center of the screen.

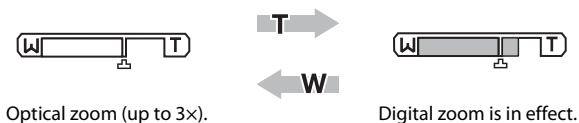





In the digital zoom which is different from the optical zoom, an image is enlarged using the digital processing, creating slightly grainy image.









 is displayed in the zooming position of the maximum ratio without interpolation in the zoom indicator on the monitor.

The zoom indicator will be yellow when the zooming operation goes beyond , and the picture quality in digital zoom begins to degrade.

Maximum Zoom Ratio without Interpolation

When the shooting mode is set to Auto Mode ( 31) or Scene Mode ( 32), the  position displayed in the zoom indicator will move to the Zoom in side if the image size in the image mode ( 63) becomes smaller, and the picture quality won't degrade due to the digital zoom until the magnification reaches the values shown in the table below.

If the magnification at which picture quality in digital zoom begins to degrade, the zooming operation will stop temporarily. In addition, if the **T** (Q) button is continuously pressed to increase the magnification, the picture quality in digital zoom begins to degrade.

Image mode	Zoom ratio
 ¹ ,  ¹ ,  ² ,  ²	3.0× (up to the maximum optical zoom ratio)
	3.6× (digital zoom up to 1.2×)
	4.2× (digital zoom up to 1.4×)
	4.8× (digital zoom up to 1.6×)
	9.0× (digital zoom up to 3.0×)
	12× (digital zoom up to 4.0×)

¹ L18 Only

² L16 Only

Step 3 Focus and Shoot

1 Press the shutter-release button halfway.

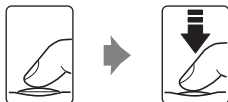

When people's faces (front view) are recognized:

Camera will focus on the face surrounded by a double border. Once focus has been locked the double border will glow green.



When shooting non-human subjects or when no faces are recognized:

The camera focuses on the subject overlapping the focus area in the center of the monitor. When the subject is in focus, the focus area glows green.

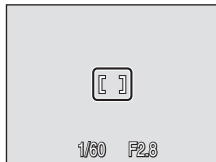

- When the digital zoom is used, the focus indicator (ⓧ 6) glows green once the focus has been locked in the center of the monitor. The focus area won't be displayed.
- The shutter speed and aperture are displayed when the shutter-release button is pressed halfway.
- The focus and exposure remain locked while the shutter-release button is pressed halfway.
- When the shutter-release button is pressed halfway, and then the double border blinks in Face Priority, or the focus area or the focus indicator blinks red, the camera is unable to focus. Change the composition and press the shutter-release button halfway down again.

2 Press the shutter-release button the rest of the way down.

The picture will be recorded to the memory card or internal memory.



✓ During Recording

While pictures are being recorded, the ⓧ (wait) icon will be displayed and the number of exposures remaining or movie length will blink. Do not turn the camera off, open the battery-chamber/memory card slot cover, or remove or disconnect the power source while these icons are displayed. Cutting power or removing the memory card in these circumstances could result in loss of data or in damage to the camera or card.

Face Priority

- If no face is recognized when the shutter-release button is pressed halfway, the camera focuses on the center of the frame.
- The camera may be unable to detect faces in the following situations:
 - When faces are partially hidden by sunglasses or other obstructions
 - When the subject is not looking directly at the camera
 - When faces take up too much or too little of the frame
- The camera's ability to detect faces depends on a variety of factors, including whether or not the subject is facing the camera.
- It is very rare cases, but if you shoot a subject with which autofocus may not perform as expected, the subject may not be in focus despite the fact that the double border glows green. When the camera is unable to focus, refocus on another subject positioned at the same distance from the camera as the actual portrait subject, and use focus lock ( 31).

Autofocus

Autofocus may not perform as expected in the following situations. In some rare cases, the subject may not be in focus despite the fact that the active focus area or the focus indicator glows green:

- Subject is very dark
- Objects of sharply differing brightness are included in the scene (e.g. the sun is behind the subject and is in deep shadow)
- No contrast between the subject and surroundings (e.g. when the subject is standing in front of a white wall, wearing a white shirt)
- Several objects are at different distances from the camera (e.g. the subject is inside a cage)
- Subject is moving rapidly

In the situations noted above, try pressing the shutter-release button halfway to refocus several times, or focus on another subject and use focus lock. When using focus lock, be sure that the distance between the camera and the subject with which focus was locked is the same as that for the actual subject.

AF-assist Illuminator and Flash

If the subject is poorly lit, the AF-assist illuminator may light by pressing the shutter-release button halfway, or the flash may fire by pressing the shutter-release button all the way down. The illuminator has a range of about 2.4 m (7 ft. 10.5 in.) at the maximum wide-angle position and 1.7 m (5 ft. 6.9 in.) at the maximum telescopic position. The AF-assist illuminator can be set to **Off** manually ( 83), although in this case the camera may not focus when lighting is poor.

Step 4 Viewing and Deleting Pictures

Viewing Pictures (Playback Mode)



Press .

The last picture taken will be displayed in full-frame playback mode.

Use the multi selector , ,  or  to view additional pictures. Hold the multi selector down to fast forward or rewind.

Pictures may be displayed briefly at low resolution while being read from the memory card or internal memory.

Press the shooting mode button to switch to shooting mode.

When  is displayed, pictures stored in the internal memory will be displayed. When memory card is inserted,  is not displayed and pictures stored on the memory card will be displayed.

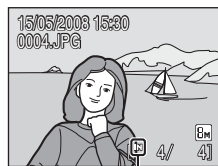
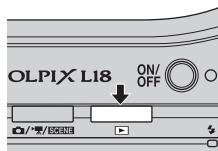



Internal memory

Deleting Pictures

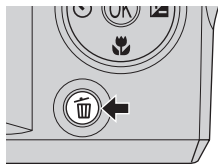
- 1 Press  to delete the picture currently displayed in the monitor.



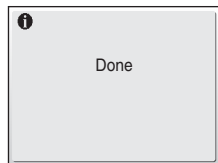

- 2 Use the multi selector to select **Yes** and press .

To exit without deleting the picture, choose **No** and press .



Playback Mode

The following options are available in full-frame playback mode.

Option	Use	Description	
Playback zoom	T (Q)	Press T (Q) to enlarge view of picture currently displayed in monitor, up to about 10x. Press OK to return to full-frame playback.	41
View thumbnails	W (checkered flag)	Press W (checkered flag) to display 4, 9 or 16 picture thumbnails.	40
Switch to shooting mode	  SCENE	Press the shooting mode button to switch to the shooting mode selected in the shooting-mode selection menu.	8

Viewing Pictures

Pictures stored in the internal memory can only be viewed if no memory card is inserted. Pictures taken in Face Priority, while in full-frame playback, will be rotated (if necessary) and displayed.

Deleting the Last Picture Taken

In shooting mode, press  to delete the last picture taken.



Using the Flash

The flash has a range of 0.5-7.7 m (19.7 in.-25 ft. 3.1 in.) when the camera is zoomed out all the way. With maximum optical zoom applied, the range is 0.5-4.5 m (19.7 in.-14 ft. 9.1 in.).

AUTO Auto

Flash fires automatically when lighting is poor.

Auto with red-eye reduction

Reduces “red-eye” in portraits ( 27).

Off

Flash will not fire even when lighting is poor.

Fill flash

Flash fires when a picture is taken. Use to “fill-in” (illuminate) shadows and backlit subjects.

Slow sync

 AUTO (auto) is combined with slow shutter speed.

Flash illuminates main subject; slow shutter speeds are used to capture background at night or under dim light.

Setting the Flash Mode

1 Press (flash mode).

The flash menu is displayed.



2 Use the multi selector to choose the desired flash mode and press .

The icon for the selected flash mode is displayed at the top of the monitor.

When  AUTO (auto) is applied,  AUTO is displayed for a few seconds only regardless of **Photo Info** ( 80).

If a setting is not applied by pressing  within a few seconds, the selection will be cancelled.

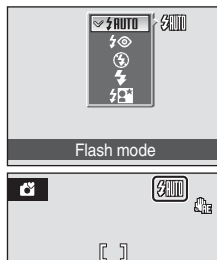

✓ The (Off) Indicator

Note the following when lighting is poor and the flash is off (Off):

- Place the camera on a flat, level surface or use a tripod (recommended).
- The ISO symbol is displayed when the camera automatically increases sensitivity. Pictures taken when ISO is displayed may be slightly mottled.

✓ Note on Using the Flash

When using the flash at a wide-angle zoom position, reflections from dust particles in the air may appear as bright spots in pictures. To reduce these reflections, set the flash to (Off) or zoom in on the subject.

✍ The Flash Lamp

The flash lamp indicates flash status when the shutter-release button is pressed halfway.

- **On:** Flash will fire when picture is taken.
- **Blinks:** Flash charging. Wait a few seconds and try again.
- **Off:** Flash will not fire when picture is taken.

If the battery level is low, monitor turns off and the flash lamp blinks until the flash is completely charged.

Flash lamp

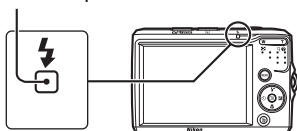

✍ The Flash Mode Setting

In any flash mode selected in the shooting mode other than (auto) mode, switching to another shooting mode or turning the camera off restores the default flash setting for each shooting mode. The default setting is (auto). (except for some scene modes)

✍ Red-eye Reduction

The COOLPIX L18/COOLPIX L16 is equipped with an advanced red-eye reduction system. Pre-flashes are fired several times at low intensity before the main flash, to reduce "red-eye." If the camera detects "red-eye" after a picture is taken, Nikon's own In-Camera Red Eye Fix processes the image as it is recorded. Therefore, there is a slight delay before the shutter-release button operates normally to take another picture. Note the following when using red-eye reduction:

- Not recommended for when shutter-release timing is essential.
- It takes a longer time than usual to start the next shooting.
- Red-eye reduction may not always produce the desired results.
- In some rare cases, other portions of pictures may be affected.

Use flash modes other than auto with red-eye reduction in above cases.

Taking Pictures with the Self-timer

The camera is equipped with a ten-second timer for self-portraits. When using the self-timer, use of a tripod is recommended.

1 Press (self-timer).

The self-timer menu is displayed.



2 Use the multi selector to choose **ON** and press .

The self-timer icon () is displayed.

If a setting is not applied by pressing  within a few seconds, the selection will be cancelled.



3 Frame the picture and press the shutter-release button halfway.

Focus and exposure will be set.

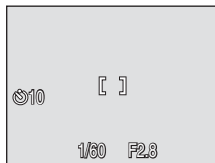

4 Press the shutter-release button the rest of the way down.

The self-timer starts and the self-timer lamp will blink. The lamp stops blinking one second before the photograph is taken and remains lit until the shutter is released.

The number of seconds remaining before the shutter is released is displayed in the monitor.

To stop the timer before a picture is taken, press the shutter-release button again.

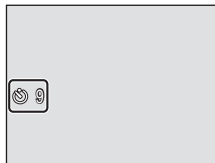

Macro Mode

Macro mode is used for taking pictures of objects as close as 15 cm (5.9 in.). Note that the flash may be unable to light entire subject at distances of less than 50 cm (19.7 in.).

- 1 Press  (macro mode).

The macro menu is displayed.





- 2 Use the multi selector to choose **ON** and press .

The macro mode icon () is displayed.

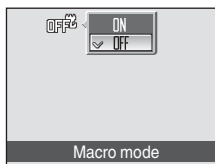
The monitor will return to the normal display for the current mode if the setting is not applied by pressing  within a few seconds.



- 3 Press **T** () or **W** () to frame the picture.

The camera can focus at distances as close as 15 cm (5.9 in.) from the lens when the  and the zoom indicator glow green (zoom indicator is over the )

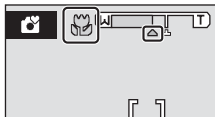

Macro Mode

In macro mode, the camera focuses continuously, even when the shutter-release button is not pressed halfway to lock focus. When the shutter-release button is halfway pressed, the focus is locked to adjust the exposure.

The Macro Mode Setting

In any macro mode selected in the shooting mode other than  (auto) mode, switching to another shooting mode or turning the camera off restores the default macro setting for each shooting mode.

Exposure Compensation

Exposure compensation is used to alter exposure from the value suggested by the camera to make pictures brighter or darker.

1 Press (exposure compensation).

The exposure compensation guide is displayed.



2 Use the multi selector to adjust exposure and press .

- When the picture is too dark: adjust the exposure compensation to "+" side.
- When the picture is too bright: adjust the exposure compensation to "-" side.
- Exposure compensation can be set to values between -2.0 and +2.0 EV.
- If a setting is not applied by pressing  within a few seconds, the selection will be cancelled.

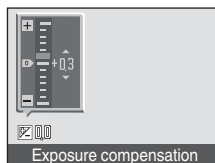

3 The setting is applied.

- The  icon and exposure compensation value are displayed in the monitor.

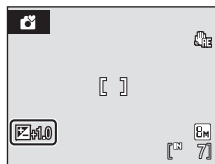

Exposure Compensation Value

Switching to another shooting mode or turning the camera off releases exposure compensation setting selected in the shooting mode other than  (auto) mode, and returns to **0.0**.

Using Exposure Compensation

The camera tends to lower exposure when the frame is dominated by brightly lit objects and to increase exposure when the frame is mostly dark. *Positive* compensation may therefore be required to capture the brilliancy of very bright objects that fill the frame (for example, sunlit expanses of water, sand, or snow) or when the background is much brighter than the main subject. *Negative* compensation may be called for when large areas of the frame contain very dark objects (for example, a swath of dark green leaves) or when the background is much darker than the main subject.

Shooting in the Auto Mode



In the  (auto) mode, you can set image mode, white balance, continuous shooting and color options in the shooting menu, and take pictures.

1 Press the shooting mode button in shooting mode.

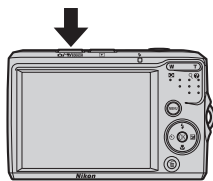
The shooting-mode selection menu will be displayed.



2 Press the multi selector ▲ or ▼ to choose and press **OK**.

- The camera enters  (auto) mode.
- Press **MENU** to select an option from the shooting menu.
 62

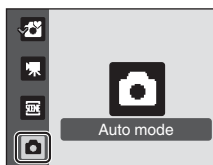

3 Frame the subject and shoot.

Camera focuses on the subject in the center of the monitor.



Focus Lock

To focus on off-center subject, use focus lock as described below.

- Be sure that the distance between the camera and the subject does not change while focus is locked.



Position the subject in the center of the frame.



Press the shutter-release button halfway.



Confirm that the focus area is green.







Continue holding down the shutter-release button halfway and recompose the picture.



Press the shutter-release button the rest of the way down.

Available Functions in (auto) Mode

In addition to the items in shooting menu, flash mode ( 26) can be changed and self-timer ( 28), macro mode ( 29) and exposure compensation ( 30) can be applied.

Shooting in the Scene Mode

Camera settings are automatically optimized for the selected subject type. The following scene modes are available.

Portrait	Party/indoor	Night landscape	Backlight
Landscape	Beach/snow	Close-up	Panorama assist
Sports	Sunset	Museum	
Night portrait	Dusk/dawn	Copy	

Setting the Scene Mode

- 1 Press the shooting mode button in shooting mode to display the shooting-mode selection menu and use the multi selector to choose and press .

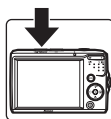

- 2 Press to display the scene menu screen, choose the desired scene and press .

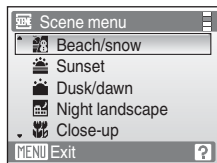
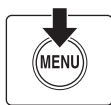

- 3 Frame the subject and shoot.



Image Mode

Image mode (63) can be set in the scene menu. The image mode setting can also be applied from the auto mode menu. Changes made to the image mode setting from any available menus apply to all shooting modes.

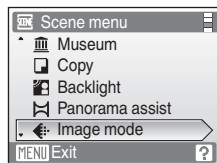

Features

Portrait

Use this mode for portraits in which the main subject stands out clearly. Portrait subjects exhibit smooth, natural-looking skin tones.

- Camera focuses on the subject in the center of the monitor.
- Digital zoom is not available.



* Other settings can be selected.

Landscape

Use this mode for vivid landscapes and cityscapes.

- Camera focuses at infinity. The focus area or the focus indicator (6) always glows green when the shutter-release button is pressed halfway. Note, however, that objects in the foreground may not always be in focus.



* Other settings can be selected.

Sports

Use this mode for dynamic action shots that freeze the action in a single shot and record motion in a series of pictures.

- While the shutter-release button is pressed halfway, the camera focuses continuously until focus is acquired and locked.
- While shutter-release button is held down, pictures are taken at rate of about 1.3 frames per second (fps) when image mode is set to **Normal (3264)** in L18 or when image mode is set to **Normal (3072)** in L16. This rate is maintained for up to 2 pictures.
- The maximum frame rate with continuous shooting may vary depending upon the current image mode setting and the memory card used.



* Other settings can be selected.

Icons Used for Descriptions

The following icons are used for descriptions in this section: flash mode (26); self-timer (28); macro mode (29); exposure compensation (30); AF-assist illumination (83).

Scene Mode Settings

Adjustments to the flash mode setting, self-timer setting, macro mode setting, and exposure compensation value applied in any scene mode are cancelled and these settings return to their default values whenever another shooting mode is selected or the camera is turned off.

Shooting in the Scene Mode

Night portrait



Use this mode to achieve a natural balance between the main subject and background lighting in portraits taken at night.

- Camera focuses on the subject in the center of the monitor.
- Digital zoom is not available.

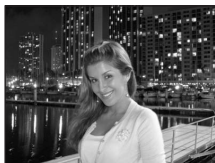

¹ Fill flash with slow sync and red-eye reduction.

² Other settings can be selected.

Party/indoor

Captures the effects of candlelight and other indoor background lighting.

- Camera focuses on the subject in the center of the monitor.
- As pictures are easily affected by camera shake, hold the camera steadily. In a dark place, use of a tripod is recommended.



¹ Fill flash with slow sync and red-eye reduction. Other settings can be selected.

² Other settings can be selected.

Beach/snow

Captures the brightness of such subjects as snowfields, beaches, or sunlit expanses of water.

- Camera focuses on the subject in the center of the monitor.
- The Anti-shake AE (AE 82) is set to **OFF**.



* Other settings can be selected.

: For those scene modes with , use of a tripod is recommended.

: For those scene modes with , noise reduction may be automatically applied as pictures taken are recorded; results in increased recording times.

Sunset



Preserves the deep hues seen in sunsets and sunrises.

- Camera focuses on the subject in the center of the monitor.





* Other settings can be selected.

Dusk/dawn



Preserves the colors seen in the weak natural light before sunrise or after sunset.

- Camera focuses at infinity. The focus area or the focus indicator ( 6) always glows green when the shutter-release button is pressed halfway. However, focus may not be set for near subjects, while the camera focuses at infinity.
- The Anti-shake AE ( 82) is set to **OFF**.



* Other settings can be selected.

Night landscape



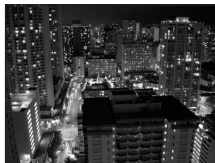

Slow shutter speeds are used to produce stunning night landscapes.

- Camera focuses at infinity. The focus area or the focus indicator ( 6) always glows green when the shutter-release button is pressed halfway. However, focus may not be set for near subjects, while the camera focuses at infinity.



* Other settings can be selected.

: For those scene modes with , use of a tripod is recommended.

: For those scene modes with , noise reduction may be automatically applied as pictures taken are recorded; results in increased recording times.

Shooting in the Scene Mode

Close-up

Photograph flowers, insects and other small objects at close-range. Macro mode (📷 29) is on and the zoom indicator is automatically moved to the closest focus position.

- The camera can focus at distances as close as 15 cm (5.9 in.) from the lens when the 🌸 and the zoom indicator glow green (zoom indicator is over the 📏).

The closest distance at which the camera can focus varies depending upon zoom position.

- While the shutter-release button is pressed halfway, the camera focuses continuously until focus is acquired and locked.
- As pictures are easily affected by camera shake, check the **Anti-shake AE** (📷 82) setting and hold the camera steadily.



* Other settings can be selected. Note that the flash may be unable to light entire subject at distances of less than 50 cm (19.7 in.).

Museum

Use indoors where flash photography is prohibited (for example, in museums and art galleries) or in other settings in which you do not want to use the flash.

- Camera focuses on the subject in the center of the monitor.
- BSS (📷 67) is available.
- As pictures are easily affected by camera shake, check the **Anti-shake AE** (📷 82) setting and hold the camera steadily.



* Other settings can be selected.

Copy

Provides clear pictures of text or drawings on a white board or in print.

- Camera focuses on the subject in the center of the monitor.
- Use macro mode (📷 29) to focus at short ranges.
- Colored text and drawings may not show up well.

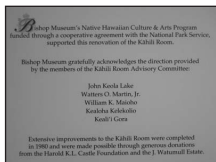

* Other settings can be selected.

Backlight

Use when light is coming from behind your subject, throwing features or details into shadow. The flash fires automatically to “fill in” (illuminate) shadows.

- Camera focuses on the subject in the center of the monitor.



* Other settings can be selected.

Panorama assist





Use when taking a series of pictures that will later be joined to form a single panorama using the supplied Panorama Maker software.



* Other settings can be selected.

Taking Pictures for a Panorama





The camera focuses on the subject in the center of the frame. Use a tripod for best results.

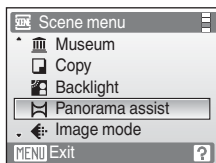





- 1 Use the multi selector to choose  **Panorama assist** in the scene menu and press **OK** ( 32).

The panorama direction icon () is displayed to show the direction in which pictures will be joined.



- 2 Use the multi selector to choose the direction and press **OK**.

Select how pictures will be joined together in the completed panorama; right () , left () , up () or down () .

The panorama direction icon () (yellow) is displayed to the direction pressed and the direction is fixed when **OK** is pressed. The fixed direction  (white) is displayed. Apply flash mode () 26, self-timer () 28, macro mode () 29 and exposure compensation () 30 settings with this step, if necessary. Press **OK** to reselect the direction.



- 3 Shoot the first picture.

The first picture is superimposed in the first third of the monitor.



- 4 Shoot the second picture.

Compose the next picture so that it overlaps the last third of the first picture and press the shutter-release button.

Repeat until you have taken the necessary number of pictures to complete the scene.

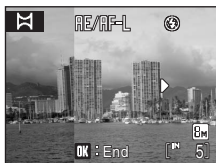

5 Press **OK** when shooting is completed.

The camera returns to step 2.



✓ **Panorama Assist**

Flash mode (P. 26), self-timer (P. 28), macro mode (P. 29) and exposure compensation (P. 30) settings cannot be adjusted after the first picture is taken. Pictures cannot be deleted, nor can zoom or image-mode setting (P. 63) be adjusted until the series is finalized.

The panorama series is terminated if the camera enters standby mode with the auto off function (P. 84) during shooting. Setting the time allowed to elapse before the auto off function is enabled to a longer setting is recommended.

🔍 **Exposure Lock**

AE/AF-L is displayed to indicate that white balance, exposure, and focus have been locked at the values set with the first shot. All pictures taken in a panorama series have the same white balance, exposure, and focus settings.

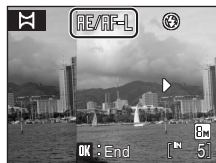



🔍 **Panorama Maker**

Install Panorama Maker from the supplied Software Suite CD. Transfer pictures to a computer (P. 51) and use Panorama Maker (P. 53) to join them in a single panorama.









🔍 **More Information**

See, "Image File and Folder Names" (P. 92) for more information.



Viewing Multiple Pictures: Thumbnail Playback

Press **W** () in full-frame playback mode ( 24) to display pictures in “contact sheets” of thumbnail images. The following operations can be performed while thumbnails are displayed.



To	Use	Description	
Choose pictures		Press the multi selector ▲ , ▼ , ◀ or ▶ .	9
Increase the number of pictures displayed (4 → 9 → 16 frames)	W ()	Press W ().	-
Decrease the number of pictures displayed (16 → 9 → 4 frames)	T ()	Press T ().	
Switch to full-frame playback		Press  .	24
Switch to shooting mode	 / SCENE	Press the shooting mode button to return to the last shooting mode selected.	8

Thumbnail Playback Mode Display

While pictures selected for printing ( 60) and protected pictures ( 89) are chosen, the icons shown at right are displayed with them. Movies are displayed as film frames.

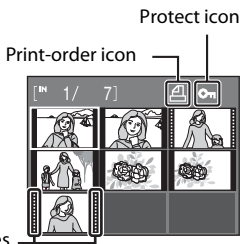

Taking a Closer Look: Playback Zoom

Pressing **T** (Q) during full-frame playback mode (24) zooms the current picture in 3x, with the center of the picture displayed in the monitor.

- The guide displayed in the right bottom in the monitor will show which part of the image is currently displayed.



The following operations can be performed while pictures are zoomed in.

To	Use	Description	24
Zoom in	T (Q)	Press T (Q) to enlarge view of picture currently displayed in monitor, up to about 10x.	–
Zoom out	W (24)	Press W (24). When the magnification ratio reaches 1x, the display returns to full-frame playback mode.	–
View other areas of picture		Press the multi selector ▲ , ▼ , ◀ or ▶ to scroll to areas of the picture not visible in the monitor.	9
Switch to full-frame playback	OK	Press OK .	24
Crop picture	MENU	Press MENU to crop current picture to contain only the portion visible in the monitor.	44
Switch to shooting mode		Press the shooting mode button to return to the last shooting mode selected.	8

More on Playback

Pictures taken in Face Priority

When pressing **T** (Q) during full-frame playback mode (24), the picture taken in Face Priority (20) will be enlarged using the face (which was focused on during shooting time) as the centralized point.

- If several faces are recognized, the picture will be enlarged using the face (which was focused on during shooting time) as the centralized point, and pressing the multi selector **▲**, **▼**, **◀** or **▶** will enable you to switch between the people's faces.
- Further pressing **T** (Q) or **W** (24) can change the magnification ratio and the pictures will be zoomed in as usual.



Editing Pictures

Use the COOLPIX L18/COOLPIX L16 to edit pictures in-camera and store them as separate files (📷 92). The editing features described below are available.

Editing function	Description
D-Lighting (📷 43)	Create a copy of the current picture with enhanced brightness and contrast, brightening dark portions of the picture.
Crop (📷 44)	Enlarge the image or refine the composition and create a copy containing only the portion visible in the monitor.
Small picture (📷 45)	Create a small copy of pictures suitable for use on web pages or as e-mail attachments.

Picture Editing

- Pictures taken at an image mode setting of **16:9** (📷 63) can not be edited.
- The COOLPIX L18/COOLPIX L16 editing or playback functions are not available for pictures taken with non-COOLPIX L18/COOLPIX L16 digital cameras.
- If a copy created using the COOLPIX L18/COOLPIX L16 is viewed on a different digital camera, the picture may not be displayed or may not be transferred to a computer.
- Editing functions are not available when there is not enough free space in the internal memory or on the memory card.

Restrictions on Picture Editing

(✓: available, -: not available)

1st editing	2nd editing		
	D-Lighting	Crop	Small picture
D-Lighting	-	✓	✓
Crop	-	-	-
Small picture	-	-	-

- Pictures cannot be edited twice with the same editing function.
- The D-Lighting should be done first while the restricted use of combination exists.

Original Pictures and Edited

- Copies created with editing functions are not deleted if the original pictures are deleted. The original pictures are not deleted if copies created with editing functions are deleted.
- Edited copies are stored with the same recording date and time as the original.
- Edited copies are not marked for printing (📷 60) or protecting (📷 89).

Enhancing Brightness and Contrast: D-Lighting

D-Lighting can be used to create copies with enhanced brightness and contrast, brightening dark portions of a picture. Enhanced copies are stored as separate files.

- 1 Select the desired picture from full-frame (📷 24) or thumbnail (📷 40) playback mode and press **MENU**.

The playback menu is displayed.

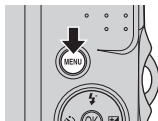

- 2 Use the multi selector to choose **D-Lighting** and press **OK**.

- The original picture is displayed at left and the picture applied with D-lighting enhancement is displayed at right.

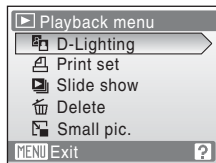

- 3 Choose **OK** and press **OK**.

A new copy with enhanced brightness and contrast is created.

To cancel D-Lighting, choose **Cancel** and press **OK**.



D-Lighting copies can be recognized by the 📷 icon displayed during playback.

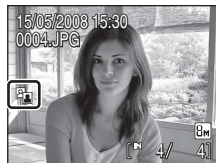

More Information

See, "Image File and Folder Names" (📷 92) for more information.

Creating a Cropped Copy: Crop



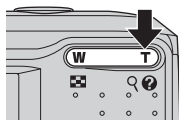

This function is only available when **MENU**  is displayed in the monitor with playback zoom ( 41) enabled. Cropped copies are stored as separate files.

1 Press **T** (Q) in full-frame playback mode to zoom in on the image.

- The image displayed in full-frame playback mode and in "tall" orientation can be cropped if the image is enlarged to fill the horizontal screen or larger.



2 Refine copy composition.

- Press **T** or **W** to adjust the zoom ratio.
- Press the multi selector , ,  or  to scroll the picture until only the portion you want to copy is visible in the monitor.

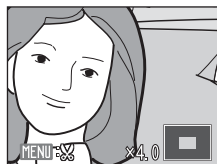

3 Press **MENU**.

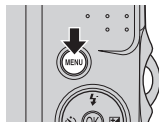















4 Use the multi selector to choose **Yes** and press **OK**.

- A new picture, containing only the portion visible in the monitor, is created.
- Choose **No** to cancel the creation of a new picture and press **OK**.



Depending on the size of the original picture and the zoom ratio in effect at the time the copy was created, the camera will automatically select one of the following image-mode settings for cropped copies (unit: pixels).

- | | | |
|--|---|---|
| •  3,264 × 2,448 (L18 Only) | •  3,072 × 2,304 | •  2,816 × 2,112 |
| •  2,592 × 1,944 | •  2,272 × 1,704 | •  2,048 × 1,536 |
| •  1,600 × 1,200 | •  1,280 × 960 | •  1,024 × 768 |
| •  640 × 480 | •  320 × 240 | •  160 × 120 |



When the image-mode setting for cropped copies is 320 × 240 or 160 × 120, these pictures are framed with a gray border in playback mode, and Small Picture icon  or  is displayed in the left side of the monitor.



More Information

See, "Image File and Folder Names" ( 92) for more information.

Resizing Pictures: Small Picture

Create a small copy of the current picture. Small copies are stored as JPEG files with a compression ratio of 1:16. The following sizes are available.

Option	Description
 640×480	Suited to television playback.
 320×240	Suited to display on web pages.
 160×120	Suitable for e-mail attachments.

- 1 Select the desired picture from full-frame ( 24) or thumbnail ( 40) playback mode and press **MENU**.

The playback menu is displayed.

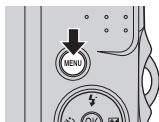

- 2 Use the multi selector to choose **Small pic.** and press **OK**.

- Press **MENU** to return to the playback mode without creating a new picture.

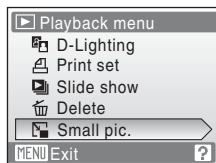

- 3 Choose the desired copy size and press **OK**.

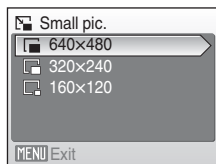

- 4 Choose **Yes** and press **OK**.

- A new, smaller copy is created.
- Choose **No** to cancel the creation of a new picture and press **OK**.
- The copy is displayed with a gray frame.

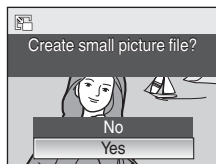



More Information

See, "Image File and Folder Names" ( 92) for more information.

Recording Movies

To shoot movies with sound recorded via the built-in microphone, select shooting mode and follow the steps below.

- 1 Press the shooting mode button in shooting mode to display the shooting-mode selection menu and use the multi selector to choose  and press .

- The maximum length of the movie that can be recorded and the movie options ( 47) icon are displayed in the monitor.

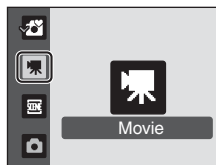
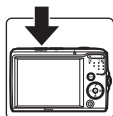

- 2 Press the shutter-release button all the way down to start recording.





A progress bar at the bottom of the monitor shows the amount of recording time remaining.

Camera focuses on subject in center of frame.

To end recording, press the shutter-release button all the way down a second time.



Recording Movies

- Macro mode () 29) is available in all modes. Flash mode () 26), self-timer () 28), and exposure compensation () 30) cannot be used.
- Macro mode settings cannot be applied or changed while movies are being recorded. Apply or change settings as necessary before movie recording begins.
- Once movie recording begins, optical zoom cannot be adjusted. Digital zoom (up to 2x) can be applied while movies are being recorded.

Autofocus

Camera focuses when the shutter-release button is pressed halfway and locks the focus (AF lock) at this position by holding the shutter-release button halfway down. The focus is set to this position during recording.

Changing Movie Settings



Movie options can be changed ( 47).

The Movie Menu



Movie options setting can be changed from the movie menu. Press **MENU** in movie mode to display the movie menu and use the multi selector to modify and apply settings.

Selecting Movie Options

The movie menu offers the options shown below.

Option	Image size and frame rate
 TV movie 640★ (default setting)	Image size: 640 × 480 pixels Frame rate: 30 frames per second
 Small size 320★	Image size: 320 × 240 pixels Frame rate: 30 frames per second
 Small size 320	Image size: 320 × 240 pixels Frame rate: 15 frames per second

Movie Options and Maximum Movie Length and Frames

Option	Internal memory (approx. 21 MB)	Memory card (256 MB)
 TV Movie 640★ (default setting)	12 s	2 min 30 s
 Small size 320★	51 s	10 min 30 s
 Small size 320	1 min 43 s	21 min

* All figures are approximate. Maximum movie length varies with make of memory card. The maximum file size that can be recorded is 2 GB.

Even if the memory card has a capacity greater than 4 GB, the camera displays the maximum movie length for the file size of 2 GB.

More Information

See, "Image File and Folder Names" ( 92) for more information.

Movie Playback

In full-frame playback mode (F 24), movies are recognized by the movie options (F 47) icon. To play a movie, display it in full-frame playback mode and press **OK**.



Use the zoom buttons to adjust playback volume. Playback controls appear at the top of the monitor. Press the multi selector ◀ or ▶ to choose a control, then press **OK** to perform the selected operation. The following operations are available.

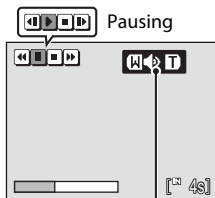

Volume indicator
During playback

To	Press	Description	
Rewind	◀	Rewind movie. Playback resumes when OK is released.	
Advance	▶	Advance movie. Playback resumes when OK is released.	
Pause	⏸	Pause playback. While paused, use the multi selector to advance or rewind the movie. The following operations can be performed while playback is paused.	
		◀	Rewind movie by one frame. Rewind continues while OK is pressed.
		▶	Advance movie by one frame. Advance continues while OK is pressed.
	▶	Resume playback.	
End	⏹	End playback and return to full-frame playback.	

Deleting Movie Files

Press **⏹** when displayed in full-frame playback mode (F 24) or when selected in thumbnail (F 40) playback mode. A confirmation dialog is displayed. Choose **Yes** and press **OK** to delete the movie, or choose **No** and press **OK** to return to the normal playback display without deleting the movie.

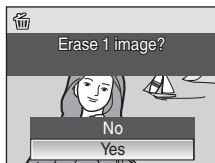

Connecting to a TV

Connect the camera to a television using the supplied A/V cable (supplied only with the COOLPIX L18) to play back pictures on the television.

1 Turn the camera off.

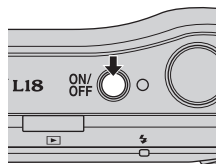

2 Connect the camera to the TV using the supplied A/V cable.

Connect the yellow plug to the video-in jack on the TV, and the white plug to the audio-in jack.

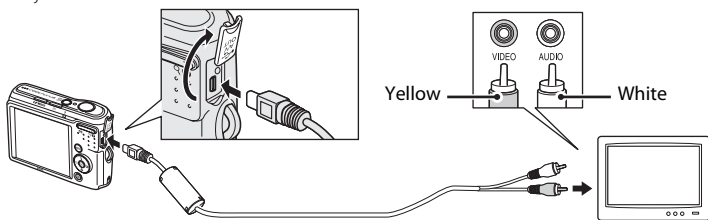

3 Tune the television to the video channel.

See the documentation provided with your television for details.

4 Turn the camera on.

5 Press .

The camera monitor will remain off and the image normally shown in the monitor will be displayed on the television.

While connected to the TV, the camera monitor will remain off.

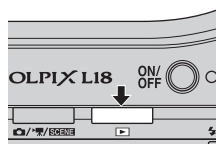

Connecting the A/V Cable

- When connecting the A/V cable, be sure that the camera connector is oriented correctly. Do not use force when connecting the A/V cable to the camera. When disconnecting the A/V cable, do not pull the connector at an angle.
- Do not pinch the connector cover between the camera's A/V connector and the A/V cable connector when connecting the cable to the camera.

Video Mode

Be sure that the camera's video mode setting conforms to the standard used by your television. The video mode setting is an option set in the setup menu (F74) > **Video mode** (F86).

Connecting to a Computer

When the camera is connected to a computer using the supplied USB cable, pictures recorded with the camera can be copied (transferred) to the computer for storage using the Nikon Transfer software.

Before Connecting the Camera

Installing the Software

Before connecting the camera to a computer, software, including Nikon Transfer and Panorama Maker for creating panorama images, must be installed from the supplied Software Suite CD. For more information on installing the software, refer to the *Quick Start Guide*.

Operating Systems Compatible with COOLPIX L18/COOLPIX L16

Windows

Preinstalled versions of Windows Vista (32-bit Home Basic/Home Premium/Business/Enterprise/Ultimate editions), Windows XP Service Pack 2 (Home Edition/Professional)

If your computer is running Windows 2000 Professional, use a card reader or similar device to transfer pictures stored on the memory card to the computer (▶ 53).

Macintosh

Mac OS X (version 10.3.9, 10.4.11)

Refer to the Nikon website for the latest information on operating system compatibility.

Note on Power Source

- When connecting the camera to a computer or printer, use fresh batteries to prevent the camera from turning off unexpectedly.
- To power the camera continuously for extended periods, use an EH-65A AC adapter (available separately). Do not, under any circumstances, use another make or model of AC adapter. Failure to observe this precaution could result in overheating or in damage to the camera.

Transferring Pictures from the Camera to a Computer

- 1 Start the computer to which Nikon Transfer was installed.
- 2 Turn off the camera.
- 3 Connect the camera to the computer using the supplied USB cable.

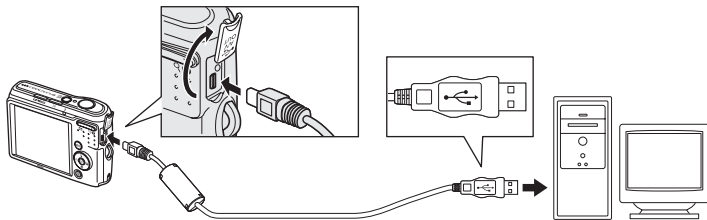

- 4 Turn on the camera.

Windows Vista

When the AutoPlay dialog is displayed, select **Copy pictures to a folder on my computer using Nikon Transfer**. To bypass this dialog in the future, check **Always do this for this device**: Nikon Transfer will start.

Windows XP

When the AutoPlay dialog is displayed, select **Nikon Transfer Copy pictures to a folder on my computer**, and click **OK**. To bypass this dialog in the future, check **Always use this program for this action**. Nikon Transfer will start.

Mac OS X

Nikon Transfer will start automatically if **Yes** was selected in the Auto-Launch setting dialog when Nikon Transfer was first installed.

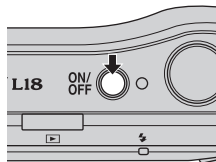

✓ Connecting the USB Cable

When connecting the USB cable, be sure that the connectors are oriented correctly. Do not use force when connecting the USB cable. When disconnecting the USB cable, do not pull the connector at an angle.

Do not pinch the connector cover between the camera's USB connector and the USB cable connector when connecting the cable to the camera.

Connection may not be recognized when the camera is connected to a computer via a USB hub.

5 Transfer pictures when Nikon Transfer has finished loading.

Click **Start Transfer** in Nikon Transfer. At the default setting, all pictures are transferred to the computer.

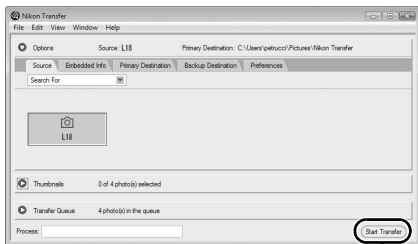

Start Transfer button

At the Nikon Transfer default setting, the folder to which pictures are transferred is automatically opened when transfer is complete.

For more information on using Nikon Transfer, refer to help information contained in Nikon Transfer.

6 Disconnect the camera when transfer is complete.

Turn the camera off and disconnect the USB cable.

For Users of Windows 2000 Professional

Use a card reader or similar device to transfer the pictures stored on the memory card to the computer.

If the memory card has a capacity greater than 2 GB, or is SDHC-compliant, the intended device must support these features of the memory card.

- At the Nikon Transfer default settings, Nikon Transfer will start automatically when a memory card is inserted into the card reader or similar device. See step 5 above to transfer pictures.
- Do not connect the camera to the computer. If the camera is connected to the computer, the **Found New Hardware Wizard** dialog will be displayed. Select **Cancel**, close the dialog, and disconnect the camera from the computer.
- To transfer pictures stored in the camera's internal memory to the computer, the pictures must first be copied to a memory card using the camera (📷 89).



Using Standard OS Operations to Open Camera Files

Navigate to the folder on the computer's hard disk to which pictures were saved and open a picture in the viewer supplied with your operating system.



Panorama Creation with Panorama Maker

- Use a series of pictures taken using the **Panorama assist** option in scene mode (📷 38) to create a single panorama photo with Panorama Maker.
- Panorama Maker can be installed to a computer using the supplied Software Suite CD.
- After installation is complete, follow the procedure described below to start Panorama Maker.

Windows

Open **All Programs (Programs** under Windows 2000) from the **Start** menu > **ArcSoft Panorama Maker 4** > **Panorama Maker 4**.

Macintosh

Open Applications by selecting **Applications** from the **Go** menu, and double-click the **Panorama Maker 4** icon.

- For more information on using Panorama Maker, refer to the on-screen instructions and help information contained in Panorama Maker.

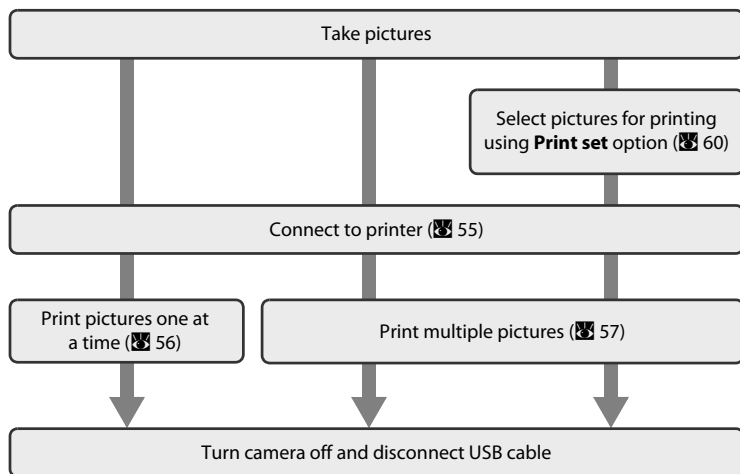

Image File Names and Folder Names

See, "Image File and Folder Names" (📷 92) for more information.

Connecting to a Printer

Users of PictBridge-compatible (📷 107) printers can connect the camera directly to the printer and print pictures without using a computer.



✔ Note on Power Source

- When connecting the camera to a computer or printer, use fresh batteries to prevent the camera from turning off unexpectedly.
- To power the camera continuously for extended periods, use an EH-65A AC adapter (available separately). Do not, under any circumstances, use another make or model of AC adapter. Failure to observe this precaution could result in overheating or in damage to the camera.

💡 Printing Pictures

In addition to printing pictures transferred to a computer from your personal printer and printing over a direct camera-to-printer connection, the following options are also available for printing pictures:

- Insert a memory card into a DPOF-compatible printer's card slot
- Take a memory card to a digital photo lab

For printing using these methods, specify the pictures and the number of prints each using your camera's print set menu (📷 60).

Connecting the Camera and Printer

- 1 Turn off the camera.

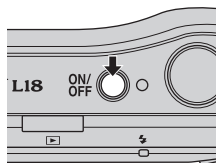

- 2 Turn on the printer.

Check printer settings.

- 3 Connect the camera to the printer using the supplied USB cable.

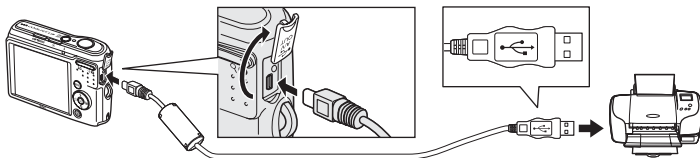

- 4 Turn on the camera.

When connected correctly, the PictBridge startup screen ① will be displayed in the camera monitor. Then the print selection screen will be displayed ②.

① will be displayed in the camera monitor. Then the print selection screen will be displayed ②.

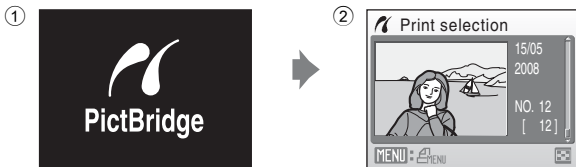
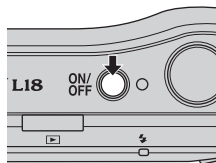

✓ Connecting the USB Cable

- When connecting the USB cable, be sure that the connectors are oriented correctly. Do not use force when connecting the USB cable. When disconnecting the USB cable, do not pull the connector at an angle.
- Do not pinch the connector cover between the camera's USB connector and the USB cable connector when connecting the cable to the camera.

Printing Pictures One at a Time

After connecting the camera to the printer correctly (▶ 55), print pictures by following the procedure below.

- 1 Use the multi selector to choose the desired picture and press **OK**.

Press **W** (◻) to switch to thumbnail display.

Press **T** (Ⓚ) to switch back to full-frame playback.

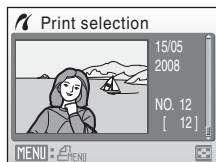

- 2 Choose **Copies** and press **OK**.

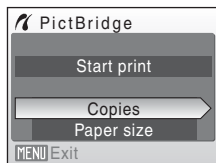

- 3 Choose the number of copies (up to nine) and press **OK**.

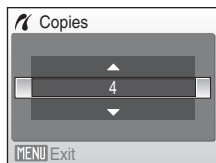

- 4 Choose **Paper size** and press **OK**.

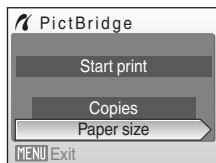

5 Choose the desired paper size and press **OK**.

To specify paper size using printer settings, choose **Default** in the paper size menu.

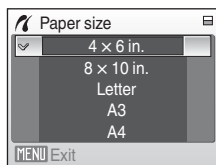
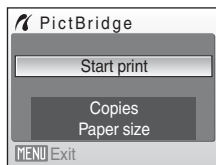
**6** Choose **Start print** and press **OK**.**7** Printing starts.

Monitor display returns to that shown in step 1 when printing is complete.

To cancel before all copies have been printed, press **OK**.

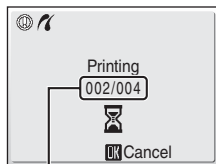

Current print/total number of prints

Printing Multiple Pictures

After connecting the camera to the printer correctly (☒ 55), print pictures by following the procedure below.

1 When the print selection screen is displayed, press **MENU**.

The print menu is displayed.

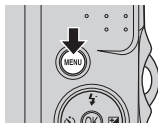
**2** Use the multi selector to choose **Paper size** and press **OK**.

- Press the **MENU** to exit the print menu.

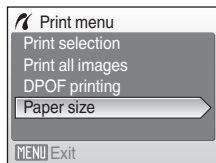

3 Choose the desired paper size and press **OK**.

To specify paper size using printer settings, choose **Default** in the paper size menu.

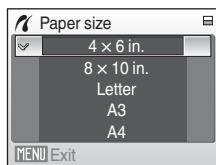
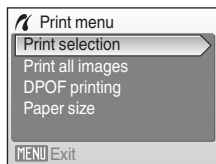
**4** Choose **Print selection**, **Print all images** or **DPOF printing** and press **OK**.**Print selection**

Choose the pictures and number of copies (up to nine) of each.

Press the multi selector **◀** or **▶** to select pictures, and press **▲** or **▼** to set the number of copies for each.

Pictures selected for printing can be recognized by the check mark (✓) and the numeral indicating the number of copies to be printed. A check mark is not displayed with pictures for which no copies have been specified and these pictures will not be printed.

Press **T** (📄) to switch to full-frame playback.

Press **W** (🖼️) to switch back to thumbnail display.

Press **OK** when setting is complete.

The menu shown at right will be displayed.

To print, choose **Start print** and press **OK**.

Choose **Cancel** and press **OK** to return to the print menu.

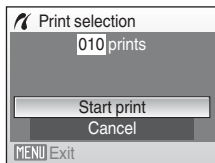
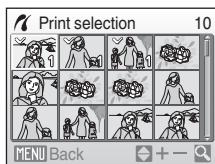

Print all images

All pictures stored in the internal memory, or on the memory card, are printed one at a time. The menu shown at right will be displayed. To print, choose **Start print** and press **OK**. Choose **Cancel** and press **OK** to return to the print menu.

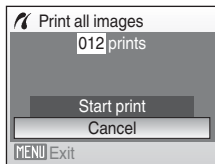
**DPOF printing**

Print pictures for which a print order was created in **Print set** (60).

- The menu shown at right will be displayed.
- To print, choose **Start print** and press **OK**.
- Choose **Cancel** and press **OK** to return to the print menu.
- To view the current print order, choose **View images** and press **OK**. To print pictures, press **OK** again.

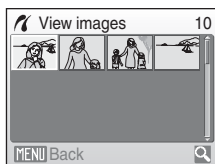
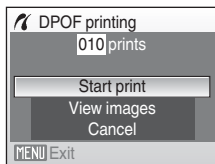
**5 Printing starts.**

Monitor display returns to the print menu (step 2) when printing is complete.

To cancel before all copies have been printed, press **OK**.

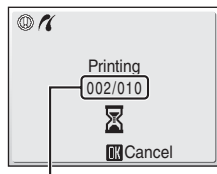

Current print/total number of prints

✓ Paper Size

The camera supports the following paper sizes: **Default** (the default paper size for the current printer), **3.5 x 5 in.**, **5 x 7 in.**, **Postcard**, **100 x 150 mm**, **4 x 6 in.**, **8 x 10 in.**, **Letter**, **A3**, and **A4**. Only sizes supported by the current printer will be displayed. To specify paper size using printer settings, choose **Default** in the paper size menu.

Creating a DPOF Print Order: Print Set

The **Print set** option in the playback menu is used to create digital “print orders” for printing on DPOF-compatible devices (📷 107).

When the camera is connected to a PictBridge-compatible printer, pictures can be printed from the printer according to the DPOF print order you have created for pictures on the memory card. If the memory card is removed from the camera, you can create the DPOF print order for pictures in the internal memory and print pictures according to the DPOF print order.

1 Press **MENU** in playback mode.

The playback menu is displayed.

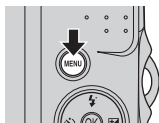

2 Use the multi selector to choose **Print set** and press **OK**.

The print set menu is displayed.

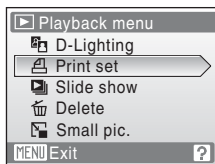

3 Choose **Select images** and press **OK**.

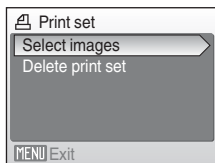

4 Choose the pictures and number of copies (up to nine) of each.

Press the multi selector ◀ or ▶ to choose the desired pictures. Press ▲ or ▼ to set the number of copies for each.

Pictures selected for printing can be recognized by the check mark (✔) icon and the numeral indicating the number of copies to be printed. A check mark is not displayed with pictures for which no copies have been specified and these pictures will not be printed.

Press **T** (📷) to switch to full-frame playback.

Press **W** (📷) to switch back to thumbnail display.

Press **OK** when setting is complete.

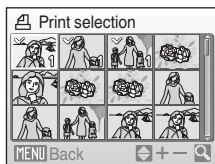



5 Choose whether or not to also print shooting date and photo information.

Choose **Date** and press **OK** to print date of recording on all pictures in the print order.

Choose **Info** and press **OK** to print shutter speed and aperture on all pictures in the print order.

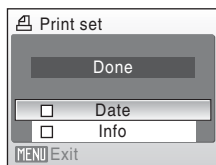
Choose **Done** and press **OK** to complete the print order and exit.



Pictures selected for printing are recognized by the  icon displayed with playback.

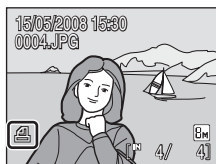

Note on Printing with Date and Photo Information

Date and **Info** options selected in the print set menu can be printed on pictures from a DPOF-compatible ( 107) printer which can print Date and Info Options.

- Note that Info Option cannot be printed on pictures if you connect the camera to a printer through the supplied USB cable and choose **DPOF printing** ( 58).
- **Date** and **Info** are reset each time the print set menu is displayed.

Deleting All Print Orders

Choose **Delete print set** in step 3 and press **OK**. Print orders for all pictures will be deleted.

Note on the Print Set Date Option

The date and time printed on pictures with DPOF printing when **Date** in the print set menu is enabled, are those recorded with the picture when it was taken. Date and time printed using this option are not affected when the camera's date and time setting are changed from the setup menu after pictures are recorded.



Date Imprint

When using **Date imprint** ( 81) in the setup menu, shooting date will be imprinted on pictures. If you use such pictures, date can be printed from printers that do not support the date imprinting.

Only the imprinted date is printed on pictures even if **Date** is selected from the **Print Set**.

Shooting Options: The Shooting Menu

The shooting menu in auto mode (📷 31) contains the following options.

📷	Image mode ¹	📷 63
	Choose image size and quality.	
WB	White balance ²	📷 65
	Match white balance to the light source.	
📷	Continuous ²	📷 67
	Continuous and BSS settings can be applied.	
📷	Color options ²	📷 68
	Apply color effects to pictures as they are recorded.	
🔧	Set up ³	📷 74
	Display the setup menu.	

¹ **Image mode** setting can be applied in the scene mode menus.

² See the information on restrictions that may apply to these settings (📷 69).

³ **Set up** can be selected from other shooting mode menus.

Displaying the Shooting Menu

Press the shooting mode button in shooting mode to display the shooting-mode selection menu and set the shooting menu to 📷 (auto) mode.



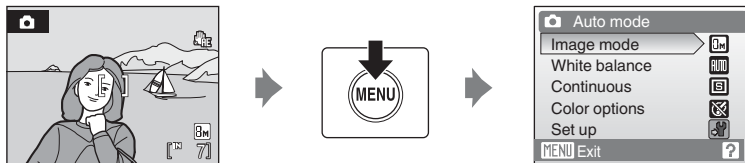





Press **MENU** to display the shooting menu.



- To choose menus and apply selection, use the multi selector (📷 9).
- To exit the shooting menu, press **MENU**.

← Image Mode

Pictures taken with a digital camera are recorded as image files. The size of the files, and with it the number of images that can be recorded, depends on the size and quality of the images. Before shooting, choose an image mode according to how you plan to use the picture.

Option	Size (Pixels)	Description
 High (3264★) (L18 Only)	3,264 × 2,448	Highest quality, suitable for enlargements or high-quality prints. The compression ratio is approximately 1:4.
 High (3072★) (L16 Only)	3,072 × 2,304	
 Normal (3264) ¹ (L18 Only)	3,264 × 2,448	Best choice in most situations. The compression ratio is approximately 1:8.
 Normal (3072) ² (L16 Only)	3,072 × 2,304	
 Normal (2592)	2,592 × 1,944	
 Normal (2048)	2,048 × 1,536	Smaller size allows more pictures to be stored. The compression ratio is approximately 1:8.
 PC Screen (1024)	1,024 × 768	Suited to display on a computer monitor. The compression ratio is approximately 1:8.
 TV Screen (640)	640 × 480	Suited to full-screen display on a television, or distribution by e-mail or the web. The compression ratio is approximately 1:8.
 16:9 (1920)	1,920 × 1,080	Pictures with an aspect ratio of 16:9 can be taken. The compression ratio is approximately 1:8.

¹ Default setting for L18

² Default setting for L16

The icon for the current setting is displayed in the monitor in shooting and playback modes ( 6, 7).

Image Mode









The image mode setting can also be applied from the scene mode menu. Changes made to the image mode setting from any available menus apply to all shooting modes.

The image mode setting cannot be applied in the easy auto mode.

 Normal (3,264) with L18 and  Normal (3,072) with L16 are fixed.

Number of Exposures Remaining

The following table lists the approximate number of pictures that can be stored in internal memory and on a 256 MB memory card. Note that the number of pictures that can be stored will differ depending on the composition of the picture (due to JPEG compression). In addition, this number may differ depending on the make of memory card, even if the capacity for the memory card is the same.

Setting	Internal memory (approx.21 MB)	Memory card ¹ (256 MB)	Print size (printed at 300 dpi; cm/in.) ²
 High (3264★) (L18 Only)	3	45	28 × 21/11.0 × 8.2
 High (3072★) (L16 Only)	4	50	26 × 19.5/10 × 7.7
 Normal (3264) (L18 Only)	7	95	28 × 21/11.0 × 8.2
 Normal (3072) (L16 Only)	8	105	26 × 19.5/10 × 7.7
 Normal (2592)	12	150	22 × 16.5/8.8 × 6.6
 Normal (2048)	19	245	17 × 13/6.8 × 5.2
 PC Screen (1024)	79	985	9 × 7/3.6 × 2.8
 TV Screen (640)	102	1260	5 × 4/2 × 1.6
 16:9 (1920)	30	370	16 × 9/6.3 × 3.5

¹ If the number of exposures remaining is 10,000 or more, the number of exposures remaining display shows **9999**.

² Print sizes are calculated by dividing the number of pixels by printer resolution (dpi) and multiplying by 2.54 cm (1 in.). However, at the same image size, pictures printed at higher resolutions will print smaller than the size indicated, and those printed at lower resolutions will print larger than the size indicated.

WB White Balance

The color of light reflected from an object varies with the color of the light source. The human brain is able to adapt to changes in the color of the light source, with the result that white objects appear white whether seen in the shade, direct sunlight, or under incandescent lighting. Digital cameras can mimic this adjustment by processing images according to the color of the light source. This is known as “white balance.” For natural coloration, choose a white balance setting that matches the light source before shooting. Although the default setting, **Auto**, can be used under most types of lighting, you can apply the white balance setting suited to a particular light source to achieve more accurate results.

Auto (default setting)

White balance automatically adjusted to suit lighting conditions. Best choice in most situations.

Preset manual

Neutral-colored object used as reference to set white balance under unusual lighting conditions.
See, “Preset Manual” ( 66) for more information.

Daylight

White balance adjusted for direct sunlight.

Incandescent

Use under incandescent lighting.

Fluorescent

Use under most types of fluorescent lighting.

Cloudy

Use when taking pictures under overcast skies.

Flash

Use with the flash mode.

The effects of the selected option can be previewed in the monitor. At settings other than **Auto**, the icon for the current setting is displayed in the monitor ( 6).

Flash Mode

At white-balance settings other than **Auto** or **Flash**, turn the flash off (  26).

Preset Manual

Preset manual is used with mixed lighting or to compensate for light sources with a strong color cast (for example, to make pictures taken under a lamp with a red shade look as though they had been taken under white light).

1 Place a white or gray reference object under the lighting that will be used during shooting.

2 Use the multi selector to choose **PRE Preset manual** in the white balance menu, and press **OK**.

The camera zooms in.

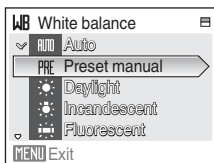

3 Choose **Measure**.

To apply the most recently measured value for preset manual, choose **Cancel** and press **OK**.

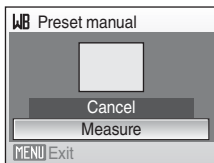

4 Frame the reference object.

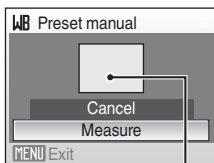

Reference object frame

5 Press **OK**.

The shutter is released and the new white-balance value is set.
No pictures are recorded.

Note on Preset Manual

Regardless of the flash mode selected, the flash will not fire when **OK** is pressed in step 5. Therefore, the camera cannot measure a value for preset manual for when the flash is used.



Continuous

Motion is captured in a series of pictures. **Continuous** and **BSS** settings can be applied. If any setting other than **Single** is applied, flash mode is set to off. Focus, exposure and white balance are fixed at the values for the first picture in each series.

Single (default setting)

One shot is taken each time shutter-release button is pressed.

Continuous



While shutter-release button is held down, pictures are taken at rate of about 1.3 frames per second (fps) when image mode is set to  **Normal (3264)** in L18 or when image mode is set to  **Normal (3072)** in L16. This rate is maintained for up to 2 pictures.

Best Shot Selector (BSS)

The “best shot selector” is recommended when shooting with the flash off or the camera zoomed in, or in other situations in which inadvertent motion can result in blurred pictures. When BSS is on, the camera takes up to ten pictures while the shutter-release button is held down. The sharpest picture in the series is automatically selected and saved.

Multi-shot 16

Each time shutter-release button is pressed, camera takes 16 shots at about 1.3 frames per second and arranges them in a single picture.

The recorded image mode will be fixed to  **Normal (3264)** in L18, and to  **Normal (3072)** in L16.

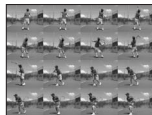

At settings other than **Single**, the indicator for the current setting is displayed in the monitor ( 6).

Note on Continuous Shooting

The maximum frame rate with continuous shooting may vary, depending upon the current image mode setting and the memory card used.

Note on Best Shot Selector

BSS may not produce the desired results if the subject moves or the composition changes while the shutter-release button is pressed all the way down.

Color Options

Make colors more vivid or record pictures in monochrome.



Standard color (default setting)

Use for pictures exhibiting natural color.



Vivid color

Use to achieve a vivid, “photoprint” effect.



Black-and-white

Record pictures in black-and-white.



Sepia

Record pictures in sepia tones.



Cyanotype

Record pictures in cyan-blue monochrome.

The effects of the selected option can be previewed in the monitor. At settings other than **Standard color**, the icon for the current setting is displayed in the monitor ( 6).

Restrictions on Camera Settings

Restrictions apply to the following settings in  (auto) mode.



Flash mode

Flash turns off at **Continuous** settings of **Continuous**, **Multi-shot 16** or **BSS**. Applied setting is restored when **Single** is selected.

Self-timer

If self-timer is on, only one shot will be taken when shutter is released, regardless of settings chosen for **Continuous**. Applied **Continuous** settings is restored when picture is taken or self-timer is turned off.

Continuous











Selecting **Multi-shot 16** fixes image mode setting to  **Normal (3264)** (L18)/ **Normal (3072)** (L16). Selecting a mode other than **Multi-shot 16** from **Continuous** returns the previous image mode.

White balance

White balance is automatically set to **Auto** and cannot be adjusted when **Black-and-white**, **Sepia** or **Cyanotype** is selected for **Color options**. Applied white balance setting is restored when **Standard color** or **Vivid color** is selected.

Playback Options: The Playback Menu

The playback menu contains the following options.

 D-lighting  43
Enhance brightness and contrast in dark portions of the pictures.
 Print set  60
Select pictures to print and the number of copies for each.
 Slide show  72
View pictures stored in the internal memory or on a memory card in an automatic slide show.
 Delete  73
Delete all or selected pictures.
 Small pic.  45
Create a small copy of the current picture.

Displaying the Playback Menu

Press  to enter playback mode.

Display the playback menu by pressing **MENU**.

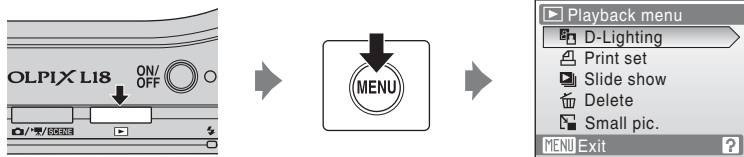

- Use the multi selector to choose and apply settings ( 9).
- To exit the playback menu, press **MENU**.

Selecting Multiple Pictures

To select multiple pictures, the screen shown at right is displayed in the menus below.

- Playback menu: Print set (🖨️ 60) and deletion (🗑️ 73)
- Set up menu: Welcome screen (👤 76), protect (🔒 89) and copy (📄 89)

Follow the procedure described below to select multiple pictures.

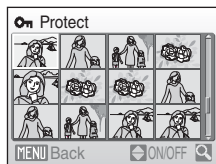

1 Press the multi selector ◀ or ▶ to choose the desired picture.

Only one picture can be selected for **Welcome screen**. Proceed to step 3.

Press **T** (🔍) to switch to full-frame playback.

Press **W** (📄) to switch back to thumbnail display.

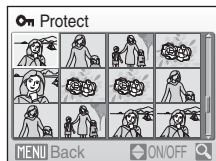

2 Press ▲ or ▼ to select **ON** or **OFF** (or the number of copies).

When **ON** is selected, a check mark (✓) is displayed in the top left corner of the current picture. Repeat steps 1 and 2 to select additional pictures.

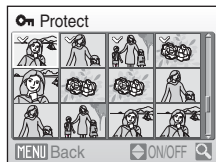

3 Press **OK**.

The setting is enabled.

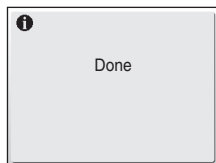

Slide Show

Play back pictures, stored in the internal memory or on a memory card, one by one in an automated “slide show.”

- 1 Use the multi selector to choose **Start** and press **OK**.

To repeat the slide show automatically, enable **Loop** and press **OK** before choosing **Start**. The check mark (✓) will be added to the loop option when enabled.

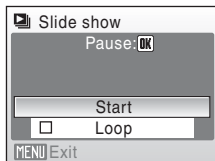

- 2 The slide show begins.

While the slide show is in progress, the following operations can be performed:

- Use the multi selector to switch pictures. Hold ◀ or ▶ down to fast rewind or forward.
- Press **OK** to pause the slide show.



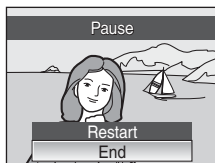

- 3 Choose **End** or **Restart**.

When the slide show ends or is paused, choose **End** and press **OK** to return to the playback menu, or choose **Restart** to play the slide show again.



Notes on Slide Show

- Only the first frame of movies ( 48) included in slide shows is displayed.
- Even if **Loop** is selected, the monitor can continuously display the Slide Show for up to 30 minutes ( 84).

Delete

Delete selected pictures or all pictures.

Erase selected images

Delete selected pictures ( 71).

Erase all images

Delete all pictures.

Notes on Deletion

- Once deleted, pictures cannot be recovered. Transfer important images to a computer before deletion.
- Pictures marked with the  icon are protected and cannot be deleted.

Basic Camera Setup: The Setup Menu

The setup menu contains the following options.

	Menu	 76
	Choose how menus are displayed.	
	Welcome screen	 76
	Select screen displayed when camera is turned on.	
	Date	 77
	Set camera clock and choose home and destination time zones.	
	Monitor settings	 80
	Adjust monitor brightness and choose display style.	
	Date imprint	 81
	Imprint date or date counter on pictures.	
	Anti-shake AE	 82
	Increase the shutter speed and adjust the anti-shake AE settings for shooting.	
	AF assist	 83
	Enable or disable AF-assist illumination.	
	Sound settings	 83
	Adjust sound settings.	
	Auto off	 84
	Set time before camera enters standby mode.	
	Format memory/Format card	 85
	Format internal memory or memory card.	
	Language	 86
	Choose the language used for camera monitor display.	
	Video mode	 86
	Adjust settings necessary for connection to television.	
	Reset all	 87
	Restore camera settings to default values.	
	Battery type	 89
	Choose type of batteries inserted in camera.	
	Protect	 89
	Protect selected pictures from accidental deletion.	
	Copy	 89
	Copy files between memory card and internal memory.	
	Firmware version	 90
	Display camera firmware version.	

Displaying the Setup Menu

(easy auto) mode

Press **MENU** to display the setup menu.

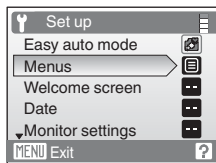
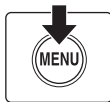

Auto Mode, Scene Mode, and Movie Mode

Press **MENU** to display the shooting menu and use the multi selector to choose **Set up**. Press **OK** to display the setup menu.

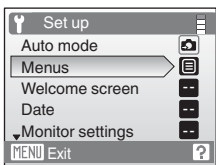
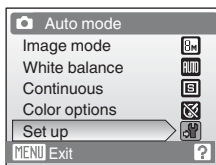

Press the multi selector **▲** or **▼** to choose **Set up** and press **OK**.

- To choose menus and apply selection, use the multi selector (**9**).
- To exit the setup menu, press **MENU**.

Menus

Choose the initial menu displayed.

Text (default setting)

Text labels for menus are displayed in list format.

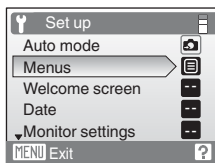

Icons

All menu items can be displayed in a single page.

Menu names

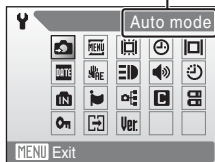

Welcome Screen

You can select the welcome screen to be displayed when the camera is turned on.

None (default setting)

A welcome screen is not displayed when the camera is turned on.

COOLPIX

Displays a welcome screen when the camera is turned on.

Select an image

Select a picture in the internal memory or on the memory card for the welcome screen. Choose a picture in the picture selection screen ( 71) and press **OK**. As the selected image is stored in the camera, the image will appear in the welcome screen even if the original picture is deleted.

Pictures which are set as **16:9** on **image mode** setting ( 63) and images smaller than 320x240 edited by the crop or small picture function are not selectable.

Date

Set the camera clock and choose home and travel destination time zones.

Date

Set camera clock to current date and time.

See "Setting Display Language, Date and Time" (📖 14) for more information.

Time zone

🏠 (home time zone) can be specified and daylight saving enabled or disabled from **Time zone** options. When ➔ (destination time zone) is selected, the time difference (📖 79) is automatically calculated and the date and time in the selected region are recorded. Useful when travelling.

Setting Travel Destination Time Zone

- 1 Use the multi selector to choose **Time zone** and press **OK**.

The time zone menu is displayed.

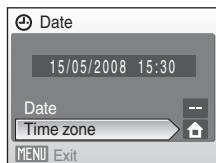

- 2 Choose ➔ and press **OK**.

The date and time displayed on the monitor changes according to the region currently selected.

If daylight saving time is in effect, use the multi selector to choose **Daylight saving** and press **OK**, and then press ▲. The time is automatically advanced one hour.

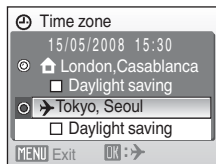

3 Press .

The travel destination menu is displayed.

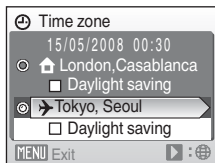

4 Choose the travel destination time zone and press .

The setting is enabled.

While the travel destination time zone is selected, the  icon will be displayed in the monitor when the camera is in shooting mode.

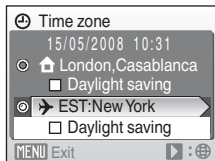
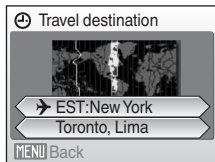



The Clock Battery

The clock battery charges when the main batteries are installed or an AC adapter is connected, and can provide several days of backup power after about ten hours of charging.

🏠 (Home Time Zone)

- To switch to the home time zone, choose  in step 2.
- To change the home time zone, choose  in step 2 and perform steps 3 and 4, to set the home time zone.

Daylight Saving Time

- If date and time are set when daylight saving time is not in effect: Turn **Daylight saving** on () when daylight saving time begins, to automatically advance the camera's clock one hour.
- If date and time are set with **Daylight saving** turned on () when daylight saving time is in effect: Turn **Daylight saving** off when daylight saving time ends, to automatically set the camera's clock back one hour.

 **Time Zones (14)**

The camera supports the time zones listed below.

For time differences not listed below, set the camera clock to local time (14, 77).

The table contains some locations that are not displayed on the camera's time zone map.

UTC +/-	Location	UTC +/-	Location
-11	Midway, Samoa	+1	Madrid, Paris, Berlin
-10	Hawaii, Tahiti	+2	Athens, Helsinki, Ankara
-9	Alaska, Anchorage	+3	Moscow, Riyadh, Kuwait, Manama, Nairobi
-8	PST (PDT): Los Angeles, Seattle, Vancouver	+4	Abu Dhabi, Dubai
-7	MST (MDT): Denver, Phoenix, La Paz	+5	Islamabad, Karachi
-6	CST (CDT): Chicago, Houston, Mexico City	+5.5	New Delhi
-5	EST (EDT): New York, Toronto, Lima	+6	Colombo, Dhaka
-4	Caracas, Manaus	+7	Bangkok, Jakarta
-3	Buenos Aires, São Paulo	+8	Beijing, Hong Kong, Singapore
-2	Fernando de Noronha	+9	Tokyo, Seoul
-1	Azores	+10	Sydney, Guam
±0	London, Casablanca	+11	New Caledonia
		+12	Auckland, Fiji

Monitor Settings

Choose whether or not to display information in the monitor, and set the monitor brightness.

Photo info

Choose information displayed in monitor during shooting and playback mode.





Brightness

Choose from five settings for monitor brightness. The default setting is **3**.

Photo Info

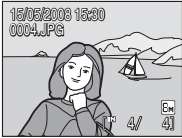
The following display options are available.

See “The Monitor” (📷 6) for information on indicators in the monitor.

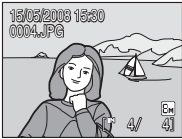
	Shooting mode	Playback mode
Show info		
Auto info (default setting)	After the same information as in Show info above is displayed for a few seconds, display will be the same as Hide info .	
Hide info		
Framing grid	 <p>In 📷 (easy auto) mode, 📷 (auto) mode, a framing grid is displayed to help frame pictures; other current settings or operation guide is displayed for a few seconds, as in Auto info above.</p> <p>In other shooting modes, the current settings or operation guide is displayed, as in Auto info above.</p>	 <p>The current settings or operation guide is displayed, as in Auto info above.</p>

Date Imprint

Date and time are imprinted on pictures. Date can be printed from printers that do not support the date imprinting ( 61).

Off (default setting)

Date and time are not imprinted on pictures.

Date



Date is imprinted on the bottom right corner of pictures taken while this option is in effect.

Date and time

Date and time are imprinted on the bottom right corner of pictures taken while this option is in effect.

At settings other than **Off**, the icon for the current setting is displayed in the monitor ( 6).

Date Imprint

- Imprinted dates form a permanent part of image data and cannot be deleted.
- Dates imprinted at an image-mode setting ( 63) of **TV screen (640)** may be difficult to read. Choose **PC screen (1024)** or larger when using date imprint.
- The date is recorded using the format selected in the setup menu's **Date** item ( 14, 77).

Date Imprint and Print Set

When pictures are printed from DPOF-compatible printers that can print date and photo information, you can use **Print Set** ( 60) and print the shooting date and photo information on the pictures. In such a case, it is unnecessary to imprint date and time on pictures beforehand using **Date Imprint**.

Anti-shake AE

Set anti-shake AE which automatically increases the shutter speed in shooting still pictures to reduce the camera and subject blurs.

When anti-shake AE is enabled, the current setting is displayed in the monitor during shooting (when **Off** is selected, an icon for the current setting is not displayed in the monitor) ( 6).

Auto (default setting)

When camera detects the movement of the subject or camera shake, the shutter speed will be increased for reducing the blur.

When the shooting mode is set to **Beach/snow** ( 34) and **Dusk/dawn** ( 35) in the scene mode, the Anti-shake AE is set to **OFF**.

Off

Anti-shake AE is not enabled.

Notes on Anti-shake AE

- Anti-shake AE may not be able to completely reduce the camera and subject blurs in some situations.
- The pictures taken may become somewhat grainy.
- If the subject is extremely blurred, too dark and so forth, the Anti-shake AE won't start.

AF Assist

Enable or disable AF-assist illumination.

Auto (default setting)

AF-assist illumination will be used to assist the focus operation when the subject is poorly lit. Note that for some scene modes, AF-assist illumination turns off automatically.

Off

Disable this function. The camera may be unable to focus if lighting is poor.

Sound Settings

Adjust the following sound settings.

Button sound

When **On** (default setting) is selected, beep will sound once when operations are completed successfully, twice when the camera acquires focus on the subject and three times when error is detected, and start-up sound will come when the camera is turned on.

Shutter sound

Choose shutter sound from **On** (default setting) and **Off**.

Auto Off

To reduce the drain on the batteries, the monitor turns off and the camera enters standby mode ( 13), if no operations are performed for a certain period of time. The power-on lamp flashes in standby mode. If no operations are performed for another three minutes, the camera turns off automatically.

Use this option to set time before camera enters standby mode.

Auto off

Choose the time allowed to elapse before the camera enters standby mode if no operations are performed from **30 s** (default setting), **1 m**, **5 m**, and **30 m**.

Sleep Mode

If **On** (default setting) is selected, the camera will enter standby mode when there is no change in the brightness of the subject, even before the time selected in the auto off menu has elapsed.

The camera will enter sleep mode after 30 seconds when **Auto off** is set to **1 m** or less, or after 1 minute when **Auto off** is set to **5 m** or more.

Notes on Auto Off

The time allowed to elapse before the camera enters standby mode is fixed in the following cases:

- While menus are displayed: 3 minutes
- While slide show is in progress: Up to 30 minutes

Format Memory/ **Format Card**

Use this option to format the internal memory or a memory card.

Formatting the Internal Memory

To format the internal memory, remove the memory card from the camera.

The **Format memory** option appears in the setup menu.

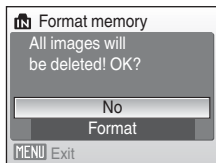

Formatting a Memory Card

When the memory card is inserted in the camera, the **Format card** option appears in the setup menu.

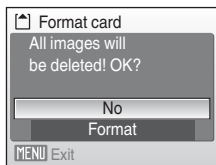

Formatting Internal Memory and Memory Cards

- Formatting the internal memory or memory cards permanently deletes all data. Be sure to transfer important pictures to a computer before formatting.
- Do not turn the camera off, open the battery-chamber/memory card slot cover during formatting.
- The first time you insert the memory cards used in other devices into the COOLPIX L18/COOLPIX L16, format them.

Language

Choose one of 24 languages for display of camera menus and messages.

Čeština	Czech
Dansk	Danish
Deutsch	German
English	(default setting)
Español	Spanish
Ελληνικά	Greek
Français	French
Indonesia	Indonesian
Italiano	Italian
Magyar	Hungarian
Nederlands	Dutch
Norsk	Norwegian

Polski	Polish
Português	Portuguese
Русский	Russian
Suomi	Finnish
Svenska	Swedish
Türkçe	Turkish
عربي	Arabic
中文简体	Simplified Chinese
中文繁體	Traditional Chinese
日本語	Japanese
한글	Korean
ภาษาไทย	Thai





Video mode

Adjust settings for connection to a television. Choose from **NTSC** and **PAL**.

Reset All

When **Reset** is selected, the camera's settings will be restored to their default values.

Pop-up Menu

Option	Default value*
Flash mode ( 26)	Auto
Self-timer ( 28)	Off
Macro mode ( 29)	Off
Exposure compensation ( 30)	0.0

* For the default settings for the scene mode ( 32), see the description for each scene.







Scene Mode

Option	Default value
Scene mode ( 32)	Portrait

Movie Menu

Option	Default value
Movie options ( 47)	TV movie 640 ★

Shooting Menu

Option	Default value
Image mode ( 63)	L18:  Normal (3264) L16:  Normal (3072)
White balance ( 65)	Auto
Continuous ( 67)	Single
Color options ( 68)	Standard color

Setup Menu

Option	Default value
Menus (🔑 76)	Text
Welcome screen (🔑 76)	None
Photo info (🔑 80)	Auto info
Brightness (🔑 80)	3
Date imprint (🔑 81)	Off
Anti-shake AE (🔑 82)	Auto
AF assist (🔑 83)	Auto
Button sound (🔑 83)	On
Shutter sound (🔑 83)	On
Auto off (🔑 84)	30 s
Sleep mode (🔑 84)	On

Others

Option	Default value
Paper size (🔑 56, 57)	Default

- Choosing **Reset all** also clears the current file number (🔑 92) from the memory. Numbering will continue from the lowest number available. To reset file numbering to "0001", delete all pictures (🔑 73) before selecting **Reset all**.
- Settings for **Date** (🔑 77), **Language** (🔑 86), **Video mode** (🔑 86), **Battery type** (🔑 89) and picture stored in the camera for the welcome screen (🔑 76) in the setup menu and **Preset manual** (🔑 66) in the **White balance** menu will remain unaffected even if **Reset all** is performed.

Battery type

To ensure that the camera shows the correct battery level (, 18), choose the type that matches the batteries currently in use.

Alkaline (default setting)	LR6 alkaline batteries
COOLPIX (Ni-MH)	ZR6 oxyride batteries Nikon EN-MH1 rechargeable nickel-metal hydride batteries
Lithium	FR6/L91 lithium batteries

Protect

Protect selected pictures from accidental deletion. Note, however, that formatting the camera's internal memory or the memory card will permanently erase protected files (, 85).



See “Selecting Multiple Pictures” (, 71) for more information on using this function.

Protected pictures are recognized by the  icon (, 40) in playback mode.

Copy

Copy pictures between the internal memory and a memory card.

- 1 Select an option from the copy screen and press .

- : Copy pictures from internal memory to memory card.
- : Copy pictures from memory card to internal memory.

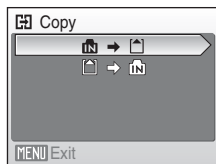

2 Select a copy option and press **OK**.

Selected images: Copy pictures selected from the picture selection screen (**8** 71).

All images: Copy all pictures.

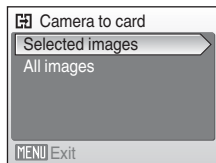

✓ Notes on Copying Pictures

- JPEG- and AVI- format files can be copied. Files recorded in any other format cannot be copied.
- Pictures taken with another make of camera or that have been modified on a computer cannot be copied.
- Edited copies have the same protection marking (**8** 89) as the original, but are not marked for printing (**8** 60).

🔍 More Information

See, "Image File and Folder Names" (**8** 92) for more information.

Ver. Firmware Version

View the current camera firmware version.

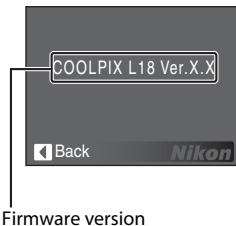

Optional Accessories

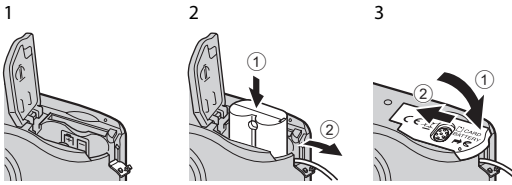
Rechargeable battery	Two Nikon EN-MH1 rechargeable NiMH batteries (EN-MH1-B2)
Battery charger	MH-71 Battery Charger
AC adapter	EH-65A AC adapter (connects as shown)  EH-62B AC adapter cannot be used.
USB cable	USB cable UC-E6
A/V cable	Audio/Video cable EG-CP14

Approved Memory Cards

The following memory cards have been tested and approved for use in the COOLPIX L18/COOLPIX L16.

All cards of the designated make and capacity can be used, regardless of speed.

SanDisk	128 MB, 256 MB, 512 MB, 1 GB, 2 GB ¹ , 4 GB ²
Toshiba	128 MB, 256 MB, 512 MB, 1 GB, 2 GB ¹ , 4 GB ²
Panasonic	128 MB, 256 MB, 512 MB, 1 GB, 2 GB ¹ , 4 GB ²

¹ If the memory card will be used with a card reader or similar device, check that device supports 2 GB cards.

²  SDHC-compliant. If the memory card will be used with a card reader or similar device, check that device supports SDHC.

Operation is not guaranteed with other makes of card. Contact the manufacturer for details on the above cards.

Image File and Folder Names

Pictures and movies are assigned file names as follows.

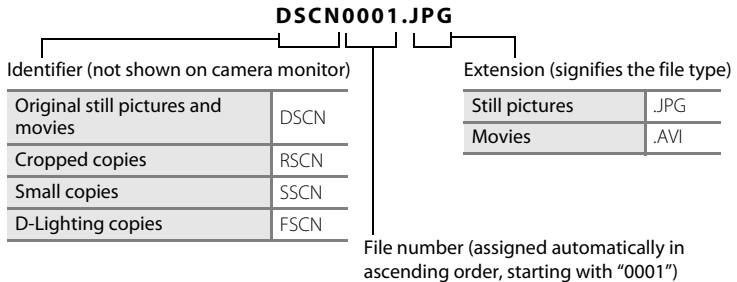

- Files are stored in folders automatically named with a three-digit folder number followed by NIKON (e.g. "100NIKON"). If a picture is taken when the current folder contains 200 pictures, a new folder will be created by adding one to the current folder number. (e.g. "100NIKON" → "101NIKON"). If a picture is taken when the current file is numbered 9999, a new folder will also be created and the new file number is returned to 0001.
- Files are stored in folders named with a folder number followed by a five-character identifier: "P_" plus a three-digit sequence number for pictures taken using panorama assist (📷 38) (e.g. "101P_001") and file numbers will be assigned automatically starting with "0001".
- If files are copied between the internal memory and the memory card (📷 89), the files are named as follows.
 - **Selected images:** The image data is copied in the current folder (or the folder to be used in the next time shooting). The newly copied pictures are numbered consecutively from the largest number available in the internal memory or memory card.
 - **All images:** All the pictures in the folder are copied with the same file numbers. New folder numbers are assigned in ascending order starting from the largest folder number available. The file names are not changed.
- If a picture is taken when the current folder is numbered 999 and contains 200 pictures or a picture numbered 9999, no further pictures can be taken until the memory card is replaced with a new one or the medium is formatted (📷 85).

Caring for the Camera

To ensure continued enjoyment of this Nikon product, observe the following precautions when using or storing the device.

Keep Dry

The device will be damaged if immersed in water or subjected to high humidity.

Do Not Drop

The product may malfunction if subjected to strong shock or vibration.

Handle the Lens and all Moving Parts with Care

Do not apply force to the lens, lens cover, monitor, memory card slot or battery chamber. These parts are easily damaged. Applying force to the lens cover could result in camera malfunction or damage to the lens. Should the monitor break, care should be taken to avoid injury caused by broken glass and to prevent the liquid crystal from the display touching the skin or entering the eyes or mouth.

Do Not Point the Lens at Strong Light Sources for Extended Periods

Avoid pointing the lens at the sun or other strong light sources for extended periods when using or storing the camera. Intense light may cause deterioration of the CCD image sensor, producing a white blur effect in photographs.

Keep Away from Strong Magnetic Fields

Do not use or store this device in the vicinity of equipment that generates strong electromagnetic radiation or magnetic fields. Strong static charges or the magnetic fields produced by equipment such as radio transmitters could interfere with the monitor, damage data stored on the memory card, or affect the product's internal circuitry.

Avoid Sudden Changes in Temperature

Sudden changes in temperature, such as when entering or leaving a heated building on a cold day, can cause condensation to form inside the device. To prevent condensation, place the device in a carrying case or a plastic bag before exposing it to sudden changes in temperature.

Turn the Product Off Before Removing or Disconnecting the Power Source

Do not unplug the product or remove the batteries while the product is on, or while images are being recorded or deleted. Forcibly cutting power in these circumstances could result in loss of data or in damage to product memory or internal circuitry. To prevent an accidental interruption of power, avoid carrying the product from one place to another while an AC adapter is connected.

The Self-timer Lamp/AF-assist Illuminator LED

The light-emitting diode (LED;  4, 28, 83) used in the self-timer lamp/AF-assist illuminator conforms to the following IEC standard:

CLASS 1 LED PRODUCT

IEC60825-1 Edition 1,2-2001

Batteries

- Check the battery level when taking the camera out, and replace the batteries if necessary ( 18). If possible, carry spare batteries when taking pictures on important occasions.
- Battery capacity tends to decrease on cold days. Be sure that the batteries are fresh before heading outside to take pictures in cold weather. Keep spare batteries in a warm place and exchange as necessary. Once warmed, a cold battery may recover some of its charge.
- Dirt on the battery terminals can prevent the camera from functioning.
- Used batteries are a valuable resource. Please recycle used batteries in accordance with local regulations.

Cleaning

Lens	Avoid touching glass parts with your fingers. Remove dust or lint with a blower (typically a small device with a rubber bulb attached to one end that is pumped to produce a stream of air out the other end). To remove fingerprints or other stains that cannot be removed with a blower, wipe the lens with a soft cloth, using a spiral motion that starts at the center of the lens and working toward the edges. If this fails, clean the lens using a cloth lightly dampened with commercial lens cleaner.
Monitor	Remove dust or lint with a blower. To remove fingerprints and other stains, clean the monitor with a soft, dry cloth, being careful not to apply pressure.
Body	Use a blower to remove dust, dirt or sand, then wipe gently with a soft, dry cloth. After using the camera at the beach or seaside, wipe off any sand or salt with a dry cloth lightly dampened with fresh water, then dry thoroughly. Note that foreign matter inside the camera could cause damage not covered by the warranty.

Do not use alcohol, thinner, or other volatile chemicals.

Storage

Turn the camera off when not in use. Check that the power-on lamp is off before putting the camera away. Remove the batteries if the camera will not be used for an extended period. Do not store the camera with naphtha or camphor moth balls, or in any of the following locations:

- Next to equipment that produces strong electromagnetic fields, such as televisions or radios
- Exposed to temperatures below -10°C (14°F) or above 50°C (122°F)
- Poorly ventilated or subject to humidities of over 60 %









To prevent mold or mildew, take the camera out of storage at least once a month. Turn the camera on and release the shutter a few times before putting the camera away again.











Notes on the Monitor

- The monitor may contain a few pixels that are always lit or that do not light. This is a characteristic common to all TFT LCD displays, and does not indicate a malfunction. Images recorded using the product will not be affected.
- When framing bright subjects, vertical comet-like streaks that whiten toward either end may appear in the display. This phenomenon, known as “smear,” does not appear in the final photograph and does not indicate a malfunction. Some smear may appear in movies.
- Images in the monitor may be difficult to see under bright lighting.
- The monitor is lit by an LED backlight. Should the monitor begin to dim or flicker, contact your Nikon-authorized service representative.















Error Messages

The following table lists the error messages and other warnings displayed in the monitor, as well as the solutions for dealing with them.

Display	Problem	Solution	
 (blinks)	Clock not set.	Set clock.	77
	Battery running low.	Prepare to replace batteries.	12, 89
i Battery exhausted.	Battery exhausted.	Replace batteries.	
 ● (● blinks red)	Camera cannot focus.	<ul style="list-style-type: none"> • Refocus. • Use focus lock. 	22, 23
 Please wait for the camera to finish recording. 	Camera cannot perform other operations until recording is complete.	Wait until message clears from display automatically when recording is complete.	22
i Memory card is write protected.	Write-protect switch is in "lock" position.	Slide write-protect switch to "write" position.	17
 This card cannot be used.	Error accessing memory card.	<ul style="list-style-type: none"> • Use approved card. • Check that connectors are clean. • Confirm that memory card is correctly inserted. 	91
 This card cannot be read.			16
 Card is not formatted. Format card? No Yes	Memory card has not been formatted for use in camera.	Choose Yes and press  to format card, or turn camera off and replace card.	17
i Out of memory.	Memory card is full.	<ul style="list-style-type: none"> • Choose smaller image size. • Delete pictures. • Insert new memory card. • Remove memory card and use internal memory. 	63 24, 48, 73 16 17

Display	Problem	Solution	
 Image cannot be saved.	Error occurred while recording picture.	Format internal memory or memory card.	85
	Camera has run out of file numbers.	<ul style="list-style-type: none"> • Insert new memory card. • Format internal memory or memory card. 	16 85
	Picture cannot be used for welcome screen.	Choose picture 640 × 480 pixels or larger, or picture taken at an image mode setting other than 16:9 .	44, 45, 63
	Cannot copy picture.	Delete pictures from destination.	73
 Image cannot be modified.	Cannot edit selected picture.	Select picture that supports crop, D-Lighting or small picture.	42
 Cannot record movie.	Time out error while recording movie.	Choose memory card with faster write speed.	91
 Memory contains no images.	No pictures in the internal memory or memory card.	Remove memory card to play back pictures from internal memory.	17
 File contains no image data.	File not created with COOLPIX L18/L16.	View file on computer or other device.	–
 This image cannot be deleted	Picture is protected.	Disable protection.	89
Lens error 	Lens error.	Turn camera off and then on again. If error persists, contact retailer or Nikon-authorized service representative.	18
 Communications error	USB cable disconnected during printing.	Turn camera off, reconnect USB cable.	55
System error 	Error has occurred in camera's internal circuitry.	Turn camera off, remove and reinsert batteries, and turn camera on. If error persists, contact retailer or Nikon-authorized service representative.	12, 18

Error Messages

Display	Problem	Solution	
 Printer error: check printer status.	Running out of ink or printer error.	Check printer. After checking the ink or solving the problem, select Resume and press  to resume printing.*	–
 Printer error: check paper	Specified size of paper is not loaded in printer.	Load the specified paper, select Resume and press  to resume printing.*	–
 Printer error: paper jam	Paper has jammed in the printer.	Eject the jammed paper, select Resume and press  to resume printing.*	–
 Printer error: out of paper	No paper is loaded in printer.	Load the specified paper, select Resume and press  to resume printing.*	–
 Printer error: check ink	Ink error.	Check ink, select Resume and press  to resume printing.*	–
 Printer error: out of ink	Ink cartridge is empty.	Replace ink, select Resume and press  to resume printing.*	–
 Printer error: file corrupt	An error caused by the image file has occurred.	Select Cancel and press  to cancel printing.	–

* See the documentation provided with your printer for further guidance and information.

Troubleshooting

If the camera fails to function as expected, check the list of common problems below before consulting your retailer or Nikon-authorized service representative. Refer to the page numbers in the right-most column for more information.

Display, Settings and Power Supply







Problem	Cause/Solution	
Monitor is blank	<ul style="list-style-type: none">• Camera is off.• Battery is exhausted.• Standby mode for saving power: press the shutter-release button halfway.• When flash lamp blinks red, wait until flash has charged.• Camera and computer are connected via USB cable.• Camera and TV are connected via A/V cable.	18 18 11, 13 27 50 49
Monitor is hard to read	<ul style="list-style-type: none">• Adjust monitor brightness.• Monitor is dirty. Clean monitor.• Monitor has dimmed to save power. Monitor brightens when controls are used.	80 95 13
Camera turns off without warning	<ul style="list-style-type: none">• Batteries are low.• Camera has turned off automatically to save power.• Batteries are cold.	18 94
Date and time of recording are not correct	<ul style="list-style-type: none">• Pictures recorded before clock was set, and "Date not set" indicator blinks during shooting, will have time stamp of "00/00/0000 00:00"; movies will be dated "01/01/2008 00:00." Set the correct date and time from Date in the setup menu.• Check camera clock regularly against more accurate timepieces and reset as required.	14 77
No indicators displayed in monitor	Hide info is selected for Photo info . Select Show info .	80
Date imprint not available	Camera clock has not been set.	14, 77
Date not appearing on pictures even when Date imprint is enabled	Date does not appear on movies or on pictures taken using  .	37, 46
Camera settings reset	Backup battery is exhausted; all settings were restored to their default values.	78







Electronically Controlled Cameras

In extremely rare instances, unusual characters may appear in the monitor and the camera may stop functioning. In most cases, this phenomenon is caused by a strong external static charge. Turn the camera off, remove and replace the battery, then turn the camera on again. In the event of continued malfunction, contact your retailer or Nikon-authorized service representative. Note that disconnecting the power source as described above may result in the loss of any data not recorded to internal memory or the memory card at the time the problem occurred. Data already recorded will not be affected.

Shooting

Problem	Cause/Solution	
No picture taken when shutter-release button is pressed.	<ul style="list-style-type: none"> When camera is in playback mode, press the shooting mode button. When menus are displayed, press MENU. Battery is exhausted. When flash lamp blinks, flash is charging. 	24 10 18 27
Camera cannot focus.	<ul style="list-style-type: none"> The intended subject is one with which autofocus does not perform well. Set AF assist in the setup menu to Auto. Focus error. Turn camera off and then on again. 	23 83 18
Pictures are blurred.	<ul style="list-style-type: none"> Use flash. Use anti-shake AE. Use BSS. Use tripod and self-timer. 	26 82 67 5, 28
Bright specks appear in pictures taken with flash.	Flash is reflecting off particles in air. Turn flash off.	27
Flash does not fire.	<ul style="list-style-type: none"> Flash is off. Some scene modes that cannot turn on flash are selected. Continuous, BSS or Multi-shot 16 is selected for Continuous. 	26 32 67
Optical zoom cannot be used.	Optical zoom cannot be used while recording movies.	46

Problem	Cause/Solution	
Digital zoom cannot be used.	Digital zoom cannot be used: <ul style="list-style-type: none"> • When  Portrait or  Night portrait is selected from the scene mode menu. • When Multi-shot 16 is selected from the Continuous settings in the shooting mode menu. • Before movie is started. 	33, 34 67 46
Image mode not available.	Image mode cannot be adjusted when Multi-shot 16 is selected for Continuous .	67
No sound when shutter is released.	<ul style="list-style-type: none"> • Off is selected for Sound settings > Shutter sound in setup menu. • Continuous, BSS or Multi-shot 16 is selected for Continuous in shooting menu. •  (Sports scene mode) or  (Museum scene mode) is selected. • Movie mode is selected. 	83 67 33, 36 46
AF-assist illuminator does not light.	<ul style="list-style-type: none"> • Off is selected for AF assist option in camera setup menu. • AF-assist illuminator turns off automatically in some modes. 	83 33-37
Pictures appear smeared.	Lens is dirty. Clean lens.	95
Colors are unnatural.	White balance does not match light source.	65
Randomly spaced bright pixels ("noise") appear in image.	Shutter speed too slow or ISO sensitivity too high. Noise can be reduced by: <ul style="list-style-type: none"> • Using flash • Choosing scene mode with noise reduction 	26 34, 35
Pictures are too dark (underexposed).	<ul style="list-style-type: none"> • Flash is off. • Flash window is blocked. • Subject is beyond flash range. • Adjust exposure compensation. • Subject is backlit. Select  (Backlight scene mode) or use fill flash. 	26 20 26 30 26, 37
Pictures are too bright (overexposed).	Adjust exposure compensation.	30

Problem	Cause/Solution	
Unexpected results when flash set to  (auto with red-eye reduction).	If  (auto with red-eye reduction) or fill flash with slow sync and red-eye reduction in  (Night portrait scene mode) is used, in-Camera Red Eye Fix may, in very rare cases, be applied to areas not affected by red-eye. Use flash modes other than  (auto with red-eye reduction) and take pictures in the shooting mode other than  Night Portrait	26, 34

Playback

Problem	Cause/Solution	
File cannot be played back.	File was overwritten or renamed by computer or other make of camera.	-
Cannot zoom in on picture.	Playback zoom cannot be used with movies, small pictures, or pictures that have been cropped to below 320 × 240.	-
Cannot use D-Lighting, crop, or small picture options.	<ul style="list-style-type: none"> • These options cannot be used with movies, and pictures taken when 16:9 is applied in the image-mode setting. • Select picture that supports D-Lighting, crop, or small picture. • Other cameras may be unable to play back pictures recorded with this camera. 	48, 63 42 -
Pictures not displayed on television.	<ul style="list-style-type: none"> • Choose correct video mode. • Memory card contains no pictures. Replace memory card. Remove memory card to play back pictures from internal memory. 	86 16
Nikon Transfer does not start when camera is connected.	<ul style="list-style-type: none"> • Camera is off. • Battery is exhausted. • USB cable is not correctly connected. • Camera is not recognized by the computer. • If your computer is running Windows 2000 Professional, your camera cannot be connected. • Computer is not set to launch Nikon Transfer automatically. <p>For more information on Nikon Transfer, refer to help information contained in Nikon Transfer.</p>	18 18 50 - 53 -

Problem	Cause/Solution	
Pictures to be printed are not displayed.	Memory card contains no pictures. Replace memory card. Remove memory card to print pictures from internal memory.	16
Cannot select paper size with camera.	Paper size cannot be selected from the camera if the printer does not support the page sizes used by the camera, or the printer automatically selects the page size. Use the printer to select page size.	56, 57

Specifications

Nikon COOLPIX L18/COOLPIX L16 Digital Camera



Type	Compact digital camera
Effective pixels	COOLPIX L18: 8.0 million COOLPIX L16: 7.1 million
CCD	1/2.5-in. CCD
Total pixels	COOLPIX L18: 8.29 million COOLPIX L16: 7.41 million
Lens	3x Zoom-Nikkor lens
Focal length	5.7-17.1mm (equivalent with 35mm [135] format picture angle: 35-105mm)
f/-number	f/2.8-4.7
Construction	5 elements in 5 groups
Digital zoom	Up to 4x (equivalent with 35mm [135] format picture angle: approx. 420mm)
Autofocus (AF)	Contrast-detect AF
Focus range (from lens)	<ul style="list-style-type: none">• Approx. 50 cm (1 ft. 7.7 in.) to ∞• Macro mode: Approx. 15 cm (5.9 in.) to ∞ (when the zoom indicator is positioned over )
Focus-area selection	Center, Face-priority
AF-assist illumination	Class 1 LED product (IEC 60825-1 Edition 1.2 ²⁰⁰¹); max. output: 1000 μW
Monitor	COOLPIX L18: 3.0in., Approx.230k-dot, TFT LCD with 5-level brightness adjustment COOLPIX L16: 2.8in., Approx.230k-dot, TFT LCD with 5-level brightness adjustment
Frame coverage (shooting mode)	Approx. 97% horizontal and 97% vertical (Compared to actual picture)
Frame coverage (playback mode)	Approx. 100% horizontal and 100% vertical (Compared to actual picture)
Storage	
Media	Internal memory (Approx.21 MB) Secure Digital (SD) memory cards
File system	DCF, Exif 2.2, and DPOF compliant
File formats	Compressed: JPEG-Baseline compliant Movies: AVI

Image size (pixels)	<p>COOLPIX L18:</p> <ul style="list-style-type: none"> • 3264 × 2448 [High (3264★) / Normal (3264)] • 2592 × 1944 [Normal (2592)] • 2048 × 1536 [Normal (2048)] • 1024 × 768 [PC Screen (1024)] • 640 × 480 [TV Screen (640)] • 1920 × 1080 [16:9 (1920)] <p>COOLPIX L16:</p> <ul style="list-style-type: none"> • 3072 × 2304 [High (3072★) / Normal (3072)] • 2592 × 1944 [Normal (2592)] • 2048 × 1536 [Normal (2048)] • 1024 × 768 [PC Screen (1024)] • 640 × 480 [TV Screen (640)] • 1920 × 1080 [16:9 (1920)]
ISO sensitivity (Standard output sensitivity)	Auto (ISO 64-1600)
Exposure	
Metering	256-segment matrix, center-weighted (digital zoom less than 2x), spot (digital zoom 2x or more)
Exposure control	Programmed auto-exposure with anti-shake AE and exposure compensation (-2.0 to +2.0 EV in steps of 1/3 EV)
Range (ISO 100)	[W]: -1 to +16.2 EV [T]: 0.5 to 17.6 EV
Shutter	Mechanical and charge-coupled electronic shutter
Speed	1/1500–1 s
Aperture	Electronically-controlled ND filter (-2 AV) selection
Range	2 steps (f/2.8 and f/5.6 [W])
Self-timer	10 seconds
Built-in flash	
Range	[W]: 0.5 to 7.7 m (19.7 in. to 25 ft. 3.1 in.) [T]: 0.5 to 4.5 m (19.7 in. to 14 ft. 9.1 in.)
Flash control	TTL auto flash with monitor preflashes

Specifications

Interface	Hi-Speed USB
Data transfer protocol	MTP, PTP
Video output	Can be selected from NTSC and PAL
I/O terminals	<ul style="list-style-type: none">• Audio/video (A/V) out• Digital I/O (USB)
Supported languages	Czech, Danish, German, English, Spanish, Greek, French, Indonesian, Italian, Hungarian, Dutch, Norwegian, Polish, Portuguese, Russian, Finnish, Swedish, Turkish, Arabic, Chinese (Simplified and Traditional), Japanese, Korean, Thai
Power sources	<ul style="list-style-type: none">• Two AA alkaline, lithium, or oxyride batteries• Two EN-MH1 rechargeable NiMH batteries (available separately)• EH-65A AC adapter (available separately)
Battery life*	Approx. 180 shots with alkaline, 650 shots with lithium, or 300 shots with EN-MH1 batteries
Dimensions (W × H × D)	Approx. 95 × 61 × 29.5 mm (3.7 × 2.4 × 1.2 in.) (excluding projections)
Weight	Approx. 125 g (4.4 oz) without battery and memory card
Operating environment	
Temperature	0 to 40 °C (+32 to 104 °F)
Humidity	Less than 85% (no condensation)

- Unless otherwise stated, all figures are for a camera with a fully-charged EN-MH1 batteries operated at an ambient temperature of 25 °C (77 °F).

* Based on Camera and Imaging Products Association (CIPA) standards for measuring the life of camera batteries. Measured at 23 °C (73 °F); zoom adjusted with each shot, flash fired with every other shot, image mode set to [COOLPIX L18:  Normal(3264)/COOLPIX L16:  Normal (3072)].

Battery life may vary depending on shooting interval and length of time menus and images are displayed.

Supplied batteries are for trial use only.

Specifications

















Nikon will not be held liable for any errors this manual may contain. The appearance of this product and its specifications are subject to change without notice.

Supported Standards

- **DCF:** Design Rule for Camera File System is a standard widely used in the digital camera industry to ensure compatibility among different makes of camera.
- **DPOF:** Digital Print Order Format is an industry-wide standard that allows pictures to be printed from print orders stored on the memory card.
- **Exif version 2.2:** This camera supports Exif (Exchangeable Image File Format for Digital Still Cameras) version 2.2, a standard that allows information stored with photographs to be used for optimal color reproduction when images are output from Exif-compliant printers.
- **PictBridge:** A standard developed cooperatively by the digital camera and printer industries, allowing photographs to be output directly to a printer without connecting the camera to a computer.

Index

Symbols

-  Anti-shake AE 19, 82
-  Apply selection button 5
-  Auto mode 8, 31
-  Battery level indicator 18
-  Delete button 5, 25
-  Easy auto mode 8, 18
-  Exposure compensation 9, 30
-  Flash mode 9, 26
-  Help 11
-  Playback zoom 41
-  Thumbnail playback 40
- W** and **T** zoom buttons 5, 20, 29, 48, 56
-  Macro mode 9, 29
- MENU** button 10
-  Movie mode 8, 46
-  Playback button 8
-  Scene mode 8, 32
-  Self-timer 9, 28

A

- AC adapter 13, 91
- Accessories 91
- AE-L 39
- AF assist 83
- Anti-shake AE 19, 82
- Aperture 22
- Audio/Video (A/V) cable 49, 91
- Auto off 84
- Auto with red-eye reduction 26
- Autofocus 22, 23
- AVI 92

B

- Backlight  32, 37
- Backlit subjects 26, 37
- Batteries 12, 94
 - EN-MH1 12, 89, 91
 - FR6/L91 (AA) 12, 89
 - LR6 (AA) 12, 89
 - ZR6 (AA) 12, 89
- Battery charger 91

- Battery level indicator 18
- Battery type 13, 89
- Battery-chamber/memory card slot cover 5
- Beach/snow  32, 34
- Best shot selector (BSS) 67
- Black-and-white 68
- Blur 100
- Brightness 80

C

- Cable connector 4, 49, 51, 55
- Cleaning
 - Body 95
 - Lens 95
 - Monitor 95

- Close-up  32, 36

- Cloudy 65

- Color options 68

- Computer 50–53

- Continuous 67, 69

- Copy 89

- Copy  32, 36

- Crop 44

- Cyanotype 68

D

- Date 14–15, 77

- Date imprint 81

- Daylight 65

- Daylight saving time 14, 77

- DCF 107

- Delete 24, 25, 48, 73

- Digital print order format 60, 107

- Digital zoom 21

- D-Lighting 43

- DPOF 60–61, 107







- DSCN 92

- Dusk/dawn  32, 35

E

- EH-65A AC adapter 13, 91

- Error messages 96–98

- Exif version 2.2 107
- Exposure compensation 9, 30
- Extension 92
- E**
- Face Priority 20, 23
- File names 92
- Fill flash 26
- Firmware version 90
- Flash 4
 - lamp 5, 27
 - mode 9, 26, 69
- Fluorescent 65
- Focus 6, 22
 - area 6, 22
 - indicator 6, 22
- Focus lock 31
- Folder names 92
- Format 17, 85
- Framing 20
- FSCN 92
- Full-frame playback mode 24, 25
- H**
- Help 11
- I**
- Image mode 32, 63
- Incandescent 65
- Internal memory 6–7, 16, 64, 85
 - capacity 64
 - formatting 85
- ISO sensitivity 6, 27
- J**
- JPEG 104
- JPG 92
- L**
- Landscape  32, 33
- Language 14, 86
- Lens 4, 95
- M**
- Macro mode 9, 29
- Memory card 6–7, 16, 64, 91
 - approved 91
 - capacity of 64
 - formatting 85
 - Inserting and removing 16
 - slot 16
- Menu button 10
- Menus 76
- Microphone 4, 46
- Monitor 5, 6–7, 18, 19, 80, 95
 - brightness 80
 - indicators in 6–7
- Monitor settings 80
- Movie menu 47
- Movie mode 46
- Movie options 47
 - maximum movie length 47
 - small size 47
 - TV movie 47
- Movies 46, 48
 - deleting 48
 - playback 48
 - recording 46
- Multi selector 5, 9
- Multi-shot 16 67
- Museum  32, 36
- N**
- Night landscape  32, 35
- Night portrait  32, 34
- Noise reduction 34, 35
- Number of exposures remaining 64
- O**
- Optical zoom 21
- P**
- Panorama 37–39
- Panorama assist  32, 37
- Paper size 56, 57
- Party/indoor  32, 34
- PictBridge 55, 107
- Playback 24, 40–45
 - mode 8, 24, 25

thumbnail 40
zoom 41

Playback menu 70–73

Portrait (👤) 32, 33

Power switch 4, 12

Power-on lamp 4, 12

Print set 60

Print size 64

Printer 54

Protect 89

R

Red-eye reduction 27

Reset all 87

RSCN 92

S

Secure Digital (SD) memory card 1

Self-timer 9, 28, 69

Self-timer lamp 4, 28

Sepia 68

Setup menu 74–90

Shooting menu 62–69

Shooting mode 8

Shooting mode button 5, 8

Shooting-mode selection menu 8

Shutter speed 22

Shutter-release button 4

Single 67

Slide show 72

Slow sync 26

Small picture 45

Smear 95

Sound settings 83

Speaker 4

Sports (🏃) 32, 33

SSCN 92

Standard color 68

Strap, Camera 11

Sunset (🌇) 32, 35

Support information 2

I

Television 49
connecting to 49

Thumbnail playback 40

Time zone 14–15, 77, 79

Transfer 51

Tripod socket 5

U

USB cable 51, 55, 91

V

Video mode 86

Vivid color 68

Volume 48

W

Welcome screen 76

White balance 65, 69
preset manual 66

Z

Zoom 20
buttons 5, 20, 29, 48, 56
indicator 6
playback 41

Nikon

No reproduction in any form of this manual, in whole or in part (except for brief quotation in critical articles or reviews), may be made without written authorization from NIKON CORPORATION.



NIKON CORPORATION

Fuji Bldg., 2-3 Marunouchi 3-chome,
Chiyoda-ku, Tokyo 100-8331, Japan

Printed in Europe
CT8A01(11)
6MMA3111-01