

Nikon

DIGITAL CAMERA

COOLPIX P90

User's Manual

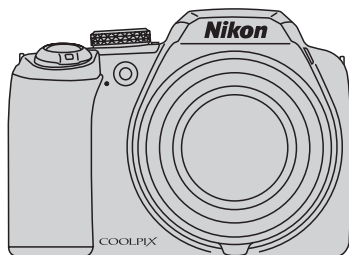

En

Trademark Information

- Microsoft, Windows and Windows Vista are either registered trademarks or trademarks of Microsoft Corporation in the United States and/or other countries.
- Macintosh, Mac OS, and QuickTime are trademarks of Apple Inc.
- Adobe and Acrobat are registered trademarks of Adobe Systems Inc.
- The SD logo is a trademark of the SD Card Association.
- PictBridge is a trademark.
- All other trade names mentioned in this manual or the other documentation provided with your Nikon product are trademarks or registered trademarks of their respective holders.

Introduction

First Steps



Basic Photography and Playback: Auto Mode

SCENE  Shooting Suited for the Scenes



Automatic Shooting of Smiling Faces



Sport Continuous Mode

Shoot pictures using **P, S, A, M, U1 and **U2****



More on Playback



Movies



Voice Recordings

Connecting to Televisions, Computers and Printers

MENU Shooting, Playback and Setup Menus

Technical Notes

For Your Safety

To prevent damage to your Nikon product or injury to yourself or to others, read the following safety precautions in their entirety before using this equipment. Keep these safety instructions where all those who use the product will read them. The consequences that could result from failure to observe the precautions listed in this section are indicated by the following symbol:



This icon marks warnings, information that should be read before using this Nikon product, to prevent possible injury.

WARNINGS

Turn off in the event of malfunction

Should you notice smoke or an unusual smell coming from the camera or AC adapter, unplug the AC adapter and remove the battery immediately, taking care to avoid burns. Continued operation could result in injury. After removing or disconnecting the power source, take the equipment to a Nikon-authorized service representative for inspection.

Do not disassemble

Touching the internal parts of the camera or AC adapter could result in injury. Repairs should be performed only by qualified technicians. Should the camera or AC adapter break open as the result of a fall or other accident, take the product to a Nikon-authorized service representative for inspection, after unplugging the product and/or removing the battery.

Do not use the camera or AC adapter in the presence of flammable gas

Do not use electronic equipment in the presence of flammable gas, as this could result in explosion or fire.

Handle the camera strap with care

Never place the strap around the neck of an infant or child.

Keep out of reach of children

Particular care should be taken to prevent infants from putting the battery or other small parts into their mouths.

 Observe caution when handling the battery

The battery may leak or explode if improperly handled. Observe the following precautions when handling the battery for use in this product:

- Before replacing the battery, turn the product off. If you are using the AC adapter, be sure it is unplugged.
- Use only a Rechargeable Li-ion Battery EN-EL5 (supplied). Charge the battery by inserting it in a Battery Charger MH-61 (supplied).
- When inserting the battery, do not attempt to insert it upside down or backwards.
- Do not short or disassemble the battery or attempt to remove or break the battery insulation or casing.
- Do not expose the battery to flame or to excessive heat.
- Do not immerse in or expose to water.
- Replace the terminal cover when transporting the battery. Do not transport or store with metal objects such as necklaces or hairpins.
- The battery is prone to leakage when fully discharged. To avoid damage to the product, be sure to remove the battery when no charge remains.
- Discontinue use immediately should you notice any change in the battery, such as discoloration or deformation.
- If liquid from the damaged battery comes in contact with clothing or skin, rinse immediately with plenty of water.

 Observe the following precautions when handling the battery charger

- Keep dry. Failure to observe this precaution could result in fire or electric shock.
- Dust on or near the metal parts of the plug should be removed with a dry cloth. Continued use could result in fire.
- Do not handle the power cable or go near the battery charger during lightning storms. Failure to observe this precaution could result in electric shock.
- Do not damage, modify, forcibly tug or bend the power cable, place it under heavy objects, or expose it to heat or flames. Should the insulation be damaged and the wires become exposed, take it to a Nikon-authorized service representative for inspection. Failure to observe these precautions could result in fire or electric shock.
- Do not handle the plug or battery charger with wet hands. Failure to observe this precaution could result in electric shock.
- Do not use with travel converters or adapters designed to convert from one voltage to another or with DC-to-AC inverters. Failure to observe this precaution could damage the product or cause overheating or fire.

 **Use appropriate cables**

When connecting cables to the input and output jacks, use only the cables provided or sold by Nikon for the purpose, to maintain compliance with product regulations.

 **Handle moving parts with care**

Be careful that your fingers or other objects are not pinched by the lens cover or other moving parts.

 **CD-ROMs**

The CD-ROMs supplied with this device should not be played back on audio CD equipment. Playing CD-ROMs on an audio CD player could cause hearing loss or damage the equipment.

 **Observe caution when using the flash**

Using the flash close to your subject's eyes could cause temporary visual impairment. Particular care should be observed if photographing infants, when the flash should be no less than 1 m (3 ft. 4 in.) from the subject.

 **Do not operate the flash with the flash window touching a person or object**

Failure to observe this precaution could result in burns or fire.

 **Avoid contact with liquid crystal**

Should the monitor break, care should be taken to avoid injury caused by broken glass and to prevent liquid crystal from the monitor touching the skin or entering the eyes or mouth.

 **Turn the power off when using inside an airplane or the hospital**

Turn the power off while inside the airplane during take off or landing. Follow the instructions of the hospital when using while in a hospital. The electromagnetic waves given out by this camera may disrupt the electronic systems of the airplane or the instruments of the hospital.

Notices

Notice for Customers in the U.S.A.

Federal Communications Commission (FCC) Radio Frequency Interference Statement

This equipment has been tested and found to comply with the limits for a Class B digital device, pursuant to Part 15 of the FCC rules. These limits are designed to provide reasonable protection against harmful interference in a residential installation. This equipment generates, uses, and can radiate radio frequency energy and, if not installed and used in accordance with the instructions, may cause harmful interference to radio communications. However, there is no guarantee that interference will not occur in a particular installation. If this equipment does cause harmful interference to radio or television reception, which can be determined by turning the equipment off and on, the user is encouraged to try to correct the interference by one or more of the following measures:

- Reorient or relocate the receiving antenna.
- Increase the separation between the equipment and receiver.
- Connect the equipment into an outlet on a circuit different from that to which the receiver is connected.
- Consult the dealer or an experienced radio/television technician for help.



Nikon

COOLPIX P90

CAUTIONS

Modifications

The FCC requires the user to be notified that any changes or modifications made to this device that are not expressly approved by Nikon Corporation may void the user's authority to operate the equipment.

Interface Cables

Use the interface cables sold or provided by Nikon for your equipment. Using other interface cables may exceed the limits of Class B Part 15 of the FCC rules.

Notice for customers in the State of California WARNING

Handling the cord on this product will expose you to lead, a chemical known to the State of California to cause birth defects or other reproductive harm.

Wash hands after handling.

Nikon Inc.,

1300 Walt Whitman Road
Melville, New York 11747-3064
USA

Tel: 631-547-4200

Notice for customers in Canada

CAUTION

This Class B digital apparatus complies with Canadian ICES-003.

ATTENTION

Cet appareil numérique de la classe B est conforme à la norme NMB-003 du Canada.

Notice for customers in Europe

This symbol indicates that this product is to be collected separately.



The following apply only to users in European countries:

- This product is designated for separate collection at an appropriate collection point. Do not dispose of as household waste.
- For more information, contact the retailer or the local authorities in charge of waste management.

This symbol on the battery indicates that the battery is to be collected separately.



The following apply only to users in European countries:

- All batteries, whether marked with this symbol or not, are designated for separate collection at an appropriate collection point. Do not dispose of as household waste.
- For more information, contact the retailer or the local authorities in charge of waste management.

Table of Contents



For Your Safety	ii
WARNINGS	ii
Notices	v
<hr/>	
Introduction	1
About This Manual	1
Information and Precautions	2
Parts of the Camera	4
The Camera Body	4
Changing the Angle of the Monitor	6
Raising and Lowering the Built-in Flash	7
Attaching the Camera Strap and Lens Cap	7
The Monitor	8
Basic Operations	10
The Mode Dial	10
The Command Dial	11
The Multi Selector	12
The MENU Button	13
Switching Between Tabs	13
Help Displays	14
The INFO (monitor) Button	14
The DISP (display) Button	15
<hr/>	
First Steps	16
Charging the Battery	16
Inserting the Battery	18
Removing the Battery	19
Turning On and Off the Camera	19
Setting Display Language, Date and Time	20
Inserting Memory Cards	22
Removing Memory Cards	22
<hr/>	
 Basic Photography and Playback: Auto Mode	24
Step 1 Turn the Camera On and Select  (Auto) Mode	24
Indicators Displayed in  (Auto) Mode	25
Step 2 Frame a Picture	26
Using the Electronic Viewfinder	26
Using the Zoom	27
Step 3 Focus and Shoot	28
Step 4 Viewing and Deleting Pictures	30
Viewing Pictures (Playback Mode)	30
Deleting Pictures	30
Using the Flash	32
Setting the Flash Mode	33
Taking Pictures with the Self-Timer	35

Table of Contents

Using Focus Mode	36
Setting the Focus Mode	37
Using Manual Focus	38
Exposure Compensation	39
SCENE/📷 Shooting Suited for the Scenes	40
Shooting in Scene Mode	40
Setting the Scene Mode	40
Features	41
Taking Pictures in Food Mode	48
Taking Pictures for a Panorama	50
Shooting in the Scene Mode Selected by the Camera (Scene Auto Selector)	52
😊/👁️ Automatic Shooting of Smiling Faces	54
Using Smile Timer/Blink Proof	54
Notes on Blink Proof	55
🏃 Sport Continuous Mode	56
Shooting in Sport Continuous Mode	56
Sport Continuous Menu	58
Shoot pictures using P, S, A, M, U1 and U2	60
P, S, A, M modes	60
P (Programmed Auto) Mode	62
S (Shutter-Priority Auto) Mode	63
A (Aperture-Priority Auto) Mode	64
M (Manual) Mode	65
Using U1, U2 (User Setting Mode)	67
Save the Settings in U1 or U2	68
Resetting Saved Settings	69
Active D-Lighting	70
▶ More on Playback	71
Viewing Multiple Pictures: Thumbnail Playback	71
Calendar display	72
Taking a Closer Look: Playback Zoom	73
Editing Pictures	74
Using Quick Retouch	75
Enhancing Brightness and Contrast: D-Lighting	76
Creating a Cropped Copy: Crop	77
Resizing Pictures: Small Picture	78
Adding Black Frame on Pictures: Black Border	79
Voice Memos: Recording and Playback	80
Recording Voice Memos	80

Playing Voice Memos	80
Deleting Voice Memos	80
🎬 Movies	81
Recording Movies	81
The Movie Menu	82
🎬 Selecting Movie Options	82
🔊 Autofocus Mode	83
📺 Electronic VR	84
Time-Lapse Movies	84
Movie Playback	86
Deleting Movie Files	86
🎤 Voice Recordings	87
Making Voice Recordings	87
Playing Voice Recordings	89
Deleting Sound Files	90
Copying Voice Recordings	91
Connecting to Televisions, Computers and Printers	92
Connecting to a TV	92
Connecting to a Computer	93
Before Connecting the Camera	93
Transferring Pictures from the Camera to a Computer	94
Connecting to a Printer	97
Connecting the Camera and Printer	98
Printing Pictures One at a Time	99
Printing Multiple Pictures	100
Creating a DPOF Print Order: Print Set	103
MENU Shooting, Playback and Setup Menus	105
Shooting Options: The Shooting Menu	105
Displaying the Shooting Menu	106
📷 Image Quality	107
📷 Image size	108
🔄 Optimize Image	111
WB White Balance	114
ISO ISO Sensitivity	116
📷 Metering	117
📷 Continuous	118
BKT Auto Bracketing	121
[+] AF-Area Mode	122
🔊 Autofocus Mode	125
📷 Flash Exp. Comp.	125

Table of Contents

Noise Reduction.....	126
Distortion Control	126
Functions that Cannot be Applied Simultaneously.....	127
Playback Options: The Playback Menu	129
Displaying the Playback Menu	129
Slide Show.....	131
Delete.....	132
Protect	132
Rotate Image.....	133
Hide Image.....	133
Copy	134
Basic Camera Setup: The Setup Menu.....	135
Displaying the Setup Menu.....	136
Welcome Screen.....	137
Date.....	138
Monitor Settings.....	141
Date Imprint	142
Vibration Reduction.....	143
Motion Detection.....	144
AF Assist.....	145
Digital Zoom.....	145
Sound Settings	146
Auto Off.....	146
Format Memory/Format Card	147
Language.....	148
Video Mode.....	148
Blink Warning.....	149
Reset All	151
Reset file numbering.....	154
Firmware Version.....	154
<hr/>	
Technical Notes	155
Optional Accessories	155
Approved Memory Cards	155
File and Folder Names.....	156
Caring for the Camera	158
Cleaning	160
Storage.....	161
Error Messages	162
Troubleshooting.....	166
Specifications	172
Supported Standards	175
Index	176

About This Manual

Thank you for your purchase of a Nikon COOLPIX P90 digital camera. This manual was written to help you enjoy taking pictures with your Nikon digital camera. Read this manual thoroughly before use, and keep it where all those who use the product will read it.

Symbols and Conventions

To make it easier to find the information you need, the following symbols and conventions are used:



This icon marks cautions, information that should be read before use, to prevent damage to the camera.



This icon marks tips, additional information that may be helpful when using the camera.



This icon marks notes, information that should be read before using the camera.



This icon indicates that more information is available elsewhere in this manual or in the *Quick Start Guide*.

Notations

- A Secure Digital (SD) memory card is referred to as a “memory card”.
- The setting at the time of purchase is referred to as the “default setting”.
- The names of menu items displayed in the camera monitor, and the names of buttons or messages displayed in a computer monitor are indicated in bold text.

Screen Samples

In this manual, images are sometimes omitted from monitor and electronic viewfinder display samples so that monitor indicators can be more clearly shown.

Illustrations and Screen Display

Illustrations and text displays shown in this manual may differ from actual display.

Memory Cards

Pictures taken with this camera can be stored in the camera's internal memory or on removable memory cards. If a memory card is inserted, all new pictures will be stored on the memory card and delete, playback, and format operations will apply only to the pictures on the memory card. The memory card must be removed before the internal memory can be formatted or used to store pictures to, or delete, or view pictures.

Information and Precautions

Life-Long Learning

As part of Nikon's "Life-Long Learning" commitment to ongoing product support and education, continually updated information is available online at the following sites:

- For users in the U.S.A.: <http://www.nikonusa.com/>
- For users in Europe and Africa: <http://www.europe-nikon.com/support/>
- For users in Asia, Oceania, and the Middle East: <http://www.nikon-asia.com/>

Visit these sites to keep up-to-date with the latest product information, tips, answers to frequently asked questions (FAQs), and general advice on digital imaging and photography. Additional information may be available from the Nikon representative in your area. See the URL below for contact information:

<http://imaging.nikon.com/>

Use Only Nikon Brand Electronic Accessories

Nikon COOLPIX cameras are designed to the highest standards and include complex electronic circuitry. Only Nikon brand electronic accessories (including battery chargers, batteries and AC adapters) certified by Nikon specifically for use with this Nikon digital camera are engineered and proven to operate within the operational and safety requirements of this electronic circuitry.

THE USE OF NON-NIKON ELECTRONIC ACCESSORIES COULD DAMAGE THE CAMERA AND MAY VOID YOUR NIKON WARRANTY.

The use of third-party rechargeable Li-ion batteries not bearing the Nikon holographic seal could interfere with normal operation of the camera or result in the batteries overheating, igniting, rupturing, or leaking.

For more information about Nikon brand accessories, contact a local authorized Nikon dealer.

Holographic seal: Identifies this device as an authentic Nikon product.



Before Taking Important Pictures

Before taking pictures on important occasions (such as at weddings or before taking the camera on a trip), take a test shot to ensure that the camera is functioning normally. Nikon will not be held liable for damages or lost profits that may result from product malfunction.

About the Manuals

- No part of the manuals included with this product may be reproduced, transmitted, transcribed, stored in a retrieval system, or translated into any language in any form, by any means, without Nikon's prior written permission.
- Nikon reserves the right to change the specifications of the hardware and software described in these manuals at any time and without prior notice.
- Nikon will not be held liable for any damages resulting from the use of this product.
- While every effort was made to ensure that the information in these manuals is accurate and complete, we would appreciate it were you to bring any errors or omissions to the attention of the Nikon representative in your area (address provided separately).

Notice Concerning Prohibition of Copying or Reproduction

Note that simply being in possession of material that was digitally copied or reproduced by means of a scanner, digital camera or other device may be punishable by law.

- **Items prohibited by law from being copied or reproduced**

Do not copy or reproduce paper money, coins, securities, government bonds or local government bonds, even if such copies or reproductions are stamped "Sample". The copying or reproduction of paper money, coins, or securities which are circulated in a foreign country is prohibited. Unless the prior permission of the government was obtained, the copying or reproduction of unused postage stamps or post cards issued by the government is prohibited.

The copying or reproduction of stamps issued by the government and of certified documents stipulated by law is prohibited.

- **Cautions on certain copies and reproductions**

The government has issued cautions on copies or reproductions of securities issued by private companies (shares, bills, checks, gift certificates, etc.), commuter passes or coupon tickets, except when a minimum of necessary copies are to be provided for business use by a company. Also, do not copy or reproduce passports issued by the government, licenses issued by public agencies and private groups, ID cards and tickets, such as passes and meal coupons.

- **Comply with copyright notices**

The copying or reproduction of copyrighted creative works such as books, music, paintings, woodcut prints, maps, drawings, movies and photographs is governed by national and international copyright laws. Do not use this product for the purpose of making illegal copies or to infringe copyright laws.

Disposing of Data Storage Devices

Please note that deleting images or formatting data storage devices such as memory cards or built-in camera memory does not completely erase the original image data. Deleted files can sometimes be recovered from discarded storage devices using commercially available software, potentially resulting in the malicious use of personal image data. Ensuring the privacy of such data is the user's responsibility.

Before discarding a data storage device or transferring ownership to another person, erase all data using commercial deletion software, or format the device and then completely refill it with images containing no private information (for example, pictures of empty sky). Be sure to also replace any pictures selected for the welcome screen (📷137). Care should be taken to avoid injury or damage to property when physically destroying data storage devices.

Parts of the Camera

The Camera Body

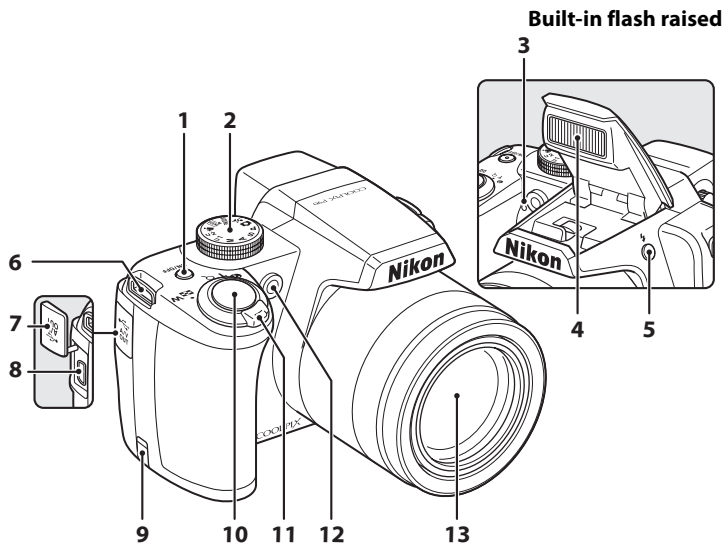

1	Power switch/Power-on lamp 19, 146	10	Shutter-release button 28
2	Mode dial 10		Zoom control 27
3	Built-in microphone 80, 81, 87		W : Wide 27
4	Built-in flash 7, 32		T : Tele 27
5	⚡ (Flash pop-up) button 7, 33	11	📷 : Thumbnail playback 71
6	Eyelet for camera strap (at 2 places) 7		🔍 : Playback zoom 73
7	Connector cover 92, 94, 98		🔍 : Help 14
8	Cable connector 92, 94, 98	12	Self-timer lamp 35
9	Power connector cover 155		AF-assist illuminator 145
		13	Lens 160, 172

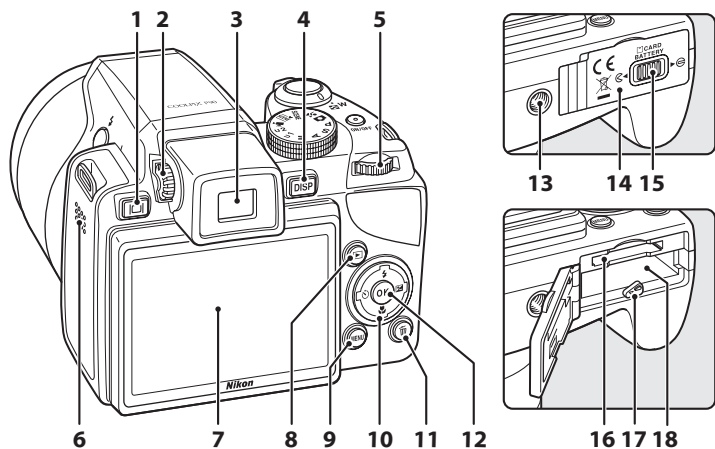

1	(monitor) button..... 14	10	Multi selector..... 12
2	Diopter adjustment control..... 14	11	(delete) button..... 30, 31, 80, 86, 90
3	Electronic viewfinder 14	12	(apply selection) button 12
4	DISP (display) button 15	13	Tripod socket
5	Command dial 11	14	Battery-chamber/ memory card slot cover 18, 22
6	Speaker 80, 86, 89	15	Cover latch..... 18, 22
7	Monitor 8, 15, 25	16	Memory card slot 22
8	(playback) button..... 30	17	Battery latch..... 18, 19
9	MENU button..... 13, 40, 82, 106, 129, 136	18	Battery chamber..... 18

Changing the Angle of the Monitor

The angle of the monitor can be lowered down to 45° or raised upward to 90°. This is convenient when taking pictures with the camera held at high or low positions.

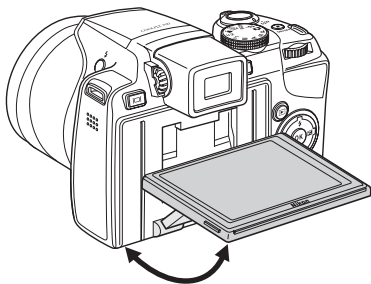
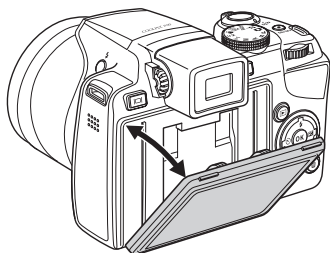

✓ Notes on Monitor

- Do not apply excessive force when changing the angle of the monitor.
- The monitor cannot be moved horizontally.
- Put the monitor back in the original position when using in normal situations.

Raising and Lowering the Built-in Flash

Press the ⚡ (flash pop-up) button to raise the built-in flash.

- When not using the built-in flash, gently push the flash down until it clicks shut.

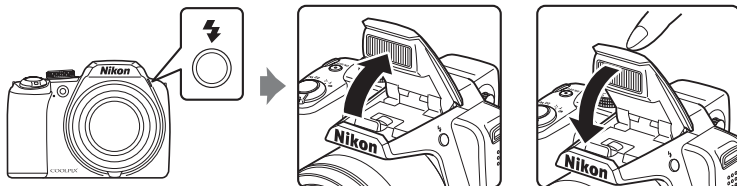

Attaching the Camera Strap and Lens Cap

Attach the lens cap to the strap, and then attach the strap to the camera (at two places).

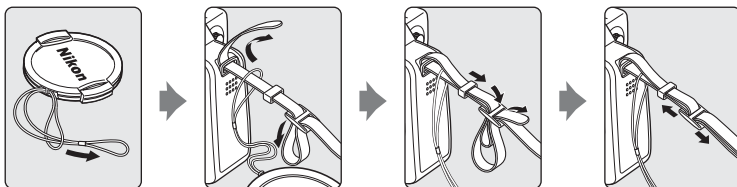

✓ Lens Cap

- Remove the lens cap before you shoot a picture.
- At times when you will not be shooting pictures such as when the power is off, or while you are carrying the camera, attach the lens cap to the camera to protect the lens.

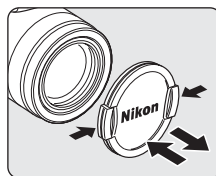

The Monitor

The following indicators may appear in the monitor during shooting and playback (actual display varies with current camera settings).

See page 15 for details on changing the monitor display.

Shooting

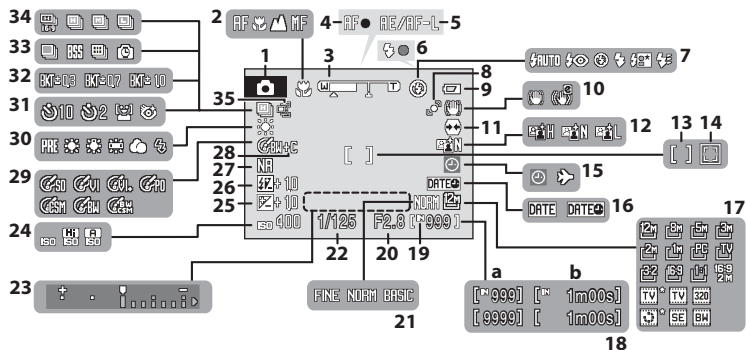

1	Shooting mode*	24, 40, 52, 56, 60, 81
2	Focus mode	36
3	Zoom indicator	27
4	Focus indicator	28
5	AE/AF-L indicator	51
6	Flash indicator	34
7	Flash mode	32
8	Motion detection icon	144
9	Battery level indicator	24
10	Vibration reduction icon (still pictures)	25, 143
11	Electronic VR icon (movies)	84
12	Distortion control	126
13	Active D-Lighting	70
14	Focus area	28, 122
15	Focus area (Face Priority)	122
16	"Date not set" indicator	162
17	Time zone indicator	138
18	Date imprint	142
19	Image size	108
20	Movie options	82

18	(a) Number of exposures remaining (still pictures)	24
	(b) Movie length	81
19	Internal memory indicator	25
20	Aperture	61
21	Image quality	107
22	Shutter speed	61
23	Exposure display	65
24	ISO sensitivity	34, 116
25	Exposure compensation value	39
26	Flash exposure compensation	125
27	Noise reduction	126
28	B&W + color	113
29	Image optimization	111
30	White balance mode	114
31	Self-timer indicator	35
	Smile timer	54
	Blink proof	55
32	Bracketing	121
33	Continuous shooting mode	58, 118
34	High-speed mode	58
35	Pre-shooting cache	58, 59

* Differs according to the current shooting mode. Refer to the sections on each mode for details.

Playback

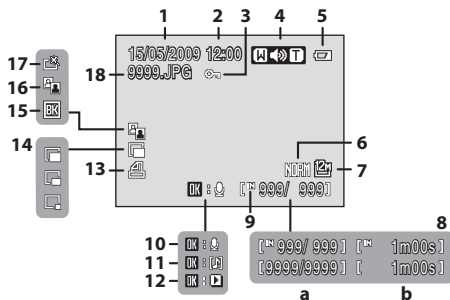

1	Date of recording.....	20	10	Voice memo recording guide	80
2	Time of recording	20	11	Voice memo playback guide	80
3	Protect icon.....	132	12	Movie playback indicator.....	86
4	Volume indicator	80, 86	13	Print-order icon	103
5	Battery level indicator	24	14	Small picture	77, 78
6	Image quality*	107	15	Black border indicator	79
7	Image size	108	16	D-Lighting icon	76
	Movie options*	82	17	Quick retouch icon.....	75
8	(a) Current frame number/ total number of frames.....	30	18	File number and type	156
	(b) Movie length	86			
9	Internal memory indicator	30			

* Differs according to the selected option.

Basic Operations

The Mode Dial

Align the mode icon with the mark next to the mode dial.

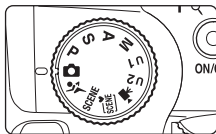

Introduction

Auto (📖24)

Choose this simple mode, an automatic, “point-and-shoot” mode recommended for first-time users of digital cameras.

Sport Continuous (📖56)

Continuous shooting of pictures are done at high speeds when the shutter-release button is pressed down fully.

SCENE Scene (📖40)

Choose this mode for automatic adjustment of settings to suit the selected subject type, or use the voice recording option to record sound only.

P, S, A, M (📖60)

Choose these modes for greater control over shutter speed and aperture.

U1, U2 User Setting (📖67)

Save the settings made in shooting modes **P, S, A** and **M**. Once the settings are saved, you can shoot with the settings that are more frequently used by just changing over to this mode.

Movie (📖81)

Choose this mode to shoot movies.

Scene Auto Selector (📖52)

By simply framing a picture, the camera automatically selects the optimum scene mode for simpler shooting.

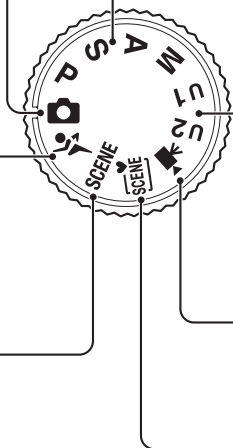

The Command Dial

You can rotate the command dial to select items from a menu screen or to choose and configure any of the following functions.

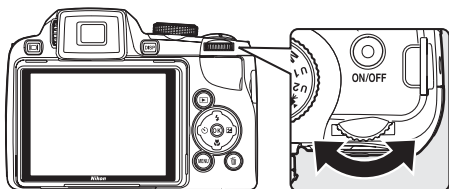

For Shooting

Mode	Use	Description	
Programmed auto (mode dial set to P)		Change the flexible program	62
Shutter-priority auto (mode dial set to S)		Adjust shutter speed	63
Aperture-priority auto (mode dial set to A)		Adjust aperture	64
Manual (mode dial set to M)		Adjust shutter speed or aperture (press the multi selector to select a different option)	65

For Playback

Mode	Use	Description	
Full-frame playback or thumbnail playback		Choose a picture	30, 71
Calendar display		Choose a date	72
Playback zoom		Change the zoom ratio	73
Movie/Audio playback		Advance/Rewind	86, 90

The Multi Selector

This section describes standard uses of the multi selector to select modes, select menu options, and to apply selections.

For Shooting

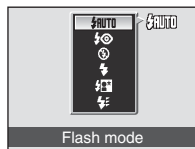
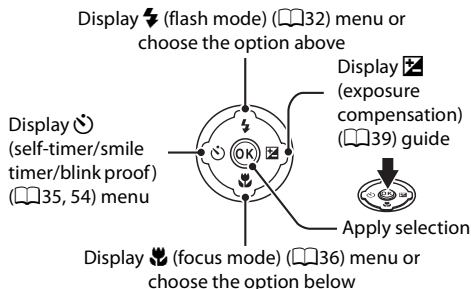

For Playback

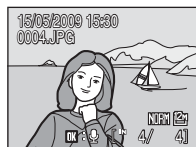
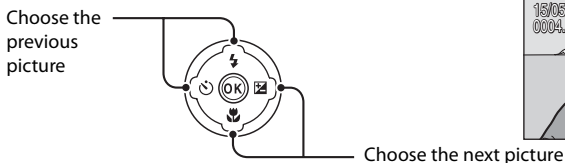

For the Menu Screen

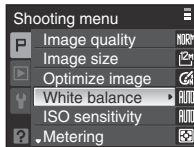
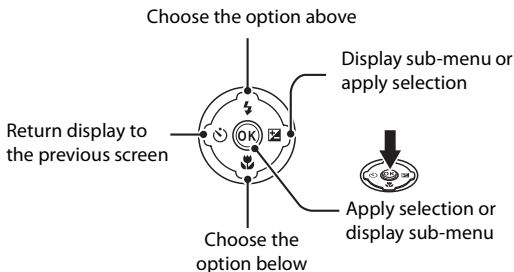

Note on the Multi Selector

In this manual, up, down, left, and right presses of the multi selector may be indicated with ▲, ▼, ◀, and ▶.

The MENU Button

Press the **MENU** button to display the menu and to select options for the menu items.

- Use the multi selector to navigate the menus (12).
- Menu items can also be chosen by rotating the command dial.
- Choose the tabs on the left to display the options for each menu item.
- Press the **MENU** button again to exit the menu.

Displayed when the menu contains two or more pages

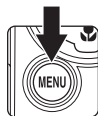

- **Top tab:**
Display the menus for the mode selected by the mode dial
 - **Middle tab:**
Display the playback menu
 - **Bottom tab:**
Display the setup menu
- Displayed when there are following menu options

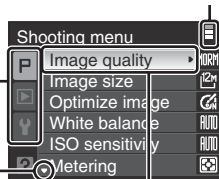

The selected option

Displayed when there are previous menu options

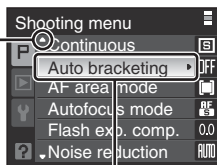

Press the **OK** button or the multi selector **▶** to proceed to the next set of options.

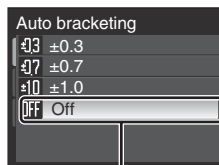

Press the **OK** button or the multi selector **▶** to apply the selection.

Switching Between Tabs

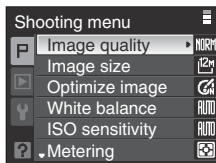

Press the multi selector **◀** to highlight the tab.

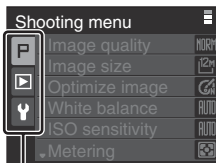

Press the multi selector **▲▼** to choose another tab, and press either the **OK** button or **▶**.

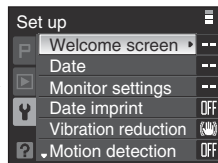

The chosen menu is displayed.

Help Displays

Rotate the zoom control to **T** (🔍) when **?** is displayed at the bottom of the menu screen to view a description of the currently selected menu option.

To return to the original menu, rotate the zoom control to **T** (🔍) again.

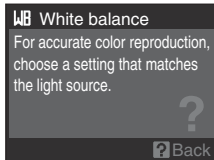
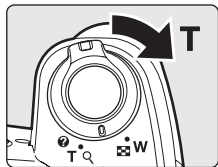

The **|** (monitor) Button

Press the **|** (monitor) button to switch between the monitor or electronic viewfinder. Switch to the one that suits the shooting conditions. For example, use the electronic viewfinder in bright locations when it is difficult to see the monitor.

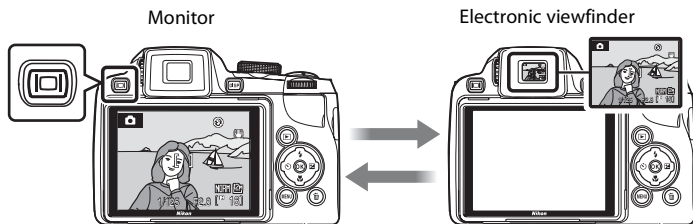

✔ Dioptr Adjustment of Electronic Viewfinder

When the diopter for the electronic viewfinder is out of focus and the display is difficult to see, adjust the diopter with the diopter adjustment control. While looking into the viewfinder, rotate the diopter adjustment control until the display is clearly visible.

Take care not to scratch your eye with your fingertips or nails when rotating the diopter adjustment control.

Diopter adjustment control

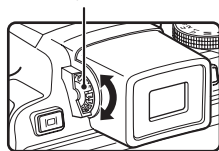

The DISP (display) Button

To switch between the information displayed on the monitor during shooting and playback, press the **DISP** button.

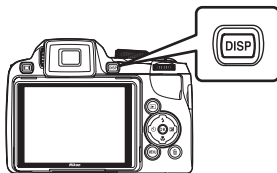

For Shooting

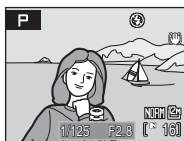

Display information

Display the picture and the shooting data.

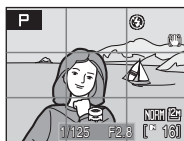

Framing grids¹

Display a boxed guide for framing.



Information hidden

Display the picture only.

For Playback

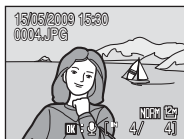

Display photo information

Display the picture taken and the photo information.

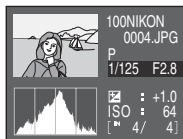

Display shooting data (except for movies)

Display highlight², histogram³ and shooting data⁴.



Information hidden

Display only the taken picture.

1 Available only when mode dial is set to **P, S, A, M, U1** or **U2**

2 The brightest portions of the image (portions that are highlighted) will blink. Use highlights as a guide when setting exposure.

3 A graph showing tone distribution. The horizontal axis corresponds to pixel brightness, with dark tones to the left and bright tones to the right. The vertical axis shows the number of pixels.

4 The shooting data displayed includes the folder name, file name, shooting mode used (**P, S, A** or **M**), shutter speed, aperture, exposure compensation, ISO sensitivity, and the current file number/total number of exposures.

P is displayed when the shooting mode **SCENE**, **AF-ON**, **AF-L** or **P** is chosen.

Charging the Battery

Charge the Rechargeable Li-ion Battery EN-EL5 (supplied) using the Battery Charger MH-61 (supplied).

1 Connect the power cable in the order of ①-②.

- The CHARGE lamp will light.

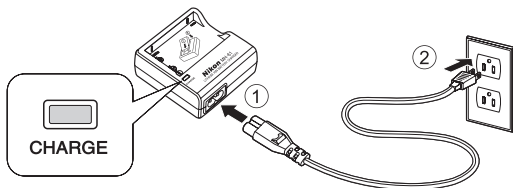

2 Insert the battery into the battery charger by sliding the battery forward ①, and press down until it locks into place ②.

- CHARGE lamp starts blinking when charging starts.
- Charging is complete when the lamp stops blinking.
- About two hours are required to charge a fully exhausted battery.

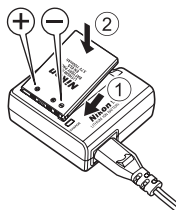

The following chart explains CHARGE lamp status.

CHARGE lamp	Description
Blinks	Battery charging.
On	Battery fully charged.
Flickers	<ul style="list-style-type: none"> • The battery is not inserted correctly. Remove the battery and reinsert it into the battery charger so that the battery is lying flat. • The temperature is not suitable for usage. Use the charger in a room with a surrounding temperature range of 5 to 35°C (41 to 95°F) to charge the battery. • The battery is faulty. Unplug the charger immediately and stop charging the battery. Bring the battery and charger to a Nikon-authorized service representative for inspection.

3 Remove the battery and unplug the charger.

Notes on the Battery Charger

- The supplied battery charger is for use only with a Rechargeable Li-ion Battery EN-EL5. Do not use with incompatible batteries.
- Be sure to read and follow the warnings and cautions of “For Your Safety” (📖ii) thoroughly before using the battery charger.

Notes on the Battery

- Be sure to read and follow the warnings and cautions of “For Your Safety” (📖ii) thoroughly before using the battery.
- Be sure to read and follow the warnings for “The Battery” (📖159) of the section “Caring for the Camera” thoroughly before using the battery.
- If the battery will not be used for an extended period, recharge it at least once every six months and run it flat before returning it to storage.

Note on AC Power Supply

To power the camera continuously for extended periods, use the AC Adapter EH-62A (available separately from Nikon) (📖155). Do not, under any circumstances, use another make or model of AC adapter. Failure to observe this precaution could result in overheating or in damage to the camera.

Inserting the Battery

Insert a Rechargeable Li-ion Battery EN-EL5 (supplied) into the camera.

- Charge the battery before first use or when the battery is running low (16).

- 1 Open the battery-chamber/memory card slot cover.

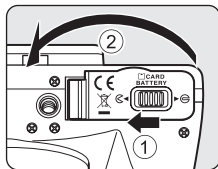

- 2 Insert the battery.

- Confirm that the positive (+) and negative (-) terminals are oriented correctly, as shown on the label at the entrance of the battery chamber, and insert the battery.
- Use the battery to push the orange battery latch in the direction indicated by the arrow 1 and fully insert the battery 2. When the battery is fully inserted, the battery latch will lock it in place.

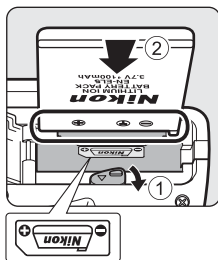

✓ Inserting the Battery Correctly

Inserting the battery upside down or backwards could damage the camera. Be sure to confirm that the battery is in the correct orientation.



- 3 Close the battery-chamber/memory card slot cover.

- Close the battery-chamber/memory card slot cover 1, and slide the cover latch to the 2 position.

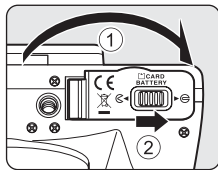

Removing the Battery

Turn the camera off and confirm that the power-on lamp and the monitor are off before opening the battery-chamber/memory card slot cover.

To eject the battery, open the battery-chamber/memory card slot cover and slide the orange battery latch in the direction shown ①. The battery can then be removed by hand ②.

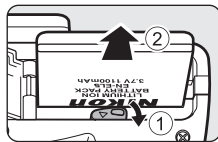



- Note that the battery may become hot during use; observe due caution when removing the battery.

Turning On and Off the Camera

Remove the lens cap before turning on the camera. Press the power switch to turn on the camera. The power-on lamp (green) will light for a moment and the monitor will turn on.

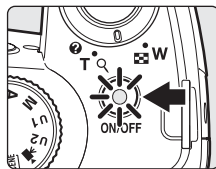
Pressing the power switch when the power-on lamp (green) or the monitor is lighted up will turn off the camera.





- When the camera is off, holding down the  button will turn the camera on in playback mode (30).
- If **Lens error** is displayed, check that the lens cap has been removed and turn the camera on again.

Auto Power Off while in Shooting Mode (Standby Mode)

If no operations are performed for about a minute (default setting), the monitor will turn off automatically and the camera will enter standby mode. If no operations are performed for another three minutes, the camera will turn off automatically (auto off function).

If the monitor is off in standby mode, press the power switch or the shutter-release button to reactivate it.

- The time allowed to elapse before the camera enters standby mode can be changed from the **Auto off** option (146) in the setup menu (135).

Setting Display Language, Date and Time

A language-selection dialog is displayed the first time the camera is turned on.

1 Press the power switch to turn on the camera.

- The power-on lamp (green) will light for a moment and the monitor will turn on.
- Remove the lens cap.

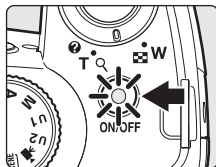

2 Use the multi selector to choose the desired language and press the OK button.

- For information on using the multi selector, see "The Multi Selector" (📖12)



3 Choose Yes and press the OK button.

- If No is selected, the date and time will not be set.

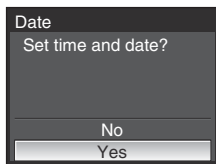

4 Press the multi selector ◀ or ▶ to select your home time zone (📖140) and press the OK button.

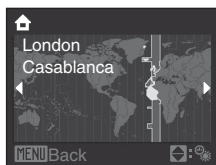

🔍 Daylight Saving Time

If daylight saving time is in effect, press the multi selector ▲ in the time zone selection screen displayed in step 4 to turn on the daylight saving time option.

When the daylight saving time option is enabled, 🌞 is displayed at the top of the monitor.

To turn off the daylight saving time option, press ▼.



5 Edit the date.

- Press ▲ or ▼ to edit the highlighted item.
- Press ► to move the highlight in the following order:
D (day) → **M** (month) → **Y** (year) → **hour** → **minute** → **DMY** (the order in which the day, month, and year are displayed)
- Press ◀ to return to the previous cursor.

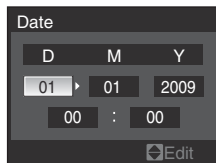
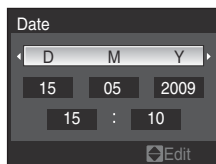
**6** Choose the order in which the day, month and year are displayed.**7** Check that the lens cap is removed, and press the **OK** button.

- The settings are applied and monitor display reverts to shooting mode.
- The lens will extend at this time.

🔍 Changing the Date and Time

- Select **Date** from **Date** (📖138) in the setup menu (📖135) to change the current date and time, and follow the procedure described in step 5 above.
- Select **Time zone** from **Date** in the setup menu to change the time zone and daylight saving time settings (📖138).

Inserting Memory Cards

Image, sound, and movie files are stored in the camera's internal memory (approx. 47 MB) or on removable memory cards (available separately) (155).

If a memory card is inserted in the camera, data is automatically stored on the memory card and data recorded to the memory card can be played back, deleted, or transferred. Remove the memory card to store data in the internal memory, or play back, delete, or transfer data from the internal memory.

- 1 Confirm that the power-on lamp and the monitor are turned off and open the battery-chamber/memory card slot cover.

- Be sure to turn off the camera before opening the battery-chamber/memory card slot cover.

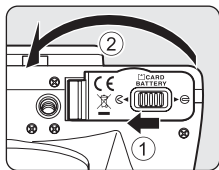

- 2 Insert the memory card.

- Slide the memory card in correctly as shown on the right, until it clicks into place.
- Close the battery-chamber/memory card slot cover after inserting the memory card.

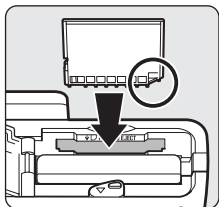

Inserting the Memory Card Correctly

Inserting the memory card upside down or backwards could damage the camera or the memory card. Be sure to confirm that the memory card is in the correct orientation.

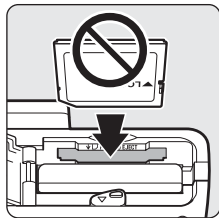

Removing Memory Cards

Before removing memory cards, **turn the camera off** and confirm that the power-on lamp and the monitor are off.

Open the battery-chamber/memory card slot cover and press the card in ① gently to partially eject the card. The card can then be removed by hand ②.

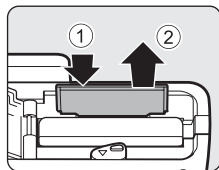

✓ Formatting a Memory Card

If the message at the right is displayed when the camera is turned on, the memory card must be formatted before use. **Note that formatting** (📖147) **permanently deletes all data on the memory card.** Be sure to make copies of any pictures you wish to keep before formatting the memory card.

Use the multi selector to choose **Yes** and press the **OK** button. When the confirmation dialog is displayed, choose **Format** and press the **OK** button to start formatting.

- Do not turn the camera off, or open the battery-chamber/memory card slot cover until formatting is complete.
- When you insert memory cards used in other devices into this camera for the first time, be sure to format them (📖147) with this camera.

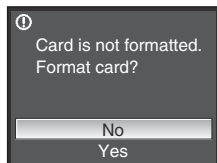

✓ The Write Protect Switch

Memory cards are equipped with a write protect switch. When this switch is in the "lock" position, data cannot be written to, or deleted from, the memory card. If the switch is in the "lock" position, unlock it by sliding the switch to the "write" position to record or delete pictures, or to format the memory card.

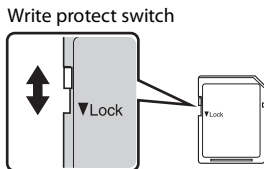

✓ Memory Cards

- Use only Secure Digital memory cards.
- Do not perform the following operations during formatting, while data is being written to or deleted from the memory card, or during data transfer to a computer. Failure to observe this precaution could result in the loss of data or in damage to the camera or memory card:
 - Eject the memory card
 - Remove the battery
 - Turn off the camera
 - Disconnect the AC adapter
- Do not use a computer to format the memory card.
- Do not disassemble or modify.
- Do not drop, bend, or expose to water or strong physical shocks.
- Do not touch the metal terminals with your fingers or metal objects.
- Do not affix labels or stickers to the memory card.
- Do not leave in direct sunlight, closed vehicles or areas exposed to high temperatures.
- Do not expose to humidity, dust, or to corrosive gases.

Step 1 Turn the Camera On and Select (Auto) Mode

This section describes how to take pictures in  (auto) mode, an automatic, “point-and-shoot” mode recommended for first-time users of digital cameras.

1 Rotate the mode dial to .

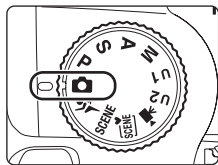

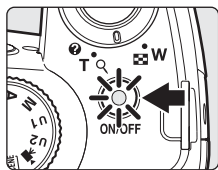

2 Remove the lens cap and press the power switch.

- The power will be turned on, and the lens will extend.
- The power-on lamp (green) will light for a moment and the monitor will turn on.



3 Check the battery level and number of exposures remaining in the monitor.

Battery Level

Monitor	Description
NO INDICATOR	Battery fully charged.
	Battery level low; prepare to charge or replace the battery.
 Battery exhausted.	Cannot shoot. Recharge or replace with a fully-charged battery.

Battery level indicator

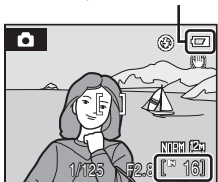

Number of exposures remaining

Number of Exposures Remaining



The number of exposures remaining will be displayed.

The number of pictures that can be stored depends on the remaining capacity of the internal memory or memory card, the image quality, and the image size (109).

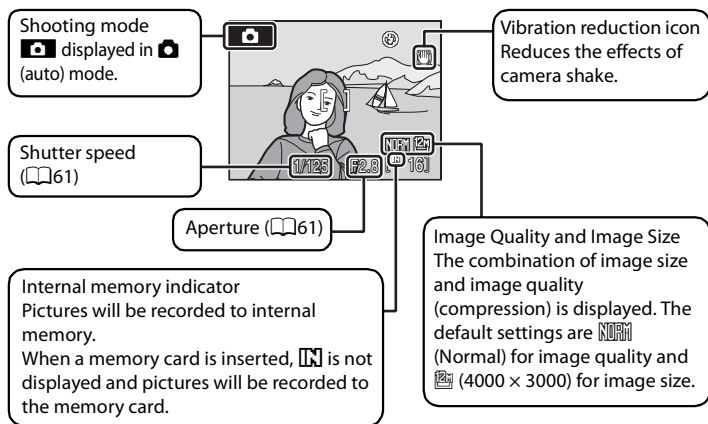







Indicators Displayed in (Auto) Mode



Note on the Flash

When the built-in flash is lowered, the flash setting is fixed to off and  appears at the top of the monitor. In situations where flash is needed, such as in dark locations or when the subject is backlit, be sure to raise the built-in flash (33).

Functions Available in (Auto) Mode

In  (auto) mode, focus mode (36) and exposure compensation (39) can be applied and pictures can be taken using the flash mode (32) and self-timer (35). Pressing the **MENU** button in  (auto) mode allows you to specify settings for the shooting menu options: **Image quality** (107) and **Image size** (108).

Vibration Reduction

When **On** (default setting) is chosen for **Vibration reduction** (143), the camera effectively reduces camera shake that commonly occurs when shooting with zoom applied or at slow shutter speeds.

Set **Vibration reduction** to **Off** when using a tripod to stabilize the camera during shooting.

Step 2 Frame a Picture

1 Ready the camera.

- Hold the camera steadily in both hands.
- Keep your fingers, hair, strap and other objects away from the lens, flash, AF-assist illuminator, microphone and speaker.

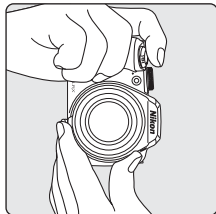
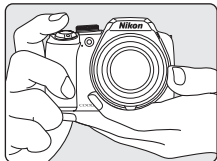

2 Frame the picture.

- Position the main subject near the center of the monitor.

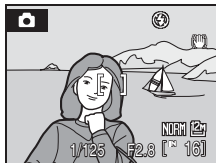

Using the Electronic Viewfinder

Use the electronic viewfinder to frame pictures when bright light makes it difficult to see the display in the monitor. Press the  button to switch to the electronic viewfinder (14).

When the diopter for the electronic viewfinder is out of focus, rotate the diopter adjustment control to a position where the display is clearly visible (14).

Using the Zoom

Rotate the zoom control to activate optical zoom. Rotate in the direction of **T** to zoom in on the subject. Or rotate in the direction of **W** to have a wider view. Rotating the zoom control all the way in either direction will adjust the zoom quickly, while rotating the control partially will adjust the zoom slowly.

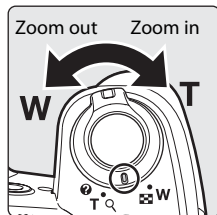

A zoom indicator is displayed at the top of the monitor when the zoom control is rotated.

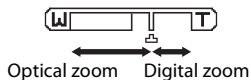

Digital Zoom

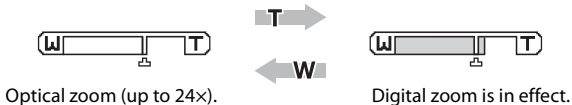

When the camera is already at the maximum optical zoom magnification, rotating the zoom control in the **T** direction will trigger digital zoom. The subject can be magnified up to 4x of the maximum optical zoom ratio.

Focus will be on the center of the frame and the focus area will not be displayed when digital zoom is in effect.



Digital Zoom and Interpolation

Unlike optical zoom, digital zoom uses a digital imaging process known as interpolation to magnify images, resulting in slight deterioration of picture quality according to the image size (108) and digital zoom magnification.

Interpolation is applied at zoom positions beyond . When zoom is increased beyond the  position, interpolation is initiated and the zoom indicator turns yellow to indicate that interpolation is being applied.

The position of  moves to the right as image size decreases, allowing for confirmation of the zoom positions at which shooting without interpolation is possible at the current image size setting.

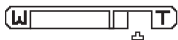

When the image size is small

- By using **Digital zoom** (145) in the setup menu (135), it is possible to restrict the magnification of the digital zoom within a range where images may not deteriorate, or to set the digital zoom so that it will not operate.

Step 3 Focus and Shoot

1 Press the shutter-release button halfway.

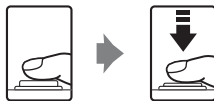

- The camera focuses on the subject in the center focus area. When the subject is in focus, the focus area will glow green.



- When digital zoom is in effect, the focus area is not displayed. When the camera focuses on the subject in the center of the frame, the focus indicator (📖8) will glow green.
- Focus and exposure remain locked while the shutter-release button is pressed halfway.
- When the shutter-release button is pressed halfway and the camera is unable to focus, the AF-area or focus indicator blinks red. Change the composition and press the shutter-release button halfway again.

2 Press the shutter-release button the rest of the way down.



- The shutter will be released and the picture will be recorded to the memory card or internal memory.

Pressing the Shutter-Release Button Halfway/All the Way Down

The camera features a two-stage shutter-release button. To set focus and exposure, press the shutter-release button halfway, stopping when you feel resistance. Focus and exposure lock while the shutter-release button is held in this position. To release the shutter and take a picture, press the shutter-release button the rest of the way down.

Do not use force when pressing the shutter-release button, as this may result in camera shake and blurred pictures.



Press the shutter-release button halfway to lock focus and exposure.

Press the shutter-release button the rest of the way down to shoot.

✓ During Recording

While pictures are being recorded, the number of exposures remaining display will blink. **Do not open the battery-chamber/memory card slot cover** while pictures are being recorded. Cutting power or removing the memory card in these circumstances could result in loss of data or in damage to the camera or card.

✓ Autofocus

Autofocus may not perform as expected in the following situations. In some rare cases, the subject may not be in focus despite the fact that the active focus area, or focus indicator, glows green:

- Subject is very dark
- Objects of sharply differing brightness are included in the scene (e.g. the sun is behind the subject and is in deep shadow)
- No contrast between the subject and surroundings (e.g. when the subject is standing in front of a white wall, wearing a white shirt)
- Several objects are at different distances from the camera (e.g. the subject is inside a cage)
- Subject is moving rapidly

In the situations noted above, try pressing the shutter-release button halfway to refocus several times, or focus on another subject and use focus lock. When using focus lock, be sure that the distance between the camera and the subject with which focus was locked is the same as that for the actual subject.

📍 Focus Lock

Use focus lock to focus on off-center subjects when Center is selected for AF area mode.

- Be sure that the distance between the camera and the subject does not change.
- When the shutter-release button is pressed halfway, exposure is locked.

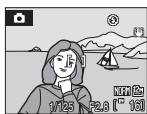

Frame the subject to be focused on using the camera



Press the shutter-release button halfway.



Confirm that the focus area is green.



Continue holding down the shutter-release button halfway and recompose the picture.

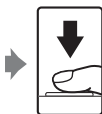

Press the shutter-release button the rest of the way down to shoot.







📍 AF-assist illuminator

If the subject is poorly lit, the AF-assist illuminator (📖145) may light by pressing the shutter-release button halfway.

Step 4 Viewing and Deleting Pictures

Viewing Pictures (Playback Mode)

Press the  button.

- The last picture shot will be displayed in full-frame playback mode.
- Press the multi selector , ,  or  to view additional pictures. Continue holding down the button to fast forward pictures. Pictures can also be chosen by rotating the command dial.
- Pictures may be displayed briefly at low resolution while being read from the memory card or internal memory.
- Press the  button or the shutter-release button to switch to shooting mode.
- When  is displayed, pictures stored in the internal memory will be displayed. When memory card is inserted,  is not displayed and pictures stored on the memory card will be displayed.

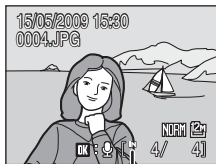
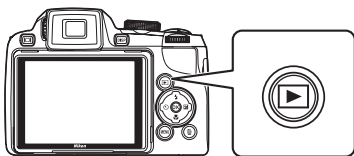



Internal memory indicator

Deleting Pictures

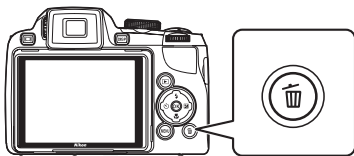
- 1 Press the  button to delete the picture currently displayed in the monitor.







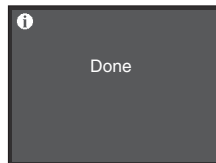
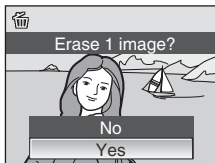



- 2 Use the multi selector to choose **Yes** and press the  button.

- To exit without deleting the picture, choose **No** and press the  button.



Options Available in Playback Mode



The following options are available in full-frame playback mode.

Option	Use	Description	
Playback zoom	T 	Enlarge the view of the picture currently displayed in the monitor, up to about 10x. Press the OK button to return to full-frame playback.	73
Thumbnail display/ Calendar display	W 	Display images by 4, 9 or 16 picture thumbnails or the calendar.	71
Hide or show photo information	DISP	Hide or show the shooting information and photo information in monitor.	15
Switch between displays		Switch between the monitor and electronic viewfinder display.	14
Record/play voice memos		Record or play back voice memos up to 20 seconds in length.	80
Switch to shooting mode		Press the  button or the shutter-release button to change back to the last chosen shooting mode.	30
			

Pressing the Button to Turn on the Camera

When the camera is off, holding down the  button will turn the camera on in playback mode. The lens will not extend.

Viewing Pictures

- Pictures stored in the internal memory can only be viewed if no memory card is inserted.
- Pictures that were shot using face priority ( 123) will be rotated automatically when displayed in full-frame playback mode according to the orientation of the face.
- If the monitor is off in standby mode due to the camera's auto off function, press the  button to reactivate it ( 146).

Deleting the Last Picture Taken While in Shooting Mode

In shooting mode, press the  button to delete the last picture shot.

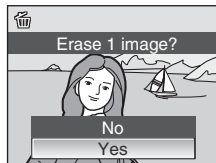

Deleting Multiple Pictures

Choose **Delete** ( 132) from the playback menu ( 129) to delete multiple pictures.

Using the Flash

In dark locations or when the subject is backlit, you can shoot pictures with flash by raising the built-in flash.

The flash has a range of about 0.5 to 8.0 m (1 ft. 8 in. to 26 ft.) for wide, and about 1.7 to 5.0 m (5 ft. 7 in. to 16 ft.) for tele (when **ISO sensitivity** is set to **Auto**).

Change the flash setting according to each situation.

Auto

Flash fires automatically when lighting is poor.

Auto with red-eye reduction

Reduces “red-eye” in portraits (📖34).

Off

Flash will not fire even when lighting is poor.

Fill flash

Flash fires when a picture is taken. Use to “fill-in” (illuminate) shadows and backlit subjects.

Slow sync

Fill flash is combined with slow shutter speed.

Flash illuminates main subject; slow shutter speeds are used to capture background at night or under dim light.

Rear-curtain sync

Flash fires just before shutter closes, creating the effect of a stream of light behind moving subjects.

Setting the Flash Mode

1 Press the (flash pop-up) button.

The built-in flash will be raised.

- When the built-in flash is lowered, the flash mode will be fixed to  (off).

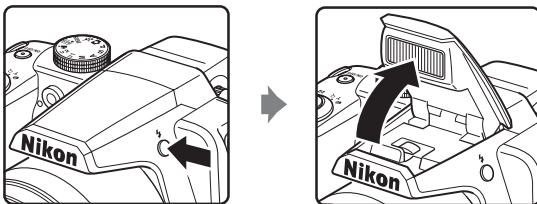





2 Press (flash mode).

- The flash mode menu is displayed.



3 Use the multi selector to choose the desired mode and press the button.

- The icon for the selected flash mode is displayed at the top of the monitor.
- When  (auto) is applied,  is only displayed for a few seconds even if monitor indicators ( 15) are turned on.
- If a setting is not applied by pressing the  button within a few seconds, the selection will be cancelled.

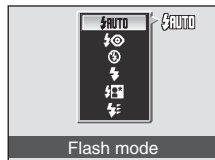

Lowering the Built-in Flash

When not using the built-in flash, gently push to lower the flash until it clicks shut ( 7).

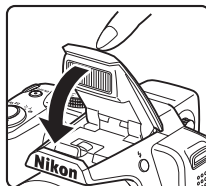

✔ Shooting When Lighting is Poor and When the Flash is Disabled (🔇)

- Use of a tripod is recommended to stabilize the camera during shooting and avoid the effects of camera shake. Set **Vibration reduction** (📖143) to **Off** when using a tripod to stabilize the camera during shooting.
- The **ISO** indicator is displayed when the camera automatically increases sensitivity. Pictures taken when **ISO** is displayed may be slightly mottled.

✔ Note on Using the Flash

When using the flash, reflections from dust particles in the air may appear as bright spots in pictures. To reduce these reflections, set the flash mode to 🚫 (Off), or shoot pictures with the built-in flash lowered.

🔧 The Flash Indicator

The flash indicator shows the flash status when the shutter-release button is pressed halfway down.

- On: Flash will fire when picture is shot.
- Blinks: Flash is charging. Wait a few seconds and try again.
- Off: Flash will not fire when picture is shot.



🔧 The Flash Mode Setting

- The default flash mode setting varies with shooting mode.
 - 📷 (auto) mode: 🚫AUTO (auto)
 - **P, S, A, M** mode: 🚫AUTO (auto)
 - Scene mode: setting varies for different scene modes (📖41 to 47).
 - 📷 (scene auto selector) mode: 🚫AUTO (auto) the camera automatically chooses the optimum flash mode setting for the scene mode it has selected (📖32).
 - 🏃 (sport continuous) mode: 🚫 (off)
 - Time-lapse movie: 🚫AUTO (Auto)
- The flash mode setting 🚫👁 (auto with red-eye reduction) applied in 📷 (auto) mode is stored in the camera's memory even after the camera is turned off, and reapplied the next time 📷 (auto) mode is selected.
- For **P, S, A** and **M** shooting modes, the setting for flash mode will be stored in the camera's memory even after the camera is turned off.

🔧 Red-eye Reduction

This camera uses Advanced Red-eye Reduction ("In-Camera Red-Eye Fix").

The flash fires repeatedly at low intensity before the main flash, reducing the red-eye effect.

The camera then analyzes the picture; if red-eye is detected, the affected area will be processed to further reduce red-eye before the picture is saved.

Note that because there is a slight lag between the shutter-release button being pressed and the picture being shot, this mode is not recommended when a quick shutter response is required. The time before the next picture can be shot also increases slightly. Advanced red-eye reduction may not produce the desired results in all situations. In extremely rare instances, areas not subject to red-eye may be affected by advanced red-eye reduction processing; in these cases, choose another mode and try again.

Taking Pictures with the Self-Timer

The self-timer function is useful when you wish to have your picture taken, such as when taking memorial pictures, and for reducing the effects of camera shake that occurs when the shutter-release button is pressed. When using the self-timer, use of a tripod is recommended. Turn **Vibration reduction** (📖 143) off when using a tripod.

1 Press (self-timer).

- The self-timer menu is displayed.



2 Use the multi selector to choose **10s** or **2s** and press the button.

- **10s** (ten seconds): suitable for memorial portraits.
- **2s** (two seconds): suitable for preventing camera shake.
- The mode selected for self-timer is displayed.
- If a setting is not applied by pressing the  button within a few seconds, the selection will be cancelled.

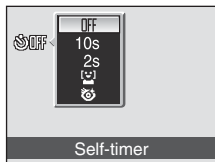

3 Frame the picture and press the shutter-release button halfway.

- Focus and exposure will be set.

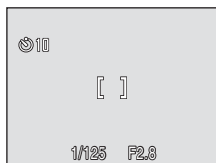

4 Press the shutter-release button the rest of the way down.

- The self-timer starts, and the number of seconds remaining until the shutter is released is displayed in the monitor. The self-timer lamp will blink. The lamp stops blinking one second before the picture is taken and remains lit until the shutter is released.
- When the shutter is released, the self-timer turns **OFF**.
- To stop the timer before a picture is taken, press the shutter-release button again.

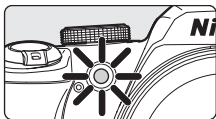

Note on (smile timer) and (blink proof)

If  or  is chosen, the shutter is automatically released (📖 54) when smiling faces are detected using face priority.

Using Focus Mode



Choose a focus mode according to the subject and composition.

AF Autofocus

Camera automatically adjusts focus according to distance to subject. Use when the distance from subject to lens is 50 cm (1 ft. 8 in.) or more, or 1.7 m (5.6 ft.) or more when camera is zoomed all the way out.



Macro close-up

Use for close-ups of flowers or small objects.

The closest shooting distance will vary according to the magnification of the zoom. When the zoom indicator is positioned where the  mark glows green, the camera can focus on subjects as close as 10 cm (4 in.) from the lens. At the  zoom position, the camera can focus on subjects as close as 1 cm (0.4 in.) from the lens.

Infinity







Use when shooting distant scenes through foreground objects such as windows or when shooting landscapes.

When the shutter-release button is pressed halfway, the focus area or focus indicator () always glows green. However, the camera may not be able to focus on nearby objects. The flash mode is set to  (off).

MF Manual focus

The focus can be adjusted for any subject that is a distance of 1 cm (0.4 in.) to infinity from the lens ()38).

Focus Modes Available in Each Shooting Mode

		P, S, A, M, U1, U2	SCENE			
AF (Autofocus)	✓*1	✓*1	*2	*3	✓*1	✓*1
 (Macro close-up)	✓	✓			✓	✓
 (Infinity)	✓	✓			✓	✓
MF (Manual)	–	✓	–	✓	–	

*1 Default setting for each shooting mode.

*2 Available focus modes and default setting varies between different scene modes ()41 to 51).

*3 The camera sets the focus mode according to the scene mode that it has automatically determined ()52).

The Focus Mode Setting

For **P**, **S**, **A** and **M** shooting modes, the changed setting for focus mode will be stored in the camera's memory even after the camera is turned off.



Setting the Focus Mode

1 Press (focus mode).

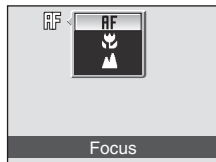
- The focus mode menu is displayed.



2 Use the multi selector to choose the focus mode and press the button.

- The mode selected for focus mode is displayed.
- When **AF** (autofocus) is applied, **AF** is only displayed for a few seconds even if monitor indicators () are turned on.
- If a setting is not applied by pressing the  button within a few seconds, the selection will be cancelled.



Macro Close-up

In macro close-up mode, the camera will automatically repeat focusing. The focus will lock by pressing the shutter-release button halfway and exposure will be fixed.

However, in **P, S, A, M, U1** and **U2** modes, the setting for **Autofocus mode** () will take priority and be applied.

Infinity

If you set focus mode to infinity while using  (auto) mode or the **P, S, A, M, U1** and **U2** modes, the focus area will not be displayed on the screen.

Using Manual Focus

1 Press  (focus mode) to display the focus menu.

- Use the multi selector to choose **MF** (manual focus) and press the **OK** button.
- The center of the picture will be enlarged and displayed on the screen.

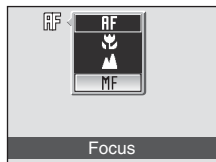

2 Press **▲** or **▼** on the multi selector to adjust the focus.

- Adjust the focus while viewing the image in the monitor.
- Press **▲** to focus on far subjects.
- Press **▼** to focus on near subjects.
- Press the shutter-release button halfway to check the composition. Continue pressing down fully to take the picture.

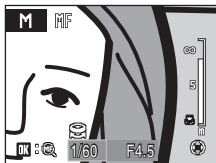

3 Press the **OK** button to check the field of view.

- The field of view and the enlarged center section of the picture will be displayed together.
- Press the shutter-release button at this point to take the picture.

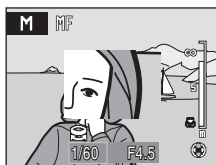

4 Press the **OK** button.

- **MF** is displayed at the top of the monitor, and the focus is locked. Pictures can be taken using the locked focus.
- To readjust the focus, repeat steps 1 to 3.
- To change back to autofocus, return to step 1 and choose any setting other than **MF**.

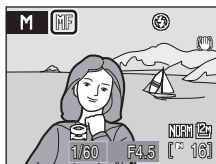

MF (Manual Focus)

- An approximate depth of field (the area of focus on the subject) can be previewed by pressing the shutter-release button halfway.
- Digital zoom is not available.

Exposure Compensation

Exposure compensation is used to alter the exposure from the value suggested by the camera to make pictures brighter or darker.

1 Press (exposure compensation).

- The exposure compensation guide is displayed.
- Exposure compensation is not available for **M** (manual) mode.





2 Press or on the multi selector to adjust the exposure.

- When the subject is too dark: adjust the exposure compensation to “+” side.
- When the subject is too bright: adjust the exposure compensation to “-” side.
- Exposure compensation can be set to values between -2.0 and +2.0 EV in increments of 1/3 EV.



3 Exit the exposure compensation setting by pressing the button.

- When an exposure compensation value other than **0.0** is applied, the value is displayed with the  icon in the monitor.
- To cancel the exposure compensation setting, change the value to 0.0 and press the  button.

4 Press the shutter-release button to take the picture.

- Pictures can also be taken with a specified exposure compensation value by pressing the shutter-release button after step 2 (face priority  123) will not be available).



Exposure Compensation Value

For **P**, **S** and **A** shooting modes, the setting for exposure compensation will be stored in the camera's memory even after the camera is turned off.

Using Exposure Compensation

- The camera tends to lower exposure when the frame is dominated by brightly lit objects (for example, sunlit expanses of water, sand, or snow) or when the background is much brighter than the main subject.
- Negative compensation may be called for when large areas of the frame contain very dark objects (for example, a swath of dark green leaves) or when the background is much darker than the main subject.

Shooting in Scene Mode

Camera settings are automatically optimized for the selected subject type. The following scene modes are available.

Portrait	Beach/snow	Close-up	Copy
Landscape	Sunset	Food	Backlight
Night portrait	Dusk/dawn	Museum	Panorama assist
Party/indoor	Night landscape	Fireworks show	Voice recording*

* See "Voice Recordings" (187).

Setting the Scene Mode

1 Rotate the mode dial to **SCENE**.

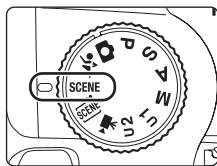

2 Press the **MENU** button to display the scene menu screen, choose the desired scene with the multi-selector and press the **OK** button.

- Choose the **SCENE** tab when the scene menu is not displayed (113).

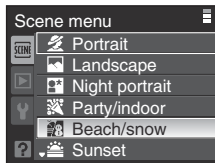
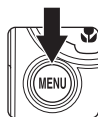

3 Frame the subject and take the picture.

- For scene modes that use the flash, be sure to press the (flash pop-up) button to raise the built-in flash before shooting.



Image Quality and Image Size

Image quality (107) and **Image size** (108) settings can be adjusted in the scene menu. Changes made to the image size setting apply to all shooting modes (except for sport continuous mode, **U 1** and **U 2** shooting modes, and movie mode).

Features

Portrait

NR

Use this mode for taking portraits in which the main subject stands out clearly. Portrait subjects exhibit smooth, natural-looking skin tones.

- The camera automatically detects and focuses on a face looking toward the camera (see “Shooting with Face Priority” (📖123) for more information).
- If the camera detects multiple faces, the camera focuses on the face closest to the camera.
- If no face is recognized, the camera will focus on the subject in the center of the frame.
- The **Did someone blink?** screen may be displayed when the **Blink warning** option (📖149) in the setup menu is set to **On** (default setting). Press the  button or the shutter-release button to return to the shooting screen. See “Operating the Did someone blink? Screen” (📖150) for more information.
- Digital zoom is not available.



* Other settings can be selected.

Landscape

NR

Use this mode for vivid landscapes and cityscapes.

- Camera focuses at infinity. When the shutter-release button is pressed halfway, the focus area or focus indicator (📖8) always lights green; however, focus may not be set for nearby subjects, while the camera focuses at infinity.
- AF-assist illuminator does not light regardless of the AF assist (📖145) setting.







*¹ Self-timer is available.

*² Other settings can be selected.

: Pictures shot in scene modes utilizing  are processed automatically to reduce noise and therefore take a longer time to record.

Icons Used for Descriptions

The following icons are used for descriptions in this section: , flash mode when the built-in flash is raised (📖32); , self-timer/smiley timer/blink proof (📖35, 54); , focus mode (📖36); , exposure compensation (📖39).

Shooting in Scene Mode

Night portrait



Use this mode to achieve a natural balance between the main subject and background lighting in portraits taken at night.

- The camera automatically detects and focuses on a face looking toward the camera (see “Shooting with Face Priority” (123) for more information).
- If the camera detects multiple faces, the camera focuses on the face closest to the camera.
- If no face is recognized, the camera will focus on the subject in the center of the frame.
- The **Did someone blink?** screen may be displayed when the **Blink warning** option (149) in the setup menu is set to **On** (default setting). Press the  button or the shutter-release button to return to the shooting screen. See “Operating the Did someone blink? Screen” (150) for more information.
- Shoot pictures with the built-in flash raised.
- Digital zoom is not available.
- Motion detection (144) is disabled.



	 *1		Off*2		AF		0.0*3
---	--	---	-------	---	----	---	-------

*1 Fill flash with slow sync and red-eye reduction.

*2 Self-timer and  (smile timer) are available.

*3 Other settings can be selected.

Party/indoor

Suitable for taking pictures in parties. Captures the effects of candlelight and other indoor background lighting.

- The camera focuses on the subject in the center of the frame.
- Hold the camera steadily as pictures are easily affected by camera shake. When shooting under low lighting, use of a tripod is recommended. Set **Vibration reduction** (143) to **Off** when using a tripod to stabilize the camera during shooting.





	 *1		Off*2		AF		0.0*3
---	--	---	-------	---	----	---	-------

*1 May automatically switch to slow sync with red-eye reduction. Other settings can be selected.

*2 Self-timer is available.

*3 Other settings can be selected.

: For scene modes with , use of a tripod is recommended. Turn **Vibration reduction** (143) off when using a tripod.

: Pictures shot in scene modes utilizing  are processed automatically to reduce noise and therefore take a longer time to record.

Beach/snow**NR**

Captures the brightness of such subjects as snowfields, beaches, or sunlit expanses of water.

- The camera focuses on the subject in the center of the frame.



*1 Other settings can be selected.

*2 Self-timer is available.

Sunset**NR**

Preserves the deep hues seen in sunsets and sunrises.

- The camera focuses on the subject in the center of the frame.



*1 Other settings can be selected.

*2 Self-timer is available.

Dusk/dawn**NR**

Preserves the colors seen in the weak natural light before sunrise or after sunset.

- Camera focuses at infinity. When the shutter-release button is pressed halfway, the focus area or focus indicator (8) always lights green; however, focus may not be set for nearby subjects, while the camera focuses at infinity.
- Motion detection (144) is disabled.
- AF-assist illuminator does not light regardless of the AF assist (145) setting.



*1 Self-timer is available.

*2 Other settings can be selected.

: For scene modes with , use of a tripod is recommended. Turn **Vibration reduction** (143) off when using a tripod.

NR: Pictures shot in scene modes utilizing **NR** are processed automatically to reduce noise and therefore take a longer time to record.

Shooting in Scene Mode

Night landscape



Use this mode to capture night landscapes. Slow shutter speeds are used to produce stunning night landscapes.

- Camera focuses at infinity. When the shutter-release button is pressed halfway, the focus area or focus indicator (📖8) always lights green; however, focus may not be set for nearby subjects, while the camera focuses at infinity.
- Motion detection (📖144) is disabled.
- AF-assist illuminator does not light regardless of the AF assist (📖145) setting.



Off*¹



0.0*²





*¹ Self-timer is available.

*² Other settings can be selected.

Close-up



Photograph flowers, insects and other small objects at close range.

- The focus mode (📖36) setting will be changed to  (macro close-up) and the camera automatically zooms to the position at the closest distance at which the camera can focus.
- When the zoom indicator is positioned where the  mark glows green, the camera can focus on subjects as close as 10 cm (4 in.) from the lens. At the  zoom position, the camera can focus on subjects as close as 1 cm (0.4 in.) from the lens.
- **AF area mode** is set to **Manual**. Press the  button to choose the focus area in which focus is acquired (📖122).
- The camera focuses continuously until focus is locked by pressing the shutter-release button halfway.
- As pictures are easily affected by camera shake, check the **Vibration reduction** (📖143) setting and hold the camera steadily.



📖AUTO*¹





Off*²





0.0*¹

*¹ Other settings can be selected. Note that the flash may be unable to light entire subject at distances of less than 50 cm (1 ft. 8 in.).

*² Self-timer is available.

: For scene modes with , use of a tripod is recommended. Turn **Vibration reduction** (📖143) off when using a tripod.

: Pictures shot in scene modes utilizing  are processed automatically to reduce noise and therefore take a longer time to record.

Food

Use this mode to take pictures of food. See “Taking Pictures in Food Mode” (📖48) for more information.

- **AF area mode** is set to **Manual**. Press the  button to choose the focus area in which focus is acquired (📖122).



*1 Self-timer is available.

*2 Other settings can be selected.

Museum

Use indoors where flash photography is prohibited (for example, in museums and art galleries) or in other settings in which you do not want to use the flash.

- The camera focuses on the subject in the center of the frame.
- BSS (Best Shot Selector) (📖118) is used when shooting.
- As pictures are easily affected by camera shake, check the **Vibration reduction** (📖143) setting and hold the camera steadily.
- Motion detection (📖144) is disabled.
- AF-assist illuminator does not light regardless of the AF assist (📖145) setting.



*1 Self-timer is available.

*2  (macro close-up) can be selected.

*3 Other settings can be selected.

Shooting in Scene Mode

Fireworks show



Slow shutter speeds are used to capture the expanding burst of light from a firework.

- Camera focuses at infinity. When the shutter-release button is pressed halfway, the focus area or focus indicator (📖8) always lights green; however, focus may not be set for nearby subjects, while the camera focuses at infinity.
- Digital zoom is not available.
- Motion detection (📖144) is disabled.
- AF-assist illuminator does not light regardless of the AF assist (📖145) setting.



Off



0.0

Copy



Provides clear pictures of text or drawings on a white board or in print.

- The camera focuses on the subject in the center of the frame.
- Use 🌺 (macro close-up) mode (📖36) in focus mode with this mode to shoot pictures at close distances.
- Colored text and drawings may not show up well.

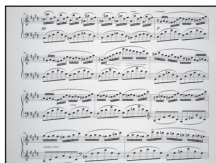

Off^{*2}



AF^{*3}



0.0^{*1}

*1 Other settings can be selected.

*2 Self-timer is available.

*3 🌺 (macro close-up) can be selected.

Backlight

Use when light is coming from behind your subject, throwing features or details in shadow. The flash fires automatically to “fill in” (illuminate) shadows.

- The camera focuses on the subject in the center of the frame.
- Shoot pictures with the built-in flash raised.
- Motion detection (📖144) is disabled.



Off^{*1}



AF



0.0^{*2}

*1 Self-timer is available.

*2 Other settings can be selected.

📖: For scene modes with 📖, use of a tripod is recommended. Turn **Vibration reduction** (📖143) off when using a tripod.

NR: Pictures shot in scene modes utilizing NR are processed automatically to reduce noise and therefore take a longer time to record.

Panorama assist



Use when taking a series of pictures that will later be joined to form a single panorama using the supplied Panorama Maker software. See “Taking Pictures for a Panorama” (📖50) for more information.



*1 Other settings can be selected.

*2 Self-timer is available.

*3 (macro close-up) or (infinity) can be selected.

: Pictures shot in scene modes utilizing are processed automatically to reduce noise and therefore take a longer time to record.

Taking Pictures in Food Mode

Use this mode to take pictures of food.

- 1 Use the multi selector to choose **Food** from the scene menu and press the **OK** button (☑40).

- The focus mode (☑36) setting will be changed to **Macro close-up** and the camera automatically zooms to the position at the closest distance at which the camera can focus.

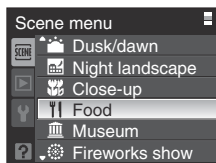

- 2 Press the multi selector **▲** or **▼** to choose white balance.

- Press **▲** to increase the amount of red, or **▼** to increase the amount of blue.

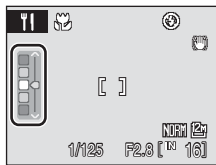

- 3 Frame the picture.

- When the zoom indicator is positioned where the **Macro** mark glows green, the camera can focus on subjects as close as 10 cm (4 in.) from the lens. At the **Wide** zoom position, the camera can focus on subjects as close as 1 cm (0.4 in.) from the lens.
- As pictures are easily affected by camera shake, check the **Vibration reduction** (☑143) setting and hold the camera steadily.
- **AF area mode** is set to **Manual** (☑122). Press the **OK** button to move the focus area. Press the multi selector **▲**, **▼**, **◀** or **▶** to move the focus area to the desired position. Press the **OK** button again to lock the selected focus area.
- Self-timer (☑35) and exposure compensation (☑39) settings can be adjusted while the focus area is locked.

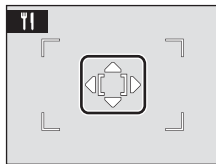
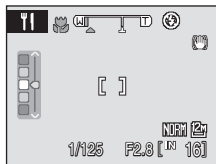



4 Press the shutter-release button to take the picture.

- Focus and exposure are locked when the shutter-release button is pressed halfway, and a picture is taken when the shutter-release button is pressed the rest of the way down.
- When the camera is unable to focus, the focus area blinks red. Change the composition and press the shutter-release button halfway again.



Note on Food Mode

Flash mode is disabled. Focus mode setting ( 36) is fixed at  (macro close-up).

White Balance Setting in Food Mode

- Increasing the amount of red or blue will decrease illumination effects.
- Changing white balance in food mode will not affect **White balance** in the shooting menu ( 114).
- The white balance setting applied in food mode is stored in the camera's memory even after the camera is turned off, and reapplied the next time food mode is selected.

Taking Pictures for a Panorama





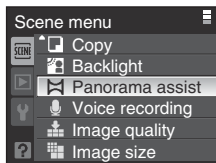

The camera focuses on the subject in the center of the frame. Use a tripod for best results. Set **Vibration reduction** (📖143) to **Off** when using a tripod to stabilize the camera during shooting.

- 1 Use the multi selector to choose **Panorama assist** from the scene menu and press the **OK** button (📖40).

- The  icon is displayed to show the direction in which pictures will be joined.



- 2 Use the multi selector to choose the direction and press the **OK** button.

- Decide how pictures will be joined together in the completed panorama; right () , left () , up () or down () .
- The yellow panorama direction icon () will move to the direction pressed, so press the **OK** button to choose the direction. A white panorama direction icon () will be displayed in the chosen direction.
- Apply flash mode (📖32), self-timer (📖35), focus mode (📖36) and exposure compensation (📖39) settings with this step, if necessary.
- Press the **OK** button again to reselect the direction.



- 3 Shoot the first picture.

- The picture taken will be displayed in 1/3 of the monitor.



- 4 Shoot the second picture.

- Match the outline of the next picture so that one-third of the frame overlaps on to the previous picture, and press the shutter-release button.
- Repeat until you have taken the necessary number of pictures to complete the image.



5 Press the **OK** button when shooting is completed.

- The camera returns to step 2.



✓ Panorama Assist

- Flash mode, self-timer, focus mode and exposure compensation settings cannot be adjusted after the first picture is taken. Apply the appropriate settings before you start to shoot. Changes to image quality (107) or image size settings (108), operation of the zoom, and deletion of images cannot be performed after you start to shoot.
- The panorama series is terminated if the camera enters standby mode with the auto off function (146) during shooting. Setting the time allowed to elapse before the auto off function is enabled to a longer time is recommended.

AE/AF-L (exposure lock) Indicator

AE/AF-L is displayed to indicate that white balance, exposure, and focus have been locked at the values set with the first shot. All pictures taken in a panorama series have the same focus, exposure, and white-balance settings.



📷 Panorama Maker

Install Panorama Maker from the supplied Software Suite CD. Transfer pictures to a computer (193) and use Panorama Maker (196) to join them in a single panorama.

📷 More Information

See "File and Folder Names" (156) for more information.

Shooting in the Scene Mode Selected by the Camera (Scene Auto Selector)

By simply framing a picture, the camera automatically selects the optimum scene mode for simpler shooting. When the camera is aimed at a subject in  scene auto selector mode, the camera automatically selects one of the following scene modes.

- Auto mode
- Landscape ()41
- Night landscape ()44
- Backlight ()46
- Portrait ()40
- Night portrait ()42
- Close-up ()44

1 Rotate the mode dial to .

- If the built-in flash is not raised, the message **The flash is lowered.** will be displayed.
- Press the  (flash pop-up) button to raise the built-in flash.



2 Frame the subject and take the picture.

- When the camera automatically selects a scene mode, the shooting mode icon changes to that for the scene mode currently enabled.

 : Auto mode

 : Portrait

 : Landscape



 : Night portrait

 : Night landscape

 : Close-up

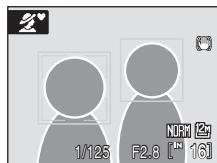
 : Backlight





- Press the shutter-release button halfway to set focus and exposure. When the subject is in focus, the focus area (active focus area) glows green.
- Press the shutter-release button the rest of the way down to take the picture.
- The **Did someone blink?** screen may be displayed when the **Blink warning** option ()149) in the setup menu is set to **On** (default setting). Press the  button or the shutter-release button to return to the shooting screen. See “Operating the Did someone blink? Screen” ()150) for more information.

✔ Note on Scene Auto Selector Mode



Depending upon shooting conditions, the camera may not select the desired scene mode. Should this occur, switch to auto mode (📖24) or choose the desired scene mode manually (📖40).

📎 Focusing in Scene Auto Selector Mode



- In scene auto selector mode, the camera detects and focuses on a face looking toward the camera (see “Shooting with Face Priority” (📖123) for more information).
- When the shooting mode icon  is displayed or when  (close-up) mode is in use, the camera will automatically focus on the area (one of nine) containing the subject closest to the camera. This is similar to the **Auto** setting of **AF area mode** (📖122).

📎 Flash Mode in Scene Auto Selector Mode

 (auto) (default setting) and  (off) flash mode settings (📖32) can be applied.

- When  (auto) is applied, the camera automatically chooses the optimum flash mode setting for the scene mode it has selected.
- When  (off) is applied, the flash does not fire, regardless of shooting conditions.

📎 Functions Restricted in Scene Auto Selector Mode

- Digital zoom is not available.
-  (smile timer) and  (blink proof) cannot be used.
- The  (focus mode) button (📖12, 36) on the multi selector cannot be used.

Using Smile Timer/Blink Proof

The camera detects a smiling face using face priority and releases the shutter automatically. This function can be used in the following shooting modes: **A** (auto) mode, **Portrait** and **Night portrait** (excluding blink proof) settings of Scene mode, and **P, S, A, M, U 1** and **U 2** modes.

1 Press (self-timer).

- The self-timer menu is displayed.
- Change any flash mode, exposure compensation, or shooting menu settings before pressing the  button.



2 Use the multi selector to choose (smile timer) or (blink proof) (55), and press the button.

- If a setting is not applied by pressing the  button within a few seconds, the selection will be cancelled.

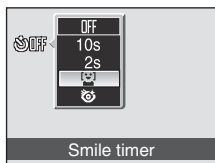

3 Frame the picture.

- Point the camera at the subject.
- When the camera detects a face looking toward the camera, the focus area containing the face will be displayed with a yellow double border. The camera focuses on the face framed by the double border. The double border will turn green for a moment and focus will be locked.
- Up to three faces can be detected. When more than one face is detected, the face closest to the center of the frame is framed by a double border and the others by single borders.
- Digital zoom is not available.

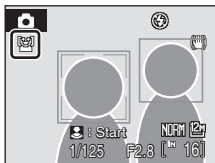

4 Press the shutter-release button fully.

- The camera begins searching for smiling faces five seconds after the shutter-release button is fully pressed down. The time until the search starts will be displayed in the monitor and the double border will turn green.
- Press the shutter-release button before the camera starts searching for smiling faces to stop the timer.
- If the camera detects that the face framed by the double border is smiling, the shutter is automatically released.
- After the timer starts counting down, the face that is recognized by the camera and framed by the double border will be detected as a smiling face.
- When the shutter is released, automatic shooting, in which the camera detects a smiling face and releases the shutter automatically, will be performed repeatedly.

5 Press the shutter-release button when the required pictures have been taken.

- Automatic shooting will end.
- Shooting will also end in the situations below.
 - When nine pictures have been taken
 - When more than five minutes has passed since pressing the shutter-release button in step 4 and no smiling faces have been detected

Notes on Blink Proof



Choose the  (blink proof) icon in step 2 of the previous page to use the blink proof function together with smile timer.

Once the camera starts searching for smiling faces in step 4, whenever smiling faces are detected, the camera takes two pictures and chooses an image in which the subjects' eyes are open.

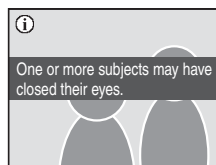
- The message on the right will be displayed for a few seconds when the camera detects someone blinking in the picture taken.
-  (blink proof) cannot be chosen in **Night portrait** mode.



Face Priority and Smiling Face Detection Features



When the camera is pointed at a face looking toward the camera in  smile timer/ blink proof, the face is automatically recognized and that smiling face will be detected.

- Under some shooting conditions, Face priority will not take effect and smiling faces cannot be detected.
- See "Shooting with Face Priority" (📖123) for more information about Face Priority.

Operation of the Self-Timer Lamp for Smile Timer/Blink Proof

- When the shutter-release button is pressed in step 4, the self-timer lamp will blink. The lamp stops blinking one second before the camera begins searching for smiling faces.
- When the camera has detected peoples' faces and is waiting for a smiling face, the self-timer lamp blinks.
- Immediately after the shutter is released with detection of a smiling face, the self-timer lamp flickers.

Functions Restricted in Smile Timer/Blink Proof Mode

- The focus mode setting will be changed to **AF** (autofocus). If the setting is changed to any setting other than **AF** (autofocus),  (smile timer) or  (blink proof) will be cancelled.
- Flash cannot be used for  (blink proof).
- For shooting modes **P**, **S**, **A**, **M**, **U 1** and **U 2** blink proof cannot be used if **B&W + color** has been enabled for the **Black-and-white** option of **Optimize image** (📖111).

More Information

See "Autofocus" (📖29) for more information.

Shooting in Sport Continuous Mode

Sport continuous mode allows rapid, continuous shooting while you press and hold the shutter-release button fully. With continuous shooting, instantaneous movements in moving subjects can be captured clearly.

- The ISO sensitivity is set automatically within the range of ISO 640 to 6400.
- Image sizes that can be selected are **3M 2048×1536** or smaller.
- The focus, exposure, and white balance settings are fixed at the values for the first picture in each series.

1 Rotate the mode dial to (sport continuous).

- The shooting mode changes to sport continuous mode.

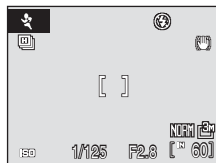

2 Press the MENU button and choose a continuous shooting type.

- See “Sport Continuous Menu” (158) for more information.
- Choose the  tab when the sport continuous menu is not displayed (113).
- Once the configuration is complete, press the MENU button to return to the shooting screen. Pressing the shutter-release button also returns to the shooting screen.

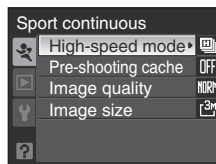

3 Frame the subject and shoot.

- The camera focuses on the subject in the center of the frame.
- Up to a maximum of 45 frames can be taken continuously while the shutter-release button is fully pressed down.



✓ Notes on Sport Continuous Shooting

- A longer period of time is taken to record the images after shooting ends. The time taken until recording ends may vary, depending upon the amount of images taken, image quality setting, image size setting and the write speed of the memory card used.
- The exposure will be set automatically. When **High-speed mode** (📖58) is set to **Continuous H** or **Continuous H (16:9)**, the shutter speed is set automatically within the range of 1/4000 to 1/20 s.
- Pictures taken in this mode may appear grainy as the ISO sensitivity is set to a high value.
- As the ISO level is fixed at 640 or higher, the camera may fail to obtain the proper exposure in fine weather (pictures may be over-exposed).
- Exposure and white balance values may be unstable when shooting pictures under high-speed flickering fluorescent lights or mercury lamps.
- Note that shooting will stop if you raise or lower the built-in flash while fully depressing the shutter-release button.
- The flash mode (📖32) is locked to Ⓜ (off).
- The focus mode (📖36) settings can be changed. If the setting is changed to **AF** (autofocus) (default setting) or **MF** (macro close-up) in sport continuous mode, the focus mode setting will be changed to Full-time AF (📖125).
- Exposure compensation (📖39) settings can be changed.
- Self-timer cannot be used.
- AF assist illuminator does not light, even if AF assist (📖145) is set.

✓ Notes on Continuous H (16:9) and Continuous H

If very bright objects such as the sun or lights are captured in Continuous H (16:9) or Continuous H mode, vertical streaks of light (known as "smear") may appear in the recorded image. Parts or the entire image around the border of the smear may turn dark or green in color. To prevent this from happening we recommend that you avoid capturing those bright objects directly when shooting.

🔍 More Information

See "Autofocus" (📖29) for more information.





Sport Continuous Menu

The sport continuous menu has setting options for the following items. Press the **MENU** button when in sport continuous mode to display the sport continuous menu, and then use the multi selector to change the settings.

- Choose the  tab when the sport continuous menu is not displayed (📖13).

High-speed mode

Choose the continuous shooting type.

Option	Maximum continuous shooting speed	Description
 Continuous H (16:9)	Approx. 15 frames per second	The camera shoots continuously at a higher speed than Continuous H , with images recorded at an image size of 16:9 (1920x1080).
 Continuous H (default setting)	Approx. 11 frames per second	Continuous shooting will be performed at high speeds.
 Continuous M	Approx. 6 frames per second	
 Continuous L	Approx. 4 frames per second	

Pre-shooting cache







Pre-shooting cache can be set when **High-speed mode** is set to **Continuous H (16:9)** or **Continuous H**. When pre-shooting cache is set to **On**, the camera will start shooting once the shutter-release button is pressed down half-way and can save up to ten frames just before the shutter-release button is fully pressed down. Up to a maximum of 35 images can be recorded during the period when the shutter-release button is pressed down fully. This improves the probability of capturing a critical moment (📖59).

Image quality

Image quality (📖107) settings can be changed.

Image size

Image size (📖108) settings can be changed.

- The following image sizes are available in sport continuous mode:  **2048x1536** (default setting),  **1600x1200**,  **1280x960**,  **1024x768** and  **640x480**.
- Image size will be changed to  **1920x1080**, and other sizes cannot be selected when **Continuous H (16:9)** is chosen.
- The image quality and image size settings in the sport continuous menu are stored independently and are not applied to other shooting modes.

Pre-shooting Cache

When pre-shooting cache is set to **On**, shooting will start when the shutter-release button is pressed down halfway for more than 0.5 seconds, and images (up to ten) that were recorded just before the shutter-release button is pressed down fully will be saved. Up to a maximum of 35 images can be recorded during the period when the shutter-release button is pressed down fully.

The current setting is displayed during shooting (when **Off** is selected, an icon for the current setting is not displayed) (p.8). When the shutter-release button is pressed down halfway, the pre-shooting cache icon will glow in green.

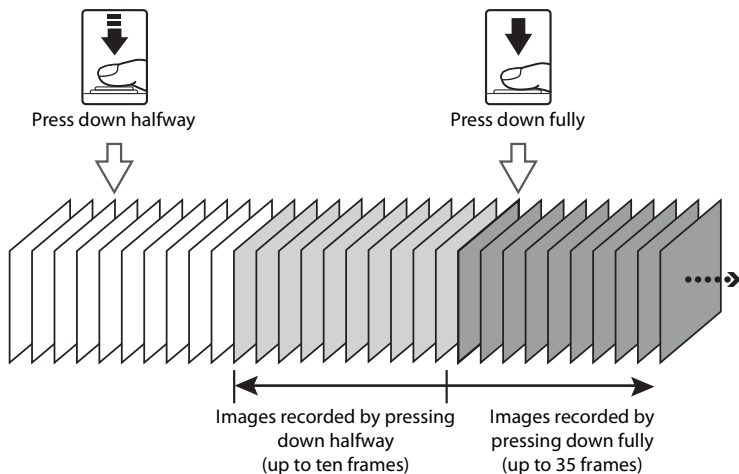

- Check the remaining memory capacity before shooting. Having 45 or more frames in the memory before shooting is recommended.

Number of frames recordable	Number of frames recordable using pre-shooting cache
45 frames and over	Maximum of 10 frames
44 frames and below	Maximum of 5 frames
6 frames and below	Pre-shooting cache is not usable

P, S, A, M modes

By rotating the mode dial, you can shoot pictures in the following four exposure modes: **P** (programmed auto), **S** (shutter-priority auto), **A** (aperture-priority auto), and **M** (manual). In addition to allowing you to set the shutter speed and aperture yourself, these modes offer control over a variety of advanced settings such as changing the ISO sensitivity and white balance in the shooting menu (📖105).

Mode	Description	Usage
P Programmed auto (📖62)	Camera sets the shutter speed and aperture automatically for optimal exposure. Flexible program, which changes the combination of shutter speed and aperture, can be used (📖62).	Recommended for most situations.
S Shutter-priority auto (📖63)	User chooses shutter speed; camera selects aperture for best results.	Use to shoot fast moving subjects using a fast shutter speed, or use to emphasize the movements of a moving subject using a slow shutter speed.
A Aperture-priority auto (📖64)	User chooses aperture; camera selects shutter speed for best results.	Use to blur background or bring both foreground and background into focus.
M Manual (📖65)	User controls both shutter speed and aperture.	Use to control exposure according to shooting requirements.

Settings that are frequently used for **P, S, A** and **M** shooting modes can be saved in mode dial **U1** or **U2**. Rotating the mode dial to **U1** or **U2** enables you to shoot pictures using the saved settings that are used frequently (📖68).

Shutter Speed and Aperture

The same exposure can be achieved with different combinations of shutter speed and aperture, allowing you to freeze or blur motion and control depth of field. The following figure shows how shutter speed and aperture affect exposure. When the ISO sensitivity setting (see page 116) is changed, the range of shutter speeds and aperture values at which the correct exposure can be obtained also changes.

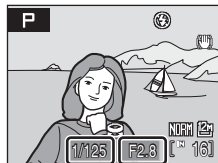

Shutter speed Aperture



Fast shutter speed:
1/1000 s



Slow shutter speed:
1/30 s



Large aperture
(small f-number):
f/2.8



Small aperture
(large f-number):
f/8.0

P (Programmed Auto) Mode

Shoot pictures with shutter speed and aperture value set automatically by the camera.

1 Rotate the mode dial to **P**.

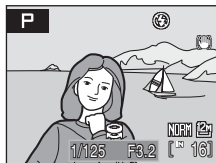

2 Frame the subject and shoot.

- At the default setting, the camera automatically selects the focus area (one of nine) containing the subject closest to the camera (📖122).



Flexible Program

In mode **P**, different combinations of shutter speed and aperture can be selected by rotating the command dial ("flexible program"). While flexible program is in effect, an asterisk (*****) appears next to the mode indicator (**P**) in the monitor.

- Rotate the command dial to the right for large apertures (small f-numbers) that blur background details or fast shutter speeds that "freeze" motion.
- Rotate the command dial to the left for small apertures (large f-numbers) that increase depth of field or slow shutter speeds that blur motion.
- To restore default shutter speed and aperture settings, rotate the command dial until the ***** asterisk next to the mode indicator is no longer displayed. Selecting another mode, or turning off the camera, also restores default shutter speed and aperture settings.

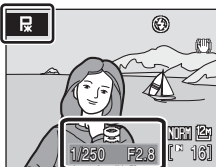
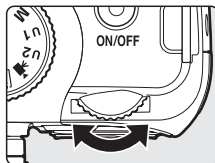

✔ Note on Shutter Speed

When **Multi-shot 16** is selected for **Continuous** (📖118) the fastest shutter speed is changed to 1/2500 second, and the slowest shutter speed is restricted to 1/30 second.

S (Shutter-Priority Auto) Mode

Set the shutter speed and shoot pictures.

- 1 Rotate the mode dial to **S**.

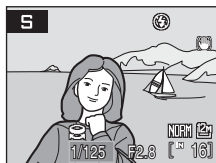

- 2 Rotate the command dial to choose the shutter speed value between 1/2000 second and 8 seconds.

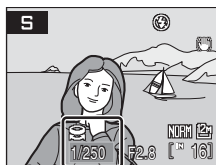

- 3 Focus and shoot.

- At the default setting, the camera automatically selects the focus area (one of nine) containing the subject closest to the camera (📖122).



✓ S (Shutter-Priority Auto) Mode

- If the selected shutter speed would result in the picture being over- or underexposed, the shutter speed display will flash when the shutter-release button is pressed halfway. Choose another shutter speed and try again.
- At speeds slower than 1/4 second, the shutter speed indicator will turn red to show that noise reduction (📖126) is recommended to reduce “noise” in the form of randomly-spaced, brightly colored dots. Setting **Noise reduction** to **On** (📖126) is recommended.

✓ Note on Shutter Speed

When **Multi-shot 16** is selected for **Continuous** (📖118) the fastest shutter speed is changed to 1/2500 second, and the slowest shutter speed is restricted to 1/30 second.

A (Aperture-Priority Auto) Mode

Set the aperture value and shoot pictures.

1 Rotate the mode dial to **A**.

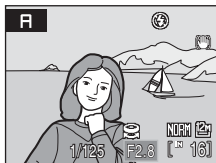

2 Rotate the command dial to choose the aperture value (f/-number).

- When the camera is zoomed all the way out, aperture can be set to values between f/2.8 and f/8.0; at maximum zoom, aperture can be set to values between f/5.0 and f/8.0.

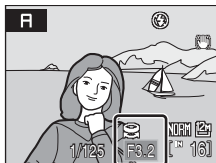

3 Focus and shoot.

- At the default setting, the camera automatically selects the focus area (one of nine) containing the subject closest to the camera (📖 122).



✓ **A (Aperture-Priority Auto) Mode**

If the selected aperture would result in the picture being over- or underexposed, the aperture display will flash when the shutter-release button is pressed halfway. Choose another aperture value and try again.

✓ **Note on Shutter Speed**

When **Multi-shot 16** is selected for **Continuous** (📖 118) the fastest shutter speed is changed to 1/2500 second, and the slowest shutter speed is restricted to 1/30 second.

🔍 **Aperture and Zoom**

Aperture is expressed as an f-number, which is the ratio of the focal length of the lens to the effective diameter of the opening (aperture) through which light enters the camera. Large apertures (expressed by small f-numbers) let more light into the camera, and small apertures (large f-numbers) let less light. This camera has a lens with a focal length of 4.6-110.4 mm and an aperture of f/2.8 to f/5. When the camera is zoomed out, the f-number decreases. When the camera is zoomed in, the f-number increases.



M (Manual) Mode

Set the shutter speed and aperture value, and shoot pictures.

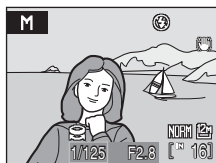
1 Rotate the mode dial to **M**.



2 Press the multi selector to activate the shutter speed setting.

- The active setting switches between shutter speed and aperture each time the multi selector  is pressed.
- At speeds slower than 1/4 second, the shutter speed indicator turns red ( 63).

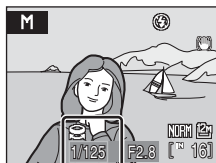

3 Rotate the command dial to choose the shutter speed value between 1/2000 second and 8 seconds.

- When adjusting aperture or shutter speed, the degree of deviation from the exposure value measured by the camera is displayed for a few seconds in the exposure display.
- The degree of deviation in the exposure display is shown in EVs (-2 to +2 EV in increments of 1/3 EV).
A display similar to that illustrated at right indicates that the picture will be overexposed by 1 EV (+1).

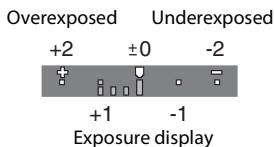
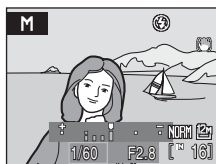

4 Press the multi selector to activate the aperture setting.

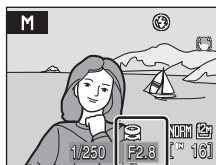

M (Manual) Mode

5 Rotate the command dial to choose an aperture value.

- Repeat steps 2 to 5 to modify shutter speed and aperture settings until the desired exposure is achieved.

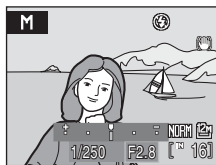

6 Focus and shoot.

- At the default setting, the camera automatically selects the focus area (one of nine) containing the subject closest to the camera (see page 122).



✔ Note on Shutter Speed

When **Multi-shot 16** is selected for **Continuous** (see page 118) the fastest shutter speed is changed to 1/2500 second, and the slowest shutter speed is restricted to 1/30 second.

✔ Note on ISO Sensitivity

When **ISO sensitivity** (see page 116) is set to **Auto** (default setting), **High ISO sensitivity auto**, or **Fixed range auto**, ISO sensitivity will be fixed at ISO 64.

Using U 1, U 2 (User Setting Mode)

Settings that are frequently used for **P**, **S**, **A** and **M** shooting modes can be saved in mode dial **U 1** or **U 2**.

Rotating the mode dial to **U 1** or **U 2** enables you to shoot using the saved settings. The following settings can be saved in **U 1** and **U 2**.

Basic Settings

Shooting modes P/S/A/M (60) ¹	Monitor display (14, 15)	Zoom position (27)
(Flash mode) (32)	(Focus mode) (36) ²	(exposure compensation) (39)

Shooting menu

Image quality (107)	Image size (108)	Optimize image (111)
White balance (114) ³	ISO sensitivity (116)	Metering (117)
Continuous (118)	Auto bracketing (121)	AF area mode (122) ⁴
Autofocus mode (125)	Flash exp. comp. (125)	Noise reduction (126)
Distortion control (126)	Active D-Lighting (70)	

1 The current flexible program (when set to **P**), shutter speed (when set to **S** and **M**) or aperture (when set to **A** and **M**) settings will be saved.

2 The current focus distance will be saved when set to **MF** (manual focus).

3 The preset value for preset manual applies to the **P**, **S**, **A**, **M**, **U 1** and **U 2** shooting modes.

4 The current focus area position is saved when AF area mode is set to **Manual**.

Backup battery

If the internal backup battery (139) is exhausted, the settings saved in U1 and U2 will be reset. Writing down any important setting is recommended.

Save the Settings in **U1** or **U2**

1 Rotate the mode dial to the desired exposure mode.

- Rotate to **P, S, A** or **M**.
- Settings can be saved even if rotated to **U1** or **U2** (the default settings of shooting mode **P** are saved when the camera is first purchased).

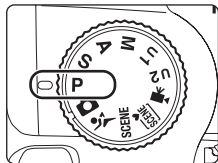

2 Change to a frequently used setting.

3 Press the **MENU** button.

- The shooting menu is displayed.
- Choose the **P, S, A, M, U1** or **U2** tab when the shooting menu is not displayed (13).

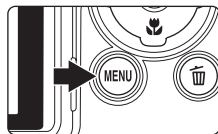

4 Use the multi selector to choose **Save user settings** and press the **OK** button.

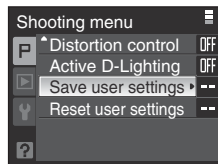

5 Choose the destination to which to save, and press the **OK** button.

- The current settings will be saved.
- The settings in the destination will be overwritten.

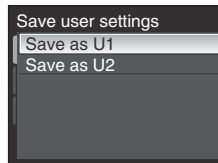

Resetting Saved Settings

The saved setting will revert back to the default setting of shooting mode **P**.

- 1 Choose **Reset user settings** in the shooting menu screen and press the **OK** button.

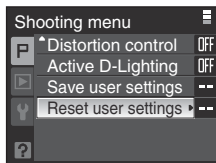

- 2 Choose the destination to reset and press the **OK** button.

- The saved settings have been reset.

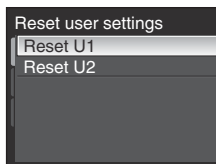

Active D-Lighting

“Active D-Lighting” preserves details in highlights and shadows, creating photographs with natural contrast. The image taken will reproduce the contrast effect that is seen with the naked eye. This is particularly effective for shooting brightly lit outdoor scenery from darker indoors or taking pictures of shaded subjects at a sunny seaside. This feature can be selected in shooting modes **P**, **S**, **A**, **M**, **U1**, and **U2**

1 Rotate the mode dial to **P**, **S**, **A** or **M**.

- Can be set even if **U1** or **U2** is selected.



2 Press the **MENU** button to display the shooting menu, choose **Active D-Lighting** with the multi selector and press the **OK** button.

- Choose the **P**, **S**, **A**, **M**, **U1** or **U2** tab when the shooting menu is not displayed (📖13).

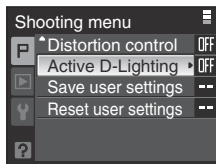
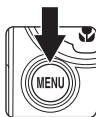

3 Choose the amount of enhancement and press the **OK** button.

- At settings other than **Off**, the icon for the current setting is displayed in the monitor (📖8).

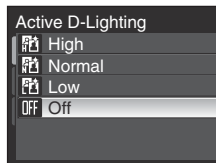

✓ Active D-Lighting

- Additional time is required to record images when shooting using Active D-Lighting.
- When Active D-Lighting is selected, exposure will be reduced in comparison to shooting without selecting Active D-Lighting. Adjustments will be made to highlighted areas, underexposed areas and mid-tones so that brightness of gradations will become appropriate.
- The setting for **Metering** (📖117) will change to **Matrix** when shooting with Active D-Lighting.
- The **Contrast** setting for the optimize image options **Custom** (📖112) and **Black-and-white** (📖113) → **Custom** will be changed to **Auto**.
- If the **ISO sensitivity** (📖116) is set to **High ISO sensitivity auto** or to **1600** and above, the setting for Active D-Lighting will change to **Off**.

✓ Active D-Lighting Versus D-Lighting

The **Active D-Lighting** option in the shooting menu adjusts exposure before shooting to optimize the dynamic range. The **D-Lighting** (📖76) option in the playback menu optimizes dynamic range in images after shooting.

Viewing Multiple Pictures: Thumbnail Playback

Rotate the zoom control to **W** (📏) in full-frame playback mode (📖30) to display pictures as thumbnail images in thumbnail playback mode.





The following operations can be performed in thumbnail playback.

To	Use	Description	📖
Choose pictures		Press ▲, ▼, ◀ or ▶ on the multi selector.	12
		Rotate the command dial.	-
Increase the number of thumbnails displayed/Calendar display	W (📏)	Rotate the zoom control towards the W (📏) direction to increase the number of thumbnails from 4 → 9 → 16 → Calendar display. In calendar display, the images can be selected according to date by moving the cursor (📖72). Rotate towards the T (📏) direction to return to thumbnail display.	-
Decrease number of picture thumbnails displayed	T (📏)	Rotate the zoom control towards the T (📏) direction to decrease the number of thumbnails from 16 → 9 → 4. Rotate towards T (📏) again during 4 thumbnails display to return to full-frame playback.	-
Return to full-frame playback	OK	Press the OK button.	30
Switch to shooting mode		Press the button or the shutter-release button to change back to the last chosen shooting mode.	30

Viewing Multiple Pictures: Thumbnail Playback

Icons on the Thumbnails

When print set (103) and protected pictures (132) are selected in thumbnail playback mode, the icons shown at the right are displayed with them.



Movies are displayed as film frames.

Print-set icon

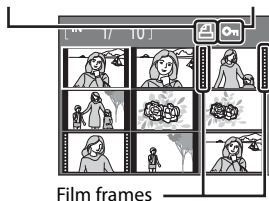
Protect icon







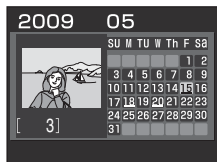

Calendar display

Rotate the zoom control towards **W** () during playback mode when 16 thumbnails are displayed (71) to change to calendar display.

Move the cursor and choose the image according to the date. Dates will be underlined in yellow if there are pictures taken on that date.



The following operations can be performed while the calendar is displayed.

To	Use	Description	
Select date		Press ▲ , ▼ , ◀ or ▶ on the multi selector.	12
		Rotate the command dial.	-
Return to full-frame playback		Change to full-frame playback display of the first photo taken on the chosen date.	30
Return to thumbnail display	T ()	Rotate the zoom control to T ()	-

Notes on Calendar display





- Images taken without the date set will be treated as images taken on "01.01.09".
- **MENU** and  buttons are disabled while the Calendar is displayed.

Taking a Closer Look: Playback Zoom

Rotating the zoom control to **T** (Q) during full-frame playback mode (📖30) zooms in on the current picture, enlarging and displaying the center of the picture on the monitor.

- The guide at lower right shows which portion is enlarged. The following operations can be performed while pictures are zoomed in.



To	Use	Description	📖
Zoom in	T (Q)	Zoom increases each time the zoom control is rotated to T (Q), up to about 10x. Zoom also increases by rotating the command dial to the right.	-
Zoom out	W (📐)	Rotate the zoom control to W (📐). When the magnification ratio reaches 1x, the display returns to full-frame playback mode. Zoom also decreases by rotating the command dial to the left.	-
Move the display area		Press the multi selector ▲ , ▼ , ◀ or ▶ to move the display area to other areas of the picture.	12
Return to full-frame playback	OK	Press the OK button.	30
Crop picture	MENU	Press to crop the current picture to contain only the portion visible in the monitor.	77
Switch to shooting mode		Press the  button or the shutter-release button to change back to the last chosen shooting mode.	30
			

Pictures Taken Using the Face-Priority Function

When zooming in (playback zoom) on a picture taken using the face-priority function (📖123), the picture will be enlarged with the face detected during shooting at the center of the monitor.

- If more than one face was detected, the picture will be enlarged with the face on which focus was acquired at the center of the monitor. Press the multi selector **▲**, **▼**, **◀** or **▶** to display other faces that were detected.
- When the zoom control is further rotated towards the **T** (Q) or **W** (📐) direction, the zoom ratio will change and will become a normal playback zoom display.

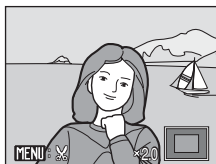



Editing Pictures

Use this camera to edit pictures in-camera and store them as separate files (📖156).

Editing function	Description
Quick retouch(📖75)	Easily create a copy with enhanced contrast and richer colors.
D-Lighting(📖76)	Create a copy of the current picture with enhanced brightness and contrast, brightening dark portions of the picture.
Crop (📖77)	Crop picture. Enlarge the image or refine the composition and create a copy containing only the portion visible in the monitor.
Small picture(📖78)	Create a small copy of pictures suitable for use on web pages or as e-mail attachments.
Black border(📖79)	Create a copy with a black frame along border of the picture that provides a little more impact.

Notes on Picture Editing

- Editing other than Black border cannot be performed on pictures shot with **Image size** (📖108) of  **3984×2656**,  **3968×2232**, and  **2992×2992** and pictures shot on **Continuous H (16:9)** setting (📖58).
- This camera's editing functions cannot be used for pictures taken with another make or model of camera.
- If a copy created using this camera is viewed on another make or model of camera, the picture may not be displayed or may not be transferred to a computer.
- Editing functions are not available when there is not enough free space in the internal memory or on the memory card.

Restrictions on Picture Editing

1st editing	2nd editing				
	Quick retouch	D-Lighting	Crop	Small picture	Black border
Quick retouch	–	–	✓	✓	–
D-Lighting	–	–	✓	✓	–
Crop	–	–	–	–	–
Small picture	–	–	–	–	–
Black border	–	–	–	–	–

- Pictures cannot be edited twice with the same editing function.
- Quick retouch or D-Lighting should be done first while the restricted use of combination exists.
- A black border cannot be applied to copies created using editing functions.

Original Pictures and Edited Copies

- Copies created with editing functions are not deleted if the original pictures are deleted. The original pictures are not deleted if copies created with editing functions are deleted.
- Edited copies are stored with the same recording date and time as the original.
- Even if the pictures that are marked for **Print set** (📖103) or **Protect** (📖132) are used for editing, these settings will not be reflected on the edited copies.

Using Quick Retouch

Easily create retouched images in which contrast and saturation have been enhanced. Retouched copies are stored as separate files.

- 1 Choose the desired picture from full-frame (📖30) or thumbnail (📖71) playback mode and press the **MENU** button.

- The playback menu is displayed.
- Choose the ▶ tab when the playback menu is not displayed (📖13).

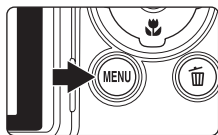

- 2 Use the multi selector to choose **Quick retouch** and press the **OK** button.

- The original version will be shown on the left and the edited version will be shown on the right.
- If the playback menu is displayed from a mode other than playback mode, choose **Quick retouch** to display the picture selection screen (📖130). Choose an image to edit and press the **OK** button.

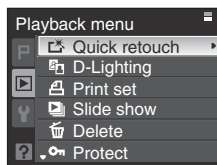

- 3 Choose the amount of enhancement using ▲ or ▼ of the multi selector, and press the **OK** button.

- A new, edited copy is created.
- To cancel quick retouch, press the **MENU** button.
- Quick retouched copies can be recognized by the 📷 icon displayed during playback.

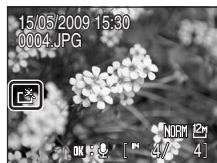
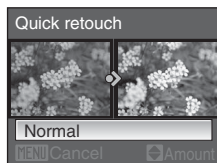

More Information

See "File and Folder Names" (📖156) for more information.

Enhancing Brightness and Contrast: D-Lighting

D-Lighting can be used to create copies with enhanced brightness and contrast, brightening dark portions of a picture. Enhanced copies are stored as separate files.

- 1 Choose the desired picture from full-frame (📄30) or thumbnail (📄71) playback mode and press the **MENU** button.

- The playback menu is displayed.
- Choose the ▶ tab when the playback menu is not displayed (📄13).

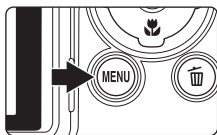

- 2 Use the multi selector to choose **D-Lighting** and press the **OK** button.

- The original version will be shown on the left and the edited version will be shown on the right.
- If the playback menu is displayed from a mode other than playback mode, choose **D-Lighting** to display the picture selection screen (📄130). Choose an image to edit and press the **OK** button.

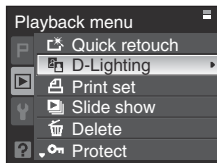

- 3 Choose the amount of enhancement using ▲ or ▼ of the multi selector, and press the **OK** button.

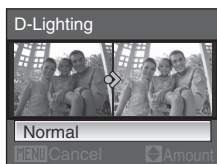

- A new, edited copy is created.
- To cancel D-Lighting, press the **MENU** button.
- D-Lighting copies can be recognized by the 📄 icon displayed during playback.



More Information

See "File and Folder Names" (📄156) for more information.

Creating a Cropped Copy: Crop





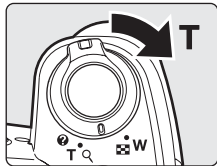

Create a copy containing only the portion visible in the monitor when **MENU**  is displayed with playback zoom (73) enabled. Cropped copies are stored as separate files.

1 Enlarge the desired picture during full-frame display (30) by rotating the zoom control to the **T** () direction.

- To crop a picture displayed in “tall” (portrait) orientation, zoom in on the picture until the black bars displayed on the both sides of the monitor disappear. The cropped picture will be displayed in landscape orientation. To crop the picture in its current “tall” (portrait) orientation, first, use the **Rotate image** option (133) to rotate the picture so that it is displayed in landscape orientation. Next, enlarge the picture for cropping, crop the picture, and then rotate the cropped picture back to “tall” (portrait) orientation.



2 Refine copy composition.

- Rotate the zoom control to **T** () or **W** () to adjust the zoom ratio.
- Press the multi selector , ,  or  to scroll the picture until only the portion you want to copy is visible in the monitor.

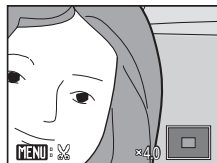

3 Press the **MENU** button.

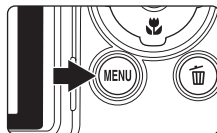



4 Use the multi selector to choose **Yes** and press the **OK** button.

- A new picture, containing only the portion visible in the monitor, is created.
- To cancel creating a cropped copy, choose **No**.



Image Size



As the area to be saved is reduced, the image size (pixels) of the cropped copy is also reduced. When the size of the cropped copy is 320 × 240 or 160 × 120, the small picture icon  or  is displayed on the left of the screen in full-frame playback mode.



More Information



See “File and Folder Names” (156) for more information.

Resizing Pictures: Small Picture

Create a small copy of the current picture. Small copies are stored as JPEG files with a compression ratio of 1:16. The following sizes are available.

Option	Description
 640×480	Suitable for television playback.
 320×240	Suitable for displaying on web pages.
 160×120	Suitable for e-mail attachments.

- 1 Choose the desired picture from full-frame () or thumbnail () playback mode and press the **MENU** button.

- The playback menu is displayed.
- Choose the  tab when the playback menu is not displayed ()13).

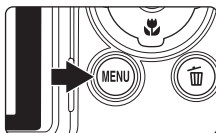

- 2 Use the multi selector to choose  **Small picture** and press the **OK** button.

- If the playback menu is displayed from a mode other than playback mode, choose **Small picture** to display the picture selection screen ()130). Choose an image to edit and press the **OK** button.

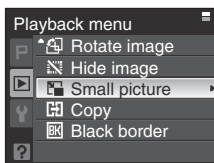

- 3 Choose the desired copy size and press the **OK** button.

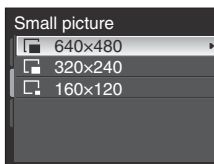

- 4 Choose **Yes** and press the **OK** button.

- A new, smaller copy is created.
- To cancel creating a small copy, choose **No**.
- The copy is displayed with a gray frame.

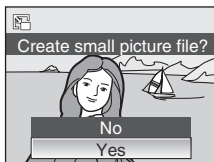

More Information

See "File and Folder Names" ()156) for more information.



Adding Black Frame on Pictures: Black Border

This function creates copies with **Thin**, **Medium**, or **Broad** black lines, along borders of pictures. Copies with a black frame are stored as separate files.

- 1 Choose the desired picture from full-frame (📖30) or thumbnail (📖71) playback mode and press the **MENU** button.

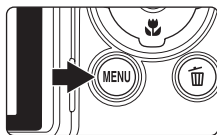
- The playback menu is displayed.
- Choose the  tab when the playback menu is not displayed (📖13).



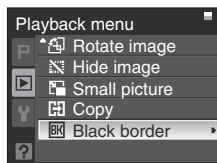

- 2 Use the multi selector to choose  **Black border** and press the  button.

- If the playback menu is displayed from a mode other than playback mode, choose **Black border** to display the picture selection screen (📖130). Choose an image to edit and press the  button.

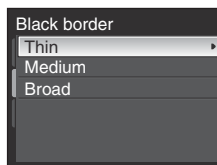

- 3 Choose the desired thickness of frame and press the  button.



- 4 Choose **Yes** and press the  button.

- A new copy with a black frame is created.
- To cancel creating a copy with black border, choose **No**.

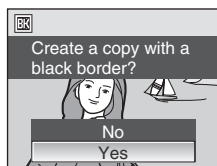



Black Border

- Borders of a picture will be hidden with black lines because black portion is drawn from picture's edges according to their thickness.
- When a picture with a black border is printed using a printer's borderless print function, black frame may not be printed.

More Information

See "File and Folder Names" (📖156) for more information.

Voice Memos: Recording and Playback

Use the camera's built-in microphone to record voice memos for pictures marked with   in full-frame playback mode ( 30).



Recording Voice Memos

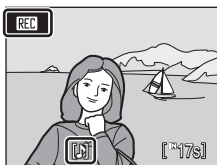
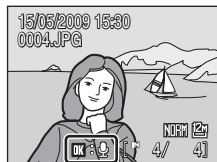

A voice memo, up to 20 seconds in length, will be recorded while the  button is pressed down.

- Do not touch the built-in microphone during recording.
- During recording, **REC** and  blink in the monitor.





Playing Voice Memos

Press the  button while a picture is displayed in full-frame playback mode to play the voice memo. Playback ends when the voice memo ends or when the  button is pressed again.

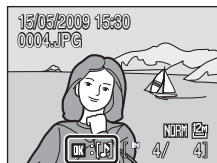
- Pictures with voice memos can be recognized by the   icon.
- Use the zoom control **T** () or **W** () during playback to adjust the volume.



Deleting Voice Memos

Choose a picture with a voice memo and press the  button. Use the multi selector to choose  and press the  button. Only the voice memo will be deleted.

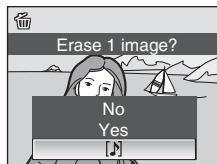

Notes on Voice Memos

- When a picture with a voice memo attached is deleted, both the picture and its voice memo are deleted.
- Voice memos cannot be recorded for a picture that already has a voice memo attached on it. The current voice memo must be deleted before a new voice memo can be recorded.
- Voice memos cannot be attached to images shot using other cameras.

More Information

See "File and Folder Names" ( 156) for more information.

Recording Movies

To shoot movies with sound recorded via the built-in microphone, select shooting mode and follow the steps below.

1 Rotate the mode dial to **Movie**.

- Exposure count display shows the maximum total length of a movie that can be recorded.

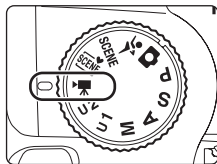

2 Press the shutter-release button all the way down to start recording.

- Camera focuses on the subject in center of the frame.
- A progress bar at the bottom of the monitor shows the amount of recording time remaining.
- To end recording, press the shutter-release button all the way down again.
- Recording stops automatically when the internal memory or memory card becomes full, or recording time reaches 25 minutes.

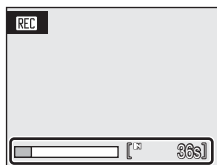

✓ Shooting Movies

- Exposure compensation (☐39) is available. **AF** (autofocus), **MF** (macro close-up), and **∞** (infinity) are available for the focus mode (☐36). Flash (☐32) can only be used for time-lapse movies. Self-timer and smile timer/blink proof are disabled.
- Flash mode, focus mode and exposure compensation settings cannot be applied or changed while movies are being recorded. Apply or change settings as necessary before movie recording begins.
- Optical zoom cannot be adjusted once movie recording begins. Digital zoom cannot be applied before movie recording begins. However, digital zoom (up to 2x) can be applied while movies, other than time-lapse movies, are being recorded.
- With the exception of time-lapse movies, the angle of view (field of view) when shooting movies is smaller than when shooting still pictures.

✓ Note on Recording Movies

When the movie has been fully recorded to the internal memory or memory card, the monitor display will revert to the normal shooting mode display. **Do not open the battery-chamber/memory card slot cover while pictures are being recorded.** Turning the camera off or removing the memory card while movies are being recorded could result in loss of data or in damage to the camera or card.



🔍 Changing Movie Settings

- Movie options**, **Autofocus mode** and **Electronic VR** (☐82) settings can be changed in the movie menu.
- When **Movie options** is set to **Time-lapse movie** ★, movies are recorded without sound.



The Movie Menu

Movie options, **Autofocus mode** and **Electronic VR** settings can be changed in the movie menu.







Press the **MENU** button in movie mode to display the movie menu and use the multi selector to modify and apply settings.

- Choose the  tab when the movie menu is not displayed (13).







Selecting Movie Options

Set to  (Movie) → **MENU** →  (Movie menu) → Movie options

The movie menu offers the options shown below.

Option	Image size and frame rate
 TV movie 640 ★ (default setting)	Image size: 640 × 480 pixels Frame rate: 30 frames per second
 TV movie 640	Image size: 640 × 480 pixels Frame rate: 15 frames per second
 Small size 320	Image size: 320 × 240 pixels Frame rate: 15 frames per second
 Time-lapse movie ★ ( 84)	The camera automatically shoots pictures at intervals and joins them into a movie. Record flowers opening or butterflies emerging from cocoons. No sound will be recorded. Image size: 640 × 480 pixels Frame rate: 30 frames per second
 Sepia movie 320	Record movies in sepia tones. Image size: 320 × 240 pixels Frame rate: 15 frames per second
 B&W movie 320	Record movies in black and white. Image size: 320 × 240 pixels Frame rate: 15 frames per second

Maximum Movie Length



Option	Internal memory (approx. 47MB)	Memory card (512 MB)
 TV movie 640★ (default setting)	43 s	Approx. 7 min 10 s
 TV movie 640	1 min 26 s	Approx. 14 min 10 s
 Small size 320	2 min 50 s	25 min
 Time-lapse movie★ ( 84)	513 frames	1800 frames per movie
 Sepia movie 320	2 min 50 s	25 min
 B&W movie 320	2 min 50 s	25 min

* All figures are approximate. The maximum recording time may vary with make of memory card. This camera can record movies up to a maximum of 25 minutes in length. The remaining length of the movie that is displayed on the screen during recording will be a maximum of 25 minutes, regardless of the remaining memory on the memory card.



More Information

See "File and Folder Names" ( 156) for more information.



Autofocus Mode

Set to  (Movie) → MENU →  (Movie menu) → Autofocus mode



Choose how the camera focuses in movie mode.

Option	Description
 Single AF (default setting)	Camera focuses when the shutter-release button is pressed halfway and focus is locked while the button is pressed. The focus is locked at this position during shooting.
 Full-time AF	Camera focuses continuously until focus is acquired and locked. To prevent sound of camera focusing from interfering with recording, use of Single AF is recommended.

Electronic VR



Set to  (Movie) → MENU →  (Movie menu) → Electronic VR

Enable or disable electronic VR for movie recording.

Option	Description
 On (default setting)	Reduce the effects of camera shake in all movie modes except Time-lapse movie  .
OFF Off	Electronic VR is not enabled.

At settings other than **Off**, the icon for the current setting is displayed in the monitor (8).



Vibration Reduction for Time-Lapse Movies

To enable or disable vibration reduction while shooting in **Time-lapse movie**  mode, use the **Vibration reduction** setting (143) in the setup menu (135).

Time-Lapse Movies

Record flowers opening or butterflies emerging from cocoons (82).

- 1 Use the multi selector to choose **Movie options** from the movie menu and press the  button.

- Choose the  tab when the movie menu is not displayed (13).

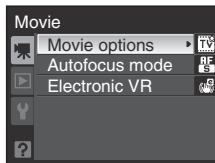

- 2 Choose  **Time-lapse movie**  and press the  button.

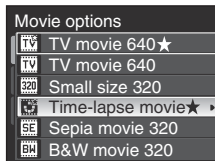

3 Choose the interval taken between each shot and press the **OK** button.

- Choose from **30 s**, **1 min**, **5 min**, **10 min**, **30 min** and **60 min**.

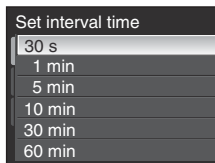

4 Press the **MENU** button.

- The camera returns to shooting mode.

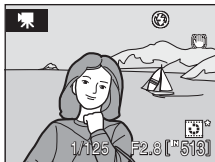

5 Press the shutter-release button all the way down to start recording.

- Monitor turns off and the power-on lamp blinks between shots.
- Monitor reactivates automatically for the next shot.

6 Press the shutter-release button all the way down a second time to end recording.

- Recording will automatically stop if the internal memory or memory card becomes full, or when 1800 frames have been recorded. A 1800-frame movie has a playback time of 60 seconds.

✓ Time-Lapse Movie

- Flash mode (📖32), focus mode (📖36), and exposure compensation (📖39) cannot be adjusted after the first picture is shot. The second picture or later will be shot with the same settings. Apply the appropriate settings before shooting begins.
- To prevent the camera from turning off unexpectedly during recording, use a fully charged battery.
- To power the camera continuously for extended periods, use the AC Adapter EH-62A (available separately from Nikon). Do not, under any circumstances, use another make or model of AC adapter. Failure to observe this precaution could result in overheating or in damage to the camera.
- Do not rotate the mode dial to a different setting during recording.

Movie Playback

In full-frame playback mode (📖30), movies are recognized by the movie mode icons (📖82). To play a movie, display it in full-frame playback mode and press the **OK** button.

Use the zoom control **T** or **W** during playback to adjust the volume.

Rotate the command dial to advance or rewind the movie.

Playback controls appear at the top of the monitor. Press the multi-selector ◀ or ▶ to choose a control, then press the **OK** button to perform the selected operation. The following operations are available.

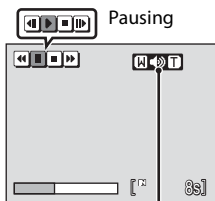

During playback Volume indicator

To	Use	Description
Rewind	⏮	Rewind the movie when the OK button is pressed down.
Advance	⏭	Advance the movie when the OK button is pressed down.
Pause	⏸	Press the OK button to pause playback. The following operations can be performed while playback is paused.
		⏮ Press the OK button to rewind the movie by one frame. Rewind continues while the button is pressed.
		⏭ Press the OK button to advance the movie by one frame. Advance continues while the button is pressed.
	▶	Press the OK button to resume playback.
End	⏹	Press the OK button to return to full-frame playback mode.

Deleting Movie Files

Press the **🗑** button when being played back, when displayed in full-frame playback mode (📖30), or when selected in thumbnail (📖71) playback mode.

Select **Yes** and press the **OK** button to delete the movie, or select **No** to exit without deleting the movie.

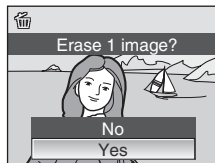

Making Voice Recordings

Audio voice recordings can be recorded over the built-in microphone and played back over the built-in speaker.

1 Rotate the mode dial to **SCENE**.

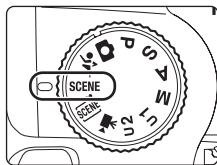

2 Press the **MENU** button to display the scene menu screen, choose **Voice recording** with the multi selector and press the **OK** button.

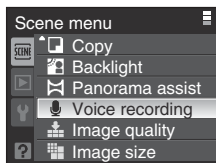
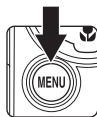

- The length of recording that can be made will be displayed.
- Choose the **SCENE** tab when the scene menu is not displayed (13).

3 Press **◀** or **▶** to choose **🔴** on the operation panel, and press the **OK** button to start recording.

- The power-on lamp lights during recording.
- If no operations are performed for about 30 seconds after voice recording begins, the camera's power saving function is enabled and the monitor turns off. Press the **DISP** button to light up the monitor.
- See "Operations During Recording" (88) for more information.

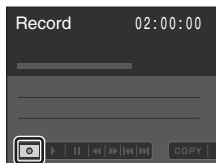

4 Press **◀** or **▶** to choose **■** on the operation panel, and press the **OK** button to stop recording.

- Recording will end automatically if the internal memory or memory card becomes full, or after 120 minutes of recording on the memory card.

More Information

See "File and Folder Names" (156) for more information.

Operations During Recording



To	Use	Description
Move the cursor on the operation panel		<p>Press ◀ or ▶ on the multi selector.</p> <p>■ : Press the OK button to end recording.</p> <p> : Press the OK button to pause recording. Choose ⏸ and press the OK button to resume recording while recording is paused.</p>
Create index*		<p>Press ▲ or ▼ on the multi selector.</p> <p>Indexes make it easy to locate desired portions of a recording.</p> <p>Start of recording is index number 01; other numbers that follow are assigned in ascending order each time the multi selector is pressed, up to index number 98.</p>

* The copied files can be played back using QuickTime or any other WAV compatible audio player. Note that index points created with the camera cannot be used when voice recordings are played back on computers.

Operations During Playback

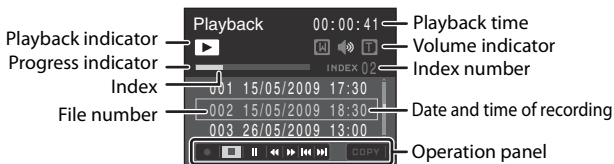

Use the zoom control **T/W** to adjust playback volume.

Rotate the command dial to advance or rewind the voice recording.

Playback controls appear at the bottom of the monitor. Press the multi selector ◀ or ▶ to choose a control, then press the **OK** button to perform the selected operation. The following operations are available.

To	Use	Description
Rewind	◀◀	Rewind the voice recording when the OK button is pressed down.
Advance	▶▶	Advance the voice recording when the OK button is pressed down.
Skip to previous index	◀◀◀	Press the OK button to skip to the previous index.
Skip to next index	▶▶▶	Press the OK button to skip to the next index.
Pause	⏸	Press the OK button to pause playback. Press the OK button to resume playback while playback is paused.
End	■	Press the OK button to end playback.

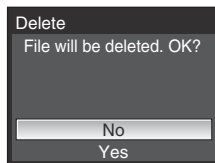

Deleting Sound Files

Press the **🗑** button during playback, or choose a sound file in the voice recording screen, and press the **🗑** button to display the confirmation dialog. To delete the file, choose **Yes** and press the **OK** button. To cancel deletion, choose **No**.





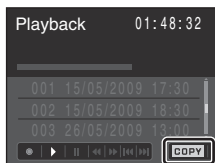

Copying Voice Recordings

Copy voice recordings between the internal memory and a memory card. This option is available only when a memory card is inserted.

- 1 Press ◀ or ▶ on the multi selector in the voice recording screen (step 3 of )89), choose **COPY** and press the  button.



- 2 Choose a copy option and press the  button.

-  → : Copy recordings from internal memory to memory card.
-  → : Copy recordings from memory card to internal memory.

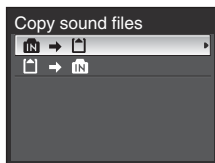

- 3 Select a copy option and press the  button.

- **Selected files:** proceed to step 4
- **Copy all files:** proceed to step 5

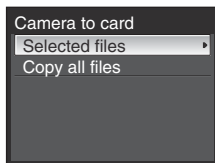

- 4 Choose the data to be copied.

- Press the multi selector ▶ to select the file (✓). Press the multi selector ▶ again to cancel the selection.
- Multiple files can be selected.
- Press the  button when setting is complete.

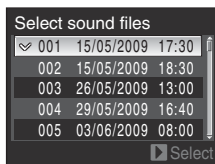

- 5 When a confirmation dialog is displayed, choose **Yes** and press the  button.

- Copying starts.

Note on Copying Sound Files

This camera may be unable to play or copy sound files created with other cameras.

Connecting to a TV

Connect the camera to a television using the supplied audio/video cable to play back pictures on the television.

1 Turn off the camera.

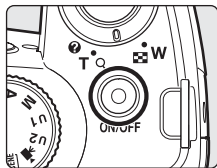

2 Connect the camera to the TV using the supplied audio/video cable.

- Connect the yellow plug to the video-in jack on the TV, and the white plug to the audio-in jack.

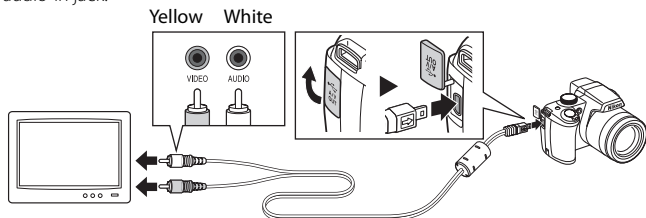

3 Tune the television to the video channel.

- See the documentation provided with your television for details.

4 Hold down the button to turn on the camera.

- The camera enters playback mode, and pictures recorded to the internal memory, or memory card, will be displayed on the television.
- While connected to the TV, the camera monitor will remain off.

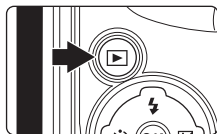

Connecting the Audio/Video Cable

When connecting the audio/video cable, be sure that the connectors are oriented correctly. Do not use force when connecting the audio/video cable. When disconnecting the audio/video cable, do not pull the connector at an angle.

When Nothing Appears on the TV

Be sure that the camera's video mode setting in the setup menu (📖135) → **Video mode** (📖148) conforms to the standard used by your television.

Connecting to a Computer

Use the supplied USB cable to connect the camera to a computer, and copy (transfer) pictures to a computer with the supplied Nikon Transfer software.

Before Connecting the Camera

Installing the Software

Before connecting the camera to a computer, software, including Nikon Transfer, and Panorama Maker for creating panorama photos, must be installed from the supplied Software Suite CD. For more information on installing the software, refer to the *Quick Start Guide*.

Compatible Operating Systems

Windows

Preinstalled versions of 32-bit Windows Vista Home Basic/Home Premium/Business/Enterprise/Ultimate editions (Service Pack 1), Windows XP Home Edition/Professional (Service Pack 3)

Macintosh

Mac OS X (version 10.3.9, 10.4.11, 10.5.5)

Refer to the Nikon website for the latest information on operating system compatibility.

Notes on Power Source

- When connecting the camera to a computer or printer, use a fully charged battery to prevent the camera from turning off unexpectedly.
- To power the camera continuously for extended periods, use the AC Adapter EH-62A (available separately from Nikon). Do not, under any circumstances, use another make or model of AC adapter. Failure to observe this precaution could result in overheating or in damage to the camera.

Transferring Pictures from the Camera to a Computer

- 1 Start the computer to which Nikon Transfer was installed.
- 2 Turn off the camera.
- 3 Connect the camera to the computer using the supplied USB cable.

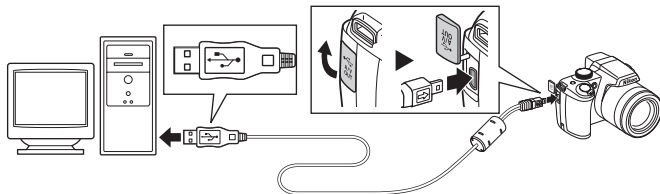

- 4 Turn on the camera.

- The power-on lamp will light.

- **Windows Vista:**

When the **AutoPlay** dialog is displayed, click **Copy pictures to a folder on my computer using Nikon Transfer**. Nikon Transfer will start.

To bypass this dialog in the future, check **Always do this for this device:**

- **Windows XP:**

When the action selection dialog is displayed, click **Nikon Transfer Copy pictures to a folder on my computer**, and click **OK**. Nikon Transfer will start. To bypass this dialog in the future, check **Always use this program for this action.**

- **Mac OS X:**

Nikon Transfer will start automatically if **Yes** was selected in the **Auto-Launch setting** dialog when Nikon Transfer was first installed.

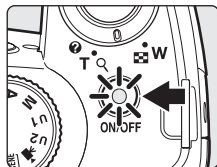

Connecting the USB Cable

- When connecting the USB cable, be sure that the connectors are oriented correctly. Do not use force when connecting the USB cable. When disconnecting the USB cable, do not pull the connector at an angle.
- Connection may not be recognized when the camera is connected to a computer via a USB hub.

5 Transfer pictures when Nikon Transfer has finished loading.

- Click the **Start Transfer** button in Nikon Transfer. All pictures will be transferred to the computer (at the Nikon Transfer default setting).

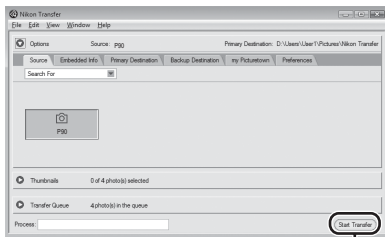

Start Transfer button

- The folder to which pictures are transferred is automatically opened when transfer is complete (at the Nikon Transfer default setting).
- If ViewNX has been installed, ViewNX will start automatically and you can view the pictures transferred.
- For more information on using Nikon Transfer or ViewNX, refer to the help information contained in Nikon Transfer or ViewNX.

6 Disconnect the camera when transfer is complete.

- Turn the camera off and disconnect the USB cable.

Using a Card Reader

Pictures stored on a memory card that is inserted into a card reader or similar device can also be transferred to the computer using Nikon Transfer.

- If the memory card has a capacity of 2 GB or greater, or is SDHC-compliant, the intended device must support these features of the memory card.
- Nikon Transfer will start automatically when a memory card is inserted into the card reader or similar device (default setting of Nikon Transfer). See step 5 of “Transferring Pictures from the Camera to a Computer” (📖95).
- To transfer pictures stored in the camera’s internal memory to the computer, the pictures must first be copied to a memory card using the camera (📖91, 134).

Using the Computer to Open Image/Sound Files

- Navigate to the folder to which pictures were saved and open a picture in the viewer supplied with your operating system.
- Sound files can be played back using QuickTime or any other WAV compatible audio player.

Panorama Creation with Panorama Maker

- Use a series of pictures taken using the **Panorama assist** option in scene mode (📖47) to create a single panorama photo with Panorama Maker.
- Panorama Maker can be installed to a computer using the supplied Software Suite CD.
- After installation is complete, follow the procedure described below to start Panorama Maker.

Windows:

From the **Start** menu, open **All Programs** → **ArcSoft Panorama Maker 4** → **Panorama Maker 4**.

Macintosh:

Open Applications by selecting **Applications** from the Go menu, and double-click the **Panorama Maker 4** icon.

- For more information on using Panorama Maker, refer to the on-screen instructions and help information contained in Panorama Maker.

More Information

See “File and Folder Names” (📖156) for more information.

Connecting to a Printer

Users of PictBridge-compatible (📖175) printers can connect the camera directly to the printer and print pictures without using a computer. The steps for printing are as follows.

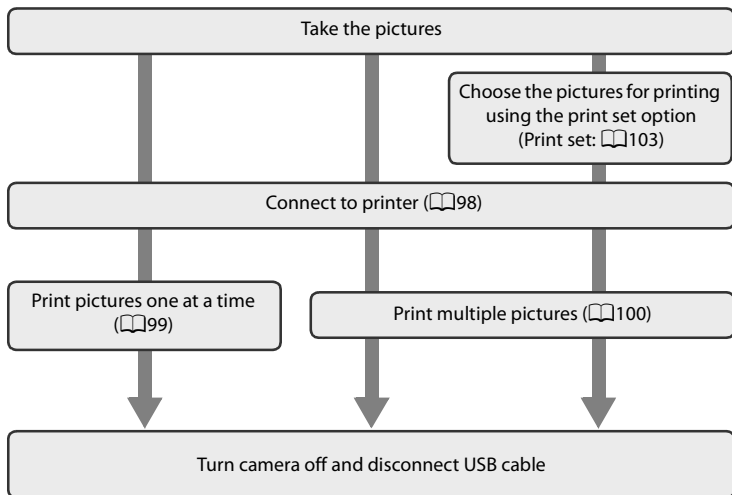

✔ Notes on Power Source

- When connecting the camera to a computer or printer, use a fully charged battery to prevent the camera from turning off unexpectedly.
- To power the camera continuously for extended periods, use the AC Adapter EH-62A (available separately from Nikon). Do not, under any circumstances, use another make or model of AC adapter. Failure to observe this precaution could result in overheating or in damage to the camera.

🔍 Printing Pictures

In addition to printing pictures transferred to a computer and printing over a direct camera-to-printer connection for images recorded in the memory card, the following options are also available for printing pictures:

- Insert a memory card into a DPOF-compatible printer's card slot.
- Take a memory card to a digital photo lab.

For printing using these methods, specify the pictures and the number of prints each using the **Print set** (📖103) option in the playback menu.

Connecting the Camera and Printer

- 1 Turn off the camera.

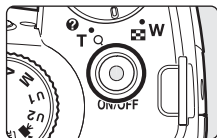

- 2 Turn on the printer.

- Check printer settings.

- 3 Connect the camera to the printer using the supplied USB cable.

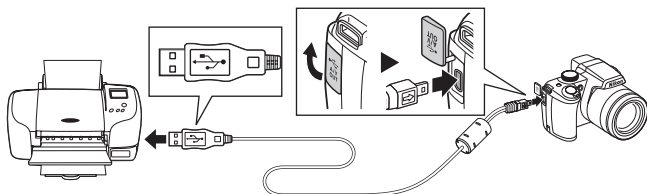

- 4 Turn on the camera.

- When connected correctly, the PictBridge startup screen ① will be displayed in the camera monitor. Then the print selection screen will be displayed ②.

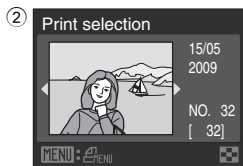
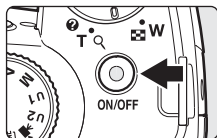

✓ Connecting the USB Cable

When connecting the USB cable, be sure that the connectors are oriented correctly. Do not use force when connecting the USB cable. When disconnecting the USB cable, do not pull the connector at an angle.

🔍 More Information

See "Printing Images of Size 1:1" (📖110) for more information.

Printing Pictures One at a Time

After connecting the camera to the printer correctly (📖98), print pictures by following the procedure below.

1 Use the multi selector to choose the picture to be printed and press the **OK** button.

- Pictures can also be chosen by rotating the command dial.
- Rotate the zoom control to **W** (📷) to display 12 thumbnails, or to **T** (📺) to switch back to full-frame playback.

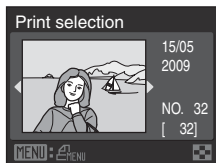

2 Choose **Copies** and press the **OK** button.

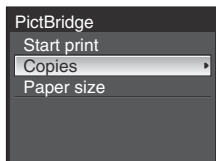

3 Choose the number of copies (up to nine) and press the **OK** button.

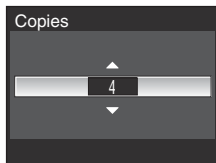

4 Choose **Paper size** and press the **OK** button.

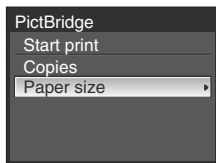

5 Choose the desired paper size and press the **OK** button.

- To specify paper size using printer settings, choose **Default** in the paper size menu.

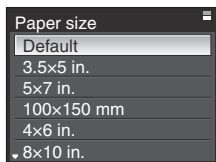

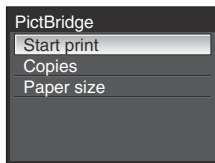
6 Choose **Start print** and press the **OK** button.**7** Printing starts.

- Monitor display returns to that shown in step 1 when printing is complete.
- To cancel before all copies have been printed, press the **OK** button.

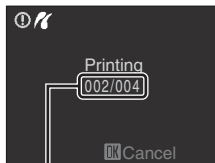

Current print/total number of prints

Printing Multiple Pictures

After connecting the camera to the printer correctly (📖98), print pictures by following the procedure below.

1 When the print selection screen is displayed, press the **MENU** button.

- The print menu is displayed.

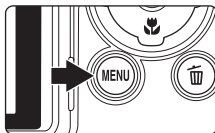
**2** Use the multi selector to choose **Paper size** and press the **OK** button.

- To exit the print menu, press the **MENU** button.

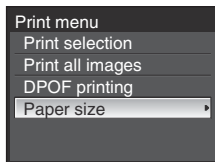
**3** Choose the desired paper size and press the **OK** button.

- To specify paper size using printer settings, choose **Default** in the paper size menu.

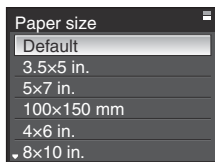

4 Choose **Print selection**, **Print all images** or **DPOF printing** and press the **OK** button.

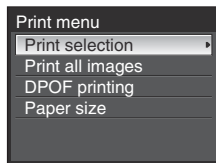

Print selection

Choose the pictures (up to a maximum of 99) and number of copies (up to nine per picture).

- Press the multi selector ◀ or ▶ to choose the pictures, and press ▲ or ▼ to set the number of copies for each.
- Pictures can also be chosen by rotating the command dial.
- Pictures selected for printing can be recognized by the check mark icon and the numeral indicating the number of copies to be printed. A check mark is not displayed with pictures for which no copies have been specified and these pictures will not be printed.
- Rotate the zoom control to **T** (Q) to switch to full-frame playback, or **W** (checkered flag) to switch to 12 thumbnails display.
- Press the **OK** button when setting is complete.
- The menu shown at right will be displayed. To print, choose **Start print** and press the **OK** button.
- Choose **Cancel** and press the **OK** button to return to the print menu.

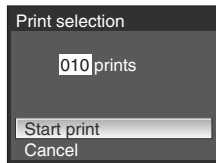
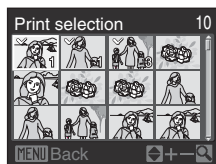

Print all images

All pictures stored in the internal memory, or on the memory card, are printed one at a time.

- The menu shown at right will be displayed. To print, choose **Start print** and press the **OK** button.
- Choose **Cancel** and press the **OK** button to return to the print menu.

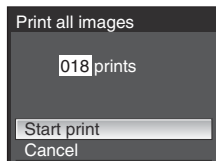

DPOF printing

Print pictures for which a print order was created in **Print set** option.

- The menu shown at right will be displayed. To print, choose **Start print** and press the **OK** button.
- Choose **Cancel** and press the **OK** button to return to the print menu.
- To view the current print order, choose **View images** and press the **OK** button. To print pictures, press the **OK** button again.

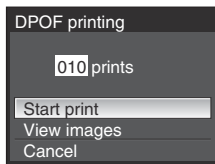

5 Printing starts.

- Monitor display returns to that shown in step 2 when printing is complete.
- To cancel before all copies have been printed, press the **OK** button.

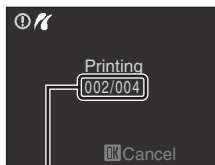

Current print/total number of prints

Paper Size

The camera supports the following paper sizes: **Default** (the default paper size for the current printer), **3.5×5 in.**, **5×7 in.**, **100×150 mm**, **4×6 in.**, **8×10 in.**, **Letter**, **A3**, and **A4**. Only sizes supported by the current printer will be displayed.

Creating a DPOF Print Order: Print Set

The Print set option in the playback menu is used to create digital “print orders” for printing on DPOF-compatible printers or in print shops (📖175).

When the camera is connected to a PictBridge-compatible printer, pictures can be printed from the printer according to the DPOF print order you have created for pictures on the memory card. If the memory card is removed from the camera, you can create the DPOF print order for pictures in the internal memory and print pictures according to the DPOF print order.

1 Press the **MENU** button in playback mode.

- The playback menu is displayed.

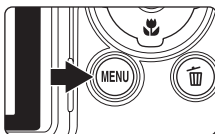

2 Use the multi selector to choose **Print set** and press the **OK** button.

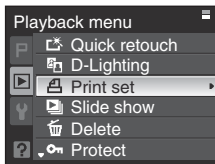

3 Choose **Select images** and press the **OK** button.

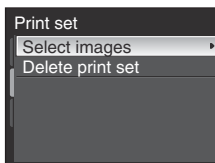

4 Choose the pictures (up to a maximum of 99) and number of copies (up to nine per picture).

- Press the multi selector ◀ or ▶ to choose the pictures, and press ▲ or ▼ to set the number of copies for each.
- Pictures can also be chosen by rotating the command dial.
- Pictures selected for printing can be recognized by the check mark icon and the numeral indicating the number of copies to be printed. A check mark is not displayed with pictures for which no copies have been specified and these pictures will not be printed.
- Rotate the zoom control to **T** (📷) to switch to full-frame playback, or **W** (📱) to switch to 12 thumbnails display.
- Press the **OK** button when setting is complete.

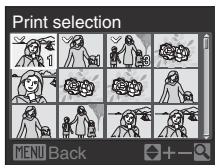



More Information

See “Printing Images of Size 1:1” (📖110) for more information.

5 Choose whether or not to also print shooting date and photo information.

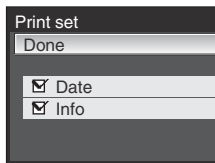
- Choose **Date** and press the **OK** button to print the date of recording on all pictures in the print order.
- Choose **Info** and press the **OK** button to print shooting information (shutter speed and aperture) on all pictures in the print order.
- Choose **Done** and press the **OK** button to complete the print order.



Pictures selected for printing are recognized by the  icon displayed with playback.

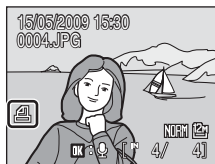

Notes on Printing Shooting Date and Photo Information

When the **Date** and **Info** options are enabled in the Print set menu, shooting date and photo information are printed on pictures when a DPOF-compatible ( 175) printer which supports printing of shooting date and photo information is used.

- Photo information cannot be printed when the camera is connected directly to a printer, via the supplied USB cable, for DPOF printing ( 102).
- **Date** and **Info** are reset each time the **Print set** menu is displayed.

Deleting All Print Orders

Choose **Delete print set** in step 3 and press the **OK** button. Print orders for all pictures will be deleted.

Note on the Print Set Date Option

The date and time printed on the picture is the date and time recorded on the camera when the picture was taken. The date and time printed using this option will not be affected even if the camera's **Date** setting is changed from the setup menu after the pictures are taken.































Date imprint

The date and time of recording can be imprinted on pictures using the **Date imprint** option ( 142) in the setup menu. Pictures with the date and time imprinted on them can also be printed from printers that do not support printing of the date and time on pictures.

Only the date and time of **Date imprint** on the pictures will be printed, even if **Print set** is enabled with the date selected in the print set screen.

Shooting Options: The Shooting Menu

The shooting menu of **P**, **S**, **A**, **M**, **U1** and **U2** modes contain the following options.

	Image quality*	 107
Choose the image quality (compression ratio) of recorded pictures.		
	Image size*	 108
Choose the image size of recorded pictures.		
	Optimize image	 111
Change the settings for optimizing images according to the shooting scene or your preferences.		
	White balance	 114
Match white balance to the light source.		
	ISO sensitivity	 116
Control the camera's sensitivity to light.		
	Metering	 117
Choose how the camera meters exposure.		
	Continuous	 118
Change settings for Continuous (continuous shooting) and BSS (Best Shot Selector).		
	Auto bracketing	 121
Vary exposure over a sequence of pictures.		
	AF area mode	 122
Choose where the camera focuses.		
	Autofocus mode	 125
Choose how the camera focuses.		
	Flash exp. comp.	 125
Adjust flash level.		
	Noise reduction	 126
Reduce noise in pictures shot at slow shutter speeds.		
	Distortion control	 126
Correct the distortion.		
	Active D-Lighting	 70
Prevent loss of detail in highlights and shadows when shooting images.		

U1
U2 Save user settings 📖68

Save the current edited settings into the mode dial **U1** and **U2** modes.

U1
U2 Reset user settings 📖69

Reset the saved settings in **U1** and **U2** back to the default settings.

* This option can also be set in the menus for other shooting modes (except for movie mode).

Displaying the Shooting Menu

Choose **P** (Programmed Auto), **S** (Shutter-Priority Auto), **A** (Aperture-Priority Auto), **M** (Manual) or **U1/U2** by rotating the mode dial.

Press the **MENU** button and choose a tab from **P, S, A, M, U1** or **U2** to display the shooting menu (📖13).

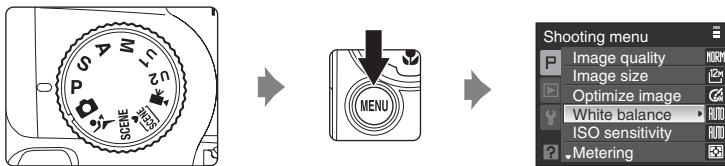

- Press the multi selector to select items and set functions on menus (📖12).
- Press the **MENU** button to exit the shooting menu.

✔ Functions that Cannot Be Applied Simultaneously

Some functions cannot be enabled in conjunction with others (📖127).

🔑 Navigating the Camera Menu

The command dial can also be used in place of pressing ▲ or ▼ on the multi selector.

Image Quality

Set to **P, S, A or M** → MENU → **P, S, A, M** (shooting menu) (📖105) → Image quality

Choose the amount of compression applied to pictures.

Lower compression ratios result in higher quality pictures, but also larger file sizes, limiting the number of pictures that can be recorded.

FINE Fine

Fine quality images (compression ratio of 1:4), suitable for enlargement or high quality prints.

NORM Normal (default setting)

Normal image quality (compression of 1:8), suitable for most applications.

BASIC Basic

Basic image quality (compression of 1:16), suitable for pictures that will be distributed by e-mail or used in web pages.

The icon for the current setting is displayed in the monitor in shooting and playback modes (📖8, 9).

Notes on the Image Quality Setting

- Changes made to the image quality setting apply to all shooting modes (except for sport continuous mode, **U1** and **U2** shooting modes, and movie mode).
- Use the sport continuous menu to change the image quality setting for sport continuous mode (📖58).

More Information

See "Number of Exposures Remaining" (📖109) for more information.

















Image size

Set to **P, S, A** or **M** → **MENU** → **P, S, A, M** (shooting menu) (105) → Image size

Choose the size of pictures in pixels for recording.

Pictures shot at smaller sizes require less memory, making them suited to distribution by e-mail or the web.

Conversely, the larger the image, the larger the size at which it can be printed or displayed without becoming noticeably “grainy,” limiting the number of pictures that can be recorded.

Image size	Description
 4000×3000 (default setting)	Record pictures exhibiting greater detail than those shot at  3264×2448 or  2592×1944 .
 3264×2448	Good balance between file size and quality makes this the best choice in most situations.
 2592×1944	
 2048×1536	Smaller than  4000×3000 ,  3264×2448 and  2592×1944 for recording more pictures.
 1600×1200	
 1280×960	
 1024×768	
 640×480	Record pictures suitable for display on a television, or for distribution via e-mail.
 3984×2656	Record pictures with the same aspect ratio (3:2) as those shot with 35 mm film cameras.
 3968×2232	Record pictures with the same aspect ratio (16:9) as wide-screen televisions.
 2992×2992	Record perfectly square pictures.



The icon for the current setting is displayed in the monitor in shooting and playback modes (8, 9).

Notes on the Image Size Setting

- Changes made to the image size setting apply to all shooting modes (except for sport continuous mode, **U1** and **U2** shooting modes, and movie mode).
- Change the image size settings for sport continuous mode using the sport continuous menu (58).

Number of Exposures Remaining

The following table lists the approximate number of pictures that can be stored in internal memory and on a 512 MB memory card, at each combination of **Image size** (□□108) and **Image quality** (□□107) settings. Note that the number of images that can be stored will differ depending on the composition of the image (due to JPEG compression). In addition, this number may differ depending on the make of memory card, even if the capacity for the memory card is the same.

Image size	Image quality	Internal memory (approx. 47 MB)	Memory card ¹ (512 MB)	Print size ² (cm/in.)
 4000×3000 (default setting)	Fine	8	80	34×25/13×10
	Normal	16	160	
	Basic	32	320	
 3264×2448	Fine	12	120	28×21/11×8
	Normal	24	240	
	Basic	48	470	
 2592×1944	Fine	19	190	22×16/8.5×6.5
	Normal	38	375	
	Basic	75	735	
 2048×1536	Fine	31	305	17×13/7×5
	Normal	60	590	
	Basic	114	1115	
 1600×1200	Fine	50	495	14×10/5×4
	Normal	96	940	
	Basic	171	1675	
 1280×960	Fine	77	755	11×8/4×3
	Normal	140	1370	
	Basic	256	2515	
 1024×768	Fine	114	1115	9×7/3.5×2.5
	Normal	205	2010	
	Basic	342	3355	
 640×480	Fine	256	2515	5×4/2×1.5
	Normal	385	3775	
	Basic	616	6040	
 3984×2656	Fine	9	90	34×22/13×8.5
	Normal	18	180	
	Basic	36	355	
 3968×2232	Fine	11	110	34×19/13×7.5
	Normal	22	215	
	Basic	44	430	
 2992×2992	Fine	11	105	25×25/10×10
	Normal	22	215	
	Basic	43	425	
 1920×1080 ³	Fine	46	455	16×9/6.5×3.5
	Normal	88	860	
	Basic	162	1590	

Shooting Options: The Shooting Menu

- 1 If the number of exposures remaining is 10,000 or more, the number of exposures remaining display shows "9999".
- 2 Print size at an output resolution of 300 dpi.
Print sizes are calculated by dividing the number of pixels by printer resolution (dpi) and multiplying by 2.54 cm (1 in.). However, even with the same image size setting, images printed at higher resolutions will print smaller than the size indicated, and those printed at lower resolutions will print larger than the size indicated.
- 3 This image size is used when **Continuous H (16:9)** is chosen for the **High-speed mode** option in the Sport Continuous Menu.



Printing Images of Size 1:1

Change the printer setting to "Border" when printing images of size set to 1:1.

The images may not be printed in 1:1 ratio depending on the printer.

See the instruction manual of the printer or check with the authorized print dealer for further details.

Optimize Image

Set to **P, S, A or M** → MENU → **P, S, A, M** (shooting menu) (📖105) → Optimize image

Change the settings for optimizing images according to the shooting scene or your preferences. Contrast, saturation, sharpening, and other settings can be adjusted in detail.

 **Normal (default setting)**
Recommended in most situations.

 **Softer**
Softens outlines, producing natural results suitable for portraits or retouching on a computer.

 **Vivid**
Enhances saturation and produces vibrant reds and greens. Images will become sharp and slightly high in contrast.

 **More vivid**
Maximizes saturation, contrast, and sharpness to produce crisp images with sharp outlines.

 **Portrait**
Lowers contrast while lending natural texture and rounded feel to skin of portrait subjects.

 **Custom**
Customize image optimization settings (📖112).

 **Black-and-white**
Shoot photos in black-and-white (📖113).

At settings other than **Normal**, the indicator for the current optimize image setting is displayed in the monitor during shooting (📖8).

Optimize Image

If the optimize image setting is set to **Normal, Softer, Vivid, More vivid, Portrait** or **Standard of Black-and-white**, results will vary with exposure and the position of the subject in the frame even if shooting conditions remain the same. For consistent results over a series of photographs, select **Custom** and choose a setting other than **Auto** for contrast, sharpening, and saturation.

Customizing Image Enhancement Options: Custom

Select **Custom** to make separate adjustments to the following options.

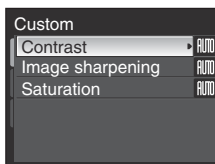

Contrast

Control contrast.

Lower settings prevent loss of detail in highlights under harsh lighting or in direct sunlight. Higher settings preserve detail in misty landscapes and other low-contrast subjects.

The default setting is **Auto**.

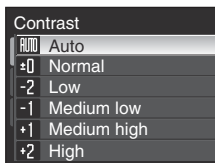
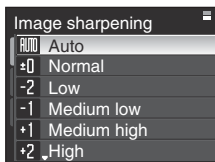

Image sharpening

Choose how much outlines are sharpened during shooting.

Choose high settings for sharp outlines, low settings for softer outlines.

The default setting is **Auto**.



Saturation

Control the vividness of colors.

Choose moderate for less saturated colors, enhanced for more vivid colors.

The default setting is **Auto**.

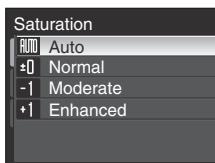

✔ Note on Contrast

Contrast settings cannot be changed if **Active D-Lighting** (☰70) is set to any setting other than **Off**.

✔ Note on Image Sharpening

The effects of image sharpening cannot be previewed in the monitor during shooting. Check results in playback mode.

Shooting in Black-and-White: Black-and-white

When **Black-and-white** is selected, the options described below are available.

- Choose **Standard** to shoot in basic black-and-white.
- Choose **Custom** to manually adjust **Contrast**, **Image sharpening**, and **Monochrome filter** effects.
- When the **B&W + color** option is enabled (✓), one black-and-white picture and the same picture in full color are recorded simultaneously.

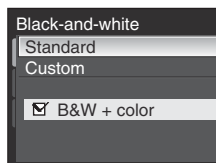

The following options can be adjusted in **Custom**.

Contrast

Same as **Optimize image** → **Custom** → **Contrast** (📖112).

Image sharpening

Same as **Optimize image** → **Custom** → **Image sharpening** (📖112).

Monochrome filter

This effect simulates black-and-white photography with a color filter.

Yellow, Orange, Red:

Enhance contrast. Can be used to tone down the brightness of the sky in landscape photographs. Orange filter results in greater contrast than yellow filter, and red filter greater contrast than orange filter.

Green:

Softens skin tones. Suitable for portraits.

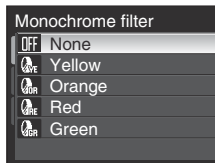

B&W + Color

Color pictures recorded when B&W + color is enabled are the same as those shot at an optimize image setting of **Normal**.

WB White Balance

Set to **P, S, A or M** → MENU → **P, S, A, M** (shooting menu) (📖105) → White balance

The color of light reflected from an object varies with the color of the light source. The human brain is able to adapt to changes in the color of the light source, with the result that white objects appear white whether seen in the shade, direct sunlight, or under incandescent lighting. Digital cameras can mimic this adjustment of the human eye by processing images according to the color of the light source. This is known as “white balance.” For natural coloration, choose a white balance setting that matches the light source before shooting.

Although the default setting, **Auto**, can be used under most types of lighting, you can apply the white balance setting suited to a particular light source to achieve more accurate results.

Auto (default setting)

White balance automatically adjusted to suit lighting conditions. Best choice in most situations.

Preset manual

Neutral-colored object used as reference to set white balance under unusual lighting conditions. See “Preset Manual” (📖115) for more information.

Daylight

White balance adjusted for direct sunlight.

Incandescent

Use under incandescent lighting.

Fluorescent

Use under most types of fluorescent lighting.

Cloudy

Use when shooting under overcast skies.

Flash

Use with the flash.

The effects of the selected option can be previewed in the monitor. At settings other than **Auto**, the icon for the current setting is displayed in the monitor (📖8).

Flash Mode

At white balance settings other than **Auto** or **Flash**, turn the flash off (🔴) (📖32).

Preset Manual

Preset manual is used with mixed lighting or to compensate for light sources with a strong color cast when the desired effect has not been achieved with settings like **Auto** and **Incandescent** (for example, to make images shot under a lamp with a red shade look as though they had been shot under white light).

1 Place a white or gray reference object under the lighting that will be used during shooting.

2 Use the multi selector to choose **PRE Preset manual** in the white balance menu, and press the **OK** button.

- The camera lens extends to a position that is half of the camera's maximum optical zoom.

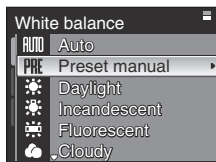

3 Choose **Measure**.

- To use the most recently measured value for preset manual, choose **Cancel** and press the **OK** button. The most recently measured value will be set for white balance.



4 Frame the reference object.

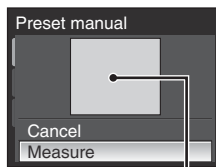

Reference object frame

5 Press the **OK** button to measure the white balance value.

- The shutter is released and the new white-balance value is set.
- No images are recorded.

✔ Note on Preset Manual

Regardless of the flash mode selected, the flash will not fire when the **OK** button is pressed in step 5. Therefore, the camera cannot measure a value for preset manual for when the flash is used.

ISO ISO Sensitivity

Set to **P, S, A** or **M** → MENU → **P, S, A, M** (shooting menu) (📖105) → ISO sensitivity

Sensitivity is a measure of how quickly the camera reacts to light. The higher the sensitivity, the less light needed to make an exposure. Although a high ISO rating is suitable for shooting pictures of subjects in action or in poor lighting, high sensitivity is often associated with “noise” - randomly spaced, brightly colored pixels concentrated in dark parts of the image.

Auto (default setting)

Sensitivity is ISO 64 in bright places; in dark places the camera automatically raises sensitivity to a maximum of ISO 800. In **M** (manual) mode, sensitivity will be fixed at ISO 64 if **Auto** is chosen.

High ISO sensitivity auto

The ISO sensitivity is set automatically within the range of ISO 64 to 1600 according to the brightness of the subject. In **M** (manual) mode, sensitivity will be fixed at ISO 64 if **High ISO sensitivity auto** is chosen.

Fixed range auto

Choose the range in which the camera automatically adjusts ISO sensitivity, from **ISO 64-100** (default setting), **ISO 64-200** or **ISO 64-400**. The camera will not raise sensitivity beyond the maximum value in the selected range. Set the maximum value for ISO sensitivity for effective control over the amount of “grain” that appears in images. In **M** (manual) mode, sensitivity will be fixed at ISO 64 if **Fixed range auto** is chosen.

64, 100, 200, 400, 800, 1600, 3200, 6400

ISO Sensitivity will be locked at the specified value.

At settings other than Auto, the current setting is displayed in the monitor (📖8). If **Auto** is selected and the sensitivity is raised above ISO 64, the **ISO** icon will be displayed (📖34). When **High ISO sensitivity auto** is selected **ISO** will be displayed, and **ISO** and the maximum ISO sensitivity value are displayed when **Fixed range auto** is selected.

✓ Notes on ISO Sensitivity 3200 and 6400

- When **3200** or **6400** is selected for **ISO sensitivity**, the image size will display in red during shooting.
- When **ISO sensitivity** is set to **3200** or **6400**, **Image size** (📖108) cannot be set to **4000×3000**, **3264×2448**, **2592×1944**, **3984×2656**, **3968×2232** and **2992×2992**. At these image size settings, selecting **3200** or **6400** for **ISO sensitivity** automatically switches the Image size setting to **2048×1536**. The last image size setting applied is restored when any setting other than **3200** or **6400** is selected for **ISO sensitivity**.

Metering

Set to **P, S, A or M** → MENU → **P, S, A, M** (shooting menu) (📖105) → Metering

The process of measuring the brightness of the subject to determine the exposure is known as Metering.

Choose how the camera meters exposure.

Matrix (default setting)

Camera sets exposure for entire frame. Recommended in most situations.

Center-weighted

Camera meters entire frame but assigns greatest weight to subject in center of frame. Classic meter for portraits; preserves background details while letting lighting conditions at center of frame determine exposure. Can be used with focus lock (📖29) to meter off-center subjects.

Spot

Camera meters area shown by circle in center of frame. Ensures that subject in metering target is correctly exposed even if background is much lighter or darker. Ensure that the subject is within the area shown by circle when shooting. Can be used with focus lock (📖29) to meter off-center subjects.

Spot AF area

Camera meters selected focus area. Available only when a setting other than **Center** is selected for **AF area mode** (📖122).

Notes on Metering

- When digital zoom is in effect, at magnifications of 1.2x to 1.8x, **Metering** is set to **Center-weighted**, and at magnifications of 2.0x to 4.0x, its set to **Spot**. When digital zoom is in effect, the metered area is not shown in the monitor.
- The setting for **Metering** will be changed to **Matrix** when any setting other than **Off** is selected for **Active D-Lighting**.

Metering Area

The active metering area is displayed in the monitor when **Center-weighted** or **Spot** is selected for **Metering**.

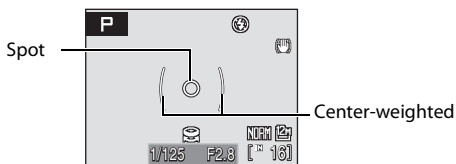

Continuous

Set to **P, S, A** or **M** → MENU → **P, S, A, M** (shooting menu) (📖105) → Continuous

Capture motion in a series of pictures and apply Best Shot Selector (BSS).

When **Continuous**, **BSS**, or **Multi-shot 16** is selected, the flash will be set to  (off), and focus, exposure and white balance are fixed at the values for the first picture in each series.

Single (default setting)

One image is shot each time the shutter-release button is pressed.

Continuous

While the shutter-release button is held down, up to 25 pictures are shot at a rate of about 1.4 frames per second (fps) when image quality is set to **Normal** and image size is set to  **4000×3000**.

BSS

BSS is recommended for shooting under low lighting without the flash, with the camera zoomed in, or in other situations in which camera shake is likely to blur pictures.

The camera takes up to ten images while the shutter-release button is held down. The sharpest image (image with the most detail) in the series is automatically selected and saved.

Multi-shot 16

Each time shutter-release button is pressed, camera shoots 16 pictures at about 7.5 frames per second and arranges them in a single picture with image quality set to **Normal** and image size set to  **2592×1944**.

- Digital zoom is not available.
- **ISO sensitivity** (📖116) will be changed automatically according to the brightness for **P, S** and **A** shooting modes. The setting for **ISO sensitivity** will be fixed at 400 for **M** (manual) mode.

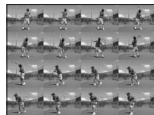

Intvl timer shooting

Camera takes images automatically at specified intervals (📖119).

At settings other than **Single**, the indicator for the current setting is displayed in the monitor (📖8).

✓ Notes on Continuous Shooting

- The maximum frame rate with continuous shooting may vary, depending upon the current image quality setting, image size setting and the type of memory card used.
- Be aware that shooting will stop if the built-in flash is raised or lowered while you are pressing the shutter-release button fully in **Continuous** or **BSS** mode.

✓ Note on Best Shot Selector

BSS is best suited for shooting stationary subjects. BSS may not produce the desired results if the subject moves or the composition changes while the shutter-release button is pressed all the way down.

✓ Notes on Multi-shot 16

If bright objects such as the sun or electric lights are captured when shooting with the Multi-shot 16 option, vertical streaks of light may appear in the recorded images. We recommend that you avoid capturing bright objects when shooting with the Multi-shot 16 option.

✓ Note on Shutter Speed

When **Multi-shot 16** is selected for **Continuous** the fastest shutter speed is changed to 1/2500 second, and the slowest shutter speed is restricted to 1/30 second.

Interval Timer Shooting

Images are shot automatically at specified intervals.

Choose from **30 s**, **1 min**, **5 min**, or **10 min**.

- 1 Use the multi selector to choose **Intvl timer shooting** in the continuous menu screen and press the **OK** button.

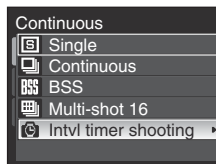

- 2 Choose the interval taken between each shot and press the **OK** button.

- The maximum amount of frames that can be taken during interval timer shooting differs according to the interval taken between each shot.
 - **30 s**: 600 images
 - **1 min**: 300 images
 - **5 min**: 60 images
 - **10 min**: 30 images

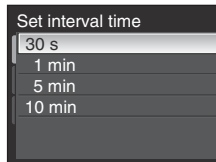

3 Press the **MENU** button.

- The camera returns to shooting mode.

4 Press the shutter-release button all the way down to shoot the first picture and initiate interval timer shooting.

- Monitor turns off and the power-on lamp blinks between shots.
- The monitor turns back on automatically right before the next image is shot.

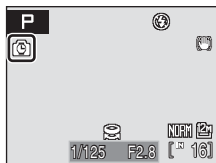

5 Press the shutter-release button all the way down a second time to end recording.

- Recording will end automatically if the internal memory or memory card becomes full, or when the maximum amount of frames have been recorded.

Notes on Interval Timer Shooting

- To prevent the camera from turning off unexpectedly during recording, use a fully charged battery.
- To power the camera continuously for extended periods, use the AC Adapter EH-62A (available separately from Nikon). Do not, under any circumstances, use another make or model of AC adapter. Failure to observe this precaution could result in overheating or in damage to the camera.
- Do not rotate the mode dial to a different setting while performing interval timer shooting.

More Information

See “File and Folder Names” (📖 156) for more information.

BKT Auto Bracketing

Set to **P, S, A** or **M** → MENU → **P, S, A, M** (shooting menu) (📖105) → Auto bracketing

Auto bracketing is used to vary exposure by a selected amount over a series of pictures, “bracketing” the exposure value selected by the camera or with exposure compensation. Use in situations in which it is difficult to guess the correct exposure (📖39).

 ±0.3

Camera varies exposure by 0 EV, +0.3EV, and –0.3EV over next three shots. The three shots will be taken in sequence when the shutter-release button is fully pressed.

 ±0.7

Camera varies exposure by 0 EV, +0.7EV, and –0.7EV over next three shots. The three shots will be taken in sequence when the shutter-release button is fully pressed.

 ±1.0

Camera varies exposure by 0 EV, +1.0EV, and –1.0EV over next three shots. The three shots will be taken in sequence when the shutter-release button is fully pressed.

OFF Off (default setting)

Bracketing is not performed.

At settings other than **Off**, the icon for the current setting is displayed in the monitor (📖8).

✔ Notes on Auto Bracketing

- **Auto bracketing** is not available in **M** (manual) mode.
- When exposure compensation is applied (📖39), and **±0.3**, or **±0.7** or **±1.0** is selected for **Auto bracketing**, the combined exposure compensation values will be applied.

[+] AF-Area Mode

Set to **P, S, A** or **M** → MENU → **P, S, A, M** (shooting menu) (📖105) → AF area mode

Use this option to determine where the camera focuses.

When digital zoom is in effect, the camera will focus on the subject in the center focus area regardless of the applied **AF area mode** option.

[👤] Face priority

The camera automatically detects and focuses on a face looking toward the camera (see “Shooting with Face Priority” (📖123) for more information). If the camera detects multiple faces, the camera focuses on the face closest to the camera.

When shooting pictures of subjects other than people, or framing a subject with which no face is recognized, AF area mode will be set to **Auto**. The camera chooses the focus area.

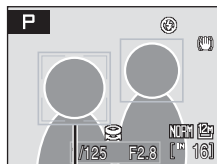

Focus area

[📷] Auto (default setting)

Camera automatically selects the focus area (one of nine) containing the subject closest to the camera. Press the shutter-release button halfway to activate the focus area.

When the shutter-release button is pressed halfway, the focus area selected by the camera will be displayed in the monitor.

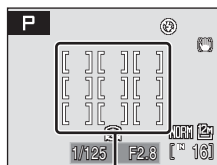

Focus areas

[📷] Manual

Choose the focus position from 99 areas in the screen. This option is suited to situations in which the intended subject is relatively still and not positioned in the center of the frame. Press the multi selector ▲, ▼, ◀ or ▶ to select one of 99 focus areas displayed in the monitor's focus-area selection screen, and shoot.

To end focus-area selection and adjust the flash mode, focus mode, self-timer and exposure compensation settings, press the **OK** button. To return to the focus-area selection screen, press the **OK** button again.

- At an **Image size** setting (📖108) of [📷] **2992x2992**, 81 focus areas are available.

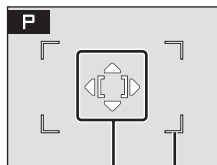

Focus area
Selectable areas

Center

Camera focuses on the subject in the center of the frame.
Center focus area is always used.

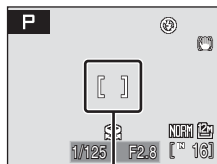

Focus area

More Information

See "Autofocus" (129) for more information.

Shooting with Face Priority



The camera automatically detects and focuses on a face looking toward the camera.

The face priority function will be enabled for the following situations.





- **Face priority** is selected for AF area mode (122)
- When **Portrait** (40) or **Night portrait** (42) is chosen for scene mode
- When scene auto selector mode (52) is chosen
- When  (smile timer) or  (blink proof) is set (54)

1 Frame the picture.

- When the camera detects a face looking toward the camera, that face will be framed by a yellow double border.
- 
- When the camera detects more than one face, depending upon the shooting mode, the operation varies as follows.



Shooting mode	Faces framed by a double border	Number of faces to be recognized
P, S, A, M, U1, U2 modes (Face priority)	The face closest to the camera * The other faces are framed by a single border.	Up to 12
Portrait or Night portrait scene modes		
Scene Auto Selector mode	The face closest to the center of the frame * The other faces are framed by a single border.	Up to 3
 (Smile timer)  (Blink proof)		

2 Press the shutter-release button halfway.

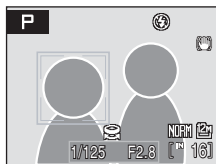
- The camera focuses on the face framed by the double border. The double border will glow green and focus will be locked.
- When the camera is unable to focus on a face, the double border will blink. Press the shutter-release button halfway again and focus.
- Press the shutter-release button all the way down to shoot.
- If the shutter-release button is fully pressed down while  (smile timer) or  (blink proof) is set, the shutter will release automatically when the camera detects a smiling face ( 54).
- When the **Blink warning** option in the setup menu is set to **On** (default setting), the **Did someone blink?** screen will appear immediately after shooting if there is a possibility that the subjects' eyes are closed. You can check the picture taken and determine if you need to take the picture again ( 149, 150). To return to the shooting mode, press  button or press the shutter-release button halfway down.



Notes on Face Priority

- When **Face priority** is selected for **AF area mode**, the setting will automatically switch to **Auto** if no face is detected when the shutter-release button is pressed halfway.
- If no face is recognized when the shutter-release button is pressed halfway in the **Portrait** or **Night portrait** scene modes, the camera will focus on the subject in the center focus area.
- The camera may be unable to detect faces in the following situations:
 - When faces are partially hidden by sunglasses or other obstructions
 - When the subject is not looking directly at the camera
 - When faces take up too much or too little of the frame
- The camera's ability to detect faces depends on a variety of factors, including whether or not the subject is facing the camera.
- In some rare cases of shooting subjects with which autofocus may not perform as expected ( 29), the subject may not be in focus despite the fact that the double border glows green. Should this occur, change the AF area mode setting to **Manual** or **Center** in **P, S, A, M, U 1** and **U 2** modes, refocus on another subject positioned at the same distance from the camera as the actual portrait subject, and use focus lock ( 29).
- Pictures that were shot using face priority will be rotated automatically when displayed in full-frame or thumbnail playback mode according to the orientation of the face.

Autofocus Mode

Set to **P, S, A** or **M** → MENU → **P, S, A, M** (shooting menu) (📖105) → Autofocus mode

Choose how the camera focuses.

Single AF (default setting)

Camera focuses when the shutter-release button is pressed halfway.

Full-time AF

Camera focuses continuously until the shutter-release button is pressed down halfway. Use with moving subjects.

Flash Exp. Comp.

Set to **P, S, A** or **M** → MENU → **P, S, A, M** (shooting menu) (📖105) → Flash exp. comp.

Flash compensation is used to adjust flash output by ± 2.0 EV in increments of $1/3$ EV, changing the brightness of the main subject relative to the background.

-0.3 to -2.0

Flash output is reduced from -0.3 to -2.0 EV, in increments of $1/3$ EV, to prevent unwanted highlights or reflections.

0.0 (default setting)

Flash output is not adjusted.

+0.3 to +2.0

Flash output is increased from $+0.3$ to $+2.0$ EV, in increments of $1/3$ EV, to make the main subject of the frame appear brighter.

At settings other than **0.0**, the icon for the current setting is displayed in the monitor (📖8).

NR Noise Reduction

Set to **P, S, A** or **M** → MENU → **P, S, A, M** (shooting menu) (📖105) → Noise reduction

At slow shutter speeds, pictures may be affected by “noise” in the form of randomly-spaced, brightly-colored dots concentrated in dark parts of the image. Use this option to reduce noise at slow shutter speeds. Enabling noise reduction increases the time needed to record pictures after they are shot.

AUTO Auto (default setting)

Noise reduction is performed at slow shutter speeds, likely to result in pictures affected by noise.

NR On

Noise reduction is applied to pictures shot at shutter speeds of 1/4 s or slower. Switching this to **On** is recommended when shooting at slow shutter speeds.

- **Multi-shot 16** cannot be used when noise reduction is set to **On**.

When noise reduction is performed, the **NR** icon is displayed in the monitor during shooting (📖8).

DC Distortion Control

Set to **P, S, A** or **M** → MENU → **P, S, A, M** (shooting menu) (📖105) → Distortion control

Specify whether or not the distortion is corrected. Enabling distortion control reduces the size of the frame, as compared to distortion control not being enabled.

DC On

Distortion at frame peripheries caused by the characteristics of the lens is corrected.

- When **On** is selected for **Distortion control**, the setting for **Continuous** will be changed to **Single**, and **Auto bracketing** will be changed to **Off**.
- **Distortion control** does not function when shooting using **Blink proof**, even if **On** is selected.

OFF Off (default setting)

No distortion correction performed.

At settings other than **Off**, the icon for the current setting is displayed in the monitor (📖8).

Functions that Cannot be Applied Simultaneously

Restrictions apply to the following settings in **P**, **S**, **A**, **M**, **U1** and **U2** modes.

Flash mode

- Flash mode is disabled (🚫) when ▲ (infinity) is selected for focus mode, **Continuous**, **BSS**, or **Multi-shot 16** is selected for **Continuous**, or when any mode other than **Off** is enabled for **Auto bracketing**.
- Applied setting is restored when any mode other than ▲ (infinity) is selected for focus mode, **Single** or **Intvl timer shooting** is selected for **Continuous**, or **Off** is selected for **Auto bracketing**.

Self-timer/Smile timer/Blink proof

- If self-timer, 😊 (smile timer) or 🙄 (blink proof) is set, **Continuous** will be set to **Single**, and **Auto bracketing** will be set to **Off**.
- The **Continuous** and **Auto bracketing** settings are restored when self-timer, 😊 (smile timer) or 🙄 (blink proof) is disabled, (or when shooting with the self-timer or smile timer has finished).
- For shooting modes **P**, **S**, **A**, **M**, **U1** and **U2** blink proof cannot be used if **B&W + color** is enabled for the **Black-and-white** option of **Optimize image**.

Focus mode

- When 😊 (smile timer) or 🙄 (blink proof) is set while the focus mode setting is set to ▲ (infinity), 📷 (macro close-up) or MF, the focus mode setting will be changed to FF.
- When **Face priority** is selected for **AF area mode**, setting focus mode to ▲ (infinity) changes the AF area mode setting to **Auto**. Selecting an option other than ▲ (infinity) for focus mode restores the AF area mode setting to **Face priority**.

Optimize image

- White balance** is automatically set to **Auto** when **Black-and-white** is selected for **Optimize image**. The last **White balance** setting applied is restored when any setting other than **Black-and-white** is selected for **Optimize image**.
- Enabling the **B&W + color** option for the **Black-and-white** item in the **Optimize image** menu changes the **Continuous** setting to **Single** and the **Auto bracketing** setting to **Off**. These **Continuous** and **Auto bracketing** settings do not change even when the **B&W + color** option is disabled.
- When an option other than **Off** is selected for **Active D-Lighting**, the **Contrast** option in the **Custom** and **Black-and-white** → **Custom** settings will be changed to **Auto**.

ISO sensitivity

- When **ISO sensitivity** is set to **3200** or **6400**, **Image size** cannot be set to **4000×3000**, **3264×2448**, **2592×1944**, **3984×2656**, **3968×2232** and **2992×2992**.

At these image size settings, selecting **3200** or **6400** for **ISO sensitivity** automatically switches the Image size setting to **2048×1536**. The last image size setting applied is restored when any setting other than **3200** or **6400** is selected for **ISO sensitivity**.

- When **ISO sensitivity** is set to **High ISO sensitivity auto** or **1600** and higher, the setting for active D-Lighting will be changed to **Off**.

Metering

When an option other than **Off** is selected for **Active D-Lighting**, the setting for **Metering** will be changed to **Matrix**.

Continuous

- When an option other than **Single** is selected for **Continuous**, the setting for **Auto bracketing** will be changed to **Off**.
- Selecting **Multi-shot 16** will fix the **Image quality** setting to **Normal** and **Image size** setting to **2592×1944**.
- **ISO sensitivity** will be set automatically according to the brightness when shooting mode **P**, **S**, or **A** is used. The setting for **ISO sensitivity** will be fixed at 400 for shooting mode **M**.
- When an option other than **Multi-shot 16** is selected for **Continuous**, the original settings for **Image quality**, **Image size** and **ISO sensitivity** will be restored.

Auto bracketing

When an option other than **Off** is selected for **Auto bracketing**, the setting for **Continuous** will be changed to **Single**, and the flash mode setting will be changed to .

AF area mode

- When **Spot AF area** is selected for **Metering**, setting **AF area mode** to **Center** changes the **Metering** setting to **Matrix**.
- When an option other than **Center** is selected for **AF area mode**, the setting for **Metering** will be changed back to **Spot AF area**.

Noise reduction











When **Multi-shot 16** is selected for **Continuous** and **Noise reduction** is set to **On**, **Continuous** will change to **Single**.

Distortion control

- When **On** is selected for **Distortion control**, the setting for **Continuous** will be changed to **Single**, and **Auto bracketing** will be changed to **Off**. Even when the **Distortion control** option is disabled (**Off**), the **Continuous** and **Auto bracketing** settings do not change.
- **Distortion control** does not function when shooting using (blink proof), even if **On** is selected.

Playback Options: The Playback Menu

The playback menu contains the following options.

	Quick retouch 📖75
Easily create retouched images in which contrast and saturation have been enhanced.	
	D-Lighting 📖76
Enhances brightness and contrast in dark portions of pictures.	
	Print set 📖103
Select pictures to print and the number of copies for each.	
	Slide show 📖131
View pictures stored in the internal memory or on a memory card in an automatic slide show.	
	Delete 📖132
Delete selected or all pictures.	
	Protect 📖132
Protect selected pictures from accidental deletion.	
	Rotate image 📖133
Change the orientation of an existing picture.	
	Hide image 📖133
Hide selected pictures during playback.	
	Small picture 📖78
Create a small copy of the current picture.	
	Copy 📖134
Copy files between memory card and internal memory.	
	Black border 📖79
Create the new picture surrounding with black border.	

Displaying the Playback Menu

Display the playback menu by pressing the **MENU** button and choosing the  tab (📖113).

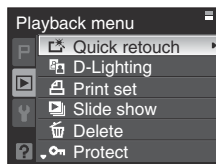
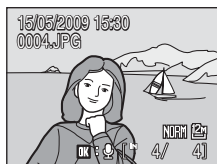

- Press the multi selector to select items and set functions on menus (📖12).
- To exit the playback menu, press the **MENU** button.

Selecting Pictures

The picture selection screen, as shown at right, will be displayed with the following menus:

- **Playback menu:**

- Quick retouch* (📖75),
- D-Lighting* (📖76),
- Select images** in Print set (📖103),
- Erase selected images** in Delete (📖132),
- Protect (📖132),
- Rotate image (📖133),
- Hide image (📖133),
- Small picture* (📖78),
- Selected images** in Copy (📖134),
- Black border* (📖79)

- **Setup menu:** Welcome screen (📖137)

* These will be displayed if menu items are selected when the playback menu has been displayed from a mode other than playback mode (📖13).

Follow the procedure described below to select pictures.



1 Press the multi selector ◀ or ▶ to choose the desired picture.

- The command dial can also be used in place of pressing ◀ or ▶ on the multi selector.
- Only one picture can be selected for **Quick retouch**, **D-Lighting**, **Rotate image**, **Small picture**, **Black border** and **Welcome screen**. Proceed to step 3.
- Rotate the zoom control to **T** (📄) to switch to full-frame playback, or **W** (📄) to switch to 12 thumbnails display.



2 Press ▲ or ▼ to select ON or OFF (or the number of copies).

- When ON is selected, a check mark is displayed in the current picture. Repeat steps 1 and 2 to select additional pictures.



3 Press the Ⓞ button to apply picture selection.

Slide Show

Press the **MENU** button →  (Playback menu) (📖129) →  Slide show

Playback pictures, stored in the internal memory or on a memory card, one by one in an automated “slide show.”



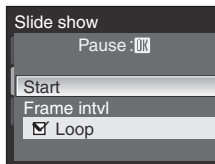

1 Use the multi selector to choose **Start** and press the **OK** button.

- To change the interval between pictures, choose **Frame intvl**, select the desired interval time, and press the **OK** button before choosing **Start**.
- To repeat the slide show automatically, enable **Loop** and press the **OK** button before choosing **Start**. The check mark (✓) will be added to the loop option when enabled.



2 The slide show begins.

While the slide show is in progress, the following operations can be performed:

- Press the multi selector  to view pictures in the order recorded, or  to view pictures in reverse order. Press and hold  to fast forward, or  to rewind.
- Press the **OK** button to pause the slide show.



3 Choose End or Restart.

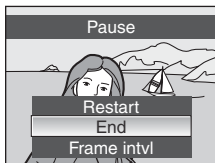

- When the slide show ends or is paused, choose **End** and press the **OK** button to return to the playback menu. Choose **Restart** to play the slide show again.



Notes on Slide Show

- Only the first frame of movies (📖86) included in slide shows is displayed.
- Slide shows play for a maximum of 30 minutes, even when **Loop** is selected (📖146).

Delete

Press the **MENU** button →  (Playback menu) (📖129) →  Delete

Delete selected or all pictures.

Erase selected images

Delete selected pictures (see “Selecting Pictures” (📖130) for more information).



Erase all images

Delete all pictures.

Notes on Deletion

- Once deleted, pictures cannot be recovered. Transfer important images to a computer before deletion.
- Pictures marked with the  icon are protected and cannot be deleted.

Protect

Press the **MENU** button →  (Playback menu) (📖129) →  Protect

Protect selected pictures from accidental deletion.

Select the picture and apply the setting in the picture selection screen (see “Selecting Pictures” (📖130) for more information).

Note, however, that formatting the camera’s internal memory or the memory card will permanently erase protected files (📖147).

Protected pictures are recognized by the  icon in playback mode (📖9, 72).

Rotate Image

Press the **MENU** button →  (Playback menu) (📖129) →  Rotate image

Change the orientation of pictures played back in the camera's monitor after shooting. Pictures can be rotated 90° clockwise or counterclockwise.

Pictures that were recorded in the portrait (vertical) orientation can be rotated up to 180° in either direction.

Select a picture in the picture selection screen (📖130), and press the **OK** button to display the rotate image screen. Press the multi selector ◀ or ▶ to rotate the picture 90°.

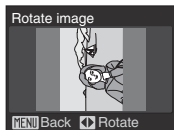

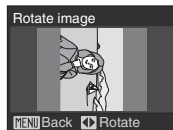
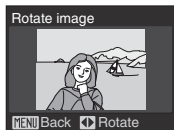

Rotate 90°
counterclockwise



Rotate 90°
clockwise

Press the **OK** button to set the orientation displayed, and save the orientation data with the picture.

Hide Image

Press the **MENU** button →  (Playback menu) (📖129) →  Hide image

Hide selected pictures during playback.

Select the picture and apply the setting in the picture selection screen (see "Selecting Pictures" (📖130) for more information).



Hidden pictures cannot be deleted using the **Delete** option. Note, however, that formatting the camera's internal memory or the memory card will permanently erase hidden files (📖147).

Copy

Press the **MENU** button →  (Playback menu) (📖129) →  Copy

Copy pictures between the internal memory and a memory card.

1 Use the multi selector to select an option from the copy screen and press the  button.

- : Copy pictures from internal memory to memory card.
- : Copy pictures from memory card to internal memory.

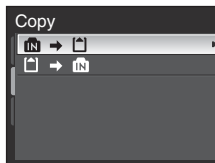

2 Select a copy option and press the  button.

- **Selected images:** Copy pictures selected from the picture selection screen (📖130).
- **All images:** Copy all pictures.

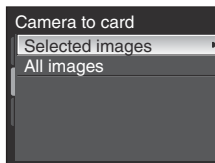

Notes on Copying Pictures

- JPEG-, AVI-, and WAV-format files can be copied. Files recorded in any other format cannot be copied.
- If voice memos (📖80) are attached to pictures selected for copying, voice memos are copied with the pictures.
- Sound files recorded using voice recording (📖87) can be copied using the **Copy sound files** option (📖91).
- Pictures recorded with another make or model of camera or that have been modified on a computer cannot be copied.
- Edited copies have the same protection marking (📖132) as the original, but are not marked for printing (📖103).
- Hidden pictures (📖133) cannot be copied.

Memory contains no images. Message



































If there are no pictures stored on the memory card when playback mode is applied, the message, **Memory contains no images.**, will be displayed. Press the **MENU** button to display the copy option screen, and copy the pictures stored in the camera's internal memory to the memory card.

More Information

See "File and Folder Names" (📖156) for more information.

Basic Camera Setup: The Setup Menu

The setup menu contains the following options.

	Welcome screen  137
	Select screen displayed when camera is turned on.
	Date  138
	Set camera clock and choose home and destination time zones.
	Monitor settings  141
	Adjust post-shooting image review, and monitor brightness settings.
	Date imprint  142
	Imprint the date on pictures.
	Vibration reduction  143
	Choose whether or not vibration reduction is enabled when taking still pictures.
	Motion detection  144
	Enable motion detection to reduce the effects of camera shake and subject movement when shooting still pictures.
	AF assist  145
	Enable or disable AF-assist illumination.
	Digital zoom  145
	Enable or disable digital zoom.
	Sound settings  146
	Adjust sound settings.
	Auto off  146
	Set time before camera enters standby mode.
	Format memory/Format card  147
	Format internal memory or memory card.
	Language  148
	Choose language used for camera monitor display.
	Video mode  148
	Adjust settings necessary for connection to TV.
	Blink warning  149
	Choose whether or not to detect blinking human subjects when shooting pictures using face priority.
	Reset all  151
	Restore camera settings to default values.
	Reset file numbering  154
	Reset the file numbering.
	Firmware version  154
	Display camera firmware version.

Displaying the Setup Menu

Choose the **Y** tab in the menu screen.

- 1 Press the **MENU** button to display the menu screen.

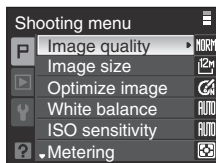

- 2 Press **◀** on the multi selector.

- Tab will be selectable.

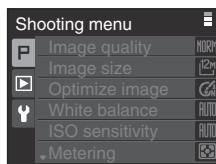

- 3 Press **▲** or **▼** to select the **Y** tab.

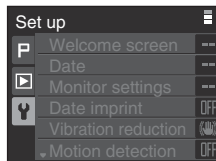

- 4 Press **▶** or the **OK** button.

- The setup menu items will be selectable.
- Press the multi selector to select items and set functions on menus (12).
- To exit the setup menu, press the **MENU** button or **◀** to select the shooting or playback tabs.

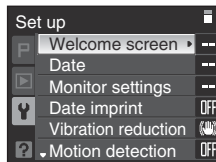

Welcome Screen

Press the **MENU** button →  (Setup menu) (📖135) → Welcome screen

You can select the welcome screen to be displayed when the camera is turned on.

None (default setting)

Welcome screen is not displayed.



COOLPIX

Displays a welcome screen.



Select an image

Select a picture in the internal memory or on the memory card for the welcome screen. Choose a picture in the picture selection screen (📖130), and press the **OK** button.

As the selected picture is stored in the camera, the picture will appear in the welcome screen even if the original picture is deleted.

- Pictures shot with **Image size** (📖108) of  **3984×2656**,  **3968×2232**, and  **2992×2992** and pictures shot on **Continuous H (16:9)** setting (📖58) cannot be saved.
- Pictures reduced to 160 × 120 or smaller through cropping (📖77) and small picture editing (📖78), cannot be selected.

Date





Press the **MENU** button →  (Setup menu) ( 135) → Date

Set the camera clock and choose home and travel destination time zones.

Date



Set camera clock to current date and time.

Use the following controls to set the date and time.

-  : highlight a different item (day, month, year, hour, minute, and the order in which day, month, and year are displayed)
-  : edit the highlighted item
-  button: apply the setting

Time zone

 (home time zone) can be specified and daylight saving enabled or disabled from time zone options.

When  (travel destination) is selected, the time difference ( 140) between the home time zone () is automatically calculated and the date and time in the selected region are recorded. Useful when travelling.

Setting the Travel Destination Time Zone

- 1 Use the multi selector to choose **Time zone** and press the  button.

- The time zone screen is displayed.

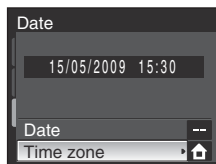

- 2 Choose  **Travel destination** and press the  button.

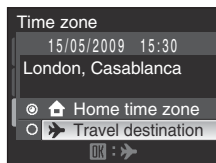

- The date and time displayed on the monitor changes according to the region currently selected.

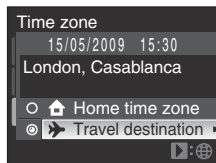

3 Press **▶**.

- The time zone selection screen is displayed.

**4** Press **◀** or **▶** to choose the travel destination time zone.

- Pressing **▲** in a time zone where daylight saving is in effect will display the  icon on the top of the screen. Daylight saving will be turned on and the time will advance by one hour. To turn off the daylight saving time option, press **▼**.
- Press the **OK** button to choose the travel destination time zone.
- While the travel destination time zone is selected, the  icon will be displayed in the monitor when the camera is in shooting mode.

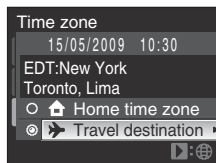
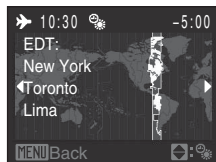
**✓ The Backup Battery**

The camera's internal clock uses a different battery from the camera's battery. The backup battery charges when the main battery is installed or the AC adapter is connected, and provides several days of backup power after about ten hours of charging.

✎ Home Time Zone

- To switch to the home time zone, choose **Home time zone** in step 2 and press the **OK** button.
- To change the home time zone, choose **Home time zone** in step 2 and perform the steps for **Travel destination** to set the home time zone.

✎ Daylight Saving Time

When daylight saving time starts or ends, turn the daylight saving time option on or off from the time zone selection screen displayed in step 4.

Basic Camera Setup: The Setup Menu



Time Zones (📖20)

The camera supports the time zones listed below.

For time differences not listed below, set the camera clock using **Date**.

UTC +/-	Location	UTC +/-	Location
-11	Midway, Samoa	+1	Madrid, Paris, Berlin
-10	Hawaii, Tahiti	+2	Athens, Helsinki, Ankara
-9	Alaska, Anchorage	+3	Moscow, Nairobi, Riyadh, Kuwait, Manama
-8	PST (PDT): Los Angeles, Seattle, Vancouver	+4	Abu Dhabi, Dubai
-7	MST (MDT): Denver, Phoenix	+5	Islamabad, Karachi
-6	CST (CDT): Chicago, Houston, Mexico City	+5.5	New Delhi
-5	EST (EDT): New York, Toronto, Lima	+6	Colombo, Dhaka
-4	Caracas, Manaus	+7	Bangkok, Jakarta
-3	Buenos Aires, Sao Paulo	+8	Beijing, Hong Kong, Singapore
-2	Fernando de Noronha	+9	Tokyo, Seoul
-1	Azores	+10	Sydney, Guam
±0	London, Casablanca	+11	New Caledonia
		+12	Auckland, Fiji

Monitor Settings

Press the **MENU** button →  (Setup menu) (135) → Monitor settings

Change the settings for the options below.

Image review

On (default setting): Picture is automatically displayed in the monitor immediately after it is taken and the monitor display returns to shooting mode.

Off: Picture is not displayed after it is taken.

Brightness

Choose from five settings for monitor brightness. The default setting is **3**.

Date Imprint

Press the **MENU** button →  (Setup menu) (📖135) → **Date imprint**

Date and time of recording can be imprinted on pictures. This information can be printed even from printers that do not support printing of date and time (📖104).

Off (default setting)

Date and time are not imprinted on pictures.

Date



Date is imprinted on the bottom right corner of pictures taken while this option is in effect.

Date and time

Date and time are imprinted on the bottom right corner of pictures taken while this option is in effect.

At settings other than **Off**, the icon for the current setting is displayed in the monitor (📖8).

Date Imprint

- Imprinted dates form a permanent part of image data and cannot be deleted.
- Dates imprinted at an **Image size** (📖108) setting of  **640×480** may be difficult to read. Choose  **1024×768** or larger when using date imprint.
- The date is recorded using the format selected in the setup menu's **Date** option (📖20, 138).
- Dates cannot be imprinted in the following situations (📖167).
 - When **Museum** or **Panorama assist** is selected for scene mode
 - When **Continuous** or **BSS** is selected for **Continuous** (📖118)
 - When **Auto bracketing** (📖121) is set to any setting other than **Off**
 - When  (blink proof) (📖55) is selected
 - When sport continuous mode is selected
 - Movie mode

Date Imprint and Print Set

When printing from DPOF-compatible printers which support printing of shooting date and photo information, the date and information can be printed on pictures without the date and time being imprinted on them, using options in the **Print set** menu (📖103).

Vibration Reduction

Press the **MENU** button →  (Setup menu) (135) → Vibration reduction

Specify the vibration reduction setting for taking still pictures.

Vibration reduction effectively corrects blur, caused by slight hand movement known as camera shake, that commonly occurs when shooting with zoom applied or at slow shutter speeds.

Set Vibration reduction to **Off** when using a tripod to stabilize the camera during shooting.

On (default setting)

Vibration reduction is enabled when shooting still pictures. Camera detects and factors out panning movements when reducing camera shake. When camera is panned horizontally, for example, vibration reduction reduces only vertical shake. If camera is panned vertically, vibration reduction affects only horizontal shake.

Off



Vibration reduction is not enabled.

When vibration reduction is enabled, the current setting is displayed during shooting (when **Off** is selected, an icon for the current setting is not displayed) (8).



Notes on Vibration Reduction

- Vibration reduction may take a few seconds to activate after the power is turned on or the camera enters shooting mode from playback mode. Wait until the display stabilizes before shooting.
- Due to characteristics of the vibration reduction function, images displayed in the camera's monitor immediately after shooting may appear blurry.
- Vibration reduction may be unable to completely eliminate the effects of camera shake in some situations.

Compensating Movies with Electronic VR

To reduce the effects of camera shake when recording movies other than time-lapse movies, enable **Electronic VR** (84) from the movie menu (82).

Motion Detection

Press the **MENU** button →  (Setup menu) ( 135) → Motion detection

Enable motion detection to reduce the effects of camera shake and subject movement when shooting still pictures.

Auto

When camera detects the movement of the subject or camera shake, the shutter speed will be increased for reducing the effects of them.

However, motion detection does not function in the following situations.

- When fill flash is used
- When specific scene modes are used ( 41 to 47)
- When shooting modes **P**, **S**, **A**, **M**, **U1** or **U2** is used
- When sport continuous mode is selected.

Off (default setting)

Motion detection will not be applied.

When motion detection is enabled, the current setting is displayed during shooting (when **Off** is selected, an icon for the current setting is not displayed) ( 8).

The motion detection icon will glow green when the camera detects any vibration and increases the shutter speed.

Notes on Motion Detection

- Motion detection may be unable to completely reduce effects of camera shake and subject movement in some situations.
- Motion detection may not function if the subject exhibits significant movement or is too dark.
- The pictures taken may become somewhat grainy.

AF Assist

Press the **MENU** button → **Y** (Setup menu) (📖135) → AF assist

Enable or disable AF-assist illumination.

Auto (default setting)

AF-assist illumination will be used to assist the focus operation when the subject is poorly lit. The illuminator has a range of about 4 m (13 ft.) at the maximum wide-angle position and about 2.2 m (7 ft. 2 in.) at the maximum telephoto position. However, note that for some scene modes, AF-assist illumination turns off automatically (📖41 to 46) even if **Auto** is set.

Off

Disable this function. The camera may be unable to focus if lighting is poor.

Digital Zoom

Press the **MENU** button → **Y** (Setup menu) (📖135) → Digital zoom

Enable or disable digital zoom.

On (default setting)

When the camera is zoomed in to the maximum optical zoom position, rotating and holding the zoom control at **T** (📖) triggers digital zoom (📖27).



Crop

Limit digital zoom to the range at which image quality does not degrade.



Off

Digital zoom will not be activated (except when shooting a movie).

Notes on Digital Zoom

- When digital zoom is in effect, AF area mode is set to **Center** (📖122).
- Digital zoom cannot be used in the following situations.
 - When the focus mode (📖36) is set to **MF** (manual focus)
 - When  (smile timer) or  (blink proof) (📖54) is used
 - When **Portrait**, **Night portrait** or **Fireworks show** is selected for scene mode
 - When scene auto selector mode is selected
 - When **Multi-shot 16** is selected in **Continuous** (📖118) mode
 - Before beginning to record a movie (digital zoom of up to 2x can be used during recording of a movie, except for time-lapse movies)
- At magnifications of 1.2x to 1.8x, **Metering** is set to **Center-weighted**, and at magnifications of 2.0x to 4.0x, its set to **Spot**.

Sound Settings

Press the MENU button →  (Setup menu) (135) → Sound settings

Adjust the following sound settings.

Button sound

Turn button sound **On** (default setting) or **Off**. A beep will sound once when operations are completed successfully, twice when the camera acquires focus on the subject, and three times when an error is detected. Start-up sound will also play when the camera is turned on.

Shutter sound

Choose shutter sound from **On** (default setting) or **Off**.

Auto Off

Press the MENU button →  (Setup menu) (135) → Auto off

If no operations are performed for the selected length of time, the monitor will turn off and the camera enters standby mode (19) to reduce drain on the batteries.

The power-on lamp blinks in standby mode. If no operations are performed for another three minutes, the camera will turn off automatically.

Choose the time allowed to elapse before the camera enters standby mode if no operations are performed from **30 s**, **1 min** (default setting), **5 min**, and **30 min**.

Canceling Standby Mode

Cancel standby mode and reactivate the monitor by pressing the power switch, shutter-release button or the  button, or by rotating the mode dial.

Notes on Auto Off

The time taken for the monitor to enter standby mode is as follows.

- When menus are displayed: three minutes
- During slideshow playback: maximum of 30 minutes
- When the AC adapter is connected: 30 minutes

Format Memory/Format Card

Press the **MENU** button → **Y** (Setup menu) (📖135) → **Format memory/Format card**

Use this option to format the internal memory or a memory card.

Formatting the Internal Memory

To format the internal memory, remove the memory card from the camera. The **Format memory** option appears in the setup menu.

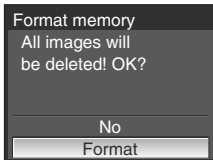

Formatting a Memory Card

When the memory card is inserted in the camera, the **Format card** option appears in the setup menu.

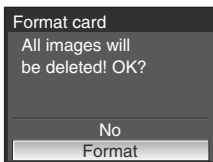

Formatting Internal Memory and Memory Cards

- Formatting the internal memory or memory cards permanently deletes all data. Be sure to transfer important pictures to a computer before formatting.
- Do not turn the camera off, disconnect the AC adapter, or open the battery-chamber/memory card slot cover during formatting.
- The first time you insert the memory cards used in other devices into this camera, be sure to format them with this camera.

Language

Press the **MENU** button →  (Setup menu) (📖135) → Language

Choose one of 24 languages for display of camera menus and messages.

Čeština	Czech
Dansk	Danish
Deutsch	German
English	(default setting)
Español	Spanish
Ελληνικά	Greek
Français	French
Indonesia	Indonesian
Italiano	Italian
Magyar	Hungarian
Nederlands	Dutch
Norsk	Norwegian

Polski	Polish
Português	Portuguese
Русский	Russian
Suomi	Finnish
Svenska	Swedish
Türkçe	Turkish
عربي	Arabic
中文简体	Simplified Chinese
中文繁體	Traditional Chinese
日本語	Japanese
한글	Korean
ภาษาไทย	Thai

Video Mode



Press the **MENU** button →  (Setup menu) (📖135) → Video mode

Adjust settings for connection to TV.

Choose **NTSC** or **PAL**.

Blink Warning

Press the **MENU** button →  (Setup menu) (📖135) → **Blink warning**

Set whether or not to detect human subjects with eyes closed when shooting pictures using face priority (📖123) in any mode other than  smile timer/ blink proof (📖54).

On (default setting)

When the camera detects that one or more human subjects have closed their eyes shortly after recognizing the faces and shooting them, the **Did someone blink?** screen will appear on the monitor.



The face of the human subject that may have closed his/her eyes is framed by a yellow border. You can check the picture taken and determine if you need to take the picture again.

See "Operating the Did someone blink? Screen" (📖150) for more information.



Off

Blink warning doesn't take effect.

Notes on Blink Warning







- The camera does not perform blink warning in the following cases.
 - When  (smile timer) (📖54) is used
 - When **Continuous, BSS, Multi-shot 16** or **Intvl timer shooting** is selected for **Continuous**
 - When focus mode is set to  (macro close-up)
- When  (blink proof) is used for shooting, the setting for **Blink warning** is ignored and whenever smiling faces are detected, the camera takes two pictures and chooses an image in which the subjects' eyes are open.

Operating the Did someone blink? Screen

When the **Did someone blink?** screen appears on the monitor while shooting using any modes other than  (smile timer)/  (blink proof) ( 55), the following operations can be performed.

If no operations are performed for a few seconds, the screen automatically returns to the shooting mode screen.



To	Use	Description
Enlarge and display the detected face	T (Q)	Rotate the zoom control to T (Q).
Return to full-frame playback	W (📐)	Rotate the zoom control to W (📐).
Select the face to be displayed		If the camera detects more than one human subject blinking, press ◀ or ▶ during playback zoom to display other faces.
Delete the picture taken		Press the  button.
Return to shooting mode		Press the  button or the shutter-release button.
		

Reset All

Press the **MENU** button →  (Setup menu) (📖135) → Reset all

When **Reset** is selected, the camera's settings will be restored to their default values.

Pop-up Menu

Option	Default value
Flash mode (📖32)	Auto
Self-timer/Smile timer/Blink proof (📖35, 54)	OFF
Focus mode (📖36)	Autofocus
Exposure compensation (📖39)	0.0

Shooting in the Scene Mode

Option	Default value
Scene menu (📖40)	Portrait
White balance in food mode (📖48)	Center

Movie Menu

Option	Default value
Movie options (📖82)	TV movie 640★
Time-lapse movie★ (📖84)	30 s
Autofocus mode (📖83)	Single AF
Electronic VR (📖84)	On

Sport Continuous Menu

Option	Default value
High speed continuous shooting (📖58)	Continuous H
Pre-shooting cache (📖58)	Off
Image quality (📖58)	Normal
Image size (📖58)	 2048×1536

Shooting Menu

Option	Default value
Image quality (📖107)	Normal
Image size (📖108)	 4000x3000
Optimize image (📖111)	Normal
Custom in Optimize image (📖112)	Contrast: Auto Image sharpening: Auto Saturation: Auto
Custom of Black-and-white in Optimize image (📖113)	Contrast: Auto Image sharpening: Auto Monochrome filter: None B&W + color: OFF
White balance (📖114)	Auto
ISO sensitivity (📖116)	Auto
Fixed range auto (📖116)	ISO 64-100
Metering (📖117)	Matrix
Continuous (📖118)	Single
Intvl timer shooting (📖119)	30 s
Auto bracketing (📖121)	Off
AF area mode (📖122)	Auto
Autofocus mode (📖125)	Single AF
Flash exp. comp. (📖125)	0.0
Noise reduction (📖126)	Auto
Distortion control (📖126)	Off
Active D-Lighting (📖70)	Off

Setup Menu

Option	Default value
Welcome screen (📖137)	None
Image review (📖153)	On
Brightness (📖153)	3
Date imprint (📖142)	Off
Vibration reduction (📖143)	On
Motion detection (📖144)	Off
AF assist (📖145)	Auto
Digital zoom (📖145)	On
Button sound (📖146)	On
Shutter sound (📖146)	On
Auto off (📖146)	1 min
Blink warning (📖149)	On

Others

Option	Default value
Paper size (📖99, 100)	Default
Slide show (📖131)	3 s

- Choosing **Reset all** also clears the current file number (📖156) from the memory. Numbering will continue from the lowest number available. If all pictures (📖132) are deleted before selecting **Reset all**, the file number for the next image taken will start from 0001.
- The following settings will not return to default settings even if **Reset all** is performed.
 - Shooting menu:** Preset manual data for **White balance** (📖115)
 - Setup menu:** **Date** (📖138), **Language** (📖148) and **Video mode** (📖148)
- User settings that were saved to the mode dial **U 1** and **U 2** modes will not be reset to default settings when **Reset all** is performed. To change these settings back to the default settings, use **Reset user settings** (📖69).

R Reset file numbering

Press the **MENU** button → **Y** (Setup menu) (📖135) → Reset file numbering

When **Yes** is selected, the sequential numbering of file numbers will be reset (📖156). After resetting, a new folder will be created and the file number for the next image taken will start from 0001.

✓ Notes on Reset file numbering

- **Reset file numbering** cannot be used when scene mode is set to **Panorama assist** or **Voice recording**, and if interval timer shooting is chosen for **Continuous** when **P, S, A, M, U 1** or **U 2** shooting modes are used. For **Panorama assist** and **Intvl timer shooting**, a new folder will be created, and file numbers will be assigned automatically starting with "0001." (📖156, 157).
- Reset file numbering cannot be applied when the folder number reaches 999 and there are images in the folder. Insert a new memory card, or format the internal memory/memory card.

Ver. Firmware Version

Press the **MENU** button → **Y** (Setup menu) (📖135) → Firmware version

View the current camera firmware version.

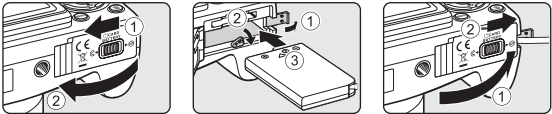

Optional Accessories

Rechargeable battery	Rechargeable Li-ion Battery EN-EL5
Battery charger	Battery Charger MH-61
AC adapter	<p>AC Adapter EH-62A (connect as shown)</p> <p>1 2 3</p>  <p>Ensure that the power connector cord passes through the opening before closing the battery-chamber/memory card slot cover. Failure to observe this precaution could cause damage to the battery-chamber/memory card slot cover.</p>
USB cable	USB Cable UC-E6
A/V cable	Audio Video Cable EG-CP14
Lens cap	Lens Cap LC-CP19

Approved Memory Cards

The following Secure Digital (SD) memory cards have been tested and approved for use in this camera.

- All cards of the designated make and capacity can be used, regardless of speed.

SanDisk	512 MB, 1 GB, 2 GB ^{*1} , 4 GB ^{*2} , 8 GB ^{*2} , 16 GB ^{*2}
TOSHIBA	512 MB, 1 GB, 2 GB ^{*1} , 4 GB ^{*2} , 8 GB ^{*2} , 16 GB ^{*2}
Panasonic	512 MB, 1 GB, 2 GB ^{*1} , 4 GB ^{*2} , 8 GB ^{*2} , 16 GB ^{*2}
Lexar	1 GB, 2 GB ^{*1} , 4 GB ^{*2} , 8 GB ^{*2}

*1 If the memory card will be used with a card reader or similar device, check that device supports 2 GB cards.

*2  SDHC-compliant. If the memory card will be used with a card reader or similar device, check that device supports SDHC.

Operation is not guaranteed with other makes of card. Contact the manufacturer for details on the above cards.

Refer to the Nikon website for the latest information on approved cards.

File and Folder Names

Pictures, movies, voice memos, and voice recordings are assigned file names as follows.

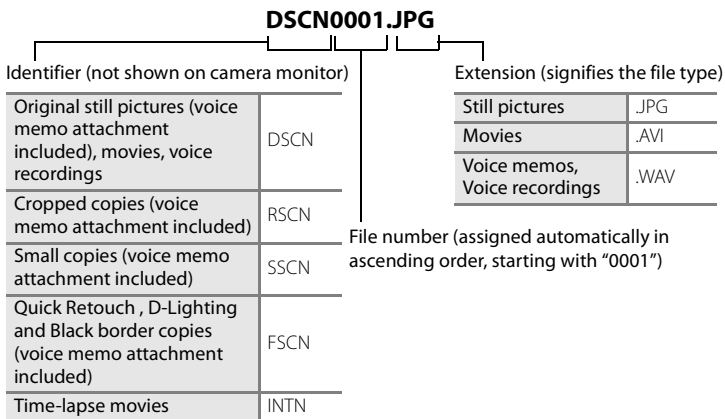

- Files are stored in folders named with a folder number followed by a five-character identifier: "P_" plus a three-digit sequence number for pictures shot using **Panorama assist** (e.g. "101P_001"; 📖50), "INTVL" for interval timer photography (e.g. "101INTVL"; 📖119), "SOUND" for voice recordings (e.g. "101SOUND"; 📖87), and "NIKON" for all other pictures (e.g. "100NIKON"). When the number of files within a folder reaches 9999 or reset the file number, a new folder will be created. File numbers will be assigned automatically starting with "0001."
- Voice memo file names have the same identifier and file number as the picture to which the voice memo is attached.
- Files copied using **Copy** → **Selected images** or **Copy sound files** → **Selected files** are copied to the current folder, where they are assigned new file numbers in ascending order starting from the largest file number in memory. **Copy** → **All images** and **Copy sound files** → **Copy all files** copy all folders from the source medium; file names do not change but new folder numbers are assigned in ascending order, starting from the largest folder number on the destination medium (📖91, 134).

- A single folder can hold up to 200 pictures; if the current folder already contains 200 pictures, a new folder, named by adding one to the current folder name, will be created the next time a picture is taken. If the current folder is numbered 999 and contains 200 pictures, or a picture is numbered 9999, no further pictures can be taken until the internal memory or memory card is formatted (📖147), or a new memory card is inserted.

Caring for the Camera

To ensure continued enjoyment of this Nikon product, observe the following precautions when using or storing the device.

Keep dry

The device will be damaged if immersed in water or subjected to high humidity.

Do not drop

The product may malfunction if subjected to strong shock or vibration.

Handle the lens and all moving parts with care

Do not apply force to the lens, lens cover, monitor, memory card slot or battery chamber. These parts are easily damaged. Applying force to the lens cover could result in camera malfunction or damage to the lens. Should the monitor break, care should be taken to avoid injury caused by broken glass and to prevent the liquid crystal from the display touching the skin or entering the eyes or mouth.

Do not point the lens at strong light sources for extended periods

Avoid pointing the lens at the sun or other strong light sources for extended periods when using or storing the camera. Intense light may cause deterioration of the CCD image sensor, producing a white blur effect in photographs.

Keep away from strong magnetic fields

Do not use or store this device in the vicinity of equipment that generates strong electromagnetic radiation or magnetic fields. Strong static charges or the magnetic fields produced by equipment such as radio transmitters could interfere with the monitor, damage data stored on the memory card, or affect the product's internal circuitry.

Avoid sudden changes in temperature

Sudden changes in temperature, such as when entering or leaving a heated building on a cold day, can cause condensation to form inside the device. To prevent condensation, place the device in a carrying case or a plastic bag before exposing it to sudden changes in temperature.

Turn the product off before removing or disconnecting the power source

Do not remove the battery while the product is on, or while images are being recorded or deleted. Forcibly cutting power in these circumstances could result in loss of data or in damage to product memory or internal circuitry.

 **The Battery**

- Check the battery level when taking the camera out, and charge the battery if necessary. Do not continue charging once the battery is fully charged, as this will result in reduced battery performance. If possible, carry a fully-charged spare battery when taking pictures on important occasions.
- Do not use the battery at ambient temperatures below 0 °C (32 °F) or above 40 °C (104 °F). Failure to observe this precaution could damage the battery or impair its performance.
- Charge indoors at an ambient temperature between 5 and 35 °C (41 to 95 °F). When the battery temperature is between 0 and 10 °C (32 to 50 °F) or 45 to 60 °C (113 to 140 °F), the chargeable capacity may decrease. The battery will not charge if its temperature is below 0 °C (32 °F) or above 60 °C (140 °F).
- If an exhausted battery is used at a low temperature, the camera may not turn on. Be sure that the battery is fully charged and spare batteries are prepared before heading outside to take pictures in cold weather. Keep spare batteries in a warm place and exchange as necessary. Once warmed, a cold battery that could not be used temporarily due to lowered performance may recover some of its charge.
- Should the battery terminals become dirty, the camera may not turn on due to poor contact. Wipe the terminals off with a clean, dry cloth before use.
- If the battery will not be used for some time, insert it in the camera and run it flat before removing it for storage. Attach the included terminal cover to the battery and store it in a cool location with an ambient temperature of 15 to 25 °C (59 to 77 °F). Do not store the battery in hot or extremely cold locations.
- While the battery is in storage, charge it at least once every six months and then use the camera to run it flat again before storing it in a cool location.
- Always remove the battery from the camera or battery charger when it is not being used. Left installed, minute amounts of current flow even when unused, and the battery may become excessively drained and no longer function.
- A marked drop in the time a fully-charged battery retains its charge, when used at room temperature, indicates that the battery needs to be replaced. Purchase a new battery.
- Replace the battery when it no longer holds a charge. Used batteries are a valuable resource. Please recycle used batteries in accordance with local regulations.

Cleaning

Lens/ electronic viewfinder	Avoid touching glass parts with your fingers. Remove dust or lint with a blower (typically a small device with a rubber bulb attached to one end that is pumped to produce a stream of air out the other end). To remove fingerprints or other stains that cannot be removed with a blower, wipe the lens with a soft cloth, using a spiral motion that starts at the center of the lens and working toward the edges. If this fails, clean the lens using a cloth lightly dampened with commercial lens cleaner.
Monitor	Remove dust or lint with a blower. To remove fingerprints and other stains, clean the monitor with a soft, dry cloth, being careful not to apply pressure.
Body	Use a blower to remove dust, dirt or sand, then wipe gently with a soft, dry cloth. After using the camera at the beach or seaside, wipe off any sand or salt with a dry cloth lightly dampened with fresh water, then dry thoroughly. Note that foreign matter inside the camera could cause damage not covered by the warranty.

Do not use alcohol, thinner, or other volatile chemicals.

Storage

Turn the camera off when not in use. Check that the power-on lamp is off before putting the camera away. Remove the battery if the camera will not be used for an extended period. Do not store the camera with naphtha or camphor moth balls, or in any of the following locations:

- Next to equipment that produces strong electromagnetic fields, such as televisions or radios
- Exposed to temperatures below -10 °C (14 °F) or above 50 °C (122 °F)
- Poorly ventilated or subject to humidities of over 60 %

To prevent mold or mildew, take the camera out of storage at least once a month. Turn the camera on and release the shutter a few times before putting the camera away again.



Notes on the Monitor

- The monitor may contain a few pixels that are always lit or that do not light. This is a characteristic common to all TFT LCD displays, and does not indicate a malfunction. Images recorded using the product will not be affected.
- Images in the monitor may be difficult to see under bright lighting.
- The monitor is lit by an LED backlight. Should the monitor begin to dim or flicker, contact your Nikon-authorized service representative.



Notes on Smear











When framing bright subjects, vertical comet-like streaks that whiten toward either end may appear in the display. This phenomenon, known as “smear”, does not indicate a malfunction.





In shooting modes other than Continuous H 16:9, Continuous H, multi-shot 16 or movie, smear has no effect on the images that are recorded.

When using the Continuous H 16:9, Continuous H, multi-shot 16 shooting and movie modes, however, we recommend that you avoid shooting bright objects.



Error Messages

















The following table lists the error messages and other warnings displayed in the monitor, as well as the solutions for dealing with them.

Display	Description	Solution	
 (blinks)	Clock not set.	Set clock.	138
	Battery is running low.	Prepare to charge or change battery.	16, 18
 Battery exhausted.	Battery exhausted.	Charge or change battery.	16, 18
 Battery temperature high	Battery temperature is high.	Turn off camera, and allow battery to cool down before resuming use. After five seconds, this message will disappear, the monitor will turn off, and the power-on lamp will blink rapidly. After the lamp blinks for three minutes, the camera will turn off automatically, but you can also press the power switch to turn it off manually.	19
 Memory card is write protected.	Write-protect switch is in "lock" position.	Slide the write-protect switch to "write" position.	23
 This card cannot be used.	Error accessing memory card.	<ul style="list-style-type: none"> • Use an approved card. • Check that connectors are clean. • Confirm that memory card is correctly inserted. 	155
 This card cannot be read.			22
 Card is not formatted. Format card? No Yes	Memory card has not been formatted for use in this camera.	Choose Yes and press the  button to format memory card.	23
 Out of memory.	Memory card is full.	<ul style="list-style-type: none"> • Choose lower image quality or smaller image size. • Delete pictures or sound files. • Replace memory card. • Remove memory card and use internal memory. 	107, 108 30, 86, 90, 132 22 22

Display	Description	Solution	
❗ Image cannot be saved.	Error occurred while recording picture.	Format internal memory or memory card.	147
	Camera has run out of file numbers.	<ul style="list-style-type: none"> Replace memory card. Format internal memory or memory card. 	22 147
	Picture cannot be used for welcome screen.	Pictures shot with Image size of  3984×2656 ,  3968×2232 , and  2992×2992 , pictures shot on Continuous H (16:9) setting, and copies created at a size of 160 × 120 or smaller using the crop or small picture function cannot be saved.	58, 77, 78, 107, 108
	There is insufficient space to save a copy.	Delete pictures from destination.	132
❗ Sound file cannot be saved.	Camera has run out of file numbers.	<ul style="list-style-type: none"> Replace memory card. Format internal memory or memory card. 	22 147
❗ One or more subjects may have closed their eyes.	An image that has blinking subjects detected in it was saved.	Check results in playback mode.	55
❗ Image cannot be modified.	Cannot edit selected picture.	<ul style="list-style-type: none"> Select a picture that supports quick retouch, D-Lighting, crop, small picture or black border. These options cannot be used with movies. 	74 -
❗ Cannot record movie.	Time out error while recording movie.	Choose memory card with faster write speed.	155
❗ Cannot reset file numbering.	No more folders can be created.	Insert a new memory card, or format the internal memory or memory card.	22, 147, 154
❗ Memory contains no images.	No pictures in the internal memory or memory card.	To copy image or sound files from internal memory to memory card, press the MENU button. Copy will be displayed.	134
❗ No sound file.	There are no sound files to be copied.	Check that the correct copy option has been selected.	89

Error Messages

Display	Description	Solution	
i File contains no image data.	File not created with this camera.	File cannot be viewed on this camera. View file using the computer or any other devices which was used to create or edit this file.	-
i This file cannot be played back.			
i All images are hidden.	The picture cannot be played back in a slide show.	-	131
	All images in the internal memory/memory card are hidden.	Disable the Hide image setting to view images.	133
i This image cannot be deleted.	Picture is protected.	Disable protection.	132
i Travel destination is in the current time zone.	Destination in same time zone as home.	-	140
i Mode dial is not in the proper position.	Mode dial is between two modes.	Rotate mode dial to select desired mode.	10
i Press the flash pop-up button to raise the flash.	The built-in flash is not raised during the Night portrait or Backlight scene modes.	Press the  (flash pop-up) button to raise the built-in flash.	33, 42, 46
i The flash is lowered.	The built-in flash is not raised during the scene auto selector mode.	Press the  (flash pop-up) button to raise the built-in flash. The camera can still shoot normally with the flash lowered if you do not wish to use it.	7, 52
i Lens error. (If the lens cap is attached, turn the camera off, remove the lens cap, and turn the camera on.)	Lens error.	Remove lens cap if still attached, and turn camera off and then on again. If error persists, contact retailer or Nikon-authorized service representative.	19
i Communications error	USB cable disconnected during printing.	Turn camera off and reconnect cable.	94, 98





Display	Description	Solution	
System error 	Error has occurred in camera's internal circuitry.	Turn camera off, remove and reinsert battery, and turn camera on. If error persists, contact retailer or Nikon-authorized service representative.	19
 Printer error: check printer status.	Printer error.	Check printer. After solving the problem, select Resume and press the  button to resume printing.*	-
 Printer error: check paper	Specified size of paper is not loaded in printer.	Load the specified type of paper, select Resume and press the  button to resume printing.*	-
 Printer error: paper jam	Paper has jammed in the printer.	Remove the jammed paper, select Resume and press the  button to resume printing.*	-
 Printer error: out of paper	No paper is loaded in the printer.	Load the specified type of paper, select Resume and press the  button to resume printing.*	-
 Printer error: check ink	Ink error.	Check ink, select Resume and press the  button to resume printing.*	-
 Printer error: out of ink	Ink cartridge is empty.	Replace ink, select Resume and press the  button to resume printing.*	-
 Printer error: file corrupt	An error caused by the image file has occurred.	Select Cancel and press the  button to cancel printing.	-



* See the documentation provided with your printer for further guidance and information.

Troubleshooting

If the camera fails to function as expected, check the list of common problems below before consulting your retailer or Nikon-authorized service representative. Refer to the page numbers in the right-most column for more information.

Display, Settings and Power Supply









Problem	Cause/Solution	
Monitor and electronic viewfinder are blank.	<ul style="list-style-type: none"> • Camera is off. • Battery is exhausted. • Standby mode for saving power: Press the power switch, shutter-release button or the  button, or rotate the mode dial to cancel standby mode. 	19 24 19, 31
	<ul style="list-style-type: none"> • Monitor and electronic viewfinder cannot be used simultaneously. Press the  button to alternate between displays. 	14
	<ul style="list-style-type: none"> • Camera and computer are connected via USB cable. • Camera and TV are connected via audio/video cable. • Time lapse movie recording in progress. 	93 92 84, 119
	<ul style="list-style-type: none"> • Ambient lighting too bright: use electronic viewfinder or move to darker location. • Adjust monitor brightness. • Monitor is dirty. Clean monitor. 	14 141 160
The electronic viewfinder is hard to read.	Adjust diopter adjustment control.	14
Display does not switch to monitor (or electronic viewfinder) when the  button is pressed.	<ul style="list-style-type: none"> • You cannot switch the display in the following situations: <ul style="list-style-type: none"> - While recording or playing back movies - While recording or playing back voice memos or voice recordings - While connected to a printer - While displaying image deletion screens • You cannot switch the display while displaying some error messages. 	81, 86 80, 87, 89 97 30, 31 162
	<ul style="list-style-type: none"> • Battery is exhausted. • Camera has turned off automatically to save power. • Battery is cold. 	24 19 159
	<ul style="list-style-type: none"> • Pictures recorded before clock was set, and "Date not set" indicator blinks during shooting, will have time stamp of "00/00/0000 00:00"; movies and voice recordings will be dated "01/01/09 00:00." Set the correct date and time using Date in the setup menu. • Check camera clock regularly against more accurate timepieces and reset as required. 	20, 138 138
	No indicators displayed in monitor.	Shooting data and photo information may be hidden. Press the DISP button until shooting data or photo information is displayed.











Problem	Cause/Solution	
Date imprint not available.	Date has not been set.	20, 138
Date not appearing on pictures even when Date imprint is enabled.	Dates cannot be imprinted in the following situations. <ul style="list-style-type: none"> • When Museum, or Panorama assist is selected in scene mode. • When Continuous or BSS is selected for Continuous • When any setting other than Off is selected for Auto bracketing • When  (blink proof) is selected • When sport continuous mode is selected • Movies 	45, 47 118 121 55 56 81
Camera settings reset.	Backup battery is exhausted; all settings were restored to their default values.	139
Reset file numbering cannot be done.	<ul style="list-style-type: none"> • Reset file numbering cannot be applied when the folder number reaches 999 and there are images in the folder. Change the memory card, or format the internal memory/memory card. • Reset file numbering cannot be done if scene mode is set to Panorama assist or Voice recording, and if Continuous is set to Intvl timer shooting when P, S, A, M, U 1 or U 2 shooting modes are used. 	154, 156 154, 156
Monitor turns off, and the power-on lamp blinks rapidly.	Battery temperature is high. Turn off camera, and allow battery to cool down before resuming use. After the lamp blinks for three minutes, the camera will turn off automatically, but you can also press the power switch to turn it off manually.	19

Electronically Controlled Cameras









In extremely rare instances, unusual characters may appear in the monitor and the camera may stop functioning. In most cases, this phenomenon is caused by a strong external static charge. Turn the camera off, remove and replace the battery, then turn the camera on again. In the event of continued malfunction, contact your retailer or Nikon-authorized service representative. Note that disconnecting the power source as described above may result in the loss of any data not recorded to internal memory or the memory card at the time the problem occurred. Data already recorded will not be affected.

Shooting

Problem	Cause/Solution	
No picture taken when shutter-release button is pressed.	<ul style="list-style-type: none"> When camera is in playback mode, press the  or shutter-release button. When menus are displayed, press the MENU button. Battery is exhausted. The built-in flash is not raised during the Night portrait or Backlight scene modes. When flash indicator blinks, flash is charging. 	<p>30</p> <p>13</p> <p>24</p> <p>33, 42, 46</p> <p>34</p>
Camera cannot focus.	<ul style="list-style-type: none"> The intended subject is one with which autofocus does not perform well. Set AF assist in the setup menu to Auto. Subject not in focus area when shutter-release button pressed halfway. The focus mode is set to MF (manual focus). Turn camera off and then on again. 	<p>29</p> <p>145</p> <p>28, 122</p> <p>36, 38</p> <p>24</p>
Pictures are blurred.	<ul style="list-style-type: none"> Use flash. Use vibration reduction and motion detection. Use BSS (Best Shot Selector). Use a tripod to stabilize the camera (use with the self-timer for best results). 	<p>32</p> <p>143</p> <p>118</p> <p>35</p>
Bright specks appear in pictures shot using flash.	Flash is reflecting off particles in air. Turn flash  (off).	32
Flash does not fire.	<ul style="list-style-type: none"> Flash is set to  (off). Some scene modes that cannot turn on flash are selected.  (blink proof) is selected. The focus mode is set to  (infinity). When sport continuous mode is selected.  mode is selected (excluding Time-lapse movie ) Continuous, BSS or Multi-shot 16 is selected for Continuous in shooting menu. When any setting other than Off is selected for Auto bracketing. 	<p>32</p> <p>40</p> <p>55</p> <p>36</p> <p>56</p> <p>81</p> <p>118</p> <p>121</p>
Optical zoom cannot be used.	Optical zoom cannot be used while recording movies.	81





Problem	Cause/Solution	
Digital zoom cannot be used.	<ul style="list-style-type: none"> • Off is selected for Digital zoom in the setup menu. • Digital zoom cannot be used in the following situations. <ul style="list-style-type: none"> - When focus mode is set to MF (manual focus) -  (smile timer) or  (blink proof) is being used - When Portrait, Night portrait or Fireworks show is selected for scene mode - When scene auto selector is chosen - When Multi-shot 16 is selected for Continuous - Before movie recording begins (digital zoom of up to 2x can be applied while movies, excluding Time-lapse movie ★ movies, are being recorded) 	145 36, 38 54, 55 41, 42, 46 52 118 81
Image size not available.	<ul style="list-style-type: none"> • Image size cannot be adjusted when Multi-shot 16 is selected for Continuous. • When ISO sensitivity is set to 3200 or 6400, or during sport continuous mode,  4000×3000,  3264×2448,  2592×1944,  3984×2656,  3968×2232 and  2992×2992 cannot be selected. • Image size cannot be adjusted when Continuous H (16:9) is selected. 	118 58, 116 58
No sound when shutter is released.	<ul style="list-style-type: none"> • Off is selected for Shutter sound of the Sound settings option in the setup menu. • Continuous, BSS, or Multi-shot 16 is selected for Continuous in shooting menu. • When any setting other than Off is selected for Auto bracketing. • When Museum is selected in scene mode. • Sport continuous mode is selected. •  mode is selected. • Do not block the speaker. 	146 118 121 45 56 81 5, 26
AF-assist illuminator does not light.	<ul style="list-style-type: none"> • Off is selected for AF assist in the setup menu. • AF-assist illuminator turns off automatically in some scene modes. 	145 145
Pictures appear smeared.	Lens is dirty. Clean lens.	160
Colors are unnatural.	White balance does not match light source.	114
Randomly spaced bright pixels ("noise") appear in image.	The subject is dark, so shutter speed is too slow or ISO sensitivity is too high. Noise can be reduced by: <ul style="list-style-type: none"> • Using flash. • Specifying a lower ISO sensitivity setting. • Applying Noise reduction in the shooting menu to suit situations. • Using a scene mode which has noise reduction ability. 	32 116 126 40

Troubleshooting

Problem	Cause/Solution	
Pictures are too dark (underexposed).	<ul style="list-style-type: none"> Flash is set to  (off). Built-in flash window is blocked. Subject is beyond flash range. Adjust exposure compensation. Raise the ISO sensitivity. Subject is backlit. Raise the built-in flash, set Backlight of the scene mode or set the flash mode to  (fill flash), and then shoot the picture. 	32 26 32 39 116 32, 46
Pictures are too bright (overexposed).	Adjust exposure compensation.	39
Unexpected results occurred when flash is set to auto with red-eye reduction.	When  (auto with red-eye reduction) or "fill flash with slow sync and red-eye reduction" of the Night portrait scene mode is applied during shooting, In-Camera Red-Eye Fix may, in very rare cases, be applied to areas not affected by red-eye. Set a flash mode other than  (auto with red-eye reduction), select a scene mode other than Night portrait , and resume shooting.	32, 42
Camera does not shoot with Multi-shot 16.	<ul style="list-style-type: none"> Self-timer,  (smile timer), or  (blink proof) has been set. Multi-shot 16 is not available when Noise reduction or Distortion control is set to On. Multi-shot 16 is not available when Black-and-white is chosen for Optimize image and B&W + color is enabled. Auto bracketing has been set. 	35, 54 126 113 121
The Contrast setting for the Optimize image options Custom and Black-and-white ( 113) → Custom cannot be adjusted.	A setting other than Off is selected for Active D-Lighting	70, 111

Playback

Problem	Cause/Solution	
File cannot be played back.	<ul style="list-style-type: none"> File was overwritten or renamed by computer or another make or model of camera. Time-lapse movie recording in progress. 	– 84, 119
Cannot zoom in on picture.	Playback zoom cannot be used with movies, small pictures, or cropped copies of size 320 × 240 pixels and below.	–

Problem	Cause/Solution	
Cannot record or play back voice memo.	<ul style="list-style-type: none"> Voice memos cannot be attached to movies. Voice memos cannot be attached to pictures taken by other cameras. Voice memos that are attached to the picture using other cameras cannot be played back on this camera. 	86 80
Cannot use quick retouch, D-Lighting, crop, small picture or black border options	<ul style="list-style-type: none"> These options cannot be used with movies. Editing other than Black border cannot be performed on pictures shot with Image size of  3984x2656,  3968x2232, and  2992x2992 and pictures shot on Continuous H (16:9) setting. Select a picture that supports quick retouch, D-Lighting, crop, small picture or black border. Pictures taken with another make or model of camera cannot be edited. Other cameras may be unable to play back, or transfer to a computer, pictures edited with this camera. 	86 58, 108 74 – –
Pictures not displayed on television.	<ul style="list-style-type: none"> The Video mode setting in Setup menu has not been set correctly. Memory card contains no pictures. Replace memory card. Remove memory card to play back pictures from internal memory. 	148 22
Nikon Transfer does not start when camera is connected.	<ul style="list-style-type: none"> Camera is off. Battery is exhausted. USB cable is not correctly connected. Camera is not recognized by the computer. Confirm that the operating system used is compatible with the camera. Computer is not set to launch Nikon Transfer automatically. For more information on Nikon Transfer, refer to help information contained in Nikon Transfer. 	24 24 94 – 93 –
Pictures to be printed are not displayed.	Memory card contains no pictures. Replace memory card. Remove memory card to print pictures from internal memory.	22
Cannot select paper size with camera.	Paper size cannot be selected from the camera if the printer does not support the paper sizes used by the camera or the printer automatically selects the page size. Use the printer to select page size.	99, 100

Specifications

Nikon COOLPIX P90 Digital Camera



Type	Compact digital camera
Effective pixels	12.1 million
Image sensor	1/2.33-in. CCD; total pixels: approx. 12.7 million
Lens	24x optical zoom, NIKKOR lens
Focal length	4.6-110.4mm (equivalent with 35mm [135] format picture angle: 26-624mm)
f/-number	f/2.8-5
Construction	14 elements in 11 groups
Digital zoom	Up to 4x (equivalent with 35mm [135] format picture angle: approx. 2496mm)
Vibration reduction	Image sensor shift (still pictures) Electronic (movies)
Autofocus (AF)	Contrast-detect AF, Multi area AF
Focus range (from lens)	<ul style="list-style-type: none">• [W]: 50 cm (1 ft. 8 in.) to ∞, [T]: 1.7 m (5 ft. 6 in.) to ∞• Macro close-up mode: 10 cm (4 in.) to ∞ (zoom position where  glows green); 1 cm (0.4 in.) to ∞ (zoom position at  mark)
Focus area	Face priority, auto (9-area automatic selection), center, manual with 99 focus areas
Electronic viewfinder	Color LCD viewfinder, 0.24-in. TFT LCD, approx. 230k-dot, with diopter adjustment function
Frame coverage (shooting mode)	Approx. 97% horizontal and 97% vertical (compared to the actual screen)
Frame coverage (playback mode)	Approx. 100% horizontal and 100% vertical (compared to the actual screen)
Monitor	3 in., approx. 230k-dot, TFT LCD Vari-angle monitor with anti-reflection coating and 5-level brightness adjustment, tiltable 45° downward, 90° upward
Frame coverage (shooting mode)	Approx. 97 % horizontal and 97 % vertical (compared to the actual screen)
Frame coverage (playback mode)	Approx. 100 % horizontal and 100 % vertical (compared to the actual screen)
Storage	
Media	Internal memory (approx. 47 MB), SD (Secure Digital) memory cards
File system	DCF, Exif 2.2, and DPOF compliant
File formats	Still pictures: Compressed: JPEG-Baseline compliant FINE (1:4), NORMAL (1:8), BASIC (1:16) Movies: AVI Sound files: WAV

Image size (pixels)	<ul style="list-style-type: none"> • 4000×3000 12 M • 2592×1944 5 M • 1600×1200 2 M • 1024×768 PC • 3984×2656 3:2 • 2992×2992 1:1 • 3264×2448 8 M • 2048×1536 3 M • 1280×960 1 M • 640×480 TV • 3968×2232 16:9 • 1920×1080 16:9 2M
ISO sensitivity (Standard output sensitivity)	<ul style="list-style-type: none"> • ISO 64, 100, 200, 400, 800, 1600, 3200, 6400 • Auto (auto gain from ISO 64 to 800) • High ISO Sensitivity auto (ISO 64 to 1600) • Fixed range auto (ISO 64 to 100, 64 to 200, 64 to 400) • Sport continuous mode (ISO 640 to 6400)
Exposure	
Metering	256-segment matrix, center-weighted, spot, spot AF area (with support for 99 focus areas)
Exposure control	Programmed auto exposure with flexible program, shutter priority auto, aperture-priority auto, manual, auto bracketing, motion detection, exposure compensation (-2.0 to +2.0 EV in steps of 1/3 EV)
Range (ISO 100)	[W]: -1 to +17.5 EV [T]: 0.7 to 17.6 EV
Shutter	Mechanical and charge-coupled electronic shutter
Shutter speed	1/2000-8 s, 1/4000-1/20 s (when shooting using Continuous H or Continuous H (16:9))
Aperture	Electronically-controlled 6-blade iris diaphragm
Range	10 steps of 1/3 EV
Self-timer	Can be selected from 10 and 2 second duration, smile timer, blink proof
Built-in flash	
Range (ISO sensitivity: Auto)	[W]: Approx. 0.5 to 8.0 m (1 ft. 8 in. to 26 ft.) [T]: Approx. 1.7 to 5.0 m (5 ft. 7 in. to 16 ft.)
Flash control	TTL auto flash with monitor preflashes
Interface	Hi-Speed USB
Data transfer protocol	MTP, PTP
Video output	Can be selected from NTSC and PAL
I/O terminal	Audio/video out; digital I/O (USB)
Supported languages	Arabic, Chinese (Simplified and Traditional), Czech, Danish, Dutch, English, Finnish, French, German, Greek, Hungarian, Indonesian, Italian, Japanese, Korean, Norwegian, Polish, Portuguese, Russian, Spanish, Swedish, Thai, Turkish
Power sources	One Rechargeable Li-ion Battery EN-EL5 (supplied) AC Adapter EH-62A (optional)
Battery life*	Approx. 200 shots (EN-EL5)

Specifications

Dimensions (W × H × D)	Approx. 114 × 83 × 99 mm (4.5 × 3.3 × 3.9 in.) (excluding projections)
Weight	Approx. 460 g (16.2 oz) (without battery and SD memory card)
Operating environment	
Operating temperature	0 to 40 °C (32 to 104 °F)
Humidity	85 % and below (no condensation)

- Unless otherwise stated, all figures are for a camera with a fully-charged Rechargeable Li-ion Battery EN-EL5 operated at an ambient temperature of 25 °C (77 °F).
- * Based on Camera and Imaging Products Association (CIPA) standards for measuring the life of camera batteries. Measured at 23 (±2) °C (73 (±4) °F); zoom adjusted with each shot, flash fired with every other shot, image quality set to **Normal**, image size set to  **4000×3000**. Battery life may vary depending on shooting interval and length of time menus and images are displayed.

Rechargeable Li-ion Battery EN-EL5

Type	Rechargeable lithium-ion battery
Rated capacity	DC 3.7 V, 1100 mAh
Operating temperature	0 to 40 °C (32 to 104 °F)
Dimensions (W × H × D)	Approx. 36 × 54 × 8 mm (1.4 × 2.1 × 0.3 in.) (excluding projections)
Weight	Approx. 30 g (1.1 oz) (excluding terminal cover)

Battery Charger MH-61

Rated input	AC 100-240 V, 50/60 Hz, 0.12-0.08 A
Rated capacity	11-16 VA
Rated output	DC 4.2 V, 950 mA
Applicable batteries	Rechargeable Li-ion Battery EN-EL5
Charging time	Approx. 2 hours when no charge remains
Operating temperature	0 to 40 °C (32 to 104 °F)
Dimensions (W × H × D)	Approx. 67 × 26 × 67 mm (1.4 × 2.1 × 0.3 in.) (excluding projections)
Length of power cable	Approx. 1.8 m (6 ft.)
Weight	Approx. 70 g (2.5 oz) (excluding power cable)

Specifications

- Nikon will not be held liable for any errors this manual may contain.
- The appearance of this product and its specifications are subject to change without notice.

Supported Standards

- **DCF:** Design Rule for Camera File System is a standard widely used in the digital camera industry to ensure compatibility among different makes of camera.
- **DPOF:** Digital Print Order Format is an industry-wide standard that allows pictures to be printed from print orders stored on the memory card.
- **Exif version 2.2:** This camera supports Exif (Exchangeable Image File Format for Digital Still Cameras) version 2.2, a standard that allows information stored with photographs to be used for optimal color reproduction when images are output from Exif-compliant printers.
- **PictBridge:** A standard developed cooperatively by the digital camera and printer industries, allowing photographs to be output directly to a printer without connecting the camera to a computer.

Index

Symbols

51

A Aperture-priority mode 60, 64

(apply selection) button 12

Auto mode 24

Delete button 30, 31, 80, 86, 90

DISP (display) button 15

Exposure compensation 39

Flash mode 33

Flash pop-up button 33

Focus mode 37

Help 14

M Manual mode 60, 65

MENU Menu button 13

Monitor button 15

Movie mode 81

Playback button 30

Playback mode 30

Playback zoom 73

P Programmed auto mode 60, 62

Scene auto selector 52

SCENE Scene mode 40

Self-timer/ Smile timer/ Blink proof 35, 54

S Shutter-priority auto mode 60, 63

Sport continuous mode 56

T Tele 27

Thumbnail display 71

U1/U2 User setting mode 67

W Wide 27

.AVI 156

.JPG 156

.WAV 156

A

AC adapter 155

Active D-Lighting 70

AF area mode 122

AF assist 4, 145

Aperture 61

Aperture-priority auto 64

Audio/video cable 92

Audio/video-in jack 92

Auto 32

Auto bracketing 121

Auto mode 24

Auto off 146

Autofocus 37, 83, 125

Autofocus mode 83, 125

AV cable 92

B

B&W + color 113

B&W movie 82, 83

Backlight 46

Battery 18, 139

Battery chamber 5

Battery charger 155

Battery latch 18

Battery level indicator 24

Battery-chamber/memory card slot cover 18, 22

Beach/snow 43

Best shot selector 118

Black border 79

Blink proof 55

Blink warning 149

BSS 118

Built-in flash 32

Button sound 146

C

Cable connector 92, 94, 98

Calendar display 72

Camera playback 82, 83

Charger 155

Close-up 44

Command dial 11

Computer 93

Connector cover 4

Continuous 118

Copy 46

Crop 77

Custom 112

D

Date 20, 138

Date imprint 142

Daylight saving time 20, 139



Delete 30, 31, 80, 86, 90, 132

Digital zoom 27, 145

Diopter adjustment control 14

Distortion control 126
 D-Lighting 76
 DPOF 175
 DPOF print 102
 DSCN 156
 Dusk/dawn  43

E
 Electronic viewfinder 14
 Electronic VR 84
 Exposure compensation 39
 Exposure mode 60
 Extension 156
 Eyelet for camera strap 4

E
 Face priority 122
 File name 156
 Fill flash 32
 Fireworks  46
 Firmware version 154
 Fixed range auto 116
 Flash exposure compensation 125
 Flash indicator 34
 Flash mode 32
 Focus 28, 83, 122, 125
 Focus area 28
 Focus indicator 28
 Focus lock 29
 Focus mode 37
 Folder name 156
 Food  48
 Format 23, 147
 Format the internal memory 147
 Format the memory card 23, 147
 FSCN 156
 Full-frame playback 30, 31
 Full-time AF 83, 125



H
 Help 14
 Hide Image 133
 High ISO Sensitivity auto 116
 High speed continuous shooting 58

I
 Identifier 156

Image copy 134
 Image quality 107
 Image Sharpening 112
 Image size 108
 Infinity 36
 Internal memory 22
 Internal memory indicator 25
 Interval Timer Shooting 118, 119
 INTN 156
 ISO sensitivity 34, 116

L
 Landscape  41
 Language 148
 Lens 4, 172
 Lens cap 7
 Li-ion rechargeable battery 18
 Lithium-ion type battery 18

M
 Macro close-up 36
 Manual focus 36, 38
 Manual Mode 65
 Memory capacity 24
 Memory card 22, 155
 Memory card slot 22
 Metering 117
 Microphone 4, 80
 Mode dial 10
 Monitor 8, 9, 160
 Monitor brightness 141
 Monochrome filter 113
 Motion detection 144
 Movie length 83
 Movie menu 82
 Movie mode 81
 Movie playback 86
 Movie recording 81
 Movie settings 82
 Multi selector 12
 Multi-shot 16 118
 Museum  45



N
 Night landscape  44
 Night portrait  42
 Nikon Transfer 94

Noise reduction 126
Number of exposures remaining 24, 109

O

Off 32
Optical zoom 27
Optimize Image 111
Optional accessories 155

P

Panorama assist  47, 50
Paper size 99, 100
Party/indoor  42
PictBridge 97, 175
Playback 30, 31, 71, 72, 73, 80, 86, 89
Playback menu 129
Playback mode 30
Playback zoom 73
Portrait  41
Power 20, 24
Power connector cover 4
Power switch 20, 24
Preset manual 115
Pre-shooting cache 58, 59
Press halfway 28
Print 99, 100, 103
Print set 103
Print Set Date Option 104
Printer 97
Programmed auto mode 62
Protect 132

Q

Quick retouch 75

R

Rear-curtain sync 32
Rechargeable battery 155
Red-eye reduction 32, 34
Reset all 151
Reset file numbering 154
Resetting Saved Settings 69
Rotate image 133
RSCN 156

S

Saturation 112
Save to user setting 68

Scene auto selector 52
Scene menu 40
Scene mode 40
Self-timer 35
Self-timer lamp 35
Sepia movie 82, 83
Setup menu 135
Shooting 24
Shooting menu 105
Shutter button 28
Shutter sound 146
Shutter speed 61
Shutter-Priority Auto Mode 63
Single 118
Single AF 83, 125
Slide show 131
Slow sync 32
Small picture 78
Smile timer 54
Sound files copy 91
Sound files playback 89
Sound settings 146
Speaker 5
Sport continuous menu 58
Sport continuous mode 56
SSCN 156
Sunset  43
Switching between tabs 13

T

Tele 27
Television 92
Thumbnail display 71
Time difference 140
Time zone 138, 140
Time-lapse movies 84
Tripod socket 5
TV Movie 82, 83

U

USB cable 94, 98
User setting mode 67

V

Vari-angle monitor 6
Vibration reduction 143
Video output 148

Voice memo 80
Voice recording 87
Voice recordings  87
Volume 86, 90

W

Welcome screen 137
White balance 114
Wide 27

Z

Zoom 27
Zoom control 4, 27

Nikon

No reproduction in any form of this manual, in whole or in part (except for brief quotation in critical articles or reviews), may be made without written authorization from NIKON CORPORATION.



NIKON CORPORATION

Fuji Bldg., 2-3 Marunouchi 3-chome,
Chiyoda-ku, Tokyo 100-8331, Japan

© 2009 Nikon Corporation

FX9B01(11)
6MM68411-01