

Nikon

En

The Nikon Guide to Digital Photography
with the

COOLPIX S4

DIGITAL CAMERA

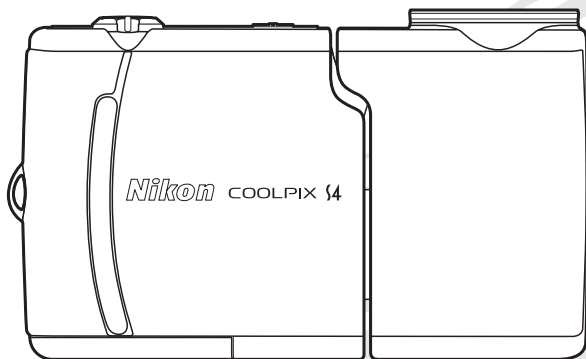

CE

Attaching the Camera Strap

Attach the camera strap as shown below.

①

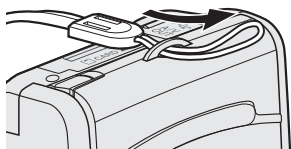

②

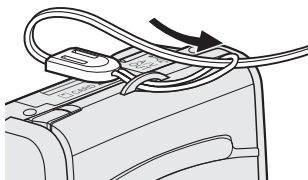

Adjust to length shown if wearing around neck.

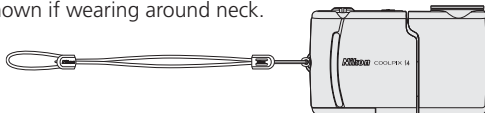

The Lens Cap

The lens cap can be opened (①) and closed (②) while still attached to the camera.

①

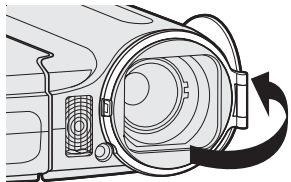

②

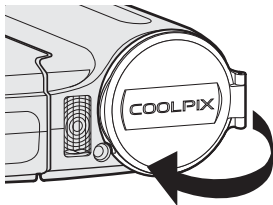

To remove the cap, open it and then pull and twist the hinge while lifting upward as shown at right.

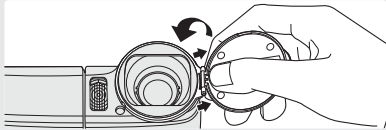

Trademark Information

Macintosh, Mac OS, and QuickTime are registered trademarks of Apple Computer, Inc. Microsoft and Windows are registered trademarks of Microsoft Corporation. The SD logo is a trademark of the SD Card Association. Adobe and Acrobat are registered trademarks of Adobe Systems Inc. PictBridge is a trademark. D-Lighting technology is provided by Apical Limited. Face-priority AF technology is provided by Identix®. All other trade names mentioned in this manual or the other documentation provided with your Nikon product are trademarks or registered trademarks of their respective holders.

Symbols and Conventions

To make it easier to find the information you need, the following symbols and conventions are used:



This icon marks cautions, information that should be read before use to prevent damage to the camera.



This icon marks notes, information that should be read before using the camera.



This icon marks tips, additional information that may be helpful when using the camera.



This icon indicates that more information is available elsewhere in this manual or in the *Quick Start Guide*.

Memory Cards

Pictures taken with this camera can be stored in the camera's internal memory or on removable memory cards. If a memory card is inserted, all new pictures will be stored on the memory card and delete, playback, and format operations will apply only to the pictures on the memory card. The memory card must be removed before the internal memory can be formatted or used to store, delete, or view pictures.

Introduction

First Steps

Basic Photography

More on Photography

Scene Mode

Voice Recordings

Movies

More on Playback

Menu Guide

Technical Notes

For Your Safety

To prevent damage to your Nikon product or injury to yourself or to others, read the following safety precautions in their entirety before using this equipment. Keep these safety instructions where all those who use the product will read them.

The consequences that could result from failure to observe the precautions listed in this section are indicated by the following symbol:



This icon marks warnings, information that should be read before using this Nikon product to prevent possible injury.

WARNINGS



Turn off in the event of malfunction

Should you notice smoke or an unusual smell coming from the camera or AC adapter, unplug the AC adapter and remove the batteries immediately, taking care to avoid burns. Continued operation could result in injury. After removing or disconnecting the power source, take the equipment to a Nikon-authorized service representative for inspection.



Do not disassemble

Touching the product's internal parts could result in injury. Repairs should be performed only by qualified technicians. Should the camera break open as the result of a fall or other accident, take the product to a Nikon-authorized service representative for inspection after unplugging the product and/or removing the batteries.



Do not use the camera or AC adapter in the presence of flammable gas

Do not use electronic equipment in the presence of flammable gas, as this could result in explosion or fire.



Handle the camera strap with care

Never place the strap around the neck of an infant or child.



Keep out of reach of children

Particular care should be taken to prevent infants from putting the batteries or other small parts into their mouths.



Observe proper precautions when handling batteries

Batteries may leak or explode if improperly handled. Observe the following precautions when handling batteries for use in this product:

- Before replacing the batteries, turn the product off. If you are using an AC adapter, be sure it is unplugged.
- Use only the batteries listed on page 6 of this manual. Do not use other types. Do not mix old and new batteries or batteries of different makes or types.
- Charge and use each pair of Nikon rechargeable Nikon EN-MH1-B2 NiMH batteries together as a set. Do not mix batteries from different pairs.
- Insert batteries in the correct orientation.
- Do not short or disassemble batteries or attempt to remove or break the covering.
- Do not expose batteries to flame or to excessive heat.
- Do not immerse in or expose to water.
- Do not transport or store with metal objects such as necklaces or hairpins.

- Batteries are prone to leakage when fully discharged. To avoid damage to the product, be sure to remove the batteries when no charge remains.
- Discontinue use immediately should you notice any change in the batteries, such as discoloration or deformation.
- If liquid from damaged batteries comes in contact with clothing or skin, rinse immediately with plenty of water.

 **Observe the following precaution when handling the battery charger**

If an MH-71 battery charger is provided with the camera, observe the following precautions:

- Keep dry. Failure to observe this precaution could result in fire or electric shock.
- Dust on or near the metal parts of the plug should be removed with a dry cloth. Continued use could result in fire.
- Do not handle the power cable or go near the battery charger during thunderstorms. Failure to observe this precaution could result in electric shock.
- Do not damage, modify, forcibly tug or bend the power cable, place it under heavy objects, or expose it to heat or flame. Should the insulation be damaged and the wires become exposed, take it to a Nikon-authorized service representative for inspection. Failure to observe these precautions could result in fire or electric shock.
- Do not handle the plug or battery charger with wet hands. Failure to observe this precaution could result in electric shock.

 **Use appropriate cables**

When connecting cables to the input and output jacks, use only the cables provided or sold by Nikon for the purpose, to maintain compliance with product regulations.

 **Handle moving parts with care**

Be careful that your fingers or other objects are not pinched between the lens section and camera body or by other moving parts.

 **CD-ROMs**

The CD-ROMs supplied with this device should not be played back on audio CD equipment. Playing CD-ROMs on an audio CD player could cause hearing loss or damage the equipment.

 **Observe caution when operating the flash**

Using the flash close to your subject's eyes could cause temporary visual impairment. Particular care should be observed if photographing infants, when the flash should be no less than one meter (39 in.) from the subject.

 **Do not fire the flash while it is touching a person or object**

Such use can result in the person being burned, and/or their clothes igniting from the heat of the flash.

 **Avoid contact with liquid crystal**

Should the monitor break, care should be taken to avoid injury due to broken glass and to prevent liquid crystal from the monitor touching the skin or entering the eyes or mouth.

Notices

- No part of the manuals included with this product may be reproduced, transmitted, transcribed, stored in a retrieval system, or translated into any language in any form, by any means, without Nikon's prior written permission.
- Nikon reserves the right to change the specifications of the hardware and software described in these manuals at any time and without prior notice.
- Nikon will not be held liable for any damages resulting from the use of this product.
- While every effort has been made to ensure that the information in these manuals is accurate and complete, we would appreciate it were you to bring any errors or omissions to the attention of the Nikon representative in your area (address provided separately).

Notice for customers in the U.S.A.

Federal Communications Commission (FCC) Radio Frequency Interference

Statement

This equipment has been tested and found to comply with the limits for a Class B digital device, pursuant to Part 15 of the FCC rules. These limits are designed to provide reasonable protection against harmful interference in a residential installation. This equipment generates, uses, and can radiate radio frequency energy and, if not installed and used in accordance with the instructions, may cause harmful interference to radio communications. However, there is no guarantee that interference will not occur in a particular installation. If this equipment does cause harmful interference to radio or television reception, which can be determined by turning the equipment off and on, the user is encouraged to try to correct the interference by one or more of the following measures:

- Reorient or relocate the receiving antenna.
- Increase the separation between the equipment and receiver.
- Connect the equipment into an outlet on a circuit different from that to which the receiver is connected.
- Consult the dealer or an experienced radio/television technician for help.

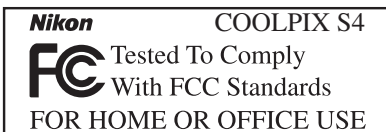

CAUTIONS

Modifications

The FCC requires the user to be notified that any changes or modifications made to this device that are not expressly approved by Nikon Corporation may void the user's authority to operate the equipment.

Interface Cables

Use the interface cables sold or provided by Nikon for your equipment. Using other interface cables may exceed the limits of Class B Part 15 of the FCC rules.

Notice for customers in the State of California

WARNING: Handling the cord on this product will expose you to lead, a chemical known to the State of California to cause birth defects or other reproductive harm. *Wash hands after handling.*

Nikon Inc.,
1300 Walt Whitman Road, Melville, New York
11747-3064, U.S.A. Tel.: 631-547-4200

Notice for customers in Canada

CAUTION

This class B digital apparatus meets all requirements of the Canadian Interference Causing Equipment Regulations.

ATTENTION

Cet appareil numérique de la classe B respecte toutes les exigences du Règlement sur le matériel brouilleur du Canada.

Symbol for Separate Collection in European Countries

This symbol indicates that this product is to be collected separately.



The following apply only to users in European countries:

- This product is designated for separate collection at an appropriate collection point. Do not dispose of as household waste.
- For more information, contact the retailer or the local authorities in charge of waste management.

Notice Concerning Prohibition of Copying or Reproduction

Note that simply being in possession of material that has been digitally copied or reproduced by means of a scanner, digital camera or other device may be punishable by law.

- **Items prohibited by law from being copied or reproduced**
Do not copy or reproduce paper money, coins, securities, government bonds, or local government bonds, even if such copies or reproductions are stamped "Sample."
The copying or reproduction of paper money, coins, or securities which are circulated in a foreign country is prohibited.
Unless the prior permission of the government has been obtained, the copying or reproduction of unused postage stamps or post cards issued by the government is prohibited.
The copying or reproduction of stamps issued by the government and of certified documents stipulated by law is prohibited.
- **Cautions on certain copies and reproductions**
The government has issued cautions on copies or reproductions of securities issued by private companies (shares, bills, checks, gift certificates, etc.), commuter passes, or coupon tickets, except when a minimum of necessary copies are to be provided for business use by a company. Also, do not copy or reproduce passports issued by the government, licenses issued by public agencies and private groups, ID cards, and tickets, such as passes and meal coupons.
- **Comply with copyright notices**
The copying or reproduction of copyrighted creative works such as books, music, paintings, woodcut prints, maps, drawings, movies, and photographs is governed by national and international copyright laws. Do not use this product for the purpose of making illegal copies or to infringe copyright laws.

Table of Contents

For Your Safety	ii
Introduction	1
Parts of the Camera.....	2
The Monitor.....	4
First Steps	6
Inserting the Batteries.....	6
Inserting Memory Cards.....	8
Turning the Camera On	10
Basic Setup	10
Basic Photography	12
Step 1—Select  Mode.....	12
Step 2—Frame the Picture.....	13
Step 3—Focus and Shoot	15
Step 4—View the Results.....	16
More on Photography	17
Using the Flash	17
Taking Pictures with the Self-Timer.....	19
Easy Close-ups: Macro Close-up Mode	20
Scene Mode	21
Framing Assist.....	22
Other Scenes	28
Voice Recordings	33
Movies	36
Movie Mode.....	36
Recording Movies.....	38
Viewing Movies	40
More on Playback	41
Viewing Pictures on the Camera	41
Viewing Pictures on TV	45
Viewing Pictures on a Computer.....	46
Printing Pictures	50
Menu Guide	58
The Shooting Menu.....	58
Image Mode	59
White Balance.....	60
Exposure Compensation.....	61
Continuous.....	61
Best Shot Selector (BSS)	63
Sensitivity.....	64

Color Options	64
The Playback Menu	65
Slide Show	67
Delete	68
Protect	68
Transfer Marking	69
Small Picture	70
Copy	71
The Setup Menu	72
Welcome Screen	73
Date	74
Brightness	75
Date Imprint	76
Sound Settings	77
Blur Warning	77
Auto Off	78
Format Memory/Format Card	78
Language	79
Interface	79
AF Assist	79
Reset all	79
Battery Type	80
Menus	80
Firmware Version	80
Technical Notes	81
Optional Accessories	81
Caring for the Camera	82
Cleaning	83
Storage	84
Error Messages	85
Troubleshooting	88
Appendix	91
Specifications	94
Index	96

Use Only Nikon Brand Electronic Accessories

Nikon COOLPIX cameras are designed to the highest standards and include complex electronic circuitry. Only Nikon brand electronic accessories (including battery chargers, batteries, and AC adapters) certified by Nikon specifically for use with this Nikon digital camera are engineered and proven to operate within the operational and safety requirements of this electronic circuitry.

THE USE OF NON-NIKON ELECTRONIC ACCESSORIES COULD DAMAGE THE CAMERA AND MAY VOID YOUR NIKON WARRANTY.

For more information about Nikon brand accessories, contact a local authorized Nikon dealer.

Disposing of Data Storage Devices

Please note that deleting images or formatting data storage devices such as memory cards or built-in camera memory does not completely erase the original image data. Deleted files can sometimes be recovered from discarded storage devices using commercially available software, potentially resulting in the malicious use of personal image data. Ensuring the privacy of such data is the user's responsibility.

Before discarding a data storage device or transferring ownership to another person, erase all data using commercial deletion software, or format the device and then completely refill it with images containing no private information (for example, pictures of empty sky). Be sure to also replace any pictures selected for the welcome screen. Care should be taken to avoid injury or damage to property when physically destroying data storage devices.

Introduction

Thank you for your purchase of a Nikon COOLPIX S4 digital camera. This manual has been written to help you enjoy taking pictures with your Nikon digital camera. Read this manual thoroughly before use, and keep it where all those who use the product will read it. The documentation for this product also includes the manuals listed below. Please be sure to read all instructions thoroughly to get the most from the camera.

- *Quick Start Guide*: The *Quick Start Guide* takes you through the process of unpacking and setting up your Nikon digital camera, taking your first photographs, and transferring them to your computer.
- *PictureProject Reference Manual* (on CD): The *PictureProject Reference Manual* contains information on using the PictureProject software provided with your camera. For information on viewing the reference manual, see the *Quick Start Guide*.

Before Taking Important Pictures

Before taking pictures on important occasions (such as at weddings or before taking the camera on a trip), take a test shot to ensure that the camera is functioning normally. Nikon will not be held liable for damages or lost profits that may result from product malfunction.

Life-Long Learning

As part of Nikon's "Life-Long Learning" commitment to ongoing product support and education, continually-updated information is available on-line at the following sites:

- For users in the U.S.A.: <http://www.nikonusa.com/>
- For users in Europe and Africa: <http://www.europe-nikon.com/support>
- For users in Asia, Oceania, and the Middle East: <http://www.nikon-asia.com/>

Visit these sites to keep up-to-date with the latest product information, tips, answers to frequently-asked questions (FAQs), and general advice on digital imaging and photography. Additional information may be available from the Nikon representative in your area. See the URL below for contact information:

<http://nikonimaging.com/>

Parts of the Camera

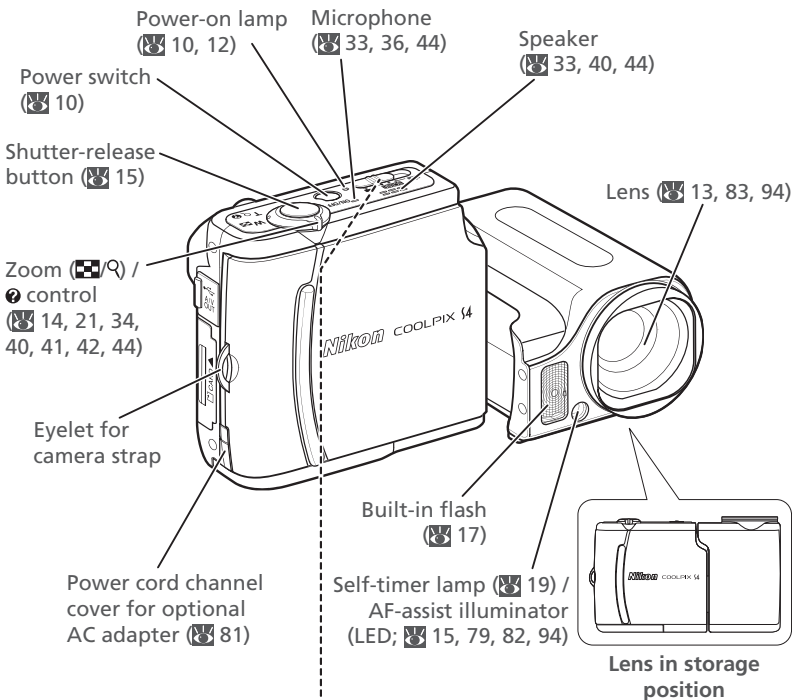

Mode selector (12, 21, 36)

Auto (12)

A simple "point-and-shoot" mode in which the majority of settings are controlled by the camera. A shooting menu offers control over seven shooting options.

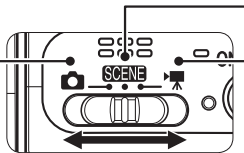

Movie (36)

Choose from four movie modes.

SCENE Scene (21)

Choose from fifteen "scenes" suited to different subjects or shooting conditions and let the camera do the rest. An additional voice recording mode is available for creating audio recordings (33).

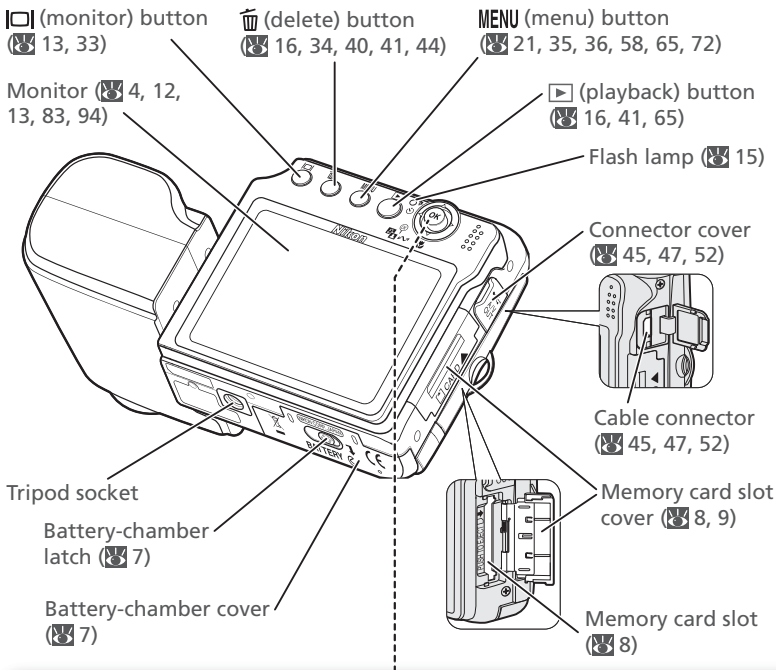

Multi selector



Press left, right, up, or down

- **Menu navigation:** Cancel and return to previous menu, or move cursor left.

- **Shooting** (☺): Display self-timer mode menu (19).

- **Menu navigation:** Move cursor down.

- **Shooting** (🌸): Display macro mode menu (20).

- **Menu navigation:** Move cursor up.

- **Shooting** (⚡): Display flash mode menu (17).



Press center (OK) to make selection

- **Menu navigation:** Display sub-menu, move cursor right, or make selection.

The Monitor

The following indicators may appear in the monitor during shooting and playback (actual display varies with current camera settings):

Shooting

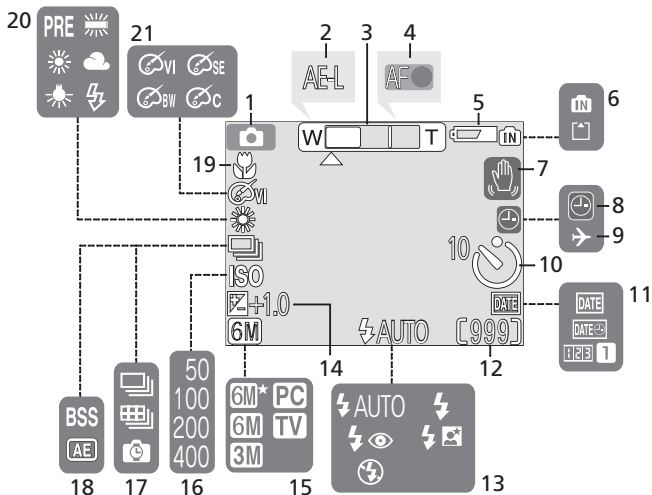

Playback

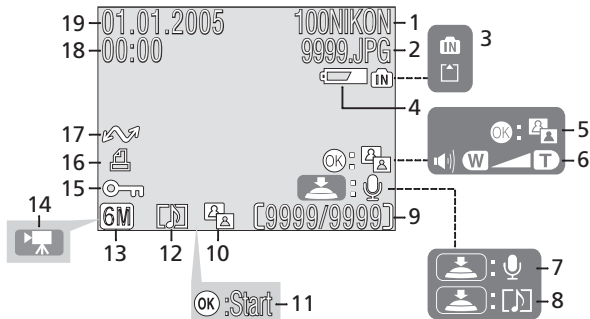

1	Shooting mode.....	12, 21, 36
2	Exposure lock	32, 39, 62
3	Zoom indicator ¹	14
4	Focus indicator ²	15
5	Battery level indicator ³	12
6	Internal memory/memory card indicator.....	12, 15
7	Camera shake icon ⁴	18, 28, 77
8	“Date not set” indicator ⁵	11
9	Time zone indicator	74
10	Self-timer indicator	19
11	Date imprint/date counter	76

1 Displayed when zoom button is pressed.

2 Displayed when shutter-release button is pressed halfway.

3 Appears when batteries are running low.

12	Number of exposures remaining	12, 92
	Movie length	36, 38
13	Flash mode.....	17
14	Exposure compensation.....	61
15	Image mode	59
16	Sensitivity	64
17	Continuous shooting mode	61–62
18	Best Shot Selector (BSS).....	63
19	Macro close-up mode.....	20
20	White balance	60
21	Color option.....	64

4 Appears at slow shutter speeds to warn that pictures may be blurred.

5 Appears when camera clock has not been set.

1	Current folder	92–93
2	File number and type.....	92–93
3	Internal memory/memory card indicator.....	41
4	Battery level indicator ¹	12
5	D-Lighting guide	43
6	Volume indicator	40, 44
7	Voice memo recording guide	44
8	Voice memo playback guide	44
9	Current frame number/ total number of frames.....	92–93
	Movie length.....	36

1 Appears when batteries are running low.

10	D-Lighting icon.....	43
11	Movie playback indicator	40
12	Voice memo icon.....	44
13	Image mode	59
14	Movie indicator	40
15	Protect icon	68
16	Print-order icon	51
17	Transfer icon.....	69, 79
18	Time of recording	10–11, 74–75
19	Date of recording	10–11, 74–75

First Steps

Inserting the Batteries

The camera uses two AA batteries. Depending on the country or region of purchase, the package will include *either* alkaline batteries *or* an MH-71 battery charger with rechargeable EN-MH1-B2 batteries.

1 Charge the batteries (EN-MH1-B2 batteries only)

If the camera came with a battery charger and rechargeable Nikon EN-MH1-B2 NiMH batteries, charge the batteries as described below. If the camera came with a pair of alkaline batteries, skip to Step 2 on the following page.

1.1 Plug the charger in

Connect the power cable to the charger (①) and then plug it into a power outlet (②). The CHARGE lamp will light (③).

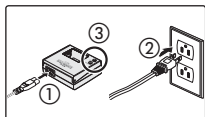

1.2 Charge the batteries

Insert the batteries as indicated on the charger. The CHARGE lamp will start to blink. Charging is complete when the lamp stops blinking.

A pair of new or fully exhausted batteries will charge in about two and a half hours.

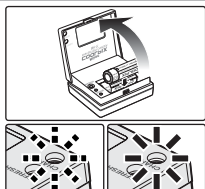

✓ Batteries

Read and follow the warnings and cautions on pages ii–iii and 84 of this manual. The camera can be used with AA alkaline (LR6) batteries, Nikon rechargeable EN-MH1-B2 NiMH batteries, ZR6 oxy-nickel batteries, and FR6/L91 lithium batteries. **Do not mix old and new batteries or batteries of different makes or types.** Batteries with the following defects can not be used:

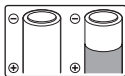

Peeling or damaged insulation



Insulation does not reach negative terminal

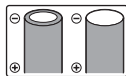

Flat negative terminal

✏ EN-MH1-B2 Batteries

Charge EN-MH1-B2 batteries before first use. Charge and use as a set: do not charge batteries one at a time or mix batteries from different pairs. Note that the batteries may tend to discharge more quickly when new or after a long period of disuse. The batteries will retain a charge longer once they have been used and recharged several times. “Memory” effects that result in reduced battery capacity can be avoided by periodically refreshing the batteries as described in the Appendix (📖 93).

2 Insert the batteries

2.1 Open the battery-chamber cover

Press the battery-chamber latch and slide the cover in the direction shown (①) until it opens (②).

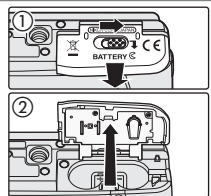

2.2 Insert the batteries

Insert the batteries as shown in the label inside the battery-chamber cover.

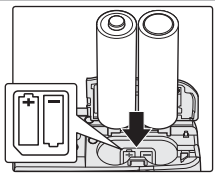

2.3 Close the battery-chamber cover

Close the cover (①) and slide it in the direction shown until it latches (②).

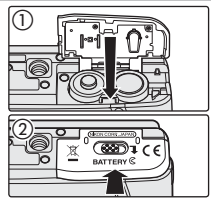

✓ Replacing Batteries

Turn the camera off and make sure the power-on lamp has gone out before opening the battery chamber cover. Batteries can not be replaced with the camera on a tripod.

The Battery Type Menu

After replacing the batteries, check that the option selected for **Battery Type** in the setup menu matches the type of batteries used (Ⓜ 80).

Alkaline Batteries

The performance of alkaline batteries can vary widely. Choose batteries from a reputable manufacturer.

The EH-62B AC Adapter Kit

The optional EH-62B AC adapter kit can be used to power the camera for extended periods (Ⓜ 81). *Do not, under any circumstances, use another make or model of AC adapter.* Failure to observe this precaution could result in overheating or in damage to the camera.

Inserting Memory Cards

Pictures are stored in the camera's internal memory (approximately 13.5 MB) or on removable Secure Digital (SD) memory cards. For information on compatible memory cards, see "Technical Notes: Optional Accessories" (81).

If no memory card is inserted, pictures are recorded to, and played back and deleted from, the camera's internal memory. Formatting (78) affects internal memory only.

If a memory card is inserted, the card is used for recording, playback, and deletion. Formatting affects only the memory card, not internal memory. **The memory card must be removed from the camera** before internal memory can be formatted or used to record, delete, or view pictures.

To insert a memory card:

1 Confirm that the power-on lamp is off

✓ Inserting Memory Cards

Turn the camera off (10) before inserting or removing memory cards.



2 Insert the memory card

Slide the cover in the direction shown (1) until it opens (2). Slide the memory card in terminals first until it clicks into place (3).

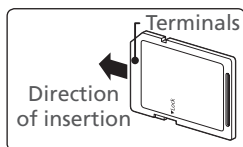
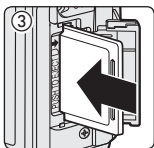
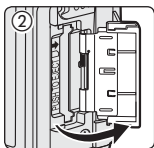
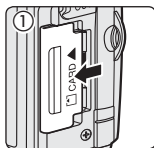

✓ Inserting Memory Cards

Check to be sure the card is in the correct orientation. Inserting the card upside down or backwards could damage the camera or the card.

Before inserting the card, make sure that it is unlocked. If the card is locked, pictures can not be recorded, deleted, or edited and the card can not be formatted.

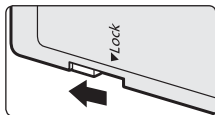
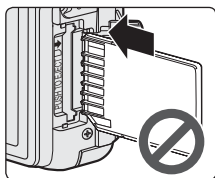

Lock switch

- 3 Close the memory card slot cover**
Close the cover (①) and slide it in the direction shown until it latches (②).

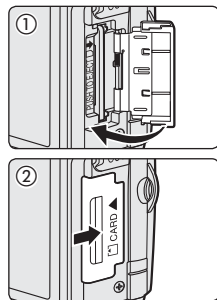

Formatting Memory Cards

Before they can be used in the COOLPIX S4, memory cards must be formatted using the **Format card** option in the camera setup menu (78).

Removing Memory Cards

Memory cards can be removed without loss of data when the camera is off. To remove memory cards, turn the camera off and confirm that the power-on lamp is off. **Do not open the memory card slot cover while the power-on lamp is lit.** Open the memory card slot cover and press the card in to partially eject the card. The card can then be removed by hand.

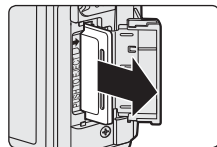

Turning the Camera On

Press the power switch until the power-on lamp lights. The power-on lamp shows camera status as follows:

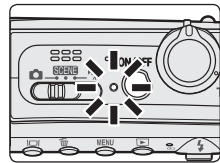

Power-on lamp	Camera status
On	On
Blinks	Auto power off (standby mode)
Flickers	Batteries exhausted (🔋 85)
Off	Off

Basic Setup

The first time the camera is turned on, a language-selection dialog will be displayed. Choose a language and set the time and date as follows:

First Steps

1

Deutsch Русский
English Svenska
Español 日本語
Français 中文(简体)
Italiano 中文(繁體)
Nederlands 한국어

MENU Cancel OK Confirm

Highlight language.*

2

DATE

Set time and date?

No
Yes

OK Confirm

Confirmation dialog displayed.

* Press MENU button to exit without selecting language.

3

DATE

Set time and date?

No
Yes

OK Confirm

Highlight Yes.

4

TIME ZONE

OK London, Casablanca
DaylightSaving

OK Confirm

TIME ZONE menu displayed.†

† See “The Setup Menu: Date” (🔋 74) for information on setting daylight saving time.

Turning the Camera Off

To turn the camera off, press the power switch again. The camera is off when the power-on lamp is off. Do not remove the batteries or memory card or disconnect the optional AC adapter until the power-on lamp has gone out.

Auto Power off (Stand-by Mode)

If no operations are performed for about five seconds, the monitor will gradually dim to save power. Full brightness can be restored by pressing the shutter-release button or operating any of the controls next to the monitor. If no operations are performed for about a minute, the monitor will turn off and the camera will enter stand-by mode, further reducing the drain on the battery (🔋 78). The power-on lamp will blink and the monitor can be reactivated by pressing the shutter-release button halfway. The camera will turn off automatically if no operations are performed for another three minutes.

5





Display map of world time zones.

6





Select home time zone.

7



Display DATE menu.

8



Edit Day (order of Day, Month, and Year may differ in some areas).

9



Select Month. Repeat steps 8–9 to edit Month, Year, hour, and minute.

10

Highlight D M Y.

11

Choose date display order.

12



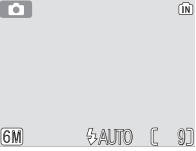

Exit to current mode.

The Camera Clock

The clock battery charges when the main batteries are installed or an AC adapter is connected, and can provide several days of backup power after about 10 hours of charging. The clock and birthday counter may be reset when the battery runs low; *when the battery is exhausted, the DATE menu will be displayed automatically.* If the clock is not set, a 📅 (“date not set”) icon will flash in the monitor during shooting. Pictures taken while this icon is displayed will have a time stamp of “00.00.0000 00:00:00,” while movies will be dated “01.01.2005 00:00:00.”

Basic Photography

This section describes how to take pictures in  (auto) mode, an automatic, “point-and-shoot” mode recommended for first-time users of digital cameras.

Step 1—Select Mode

Slide the mode selector to  and turn the camera on. The power-on lamp will light. The camera is ready to shoot when the view through the camera lens is displayed in the monitor.

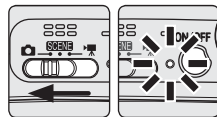

Battery indicator: appears when batteries are running low.









Shooting mode:  indicates auto mode.

Image mode: choose from five options depending on how picture will be used ( 59). Default is .

Flash mode: choose from five modes according to lighting and creative intent ( 17). Default is .





Internal memory/memory card indicator: indicates whether internal memory () or memory card () is used.

Number of exposures remaining: depends on capacity of internal memory or memory card and on option chosen for **Image Mode** ( 92).

The Battery Indicator

Display	Description
NO ICON	Batteries fully charged.
	Low battery; ready spare batteries. If flash fires, monitor will turn off while flash recharges.
WARNING!! BATTERY EXHAUSTED	Batteries exhausted. No pictures can be taken until batteries are replaced. Power-on lamp flickers.

Shooting Options

 (auto) mode offers flash ( 17), self-timer ( 19), and macro close-up options ( 20). In addition, a seven-item shooting menu gives full control over such settings as white balance and exposure compensation ( 58).

Step 2—Frame the Picture

- 1 Rotate the lens to shooting position**
The lens can be gently rotated up to 180° forward from the storage position (0°) or 90° back to face the user for a quick arms-length self-portrait. When the lens is rotated to face the user, the monitor shows a mirror image of what will appear in the final photograph.

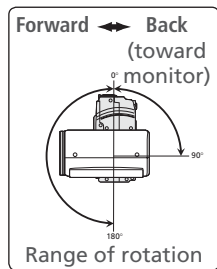

- 2 Ready the camera**
Hold the camera steadily in both hands.

Don't Block the Shot

To avoid muffled sound or dark or partially obscured pictures, keep fingers and other objects away from the microphone, lens, flash, and AF-assist lamp. If attached, the lens cap should be fully open to prevent it from blocking the lens.

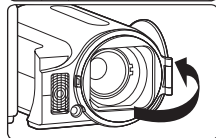
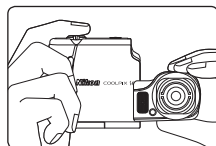

Using a Tripod

Rotate the lens to shooting position before mounting the camera on a tripod. Contact with the tripod can damage the camera lens.

The Button

Press the  button to hide or display indicators in the monitor.

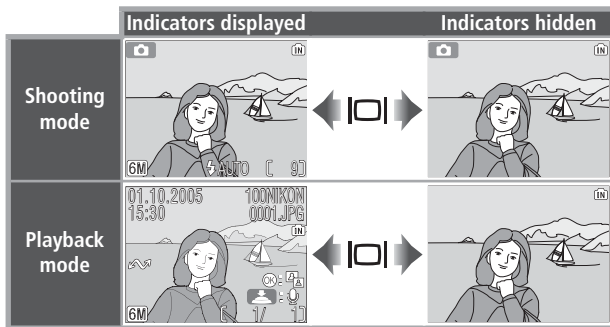

3 Frame the subject

The camera is equipped with two types of built-in zoom: optical zoom, in which the camera's telescoping lens can be used to magnify the subject up to 10 \times , and digital zoom, in which digital processing is used to further magnify the image up to 4 \times , for a total of 40 \times . Use the zoom control to frame your subject in the center of the monitor:

- **T**: zoom in on your subject so that it fills a larger area of the frame.
- **W**: zoom out from your subject, increasing the area visible in the frame.
- When the camera is zoomed in to maximum magnification, holding the control in the **T** position for about two seconds will trigger digital zoom, and the zoom indicator will turn yellow. Use the zoom control to adjust zoom in the digital zoom range. To cancel digital zoom, zoom out until the zoom indicator turns white.



Zoom out

Zoom in



Indicator shows amount of zoom



Digital zoom

Digital Zoom

In digital zoom, data from the camera's image sensor are processed digitally, enlarging the center portion of the picture to fill the frame. Unlike optical zoom, digital zoom does not increase the amount of detail visible in the picture. Instead, details visible at maximum optical zoom are simply enlarged, producing a slightly "grainy" image.

Step 3—Focus and Shoot

1 Focus

Press the shutter-release button halfway to set focus and exposure. In  mode, the camera will automatically focus on the subject at the center of the frame. Focus and exposure will lock while the shutter-release button is pressed halfway.

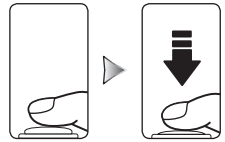

With the shutter-release button pressed halfway, check the focus indicator and flash lamp:

Focus Indicator	On (green)	Subject in focus.
	Blinks red	Camera unable to focus on subject at center of frame. Using focus lock, focus on another subject at same distance, then recompose picture and shoot ( 91).
Flash lamp	On (red)	Flash will fire when picture is taken.
	Blinks red	Flash is charging.
	Off	Flash is off or not required.

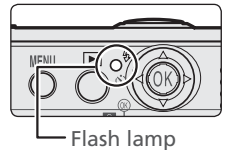
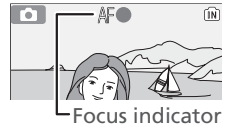





2 Take the picture

Press the shutter release button the rest of the way down to take the picture. To prevent blur, press the shutter-release button down smoothly (a blur warning may appear at slow shutter speeds;  77).



During Recording

While pictures are being recorded, the internal memory/memory card indicator ( or ) will blink. The camera can continue to take pictures until the  (wait) icon is displayed. **Do not turn the camera off, eject the memory card, or remove or disconnect the power source while the internal memory/memory card indicator is blinking or the  icon is displayed.** Cutting power or removing the memory card in these circumstances could result in loss of data or in damage to the camera or card.

The AF-Assist Illuminator

If lighting is poor, the built-in AF-assist illuminator will light when the shutter-release button is pressed halfway, allowing the camera to focus even when the subject is poorly lit ( 79).

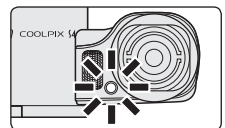



Step 4—View the Results

- 1 Press the  button
A picture will be displayed in the monitor.

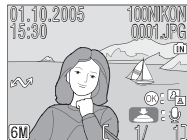

- 2 View additional pictures
Press the multi selector down or right to view pictures in the order recorded, up or left to view pictures in reverse order. Pictures are displayed briefly at low resolution while being read from memory, making it possible to scroll rapidly through pictures without waiting for each image to be displayed at full resolution. Keep the multi selector pressed to scroll quickly to the desired picture.



To return to shooting mode, press the  button again. For more information on playback, see “More on Playback” ( 41).

Deleting Unwanted Pictures

To delete the current picture, press the  button. A confirmation dialog will be displayed; press the multi selector up or down to highlight an option and then press the center of the multi selector.

- **No:** Exit without deleting the picture.
- **Yes:** Delete the picture.



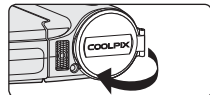
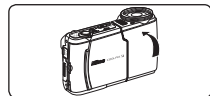

Putting the Camera Away

1. Turn the camera off.
2. Rotate the lens to the storage position.
3. Replace and close the lens cap.



The Button

Pressing the  button for about one second will turn the camera on in playback mode. Press again  to return to the mode selected with the mode selector.

More on Photography

⚡ Using the Flash

The following flash modes are available:

Mode	How it works	When to use it
⚡ AUTO Auto	Flash fires when lighting is poor.	Best choice in most situations.
⚡👁️ Auto with red-eye reduction	Flash fires several times at low intensity before main flash; pictures are further processed to reduce red-eye if required (📖 18).	Use to reduce “red-eye” in portraits. Works best when subject looks directly at low-intensity flashes. Not recommended when quick shutter response is required.
🚫 Flash Cancel (off)	Flash will not fire even when lighting is poor.	Use to capture natural lighting under dim light or where use of flash is prohibited. If 📷 (camera shake) icon appears, care should be taken to avoid blurring.
⚡ Anytime Flash (fill flash)	Flash fires whenever picture is taken.	Use to “fill-in” (illuminate) shadows and back-lit subjects.
⚡📷 Slow sync	Auto flash combined with slow shutter speeds.	Use to capture both subject and background at night or under dim light.

1

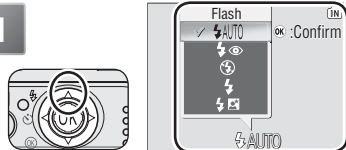

Display flash-mode menu.

2

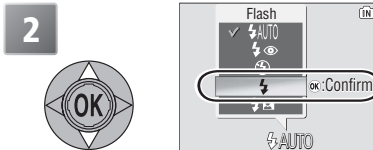

Highlight mode.

3

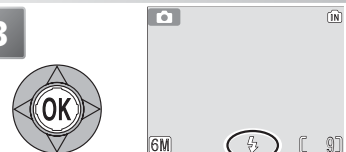



Exit menu (to exit without changing mode, wait two seconds). Selection is shown by icon at bottom of display.

When Lighting Is Poor

When lighting is poor, sensitivity is raised to compensate and the image in the monitor may be slightly “grainy.” This is normal and does not indicate a malfunction.

The (Camera Shake) Icon

When lighting is poor and the flash is off () , shutter speeds will slow and pictures may be blurred. If the shutter speed required for exposure is very slow, a  (camera shake) warning be displayed. Use of a tripod or support is recommended. Mottling may appear in pictures taken when this icon is displayed.

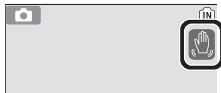

Dust or Mist

Light from the flash reflected from particles of dust or other matter in the air may appear in pictures as bright specks. If this occurs, turn the flash off and try again.

Red-eye Reduction

The COOLPIX S4 uses *advanced red-eye reduction*. Low-intensity light pulses cause the subject's pupils to contract before the flash fires. The camera then analyzes the image for red-eye; if red-eye is detected, the image will be processed to reduce its effects (“In-Camera Red-Eye Fix”). This slightly increases the amount of time needed to record each picture. If red-eye reduction does not produce the desired results, try again at another flash setting.

Default Flash Mode

When the camera is turned on in  (auto) mode, the most recent flash setting will be restored; in other modes, the flash will be reset to the default for the selected mode.

Reset all ( 79) resets the flash to **AUTO** ( mode) or to the default for the current mode (assist and scene modes).









Flash Range

The flash has a range of 0.4–3.0m (1 ft. 4 in.–10 ft.). As a result, the flash may not be able to light the entire subject at distances of less than 0.4m (1 ft. 4 in.). When taking close-ups, play each picture back after shooting to check the results.

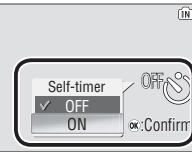

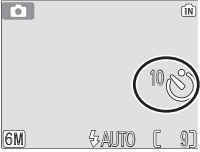
Taking Pictures with the Self-Timer

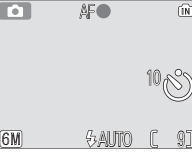
The camera is equipped with a ten-second timer for portraits or to avoid blurring that may result from the camera moving when the shutter-release button is pressed. When using the self-timer, mount the camera on a tripod (recommended) or rest it on a flat, level surface.

<p>1</p>  <p>Display self-timer menu.</p>	 <p>Self-timer OFF ON</p>	<p>2</p>  <p>Highlight ON.</p>	 <p>Self-timer OFF ON α:Confirm</p>
<p>3</p>  <p>Exit menu (to exit without changing mode, wait two seconds). Selection is shown by icon in display.</p>	 <p>6M AUTO [9]</p>	<p>4</p>  <p>Set focus and exposure.</p>	 <p>6M AUTO [9]</p>
<p>5</p> 	 <p>6M AUTO [9]</p>	<p>Start timer; display in monitor shows seconds remaining before shutter is released. To stop timer before picture is taken, press shutter-release button again or press multi selector left.</p>	

The self-timer lamp on the front of the camera will blink until one second before the picture is taken, staying lit during the final second to warn that the shutter is about to be released.

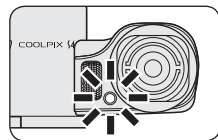



Easy Close-ups: Macro Close-up Mode

Macro close-up mode is used for taking close-up shots of small objects at very short distances (minimum 4 cm/1.6 in.).

1



Display macro close-up menu.

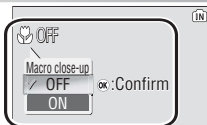

2



Highlight ON.

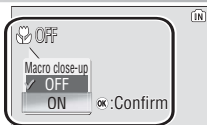

3

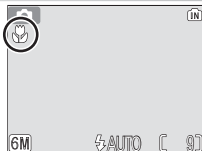

Exit menu (to exit without changing mode, wait two seconds). Selection is shown by icon in display.

4



Frame picture. Minimum focus distance varies with zoom position; if zoom is adjusted until  icon turns green, camera can focus at distance of 4 cm/1.6 in.

More on Photography

Macro Close-up Mode

The flash may not be able to light the entire subject at distances of less than 40 cm/1 ft. 4 in. When taking close-ups, play each picture back after shooting to check the results.

In macro close-up mode, the camera focuses continuously, even when the shutter-release button is not pressed halfway.

Scene Mode

Scene mode offers a choice of twelve “scene” and four “assist” settings. Camera settings are automatically optimized for the selected subject type, sparing the user the necessity of adjusting each setting separately. To display the scene menu:

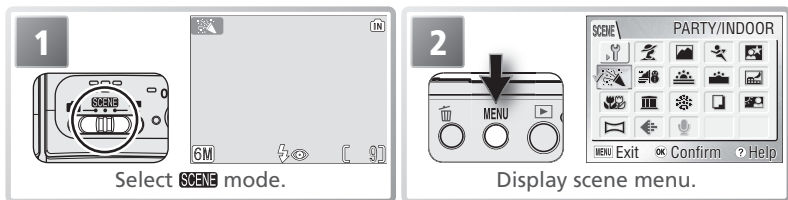

Help

For help on the current menu option, press the zoom control to **T**. Choose **T** again to return to the menu, or press the **MENU** button to exit to the mode currently selected with the mode selector.

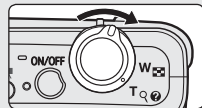

Help is available for all camera menus. In scene mode, help on other scene and assist settings can be viewed by pressing the multi selector up or down. Press the center of the multi selector to select the current scene or assist setting and return to shooting mode. In other modes, pressing the center of the multi selector when help is displayed returns you to the current menu.

Scene Mode

Depending on your subject, scene mode may not always produce the desired results. If results are not satisfactory, choose **☑** (auto) mode and try again.

Other Options

In addition to the scene and assist modes described on the following pages, the scene menu contains the options listed below:

- **⚙** (setup): Display the setup menu (**72**).
- **🖼** (image mode): Select an image mode setting from the menu shown at right (**59**).
- **🗣** (voice recording): Create a voice recording (**33**).

To display any of the above options, highlight the corresponding icon and press the center of the multi selector.

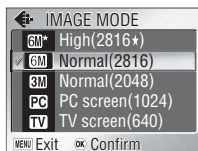





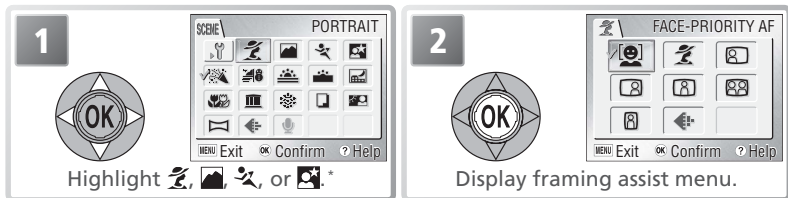



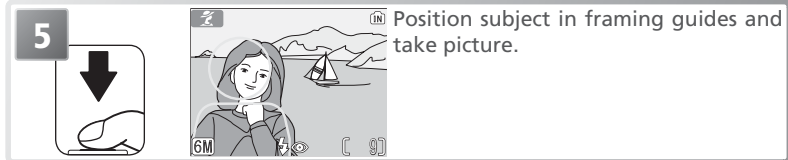
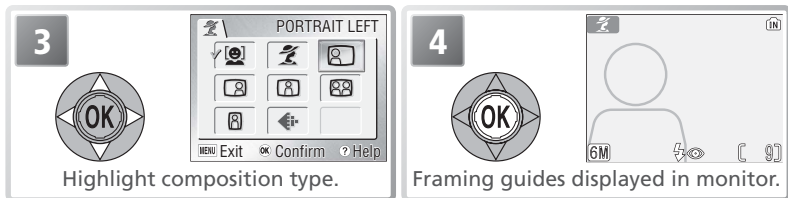

Framing Assist: , , , and

These modes offer a selection of framing assist options that allow you to compose pictures with the help of framing guides displayed in the monitor.



* To exit without changing selection, press **MENU** button.



Depending on the mode selected, restrictions may apply to flash mode (,  17), the self-timer (;  19), or macro close-up (,  20). These restrictions are noted on the pages that follow. The AF-assist illuminator ( 15) is available only when PORTRAIT is selected for  (portrait assist) or NIGHT PORTRAIT is selected for  (night portrait assist).

Using the Guides

Your subject does not have to fit exactly in the framing guides. *When framing pictures, pay attention to your surroundings; be careful not to trip and fall.*

Portrait Assist

 (portrait assist) mode is used to frame portraits in which the main subject stands out clearly while background details are softened, lending the composition a sense of depth (the degree of softening depends on the amount of light available). A framing assist menu helps frame off-center subjects and compose tall or wide shots and two-person portraits.

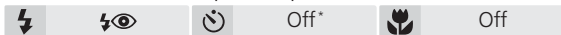

Face-priority AF: Camera automatically focuses on face of portrait subject ( 24).



PORTRAIT: No guides are displayed. Camera focuses on subject in center of frame; use focus lock to focus on off-center subjects ( 91).



Portrait left: Compose shot with subject in left half of frame. Camera focuses on subject in framing guide.



Portrait right: Compose shot with subject in right half of frame. Camera focuses on subject in framing guide.



Portrait close-up: Compose shot with subject's face in top half of frame. Camera focuses on face area in framing guide.



Portrait couple: Compose shot with two subjects side-by-side. Camera focuses on closest subject.





Portrait figure: Compose shot in "tall" orientation. Camera focuses on subject in framing guide.

* Other modes can be selected.

Taking Pictures with Face-Priority AF (23)

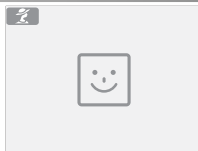
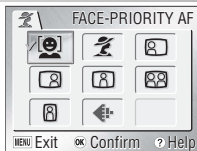
1



Highlight  and press center of multi selector.  icon blinks in monitor.

2

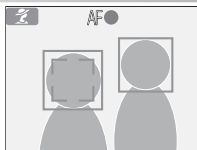

Frame picture using size of  icon as a guide. Closest portrait subject is indicated by double yellow border.*

* If camera detects multiple faces, closest subject will be indicated by double border, other subjects by single border. Camera will focus on closest subject. If camera can no longer detect subject (for example, because subject has looked away from camera), borders will no longer be displayed and  icon will blink in monitor.

3

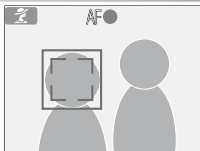

Set focus and exposure.
Double border turns green.

4



Take picture.

Face-Priority AF

The camera's ability to detect faces depends on a variety of factors, including whether or not the subject is facing the camera. The camera may be unable to detect faces that are hidden by sunglasses or other obstructions or that take up too much or too little of the frame. If no face is detected when the shutter-release button is pressed halfway, the camera will focus on the center of the frame.

The camera will focus continuously until a face detected. If the double border flashes yellow when the shutter-release button is pressed halfway, the camera is unable to focus; release the button and try again.

Landscape Assist

 (landscape assist) mode is used for vivid landscape shots that enhance outlines, colors, and contrast. A framing assist menu helps frame not only natural landscapes but also cityscapes and portrait shots featuring a landmark in the background.

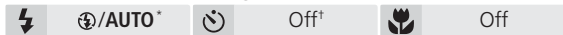

LANDSCAPE: No guides are displayed. Use to focus on distant objects through foreground objects such as windows or a screen of branches. Camera focuses at infinity; AF indicator lights whenever shutter-release button is pressed halfway.



Scenic view: Compose shot with sky in top third of frame. Match skyline with wavy yellow guide. Camera focuses at infinity; AF indicator lights whenever shutter-release button is pressed halfway.



Architecture: Photograph buildings. Framing grid helps keep verticals and horizontals aligned with the frame. Camera focuses at infinity; AF indicator lights whenever shutter-release button is pressed halfway.



Group right: Compose shot with portrait subjects at right and landmark or other object in background at left of frame. Camera focuses on portrait subject.



Group left: Compose shot with portrait subjects at left and landmark or other object in background at right of frame. Camera focuses on portrait subject.

* Flash turns off (⚡) automatically in **LANDSCAPE**, **Scenic view**, and **Architecture** modes. In **Group right** and **Group left** modes, flash mode is automatically set to **AUTO**; other modes can be selected.

† Other modes can be selected.

Sports Assist

 (sports assist) mode is used for dynamic action shots that capture moving objects. No guides are displayed in the monitor.

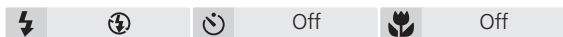

SPORTS: While shutter-release button is held down, pictures are recorded at rate of about 1.3 frames per second (fps) until  icon is displayed. Camera focuses continuously until shutter-release button is pressed halfway to lock focus.



Sport composite: Each time shutter-release button is pressed, camera takes 16 shots in about 2 seconds and arranges them in 4 rows to form single picture  1600 × 1200 pixels in size. Camera focuses continuously until shutter-release button is pressed halfway to lock focus.

Focus, Exposure, and White Balance

In sports assist mode, focus, exposure, and white balance for all pictures are determined by the first shot in each series. The AF-assist illuminator does not light.

Night Portrait Assist

 (night portrait assist) mode is used for taking portrait shots at night, when it provides a natural balance between the main subject and the background. Pictures taken at slow shutter speeds are adjusted to reduce noise, slightly increasing processing time; to prevent blurring, mount the camera on a tripod or rest it on a flat, stable surface.

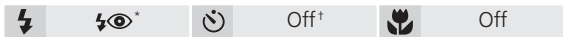
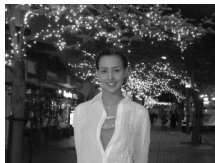

NIGHT PORTRAIT: No guides are displayed. Camera focuses on subject in center of frame; use focus lock to focus on off-center subjects (📖 91).



Portrait left: Compose shot with subject in left half of frame. Camera focuses on subject in framing guide.



Portrait right: Compose shot with subject in right half of frame. Camera focuses on subject in framing guide.



Portrait close-up: Compose shot with subject's face in top half of frame. Camera focuses on face area in framing guide.



Portrait couple: Compose shot with two subjects side-by-side. Camera focuses on closest subject.



Portrait figure: Compose shot in "tall" orientation. Camera focuses on subject in framing guide.

* Fill flash with slow sync and red-eye reduction.

† Other modes can be selected.

Other Scenes

In addition to the four “assist” modes described on the preceding pages, scene mode offers a selection of eleven “scenes,” each corresponding to a common subject type, such as a backlit subject, sunset, or interior shot. A voice recording mode is also available for creating audio recordings (🗣️ 33).

To select a scene from the scene menu (📷 21):

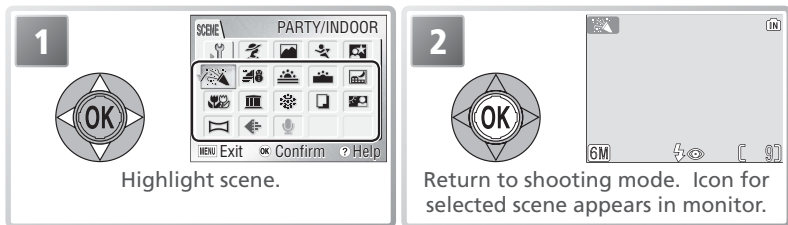

* To exit without changing selection, press **MENU** button.

Depending on the scene selected, restrictions may apply to flash mode (🔦, 📷 17), the self-timer (🕒 19), or macro close-up (🌸, 📷 20). These restrictions are noted on the pages that follow.

Scene Mode

Party/Indoor

Use for shots that include details of the background, or to capture the effects of candlelight and other indoor background lighting.

🔦 🕒* 🌸 Off 📷 Hold camera steady

* Other modes can be selected.

📷 Camera Shake (📷)

At slow shutter speeds, a 📷 icon appears in the monitor to warn that pictures may be blurred. The following indicate the precautions that can be taken to avoid blur:

Hold camera steady: Hold camera in both hands and brace elbows against body

Use tripod: Use tripod or rest camera on flat, level surface

Beach/Snow

Captures the brightness of such subjects as snowfields, beaches, or sunlit expanses of water.



Auto*



Off



—

Sunset

Preserves the deep hues seen in sunsets and sunrises.



Off



Hold camera steady

Dusk/Dawn

Preserves the colors seen in the weak natural light before sunrise or after sunset.

- Noise reduction turns on at slow shutter speeds.
- Camera focuses at infinity. AF indicator lights whenever shutter-release button is pressed halfway. AF-assist illuminator can not be used.



Off



Hold camera steady

Night landscape

Slow shutter speeds are used to produce stunning night landscapes.

- Noise reduction turns on at slow shutter speeds.
- Camera focuses at infinity. AF indicator lights whenever shutter-release button is pressed halfway. AF-assist illuminator can not be used.



Off



Use tripod

* Other modes can be selected.

Noise Reduction

“Noise” in the form of randomly-spaced, brightly-colored pixels tends to appear in pictures taken at slow shutter speeds. This effect is particularly noticeable in dark areas of the picture. At settings of **Dusk/Dawn** and **Night landscape**, pictures taken at slow shutter speeds are processed to reduce noise, increasing the time needed to process pictures before they are saved.

Close up

Use to photograph flowers, insects, and other small objects at ranges as close as 4 cm (1.6 in.), with the background artistically blurred.

- Camera focuses continuously on nearest object. Focus locks when shutter-release button is pressed halfway. Minimum focus distance varies with zoom position; to focus on objects as close as 4 cm (1.6 in.) to lens, adjust zoom until macro close-up icon () turns green. Note that flash may be unable to light entire subject at ranges of under 40 cm (1 ft. 4 in.). Take test shot and examine results in monitor.



Auto*



On



Hold camera steady

Museum

Use indoors where flash photography is prohibited (for example, in museums and art galleries) or in other settings in which you do not want to use the flash.

- Best Shot Selector (BSS;  63) turns on automatically.
- AF-assist illuminator can not be used.
- Photography may be prohibited in some settings. Obtain permission first.



Off*



Hold camera steady

Fireworks show

Slow shutter speeds are used to capture the expanding burst of light from a firework.

- Camera focuses at infinity. AF indicator lights whenever shutter-release button is pressed halfway. AF-assist illuminator can not be used.
- Self-timer can not be used.



Off



Use tripod

Copy

Provides clear pictures of text or drawings on a white board or in printed matter such as a business card.

- Use macro close-up ( 20) to focus at short ranges.
- Colored text and drawings may not show up well.

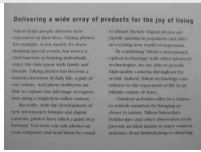

Off*



* Other modes can be selected.

Back light

Use when light is coming from behind a portrait subject, throwing their features into shadow. The flash fires automatically to “fill in” (illuminate) shadows.



Off



—

Panorama assist 32)

Use when taking a series of pictures that will later be joined together in PictureProject to form a panorama.



Off*







—

Voice recording 33)

Create a digital audio recording.

* Other modes can be selected.

Panorama Assist

Flash mode  17), the self-timer  19), and macro close-up  20) can be adjusted after the pan direction is selected. Once the first shot in each series is taken, the pan direction, zoom, flash mode, macro close-up, and image mode  59) can not be adjusted nor pictures deleted until the series is complete.



Panoramas are easier to compose if the camera is mounted on a tripod.

See the Appendix for information on how panoramas are stored  92–93).

Taking Pictures for a Panorama

1



Highlight  (Panorama assist) in scene menu ( 21).



2



Default pan direction displayed.



3

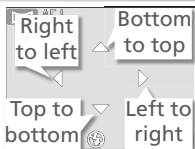

Select how pictures will be joined together in completed panorama. This is the direction in which camera will be panned after each shot.

4

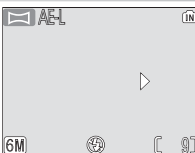

Make selection (to return to step 3, press center of multi selector again). Pan direction displayed in white. Yellow AE-L icon shows that white balance and exposure will lock with first shot.

5

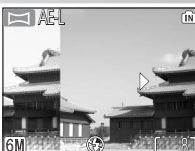

Take first shot. About $\frac{1}{3}$ of picture is superimposed on view through lens (if pan direction is left to right, picture will appear on left side of monitor). AE-L icon turns white to show that white balance and exposure settings for this picture apply to all shots in series.

6



Compose next shot to overlap with previous picture.

7



Take next shot. Repeat steps 6–7 until all shots in series have been taken.

8





End series. Shooting will also end if a new mode is selected or camera enters standby mode.

Voice Recordings

Audio voice recordings can be recorded over the built-in microphone and played back over the built-in speaker.



Making a Voice Recording

1





Highlight **VOICE RECORDING** in scene menu (21).

2



Display shows length of recording that can be made.

3





Start recording.¹

1 Recording indicator	5 Date of recording
2 File number	6 Time remaining
3 Length of recording	7 Index number ²
4 Progress indicator	

1 To pause recording, press center of multi selector. Press again to resume recording. While recording is paused, self-timer and indicator lamps will blink.

2 To create an index, press the multi selector up, down, left, or right during recording. Camera can skip to any index during playback. Start of recording is index number 01; other numbers are assigned in ascending order, to maximum of 98.

4



End recording. Recording will end automatically after five hours or when no more memory is available. Internal memory can store up to 29 minutes of audio.

Making a Voice Recording

Sound can not be recorded if there are less than ten seconds of recording time available or the batteries are exhausted. Before recording, record a test sample and play it back to determine whether conditions are suitable for audio recording. During recording, the monitor turns off. Press **[OK]** button to turn monitor on and off. Do not touch the microphone during recording.

Playing Voice Recordings

To play voice recordings back, display the voice recording screen shown in Step 2 on the preceding page and follow the steps below.

1



Display list of voice recordings.

2



Select recording.

3









Begin playback.

1 Control icons*
2 File number
3 Playback time
4 Index number
5 Progress indicator

6 Date of recording
7 Length of recording
8 Volume†
9 Index



* Press multi selector left or right to highlight control, press center to select.

Control	Description
	Pause playback.
	Resume playback.
	Advance recording. Playback resumes when multi selector is released.
	Rewind recording. Playback resumes when multi selector is released.
	Return to start of current index.
	Skip to next index.
	End playback and return to voice recording list.

† Zoom control controls volume. Select **W** to lower volume, **T** to raise volume.

To exit playback and return to recording mode, press the  button.

Deleting Voice Recordings

To delete a voice recording, highlight it in the voice recording list and press the  button, or press the  button during playback to delete the current voice recording. A confirmation dialog will be displayed; press the multi selector up or down to highlight an option, then press the center of the multi selector.

- **No:** Exit to voice recording list without deleting recording.
- **Yes:** Delete recording and return to voice recording list.

Voice Recordings



The COOLPIX S4 may be unable play or copy sound files created with other devices.

Copying Voice Recordings

To copy voice recordings between internal memory and a memory card, display the voice recording list shown in Step 1 on the preceding page and press the **MENU** button. The menu shown at right will be displayed.





1



Highlight option:

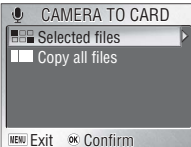

- Internal to Card: Copy recordings from internal memory to memory card
- Card to Internal: Copy recordings from memory card to internal memory

2

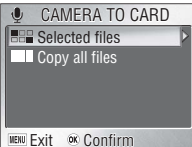

Display menu of copy options.

3



Highlight **Selected files**.*



* To copy all voice recordings, highlight **Copy all files** and press multi selector right. A confirmation dialog will be displayed; press multi selector down to highlight **Yes** and press center of multi selector.

4



Display list of voice recording files.

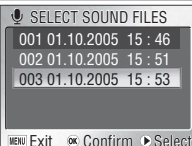

5



Highlight file.†

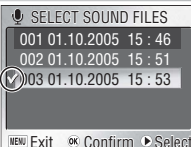

† Press **MENU** button to exit without copying recordings.

6

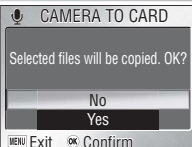

Selected file shown by ✓. Repeat steps 5–6 to select additional files.‡

7



Confirmation dialog displayed. To copy files, highlight **Yes** and press **OK**.

‡ To deselect file, highlight and press multi selector right.

Movies



Movie Mode

The camera can record the following types of movie. All movies have a frame rate of fifteen frames per second; except in the case of time-lapse movies, movies include sound recorded via the built-in microphone.

Option	Description	Max. length*	
		Internal memory (13.5MB)	256 MB memory card
TV movie 640	Frame size is 640 × 480 pixels, suitable for television playback.†	24s	7 min 15s
Small size 320 (default)	Frame size is 320 × 240 pixels.†	47s	14 min 15s
Smaller size 160	Frame size is 160 × 120 pixels, reducing file size and allowing longer movies to be recorded.†	2 min 38s	47 min 5s
Time-lapse movie	Camera takes up to 1800 stills at specified intervals and joins them to create silent movie with frame size of 640 × 480 (Ⓜ 39). Shoot flowers opening, butterfly emerging from cocoon, etc.	9s (143 frames)	120s (1800 frames)†

* Approximate maximum total length; may vary with make of card.

† Shooting can continue to limit of available memory.

‡ Regardless of actual maximum total length, maximum value shown in camera exposure count display is 999.

To choose the type of movie that will be recorded:

Movies

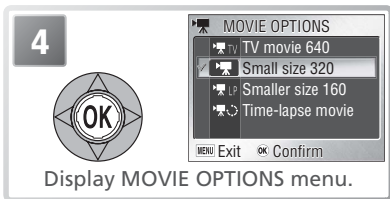
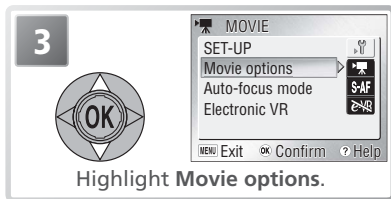
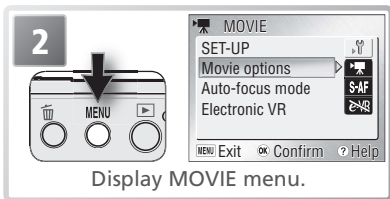
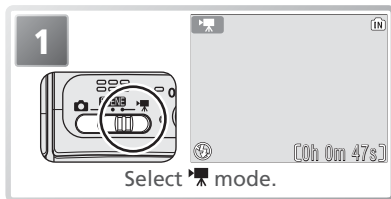

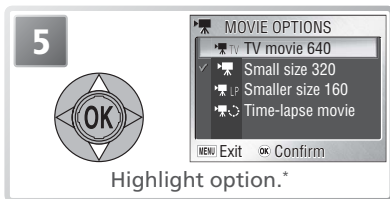

* To exit without changing mode, press MENU button.

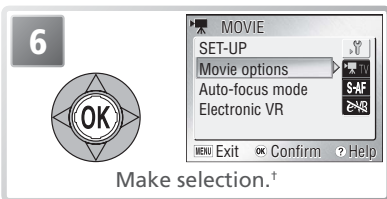

† If **Time-lapse movie** is selected, time-lapse-movie menu is displayed (39).

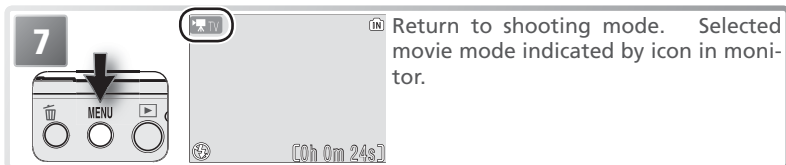

The following options are available for **Auto-focus mode**:

Option	Description
Single AF (default)	Camera focuses when shutter-release button is pressed halfway. Focus locks when focus operation is complete. Select this option to prevent sound of camera focusing from interfering with recording.
Continuous AF	Camera adjusts focus continuously.

To choose a focus option, highlight **Auto-focus mode** in the MOVIE menu (36) and press the multi selector to the right, then follow the steps below.

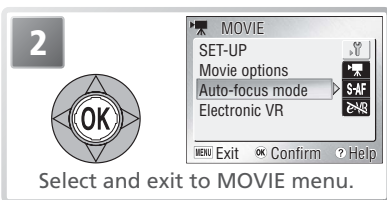
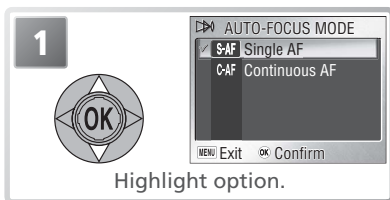

Menu Options



For help on the selected option, press the zoom control to (T) (21). To display the setup menu (72), select **Setup** from the MOVIE menu. To display menu options as icons, select **Icons** for **Menus** in the setup menu (80).

The following options are available for **Electronic VR**:

Option	Description
On	Reduces effects of camera shake (not available with time-lapse movies). eVR icon is displayed in shooting mode.  [0h 0m 47s.]
Off	Vibration reduction off.



To select an option, highlight **Electronic VR** in the MOVIE menu (36) and press the multi selector right. The menu shown in Step 1 will be displayed.

1

Highlight option.

2





Select and exit to MOVIE menu.

Recording Movies

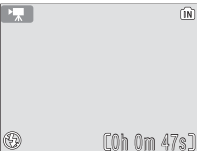

Movies

1

Select  mode. Exposure count display shows maximum total length of movie that can be recorded. [0h 0m 47s.]

2

Start recording.  icon flashes and progress indicator is displayed. [0h 0m 33s.]

3

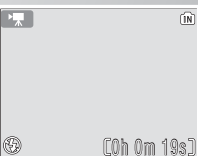

End recording. Recording will end automatically when movie has reached maximum length or memory is full. [0h 0m 19s.]

Recording Movies

The self-timer can not be used in movie mode. The flash turns off in **TV movie 640**, **Small size 320**, and **Smaller size 160** modes. Optical zoom can not be adjusted during recording; digital zoom is available to a maximum of 2x.

Recording Time-Lapse Movies

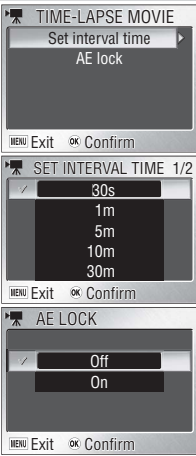
Selecting **Time-lapse movie** from the MOVIE menu (📷 36) displays the menu shown in Step 1, below.

1			<p>Highlight Set interval time or AE lock and press center of multi selector to display sub-menu. Press multi selector up or down to highlight option, press center to select.</p> <ul style="list-style-type: none">• SET INTERVAL TIME: Choose interval between shots.• AE LOCK: Choose On to fix exposure and white balance for entire series at values for first frame, Off to meter new values for each shot. Flash turns off when On is selected.
2		Return to shooting mode.	
3		Start recording. Camera takes pictures at specified interval until shutter-release button is pressed again, memory is full, or 1800 frames are recorded.	

Use a Reliable Power Source

If possible, use an optional EH-62B AC adapter kit to record time-lapse movies.

During Recording

To save power, the monitor turns off between frames. The monitor turns on automatically immediately before the camera takes the next shot.

AE Lock

When **On** is selected for **AE lock**, a yellow AE-L icon will be displayed, indicating that exposure and white balance will be locked with the first shot. Once the first shot is taken, the icon will turn white.



Viewing Movies

In full-frame playback (📺 16, 41), movies are indicated by a 📺 icon and can be viewed by pressing the center of the multi selector. Playback controls appear at the top of the display; press the multi selector left or right to highlight a control, then press the center of the multi selector to perform the selected operation.

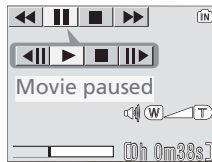

Playback display

Control	Description
	Movie rewinds while center of multi selector is pressed. Playback resumes when multi selector is released.
	Movie advances while center of multi selector is pressed. Playback resumes when multi selector is released.
	Pause playback.
	Advance paused movie one frame.
	Rewind paused movie one frame.
	Resume playback.
	End movie and return to full-frame playback.

Movie Files

See the Appendix for information on how movie files are stored (📺 92–93).

Playback Volume

The zoom control controls volume during playback. Select **W** to decrease volume, **T** to increase.

Deleting Movies

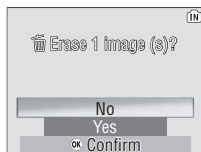

To delete the movie displayed in full-frame playback or selected in the thumbnail list (📺 41), press the 🗑️ button. A confirmation dialog will be displayed; press the multi selector up or down to highlight an option, then press the center of the multi selector.

- **Yes:** delete movie
- **No:** exit without deleting movie



More on Playback

Viewing Pictures on the Camera







To view pictures full-frame in the monitor (*full-frame playback*), press the  button (if the camera is off, pressing the  button for about a second will turn the camera on in playback mode).



Viewing Multiple Pictures: Thumbnail Playback

Selecting  (W) with the zoom control in full-frame playback displays pictures in “contact sheets” of four thumbnail images. The following operations can be performed while thumbnails are displayed:



To	Press	Description
Highlight pictures		Use multi selector to highlight pictures.
Change number of pictures displayed	Zoom control	With four thumbnails displayed, press to  (W) once to view nine thumbnails. Press to Q (T) to “zoom in” from nine to four thumbnails or, when four thumbnails are displayed, to view highlighted picture full frame.
Delete highlighted picture		Confirmation dialog displayed. Press multi selector up or down to highlight option, press center to select. <ul style="list-style-type: none">• Select No to exit without deleting picture• Select  to delete voice memo (available only if voice memo has been recorded for selected picture;  44)• Select Yes to delete picture
View highlighted picture full frame		View picture highlighted in thumbnail list full frame.
Exit to current mode		Exit to mode selected with mode selector.



Viewing Pictures

If a memory card is inserted in the camera, only the pictures on the memory card will be played back. To view the pictures in internal memory, remove the memory card or copy the pictures from internal memory to the memory card.

Taking a Closer Look: Playback Zoom

Use zoom control to zoom in on images displayed in full-frame playback (📷 16, 41). Playback zoom is not available with movies (📷 40) or small pictures (📷 70).



To	Press	Description
Zoom in	Q (T)	Zoom increases each time Q (T) is selected, to a maximum of 10x. While image is zoomed in, Q icon and zoom ratio are displayed in top left corner of monitor.
View other areas of picture		Use multi selector to scroll to areas of picture not visible in monitor. To use multi selector to view other pictures, cancel zoom.
Zoom out	W (W)	Zoom decreases each time W (W) is selected. To cancel zoom, zoom picture out until entire picture is displayed.
Cancel zoom	OK	Cancel zoom and return to full-frame playback.
Create cropped copy	Shutter button	Save portion of picture visible in monitor to separate file. Confirmation dialog displayed; press multi selector up or down to highlight option, press center to select. <ul style="list-style-type: none">• Select No to exit without creating cropped copy• Select Yes to create new picture containing only area visible in monitor

Cropped Copies

Cropped copies are stored as JPEG files with a compression ratio of 1:8. Depending on the size of the original and the zoom ratio at the time the copy was created, copies will be 2,592 × 1,944 (5M), 2,048 × 1,536 (3M), 1,600 × 1,200 (2M), 1,280 × 960 (1M), 1,024 × 768 (PC), 640 × 480 (TV), 320 × 240 (L), or 160 × 120 (S) pixels in size. Copies are created with the same transfer marking and date and time or recording as the original, but any changes to transfer marking or to protect and print attributes must be made separately. See the Appendix for more information on how cropped copies are stored (📷 92–93).

Copies can only be created if sufficient memory is available. Cropped copies may not display or transfer correctly when viewed on other models of Nikon camera. Cropping is not available with movies (📷 40), small pictures (📷 70), or cropped copies.

Enhancing Contrast: D-Lighting

D-lighting can be used to create a copy of a picture with enhanced brightness and contrast, brightening dark or backlit subjects.

Original (without
D-lighting)



Copy (with
D-lighting)



- 

1. Display picture full-frame (41). (D-lighting) guide will be displayed if D-lighting is available with selected picture (4).
- 

2. Confirmation dialog displayed.
- 

3. Highlight OK.*
- 

4. Create copy. During playback, (D-lighting) icon is displayed on copies created with D-lighting (4).





* To exit without creating copy, highlight **Cancel** and press center of multi selector.

D-Lighting







Copies are created with the same transfer marking and date and time or recording as the original, but any changes to transfer marking or to protect and print attributes must be made separately. See the Appendix for more information on how D-lighting copies are stored (92–93).

Copies can only be created if sufficient memory is available. Copies created with D-lighting may not display or transfer correctly when viewed on other models of Nikon camera. D-lighting is not available with cropped copies (42), movies (40), small pictures (70), or copies created with D-lighting.

Voice Memos: Recording and Playback

A voice memo can be recorded and appended to any picture marked with a  (voice memo recording guide) icon in full-frame playback ( 16, 41). If a voice memo already exists for the current picture, it must be deleted before a new memo can be recorded. Voice memos can not be recorded for movies or during thumb-nail playback ( 41) or playback zoom ( 42).



To	Press	Description
Record memo	 Shutter button	If  icon is displayed on current picture, memo will be recorded while shutter-release button is held down. Recording ends after about 20s or when shutter-release button is released. Do not touch microphone during recording.
Play memo	 Shutter button	Pictures for which voice memo exists are marked by  (voice memo playback guide) and  icons. Press shutter-release button to play voice memo. Playback ends when voice memo ends or shutter-release button is pressed again.
Change volume	Zoom control	Zoom control controls volume during playback. Select W to lower volume, T to increase.
Delete picture or voice memo		Confirmation dialog displayed. Press multi selector up or down to highlight option, press center to select. <ul style="list-style-type: none">• Select No to exit without deleting picture or voice memo• Select Yes to delete both picture and voice memo• Select  to delete voice memo only



Voice Memos

See the Appendix for more information on how voice memos are stored ( 92–93). Voice memos can not be added to pictures created with other types of camera. Voice memos recorded using other types of camera can not be played back on the COOLPIX S4.

Viewing Pictures on TV

The EG-CP14 audio/video (A/V) cable included with the camera can be used to connect the camera to a television or video-cassette recorder (VCR).

Choosing a Video Mode

The **Interface > Video mode** item in the setup menu offers a choice of NTSC and PAL ( 79). Be sure that the mode selected matches the standard used in the video device.

- 1 Turn the camera off
- 2 Connect the A/V cable
Connect the black plug to the camera.

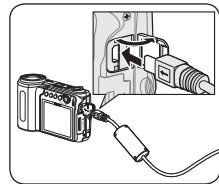

Insert the yellow plug into the video-in jack on the television or VCR. Connect the white plug to the audio-in jack.

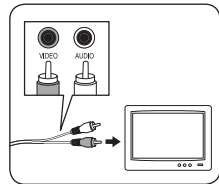

- 3 Tune the television to the video channel
If in doubt, consult the documentation for your television or VCR.
- 4 Turn the camera on
Press the  button for about a second to turn the camera on. The camera monitor will remain off and the television will show the image normally shown in the monitor.

Viewing Pictures on TV

To reduce the drain on the battery when viewing pictures for an extended period, use an EH-62B AC adapter kit (available separately).

PAL

If **PAL** is selected for **Video mode** and the camera connected to a video device, video output will be suspended and the camera monitor will turn on when the camera is in movie mode.

Viewing Pictures on a Computer

The supplied UC-E6 USB cable and PictureProject software can be used to view photographs and movies on a computer. Before pictures can be transferred (copied) to your computer, PictureProject must be installed. For more information on installing PictureProject and transferring pictures to a computer, see the documentation on the reference CD and the *Quick Start Guide*.

Before Connecting the Camera: Choosing a USB Option

Pictures can be copied from the camera to the computer by:

- Pressing the center of the multi selector (OK/⤵ button)
- Clicking the button in PictureProject



Center of multi selector (OK/⤵ button)

Which method you will use depends on your computer's operating system and the USB option selected in the camera setup menu. After consulting the following table, select the appropriate option using the **USB** item in the camera setup menu. The default option is **Mass storage**.

Operating system	Pictures transferred using:	
	Camera multi selector (OK/⤵ button) ¹	PictureProject <input type="button" value="Transfer"/> button
Windows XP Home Edition Windows XP Professional	Choose Mass storage ² or PTP .	
Windows 2000 Professional Windows Millennium Edition (Me) Windows 98 Second Edition (SE)	Choose Mass storage . ^{2,3}	
Mac OS X 10.1.5 or later	Choose PTP .	Choose Mass storage ² or PTP .

1 The center of the multi selector can not be used to transfer pictures a locked memory card. Use the PictureProject button or unlock the memory card.

2 The center of the multi selector can not be used to transfer pictures from internal memory when **Mass storage** is selected. Use the PictureProject button.

3 Do NOT select **PTP**. If **PTP** is selected when the camera is connected to a computer running Windows 2000 or Windows 98SE, the Windows hardware wizard will be displayed. Under Windows Me, the hardware wizard will be displayed after a message stating that the hardware information database is being updated. Click **Cancel** to exit the wizard, and then disconnect the camera. Be sure to select **Mass storage** before reconnecting the camera.

Viewing Pictures on a Computer

To reduce the drain on the battery when the camera is connected for an extended period, use an EH-62B AC adapter kit (available separately).

To choose a USB option, highlight **Interface** in the setup menu (79) and press the multi selector to the right. The menu shown in Step 1 will be displayed.

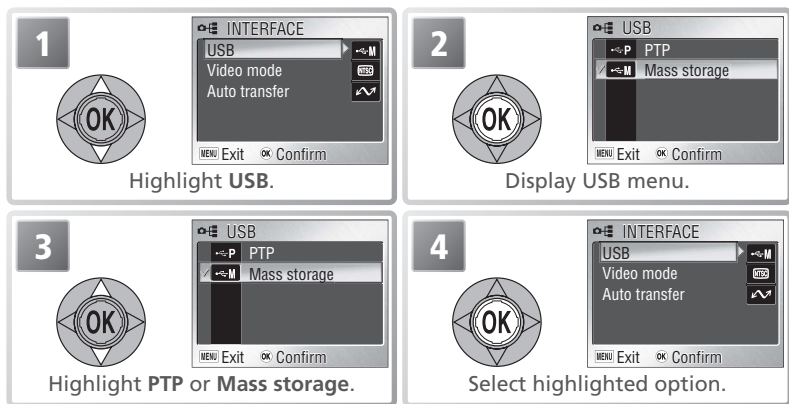

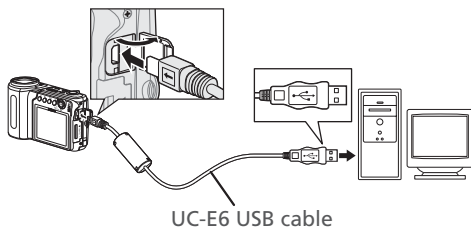

Connecting the USB Cable

Turn the computer on and wait for it to start up. Turn the camera off and connect the UC-E6 USB cable as shown below. Connect the camera directly to the computer; do not connect the cable via a USB hub or keyboard.



Transferring Pictures

If PictureProject is installed, the PictureProject Transfer window will be displayed in the computer monitor when the camera is connected and turned on. Pictures can be transferred using the  button in PictureProject (see the PictureProject reference manual CD for details) or by pressing the center of the multi selector ( button) copies to the computer all pictures that are marked for transfer ( 69, 79). The following messages will be displayed in the camera monitor while pictures are transferred.



During Transfer

Do not turn the camera off, disconnect the USB cable or AC adapter, or remove or insert memory cards while data are being transferred. Failure to observe this precaution could result in product or computer malfunction.

Transferring Pictures from Internal Memory

Data in internal memory can not be copied to the computer when a memory card is inserted in the camera. Remove the memory card before attempting to transfer data from internal memory.

Voice Recordings

PictureProject can not be used to transfer or play voice recordings. Select **Mass storage** for **USB**, copy the files manually, and then play them back using QuickTime or any other WAV-compatible audio player. Note that index points created with the camera can not be used when voice recordings are played back on another device.

Disconnecting the Camera

If **PTP** is selected in the **USB** menu, you can turn the camera off and disconnect the USB cable once transfer is complete. If you have not changed the **USB** option in the camera setup menu from its default setting of **Mass storage**, you must remove the camera from the system as shown below before turning the camera off or disconnecting the cable.

Windows XP Home Edition/Windows XP Professional

Click the “Safely Remove Hardware” icon (🔌) in the taskbar and select **Safely remove USB Mass Storage Device** from the menu that appears.



Windows 2000 Professional

Click the “Unplug or Eject Hardware” icon (🔌) in the taskbar and select **Stop USB Mass Storage Device** from the menu that appears.



Windows Millennium Edition (Me)

Click the “Unplug or Eject Hardware” icon (🔌) in the taskbar and select **Stop USB Disk** from the menu that appears.



Windows 98 Second Edition (SE)

In My Computer, click with the right mouse button on the removable disk corresponding to the camera and select **Eject** from the menu that appears.



Macintosh

Drag the untitled camera volume (“NO NAME”) into the Trash.



Printing Pictures

Pictures can be printed by any of the following methods:

- Select pictures for printing using **Print set** (see below) and take the memory card to a digital print service center or insert the card into a personal photo printer equipped with a card slot. To print the pictures in internal memory, copy them to a memory card before selecting pictures using **Print set**.
- Connect the camera to a printer that supports PictBridge and print pictures directly from the camera (52)
- Transfer the pictures using PictureProject and print them from a computer (see the *PictureProject Reference Manual*, on CD)

Print Set

The **Print set** option in the playback menu is used to create digital “print orders” for PictBridge-compatible printers or devices that support DPOF.

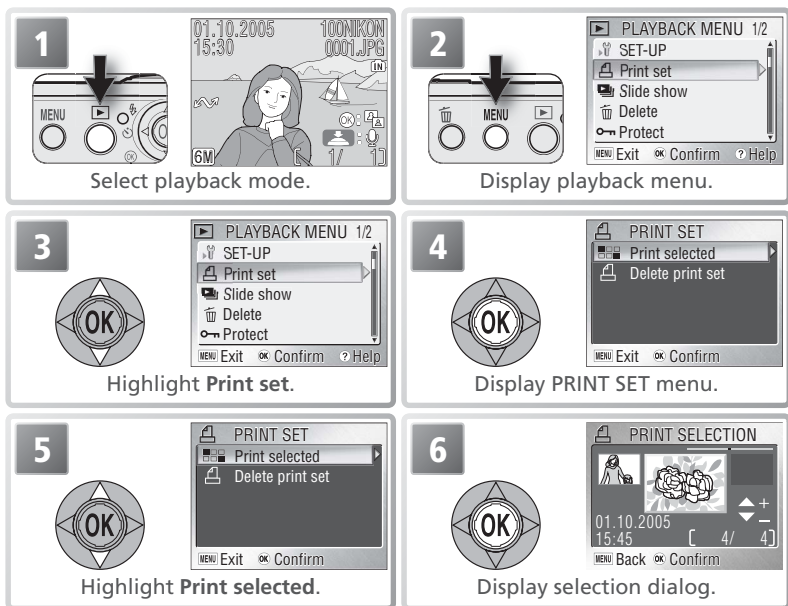

7



Scroll through pictures. Current picture shown at center of display.



8



Select current picture and set number of prints to 1. Selected pictures marked by  icon.

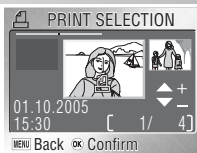

9



Choose number of prints (up to 9). To deselect picture, press multi selector down when number of prints is 1. Repeat steps 7–9 to select additional pictures.



10



Display print options. To select or deselect options, highlight and press center of multi selector. Selected items are marked with a ✓.

- **Date:** Print date of recording on all pictures in print order.
- **Info:** Print shutter speed and aperture on all pictures in print order.

To complete print order and return to playback, highlight **Done** and press center of multi selector. To exit without altering print order, press **MENU** button.

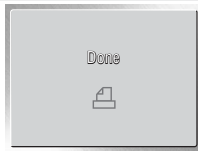
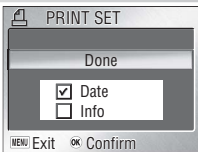

"Print Set" and Digital Print Order Format (DPOF)

Print set creates a "print order" in Digital Print Order Format (DPOF) listing the pictures to be printed, the number of prints, and the information to be included on each print. The pictures can then be printed by connecting the camera to a PictBridge-compatible printer or by removing the memory card from the camera and inserting it in a DPOF-compatible device. Note that if the **Print set** option has not been used to create a print order, one copy of all pictures will be printed.

Print Set

Date and **Info** options are reset each time the menu shown in Step 10 is displayed.

The Print-Order Icon

During playback, a print-order icon appears on all pictures in the current print order.



Printing Via Direct USB Connection

When the camera is connected to a PictBridge-compatible printer via the UC-E6 USB cable, selected pictures can be printed directly from the camera.

- 1 Set the USB option to PTP**
Set the **USB** option in the setup menu to **PTP** before connecting the printer (▶ 47; the default option is **Mass storage**).
- 2 Connect the USB cable**
After confirming that the camera is off, connect the UC-E6 USB cable as shown below.

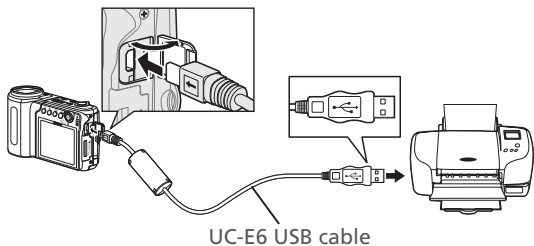

- 3 Turn the camera on**
Turn the camera and printer on. A PictBridge start-up screen will be displayed. The camera will then enter full-frame playback with the PictBridge logo displayed in the monitor.

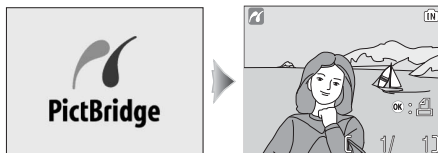

The Thumbnail Display

To view six pictures at a time, press the zoom control to **W**. Press to **T** to return to full-frame playback.

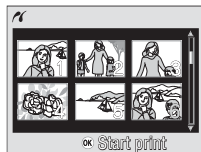

4 Print pictures

Press the center of the multi selector to print the current picture or press the **MENU** button to select multiple pictures for printing.

Printing Pictures One at a Time

Display picture full frame or highlight in thumbnail list.



Select picture for printing.



Select number of copies and choose page size (F5 54).

Print picture (F5 54).

Printing Multiple Pictures

Press **MENU** button.



Choose page size (F5 55).

Print:

- Selected pictures (F5 56)
- All pictures (F5 55)
- Current print order (F5 57)

Printing Pictures

To reduce the drain on the battery when printing, use an EH-62B AC adapter kit (available separately).

PictBridge

PictBridge is an industry standard for direct printing that ensures compatibility when different devices are connected.

Printing Pictures One at a Time

To print the picture currently displayed full frame or highlighted in the thumbnail list, press the center of the multi selector. The menu shown at right will be displayed; press the multi selector up or down to highlight an option.

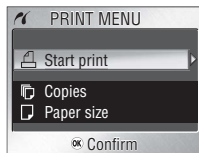

Option	Description
Start print	Highlight this option and press center of multi selector to print the selected picture. Message shown at right displayed during printing; to cancel and return to PictBridge playback display before all images have been printed, press center of multi selector. When printing is complete, message shown below at right will be displayed for about two seconds, followed by PictBridge playback display. Print additional pictures as described above or turn camera off and disconnect USB cable.
Copies	Highlight this option and press multi selector right to display menu shown at right. Press multi selector up or down to choose number of copies (maximum 9), then press center to select and return to print menu.
Paper size	Highlight this option and press multi selector right to display menu shown at right. Press multi selector up or down to highlight Default (default page size for current printer, 3.5"x5" , 5"x7" , Postcard , 100mmx150mm , 4"x6" , 8"x10" , Letter , A3 , or A4 , then press center to select and return to print menu.

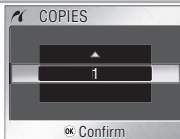
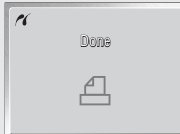

Printing Multiple Pictures

To print all pictures or multiple selected pictures, press the **MENU** button. The menu shown at right will be displayed; press the multi selector up or down to highlight an option, then press the center to select.

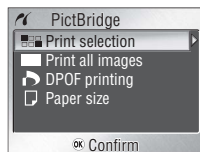







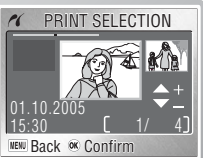

Option	Description
Print selection	Print selected pictures (56).
Print all images	Print one copy of all pictures. Message shown at right displayed during printing; to cancel and return to PictBridge menu before all images have been printed, press center of multi selector. When printing is complete, message shown below at right will be displayed for about two seconds, followed by PictBridge menu. Turn camera off and disconnect USB cable.
DPOF printing	Print current DPOF print order (57).
Paper size	Menu shown at right will be displayed. Press multi selector up or down to highlight Default (default page size for current printer, 3.5"x5" , 5"x7" , Postcard , 100mmx150mm , 4"x6" , 8"x10" , Letter , A3 , or A4), then press center to select and return to PictBridge menu.

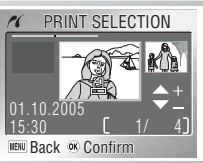

Printing Selected Pictures: Print Selection

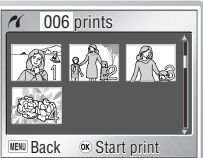
Choosing **Print selection** in the PictBridge menu (see previous page) displays the menu shown in Step 1.

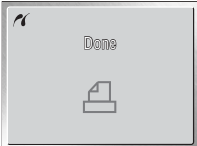

<p>1</p>  <p>Scroll through pictures. Current picture shown at center of display.</p>	 <p>2</p>  <p>Select current picture and set number of prints to 1. Selected pictures marked by  icon.</p>
<p>3</p>  <p>Choose number of prints (up to 9). To deselect picture, press multi selector down when number of prints is 1. Repeat steps 1–2 to select additional pictures.</p>	
<p>4</p>  <p>Confirm selection. Use multi selector to view other pictures.*</p>	 <p>5</p>  <p>Start printing.†</p>
<p>6</p> 	<p>When printing is complete, message shown at left is displayed for about two seconds, followed by PictBridge menu. Turn camera off and disconnect USB cable.</p>

* Press **MENU** button to exit to PictBridge menu without printing pictures.

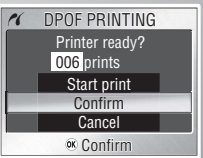

† Press center of multi selector again to cancel before printing is complete.

Printing the Current Print Order: DPOF Printing

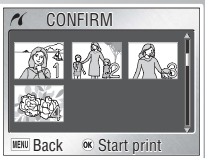
To print the current print order (📷 50), select **DPOF printing** in the PictBridge menu (📷 55). The options shown in Step 1 will be displayed.

<p>1</p>  <p>Highlight Confirm.*</p>		<p>2</p>  <p>View print order. Use multi selector to view images not visible in display.</p>	
---	---	--	---

* Select **Start print** to start printing without viewing current print order. Select **Cancel** to exit to PictBridge menu without printing.

<p>3</p> 		<p>Start printing (to interrupt printing, press center of multi selector).</p>
---	---	--

<p>4</p>		<p>When printing is complete, message shown at left is displayed for about two seconds, followed by PictBridge menu. Turn camera off and disconnect USB cable.</p>
-----------------	---	--

📷 DPOF Printing

The **DPOF printing** option is only available if pictures have previously been selected for printing using **Print set** (📷 50–51). Shooting information (📷 51) will not be included when pictures are printed via direct USB connection.

Menu Guide

The Shooting Menu

The shooting menu contains the following options:

Option	Description	
Image mode	Choose image size and quality.	59
White balance	Match white balance to the light source.	60
Exp. +/-	Adjust exposure for very bright, very dark, or high-contrast subjects.	61
Continuous	Take pictures one at a time or in a sequence.	61–62
BSS	Use the Best Shot Selector (BSS).	63
Sensitivity	Control the camera's sensitivity to light.	64
Color options	Control color.	64
Setup	Display the setup menu.	72

To display the shooting menu, slide the mode selector to and press the **MENU** button. To make a selection from the shooting menu:

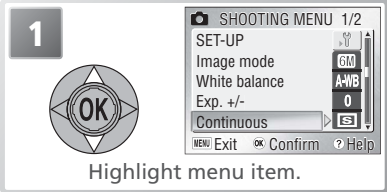
- 

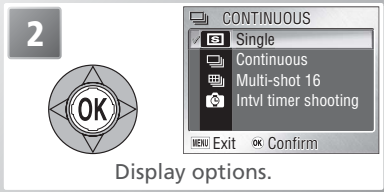
Highlight menu item.
- 

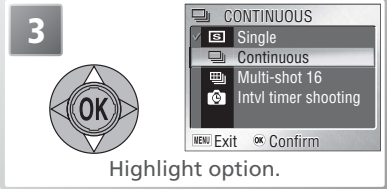
Display options.
- 

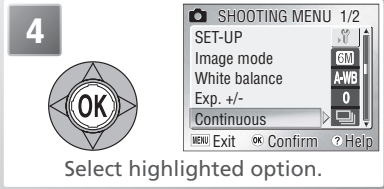
Highlight option.
- 

Select highlighted option.

To exit the menu and return to shooting mode, press the **MENU** button again, or press the button to exit to playback mode. Defaults can be restored using the **Reset all** option in the setup menu (79).

Menu Options

For help on the selected option, press the zoom control to (T) (21). To display menu options as icons, select **Icons** for **Menus** in the setup menu (80).

Image Mode



Pictures taken with a digital camera are recorded as image files. The size of the files, and with it the number of images that can be recorded, depends on the *size* and *quality* of the images (image mode). Before shooting, choose an image mode according to how you plan to use the picture.

Option	Size (pixels) [*]	Compression ratio [†]	Description	Print size (cm/in.) [‡]
High (2816*)	2,816 × 2,112	1:4	High quality, suitable for enlargements or high-quality prints.	24 × 18/ 9½ × 7
Normal (2816)	2,816 × 2,112	1:8	Best choice in most situations.	24 × 18/ 9½ × 7
Normal (2048)	2,048 × 1,536	1:8	Smaller size allows more pictures to be stored on memory card.	17 × 13/ 7 × 5
PC screen (1024)	1,024 × 768	1:8	Suited to printing at smaller sizes (for example, in a letter or report) or to display on computer monitors 17 in. or larger.	9 × 7/ 3½ × 2½
TV screen (640)	640 × 480	1:8	Can be displayed full screen on television or 13 in. monitor. Suited to distribution by e-mail or web.	5 × 4/ 2 × 1½

* Smaller images create smaller files that require less memory and are suited to transmission by e-mail or use in web pages. When printed at larger sizes, however, small images will be rough and uneven in appearance.

† To reduce the amount of memory each shot occupies, pictures are compressed as they are saved. Compression selectively reduces the quality of the image. The more a picture is compressed, the more noticeable this loss of quality is likely to be. The figures show the approximate compression ratio for each setting.

‡ All figures are approximate. The size of images when printed depends on the printer resolution: the higher the resolution, the smaller the final print size. The print sizes given here assume a printer resolution of approximately 300 dpi.

Image Mode

The current image mode is shown by an icon in the display (📷 4–5). See the Appendix for more information on image mode and file size (📷 92).

A-WB White Balance



The color of the light reflected from an object varies with the color of the light source. The human brain is able to adapt to such changes in color, with the result that we see white objects as white, regardless of whether they are in the shade, direct sunlight, or under incandescent lighting. Digital cameras can mimic this adjustment by processing pictures according to the color of the light source. This process is known as a “white balance adjustment.”

Option	Description
A-WB Auto	White balance automatically adjusted to suit lighting conditions. Best choice in most situations.
PRE White bal. preset	Gray object used as reference to set white balance under unusual lighting conditions.
Daylight	White balance adjusted for taking pictures under clear skies.
Incandescent	Use under incandescent lighting.
Fluorescent	Use under most types of fluorescent lighting.
Cloudy	Use when taking pictures under overcast skies.
Flash	Use with the flash.

PRE Preset White Balance

Preset white balance is used with mixed lighting or to compensate for light sources with a strong color cast (for example, to make pictures taken under a lamp with a red shade look as though they had been taken under white light). When **PRE (White bal. preset)** is selected from the white-balance menu, the camera will zoom in and the following options will be displayed:

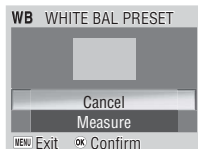

Option	Description
Cancel	Recalls the most recent value for preset white balance from the memory and sets white balance to this value.
Measure	To measure a new value for white balance, place a neutral gray object, such as a piece of cardboard, under the lighting that will be used in the final picture. Frame this object so that it fills the square in the center of the menu shown above. Highlight Measure and press the center of the multi-selector to measure a new value for white balance (shutter will be released and camera will return to original zoom position, but no picture will be recorded). Note that preset white balance can not be measured with the flash.

White Balance

The effects of white balance are visible in the monitor. At settings other than **A-WB (Auto)**, white balance is also shown by an icon in the display (4–5).

Exposure Compensation









Exposure compensation is used to alter exposure from the value suggested by the camera by from -2.0 EV (underexposure) to $+2.0$ EV (overexposure) in increments of $\frac{1}{3}$ EV. Its effects can be previewed in the monitor; *negative* values may be needed when most of the frame is very dark or the background is much darker than the main subject, *positive* values when most of the frame is very bright or the background is much brighter than the main subject.

Continuous





Use the options in this menu to capture a fleeting expression on a portrait subject, photograph a subject that is moving unpredictably, or capture motion in a series of pictures.

Option	Description
 Single	One shot is taken each time shutter-release button is pressed.
 Continuous*	While shutter-release button is pressed, camera takes pictures at rate of up to 1.3 fps until  (wait) icon is displayed.
 Multi-shot 16*	Each time shutter-release button is pressed, camera takes sixteen consecutive pictures 704 × 528 pixels in size at rate of about 1.3 fps and arranges them in four rows to form a single picture measuring 2,816 × 2,112 pixels. Image mode automatically set to 6M Normal (2816) . Digital zoom can not be used. 
 Intvl timer shooting	Camera takes pictures automatically at specified interval. See “Interval Timer Photography” ( 62).

* Flash turns off automatically. Focus, exposure, and white balance are fixed at values for first picture in each series.

Restrictions on Camera Settings

Continuous is automatically set to **Single** when the self-timer is activated ( 19) or BSS is enabled ( 63).

The Memory Buffer

During shooting, pictures are stored in a temporary memory buffer before being transferred to internal memory or to the memory card for permanent storage. The number of pictures that can be stored depends on image mode; the maximum at **6M Normal (2816)** is six. When the buffer is full, a  (wait) icon will be displayed and shooting will be suspended. More pictures can be taken as soon as enough memory becomes available in the buffer.



Continuous

At settings other than **Single**, the current “continuous” setting is shown by an icon in the display ( 4–5).

Interval Timer Photography

To display the interval timer menu, highlight **Intvl timer shooting** in the CONTINUOUS menu and press the center of multi selector.

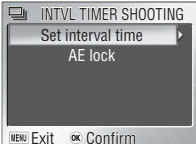
1



INTVL TIMER SHOOTING

Set interval time

AE lock

MENU Exit OK Confirm



SET INTERVAL TIME 1/2

30s

1m

5m

10m

30m

MENU Exit OK Confirm



AE LOCK

Off

On

MENU Exit OK Confirm

Highlight **Set interval time** or **AE lock** and press center of multi selector to display sub-menu. Press multi selector up or down to highlight option, press center to select.

- **SET INTERVAL TIME:** Choose interval between shots.
- **AE LOCK:** Choose **On** to fix exposure and white balance for entire series at values for first frame, **Off** to meter new values for each shot. When **On** is selected for **AE lock**, flash turns off automatically.

2

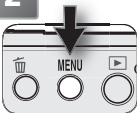

Exit to shooting mode.

3



Start recording. Camera will take pictures at specified interval until shutter-release button is pressed again, memory is full, or 1,800 frames have been recorded.

Interval Timer Photography





To save power, the monitor turns off between frames. The monitor turns on automatically immediately before the camera takes the next shot. To ensure that the batteries do not run flat before recording is complete, use an EH-62B AC adapter kit (available separately).

Pictures can not be played back during interval timer shooting. See the Appendix for information on how pictures taken during interval timer shooting are stored  92–93.

BSS Best Shot Selector (BSS)



The options in the “best-shot selector” (BSS) menu are recommended for situations in which inadvertent camera movement can produce blurred pictures, or when parts of the image are prone to under- or over-exposure.

Option	Description
 Off	BSS off. 
BSS On	Camera takes shots while shutter-release button is pressed, to a maximum of ten. These images are then compared and sharpest picture (picture with highest level of detail) is saved. Flash turns off automatically and focus, exposure, and white balance for all photos are determined by first picture in each series. Recommended for situations in which inadvertent camera movement can produce blurred pictures, for example when: <ul style="list-style-type: none">• the camera is zoomed in• macro close-up is in effect• lighting is poor and the flash can not be used May not produce desired results if subject moves or composition is changed while shutter-release button is fully pressed. 
 Exposure BSS	Selecting this option displays sub-menu shown at right. Choose from: <ul style="list-style-type: none">• Highlight BSS: picture with smallest area of overexposure is selected.• Shadow BSS: picture with smallest area of underexposure is selected.• Histogram BSS: of pictures with least under- and over-exposure, camera chooses picture with overall exposure closest to optimum. Camera takes five shots each time shutter-release button is pressed, but only picture that best meets selected criterion is saved. Flash turns off automatically and focus and white balance for all photos are determined by first picture in each series. Recommended for high-contrast subjects, when it is difficult to set exposure correctly. 

Restrictions on BSS

BSS turns off when the self timer is activated ( 19) or a setting other than **Single** is selected for **Continuous** ( 61).

BSS

At settings other than **Off**, the current BSS setting is indicated by an icon in the display ( 4–5).

ISO Sensitivity



Sensitivity (ISO equivalency) is a measure of how quickly the camera reacts to light. The higher the sensitivity, the less light needed to make an exposure. Much as film with a high ISO rating tends to produce “grainy” images, high sensitivities may however be associated with “noise”—randomly spaced, brightly colored pixels concentrated in dark parts of the image.

Option	Description
Auto	Equivalent to 50 under normal conditions; when lighting is poor and flash is off (🔴), camera compensates by raising sensitivity to a maximum of ISO 200. ISO icon displayed in monitor to warn that pictures may be affected by noise.
50	Approximately equivalent to ISO 50. Recommended unless lighting is poor or faster shutter speeds are required (e.g., when the subject is moving). Noise may appear in pictures taken at settings above this value.
100	Approximately equivalent to ISO 100.
200	Approximately equivalent to ISO 200.
400	Approximately equivalent to ISO 400.

Color Options



Color options are used to heighten the vividness of colors or to record pictures in monochrome. The effects can be previewed in the monitor.

Option	Description
Standard color	Subjects are recorded in their natural colors.
Vivid color	Use for a vivid, photoprint effect.
Black-and-white*	Pictures are recorded in black-and-white.
Sepia*	Pictures are recorded in sepia.
Cyanotype*	Pictures are recorded in blue-tinted monochrome.

* White balance set to **Auto**.

Sensitivity

At settings other than **Auto**, the current sensitivity setting is shown in the display (📷 4–5).

Color Options

At settings other than **Standard color**, the current color option setting is indicated by an icon in the display (📷 4–5).

The Playback Menu

The playback menu contains the following options:

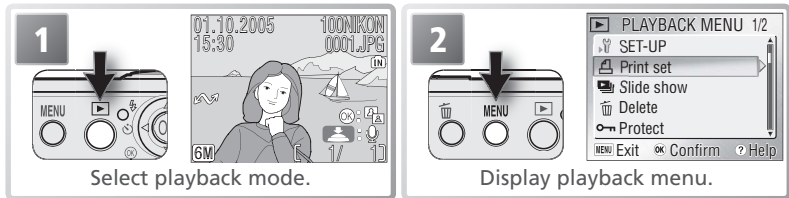

Option	Description	
Print set	Select pictures for printing on DPOF- and PictBridge-compatible devices.	50–51
Slide show	View pictures in an automatic slide show.	67
Delete	Delete all or selected pictures.	68
Protect	Protect selected pictures from accidental deletion.	68
Transfer marking	Change transfer marking of all or selected pictures.	69
Small pic.	Create small copies of the current picture.	70
Copy	Copy files between memory card and internal memory.	71
Setup	Display the setup menu.	72

To display playback menu options for the current picture:



To exit the menu and return to playback mode, press the **MENU** button again, or press the  button again to exit to shooting mode.

Menu Options

For help on the selected option, press the zoom control to  (T)  (21). To display menu options as icons, select **Icons** for **Menus** in the setup menu  (80).

Selecting Multiple Pictures

To select multiple pictures in the **Erase selected images** (🗑️ 68), **Print set** (🖨️ 50–51), **Protect** (🔒 68), **Transfer marking > Select image(s)** (🗑️ 69), or **Copy > Selected images** (🗑️ 71) menus:

1

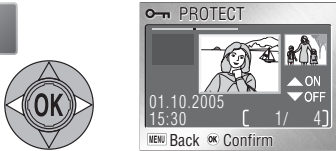

Scroll through pictures. Current picture shown at center of display.

2

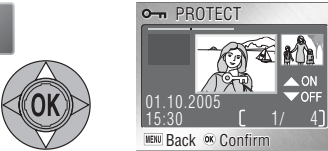

Select current picture. Selection shown by icon.

3 Repeat steps 1–2 to select additional pictures. To deselect picture, select and press multi selector down. To cancel changes and exit, press **MENU** button.

4



Complete operation.

Slide Show



This option is used to play pictures back in an automated “slide show” with about three seconds between each picture.

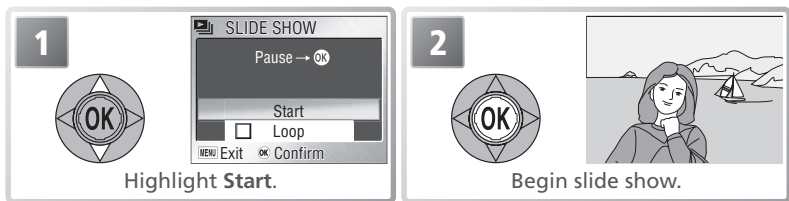

To skip to the next picture, press the multi selector to the right, or hold the multi selector down to fast forward through the show. To return to the previous picture, press the multi selector left, or hold the multi selector down to rewind through the show. To pause the slide show, press the center of the multi selector. The menu shown below will be displayed.

When the slide show ends or is paused, the menu shown at right will be displayed. Highlight **Restart** and press the center of the multi selector to restart the show, or select **End** to end the show and return to the playback menu.

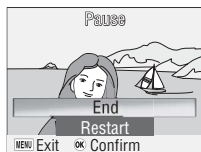

Slide Shows

The camera will enter standby mode if no operations are performed for thirty minutes.

Copies created with the small picture option (70) are not displayed during slide shows. Movies are displayed as still images showing the movie's first frame.

“Loop”



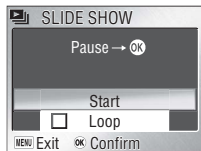

If **Loop** is selected in the starting screen, the slide show will repeat automatically. To select or deselect the loop option, highlight **Loop** and press the center of the multi selector. A check mark next to **Loop** indicates that the loop option is selected.



Delete





The delete menu contains the following options:

Option	Description
 Erase selected images	Select images for deletion ( 66). Confirmation dialog shown at right will be displayed; press multi selector up or down to highlight option, press center to select: <ul style="list-style-type: none">• Select No to exit without deleting pictures• Select Yes to delete selected pictures 
 Erase all images	Confirmation dialog displayed; press multi selector up or down to highlight option, press center to select: <ul style="list-style-type: none">• Select No to exit without deleting pictures• Select Yes to delete all unprotected pictures 

If no memory card is inserted, pictures will be deleted from internal memory. If a memory card is inserted, pictures will be deleted from the memory card.



Protect



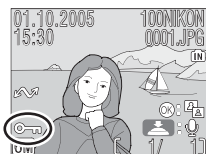



Select pictures for protection from accidental deletion. Protected files are marked with a protect icon (see right) and can not be deleted by pressing the  button or using the options in the **Delete** menu. Note, however, that protected pictures *will* be deleted when the memory card or internal memory is formatted ( 78).



Transfer Marking

This option is used to mark pictures for transfer to any computer to which PictureProject has been installed ( 46). Note that all new pictures are automatically marked for transfer when **On** (the default option) is selected for **Interface > Auto transfer** ( 79).

Option	Description
 All on	Mark all images for transfer.
 All off	Remove transfer marking from all images.
 Select image(s)	Mark selected pictures for transfer ( 66).

Pictures selected for transfer are identified by a  icon as shown at below.



Full-frame playback



Thumbnail playback

Restrictions on Auto Transfer



No more than 999 pictures can be transferred using **Auto transfer**. To transfer more than 999 pictures, use PictureProject or select and transfer pictures in batches of 999 or less. See the PictureProject reference manual (on CD) for more information.

The COOLPIX S4 can not be used to transfer pictures selected for transfer with another model of Nikon digital camera. Use the COOLPIX S4 to reselect the pictures.





Small Picture



Small copies of pictures can be created in any of the following sizes:

Option	Description
 640 × 480	Can be displayed full frame on TV.
 320 × 240	Suited to display on web pages. Small file size reduces time needed to display picture in web browser.
 160 × 120	Can be sent and received quickly as e-mail attachment.

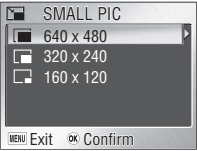
To copy a picture at a smaller size:



- 1 After displaying picture in full-frame playback or highlighting picture in thumbnail display ( 41), select **Small pic.** from playback menu ( 65).
- 2   Highlight option.
- 3   Confirmation dialog displayed. Press multi selector up or down to highlight option, press center to select:

 - **Yes:** create resized copy
 - **No:** exit without creating copy

During playback, copies are indicated by a gray border; a , , or  icon is displayed when copies are viewed full-frame.

Small Picture



Copies are stored as JPEG files with a compression ratio of 1 : 16. Copies are created with the same transfer marking and date and time or recording as the original, but any changes to transfer marking or to protect and print attributes must be made separately. See the Appendix for more information on how small pictures are stored ( 92–93).

Copies can only be created if sufficient memory is available. Small copies may not display or transfer correctly when viewed on other models of Nikon camera. Small copies can not be created from movies ( 40), cropped copies ( 42), or small pictures.

Copy





This option is only available when a memory card is inserted, when it can be used to copy pictures between internal memory and the memory card.

Option	Description
	Copy pictures from internal memory to memory card.
	Copy pictures from memory card to internal memory.

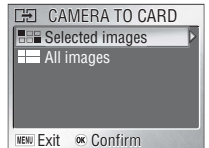
Selecting either of the above options displays the menu shown at right.



Option	Description
 Selected images	Select images for copying ( 66). Confirmation dialog shown at right will be displayed; press multi selector up or down to highlight option, press center to select: <ul style="list-style-type: none">• Select No to exit without copying pictures• Select Yes to copy selected pictures
 All images	Confirmation dialog displayed; press multi selector up or down to highlight option, press center to select: <ul style="list-style-type: none">• Select No to exit without copying pictures• Select Yes to copy all pictures

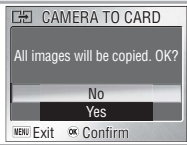
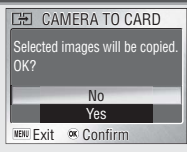

Copy

See “Copying Voice Recordings” for information on copying voice recordings ( 35). The camera may be unable to copy pictures that were created with another make of camera or that have been modified on a computer.

Copies lose all print ( 50–51) and transfer ( 69) marking. Protect marking ( 68) is not affected. See the Appendix for more information on copies are stored ( 92–93).

The Setup Menu

The setup menu contains the following options:

Option	Description	
Shooting menu		58
Scene menu		21
Movie	Return to menu for current mode.	36
Playback menu		65
Welcome screen	Select screen displayed when camera is turned on.	73
Date	Set clock and choose home and destination time zones.	10–11 74–75
Brightness	Adjust monitor brightness.	75
Date imprint	Imprint date or birthday counter on pictures.	76
Sound settings	Adjust sound and volume settings.	77
Blur warning	Turn blur warning on or off.	77
Auto off	Choose when monitor will turn off to save power.	78
Format memory/ Format card	Format internal memory or memory card.	78
Language	Choose language for camera menus and messages.	79
Interface	Adjust settings for connection to television or computer.	79
AF assist	Turn AF-assist illuminator on or off.	79
Reset all	Restore camera settings to default values.	79–80
Battery type	Match this setting to type of batteries in camera.	80
Menus	Choose how menus are displayed.	80
Firmware version	Display camera firmware version.	80

To display the setup menu:

1



Display menu for current mode.

2



Highlight **SET-UP**.

3



Display setup menu. To return to menu for current mode, press **MENU** button.



Menu Options

For help on the selected option, press the zoom control to (T) (21). To display menu options as icons, select **Icons** for **Menus** in the setup menu (80).

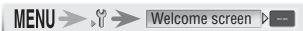
Welcome Screen

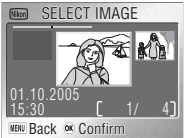

Choose the welcome screen displayed when the camera is turned on.

Option	Description
Disable welcome (default)	No welcome screen is displayed when camera is turned on.
Nikon	Image shown at right is displayed when camera is turned on. 
Animation	Animation shown at right is displayed when camera is turned on. 
Select an image	Choose welcome screen from pictures in internal memory or on memory card. Selecting this option displays selection screen shown at right; press multi selector left or right to scroll through pictures, press center to select. To exit without changing welcome screen, press MENU button. 

Welcome Screen

If **Select an image** is chosen after a custom welcome screen has been selected, the confirmation dialog shown at right will be displayed. Select **Yes** to replace the existing picture with the new welcome screen, **No** to exit leaving the welcome screen unchanged.

Small Pictures and Cropped Copies

Copies created with the small picture and cropping options can only be selected for the welcome screen if they are 640 × 480 pixels or larger.



⌚ Date

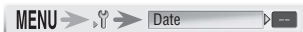

This option is used to set the camera clock and to choose home and travel destination time zones.

Option	Description
Date	Set camera clock to current date and time (⌚ 10-11).
Time zone	Choose home (🏠) or travel destination (➔) time zone; turn daylight saving time on or off (see below).

Time Zone

Selecting **Time zone** displays the menu shown in Step 1. To choose a new home (🏠) or travel destination (➔) time zone:

1

Highlight 🏠 or ➔.

2

Display map of world time zones.

3

Highlight time zone.*

4

Select time zone. Press MENU button to menu shown in Step 1.

* Travel destination time zone can not be same as home time zone.

To switch between home (🏠) and travel destination (➔) time zones:

1

Highlight 🏠 or ➔.†

2

Set clock to time in selected zone. Dot marks current selection.

† To turn daylight saving time on or off, highlight **DaylightSaving** and press center of multi selector. Selecting daylight saving time advances time in selected zone one hour.

Brightness

Press the multi selector up or down to increase or decrease the brightness of the monitor by moving the arrow to the left of the display up or down. Press the center of the multi selector to put the new setting into effect.

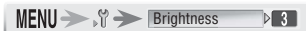

Time Zones

The time zone can not be selected if the date and time have not been set.

The camera supports the time zones listed below. Increments of less than one hour are not supported; when travelling to or from destinations at half- or quarter-hour increments from Greenwich Mean Time (GMT), such as Afghanistan, Central Australia, India, Iran, Nepal, or Newfoundland, set the camera clock to local time ( 10–11).

GMT +/-	Location
GMT -11	Midway, Samoa
GMT -10	Hawaii, Tahiti
GMT -9	Alaska, Anchorage
GMT -8	PST (PDT): Los Angeles, Seattle, Vancouver
GMT -7	MST (MDT): Denver, Phoenix, La Paz
GMT -6	CST (CDT): Chicago, Houston, Mexico City
GMT -5	EST (EDT): New York, Toronto, Lima
GMT -4	Caracas, Manaus
GMT -3	Buenos Aires, São Paulo
GMT -2	Fernando de Noronha
GMT -1	Azores
GMT	London, Casablanca

GMT +/-	Location
GMT +1	Madrid, Paris, Berlin
GMT +2	Athens, Helsinki
GMT +3	Moscow, Nairobi
GMT +4	Abu Dhabi, Dubai
GMT +5	Islamabad, Karachi
GMT +6	Colombo, Dhaka
GMT +7	Bangkok, Jakarta
GMT +8	Beijing, Hong Kong (HK), Singapore
GMT +9	Tokyo, Seoul
GMT +10	Sydney, Guam
GMT +11	New Caledonia
GMT +12	Auckland, Fiji

The Camera Clock

The camera clock is less accurate than most watches or household clocks. Check the clock regularly against more accurate timepieces and reset as necessary.

DATE Date Imprint

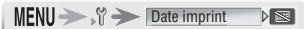

This option is used to imprint date information on pictures as they are taken. It can not be used to imprint date information on existing pictures.

Option	Description
Off	Time and date do not appear on pictures.
Date	Date is imprinted on pictures taken while this option is in effect.
Date and time	Date and time are imprinted on pictures taken while this option is in effect.
Date counter	Time stamp shows number of days between date of shooting and selected date.

Date Counter

Pictures taken while this option is in effect are imprinted with the number of days remaining until or the number of days elapsed since a specified date. Use it to track the growth of a child or count down the days until a birthday or wedding. Days remaining are indicated by ▲.

Stored dates: To choose from up to three dates between Jan. 1 1910 and Dec. 31 2037, highlight current date and press center of multi selector. Menu shown at right will be displayed. To set date, highlight, press multi selector to right, and enter date as described in “Basic Setup” (📄 10–11). To select existing date, highlight and press center of multi selector.

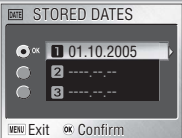

Display options: To change date display format, highlight current format and press center of multi selector. Press multi selector up or down to highlight **Number of days, Years and days, or Yrs, mnths, days** and press center to select.

Date Imprint

Data imprinted at an **Image mode** setting of **TV screen (640)** may be difficult to read. Choose a setting of **PC screen (1024)** or larger when using the date imprint option (📄 59).

Regardless of the setting chosen, the date is not imprinted in movie mode (📄 36) or when or (except for sport composite) is selected in scene mode (📄 21), **Continuous** is selected for **Continuous**, or an option other than **Off** is selected for **BSS** (📄 61, 63).

Imprinted data form a permanent part of the image and will appear whenever the image is printed, regardless of whether the date option is chosen in the **Print set** menu. At settings other than **Off**, a date imprint icon appears in the shooting display during shooting (📄 4–5).

The date is recorded in the order selected in the DATE menu. **Date imprint** can not be selected if the camera clock has not been set (📄 10–11).

Sound Settings



The options in this menu control the sound settings listed below.

Option	Description
Button sound	If On is selected, beep will sound once if memory card is inserted, data are deleted, memory card or internal memory is formatted, or new mode is selected. Beep will sound three times if batteries are exhausted, or if memory card is locked or memory card or internal memory is full when shutter is released.
Shutter sound	Choose volume of sound played when shutter is released. If Off is selected, no sound will be played when shutter is released. Regardless of setting chosen, no sound is played in sports (26) or movie (36) modes, when Continuous or Multi-shot 16 is selected for Continuous (61), or BSS is enabled (63).
Start-up sound	Choose volume of sound played when camera is turned on. If Off is selected, no sound will be played when camera is turned on. Startup sound will not play when USB cable is connected (47, 52).

Blur Warning



If **On** is selected for this option, the warning shown at right will be displayed after shooting in situations in which pictures may be blurred. Select **Yes** to record the picture, **No** to delete the picture and try again. The picture will be recorded automatically if no operations are performed for about twenty seconds. No warning will be displayed in movie mode, at scene-mode settings of Sports, Museum, Fireworks show, or Panorama assist, or when the self-timer is on, an option other than **Single** is selected for **Continuous**, or an option other than **Off** is selected for BSS.

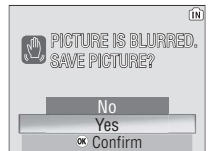

A setting of **On** is recommended when the camera is zoomed in. If you wish to view the picture before deleting it, select **Yes** in the blur warning dialog and then press the button.

1m Auto Off



Choose the time before the monitor turns off automatically to save power (👁 10).

Option	Description
Auto off	Choose delay before monitor turns off when no operations are performed.
Sleep mode	If On is selected, monitor will turn off if no change is detected in brightness of subject for 30s (Auto off set to 1 min. or less) or 1min. (Auto off set to 5 min. or more).

Regardless of the option selected, the monitor will remain on for a minimum of three minutes when menus are displayed, and for thirty minutes during a slide show or when the camera is powered by an optional EH-62B AC adapter.

IN Format Memory/

Format Card



If no memory card is inserted, this option is named **Format memory** and formats internal memory. Otherwise it is named **Format card** and formats the memory card for use in the camera. *Note that formatting permanently deletes all data, including protected pictures and any other files that may be present.* Before formatting, be sure to transfer any valued pictures to a computer (👁 46–49).

The following options will be displayed if a memory card is inserted:

Option	Description
Quick format	Format applies only to areas in which data are stored. Faster than normal format.
Format	Entire memory or memory card is formatted.

A confirmation dialog is displayed before formatting begins. Select **Format** to format the storage device. The message shown at right will be displayed; *do not turn the camera off, remove the batteries or memory card, or unplug the AC adapter while this message is displayed.*



Format Card

Format memory cards before first use and reformat them regularly thereafter. Without regular formatting, performance will drop with use. Note that memory cards can not be formatted when the battery is low.

Language



Choose the language for camera menus and messages (10).

Interface



Adjust settings for connection to a computer or video device (45, 46).

Option	Description
USB	Select USB option for connection to computer (46) or printer (52).
Video mode	Before connecting camera to video devices such as televisions or VCRs (45), choose video mode that matches video standard used in device. Camera supports NTSC and PAL standards.
Auto transfer	Choose On to mark pictures for transfer to computer as they are taken.

AF Assist



If **Auto** is selected for this option, the AF-assist illuminator will light to assist the focus operation when the subject is poorly lit. The AF-assist illuminator has a maximum range of about 2m/6ft. 7in. The AF-assist illuminator will not light if **Off** is selected for AF assist, (landscape assist), (sports assist), (Dusk/Dawn), (Night landscape), (Close up), (Museum) or (Fireworks show) is selected in scene mode, a setting other than PORTRAIT is selected in (portrait assist) mode, or a setting other than NIGHT PORTRAIT is selected in (night portrait assist) mode.

Reset all



Select **Reset** to restore the following settings to their original state:

Option	Description
Flash mode	Auto
Self timer	Off
Macro close-up	Off
Movie mode	
Movie options	Small size 320
Auto-focus mode	Single AF
Electronic VR	Off
Scene mode	Party/Indoor
Portrait assist	Face-priority AF
Landscape assist	LANDSCAPE
Sports assist	SPORTS
Night portrait assist	NIGHT PORTRAIT

Option	Description
Image mode	Normal (2816)
White balance	Auto
Exp. +/-	±0
Continuous	Single
BSS	Off
Sensitivity	Auto
Color options	Standard color
Welcome screen	Disable welcome
Brightness	3
Date imprint	Off

Option	Description
Sound settings	
Button sound	On
Shutter sound	Normal
Start-up sound	Off
AF-assist	Auto
Blur warning	On

Option	Description
Auto off	
Auto off	1 min.
Sleep mode	Off
Interface	
Auto transfer	On
Menus	Text

Choosing **Reset** also clears the current file number (📷 4–5, 92–93) from memory. Numbering will continue from the lowest number available. All other settings are unaffected.

✍️ *Resetting File Numbering to 0001*

To reset file numbering to 0001, select **Reset all** after either deleting all pictures (📷 68) or formatting the memory card or internal memory (📷 78).

🔋 **Battery Type**

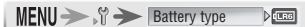

To ensure that the camera shows the correct battery level (📷 12), choose a type that matches the batteries currently in use.

Option	Battery Type
Alkaline	Alkaline
COOLPIX (NiMH)	EN-MH1-B2, oxy-nickel
Lithium	Lithium

Note that **Battery type** may be reset if the clock battery is exhausted.

MENU **Menus**



This option controls how the movie (📷 37), shooting (📷 58), playback (📷 65), and setup menus are displayed. Choose from **Text** and **Icons**.

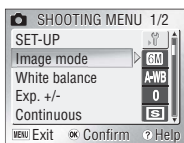

Text

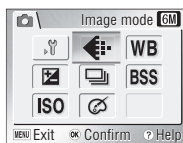

Icons

Ver. **Firmware Version**



Select this option to display the current camera firmware version. Press the multi selector to the left to return to the setup menu.

Technical Notes

Optional Accessories

At the time of writing, the following optional accessories were available for this camera. Contact your local retailer or Nikon representative for details.

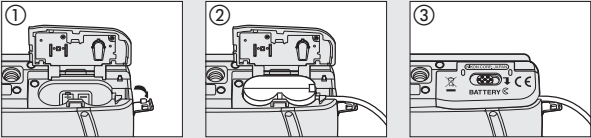
Rechargeable battery	EN-MH1-B2 rechargeable NiMH batteries
Battery charger	MH-71 battery charger
AC adapter	EH-62B AC adapter kit (connects as shown)
	

Approved Memory Cards

The following cards have been tested and approved for use with the COOLPIX S4:

SanDisk	16MB, 32MB, 64MB, 128MB, 256MB, 256MB*, 512MB, 512MB*, 1GB
Panasonic	16MB, 32MB, 64MB, 128MB, 256MB*, 512MB*, 1GB*
Toshiba	16MB, 32MB, 64MB, 128MB, 128MB*, 256MB, 256MB*, 512MB

* High speed (10MB/s)

Operation is not guaranteed with other makes of card. For more details on the above cards, please contact the manufacturer.

Memory Cards

- Use only Secure Digital (SD) memory cards.
- Format memory cards before first use.
- Do not eject the memory card, turn the camera off, or remove or disconnect the power source during formatting or while data are being written to or deleted from the card. Failure to observe this precaution could result in loss of data or damage to the camera or card.
- Do not disassemble or modify.
- Do not drop, bend, or expose to water or strong physical shocks.
- Do not touch the metal terminals with your fingers or metal objects.
- Do not affix labels or stickers to the memory card.
- Do not leave in direct sunlight in a closed vehicle or in other areas exposed to high temperatures.
- Do not expose to high levels of humidity or to corrosive gas.

Caring for the Camera

To ensure continued enjoyment of this Nikon product, observe the following precautions when storing or using the device.

- ✔ **Keep dry**
The device will be damaged if immersed in water or subjected to high levels of moisture.
- ✔ **Handle the lens and all moving parts with care**
Do not apply force to the lens, monitor or to the connector, card slot, or battery-chamber covers. These parts are especially susceptible to damage. Applying force to the lens cover could result in camera malfunction or damage to the lens.
- ✔ **Do not point the lens at strong light sources for extended periods**
Avoid pointing the lens at the sun or other strong light sources for extended periods when using or storing the camera. Intense light may cause deterioration in the CCD image sensor, producing a white blur effect in photographs.
- ✔ **Turn the product off before removing or disconnecting the power source**
Do not unplug the product or remove the batteries while the product is on, or while images are being recorded or deleted. Forcibly cutting power in these circumstances could result in loss of data or in damage to product memory or internal circuitry. To prevent an accidental interruption of power, avoid carrying the product from one place to another while the AC adapter is connected.
- ✔ **Do not drop**
The product may malfunction if subjected to strong shocks or vibration.
- ✔ **Keep away from strong magnetic fields**
Do not use or store this device in the vicinity of equipment that generates strong electromagnetic radiation or magnetic fields. Strong static charges or the magnetic fields produced by equipment such as radio transmitters could interfere with the monitor, damage data stored on the memory card, or affect the product's internal circuitry.
- ✔ **Avoid sudden changes in temperature**
Sudden changes in temperature, such as occur when entering or leaving a heated building on a cold day, can cause condensation inside the device. To prevent condensation, place the device in a carrying case or a plastic bag before exposing it to sudden changes in temperature.
- ✔ **The AF-Assist Illuminator LED**
The light-emitting diode (LED) used in the AF-assist illuminator conforms to the following IEC standard:

CLASS 1 LED PRODUCT
IEC60825-1 Edition 1.2-2001
- ✔ **Do not hold the camera by the lens cap**
The lens cap could become detached, causing the camera to fall and damaging the equipment.

Cleaning

Lens: Avoid touching glass parts with your fingers. Remove dust or lint with a *blower* (typically a small device with a rubber bulb attached to one end that is pumped to produce a stream of air out the other). To remove fingerprints or other stains that can not be removed with a blower, wipe the lens with a soft cloth, using a spiral motion that starts in the center of the lens and works out to the edges. If this fails to clean the lens, wipe with a dry cloth lightly dampened with commercial lens cleaner.

Monitor: Use a blower to remove dust or lint from the protective acrylic covering. To remove fingerprints and other stains, clean the monitor with a soft, dry cloth, being careful not to apply pressure.

Avoid contact with liquid crystal

Should the monitor break, care should be taken to avoid injury due to broken glass and to prevent the liquid crystal from the display touching the skin or entering the eyes or mouth.

Body: Use a blower to remove dust, dirt, or sand then wipe gently with a soft, dry cloth. After using the camera at the beach or seaside, wipe off any sand or salt with a dry cloth lightly dampened with fresh water, then dry thoroughly. The camera may be damaged if foreign matter gets inside the camera body. Nikon cannot accept liability for damage caused by dirt or sand.

Do not use alcohol, thinner, or other volatile chemicals.

Notes on the Monitor

- The monitor may contain a few pixels that are always lit or that do not light. This is a characteristic common to all TFT LCD displays, and does not indicate a malfunction. Images recorded using the product will not be affected.
- When you frame bright subjects, vertical comet-like streaks that whiten toward either end may appear in the display. This phenomenon, known as “smear,” does not appear in the final photograph and does not indicate a malfunction. Some smear may appear in movies.
- Images in the monitor may be difficult to see in a bright light.
- The monitor is lit by an LED backlight. Should the monitor begin to dim or flicker, contact your Nikon service representative.

Storage

Turn the camera off when not in use. Check that the power-on lamp is off before putting the camera away and remove the batteries if the camera will not be used for an extended period. Do not store the camera with naphtha or camphor moth balls or in locations that:

- are next to equipment that produces strong electromagnetic fields, such as televisions or radios
- are exposed to temperatures below -10°C (14°F) or above 50°C (122°F)
- are poorly ventilated or subject to humidities of over 60%











To prevent mold or mildew, take the camera out of storage at least once a month. Turn the camera on and release the shutter a few times before putting the camera away again.









Batteries

- Check the battery level when taking the camera out and replace the batteries if necessary ( 6–7). If possible, carry spare batteries when taking pictures on important occasions.
- Battery capacity tends to decrease on cold days. Be sure that the batteries are fresh before heading outside to take pictures in cold weather. Keep spare batteries in a warm place and exchange as necessary. Once warmed, a cold battery may recover some of its charge.
- Dirt on the battery terminals can prevent the camera from functioning.
- Used batteries are a valuable resource. Please recycle used batteries in accordance with local regulations.

Error Messages

The following table lists the error messages and other warnings that appear in the monitor and how to deal with them.

Display	Problem	Solution	
 (Flashes)	Clock not set.	Set clock.	10–11
WARNING!! BATTERY EXHAUSTED	Batteries exhausted.	Turn camera off and replace batteries.	6, 7, 10
AF● (● flashes red)	Camera cannot focus.	Use focus lock to focus on another subject at same distance, then recompose picture.	15, 91
 (Flashes)	Slow shutter speed. Pictures may be blurred.	Use flash, or steady camera using tripod, by placing camera on level surface, or by holding camera in both hands with elbows against torso.	3, 13, 17
WARNING!! PLEASE WAIT FOR THE CAMERA TO FINISH RECORDING 	Camera turned off or  button pressed during recording.	Message clears from display automatically when recording is complete.	15
MEMORY CARD IS WRITE PROTECTED	Write-protect switch is in “lock” position.	Slide write-protect to “write” position.	8
THIS CARD CANNOT BE USED 		<ul style="list-style-type: none"> • Use approved card. • Check that connectors are clean. 	81 —
WARNING!! THIS CARD CANNOT BE READ  (Flashes)	Error accessing memory card.	<ul style="list-style-type: none"> • Turn camera off and confirm that memory card is correctly inserted. 	8–9
CARD IS NOT FORMATTED  (Flashes) FORMAT NO 	Memory card has not been formatted for use in camera.	Press multi selector up to highlight FORMAT and press center to format card, or turn camera off and replace card.	8–9, 78
OUT OF MEMORY  or 	<i>Camera in shooting mode:</i> Insufficient memory to record pictures at current settings.	<ul style="list-style-type: none"> • Choose new image mode. • Remove memory card and use internal memory or insert new memory card. • Delete pictures. 	59 8–9 16, 68
	<i>Camera connected to computer:</i> Not enough memory to record information need for transfer.	Delete unwanted pictures and try again.	16, 68

Display	Problem	Solution	
IMAGE CANNOT BE SAVED  or 	<ul style="list-style-type: none"> • Camera has run out of file numbers. • Not enough memory to copy picture using crop, D-lighting, small picture, or copy options. • Original does not support cropping. • Invalid image chosen for welcome screen. 	<ul style="list-style-type: none"> • Select Reset all after either inserting new memory card or formatting the memory card or internal memory. • Format destination or delete pictures. If copying pictures to memory card, insert new memory card. • Crop can not be used with cropped copies and small pictures. • Choose image 640×480 pixels or larger. 	8–9, 78, 79–80 8–9, 16, 68, 78, 42 59
SOUND FILE CANNOT BE SAVED  or 	Camera has run out of file numbers.	Select Reset all after either inserting new memory card or using Format option.	8–9, 78, 79–80
IMAGE HAS ALREADY BEEN MODIFIED. D-LIGHTING CANNOT BE USED.	Original does not support D-lighting.	D-lighting can not be used with copies.	43
FILE CONTAINS NO IMAGE DATA	File created by computer or different make of camera.	View file on computer or correct make of camera.	—
THIS IMAGE CANNOT BE DELETED	Attempt to delete protected picture.	Remove protection before deleting picture.	68
NO SOUND FILE.	No sound file available for playback.	Press  button to return to shooting mode and record sound file.	33
THERE ARE NO MORE INDEX POINTS	Sound recording contains no indices.	Insert index before using  or  options.	33
CANNOT RECORD MOVIE	Time out error while recording movie.	Choose memory card with better performance.	81
NEW CITY IS IN THE CURRENT TIME ZONE	Travel destination is in same time zone as home location.	No need to specify new time zone if travel destination and home are in same time zone.	74–75
WARNING! THE MODE SELECTOR IS NOT IN THE PROPER POSITION	Mode selector is positioned between two modes.	Adjust mode selector to select desired mode.	2
MEMORY CONTAINS NO IMAGES	No pictures on memory card or in internal memory.	Press  button to return to shooting mode.	12, 16
ALL IMAGES ARE HIDDEN	Pictures can not be viewed on COOLPIX S4.		



Display	Problem	Solution	
TRANSFER ERROR	Pictures can not be copied to computer.	Restart transfer after checking that camera is connected and batteries are fully charged.	12, 46–49
TRANSFER CANCELLED	Transfer cancelled.		
NO IMAGES ARE MARKED FOR TRANSFER	No pictures selected for transfer when OK is pressed to copy pictures to computer.	Disconnect camera and select at least one picture for transfer, then begin transfer again.	69
COMMUNICATIONS ERROR	<ul style="list-style-type: none"> • PictureProject is not running. • USB cable disconnected while pictures are being printed or copied to computer. • USB option set incorrectly. 	<ul style="list-style-type: none"> • Start PictureProject before pressing center of multi selector. • If error appears in computer monitor, click OK to exit PictureProject. Turn camera off, reconnect cable, then turn camera on and print or transfer pictures. • Turn camera off and disconnect cable, then choose new USB setting in camera setup menu and reconnect camera. If error persists, use Transfer button in PictureProject to transfer pictures. 	— 46–49, 52–57 10, 46–49
PRINTER ERROR CHECK PRINTER STATUS	Printer error.	Check printer. To resume printing, highlight Resume and press center of multi selector. Select Cancel to exit without printing remaining images.	—
SYSTEM ERROR	Error has occurred in camera's internal circuitry.	Turn camera off, unplug AC adapter, remove and reinsert batteries, and turn camera on. If error persists, contact retailer or Nikon representative.	7, 10, 81
LENS ERROR	Error has occurred during lens operation.	Turn camera off and then on again. If error persists, contact retailer or Nikon representative.	10

Troubleshooting

If the camera fails to function as expected, check the list of common problems below before consulting your retailer or Nikon representative. Refer to the page numbers in the right-most column for more information.

Electronically-Controlled Cameras

In extremely rare instances, unusual characters may appear in the monitor and the camera may stop functioning. In most cases, this phenomenon is caused by a strong external static charge. Turn the camera off, remove and replace the batteries and/or disconnect and reconnect the AC adapter, and turn the camera on again. In the event of continued malfunction, contact your retailer or Nikon representative. Note that disconnecting the power source as described above may result in the loss of any data not recorded to internal memory or the memory card at the time the problem occurred. Data already recorded will not be affected.

Problem	Solution	
Monitor is blank	• Camera is off.	10
	• Batteries are not correctly inserted or battery-chamber cover is not properly latched.	7
	• Batteries are exhausted.	12
	• AC adapter is not properly connected.	81
	• Standby mode: press shutter-release button halfway.	78
	• USB or audio/video cable connected.	45, 47
	• Voice recording in progress: press  button to turn monitor on.	33
	• Time-lapse or interval-timer shooting in progress.	39, 62
• Lens cap is closed: open lens cap.	—	
No indicators appear in monitor	Press  button until indicators are displayed.	13
Monitor is hard to read	• Monitor brightness needs adjustment.	75
	• Monitor has dimmed to save power: press shutter-release button halfway.	10
	• Monitor is dirty: clean monitor.	83
No picture is taken when shutter-release button is pressed	• Camera is in playback mode.	16, 41
	• Batteries are exhausted.	12
	• Flash lamp blinks: flash is charging.	15
	• Display shows "CARD IS NOT FORMATTED": memory card is not formatted for use in camera.	78
	• Display shows "OUT OF MEMORY": insufficient memory to record picture at current Image mode setting.	59
	• Display shows "MEMORY CARD IS WRITE PROTECTED": memory card is locked.	8

Problem	Solution	8
Pictures are out of focus	<ul style="list-style-type: none"> • Camera can not focus on selected subject using autofocus. Use focus lock. • AF-assist illuminator is off. Select Auto for AF assist. • Focus error. Turn camera off and then on again. 	91 79 10
Pictures are blurred	<p>Camera shook during shot. Blurring caused by camera shake can be reduced by:</p> <ul style="list-style-type: none"> • Using the flash • Using the Best Shot Selector (BSS) • Using the self-timer with a tripod 	17 63 19
Bright specks in picture	Flash is reflecting from particles in air. Turn flash off.	17–18
Flash does not fire	<p>Flash is off. Flash turns off automatically when:</p> <ul style="list-style-type: none"> • LANDSCAPE, Scenic view, or Architecture is selected in landscape assist mode • Camera is in sports assist mode • Night landscape, Museum, Fireworks show, or Dusk/Dawn is selected in scene mode • Sunset, Copy, or Panorama assist is selected in scene mode (other flash modes can be selected) • Option other than Time-lapse movie is selected in movie mode • Continuous or Multi-shot 16 is selected for Continuous • BSS is enabled 	25 26 29–30 29–31 36 61 63
Randomly-spaced bright pixels (“noise”) appear in image	<p>Shutter speed too slow. Noise can be reduced by:</p> <ul style="list-style-type: none"> • Using the flash • Selecting scene mode and choosing Night portrait, Night landscape, or Dusk/Dawn as appropriate to subject and lighting conditions 	17 27, 29
Pictures are too dark (underexposed)	<ul style="list-style-type: none"> • Flash is off. • Flash window is blocked. If lens cap blocks flash window, fully open lens cap. • Subject is outside range of flash: recompose picture with subject in range of flash or use D-lighting. • Exposure compensation is too low. • Subject is backlit: select scene mode setting of Back light, use fill flash, or use D-lighting. 	17 2, 13 17–18, 43 61 17, 31, 43
Pictures are too bright (overexposed)	Exposure compensation is too high.	61
Pictures are smeared	Lens is dirty. Clean lens.	83
Colors are unnatural	White balance does not match light source.	60
File can not be played back	File has been overwritten or renamed by computer or other make of camera.	—

Problem	Solution	
Can not zoom in on picture	<ul style="list-style-type: none"> • Picture is a movie. • Picture was created with small picture option. • Picture has been cropped to below 320 × 240. 	36 70 42
Can not create copy using crop, D-lighting, or small picture options	<ul style="list-style-type: none"> • Picture is a movie. • Crop and small picture options can not be used on copies created with these options. • D-lighting can not be used on copies created with crop, D-lighting, or small picture options. • Memory is insufficient. Delete pictures. • Display shows “MEMORY CARD IS WRITE PROTECTED”: memory card is locked. 	36 42, 70 43 16, 68 8
Pictures are not displayed on television set	<ul style="list-style-type: none"> • Choose correct video mode. • USB cable is connected: disconnect USB cable. Video output is not available when USB cable is connected. 	79 47, 52
PictureProject does not start when camera is connected or memory card inserted in card reader or card slot	<ul style="list-style-type: none"> • Camera is off. • AC adapter is not properly connected, or batteries are exhausted. • USB cable is not correctly connected, or card not properly inserted in card reader or card slot. • Appropriate USB option is not selected. • Camera is not registered in Device Manager (Windows only). <p>See the PictureProject reference manual (on CD) for further information.</p>	10 12, 81 47 46–47 — 46
Pictures are not transferred when center of multi selector is pressed	USB option is set to Mass storage and no memory card is inserted.	8, 46
Camera turns off without warning	<ul style="list-style-type: none"> • Batteries are low. • Batteries are cold. 	12 84

Appendix

Focus Lock

Focus and exposure are locked when the shutter-release button is pressed halfway, and remain locked while the shutter-release button is held in this position (focus lock). Focus lock can be used to take pictures of off-center subjects or in situations in which the camera is unable to focus using autofocus.

1 Focus

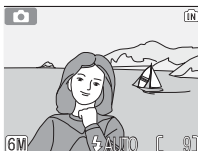

Position subject in center of frame and press shutter-release button halfway.

2 Check focus indicator

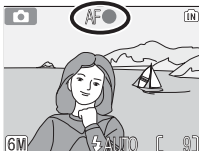

Check that focus indicator glows steadily, indicating that subject is in focus.

3 Recompose picture



Focus and exposure are locked while shutter-release button is pressed halfway.*

4 Take picture



Press shutter-release button rest of way down to take picture.

* Do not change distance between camera and subject while focus lock is in effect. If subject moves, release shutter-release button and focus again at new distance.

Getting Good Results with Autofocus

Autofocus performs best when there is contrast between the subject and the background and the subject is evenly lit. It does not perform well if the subject is very dark or moving rapidly, if there are objects of sharply differing brightness in the scene (e.g., the sun is behind your subject and their features are in deep shadow), or if there are several objects at different distances from the camera at the center of the frame (e.g., your subject is inside a cage).

File Storage



The following table shows the approximate number of pictures that can be stored in internal memory and on a 256-megabyte memory card in different image modes.





Image mode	Internal memory (13.5 MB)	256 MB memory card
6M* High (2816*)	4	80
6M Normal (2816)	9	165
3M Normal (2048)	16	300
PC PC screen (1024)	57	1025
TV TV screen (640)	123	2200

* All figures are approximate. Number of pictures that can be stored varies with make of memory card and type of scene recorded. If memory remains for more than 999 pictures, exposure count display will show 999.

Image File and Folder Names

On the memory card, pictures are identified by file names with three parts: a four letter identifier, a four-digit file number assigned automatically by the camera in ascending order, and a three-letter extension (e.g., "DSCN0001.JPG"). Movies are recorded as QuickTime movie files and can be played back on a computer after transfer.

Originals	Identifier	Extension		Copies	Identifier	Extension	
Still picture	DSCN	.JPG	16	Cropped copy	RSCN	.JPG	42
Movie	DSCN	.MOV	40	Small copy	SSCN	.JPG	70
Time-lapse movie	INTN	.MOV	39	D-lighting copy	FSCN	.JPG	43
Voice recording	DSCN	.WAV	34				
Voice memo	Same as picture	.WAV	44				

Pictures are stored in folders named with a three-digit folder number followed by a five-character identifier: "P_" plus a three-digit sequence number for pictures taken using panorama assist (e.g., "101P_001";  32), "INTVL" for interval timer photography (e.g., "101INTVL";  62), "SOUND" for voice recordings (e.g., "101SOUND";  34), and "NIKON" for all other pictures (e.g., "100NIKON"). Folders can hold up to 200 pictures; if a picture is taken when the current folder contains 200 pictures, a new folder will be created by adding one to the current folder number. If a picture is taken when the current folder contains a picture numbered 9999, a new folder will be created and file numbering will begin again from 0001. If the current folder is numbered 999 and contains 200 pictures or a picture numbered 9999, no further pictures can be taken until the memory card or internal memory is formatted ( 78) or a new memory card is inserted.

When a picture is viewed on the camera, the file number and extension appear in the top right corner of the display. The identifier is not displayed, but is visible when the picture is transferred to a computer.

File Storage: Image File and Folder Names (Continued)

Files copied using **Copy > Selected images/Selected files** are copied to the current folder, where they are assigned new file numbers in ascending order starting from the largest file number in memory. **Copy > All images/Copy all files** copies all folders from the source device; file names do not change but new folder numbers are assigned in ascending order starting from the largest folder number on the destination device (📖 35, 71).

The picture displayed when playback mode is selected is the picture with the largest file number in the folder with the largest folder number.

Refreshing Nikon EN-MH1-B2 Rechargeable NiMH Batteries

An MH-71 battery charger and rechargeable EN-MH1-B2 NiMH batteries are provided with the camera in some regions and are also available as options (📖 81). NiMH batteries may suffer a temporary drop in capacity if charged after long periods of disuse or before being fully discharged. They will return to normal after being refreshed a few times as described below.

- 1 Insert both batteries into the charger (📖 6).
- 2 Press the REFRESH button until the REFRESH lamp lights and close the lid. The REFRESH lamp turns off when the batteries are fully discharged. The batteries can now be removed or left in the MH-71 to recharge (📖 6). Unplug the charger after removing the batteries.

To resume charging before the batteries are fully discharged, or to refresh the batteries once charging has begun, press the REFRESH button for about two seconds.

Batteries that retain a charge for only short periods after being refreshed have reached the end of their working life and can no longer be used.

Printing the Date and Time of Recording on Pictures

To print the time and date of recording on pictures:

- take pictures using the **Date imprint** option in the setup menu, which imprints the date or date and time of recording directly on pictures as they are taken (📖 76)
- if the photo printer or print service supports Digital Print Order Format (DPOF), use the **Date** option in the **Print set** menu (📖 50–51)
- transfer the pictures using PictureProject and print them using the “Print Metadata” option (see the PictureProject reference manual, on CD)

🔍 “Date Imprint” Versus the Print Set “Date” Option

Date imprint	Print set > Date
Must be set before picture is taken	Set after picture is taken
Date permanently imprinted on picture	Date stored separately
Date appears whenever picture is printed	Date only appears when picture is printed on DPOF-compatible printer

Specifications

Nikon COOLPIX S4 Digital Camera

Type	Compact digital camera
Effective pixels	6.0 million
CCD	$1\frac{1}{2}$ -in. CCD; total pixels: 6.4 million
Image size (pixels)	<ul style="list-style-type: none"> • 2,816 × 2,112 (2816*, 2816) • 1,024 × 768 (1024) • 2,048 × 1,536 (2048) • 640 × 480 (640)
Lens	Zoom-Nikkor with 10× optical zoom
Focal length	F=6.3–63 mm (35-mm [135] camera-format equivalent: 38–380 mm)
f/-number	f/3.5
Construction	12 elements in 9 groups
Digital zoom	Up to 4× (35-mm [135] camera-format equivalent: 1520 mm)
Autofocus (AF)	Contrast-detect through-the-lens (TTL) AF with AF-assist illuminator
Focus range	30 cm (12 in.)–∞
(distance from lens)	Macro mode: 4 cm (1.6 in.)–∞ (W)
Focus-area selection	Center; auto multi AF
AF-assist illuminator	Class 1 LED product (IEC60825-1 Edition 1.2 ²⁰⁰¹); max. output: 1400 μW
Monitor	2.5 in., 110,000-dot, TFT LCD monitor with brightness adjustment
Approximate frame coverage	Shooting mode: 97% horizontal and 97% vertical Playback: 100% horizontal and 100% vertical
Storage	
Media	Internal memory (approx.13.5 MB); SD (Secure Digital) memory cards
File system	Compliant with Design Rule for Camera File System (DCF) [*] , Exif 2.2 [†] , and Digital Print Order Format (DPOF)
File formats	Compressed: JPEG-baseline-compliant Movies: QuickTime Sound files: WAV
Exposure	
Metering	256-segment matrix metering linked to AF area
Exposure control	Programmed auto exposure with exposure compensation (−2.0–+2.0 EV in steps of $\frac{1}{3}$ EV)
Range	+2.7–+17.5 EV
Shutter	Mechanical and charge-coupled electronic shutter
Speed	2– $1/1000$ s
Aperture	Electronically-controlled aperture and ND-filter selection
Range	f/3.5, f/4.0, f/5.6, f/6.8, and f/13.6
ISO Sensitivity	Approximately equivalent to ISO 50, 100, 200, 400; Auto
Self-timer	Approximately 10 seconds
Built-in flash	
Range (approx.)	0.4–3.0 m/1 ft. 4 in.–10 ft.
Sync method	Sensor flash system

* A standard widely used in the digital camera industry to ensure compatibility among different makes.

† Exchangeable Image File Format for Digital Still Cameras. Version 2.2 allows information stored with pictures to be used for optimal color reproduction when images are output on Exif-compliant printers.

I/O terminals	Audio/video out; digital IO (USB)
Interface	USB
Video output	Can be selected from NTSC and PAL
Supported languages	Chinese (Simplified and Traditional), Dutch, English, French, German, Italian, Japanese, Korean, Russian, Spanish, Swedish
Power sources	<ul style="list-style-type: none"> • Two AA alkaline, oxy-nickel, or lithium batteries • Two rechargeable EN-MH1-B2 NiMH batteries • EH-62B AC adapter kit
Battery life	Approximately 160 shots with alkaline, 450 shots with lithium, or 290 shots with EN-MH1-B2 batteries *
Dimensions with lens in storage position	111.5 × 68.5 × 37 mm/4.4 × 2.7 × 1.4 in. (W × H × D)
Approximate weight	205 g (7.2 oz.) without lens cap, batteries or memory card
Operating environment	
Temperature	0–+40°C (+32–104°F)
Humidity	Less than 85% (no condensation)

* Based on Camera and Imaging Products Association (CIPA) standard for measuring life of camera batteries. Measured at 25°C (77°F); zoom adjusted with each shot, flash fired with every other shot, image mode set to NORMAL.

Unless otherwise stated, all figures are for a camera with fully-charged EN-MH1-B2 batteries operated at an ambient temperature of 25°C (77°F).

MH-71 Battery Charger (Option; Supplied with Camera in Some Regions)

Rated input	AC 100–240V, 0.11–0.065 A, 50/60 Hz
Charging output	DC 1.2V/2000 mA
Applicable batteries	Nikon EN-MH1-B2 rechargeable Ni-MH batteries
Discharge time	Approximately 5 hours
Charging time	Approximately 2.5 hours
Operating temperature	5–+35°C (+41–95°F)
Dimensions	Approximately 70 × 79 × 30 mm/2.8 × 3.1 × 1.2 in. (W × H × D)
Length of cord	Approximately 1800 mm (70.9 in.)
Weight	Approximately 110 g (3.9 oz.), excluding power cable

Specifications













Nikon will not be held liable for any errors this manual may contain. The appearance of this product and its specifications are subject to change without notice.

EN-MH1-B2 NiMH Batteries

The capacity of NiMH batteries will drop if they are charged repeatedly without first being fully discharged. The batteries will return to normal once fully discharged. Note that NiMH batteries gradually lose their charge when not in use; refresh the batteries immediately before use.

Index

Symbols

-  (auto) mode, 2, 12
-  (delete) button, 3, 16, 34, 40, 41, 44
-  (internal memory) indicator, 4, 12, 15
-  (memory card) indicator, 4, 12, 15
- MENU** (menu) button, 3, 21, 35, 36, 58, 65, 72
-  (monitor) button, 3, 13, 33
-  (movie) mode, 36–40
-  (playback) button, 3, 16, 41, 65
-  (transfer) button, 46, 48
-  (transfer) icon, 69, 79
-  (wait) icon, 15, 85
-  (D-Lighting) guide, 4, 43
-  (D-Lighting) icon, 4, 43

A

- AC adapter, 81
- Accessories, 81
- AE-L, 32, 39, 62
- AF , see Focus indicator
- AF assist**, 79, 89
- AF-assist illuminator, 2, 15, 79, 82, 94
- Assist modes, 22–27
- Auto off**, 78
- Auto transfer**, 79
- A/V cable, 45

B

- Back light, 31
- Backlit subjects, 31, 43
- Batteries, ii–iii, 6–7, 12, 81, 84, 95

Battery type, 80

- Beach/Snow, 29
- Best Shot Selector, 63
- Black-and-white, 64
- Blur, 18, 28, 77, 85, 89
- Blur warning**, 4, 15, 18, 77
- BSS**, see Best Shot Selector

C

- Clock, see **Date**
- Close-up, 30
- Close-ups, 20
- Color options**, 4, 64

- Computer, 46
 - copying pictures to, 47–49
- Compression, 59
- Continuous**, 61
- Copy** (playback menu), 71
- Copy (scene mode), 30
- Cropping pictures, 42
- Cyanotype, 64

D

- Date**, 4, 10–11, 74–75
- Date counter, 76
- Date imprint**, 4, 76, 93
- DCF, see Design rule for Camera File system
- Delete**, 68
- Deleting pictures, 16, 34, 40, 41, 44, 68
 - all pictures, 68
 - in full-frame playback, 16
 - selected pictures, 68
- Design rule for Camera File system, 94
- Digital Print Order Format, 51
- Direct Print, see PictBridge
- D-lighting, 43
- DPOF, see Digital Print Order Format
- Dusk/Dawn, 29

E

- E-mail, 59, 70
- EH-62B, see AC adapter
- Electronic VR**, 38
- Error messages, 85–87
- Exif 2.2, 94
- Exif Print, see Exif 2.2
- Exp. +/-**, 61
- Exposure BSS, 63
- Exposure compensation, 61

F

- Face-priority AF, 23
- File numbering, 4, 33–34, 80, 92–93
- Fill flash, 17
- Fireworks show, 30
- Firmware, 80
- Firmware version**, 80
- Flash, 2, 4, 12, 13, 15, 17–18
 - mode, 12, 17–18

- Flash lamp, 15
- Focus, 15, 91
- Focus indicator, 15
- Focus lock, 91
- Format card**, 78
- Format memory**, 78
- Framing assist, 22–27
- Framing guides, 22
- Framing pictures, 13–14, 22

I

- Image mode**, 59, 92
- Image size, see **Image mode**
- Interface**, 47, 79
- Interval timer photography, 62

J

- JPEG, 94
- JPG, 92

L

- Landscape, 25
- Language**, 10, 79
- Language, choosing, 10, 95
- Lens, 2, 13, 83
- Lens cap, 13, 16

M

- Macro mode, 20
- Memory cards, 8–9, 81
 - approved, 81
 - capacity of, 92
 - formatting, 78
 - insertion and removal of, 8–9
- Menus**, 80
- MH-71 battery charger, 81, 95
- Mode selector, 2
- Monitor, 3, 4, 12, 83, 94
 - brightness, 75
 - indicators in, 4–5
- MOV, see Movies
- Movies, 36–40
 - recording, 38–39
 - viewing, 40
- MOVIE menu, 36
- Multi selector, 3
- Museum, 30

N
Night landscape, 29
Night Portrait, 27
NTSC, *see* Video mode
Number of exposures remaining, 12, 92

O
On/off, *see* Power switch

P
PAL, *see* Video mode
Panorama assist, 31, 32
Party/Indoor, 28
PictBridge, 51, 52–57
PictureProject, 46, 48, 69
PLAYBACK MENU, 65–71
Playback, 16, 41–57
 full-frame, 16, 41
 movies, 40
 on TV, 45
 thumbnail, 41
 voice memo, 44
 voice recording, 34

Portrait, 23
Power-on lamp, 2, 10
Power switch, 2, 10
Printing pictures, 50–57. *See also* **Date imprint**, Digital Print Order Format
PictBridge, 52–57

Print set, 50–51
Print size, 54, 55
Protect, 68
Protected pictures, 68

Q
QuickTime, 48, 92

R
Red-eye reduction, *see* Flash
Reset all, 79–80

S
SCENE (scene) mode, 21–32
Scene selection, 22, 28
Secure Digital (SD), *see* Memory cards
Self-timer, 19
Self-timer lamp, 2, 19
Sensitivity, 4, 18, 64
Sepia, 64
Setup menu, 72–80

SHOOTING menu, 58–64
Shutter-release button, 15
Size, *see* **Image mode**
Slide show, 67
Small picture, 70
Smear, 83
Sound, 33–35, 36, 44
Sound settings, 77
Speedlight, *see* Flash
Sports, 26
Standard color, 64
Standby mode, *see* Auto off
Strap, camera, 2
Sunset, 29
Support information, 1

T
Telephoto, *see* Zoom
Television, 45, 59, 79
 connecting to, 45
Thumbnail playback, 41
Time zone, 10–11, 74, 75
Timer, *see* Self-timer
Time-lapse movies, 36, 39
Transfer, 46–49
 marking pictures for, 69, 79

Transfer marking, 69
Tripod, 3, 18, 19
T, *see* Zoom control

U
USB, 47, 79
 cable (UC-E6), 46, 47, 52
 connector, 3

V
VCR, 45
Vibration reduction, *see* **Electronic VR**
Video mode, 45, 79
Vivid color, 64
Voice memo, 44
Voice recording, 31, 33–35
 copying, 35
Volume, 77
 playback, 34, 40, 44, 77

W
WAV, 92
Welcome screen, 73
White balance, 4, 60
 preset, 60
Wide angle, *see* Zoom
W, *see* Zoom control

Z
Zoom, 14, 20, 41, 42, 94
 digital, 14, 38, 61, 94
 indicator, 14
 optical, 14, 38
 playback, 41, 42
Zoom control, 2, 14, 21, 34,
 40, 41, 42, 44

Nikon

No reproduction in any form of this manual, in whole or in part (except for brief quotation in critical articles or reviews), may be made without written authorization from NIKON CORPORATION.