

**Nikon**

DIGITAL CAMERA

# COOLPIX S640

User's Manual

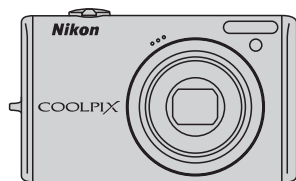

En

### **Trademark Information**

- Microsoft, Windows and Windows Vista are either registered trademarks or trademarks of Microsoft Corporation in the United States and/or other countries.
- Macintosh, Mac OS, and QuickTime are trademarks of Apple Inc.
- Adobe and Acrobat are registered trademarks of Adobe Systems Inc.
- The SD logo is a trademark of the SD Card Association.
- PictBridge is a trademark.
- All other trade names mentioned in this manual or the other documentation provided with your Nikon product are trademarks or registered trademarks of their respective holders.

**Introduction**

**First Steps**



**Basic Photography and Playback: Auto Mode**



**Shooting Suited for the Scene**



**Taking Pictures of Smiling Faces  
(Smart Portrait Mode)**



**Focusing on a Moving Subject in Subject  
Tracking Mode**



**More on Playback/In-Camera Editing**



**Movies**

**Connecting to Televisions, Computers and Printers**

**MENU**

**Shooting, Playback and Setup Menus**

**Technical Notes**

## For Your Safety

To prevent damage to your Nikon product or injury to yourself or to others, read the following safety precautions in their entirety before using this equipment. Keep these safety instructions where all those who use the product will read them. The consequences that could result from failure to observe the precautions listed in this section are indicated by the following symbol:



This icon marks warnings, information that should be read before using this Nikon product, to prevent possible injury.

### WARNINGS

#### **Turn off in the event of malfunction**

Should you notice smoke or an unusual smell coming from the camera or Charging AC Adapter, unplug the Charging AC Adapter and remove the battery immediately, taking care to avoid burns. Continued operation could result in injury. After removing or disconnecting the power source, take the equipment to a Nikon-authorized service representative for inspection.

#### **Do not disassemble**

Touching the internal parts of the camera or Charging AC Adapter could result in injury. Repairs should be performed only by qualified technicians. Should the camera or Charging AC Adapter break open as the result of a fall or other accident, take the product to a Nikon-authorized service representative for inspection, after unplugging the product and/or removing the battery.

#### **Do not use the camera or Charging AC Adapter in the presence of flammable gas**

Do not use electronic equipment in the presence of flammable gas, as this could result in explosion or fire.

#### **Handle the camera strap with care**

Never place the strap around the neck of an infant or child.

#### **Keep out of reach of children**

Particular care should be taken to prevent infants from putting the battery or other small parts into their mouths.

** Observe caution when handling the battery**

The battery may leak or explode if improperly handled. Observe the following precautions when handling the battery for use in this product:

- Before replacing the battery, turn the product off. If you are using the Charging AC Adapter/AC adapter, be sure it is unplugged.
- Use only a Rechargeable Li-ion Battery EN-EL12 (supplied). Charge the battery inserting it into the camera and connecting the Charging AC Adapter EH-68P/EH-68P (AR) (supplied).
- When inserting the battery, do not attempt to insert it upside down or backwards.
- Do not short or disassemble the battery or attempt to remove or break the battery insulation or casing.
- Do not expose the battery to flame or to excessive heat.
- Do not immerse in or expose to water.
- Replace the terminal cover when transporting the battery. Do not transport or store with metal objects such as necklaces or hairpins.
- The battery is prone to leakage when fully discharged. To avoid damage to the product, be sure to remove the battery when no charge remains.
- Discontinue use immediately should you notice any change in the battery, such as discoloration or deformation.
- If liquid from the damaged battery comes in contact with clothing or skin, rinse immediately with plenty of water.

** Observe the following precautions when handling the Charging AC Adapter**

- Keep dry. Failure to observe this precaution could result in fire or electric shock.
- Dust on or near the metal parts of the plug should be removed with a dry cloth. Continued use could result in fire.
- Do not handle the plug or go near the Charging AC Adapter during lightning storms. Failure to observe this precaution could result in electric shock.
- Do not damage, modify, forcibly tug or bend the USB cable, place it under heavy objects, or expose it to heat or flames. Should the insulation be damaged and the wires become exposed, take it to a Nikon-authorized service representative for inspection. Failure to observe these precautions could result in fire or electric shock.
- Do not handle the plug or Charging AC Adapter with wet hands. Failure to observe this precaution could result in electric shock.
- Do not use with travel converters or adapters designed to convert from one voltage to another or with DC-to-AC inverters. Failure to observe this precaution could damage the product or cause overheating or fire.

 **Use appropriate cables**

When connecting cables to the input and output jacks, use only the cables provided or sold by Nikon for the purpose, to maintain compliance with product regulations.

 **Handle moving parts with care**

Be careful that your fingers or other objects are not pinched by the lens cover or other moving parts.

 **CD-ROMs**

The CD-ROMs supplied with this device should not be played back on audio CD equipment. Playing CD-ROMs on an audio CD player could cause hearing loss or damage the equipment.

 **Observe caution when using the flash**

Using the flash close to your subject's eyes could cause temporary visual impairment. Particular care should be observed if photographing infants, when the flash should be no less than 1 m (3 ft. 4 in.) from the subject.

 **Do not operate the flash with the flash window touching a person or object**

Failure to observe this precaution could result in burns or fire.

 **Avoid contact with liquid crystal**

Should the monitor break, care should be taken to avoid injury caused by broken glass and to prevent liquid crystal from the monitor touching the skin or entering the eyes or mouth.

 **Turn the power off when using inside an airplane or the hospital**

Turn the power off while inside the airplane during take off or landing. Follow the instructions of the hospital when using while in a hospital. The electromagnetic waves given out by this camera may disrupt the electronic systems of the airplane or the instruments of the hospital.

# Notices

## **Notice for Customers in the U.S.A.**

### **Federal Communications Commission (FCC) Radio Frequency Interference Statement**

This equipment has been tested and found to comply with the limits for a Class B digital device, pursuant to Part 15 of the FCC rules. These limits are designed to provide reasonable protection against harmful interference in a residential installation. This equipment generates, uses, and can radiate radio frequency energy and, if not installed and used in accordance with the instructions, may cause harmful interference to radio communications. However, there is no guarantee that interference will not occur in a particular installation. If this equipment does cause harmful interference to radio or television reception, which can be determined by turning the equipment off and on, the user is encouraged to try to correct the interference by one or more of the following measures:

- Reorient or relocate the receiving antenna.
- Increase the separation between the equipment and receiver.
- Connect the equipment into an outlet on a circuit different from that to which the receiver is connected.
- Consult the dealer or an experienced radio/television technician for help.



**Nikon**

COOLPIX S640

### **CAUTIONS**

#### **Modifications**

The FCC requires the user to be notified that any changes or modifications made to this device that are not expressly approved by Nikon Corporation may void the user's authority to operate the equipment.

#### **Interface Cables**

Use the interface cables sold or provided by Nikon for your equipment. Using other interface cables may exceed the limits of Class B Part 15 of the FCC rules.

#### **Notice for customers in the State of California**

##### **WARNING**

Handling the cord on this product will expose you to lead, a chemical known to the State of California to cause birth defects or other reproductive harm.

##### ***Wash hands after handling.***

Nikon Inc.,

1300 Walt Whitman Road  
Melville, New York 11747-3064  
USA

Tel: 631-547-4200

## **Notice for customers in Canada**

### **CAUTION**

This Class B digital apparatus complies with Canadian ICES-003.

### **ATTENTION**

Cet appareil numérique de la classe B est conforme à la norme NMB-003 du Canada.

## **Notice for customers in Europe**

This symbol indicates that this product is to be collected separately.



The following apply only to users in European countries:

- This product is designated for separate collection at an appropriate collection point. Do not dispose of as household waste.
- For more information, contact the retailer or the local authorities in charge of waste management.

This symbol on the battery indicates that the battery is to be collected separately.







The following apply only to users in European countries:





- All batteries, whether marked with this symbol or not, are designated for separate collection at an appropriate collection point. Do not dispose of as household waste.
- For more information, contact the retailer or the local authorities in charge of waste management.



# Table of Contents



















For Your Safety .....	ii
WARNINGS .....	ii
Notices .....	v
<hr/>	
Introduction .....	1
About This Manual .....	1
Information and Precautions .....	2
Parts of the Camera .....	4
The Camera Body .....	4
The Monitor .....	6
Basic Operations .....	8
The  (shooting mode) Button .....	8
The  (playback) Button .....	9
The Rotary Multi Selector .....	10
The MENU button .....	12
Switching Between Tabs .....	12
Help Displays .....	13
Pressing the Shutter-Release Button Halfway/All the Way Down .....	13
Attaching the Camera Strap .....	13
<hr/>	
First Steps .....	14
Inserting the Battery .....	14
Removing the Battery .....	15
Charging the Battery .....	16
Turning On and Off the Camera .....	19
Setting Display Language, Date and Time .....	20
Inserting Memory Cards .....	22
Removing Memory Cards .....	22
<hr/>	
 Basic Photography and Playback: Auto Mode .....	24
Step 1 Turn the Camera On and Select  (Auto) Mode .....	24
Indicators Displayed in  (Auto) Mode .....	25
Step 2 Frame a Picture .....	26
Using the Zoom .....	27
Step 3 Focus and Shoot .....	28
Step 4 Viewing and Deleting Pictures .....	30
Viewing Pictures (Playback Mode) .....	30
Deleting Pictures .....	30
Using the Flash .....	32
Setting the Flash Mode .....	32
Taking Pictures with the Self-Timer .....	34
Macro Mode .....	35

## Table of Contents

Exposure Compensation .....	36
<hr/>	
 Shooting Suited for the Scene.....	37
Shooting in Scene Mode .....	37
Choosing a Scene Mode .....	37
Features .....	38
Shooting in the Scene Mode Selected by the Camera (Scene Auto Selector) .....	45
Taking Pictures in Food Mode .....	47
Taking Pictures for a Panorama .....	49
<hr/>	
 Taking Pictures of Smiling Faces (Smart Portrait Mode) .....	51
Using Smart Portrait Mode .....	51
Smart Portrait Menu .....	52
<hr/>	
 Focusing on a Moving Subject in Subject Tracking Mode.....	54
Subject Tracking Mode .....	54
Subject Tracking Menu .....	56
<hr/>	
 More on Playback/In-Camera Editing .....	57
Viewing Multiple Pictures: Thumbnail Playback .....	57
Calendar Display.....	59
Taking a Closer Look: Playback Zoom .....	60
Viewing Pictures by Date (List by Date Mode) .....	61
Selecting a Date in List by Date Mode .....	61
Using List by Date Mode .....	62
List by Date Menu .....	63
Image Searching (Auto Sort Mode) .....	64
Displaying Pictures in the Auto Sort Mode .....	64
Auto Sort Mode .....	66
Auto Sort Menu .....	66
Voice Memos: Recording and Playback .....	67
Recording Voice Memos .....	67
Playing Voice Memos .....	68
Deleting Voice Memos .....	68
Editing Pictures.....	69
Enhancing Contrast and Saturation: Quick Retouch .....	71
Enhancing Brightness and Contrast: D-Lighting.....	72
Making Skin Appear Smoother: Skin Softening .....	73
Resizing Pictures: Small Picture.....	74
Creating a Cropped Copy: Crop .....	75

<b>📽 Movies .....</b>	<b>76</b>
Recording Movies .....	76
The Movie Menu.....	77
📽 Selecting Movie Options.....	77
🔍 Autofocus Mode .....	77
Movie Playback.....	78
Deleting Movie Files.....	78
<b>Connecting to Televisions, Computers and Printers .....</b>	<b>79</b>
Connecting to a TV.....	79
Connecting to a Computer.....	80
Before Connecting the Camera.....	80
Transferring Pictures from the Camera to a Computer .....	81
Charging While Connecting to a Computer .....	84
Connecting to a Printer.....	85
Connecting the Camera to a Printer.....	86
Printing Pictures One at a Time.....	88
Printing Multiple Pictures .....	89
Creating a DPOF Print Order: Print Set.....	92
<b>MENU Shooting, Playback and Setup Menus .....</b>	<b>95</b>
Shooting Options: The Shooting Menu .....	95
Displaying the Shooting Menu .....	95
🔍 Image Mode.....	96
WB White Balance.....	98
📊 Metering.....	100
📺 Continuous.....	101
ISO ISO Sensitivity .....	102
🎨 Color Options.....	103
📏 AF-Area Mode .....	104
🔍 Autofocus Mode.....	108
Functions that Cannot be Applied Simultaneously.....	109
Playback Options: The Playback Menu .....	110
Displaying the Playback Menu .....	110
📺 Slide Show.....	112
🗑 Delete.....	113
🔒 Protect .....	113
🔄 Rotate Image.....	114
📄 Copy.....	115
Basic Camera Setup: The Setup Menu.....	116
Displaying the Setup Menu.....	117

## Table of Contents

 Menu .....	118
 Welcome Screen.....	119
 Date .....	120
 Monitor Settings.....	123
 Date Imprint .....	124
 Vibration Reduction.....	125
 Motion Detection .....	126
 AF Assist.....	127
 Digital Zoom .....	127
 Sound Settings.....	128
 Auto Off .....	128
 Format Memory/Format Card.....	129
 Language.....	130
 Video Mode .....	130
 Charge by Computer .....	131
 Blink Warning .....	132
 Reset All.....	134
 Firmware Version .....	136

---

<b>Technical Notes.....</b>	<b>137</b>
<b>Optional Accessories .....</b>	<b>137</b>
Approved Memory Cards .....	138
<b>File and Folder Names.....</b>	<b>139</b>
<b>Caring for the Camera .....</b>	<b>140</b>
Cleaning .....	142
Storage.....	143
<b>Error Messages .....</b>	<b>144</b>
<b>Troubleshooting.....</b>	<b>148</b>
<b>Specifications .....</b>	<b>154</b>
Supported Standards .....	157
<b>Index.....</b>	<b>158</b>

## About This Manual

Thank you for your purchase of a Nikon COOLPIX S640 digital camera. This manual was written to help you enjoy taking pictures with your Nikon digital camera. Read this manual thoroughly before use, and keep it where all those who use the product will read it.

### Symbols and Conventions

To make it easier to find the information you need, the following symbols and conventions are used:



This icon marks cautions, information that should be read before use, to prevent damage to the camera.



This icon marks tips, additional information that may be helpful when using the camera.



This icon marks notes, information that should be read before using the camera.



This icon indicates that more information is available elsewhere in this manual or in the *Quick Start Guide*.

### Notations

- A Secure Digital (SD) memory card is referred to as a “memory card”.
- The setting at the time of purchase is referred to as the “default setting”.
- The names of menu items displayed in the camera monitor, and the names of buttons or messages displayed in a computer monitor are indicated in bold text.

### Screen Samples

In this manual, images are sometimes omitted from monitor display samples so that monitor indicators can be more clearly shown.

### Illustrations and Screen Display

Illustrations and text displays shown in this manual may differ from actual display.

### Memory Cards

Pictures taken with this camera can be stored in the camera’s internal memory or on removable memory cards. If a memory card is inserted, all new pictures will be stored on the memory card and delete, playback, and format operations will apply only to the pictures on the memory card. The memory card must be removed before the internal memory can be formatted or used to store pictures to, or delete, or view pictures.

# Information and Precautions

## Life-Long Learning

As part of Nikon's "Life-Long Learning" commitment to ongoing product support and education, continually updated information is available online at the following sites:

- For users in the U.S.A.: <http://www.nikonusa.com/>
- For users in Europe and Africa: <http://www.europe-nikon.com/support/>
- For users in Asia, Oceania, and the Middle East: <http://www.nikon-asia.com/>

Visit these sites to keep up-to-date with the latest product information, tips, answers to frequently asked questions (FAQs), and general advice on digital imaging and photography. Additional information may be available from the Nikon representative in your area. See the URL below for contact information:

<http://imaging.nikon.com/>

## Use Only Nikon Brand Electronic Accessories

Nikon COOLPIX cameras are designed to the highest standards and include complex electronic circuitry. Only Nikon brand electronic accessories (including battery chargers, batteries, Charging AC Adapter and AC adapters) certified by Nikon specifically for use with this Nikon digital camera are engineered and proven to operate within the operational and safety requirements of this electronic circuitry.

THE USE OF NON-NIKON ELECTRONIC ACCESSORIES COULD DAMAGE THE CAMERA AND MAY VOID YOUR NIKON WARRANTY.

The use of third-party rechargeable Li-ion batteries not bearing the Nikon holographic seal could interfere with normal operation of the camera or result in the batteries overheating, igniting, rupturing, or leaking.

For more information about Nikon brand accessories, contact a local authorized Nikon dealer.

**Holographic seal:** Identifies this device as an authentic Nikon product.



## Before Taking Important Pictures

Before taking pictures on important occasions (such as at weddings or before taking the camera on a trip), take a test shot to ensure that the camera is functioning normally. Nikon will not be held liable for damages or lost profits that may result from product malfunction.

## About the Manuals

- No part of the manuals included with this product may be reproduced, transmitted, transcribed, stored in a retrieval system, or translated into any language in any form, by any means, without Nikon's prior written permission.
- Nikon reserves the right to change the specifications of the hardware and software described in these manuals at any time and without prior notice.
- Nikon will not be held liable for any damages resulting from the use of this product.
- While every effort was made to ensure that the information in these manuals is accurate and complete, we would appreciate it were you to bring any errors or omissions to the attention of the Nikon representative in your area (address provided separately).

## Notice Concerning Prohibition of Copying or Reproduction

Note that simply being in possession of material that was digitally copied or reproduced by means of a scanner, digital camera or other device may be punishable by law.

### • Items prohibited by law from being copied or reproduced

Do not copy or reproduce paper money, coins, securities, government bonds or local government bonds, even if such copies or reproductions are stamped "Sample". The copying or reproduction of paper money, coins, or securities which are circulated in a foreign country is prohibited. Unless the prior permission of the government was obtained, the copying or reproduction of unused postage stamps or post cards issued by the government is prohibited.

The copying or reproduction of stamps issued by the government and of certified documents stipulated by law is prohibited.

### • Cautions on certain copies and reproductions

The government has issued cautions on copies or reproductions of securities issued by private companies (shares, bills, checks, gift certificates, etc.), commuter passes or coupon tickets, except when a minimum of necessary copies are to be provided for business use by a company. Also, do not copy or reproduce passports issued by the government, licenses issued by public agencies and private groups, ID cards and tickets, such as passes and meal coupons.

### • Comply with copyright notices

The copying or reproduction of copyrighted creative works such as books, music, paintings, woodcut prints, maps, drawings, movies and photographs is governed by national and international copyright laws. Do not use this product for the purpose of making illegal copies or to infringe copyright laws.

## Disposing of Data Storage Devices



Please note that deleting images or formatting data storage devices such as memory cards or built-in camera memory does not completely erase the original image data. Deleted files can sometimes be recovered from discarded storage devices using commercially available software, potentially resulting in the malicious use of personal image data. Ensuring the privacy of such data is the user's responsibility.

Before discarding a data storage device or transferring ownership to another person, erase all data using commercial deletion software, or format the device and then completely refill it with images containing no private information (for example, pictures of empty sky). Be sure to also replace any pictures selected for the welcome screen (📷 119). Care should be taken to avoid injury or damage to property when physically destroying data storage devices.

# Parts of the Camera

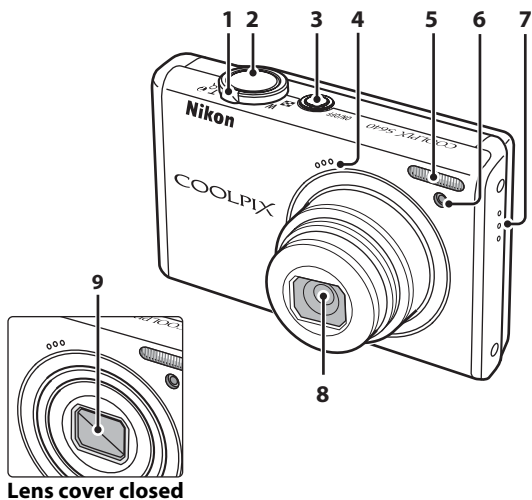
## The Camera Body



<b>1</b>	Zoom control.....27	<b>4</b>	Built-in microphone.....67, 76
	<b>W</b> : Wide.....27	<b>5</b>	Built-in flash.....32
	<b>T</b> : Tele.....27	<b>6</b>	Self-timer lamp.....34
	 : Thumbnail playback..... 57, 59		AF-assist illuminator..... 127
	 : Playback zoom.....60	<b>7</b>	Speaker.....67, 78
	 : Help..... 13	<b>8</b>	Lens..... 142, 154
<b>2</b>	Shutter-release button..... 13, 28	<b>9</b>	Lens cover
<b>3</b>	Power switch/Power-on lamp ..... 19, 128		



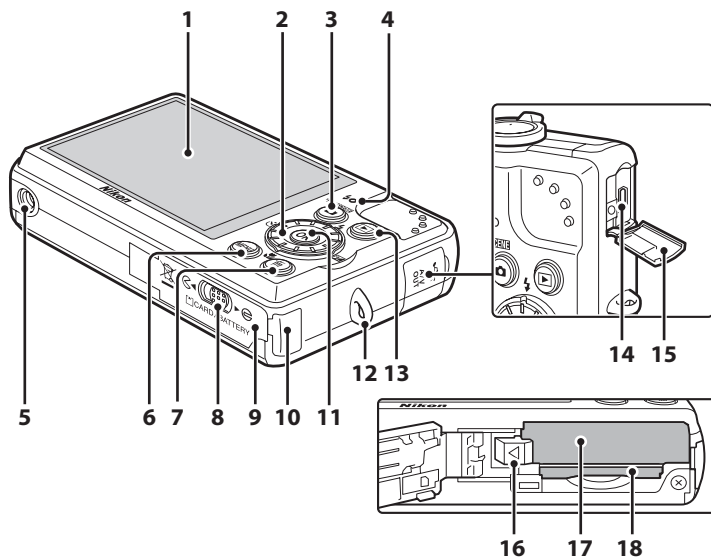

<b>1</b>	Monitor .....	6, 25
<b>2</b>	Rotary multi selector .....	10
<b>3</b>	(shooting mode) button .....	8
<b>4</b>	Charge lamp .....	17, 84
	Flash lamp .....	33
<b>5</b>	Tripod socket	
<b>6</b>	<b>MENU</b> button .....	12, 95, 110, 117
<b>7</b>	(delete) button .....	30, 31, 68, 78
<b>8</b>	Cover latch .....	14, 22
<b>9</b>	Battery-chamber/ memory card slot cover .....	14, 22

<b>10</b>	Power connector cover (for optional AC adapter connection) .....	137
<b>11</b>	(apply selection) button .....	10
<b>12</b>	Eyelet for camera strap .....	13
<b>13</b>	(playback) button .....	9, 30
<b>14</b>	Cable connector .....	79, 81, 86
<b>15</b>	Connector cover .....	79, 81, 86
<b>16</b>	Battery latch .....	14, 15
<b>17</b>	Battery chamber .....	14
<b>18</b>	Memory card slot .....	22

## The Monitor

The following indicators may appear in the monitor during shooting and playback (actual display varies with current camera settings).

The indicators and photo info displayed during shooting and playback will turn off after a few seconds (📖 123).

## Shooting

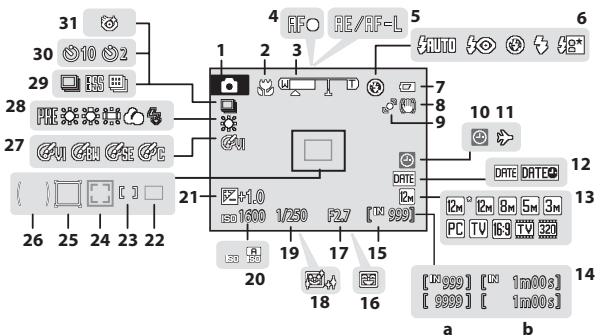

<b>1</b>	Shooting mode*.....	24, 37, 51, 54, 76
<b>2</b>	Macro mode .....	35
<b>3</b>	Zoom indicator .....	27, 35
<b>4</b>	Focus indicator.....	28
<b>5</b>	AE/AF-L indicator.....	50
<b>6</b>	Flash mode .....	32
<b>7</b>	Battery level indicator .....	24
<b>8</b>	Vibration reduction icon .....	25, 125
<b>9</b>	Motion detection icon.....	25, 126
<b>10</b>	“Date not set” indicator.....	120, 144
<b>11</b>	Travel destination indicator.....	120
<b>12</b>	Date imprint.....	124
<b>13</b>	Image mode .....	96
<b>14</b>	Movie options.....	77
	(a) Number of exposures remaining (still pictures).....	24
	(b) Movie length.....	76

<b>15</b>	Internal memory indicator .....	25
<b>16</b>	Smile timer .....	53
<b>17</b>	Aperture.....	28
<b>18</b>	Skin softening.....	52
<b>19</b>	Shutter speed .....	28
<b>20</b>	ISO sensitivity.....	33, 102
<b>21</b>	Exposure compensation value .....	36
<b>22</b>	Focus area.....	28, 104
<b>23</b>	Focus area (for manual, center).....	104
<b>24</b>	Focus area (Face Priority) .....	51, 104
<b>25</b>	Focus area (Subject Tracking mode) .....	54
<b>26</b>	Center-weighted metering area .....	100
<b>27</b>	Color options.....	103
<b>28</b>	White balance mode .....	98
<b>29</b>	Continuous shooting mode .....	101
<b>30</b>	Self-timer indicator .....	34
<b>31</b>	Blink proof .....	52

6 \* Differs according to the current shooting mode. Refer to the sections on each mode for details.

## Playback

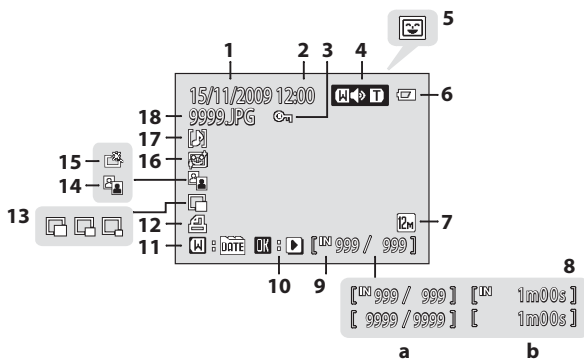

<b>1</b>	Date of recording .....	20	<b>9</b>	Internal memory indicator .....	30
<b>2</b>	Time of recording .....	20	<b>10</b>	Movie playback indicator .....	78
<b>3</b>	Protect icon .....	113	<b>11</b>	List by date guide .....	61
<b>4</b>	Volume indicator .....	68, 78	<b>12</b>	Print-order icon .....	92
<b>5</b>	Auto sort folder icon <sup>1</sup> .....	64	<b>13</b>	Small picture .....	74
<b>6</b>	Battery level indicator .....	24	<b>14</b>	D-Lighting icon .....	72
<b>7</b>	Image mode <sup>2</sup> .....	96	<b>15</b>	Quick retouch icon .....	71
	Movie option <sup>2</sup> .....	78	<b>16</b>	Skin softening icon .....	73
<b>8</b>	(a) Current frame number/ total number of frames .....	30	<b>17</b>	Voice memo indicator .....	68
	(b) Movie length .....	78	<b>18</b>	File number and type .....	139



1 The icons for auto sorting playback folder selected in playback will appear.

2 Differs according to the selected option.

# Basic Operations

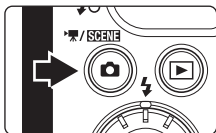
## The (shooting mode) Button









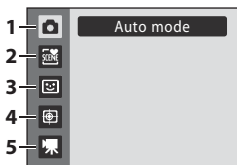



- Press the  button in playback mode to change to shooting mode.
- Press the  button in shooting mode to display the “shooting-mode selection menu” and change the shooting mode.

## Shooting-mode Selection Menu

Use the rotary multi selector ( 10) to select the following shooting modes.







1.  Auto mode ( 24)
2.  Scene mode ( 37)\*
3.  Smart portrait mode ( 51)
4.  Subject tracking mode ( 54)
5.  Movie mode ( 76)

\* The icon displayed will differ according to the last chosen mode.

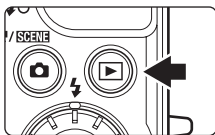
While the shooting-mode selection menu is displayed, press the  button to continue shooting without changing the shooting mode.

## The (playback) Button









- Press the  button in shooting mode to change to playback mode.
- Press the  button in playback mode to display the “playback-mode selection menu” and change the playback mode.
- When the camera is off, holding down the  button will turn the camera on in playback mode.

## Playback-mode Selection Menu

Use the rotary multi selector ( 10) to select the following playback modes.



1.  Playback mode ( 30)
2.  Auto sort mode ( 64)
3.  List by date mode ( 61)

While the playback-mode selection menu is displayed, press the  button to return to the current playback mode without changing the mode.

## The Rotary Multi Selector

This section describes standard uses of the rotary multi selector to select modes, select menu options and to apply selections.

### Shooting

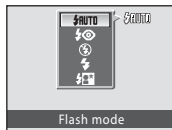
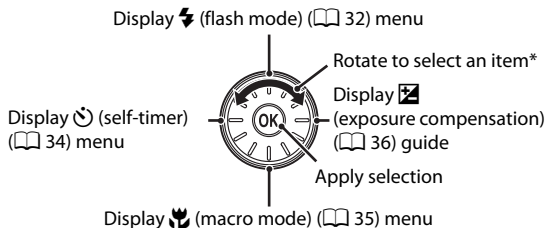

\* Options can also be chosen by pressing the rotary multi selector up or down.

### Playback

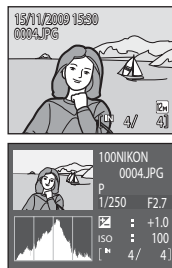
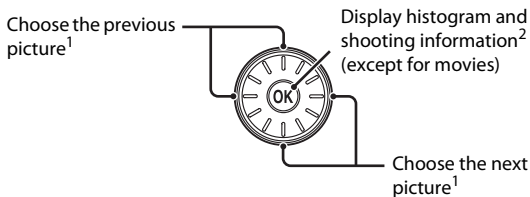

1 Subsequent or previous pictures can also be selected by rotating the rotary multi selector.

2 A histogram is a graph showing the distribution of tones in the image. The horizontal axis corresponds to pixel brightness, with dark tones to the left and bright tones to the right. The vertical axis shows the number of pixels.

The shooting information displayed includes the folder name, file name, shooting mode used, shutter speed, aperture, exposure compensation, ISO sensitivity, and the current file number.

**P** will be displayed for shooting mode.

Press the button again to return to full-frame playback.

## Menu Display

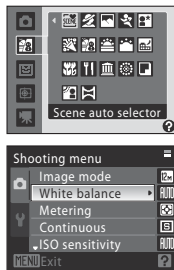
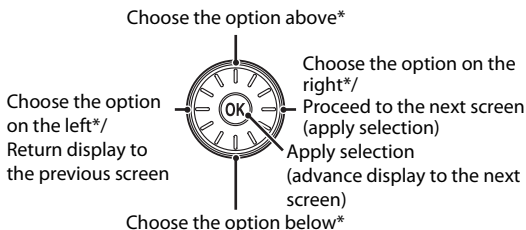

\* Options can also be chosen by rotating the rotary multi selector.

### Note on the Rotary Multi Selector

In this manual, up, down, left, and right presses of the rotary multi selector may be indicated with ▲, ▼, ◀ and ▶.

## The MENU button

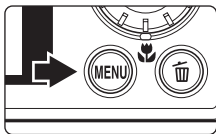

Press the **MENU** button to display the menu for the current mode.

- Use the rotary multi selector to navigate the menus (11).
- Select a tab on the left side of the monitor to display the corresponding menu.
- Press the **MENU** button again to exit the menu.

Displayed when the menu contains two or more pages

- Upper tab:  
Displays the menus for the current mode used
- Lower tab:  
Displays the setup menu

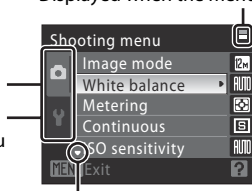

Displayed when there are one or more menu options to follow

Displayed when there are previous menu options

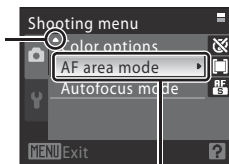

Select an item, then press the **OK** button or the rotary multi selector **▶** to proceed to the next set of options.

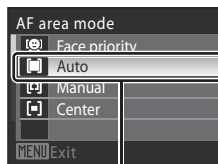

Press the **OK** button or the rotary multi selector **▶** to apply selection.

## Switching Between Tabs

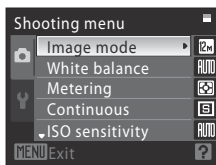

Press the rotary multi selector **◀** to highlight the tab.



Press the rotary multi selector **▲** or **▼** to choose another tab, and press either the **OK** button or **▶**.

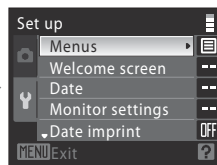

The chosen menu is displayed.



## Help Displays

Rotate the zoom control to **T** (?) when **[?]/[?]** is displayed at the bottom of the menu screen to view a description of the currently selected menu option.

To return to the original menu, rotate the zoom control to **T** (?) again.

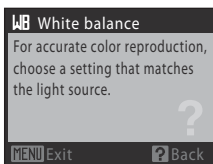
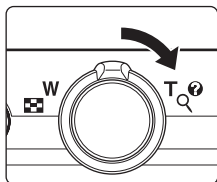

## Pressing the Shutter-Release Button Halfway/All the Way Down

The camera features a two-stage shutter-release button. To set focus and exposure, press the shutter-release button halfway, stopping when you feel resistance. Focus and exposure lock while the shutter-release button is held in this position. To release the shutter and take a picture, press the shutter-release button the rest of the way down.

Do not use force when pressing the shutter-release button, as this may result in camera shake and blurred pictures.



Press the shutter-release button halfway to set focus and exposure.

Press the shutter-release button the rest of the way down to shoot.

## Attaching the Camera Strap

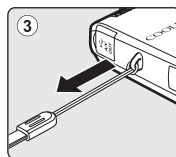
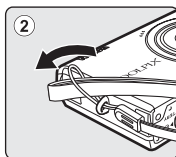
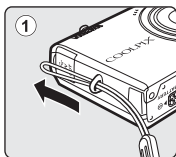

## Inserting the Battery

Insert a Rechargeable Li-ion Battery EN-EL12 (supplied) into the camera.

- Charge the battery before first use or when the battery is running low (📖 16).

### 1 Open the battery-chamber/memory card slot cover.

Slide the cover latch toward ⬅️ (①) and open the battery-chamber/memory card slot cover (②).

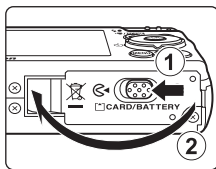

### 2 Insert the battery.

- Confirm that the positive (+) and negative (-) terminals are oriented correctly, as shown on the label at the entrance of the battery chamber, and insert the battery.
- Use the edge of the battery to push the orange battery latch in the direction indicated by the arrow (①) and fully insert the battery (②). When the battery is fully inserted, the battery latch will lock it in place.

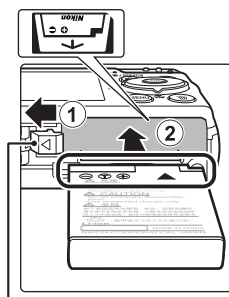

Battery latch

### ✔ Inserting the Battery Correctly

**Inserting the battery upside down or backwards could damage the camera.** Be sure to check the battery is in the correct orientation.



### 3 Close the battery-chamber/memory card slot cover.

- Close the battery-chamber/memory card slot cover (①), and slide the cover latch to the ➡️ position (②).

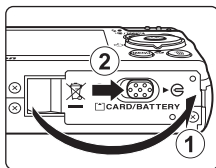

## Removing the Battery

**Turn the camera off** (📖 19) and confirm that the power-on lamp and the monitor are off before opening the battery-chamber/memory card slot cover.

To eject the battery, open the battery-chamber/memory card slot cover and slide the orange battery latch in the direction shown (①). The battery can then be removed by hand (②).

- Note that the battery may become hot during use; observe due caution when removing the battery.

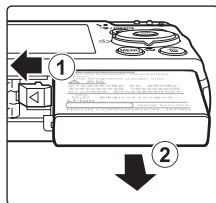

### ✓ Notes on the Battery

- Be sure to read and follow the warnings and cautions of “For Your Safety” (📖 ii) thoroughly before using the battery.
- Be sure to read and follow the warnings for “The Battery” (📖 141) of the section “Caring for the Camera” thoroughly before using the battery.
- If the battery will not be used for an extended period, recharge it at least once every six months and run it flat before returning it to storage.

# Charging the Battery

Charge the supplied Rechargeable Li-ion Battery EN-EL12 inserted into the camera, by connecting the supplied Charging AC Adapter EH-68P to the camera via the supplied USB Cable UC-E6, and then plugging the Charging AC Adapter into an electrical outlet.

## 1 Prepare the Charging AC Adapter EH-68P.

If a plug adapter\* is included, attach the plug adapter to the plug on the Charging AC Adapter. Push the plug adapter firmly until it is securely held in place. Once the two are connected, attempting to forcibly remove the plug adapter could damage the product.

\* The shape of the plug adapter varies according to the country or region in which the camera was purchased.

### **For Customers in Argentina**

If the camera was purchased in Argentina, the shape of the Charging AC Adapter EH-68P (AR) differs from that supplied in other countries, and a plug adapter is not included. Proceed to step 2.

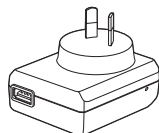
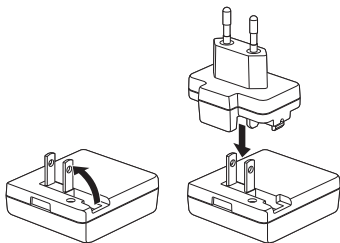

EH-68P (AR)

## 2 Be sure that the power-on lamp and the monitor are off.

- Be sure to insert the battery into the camera (📖 14) and turn off the camera (📖 19).

## 3 Use the supplied USB cable to connect the Charging AC Adapter to the camera.

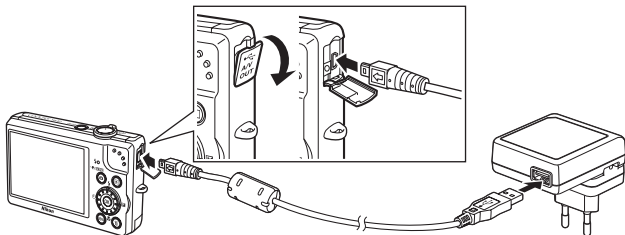

### **Connecting the Cable**

When connecting the cable, be sure that the camera connector is properly oriented. Do not use force when connecting the cable to the camera. When disconnecting the cable, do not pull the connector at an angle.

## 4 Plug the Charging AC Adapter into an electrical outlet.

- The camera's charge lamp slowly blinks green to indicate that the battery is charging.
- About 4 hours are required to charge a fully exhausted battery.

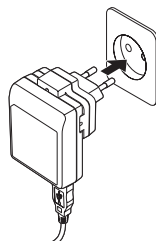

- The following chart explains charge lamp status when the camera is plugged into the electrical outlet.

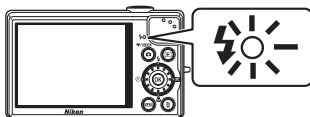

Charge lamp	Description
Blinks slowly (green)	Battery charging.
Off	Not charging. When the charge lamp changes from slow blinking (green) to off, charging is complete.
Flickers (green)	<ul style="list-style-type: none"> <li>• Operating temperature range exceeded. Charge the battery indoors with an ambient temperature of 5 °C to 35 °C (41 °F to 95 °F).</li> <li>• A USB cable is not correctly connected, nor is a Charging AC Adapter correctly plugged, or the battery is faulty. Disconnect the USB cable or unplug the Charging AC Adapter and correctly connect it again, or change the battery.</li> </ul>

## 5 Disconnect the Charging AC Adapter from the electrical outlet and then disconnect the USB cable.

## Charging the Battery

### **Notes on Charging AC Adapter**

- Do not use the Charging AC Adapter EH-68P with any device that is not supported.
- Be sure to read and follow the warnings and cautions of “For Your Safety” (📖 ii) thoroughly before using the EH-68P.
- Be sure to read and follow the warnings for “The Battery” (📖 141) thoroughly before using the battery.
- The EH-68P is compatible with AC 100-240 V, 50/60 Hz electrical outlets. When using in other countries, use a third-party plug adapter as necessary. For more information about plug adapters, consult your travel agency.
- The Charging AC Adapter EH-68P is for charging the battery inserted into the camera. When the Charging AC Adapter is connected to the camera, the camera cannot be turned on.
- Do not, under any circumstances, use a Charging AC Adapter other than the EH-68P or a USB AC adapter. Failure to observe this precaution could result in overheating or in damage to the camera.

### **Note on AC Power Supply**

- If the AC Adapter EH-62F (available separately; 📖 137) is used, power is supplied to the camera from an electrical outlet and taking pictures and playing back pictures are available with this camera.
- Do not, under any circumstances, use any AC adapter other than the EH-62F. Failure to observe this precaution could result in overheating or in damage to the camera.

### **Charging Using Computer or Battery Charger**



- Connecting the COOLPIX S640 to a computer also charges the Rechargeable Li-ion Battery EN-EL12 (📖 131).
- Rechargeable Li-ion Battery EN-EL12 can also be charged using the Battery Charger MH-65 (available separately; 📖 137).

## Turning On and Off the Camera

Press the power switch to turn on the camera. The power-on lamp (green) will light for a moment and the monitor will turn on.

Press the power switch again to turn off the camera.

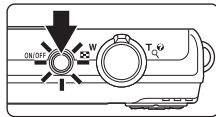

When the camera turns off, both the power-on lamp and monitor will turn off.

- When the camera is off, holding down the  button will turn the camera on in playback mode ( 30).



### Auto Power Off in Shooting Mode (Standby Mode)

If no operations are performed for about a minute (default setting), the monitor will turn off automatically and the camera will enter standby mode. If no operations are performed for another three minutes, the camera will turn off automatically (the auto off function).

- If the monitor is off in standby mode (the power-on lamp is blinking), press the power switch or the shutter-release button to reactivate it.
- The time allowed to elapse before the camera enters standby mode can be changed from the **Auto off** option ( 128) in the setup menu ( 116).

# Setting Display Language, Date and Time

A language-selection dialog is displayed the first time the camera is turned on.

## 1 Press the power switch to turn on the camera.

- The power-on lamp (green) will light for a moment and the monitor will turn on.

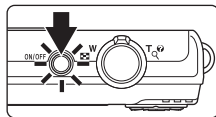

## 2 Use the rotary multi selector to choose the desired language and press the **OK** button.

- For information on using the rotary multi selector, see “The Rotary Multi Selector” (📖 10).

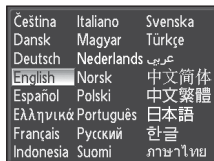

## 3 Choose **Yes** and press the **OK** button.

- If **No** is selected, the date and time will not be set.

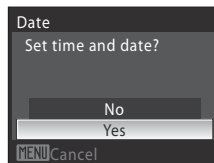

## 4 Press the rotary multi selector **◀** or **▶** to select your home time zone (city name) (📖 122) and press the **OK** button.

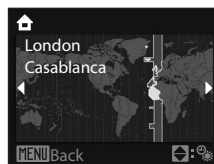

## Daylight Saving Time

If daylight saving time is in effect, press the rotary multi selector ▲ in the time zone selection screen displayed in step 4 to turn on the daylight saving time option.

When the daylight saving time option is enabled,  is displayed at the top of the monitor. To turn off the daylight saving time option, press ▼.

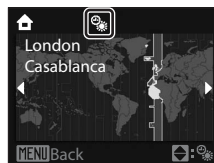



## 5 Edit the date.

- Rotate the rotary multi selector, or press ▲ or ▼ to edit the highlighted item.
- Press ► to move the highlight in the following order: **D** (day) → **M** (month) → **Y** (year) → **hour** → **minute** → **DMY** (the order in which the day, month, and year are displayed)
- Press ◀ to return to the previous item.

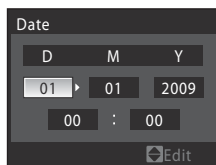

## 6 Choose the order in which the day, month and year are displayed and press the OK button or ►.

- The settings are applied and monitor display exits to shooting mode.

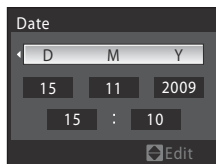

## Changing the Date and Time

- Select **Date** from the **Date** (📖 120) in the setup menu (📖 116) to change the current date and time and follow the procedure described in step 5 above.
- Select **Time zone** from the **Date** in the setup menu to change the time zone and daylight saving time settings (📖 120).

# Inserting Memory Cards

Image, sound, and movie files are stored in the camera's internal memory (approx. 45 MB) or on removable memory cards (available separately) (📖 138).

**If a memory card is inserted in the camera, data are automatically stored on the memory card, and data recorded to the memory card can be played back, deleted, or transferred. Remove the memory card to store data in the internal memory, or play back, delete, or transfer data from the internal memory.**

**1** Confirm that the power-on lamp and the monitor are off and open the battery-chamber/memory card slot cover.

- Be sure to turn off the camera before opening the battery-chamber/memory card slot cover.

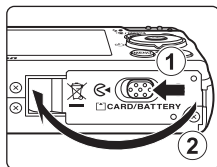

**2** Insert the memory card.

- Insert the memory card in the correct orientation (as shown on the right) until it clicks into place.
- Close the battery-chamber/memory card slot cover after inserting the memory card.

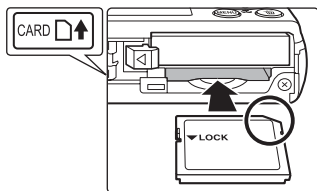

## ✓ Inserting the Memory Card Correctly

**Inserting the memory card upside down or backwards could damage the camera or the memory card.** Be sure to check the memory card is in the correct orientation.

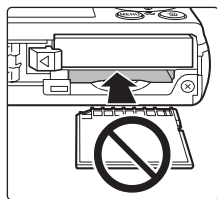

## Removing Memory Cards

Before removing memory cards, **turn the camera off** and confirm that the power-on lamp and the monitor are off.

Open the battery-chamber/memory card slot cover and press the card in (①) gently to partially eject the card. The card can then be removed by hand (②).

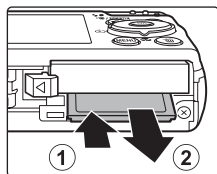

## ✓ Formatting a Memory Card

If the message at the right is displayed when the camera is turned on, the memory card must be formatted before use. **Note that formatting** (📖 129) **permanently deletes all data on the memory card.** Be sure to make copies of any pictures you wish to keep before formatting the memory card.

To format the memory card, use the rotary multi selector to choose **Yes** and press the **OK** button. When the confirmation dialog is displayed, choose **Format** and press the **OK** button to start formatting.

- Do not turn the camera off or open the battery-chamber/memory card slot cover until formatting is complete.
- When you insert a memory card that has been used in another device into this camera for the first time, be sure to format it (📖 129) with this camera.

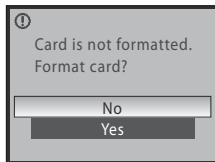

## ✓ The Write Protect Switch

Memory cards are equipped with a write protect switch. When this switch is in the “lock” position, data cannot be written to, or deleted from, the memory card. If the switch is in the “lock” position, unlock it by sliding the switch to the “write” position to record or delete pictures, or to format the memory card.

Write protect switch

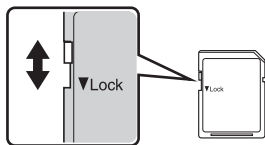

## ✓ Memory Cards

- Use only Secure Digital memory cards.
- Do not perform the following during formatting, while data is being written to or deleted from the memory card, or during data transfer to a computer. Failure to observe this precaution could result in the loss of data or in damage to the camera or memory card:
  - Eject the memory card
  - Remove the battery
  - Turn off the camera
  - Disconnect the AC adapter
- Do not use a computer to format the memory card.
- Do not disassemble or modify.
- Do not drop, bend, or expose to water or strong physical shock.
- Do not touch the metal terminals with your fingers or metal objects.
- Do not affix labels or stickers to the memory card.
- Do not leave in direct sunlight, closed vehicles or areas exposed to high temperatures.
- Do not expose to humidity, dust, or to corrosive gases.

## Step 1 Turn the Camera On and Select (Auto) Mode

This section describes how to take pictures in  (auto) mode, an automatic, “point-and-shoot” mode recommended for first-time users of digital cameras.

### 1 Press the power switch to turn on the camera.

- The power-on lamp (green) will light for a moment and the monitor will turn on. The lens will also extend.
- Proceed to step 4 when  is displayed on the monitor.

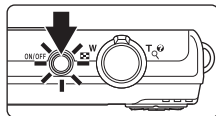

### 2 Press the button to display the shooting-mode selection menu.

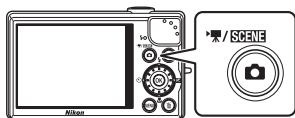



### 3 Use the rotary multi selector to choose and press the button.

- The camera enters  (auto) mode.



### 4 Check the battery level and number of exposures remaining in the monitor.

#### Battery Level

Monitor	Description
NO INDICATOR	Battery fully charged.
	Battery level low; prepare to charge or replace the battery.
 Battery exhausted.	Cannot shoot. Recharge or replace with a fully-charged battery.

#### Number of Exposures Remaining

The number of exposures remaining will be displayed.

The number of pictures that can be stored depends on the remaining capacity of the internal memory or memory card and the image mode setting ( 97).

#### Battery level indicator

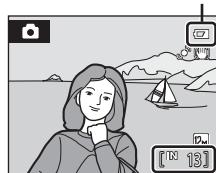

#### Number of exposures remaining



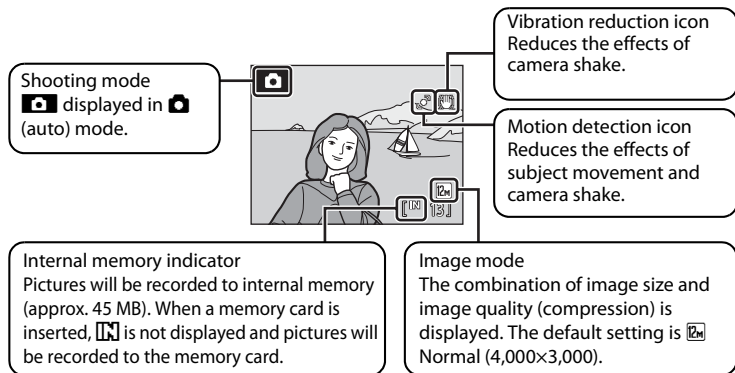



## Indicators Displayed in (Auto) Mode





The indicators and photo info displayed during shooting and playback will turn off after a few seconds ( 123).

If the monitor is turned off in standby mode to save power, press the power switch or the shutter-release button to reactivate it ( 128).

## Functions Available in (Auto) Mode

In  (auto) mode, macro mode ( 35) and exposure compensation ( 36) can be applied and pictures can be taken using the flash mode ( 32) and self-timer ( 34). Pressing the **MENU** button in  (auto) mode allows you to specify settings for all shooting menu options ( 95).

## Vibration Reduction and Motion Detection

- See **Vibration reduction** ( 125) or **Motion detection** ( 126) in the setup menu ( 116) for more information.
- Set vibration reduction to **Off** when using a tripod to stabilize the camera during shooting.

## Step 2 Frame a Picture

### 1 Ready the camera.

- Hold the camera steadily in both hands. Keep your fingers, hair, strap and other objects away from the lens, flash, AF-assist illuminator, microphone and speaker.

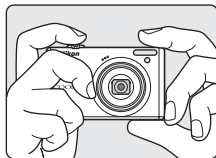

- When taking pictures in the portrait (vertical) orientation, turn the camera so that the built-in flash is above the lens.

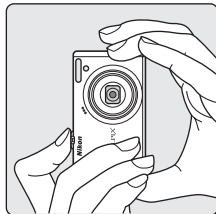

### 2 Frame the picture.

- Position the main subject near the center of the monitor.

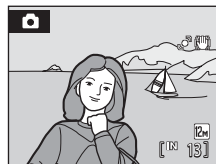

## Using the Zoom

Rotate the zoom control to activate optical zoom.

Rotate in the direction of **T** to zoom in on the subject.

Or rotate in the direction of **W** to have a wider view.

A zoom indicator is displayed at the top of the monitor when the zoom control is rotated.

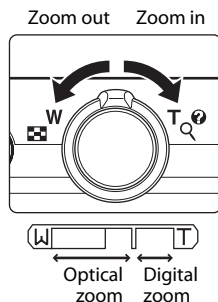

## Digital Zoom

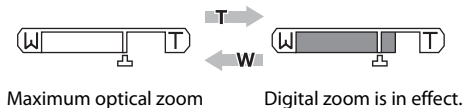

When the camera is already at the maximum optical zoom magnification, rotating the zoom control in the **T** direction will trigger digital zoom. The subject can be magnified up to 4x of the maximum optical zoom ratio.

When using digital zoom, the camera will focus on the center of the frame and the focus area will not be displayed.



## Digital Zoom and Interpolation

Unlike optical zoom, digital zoom uses a digital imaging process known as interpolation to magnify images, resulting in slight deterioration of picture quality according to the image mode (📖 96) and digital zoom magnification.

Interpolation is applied at zoom positions beyond . When zoom is increased beyond the  position, interpolation is initiated and the zoom indicator turns yellow to indicate that interpolation is being applied.

The position of  moves to the right as image size decreases, allowing for confirmation of the zoom positions at which shooting without interpolation is possible at the current image mode setting.



- Digital zoom can be disabled from the **Digital zoom** option (📖 127) in the setup menu (📖 116).

## Step 3 Focus and Shoot

### 1 Press the shutter-release button halfway.

- The camera focuses when the shutter-release button is pressed halfway (📖 13).
- Camera automatically selects the focus area (up to nine areas) containing the subject closest to the camera. When the subject is in focus, the focus area (active focus area) glows green.

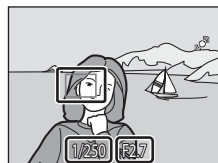
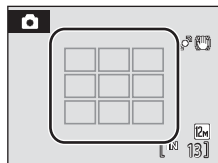
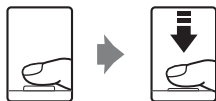

Shutter speed Aperture

- When using digital zoom, the camera focuses on the subject in the center of the frame, and the focus area is not displayed. When the subject is in focus, the focus indicator (📖 6) glows green.
- Press the shutter-release button halfway to display the shutter speed and aperture.
- Focus and exposure remain locked while the shutter-release button is pressed halfway.
- When the shutter-release button is pressed halfway and the camera is unable to focus, the focus area or focus indicator blinks red. Change the composition and press the shutter-release button halfway again.

### 2 Press the shutter-release button the rest of the way down.

- The shutter will be released and the picture will be recorded to the memory card or internal memory.





### **During Recording**

While pictures are being recorded, the number of exposures remaining display will blink. **Do not open the battery-chamber/memory card slot cover while pictures are being recorded.** Cutting power or removing the memory card in these circumstances could result in loss of data or in damage to the camera or card.



### **Autofocus**

Autofocus may not perform as expected in the following situations. In some rare cases, the subject may not be in focus despite the fact that the active focus area, or focus indicator, glows green:

- Subject is very dark
- Objects of sharply differing brightness are included in the scene (e.g. the sun is behind the subject and is in deep shadow)
- No contrast between the subject and surroundings (e.g. when the subject is standing in front of a white wall, wearing a white shirt)
- Several objects are at different distances from the camera (e.g. the subject is inside a cage)
- Subject is moving rapidly

In the situations noted above, try pressing the shutter-release button halfway to refocus several times, or focus on another subject and use focus lock ( 105). When using focus lock, be sure that the distance between the camera and the subject with which focus was locked is the same as that for the actual subject.







### **AF-assist Illuminator and Flash**

If the subject is poorly lit, the AF-assist illuminator ( 127) may light when the shutter-release button is pressed halfway and the flash ( 32) may fire when the shutter-release button is pressed all the way down.

## Step 4 Viewing and Deleting Pictures

### Viewing Pictures (Playback Mode)

Press the  (playback) button.

- The last picture shot will be displayed in full-frame playback mode.
- Rotate the rotary multi selector, or press , , , or , to view additional pictures (10).
- Pictures may be displayed briefly at low resolution while being read from the memory card or internal memory.
- Press the  button or the shutter-release button to return to shooting mode.
- When  is displayed, pictures stored in the internal memory will be displayed. When a memory card is inserted,  is not displayed and pictures stored on the memory card will be displayed.

 (shooting mode) button

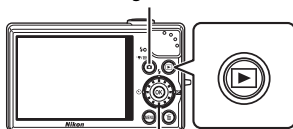

Rotary multi selector  (Playback) button

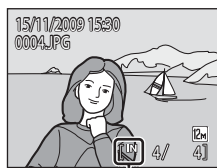



Internal memory indicator

### Deleting Pictures

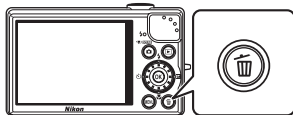
- 1 Press the  button to delete the picture currently displayed in the monitor.







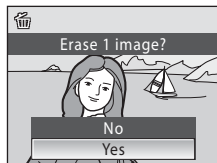





- 2 Use the rotary multi selector to choose **Yes** and press the  button.

- Deleted pictures cannot be recovered.
- To exit without deleting the picture, choose **No** and press the  button.



## Options Available in Playback Mode



The following options are available in full-frame playback mode.

Option	Use	Description	
Playback zoom	<b>T</b> 	Enlarge the view of the picture currently displayed in the monitor, up to about 10x. Press the  button to return to full-frame playback mode.	60
Thumbnail display/ Calendar display	<b>W</b> 	Display images by 4, 9 or 16 picture thumbnails, or display the calendar.	57, 59
Display shooting information		Display the histogram and the shooting information. Press the  button to return to full-frame playback.	10
Change playback mode		Display the playback-mode selection menu, and switch to List by Date mode or Auto sort playback mode.	61, 64
Switch to shooting mode		Press the  button or the shutter-release button.	30
			

## Pressing the Button to Turn on the Camera

When the camera is off, holding down the  button will turn the camera on in playback mode. The lens will not extend.

## Viewing Pictures

- Pictures stored in the internal memory can only be viewed if no memory card is inserted.
- Pictures that were shot using Face Priority ( 106) will be rotated automatically when displayed in full-frame playback mode according to the orientation of the face (excluding pictures that were shot using **Continuous**, **BSS** and **Multi-shot 16** ( 101)).
- If the monitor is turned off in standby mode to save power, press the power switch or the shutter-release button to reactivate it ( 128).

## Deleting the Last Picture Taken While in Shooting Mode

In shooting mode, press the  button to delete the last picture shot.

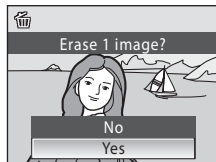

## Deleting Multiple Pictures

Choose **Delete** ( 113) from the Playback menu ( 110), List by Date menu ( 63) or Auto sort menu ( 66) to delete multiple pictures.

## Using the Flash

The flash has a range of about 0.5 to 8.0 m (1 ft. 8 in. to 26 ft.) when the camera is zoomed out all the way. With maximum optical zoom applied, the range is about 0.5 to 4.0 m (1 ft. 8 in. to 13 ft.) (when ISO sensitivity is set to auto). The following flash modes are available.

### AUTO Auto

Flash fires automatically when lighting is poor.

### Auto with red-eye reduction

Reduces “red-eye” in portraits (📖 33).

### Off

Flash will not fire even when lighting is poor.

### Fill flash

Flash fires whenever a picture is taken. Use to “fill-in” (illuminate) shadows and backlit subjects.

### Slow sync

Auto is combined with slow shutter speed.

Suitable for taking portrait images with the night landscape as the background.

Flash illuminates main subject; slow shutter speeds are used to capture background at night or under dim light.



## Setting the Flash Mode

### 1 Press (flash mode).

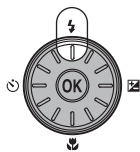
- The flash mode menu is displayed.



### 2 Use the rotary multi selector to choose the desired flash mode and press the button.

- The icon for the selected flash mode is displayed at the top of the monitor.
-  will disappear after a few seconds regardless of the current **Photo info** setting (📖 123).
- If a setting is not applied by pressing the  button within a few seconds, the selection will be cancelled.

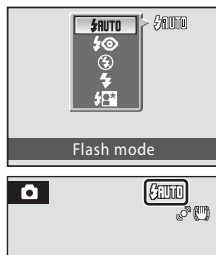

## ✓ Shooting When Lighting is Poor and When the Flash is Disabled (🚫)

- Use of a tripod is recommended to stabilize the camera during shooting and avoid the effects of camera shake. Set **Vibration reduction** (📖 125) in the setup menu (📖 116) to **Off** when using a tripod to stabilize the camera during shooting.
- The **ISO** indicator is displayed when the camera automatically increases sensitivity. Pictures taken when **ISO** is displayed may be slightly mottled.
- When **ISO** is displayed and higher sensitivity is applied, noise reduction may be automatically applied as pictures are recorded. This will result in increased recording times.

## ✓ Note on Using the Flash

Reflections from dust particles in the air may appear as bright spots in pictures. To reduce these reflections, set the flash to 🚫 (off).

## 🔧 The Flash Lamp

The flash lamp indicates the flash status when the shutter-release button is pressed halfway down.

- On 🟢 : Flash will fire when picture is shot.
- Blinks 🟡 : Flash is charging. Wait a few seconds and try again.
- Off 🚫 : Flash will not fire when picture is shot.

If the battery is low, the monitor display will turn off, and remain off, until the flash is fully charged.

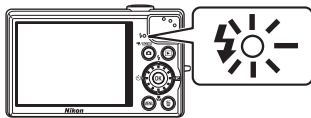

## 🔧 Flash Setting

The default flash mode setting varies with shooting mode.

- 📷 (auto): **🚫** auto.
- Scene mode: setting varies for different scene modes (📖 38-44).
- 📷 (smart portrait) mode: set to 🚫 off (when Blink Proof is on), **🚫** auto (when Blink Proof is off) (📖 53)
- Flash cannot be used simultaneously with certain features (📖 109).
- 📷 (subject tracking): 🚫 off

The flash mode setting applied in 📷 (auto) mode is stored in the camera's memory even after the camera is turned off, and reapplied the next time 📷 (auto) mode is selected.

## 🔧 Red-eye Reduction

This camera uses **Advanced Red-eye Reduction ("In-Camera Red-Eye Fix")**.

Pre-flashes are fired repeatedly at low intensity before the main flash, reducing the red-eye effect. If the camera detects "red-eye" when a picture is taken, Nikon's own In-Camera Red-Eye Fix processes the image before it is recorded.

Note the following when taking pictures:

- Because pre-flashes are fired, there is a slight lag between when the shutter-release button is pressed and when the picture is shot. This mode is not recommended when a quick shutter response is required.
- The time required to save the picture increases slightly.
- Advanced red-eye reduction may not produce the desired results in some situations.
- In extremely rare instances, areas not subject to red-eye may be affected by advanced red-eye reduction processing; in these cases, choose another mode and try again.

## Taking Pictures with the Self-Timer

The camera is equipped with a ten-second and two-second timer for self-portraits. When using the self-timer, use of a tripod is recommended. Set **Vibration reduction** (📖 125) to **Off** in the setup menu (📖 116) when using a tripod.

### 1 Press (self-timer).

- The self-timer menu is displayed.

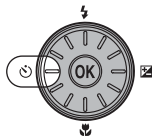

### 2 Use the rotary multi selector to choose **10s** or **2s** and press the button.

- **10s** (ten seconds): suited for important occasions (such as weddings)
- **2s** (two seconds): suited for preventing camera shake
- The mode selected for self-timer is displayed.
- If a setting is not applied by pressing the  button within a few seconds, the selection will be cancelled.



### 3 Frame the picture and press the shutter-release button halfway.

- Focus and exposure will be set.

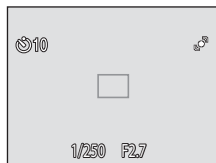

### 4 Press the shutter-release button the rest of the way down.

- The self-timer starts, and the number of seconds remaining the shutter is released is displayed in the monitor. The self-timer lamp will blink. The lamp stops blinking one second before the picture is taken and remains lit until the shutter is released.
- When the shutter is released, the self-timer turns **OFF**.
- To stop the timer before a picture is taken, press the shutter-release button again.

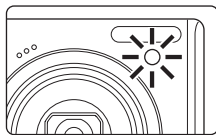
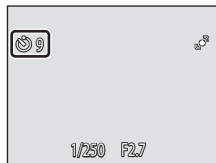

# Macro Mode



Macro mode is used for taking pictures of objects as close as 2 cm (0.8 in.). Note that the flash may be unable to light the entire subject at distances of less than 50 cm (1 ft. 7 in.).

## 1 Press (macro mode).

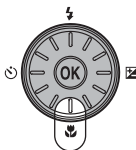
- The macro mode menu is displayed.



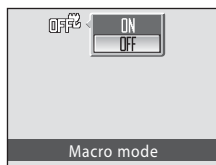

## 2 Use the rotary multi selector to choose **ON** and press the button.

- The macro mode icon () is displayed.
- If a setting is not applied by pressing the  button within a few seconds, the selection will be cancelled.



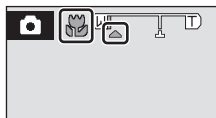

## 3 Use the zoom control and frame the picture.

- The closest distance at which the camera can focus varies depending on the zoom position. At the zoom position (wide angle position before the ) where the  icon and zoom display glow green, the camera can focus on subjects as close as 4 cm (1.6 in.) from the lens. At the wide-most zoom position, the camera can focus on subjects as close as 2 cm (0.8 in.) from the lens.



## Autofocus

When using  (auto) mode, if **Autofocus mode** ( 108) is set to **Full-time AF**, the camera will continually focus until the focus is locked when you press the shutter-release button halfway. A sound will be heard while the camera focuses.

When using other shooting modes, **Full-time AF** is turned on automatically when macro mode is turned on.

## The Macro Mode Setting

The macro mode setting applied in  (auto) mode is stored in the camera's memory even after the camera is turned off, and reapplied the next time  (auto) mode is selected.

# Exposure Compensation



Exposure compensation is used to alter the exposure from the value suggested by the camera to make pictures brighter or darker.

## 1 Press (exposure compensation).

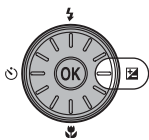
- The exposure compensation guide and histogram are displayed.



## 2 Use the rotary multi selector to adjust the exposure and press the button.

- When the subject is too dark: adjust the exposure compensation to "+" side.
- When the subject is too bright: adjust the exposure compensation to "-" side.
- Exposure compensation can be set to values between -2.0 and +2.0 EV.
- If a setting is not applied by pressing the  button within a few seconds, the selection will be cancelled.
- When set to any value other than **0.0**, the value is displayed with the  icon in the monitor.

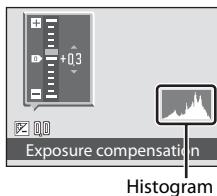

## 3 Press the shutter-release button to take the picture.

- To turn off exposure compensation, repeat from step 1 and set the value to **0.0**, then press .



### Exposure Compensation Value

The exposure compensation value applied in  (auto) mode is stored in the camera's memory even after the camera is turned off, and reapplied the next time  (auto) mode is selected.

### Using Exposure Compensation

- The camera tends to lower exposure when the frame is dominated by brightly lit objects (for example, sunlit expanses of water, sand, or snow) or when the background is much brighter than the main subject.
- Negative compensation may be called for when large areas of the frame contain very dark objects (for example, a swath of dark green leaves) or when the background is much darker than the main subject.

### Using the Histogram

A histogram is a graph showing the distribution of tones in the image.

- The horizontal axis corresponds to pixel brightness, with dark tones to the left and bright tones to the right. The vertical axis shows the number of pixels.
- Increasing exposure compensation shifts tone distribution to the right, and decreasing it shifts tone distribution to the left.
- Use as a guide when using exposure compensation and shooting without the flash.



## Shooting in Scene Mode

Camera settings are automatically optimized for the selected subject type. The following scene modes are available.

Scene auto selector	Portrait	Landscape	Sports
Night portrait	Party/indoor	Beach/snow	Sunset
Dusk/dawn	Night landscape	Close-up	Food
Museum	Fireworks show	Copy	Backlight
Panorama assist			

### Choosing a Scene Mode

- 1 Display the shooting-mode selection menu by pressing the button in shooting mode, and use the rotary multi selector to choose a scene icon.

- The icon for the scene mode that was chosen previously will be displayed. The default setting is (Scene auto selector).



- 2 Press , choose a scene and press the button.

- The screen changes to the shooting mode screen.
- “Features” → 38

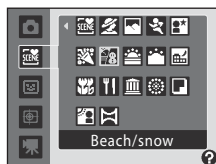

- 3 Frame the subject and take the picture.



### Image Mode

You can change the **Image mode** setting ( 96) by pressing the **MENU** button to display the (scene) menu.

Changes made to the image mode setting apply to all shooting modes (except for the movie mode).

## Features

The following icons are used for descriptions in this section:  = flash mode (📖 32),  = self-timer (📖 34),  = macro mode (📖 35),  = exposure compensation (📖 36).

### Scene auto selector

NR

By simply framing a picture, the camera automatically selects the optimum scene mode. See “Shooting in the Scene Mode Selected by the Camera (Scene Auto Selector)” (📖 45) for more information.

			Off <sup>2</sup>		Off <sup>3</sup>		0.0 <sup>2</sup>
---	---	---	------------------	---	------------------	---	------------------

- 1 The camera automatically chooses the optimum flash mode setting for the scene mode it has selected.  (off) can be selected.
- 2 Other settings can be selected.
- 3 Changes to On when the camera selects close-up scene mode.

### Portrait

NR

Use this mode for taking portraits in which the main subject stands out clearly.

- If the camera detects a face, it focuses on the face (Shooting with Face Priority → 📖 106).
- If the camera detects multiple faces, the camera focuses on the face closest to the camera.
- The skin softening feature can make the subject's (up to three people) skin appear smoother, then record the image (📖 52).
- If no face is recognized, the camera will focus on the subject in the center of the frame.
- Digital zoom is not available.



			Off*		Off		0.0*
---	---	---	------	---	-----	---	------

\* Other settings can be selected.

### Landscape

NR

Use this mode for vivid landscapes and cityscapes.

- Camera focuses at infinity. When the shutter-release button is pressed halfway, the focus area or focus indicator (📖 6) always lights green; however, focus may not be set for near subjects, while the camera focuses at infinity.
- AF-assist illuminator (📖 127) does not light.



			Off*		Off		0.0*
---	---	---	------	---	-----	---	------



\* Other settings can be selected.

**NR**: Indicates pictures shot in this scene mode are processed automatically to reduce noise, and therefore may take more time to save.

## Sports

Use this mode for dynamic action shots that freeze the action in a single shot and record motion in a series of pictures. With continuous shooting, instantaneous movements in moving subjects can be captured clearly.



- The camera focuses on the subject in the center of the frame. The camera focuses continuously until focus is locked by pressing the shutter-release button halfway.
- While the shutter-release button is held down, pictures are taken at rate of up to about 0.8 frames per second (fps) when image mode is set to  **Normal (4000)**. Shooting ends when the shutter-release button is released, or ten shots have been taken with the shutter-release button held down.
- Focus, exposure compensation, and white balance are fixed at the values determined with the first shot in each series.
- AF-assist illuminator ( 127) does not light.
- The maximum frame rate with continuous shooting may vary, depending upon the current image mode and the type of memory card used.





\* Other settings can be selected.

## Night portrait



Use this mode for portraits of a human subject shot in front of background lighting at night. Flash is used to illuminate the subject while maintaining the mood of the background.





- If the camera detects a face, it focuses on the face (Shooting with Face Priority →  106).
- If the camera detects multiple faces, the camera focuses on the face closest to the camera.
- The skin softening feature can make the subject's (up to three people) skin appear smoother, then record the image ( 52).
- If no face is recognized, the camera will focus on the subject in the center of the frame.
- Digital zoom is not available.



1 Fixed to slow sync with red-eye reduction.

2 Other settings can be selected.

: Indicates a tripod is recommended when using this scene mode. Turn **Vibration reduction** ( 125) to **Off** when using a tripod.

## Shooting in Scene Mode

### Party/indoor

**NR**

Suitable for taking pictures in parties. Captures the effects of candlelight and other indoor background lighting.

- The camera focuses on the subject in the center of the frame.
- Hold the camera steadily as pictures are easily affected by camera shake. When shooting under low lighting, use of a tripod is recommended. Set **Vibration reduction** (📖 125) to **Off** when using a tripod to stabilize the camera during shooting.

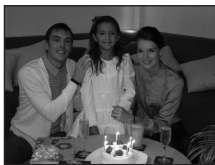

1 Fill flash with slow sync and red-eye reduction. Other settings can be selected.

2 Other settings can be selected.

### Beach/snow

**NR**

Captures the brightness of such subjects as snowfields, beaches, or sunlit expanses of water.

- The camera focuses on the subject in the center of the frame.



\* Other settings can be selected.

### Sunset

**NR**

Preserves the deep hues seen in sunsets and sunrises.

- Camera focuses at infinity. When the shutter-release button is pressed halfway, the focus area or focus indicator (📖 6) always lights green; however, focus may not be set for near subjects, while the camera focuses at infinity.
- AF-assist illuminator (📖 127) does not light.



\* Other settings can be selected.



: Indicates a tripod is recommended when using this scene mode. Turn **Vibration reduction** (📖 125) to **Off** when using a tripod.

**NR**: Indicates pictures shot in this scene mode are processed automatically to reduce noise, and therefore may take more time to save.

### Dusk/dawn



Preserves the colors seen in the weak natural light before sunrise or after sunset.

- Camera focuses at infinity. When the shutter-release button is pressed halfway, the focus area or focus indicator () always lights green; however, focus may not be set for near subjects, while the camera focuses at infinity.
- AF-assist illuminator () does not light.





\* Other settings can be selected.

### Night landscape



Use this mode to capture night landscapes. Slow shutter speeds are used to produce stunning night landscapes.

- Camera focuses at infinity. When the shutter-release button is pressed halfway, the focus area or focus indicator () always lights green; however, focus may not be set for near subjects, while the camera focuses at infinity.
- AF-assist illuminator () does not light.



\* Other settings can be selected.

: Indicates a tripod is recommended when using this scene mode. Turn **Vibration reduction** () to **Off** when using a tripod.

**NR**: Indicates pictures shot in this scene mode are processed automatically to reduce noise, and therefore may take more time to save.

## Shooting in Scene Mode

### Close-up

NR

Use to photograph flowers, insects and other small objects at close range.

- Macro mode (📖 35) will be turned on and the camera automatically zooms to the position at the closest distance at which the camera can focus.
- The closest distance at which the camera can focus varies depending on the zoom position. At the zoom position (wide angle position before the 📶 icon) where the 🐛 icon and zoom display glow green, the camera can focus on subjects as close as 4 cm (1.6 in.) from the lens. At the wide-most zoom position, the camera can focus on subjects as close as 2 cm (0.8 in.) from the lens.
- **AF area mode** is set to **Manual**. Press the **OK** button to choose the focus area in which focus is acquired. (📖 104).
- The camera focuses continuously until focus is locked by pressing the shutter-release button halfway.
- As pictures are easily affected by camera shake, be sure that **Vibration reduction** (📖 125) is enabled and hold the camera steadily.



\* Other settings can be selected. Note that when shooting with the flash, the flash may be unable to light the entire subject at distances of less than 50 cm (1 ft. 7 in.).

### Food

NR

Use this mode when taking pictures of food. See "Taking Pictures in Food Mode" (📖 47) for more information.

- **AF area mode** is set to **Manual**. Press the **OK** button to choose the focus area in which focus is acquired (📖 104).



\* Other settings can be selected.

### Museum

Use indoors where flash photography is prohibited (for example, in museums and art galleries) or in other settings in which you do not want to use the flash.

- Camera focuses on subject in center of frame.
- BSS (Best Shot Selector) (📖 101) is used when shooting.
- As pictures are easily affected by camera shake, be sure that **Vibration reduction** (📖 125) is enabled and hold the camera steadily.
- AF-assist illuminator (📖 127) does not light.



\* Other settings can be selected.

**NR**: Indicates pictures shot in this scene mode are processed automatically to reduce noise, and therefore may take more time to save.

### Fireworks show



Slow shutter speeds are used to capture the expanding burst of light from fireworks.

- Camera focuses at infinity. When the shutter-release button is pressed halfway, the focus area or focus indicator (📖 6) always lights green; however, focus may not be set for near subjects, while the camera focuses at infinity.
- AF-assist illuminator (📖 127) does not light.



### Copy



Provides clear pictures of text or drawings on a white board or in print.

- The camera focuses on the subject in the center of the frame.
- Use macro mode (📖 35) to focus at short ranges.
- Colored text and drawings may not show up well.



\* Other settings can be selected.

### Backlight

Use when light is coming from behind the subject, throwing features or details in shadow. The flash fires automatically to “fill in” (illuminate) shadows.

- The camera focuses on the subject in the center of the frame.



\* Other settings can be selected.

: Indicates a tripod is recommended when using this scene mode. Turn **Vibration reduction** (📖 125) to **Off** when using a tripod.

: Indicates pictures shot in this scene mode are processed automatically to reduce noise, and therefore may take more time to save.

## Shooting in Scene Mode

### ⏏ Panorama assist

NR



Use to take a series of pictures that will later be joined to form a single panorama using the supplied Panorama Maker software. See "Taking Pictures for a Panorama" (📖 49) for more information.



\* Other settings can be selected.

NR: Indicates pictures shot in this scene mode are processed automatically to reduce noise, and therefore may take more time to save.



## Shooting in the Scene Mode Selected by the Camera (Scene Auto Selector)

By simply framing a picture, the camera automatically selects the optimum scene mode for simpler shooting. When the camera is aimed at a subject in **SCENE** scene auto selector, the camera automatically selects one of the following scene modes.

- Auto mode (typical photography)
- Landscape (📖 38)
- Night landscape (📖 41)
- Backlight (📖 43)
- Portrait (📖 38)
- Night portrait (📖 39)
- Close-up (📖 42)

- 1 Display the shooting-mode selection menu by pressing the  button in shooting mode, and use the rotary multi selector to choose **SCENE** **Scene auto selector** (📖 37).

- Scene auto selector will be enabled.

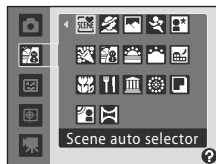

- 2 Frame the subject and take the picture.

- When the camera automatically selects a scene mode, the shooting mode icon changes to that for the scene mode currently enabled.

: Auto mode

: Portrait

: Landscape

: Night portrait

: Night landscape

: Close-up

: Backlight

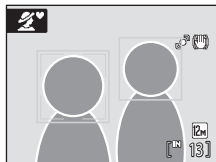



- Press the shutter-release button halfway to set focus and exposure. When the subject is in focus, the active focus area glows green.
- Press the shutter-release button the rest of the way down to take the picture.

### **Note on Scene Auto Selector Mode**



Depending upon shooting conditions, the camera may not select the expected scene mode. Should this occur, switch to  (auto) mode (📖 24) or choose the desired scene mode manually (📖 37).

### **Focusing When Using Scene Auto Selector Mode**

- When using scene auto selector mode, if the camera detects a face, it focuses on the face (Shooting with Face Priority → 📖 106).
- When the shooting mode icon is  or  (Close-up), just as when **AF area mode** (📖 104) is set to **Auto**, the camera automatically selects the focus area (up to nine areas) containing the subject closest to the camera.

### **Flash Mode in Scene Auto Selector Mode**

 **RAUTO** (auto) (default setting) and  (off) flash mode settings (📖 32) can be applied.



- When  **RAUTO** (auto) is applied, the camera automatically chooses the optimum flash mode setting for the scene mode it has selected.
- When  (off) is applied, the flash does not fire, regardless of shooting conditions.

### **Functions Restricted in Scene Auto Selector Mode**

- Digital zoom is not available.
- The macro mode button on the rotary multi selector cannot be used (📖 10, 35).



## Taking Pictures in Food Mode



Use this mode when taking pictures of food.

- 1 Display the shooting-mode selection menu by pressing the  button in shooting mode, and use the rotary multi selector to choose  **Food** (📖 37).

- Macro mode (📖 35) will be turned on and the camera automatically zooms to the position at the closest distance at which the camera can focus.



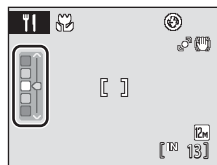

- 2 Press the rotary multi selector  or  to choose white balance.

- Press  to increase the amount of red, or  to increase the amount of blue.







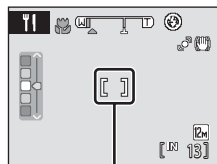

- 3 Frame the picture.

- The closest distance at which the camera can focus varies depending on the zoom position. At the zoom position (wide angle position before the  icon) where the  icon and zoom display glow green, the camera can focus on subjects as close as 4 cm (1.6 in.) from the lens. At the wide-most zoom position, the camera can focus on subjects as close as 2 cm (0.8 in.) from the lens.



Focus area

- **AF area mode** is set to **Manual** (📖 104). Press the  button to move the focus area. Rotate the rotary multi selector or press , ,  or  to move the focus area to the desired position. Press the  button again to lock the selected focus area.
- Self-timer (📖 34) and exposure compensation (📖 36) settings can be adjusted while the focus area is locked.

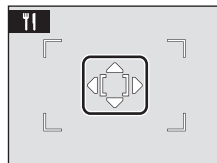

### 4 Press the shutter-release button to take the picture.

- Focus is locked when the shutter-release button is pressed halfway, and a picture is taken when the shutter-release button is pressed the rest of the way down.
- When the camera is unable to focus, the focus area blinks red. Change the composition and press the shutter-release button halfway again.



### ✔ Note on Food Mode

- Flash mode is disabled. Macro mode setting (📖 35) is set to **ON** and cannot be changed.
- As pictures are easily affected by camera shake, be sure that **Vibration reduction** (📖 125) is enabled and hold the camera steadily.



### 📝 White Balance Setting in Food Mode

- Increasing the amount of red or blue decreases the effects of lighting conditions.
- Adjusting the white balance setting while using food mode does not change the White balance setting in the shooting menu (📖 98).
- The white balance setting applied in food mode is stored in the camera's memory even after the camera is turned off, and reapplied the next time food mode is selected.

## Taking Pictures for a Panorama

The camera focuses on the subject in the center of the frame. Use a tripod for best results.









Set **Vibration reduction** (📖 125) in the setup menu (📖 116) to **Off** when using a tripod to stabilize the camera during shooting.

- 1 Display the shooting-mode selection menu by pressing the  button in shooting mode, and use the rotary multi selector to choose  **Panorama assist** (📖 37).

- The  icon is displayed to show the direction in which pictures will be joined.



- 2 Use the rotary multi selector to choose the direction and press the  button.

- Decide how pictures will be joined together in the completed panorama; right () , left () , up () or down () .
- The yellow panorama direction icon () will move to the direction pressed and press the  button to choose the direction. A white panorama direction icon () will be displayed in the chosen direction.
- Apply flash mode (📖 32), self-timer (📖 34), macro mode (📖 35) and exposure compensation (📖 36) settings with this step, if necessary.
- Press the  button again to choose a different direction.



- 3 Take the first picture.

- The picture taken will be displayed in 1/3 of the monitor.



### 4 Shoot the second picture.

- Compose the next picture so that it overlaps the first picture.
- Repeat until you have taken the necessary number of pictures to complete the image.

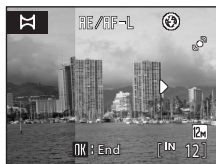

### 5 Press the **OK** button when shooting is complete.

- The camera returns to step 2.



### **Panorama Assist**

- Set flash mode, self-timer, macro mode and exposure compensation before taking the first picture. They cannot be changed after the first picture is taken. Pictures cannot be deleted, nor can zoom or **Image mode** setting (📖 96) be adjusted after the first picture is taken.
- The panorama series is terminated if the camera enters standby mode with the auto off function (📖 128) during shooting. Increasing the time allowed to elapse before the auto off function is enabled is recommended.

### **AE/AF-L (exposure lock) Indicator**

When using panorama assist mode, all pictures in the panorama have the same exposure, white balance, and focus as the first picture of the panorama.

When the first picture is shot, **AE/AF-L** is displayed to indicate that exposure, white balance, and focus are locked.



### **Panorama Maker**

Install Panorama Maker from the supplied Software Suite CD.



Transfer pictures to a computer (📖 80) and use Panorama Maker (📖 83) to join them in a single panorama.

### **More Information**

See "File and Folder Names" (📖 139) for more information.

### Using Smart Portrait Mode

At the default setting, the camera detects smiling faces using face priority and releases the shutter automatically (smile timer function). The skin softening function makes a human subject's skin appear smoother.

- 1 Display the shooting-mode selection menu by pressing the  button in shooting mode, use the rotary multi selector to choose , and then press the  button.

- Smart portrait mode is selected.

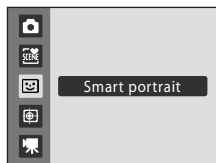

- 2 Frame the picture.

- Point the camera at the subject.
- When the camera detects a face, the focus area containing the face will be displayed with a yellow double border, and when focus is locked the double border will turn green for a moment.
- Up to three faces can be detected. When more than one face is detected, the face closest to the center of the frame is framed by a double border and the others by single borders.



- 3 The shutter is automatically released.

- If the camera detects that the face framed by the double border is smiling, the **Smile timer** function (📖 53) automatically releases the shutter.
- When the camera detects a face, the self-timer lamp (📖 4) blinks. Immediately after the shutter is released, the self-timer lamp flickers. Each time the shutter is released, the camera repeats automatic shooting by face priority and smile detection.
- The shutter can also be released by pressing the shutter-release button. If no face is detected, the camera focuses on the subject in center of frame.
- When the shutter is released, the camera makes the subject's skin appear smoother, then records the image (**Skin softening** (📖 52)).

- 4 Finish shooting.

- To finish automatic shooting of smiling faces, either turn the camera off, set **Smile timer** to **Off**, or press the  button and select another shooting mode.

### Face Priority and Smiling Face Detection Features

- Under some shooting conditions, faces and smiling faces may not be detected properly.
- See "Notes on Face Priority" (📖 107) for more information about face priority.

### Auto Power Off When Using Smile Timer (Standby Mode)

When Smile timer is set to On, the auto off function (📖 128) will turn the camera off in the following situations if no operations are performed.

- The camera is unable to detect any face.
- The camera has detected one or more faces, but is unable to detect a smiling face.

### Functions Available in Smart Portrait Mode

- Flash mode is disabled when **Blink proof** is set to **On**. Flash mode (📖 32) will be changed to **⚡AUTO** (auto) when **Blink proof** is set to **Off** (other settings can be selected).
- Exposure compensation (📖 36) can be adjusted.
- If **Smile timer** and **Blink proof** are both set to **Off**, self-timer (📖 34) can be set.
- Macro mode cannot be used.
- Digital zoom is not available.
- Press the **MENU** button to display the  (smart portrait) menu and change the settings for **Image mode**, **Skin softening**, **Smile timer**, or **Blink proof**.

### More Information

See "Autofocus" (📖 29) for more information.

## Smart Portrait Menu

The smart portrait menu contains the following options.

Press the **MENU** button in smart portrait mode to display the smart portrait menu and use the rotary multi selector to modify and apply settings.

#### Image mode

Allows you to set **Image mode** (📖 96).

Changes made to the image mode setting apply to all shooting modes (except movie mode).

#### Skin softening

Set skin softening. When the shutter is released, the camera detects up to 3 faces and processes the image to make the faces appear smoother, then records the image. The effect of this feature can be set to **High**, **Normal** (default setting), and **Low**. When **Off** is selected, skin softening is turned off.

- When skin softening is enabled, the icon for the current setting is displayed in the monitor during shooting (📖 6). When **Off** is selected, an icon for the current setting is not displayed. Additionally, the effects of the current skin softening setting cannot be previewed in the monitor while shooting. To confirm, view the pictures after shooting.



### Smile timer

- **On** (default setting): Among the detected faces, if a smile is detected in the face that is framed by a double border, the camera automatically releases the shutter.
- **Off**: The camera does not release the shutter automatically using smile timer; the shutter is only released when the shutter-release button is pressed.
- When smile timer is enabled, the current setting is displayed during shooting (📖 6). When **Off** is selected, an icon for the current setting is not displayed.

### Blink proof

When set to **On**, the shutter is released two times each time a picture is taken; the camera chooses one image in which the subjects' eyes are open, and saves it.

- The message on the right will be displayed for a few seconds when the camera records an image in which someone may have been blinking.
- When set to **On**, the flash cannot be used.
- The default setting is **Off**.
- When blink proof is enabled, the current setting is displayed during shooting (📖 6). When **Off** is selected, an icon for the current setting is not displayed.

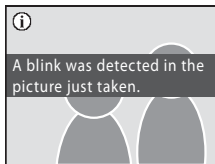



### ✓ Notes on Skin Softening



- When taking pictures with skin softening, the time required to save the pictures increases slightly.
- Depending on shooting conditions, even if the camera detects a face on the monitor at the time of shooting, effects of the skin softening function may not be visible, and areas other than the face may be processed. If the desired effect is not achieved, set **Skin softening** to **Off** and shoot again.
- The amount of skin softening effect that is applied cannot be set while using the portrait or night portrait scene modes.
- Skin softening can also be applied to pictures after they have been taken (📖 73).

## Subject Tracking Mode

Use this mode to shoot moving subjects. Subject tracking begins once you select a subject to be focused on, and the focus area will move and follow the subject. At the default setting, once the camera detects a person's face it will automatically begin tracking that person (face priority tracking).

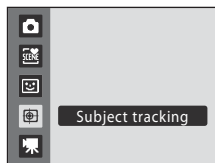
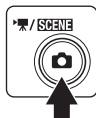
- 1** Display the shooting-mode selection menu by pressing the  button in shooting mode, use the rotary multi selector to choose , and then press the **OK** button.



- The camera enters subject tracking mode, and a single border is displayed in the center of the frame.
- The flash mode ( 32) is set to  (off) (the setting can be changed).

- 2** Select a subject.

- Frame the subject in the center of the single border, and press the **OK** button.
  - The subject is registered.
  - When the camera is unable to focus on the subject, the single border will glow red. Change the composition and try again.



- Once the subject is selected, it is framed by a yellow double border, and subject tracking begins.
- If the camera detects a face, that face is automatically registered as the subject to be tracked, and subject tracking begins ( 56).
- To change subjects, press the **OK** button to cancel the currently selected subject, then select a new subject.

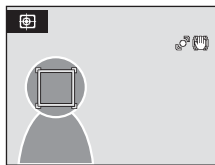

- If the camera loses sight of the subject, the double border disappears; register the subject again.

### 3 Press the shutter-release button to take the picture.

- If the camera focuses on the focus area framed by the double border when the shutter-release button is pressed halfway, the double border turns green and the focus is locked.
- If the camera is unable to focus, the double border will blink. Press the shutter-release button halfway again to focus.
- If the shutter-release button is pressed halfway while the double border is not displayed, the camera focuses on the subject at the center of the frame.
- Press the shutter-release button the rest of the way down to take the picture.

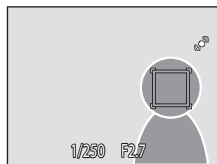

### ✓ Subject Tracking Mode

- Set the zoom position, flash mode, exposure compensation, and menu before registering a subject. If any of these are changed after a subject is registered, the subject will be canceled.
- During certain conditions, such as when the subject is moving quickly, when there is a large amount of camera shake, or when there are multiple subjects that look alike, the camera may not be able to register or track a subject, or the camera may track a different subject. Additionally, the subject may not be tracked properly depending on factors such as the subject's size and brightness.
- In some rare cases shooting subjects with which autofocus may not perform as expected (📖 29), the subject may not be in focus despite the fact that the double border glows green. Should this occur, switch to auto mode and set **AF area mode** (📖 104) to **Manual** or **Center**, refocus on another subject positioned at the same distance from the camera as the actual portrait subject, and use focus lock (📖 105).

### ✍ Usable Functions in Subject Tracking Mode

- Digital zoom is not available.
- Flash mode (📖 32) and exposure compensation (📖 36) settings can be adjusted.
- Self-timer (📖 34) and macro mode (📖 35) cannot be used.
- Press the **MENU** button to display the  (subject tracking) menu and change the settings for **Image mode**, **Autofocus mode**, or **Face priority tracking** (📖 56).

### Subject Tracking Menu

The subject tracking menu contains the following options.

Press the **MENU** button in subject tracking mode to display the subject tracking menu and use the rotary multi selector to modify and apply settings.

#### Image mode

Allows you to set **Image mode** (📖 96).

Changes made to the image mode setting apply to all shooting modes (except movie mode).

#### Autofocus mode

Allows you to set the **Autofocus mode** (📖 108) used for subject tracking mode (the default setting is **Full-time AF**).

When using subject tracking mode while set to **Full-time AF**, the camera continuously focuses once a subject is selected for subject tracking until the shutter-release button is pressed halfway to lock the focus. The sound of the camera focusing will be heard.

Changes made to the autofocus mode setting in this mode will not be applied to the autofocus mode setting in the auto shooting mode. The autofocus mode setting applied in subject tracking mode is stored in the camera's memory even after the camera is turned off.

#### Face priority tracking

When **On** is selected (default setting), if the camera detects a subject's skin, that subject is automatically registered as the subject to be tracked, and subject tracking begins tracking that subject.

#### ✔ Notes on Face Priority Tracking

- Only one subject can be tracked. If the camera detects multiple faces at the same time, the face nearest the center of the frame is tracked.
- Depending on shooting conditions, such as whether or not the subject is facing the camera, faces may not be detected properly. → Notes on Face Priority (📖 107)
- When the subject you want to focus on cannot be tracked, press the **OK** button to track again, or set **Face priority tracking** to **Off**, frame the picture so that the subject is inside the single border in the center of the frame, and press the **OK** button to register the subject again.

## Viewing Multiple Pictures: Thumbnail Playback

Rotate the zoom control to **W** (📷) in full-frame playback mode (📖 30) to display pictures as thumbnail images in thumbnail playback mode.



The following operations can be performed in thumbnail playback.

To	Use	Description	📖
Choose pictures		Rotate the rotary multi selector, or press ▲, ▼, ◀ or ▶ to choose pictures.	10
Increase the number of thumbnails displayed/Calendar display	<b>W</b> (📷)	Rotate the zoom control towards the <b>W</b> (📷) direction to increase the number of thumbnails from 4 → 9 → 16 → Calendar display. In Calendar display, move and choose the image according to the date (📖 59). Rotate towards the <b>T</b> (📷) direction to return to thumbnail display.	-
Decrease number of picture thumbnails displayed	<b>T</b> (📷)	Rotate the zoom control towards the <b>T</b> (📷) direction to decrease the number of thumbnails from 16 → 9 → 4. Rotate towards <b>T</b> (📷) again during 4 thumbnails display to return to full frame playback.	-
Return to full-frame playback	<b>OK</b>	Press the <b>OK</b> button.	30
Switch to shooting mode		Press the  button or the shutter-release button.	30

## Viewing Multiple Pictures: Thumbnail Playback

### **Icons on the Thumbnails**

When pictures that are marked for **Print set** (📖 92) or **Protect** (📖 113) are selected in thumbnail playback mode, the icons shown at the right are displayed with them.

Movies are displayed as film frames.

Print-set icon

Protect icon

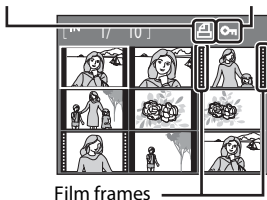



### **Thumbnail Display in Auto Sort**

When thumbnails are displayed in the auto sort mode (📖 64), the icon representing the type of the pictures being played back will appear at the top right corner of the screen.





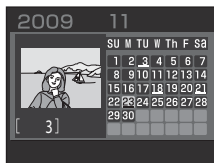

## Calendar Display

Rotate the zoom control towards **W** () during playback mode when 16 thumbnails are displayed ( 57) to change to Calendar display.

Move the cursor and choose the image according to the date. Dates will be underlined in yellow if there are pictures taken on that date.



The following operations can be performed while the Calendar is displayed.

To	Use	Description	
Select date		Rotate the rotary multi selector, or press <b>▲</b> , <b>▼</b> , <b>◀</b> or <b>▶</b> to select a date.	10
Return to full-frame playback		Changes to the full-frame playback for the first photo taken for the chosen date.	30
Return to thumbnail display	<b>T</b> (  )	Rotate the zoom control to <b>T</b> (  )	57

### Notes on Calendar Display

- Images taken without the date set will be treated as images taken on “01.01.09”.
-  and **MENU** buttons are disabled while the Calendar is displayed.

### Note on List by Date Mode

Use list by date mode ( 61) to playback images of the same date.

Playback menu ( 63) operations can also be performed for the images of the chosen date.





## Taking a Closer Look: Playback Zoom

Rotating the zoom control to **T** (Q) during full-frame playback mode (📖 30) zooms in on the current picture, enlarging and displaying the center of the picture on the monitor.

- The guide at lower right shows which portion of the picture is enlarged.



The following operations can be performed while pictures are zoomed in.

To	Use	Description	📖
Zoom in	<b>T</b> (Q)	Zoom increases each time the zoom control is rotated to <b>T</b> (Q), up to about 10x.	–
Zoom out	<b>W</b> (📐)	Rotate the zoom control to <b>W</b> (📐). When the magnification ratio reaches 1x, the display returns to full-frame playback mode.	–
Move the display area		Press the rotary multi selector ▲, ▼, ◀, or ▶ to move the display area to other areas of the picture.	10
Return to full-frame playback	ⓄK	Press the ⓄK button.	30
Crop picture	<b>MENU</b>	Press to crop the current picture to contain only the portion visible in the monitor.	75
Switch to shooting mode	 	Press the  button or the shutter-release button.	30

### Pictures Taken Using the Face Priority Function

When zooming in (playback zoom) on a picture taken using the face priority function (📖 106), the picture will be enlarged with the face detected with shooting at the center of the monitor (excluding pictures that were shot using **Continuous**, **BSS** and **Multi-shot 16** (📖 101)).

- If more than one face was detected, the picture will be enlarged with the face on which focus was acquired at the center of the monitor. Press the rotary multi selector ▲, ▼, ◀, or ▶ to display other faces that were detected.
- When rotating the zoom control towards the **T** (Q) or **W** (📐) direction to adjust the zoom ratio, the center of the picture (normal playback zoom display), rather than the face, is displayed at the center of the monitor.





## Viewing Pictures by Date (List by Date Mode)

In the **DATE** list by date mode, you can playback only the images taken on the same date. In full-frame playback mode, just as with the normal playback mode, picture displays can be enlarged, pictures can be edited, and movies can be played back. By pressing the **MENU** button to display the “List by Date Menu” (📖 63), you can delete all pictures with the same date, view a slide show of pictures with the same date, and set print set or protect for all pictures with the same date.

### Selecting a Date in List by Date Mode

- 1 Display the playback-mode selection menu by pressing the **▶** button in playback mode, use the rotary multi selector to select **DATE** and then press the **OK** button.



- Dates for which pictures exist will be listed.

- 2 Select the desired date.

- Camera lists up to 29 dates. If pictures exist for more than 29 dates, all pictures recorded earlier than most recent 29 dates will be listed together as **Others**.
- When the **OK** button is pressed, the first picture for that date will be displayed in full-frame playback.
- Rotate the zoom control to **W** (📷) in full-frame playback mode to return to the list of shooting dates screen.















### ✓ Notes on List by Date Mode

- Only the most recent 9,000 pictures can be displayed in list by date mode.
- Images taken without the date set will be treated as images taken on “01.01.09”.
- Histogram and shooting information (📖 10) cannot be displayed when using list by date mode.











## Using List by Date Mode

The following operations are possible from the list by date screen.

To	Use	Description	
Select date		Rotate the rotary multi selector, or press ▲ or ▼ to select a date.	10
Switch to full-frame playback		Press the  button to display the first picture taken on the selected date. Rotate the zoom control to <b>W</b>  in full-frame playback to return to the list of shooting dates screen.	31
Delete pictures		Press the  button after selecting a date, and a confirmation dialog will be displayed. Choose <b>Yes</b> and press the  button to delete all pictures taken on the selected date.	30
View list by date menu	<b>MENU</b>	Press the <b>MENU</b> button to display the list by date menu.	63
Change playback mode		Press the  button to display the playback-mode selection menu.	9
Switch to shooting mode		Press the  button or the shutter-release button.	30
			

## List by Date Menu

Press the **MENU** button in list by date mode to operate the following menus to be applied to only the pictures taken on the specified date.

Quick retouch*	→  71
D-Lighting*	→  72
Skin softening*	→  73
Print set	→  92
Slide show	→  112
Delete	→  113
Protect	→  113
Rotate image*	→  114
Small picture*	→  74
Voice memo*	→  67

\* During full-frame playback only









When the **MENU** button is pressed in the list by date screen ( 61), options can be applied to all pictures taken on the same date, or all pictures taken on the same date can be deleted.

To apply options to individual pictures, or to select individual pictures for deletion, display a picture full-frame and press the **MENU** button.

## Image Searching (Auto Sort Mode)

Pictures and movies will automatically be sorted in any of the following folder names after shooting them.



If the  auto sort mode is selected, you can display the pictures and movies by selecting the folder name sorted in shooting.

 Smile	 Portraits	 Food
 Landscape	 Dusk to dawn	 Close-ups
 Movie	 Retouched copies	 Other scenes

In full-frame playback mode, just as with the normal playback mode, thumbnail playback mode and calendar playback mode can be displayed, picture displays can be enlarged, pictures can be edited, and movies can be played back.

By pressing the **MENU** button to display the “Auto Sort Menu” ( 66), you can delete all pictures in the same folder, view a slide show of pictures in the same folder, and set print set or protect for all pictures in the same folder.

## Displaying Pictures in the Auto Sort Mode

- 1 Display the playback-mode selection menu by pressing the  button in playback mode, use the rotary multi selector to select , and then press the  button.

- The auto sort folder list screen appears.



- 2 Select the category.



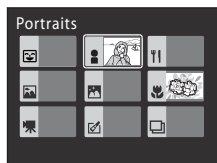



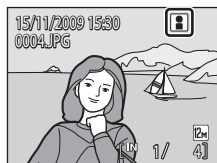



- See “Types of Folders and their Content” ( 65) for more information about auto sort categories.



- Pictures in the selected folder will be displayed in full-frame playback.
- The icon of the folder being played back currently will be displayed in the top right of the screen.



## Types of Folders and their Content

Categories	Description
 Smile	Pictures taken in smart portrait mode (📖 51) while smile timer was set to <b>On</b> .
 Portraits	Pictures taken in  (auto) mode (📖 24) using face priority (📖 106). Pictures taken in <b>Portrait*</b> , <b>Night portrait*</b> , <b>Party/indoor</b> , and <b>Backlight*</b> scene modes (📖 37). Pictures taken in smart portrait mode (📖 52) while smile timer was set to <b>Off</b> .
 Landscape	Pictures taken using the <b>Landscape*</b> scene mode (📖 37).
 Dusk to dawn	Pictures taken using the <b>Night landscape*</b> , <b>Sunset</b> , <b>Dusk/dawn</b> , and <b>Fireworks show</b> scene modes (📖 37).
 Close-ups	Pictures taken in  (auto) mode using macro (📖 35). Pictures taken using the <b>Close-up*</b> scene mode (📖 37).
 Food	Pictures taken using the <b>Food</b> (📖 47) scene mode (📖 37).
 Movie	Movies recorded using the movie mode (📖 76).
 Retouched copies	Edited pictures (📖 69).
 Other scenes	All pictures that are not included in the other folders.











\* The pictures taken using **Scene auto selector** (📖 38) are included.

### Notes when using the Auto Sort Mode

- Up to 999 images can be added per folder in the auto sort mode. A newly shot picture/movie whose folder already contains 999 images cannot be registered nor displayed in the auto sort mode. Display the picture/movie using the normal playback mode (📖 30) or the list by date mode (📖 61).
- Pictures or movies copied from the internal memory or the memory card (📖 115) cannot be displayed in the auto sort mode.
- Pictures or movies recorded by a camera other than the COOLPIX S640 cannot be displayed in the auto sort mode.









## Auto Sort Mode

The following operations are possible from the auto sort folder list screen.

To	Use	Description	
Select the folder		Rotate the rotary multi selector, or press ▲, ▼, ◀ or ▶ to select the folder.	10
Switch to full-frame playback		Press the OK button to display the first picture in the selected folder.	31
Deleting pictures		Press the  button after selecting pictures from the folder, and a confirmation dialog will be displayed. Choose <b>Yes</b> and press the OK button to delete all pictures from the folder.	30
Change playback mode		Press the  button to display the playback-mode selection menu.	9
Switch to shooting mode		Press the  button or the shutter-release button.	30
			

## Auto Sort Menu

Operate the following menus by pressing the MENU button in the full-frame playback of auto sort mode or in thumbnail display.

Quick retouch	→  71	Delete	→  113
D-Lighting	→  72	Protect	→  113
Skin softening	→  73	Rotate image	→  114
Print set	→  92	Small picture	→  74
Slide show	→  112	Voice memo	→  67

# Voice Memos: Recording and Playback

Use the camera's built-in microphone to record voice memos for pictures.

## Recording Voice Memos

- 1 Choose the desired picture from full-frame playback (📖 30) or thumbnail playback (📖 57) and press the **MENU** button.

- The playback menu is displayed.

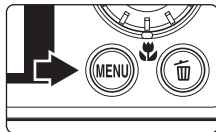

- 2 Use the rotary multi selector to choose **Voice memo** and press the **OK** button.

- The screen for recording a voice memo will be displayed.

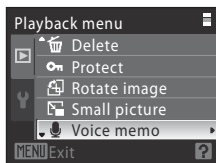

- 3 Press and hold the **OK** button to record voice memo.

- Recording ends after 20 seconds or when the **OK** button is released.
- Do not touch the built-in microphone during recording.
- During recording, **REC** and  blink in the monitor.
- When recording ends, the voice memo playback screen is displayed. Follow step 3 of "Playing Voice Memos" (📖 68) to playback the voice memo.
- Press the **MENU** button before or after recording a voice memo to return to full-frame playback.

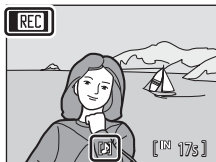



## More Information

See "File and Folder Names" (📖 139) for more information.

## Playing Voice Memos

Pictures for which voice memos have been recorded are indicated with  in full-frame playback mode.

- 1 Choose the desired picture from full-frame playback ( 30) or thumbnail playback ( 57) and press the **MENU** button.

- The playback menu is displayed.



- 2 Use the rotary multi selector to choose  **Voice memo** and press the **OK** button.

- The screen for playing a voice memo will be displayed.

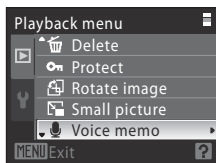



- 3 Press the **OK** button to play voice memo.

- Playback ends when the voice memo ends or the **OK** button is pressed again.
- Use the zoom control **T** or **W** during playback to adjust the volume.
- Press the **MENU** button before or after playing a voice memo to return to full-frame playback.



## Deleting Voice Memos

Choose a picture with a voice memo and press the  button. Use the rotary multi selector to choose  and press the **OK** button. Only the voice memo will be deleted.



### Notes on Voice Memos

- When a picture with a voice memo attached is deleted, both the picture and its voice memo are deleted.
- Voice memos cannot be recorded for a picture that already has a voice memo attached on it. The current voice memo must be deleted before a new voice memo can be recorded.
- Voice memos cannot be attached to images shot using cameras other than the COOLPIX S640.



## Editing Pictures

Use the COOLPIX S640 to edit pictures in-camera and store them as separate files (📖 139).

Editing function	Description
Quick retouch (📖 71)	Easily create a copy with enhanced contrast and richer colors.
D-Lighting (📖 72)	Create a copy of the current picture with enhanced brightness and contrast, brightening dark portions of the picture.
Skin softening (📖 73)	Makes the subject's skin appear smoother.
Small picture (📖 74)	Create a small copy of pictures suitable for use on web pages or as e-mail attachments.
Crop (📖 75)	Crop picture. Enlarge the image or refine the composition and create a copy containing only the portion visible in the monitor.

### Notes on In-camera Editing

- Pictures taken at an **Image mode** (📖 96) setting of **16:9 (3968)** cannot be edited.
- The COOLPIX S640 cannot be used to edit images shot using cameras other than the COOLPIX S640.
- If no faces can be detected in the image, the image cannot be edited with skin softening (📖 73).
- If a copy created using the COOLPIX S640 is viewed on a camera other than the COOLPIX S640, the picture may not be displayed or may not be transferred to a computer.
- Editing functions are not available when there is not enough free space in the internal memory or on the memory card.

### Restrictions on Picture Editing

The following limitations apply when editing pictures that were created by editing.

Copies Created By:	Can Be Edited By:
Quick retouch D-Lighting	Skin softening, small picture, or crop can be used. Quick retouch and D-Lighting cannot be used together.
Skin softening	Quick retouch, D-Lighting, small picture, or crop can be used.
Small picture Crop	No additional editing functions can be used.

- Copies created by editing cannot be edited again using the same edit function.
- To use an editing function together with small picture or crop, use the other edit function first, and use small picture or crop as the last edit function performed on that picture.
- Pictures that were taken using skin softening can be edited using skin softening.



### Original Pictures and Edited Copies

- Copies created with editing functions are not deleted if the original pictures are deleted. The original pictures are not deleted if copies created with editing functions are deleted.
- Edited copies are stored with the same recording date and time as the original.
- Even if the pictures that are marked for print set (📖 92) or protect (📖 113) are used for editing, these settings will not be reflected on the edited copies.

## Enhancing Contrast and Saturation: Quick Retouch

Easily create retouched images in which contrast and saturation have been enhanced. Retouched copies are stored as separate files.

- 1 Choose the desired picture from full-frame (📖 30) or thumbnail (📖 57) playback mode and press the **MENU** button.

- The playback menu is displayed.

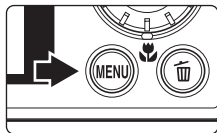

- 2 Use the rotary multi selector to choose **Quick retouch** and press the **OK** button.

- The original version will be shown on the left and the edited version will be shown on the right.

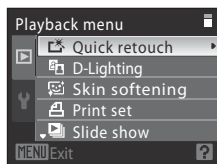

- 3 Choose the extent of the setting using **▲** or **▼** of the rotary multi selector, and press the **OK** button.

- A retouched copy is created.
- To cancel, press the **MENU** button.
- Quick retouched copies can be recognized by the  icon displayed during playback.



### More Information

See "File and Folder Names" (📖 139) for more information.

## Enhancing Brightness and Contrast: D-Lighting

D-Lighting can be used to create copies with enhanced brightness and contrast, brightening dark portions of a picture. Enhanced copies are stored as separate files.

- 1 Choose the desired picture from full-frame (📖 30) or thumbnail (📖 57) playback mode and press the **MENU** button.

- The playback menu is displayed.

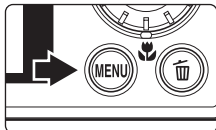

- 2 Use the rotary multi selector to choose **D-Lighting** and press the **OK** button.

- The original version will be shown on the left and the edited version will be shown on the right.

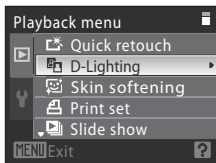

- 3 Choose **OK** and press the **OK** button.

- A new copy with enhanced brightness and contrast is created.
- To cancel, choose **Cancel** and press the **OK** button.
- D-Lighting copies can be recognized by the **D-Lighting** icon displayed during playback.

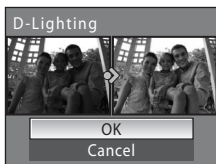

### More Information

See "File and Folder Names" (📖 139) for more information.

## Making Skin Appear Smoother: Skin Softening

Skin softening can be applied to faces that are detected in pictures already taken, to make skin appear smoother. Pictures edited with this function are stored as separate files.

- 1 Choose the desired picture from full-frame (📖 30) or thumbnail (📖 57) playback mode and press the **MENU** button.

- The playback menu is displayed.

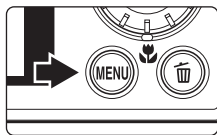

- 2 Use the rotary multi selector to choose  **Skin softening** and press the **OK** button.

- The screen that allows you to set the amount of skin softening appears.
- If no faces can be detected in the image, a warning is displayed and the screen returns to the playback menu.

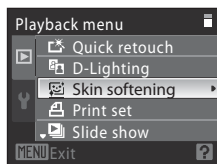

- 3 Press **▲** or **▼** to choose the amount of skin softening to be applied, and press the **OK** button.

- A confirmation screen is displayed, and the image is displayed zoomed in on the face edited by skin softening.

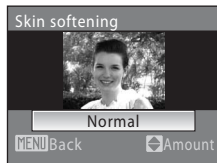

- 4 Confirm the results.

- Up to 12 faces, in order of proximity to the center of the frame, can be enhanced.
- When multiple faces are edited using skin softening, use the rotary multi selector **◀** and **▶** to switch the face that is displayed.
- To adjust the amount of skin softening, press the **MENU** button and return to step 3.
- Press the **OK** button to create a copy edited with skin softening.
- Copies created by editing with skin softening can be recognized by the  icon displayed during playback.

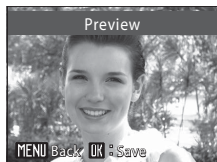



### Notes on Skin Softening

Depending on conditions such as the direction the subject is facing or the brightness of the face, the face may not be detected properly, or the desired effect may not be achieved.

## Resizing Pictures: Small Picture

Create a small copy of the current picture. Small copies are stored as separate files with a compression ratio of 1:16. The following sizes are available.

Option	Description
 640×480	Suitable for television playback.
 320×240	Suitable for displaying on web pages.
 160×120	Suitable for e-mail attachments.

- 1 Choose the desired picture from full-frame (📖 30) or thumbnail (📖 57) playback mode and press the **MENU** button.

- The playback menu is displayed.

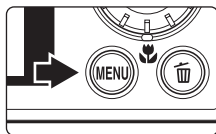

- 2 Use the rotary multi selector to choose  **Small picture** and press the **OK** button.

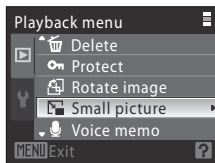

- 3 Choose the desired copy size and press the **OK** button.

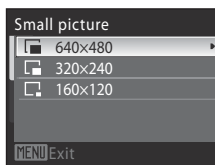

- 4 Choose **Yes** and press the **OK** button.

- A new, smaller copy is created.
- To cancel, choose **No** and press the **OK** button.
- Images created using small picture are displayed with a gray border.

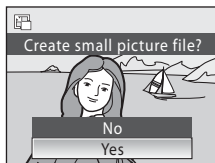

### More Information

See "File and Folder Names" (📖 139) for more information.

## Creating a Cropped Copy: Crop





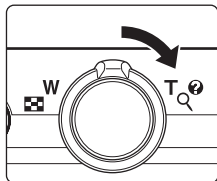

Create a copy containing only the portion visible in the monitor when **MENU**  is displayed with playback zoom ( 60) enabled. Cropped copies are stored as separate files.

### 1 Enlarge the desired picture during full-frame display ( 30) by rotating the zoom control to the **T** () direction.

- To crop a picture displayed in “tall” (portrait) orientation, zoom in on the picture until the black bars displayed on the both sides of the monitor disappear. The cropped picture will be displayed in landscape orientation. To crop the picture in its current “tall” (portrait) orientation, first, use the **Rotate image** option ( 114) to rotate the picture so that it is displayed in landscape orientation. Next, enlarge the picture for cropping, crop the picture, and then rotate the cropped picture back to “tall” (portrait) orientation.



### 2 Refine copy composition.

- Rotate the zoom control to **T** () or **W** () to adjust the zoom ratio.
- Press the rotary multi selector , ,  or  to move the display area to other areas of the picture.



### 3 Press the **MENU** button.

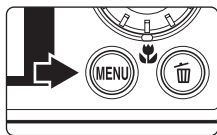



### 4 Use the rotary multi selector to choose **Yes** and press the **OK** button.

- A new picture, containing only the portion visible in the monitor, is created.
- To cancel, choose **No** and press the **OK** button.



#### Image Size



As the area to be saved is reduced, the image size (pixels) of the cropped copy is also reduced. When the size of the cropped copy is 320 × 240 or 160 × 120, the copy is displayed with a gray border during playback, and the small picture icon  or  is displayed on the left of the screen in full-frame playback mode.

#### More Information

See “File and Folder Names” ( 139) for more information.

## Recording Movies

To shoot movies with sound recorded via the built-in microphone, select shooting mode and follow the steps below.

- 1** Display the shooting-mode selection menu by pressing the  button in shooting mode, use the rotary multi selector to select , and then press the .

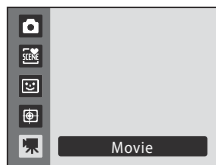



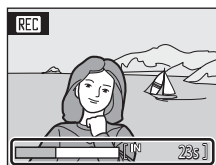

- The amount of available recording time is shown in the monitor ( 77). Regardless of the remaining memory on the memory card, the maximum size of a single movie is 2 GB, and the maximum length of a single movie is 25 minutes.

- 2** Press the shutter-release button all the way down to start recording.

- Camera focuses on the subject in center of the frame.
- A progress bar at the bottom of the monitor shows the amount of recording time remaining.
- To end recording, press the shutter-release button all the way down again.
- Recording stops automatically when the available recording time runs out.



### Shooting Movies

- Macro mode ( 35) is enabled. Flash ( 32), self-timer ( 34), and exposure compensation ( 36) are disabled.
- Macro mode settings cannot be applied or changed while movies are being recorded. Apply or change settings as necessary before movie recording begins.
- Optical zoom cannot be adjusted once movie recording begins. Digital zoom cannot be applied before movie recording begins, but up to 2x digital zoom can be applied while movies are being recorded.

### Note on Recording Movies

When the movie has been fully recorded to the internal memory or memory card, the monitor display will revert to the normal shooting mode display. **Do not open the battery-chamber/memory card slot cover while movies are being recorded.** Turning the camera off or removing the memory card while movies are being recorded could result in loss of data or in damage to the camera or card.

### Changing Movie Settings

**Movie options** and **Autofocus mode** settings can be changed in the movie menu ( 77).





# The Movie Menu

**Movie options** and **Autofocus mode** (📖 77) settings can be changed in the movie menu. Press the **MENU** button in movie mode to display the movie menu and use the rotary multi selector to modify and apply settings.



## 🔊 Selecting Movie Options

Set to 🔊 (Movie) → MENU (Movie menu) → 🔊 Movie options

The movie menu offers the options shown below.

Option	Image size and frame rate
 TV movie 640 (default setting)	Image size: 640 × 480 pixels Frame rate: 30 frames per second
 Small size 320	Image size: 320 × 240 pixels Frame rate: 30 frames per second

## 📝 Maximum Movie Length

Option	Internal memory (approx. 45 MB)	Memory card (512 MB)
 TV movie 640 (default setting)	32 s	Approx. 5 min 30 s
 Small size 320	1 min 22 s	Approx. 14 min 20 s

\* All figures are approximate. The maximum recording time may vary with make of memory card. Regardless of the remaining memory on the memory card, the maximum size of a single movie is 2 GB, and the maximum length of a single movie is 25 minutes. The amount of available recording time is shown in the monitor while recording.



## 💡 More Information

See “File and Folder Names” (📖 139) for more information.

## 🎥 Autofocus Mode

Set to 🔊 (Movie) → MENU (Movie menu) → 🎥 Autofocus mode

Choose how the camera focuses in movie mode.

Option	Description
 Single AF (default setting)	Focus is locked when the shutter-release button is pressed.
 Full-time AF	Camera focuses continuously. To prevent sound of camera focusing from interfering with recording, use of <b>Single AF</b> is recommended.

## Movie Playback

In full-frame playback mode (📖 30), movies are recognized by the movie options (📖 77) icons. To play a movie, display it in full-frame playback mode and press the **OK** button.

Use the zoom control **T** or **W** during playback to adjust the volume.

Rotating the rotary multi selector enables fast-forwarding/rewinding.

Playback controls appear at the top of the monitor. Press the rotary multi selector ◀ or ▶ to choose a control, then press the **OK** button to perform the selected operation. The following operations are available.

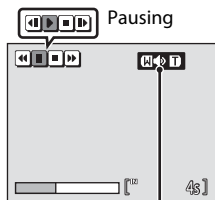

During playback

Volume indicator

To	Select	Description
Rewind	⏮	Rewind the movie when the <b>OK</b> button is pressed down.
Advance	⏭	Advance the movie when the <b>OK</b> button is pressed down.
Pause	⏸	Press the <b>OK</b> button to pause playback. The following operations can be performed while playback is paused.
		⏮ Press the <b>OK</b> button to rewind the movie by one frame. Rewind continues while the button is pressed. *
		⏭ Press the <b>OK</b> button to advance the movie by one frame. Advance continues while the button is pressed. *
	▶	Press the <b>OK</b> button to resume playback.
End	⏹	Press the <b>OK</b> button to return to full-frame playback mode.

\* The rotary multi selector can also be rotated to advance or rewind the movie frame by frame.

## Deleting Movie Files

Press the **🗑** button when displayed in full-frame playback mode (📖 30) or when selected in thumbnail (📖 57) playback mode.

A confirmation dialog is displayed. Select **Yes** and press the **OK** button to delete the movie, or select **No** to exit without deleting the movie.

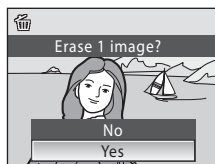

## Connecting to a TV

Connect the camera to a television using the supplied audio/video cable to play back pictures on the television.

### 1 Turn off the camera.

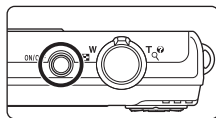

### 2 Connect the camera to the TV using the supplied audio/video cable.

- Connect the yellow plug to the video-in jack on the TV, and the white plug to the audio-in jack.

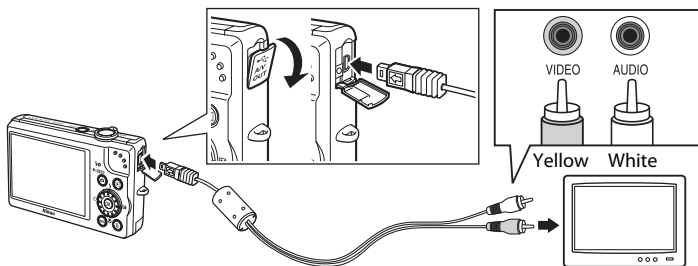

### 3 Tune the television to the video channel.

- See the documentation provided with your television for details.

### 4 Hold down the button to turn on the camera.

- The camera enters playback mode, and pictures recorded to the internal memory, or memory card, will be displayed on the television.
- While connected to the TV, the camera monitor will remain off.

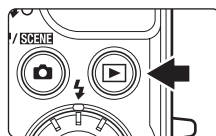

### Connecting the Audio/Video Cable

When connecting the audio/video cable, be sure that the connectors are oriented correctly. Do not use force when connecting the audio/video cable. When disconnecting the audio/video cable, do not pull the connector at an angle.

### When Nothing Appears on the TV

Be sure that the camera's video mode setting in the **Setup menu** (📖 116) → **Video mode** (📖 130) conforms to the standard used by your television.

## Connecting to a Computer

Use the supplied USB cable to connect the camera to a computer, and copy (transfer) pictures to a computer with the supplied Nikon Transfer software.

### Before Connecting the Camera

#### Install the Software

Before connecting the camera to a computer, software, including Nikon Transfer, ViewNX for viewing transferred pictures, and Panorama Maker for creating panorama images, must be installed from the supplied Software Suite CD.

For more information on installing the software, refer to the *Quick Start Guide*.

#### Compatible Operating Systems

##### Windows

Preinstalled versions of Windows Vista Service Pack 1 (32-bit Home Basic/Home Premium/Business/Enterprise/Ultimate editions),

Windows XP Service Pack 3 (Home Edition/Professional)

##### Macintosh

Mac OS X (version 10.3.9, 10.4.11, 10.5.6)

Refer to the Nikon website for the latest information on operating system compatibility.

#### Note on Computer Connection

Disconnect other USB devices such as commercial USB chargers from the computer. Simultaneous connection of the camera and other USB devices to the computer could result in operation malfunction or excessive supply of power to the camera, causing damage to the camera or memory card. Refer to the documentation supplied with other USB devices for more information.

#### Notes on Power Source

- When connecting the camera to a computer to transfer pictures, use a fully charged battery to prevent the camera from turning off unexpectedly.
- When the camera is connected to a computer via the supplied USB cable with **Auto** (default setting) selected for the **Charge by computer** option (□ 84, 131) in the setup menu, the battery inserted into the camera is automatically charged using power supplied by the computer. Pictures can be transferred while the battery is charging.
- If the AC Adapter EH-62F is used, power can be supplied to the COOLPIX S640 from an electrical outlet. Do not, under any circumstances, use another make or model of AC adapter other than EH-62F. Failure to observe this precaution could result in overheating or in damage to the camera.

## Transferring Pictures from the Camera to a Computer

- 1 Start the computer to which Nikon Transfer was installed.
- 2 Be sure that the camera is off.
- 3 Connect the camera to the computer using the supplied USB cable.

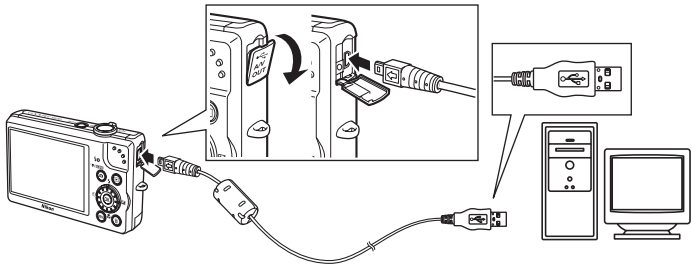

- 4 The camera automatically turns on.

The power-on lamp will light. The camera monitor will remain off.

### Windows Vista

When the AutoPlay dialog is displayed, click **Copy pictures to a folder on my computer using Nikon Transfer**. Nikon Transfer will start.

To bypass this dialog in the future, check **Always do this for this device**.

### Windows XP

When the action selection dialog is displayed, select **Nikon Transfer Copy pictures to a folder on my computer** and click **OK**. Nikon Transfer will start.

To bypass this dialog in the future, check **Always use this program for this action**.

### Mac OS X

Nikon Transfer will start automatically if **Yes** was selected in the Auto-Launch setting dialog when Nikon Transfer was first installed.

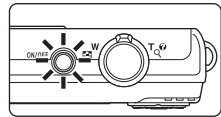

## ✓ Connecting the USB Cable

- Be sure that connectors are properly oriented. Do not attempt to insert connectors at an angle, and do not use force when connecting or disconnecting the USB cable.
- The connection may not be recognized if the camera is connected to the computer via a USB hub.

## 5 Confirm that the source device is displayed in the transfer options **Source** panel and click **Start Transfer**.

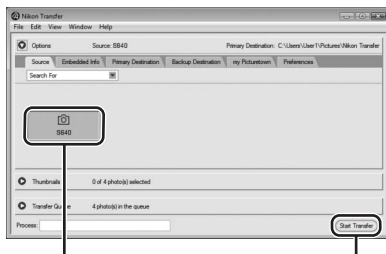

Source device

Start Transfer button

At the Nikon Transfer default settings, all pictures are transferred to the computer.

At the Nikon Transfer default settings, ViewNX starts automatically when transfer is complete and transferred pictures can be viewed.

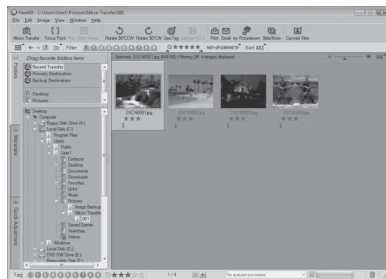

For more information on using Nikon Transfer or ViewNX, refer to help information contained in Nikon Transfer or ViewNX ( 83).

## Disconnecting the camera

Do not turn off the camera or disconnect the camera from the computer during transfer.

When transfer is complete, turn off the camera and disconnect the USB cable.

The camera turns off automatically if there is no communication with the computer for 30 minutes while the camera is connected via the USB cable.

## Charging the Battery

When the camera's charge lamp is blinking slowly in green, the battery inserted in the camera is charging ( 84).

## Using a Card Reader

The pictures stored on the memory card inserted into a card reader or similar device can also be transferred to the computer using Nikon Transfer.

- If the memory card has a capacity greater than 2 GB, or is SDHC-compliant, the intended device must support these features of the memory card.
- Insert a memory card into the card reader or similar device, and refer to the steps 4 and 5 to transfer pictures.
- To transfer pictures stored in the camera's internal memory to the computer, the pictures must first be copied to a memory card using the camera (📖 115).

## Starting Nikon Transfer or ViewNX Manually

### Windows

Choose **Start** menu>**All Programs**>**Nikon Transfer**>**Nikon Transfer** (or **All Programs**>**ViewNX**>**ViewNX**).

Double-clicking the Nikon Transfer or ViewNX shortcut icon on the desktop will also start Nikon Transfer or ViewNX.

### Macintosh

Open **Applications** and click **Nikon Software**>**Nikon Transfer**>**Nikon Transfer** (or **Nikon Software**>**ViewNX**>**ViewNX**).

Clicking the Nikon Transfer or ViewNX icon on the Dock will also start Nikon Transfer or ViewNX.

## Viewing Nikon Transfer and ViewNX Help Information

For more information on Nikon Transfer or ViewNX, start Nikon Transfer or ViewNX and select **Nikon Transfer Help** or **ViewNX Help** from the **Help** menu.

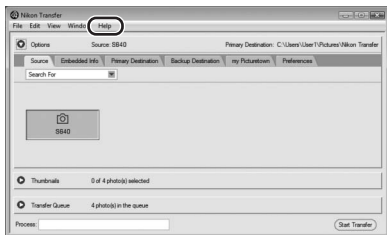

## Panorama Creation with Panorama Maker

- Use a series of pictures taken in **Panorama assist** scene mode (📖 49) to create a single panorama photo with Panorama Maker.
- Panorama Maker can be installed on a computer using the supplied Software Suite CD.
- After installation is complete, follow the procedure described below to start Panorama Maker.

### Windows

Choose **Start** menu>**All Programs**>**ArcSoft Panorama Maker 4**>**Panorama Maker 4**.

### Macintosh

Open **Applications** and double-click the **Panorama Maker 4** icon.

- For more information on using Panorama Maker, refer to the on-screen instructions and help information contained in Panorama Maker.

## Image File Names and Folder Names

See "File and Folder Names" (📖 139) for more information.

## Charging While Connecting to a Computer

When connecting the camera to a computer via the supplied USB cable while **Auto** (default setting) is selected for the **Charge by computer** option (📖 131) in the setup menu, the battery inserted into the camera is automatically charged using power supplied by the computer.

See “Before Connecting the Camera” (📖 80) and “Transferring Pictures from the Camera to a Computer” (📖 81) for more information on connecting the camera to a computer.

### Charge Lamp

The following chart explains charge lamp status when the camera is connected to a computer.

Charge lamp	Description
Slow blinking (green)	Battery charging.
Off	Not charging. If the charge lamp changes from slow blinking (green) to off while the power-on lamp is lit, charging is complete.
Fast blinking (green)	<ul style="list-style-type: none"> <li>Operating temperature range exceeded. Charge the battery indoors with an ambient temperature of 5°C to 35°C (41°F to 95°F) before use.</li> <li>A USB cable is not correctly connected or the battery is faulty. Reconnect the USB cable correctly or replace the battery.</li> <li>Computer is in sleep mode and does not supply power. Reboot a computer.</li> <li>The battery cannot be charged as computer’s specifications or settings does not support power supply to the camera.</li> </ul>

### ✓ Notes on Charging with Connection to a Computer

- The battery cannot be charged, nor can data be transferred, when the camera is connected to a computer before the camera’s date and time have been set (📖 20). If the camera’s clock battery (📖 121) has been exhausted, the date and time must be reset before the battery can be charged or images can be transferred with connection to a computer. In this case, use the Charging AC Adapter EH-68P (📖 16) to charge the battery and then set the camera’s date and time.
- If the camera is turned off, charging will also stop.
- If a computer enters sleep mode while charging, charging will stop and the camera may be turned off.
- When disconnecting the camera from a computer, turn the camera off and then disconnect the USB cable.
- It may take longer to charge the battery with connection to a computer than with charging using the Charging AC Adapter. Charging time increases when images are transferred while the battery is charging.
- When the camera is connected to a computer, an application installed on the computer, such as Nikon Transfer, may start. If the camera was connected to the computer for the sole purpose of charging the battery, exit the application.
- The camera turns off automatically if there is no communication with the computer for 30 minutes after the battery has finished charging.
- Depending upon computer specifications, settings, and power supply and allocation, it may be impossible to charge the battery inserted into the camera via computer connection.



## Connecting to a Printer

Users of PictBridge-compatible (📖 157) printers can connect the camera directly to the printer and print pictures without using a computer. The steps for printing are as follows.

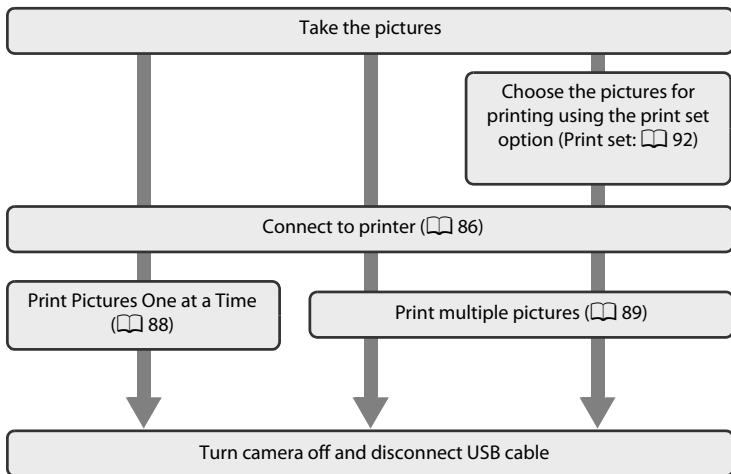

### ✓ Notes on Power Source

- When connecting the camera to a printer, use a fully charged battery to prevent the power from turning off unexpectedly.
- Use the optional AC Adapter EH-62F to charge the COOLPIX S640 using home electronic outlets. Do not, under any circumstances, use another make or model of AC adapter. Failure to observe this precaution could result in overheating or in damage to the camera.

### 📖 Printing Pictures

In addition to printing pictures transferred to a computer and printing over a direct camera-to-printer connection for images recorded in the memory card, the following options are also available for printing pictures:

- Insert a memory card into a DPOF-compatible printer's card slot.
- Take a memory card to a digital photo lab.

For printing using these methods, specify the pictures and the number of prints each using the **Print set** (📖 92) option in the playback menu.

## Connecting the Camera to a Printer

- 1 Turn off the camera.

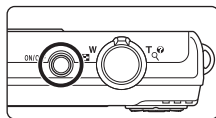

- 2 Turn on the printer.

- Check printer settings.

- 3 Connect the camera to the printer using the supplied USB cable.

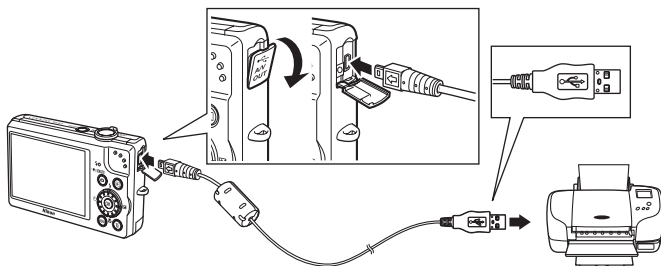

- 4 The camera automatically turns on.

- When connected correctly, the **PictBridge** startup screen (①) will be displayed in the camera monitor. Then the **Print selection** screen (②) will be displayed.

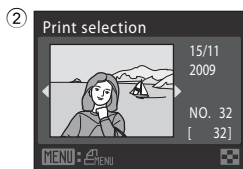
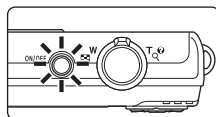

**✔ If the PictBridge Screen is not Displayed**

Turn off the camera and disconnect the USB cable. Set **Charge by computer** (📖 131) in the camera's setup menu to **Off**, then connect the camera again.

**✔ Connecting the USB Cable**

Be sure that connectors are properly oriented. Do not attempt to insert connectors at an angle, and do not use force when connecting or disconnecting the USB cable.

## Printing Pictures One at a Time

After connecting the camera to the printer correctly (📖 86), print pictures by following the procedure below.

- 1 Use the rotary multi selector to choose the picture to be printed and press the **OK** button.

- Rotate the zoom control to **W** (🖼️) to display 12 thumbnails, or to **T** (🔍) to switch back to full-frame playback.

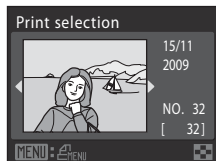

- 2 Choose **Copies** and press the **OK** button.

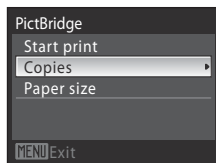

- 3 Choose the number of copies (up to nine) and press the **OK** button.



- 4 Choose **Paper size** and press the **OK** button.

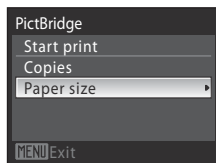

- 5 Choose the desired paper size and press the **OK** button.

- To specify paper size using printer settings, choose **Default** in the paper size menu.

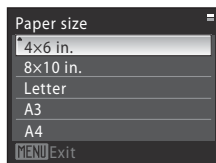

## 6 Choose **Start print** and press the **OK** button.

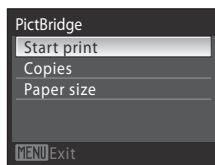

## 7 Printing starts.

- Monitor display returns to that shown in step 1 when printing is complete.
- To cancel before all copies have been printed, press the **OK** button.

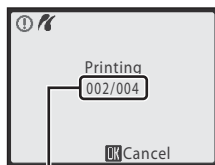

Current print/  
total number of prints

## Printing Multiple Pictures

After connecting the camera to the printer correctly (📖 86), print pictures by following the procedure below.

### 1 When the **Print selection** screen is displayed, press the **MENU** button.

- The **Print menu** is displayed.

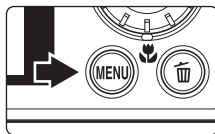

### 2 Use the rotary multi selector to choose **Paper size** and press the **OK** button.

- To exit the print menu, press the **MENU** button.

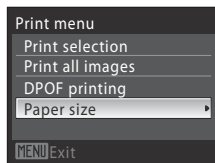

### 3 Choose the desired paper size and press the **OK** button.

- To specify paper size using printer settings, choose **Default** in the paper size menu.

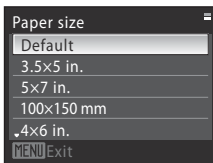

### 4 Choose **Print selection**, **Print all images** or **DPOF printing** and press the **OK** button.

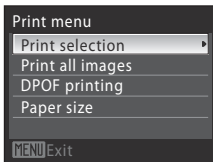

#### Print selection

Choose the pictures (up to a maximum of 99) and number of copies (up to nine per picture).

- Rotate the rotary multi selector, or press **◀** or **▶** to choose the pictures, and press **▲** or **▼** to set the number of copies for each.
- Pictures selected for printing can be recognized by the check mark icon and the numeral indicating the number of copies to be printed. A check mark is not displayed with pictures for which no copies have been specified and these pictures will not be printed.
- Rotate the zoom control to **T** (Q) to switch to full-frame playback, or **W** (R) to switch to 12 thumbnails display.
- Press the **OK** button when setting is complete.
- The menu shown at right will be displayed. To print, choose **Start print** and press the **OK** button. Choose **Cancel** and press the **OK** button to return to the print menu.

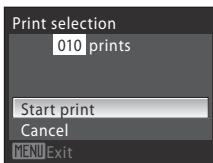
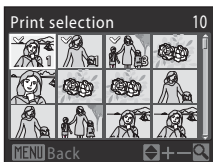

**Print all images**

All pictures stored in the internal memory, or on the memory card, are printed one at a time.

- The menu shown at right will be displayed. To print, choose **Start print** and press the **OK** button.
- Choose **Cancel** and press the **OK** button to return to the print menu.

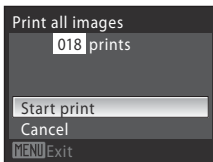
**DPOF printing**

Print the pictures in the print order that was created using **Print set** (📖 92).

- The menu shown at right will be displayed. To print, choose **Start print** and press the **OK** button.
- Choose **Cancel** and press the **OK** button to return to the print menu.

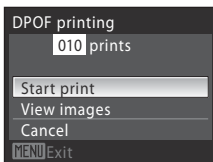

- To view the current print order, choose **View images** and press the **OK** button. To print pictures, press the **OK** button again.

**5 Printing starts.**

- Monitor display returns to that shown in step 2 when printing is complete.
- To cancel before all copies have been printed, press the **OK** button.

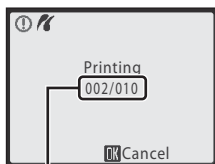

Current print/  
total number of prints

**📄 Paper Size**

The camera supports the following paper sizes: **Default** (the default paper size for the current printer), **3.5x5 in.**, **5x7 in.**, **100x150 mm**, **4x6 in.**, **8x10 in.**, **Letter**, **A3**, and **A4**. Only sizes supported by the current printer will be displayed.

## Creating a DPOF Print Order: Print Set

The Print set option in the playback menu is used to create digital “print orders” for printing on DPOF-compatible printers or in print shops (📖 157).

When the camera is connected to a PictBridge-compatible printer, pictures can be printed from the printer according to the DPOF print order you have created for pictures on the memory card. If the memory card is removed from the camera, you can create the DPOF print order for pictures in the internal memory and print pictures according to the DPOF print order.

### 1 Press the **MENU** button in playback mode.

- The playback menu is displayed.

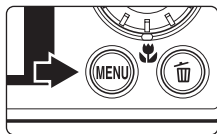

### 2 Use the rotary multi selector to choose **Print set** and press the **OK** button.

When viewing pictures by List by date or Auto sort mode  
→ step 4

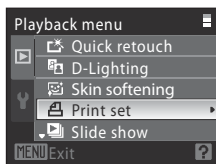

### 3 Choose **Select images** and press the **OK** button.

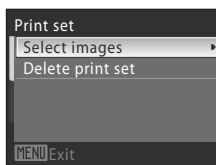

### 4 Choose the pictures (up to a maximum of 99) and number of copies (up to nine per picture).

- Rotate the rotary multi selector, or press ◀ or ▶ to choose the pictures, and press ▲ or ▼ to set the number of copies for each.
- Pictures selected for printing can be recognized by the check mark icon and the numeral indicating the number of copies to be printed. A check mark is not displayed with pictures for which no copies have been specified and these pictures will not be printed.
- Rotate the zoom control to **T** (📷) to switch to full-frame playback, or **W** (📺) to switch to 12 thumbnails display.
- Press the **OK** button when setting is complete.





## 5 Choose whether or not to also print shooting date and photo information.

- Choose **Date** and press the **OK** button to print the date of recording on all pictures in the print order.
- Choose **Info** and press the **OK** button to print shooting information (shutter speed and aperture) on all pictures in the print order.
- Choose **Done** and press the **OK** button to complete the print order.

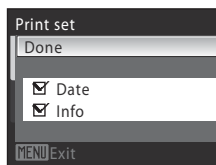

Pictures selected for printing are recognized by the  icon displayed with playback.

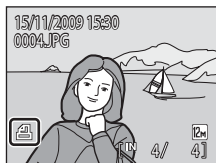

## Deleting All Print Orders

Choose **Delete print set** in step 3 and press the **OK** button. Print orders for all pictures will be deleted.

## Notes on the Print Set Option

When using Print set while viewing pictures by List by date or Auto sort mode, if pictures other than the selected date or type are already set for printing, the screen shown at right will be displayed.

- If **Yes** is selected, the current settings are added to the previous settings.
- If **No** is selected, the previous settings are deleted and only the current settings remain.

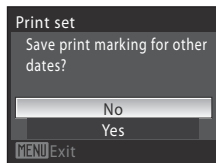

When using List by date

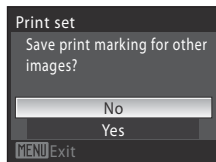

When using Auto sort mode

## Creating a DPOF Print Order: Print Set

If more than 99 pictures are selected as a result of adding the current settings, the screen shown at right will be displayed.

- If **Yes** is selected, the previous settings are deleted and only the current settings remain.
- If **Cancel** is selected, the current settings are deleted and only the previous settings remain.

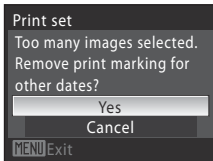

When using List by date

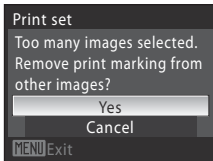

When using Auto sort mode

### Notes on Printing Shooting Date and Photo Information

When the **Date** and **Info** options are enabled in the Print set menu, shooting date and photo information are printed on pictures when a DPOF-compatible (📖 157) printer which supports printing of shooting date and photo information is used.

- Photo information cannot be printed when the camera is connected directly to a printer, via the supplied USB cable, for DPOF printing (📖 91).
- **Date** and **Info** are reset each time the **Print set** menu is displayed.
- The date and time printed on the picture is the date and time recorded on the camera when the picture was taken. The date and time printed using this option will not be affected even if the camera's **Date** setting is changed from the setup menu after the pictures are taken.



















### Date Imprint

The shooting date and time can be imprinted in pictures at the time of shooting by using **Date imprint** (📖 124) in the setup menu. This information can be printed even from printers that do not support printing of date and time.



Only the date and time of date imprint on the pictures will be printed, even if **Print set** is enabled with the date selected in the print set screen.

## Shooting Options: The Shooting Menu

While shooting in  (auto) mode ( 24), the shooting menu contains the following options.

	<b>Image mode</b>	 96
	Choose the image mode (a combination of the image size and image quality (compression)) to be used when recording. Also available when using other shooting modes (except movie mode).	
	<b>White balance</b>	 98
	Match white balance to the light source.	
	<b>Metering</b>	 100
	Choose how the camera meters exposure.	
	<b>Continuous</b>	 101
	Change settings for Continuous and BSS (Best Shot Selector).	
<b>ISO</b>	<b>ISO sensitivity</b>	 102
	Control the camera's sensitivity to light.	
	<b>Color options</b>	 103
	Apply color effects to pictures as they are recorded.	
	<b>AF area mode</b>	 104
	Choose how the focus area is determined.	
	<b>Autofocus mode</b>	 108
	Choose how the camera focuses.	

### Displaying the Shooting Menu

Set the camera to  (auto) mode ( 24).

Press the **MENU** button to display the shooting menu.

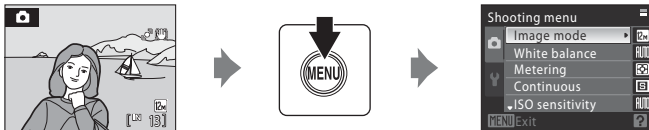

- Use the rotary multi selector to choose and apply settings ( 10).
- Press the **MENU** button to exit the shooting menu.

### Functions that Cannot be Applied Simultaneously









Some functions cannot be enabled in conjunction with others ( 109).

## Image Mode

Set to  (Auto) → MENU (Shooting menu) →  Image mode

Choose an image mode, which is the combination of image size and image quality (compression), according to how you plan to use the picture and the capacity of the internal memory or memory card.

The larger the image, the larger the size at which it can be printed or displayed without becoming noticeably “grainy”, limiting the number of pictures that can be recorded.

Image mode	Image size (pixels)	Description
 High (4000★)	4,000×3,000	Highest quality, suitable for enlargements or high-quality prints. The compression ratio is approximately 1:4.
 Normal (4000) (default setting)	4,000×3,000	The best choice in most situations. The compression ratio is approximately 1:8.
 Normal (3264)	3,264×2,448	
 Normal (2592)	2,592×1,944	
 Normal (2048)	2,048×1,536	Smaller size allows more pictures to be stored. The compression ratio is approximately 1:8.
 PC screen (1024)	1,024×768	Suited to display on computer monitor. The compression ratio is approximately 1:8.
 TV screen (640)	640×480	Suited to full-screen display on a television or distribution by e-mail or the web. The compression ratio is approximately 1:8.
 16:9 (3968)	3,968×2,232	Pictures with an aspect ratio of 16:9 can be taken. The compression ratio is approximately 1:8.









The icon for the current setting is displayed in the monitor in shooting and playback modes ( 6, 7).

### Image Mode

- Changes made to the image mode setting apply to all shooting modes (except those available from the movie mode).
- This feature cannot be used simultaneously with certain features. → “Functions that Cannot be Applied Simultaneously” ( 109)

## Number of Exposures Remaining



The following table lists the approximate number of pictures that can be stored in internal memory and on a 512 MB memory card. Note that the number of images that can be stored will differ depending on the composition of the image (due to JPEG compression). In addition, this number may differ depending on the make of memory card, even if the capacity for the memory card is the same.

Setting	Internal memory (approx. 45 MB)	Memory card <sup>1</sup> (512 MB)	Print size <sup>2</sup> (cm/in.)
 High (4000 ★)	7	Approx. 80	34 × 25/13 × 10
 Normal (4000)	13	Approx. 150	34 × 25/13 × 10
 Normal (3264)	19	Approx. 220	28 × 21/11 × 8
 Normal (2592)	31	Approx. 340	22 × 16/8.5 × 6.5
 Normal (2048)	49	Approx. 550	17 × 13/7 × 5
 PC screen (1024)	159	Approx. 1,700	9 × 7/3.5 × 2.5
 TV screen (640)	319	Approx. 3,400	5 × 4/2 × 1.5
 16:9 (3968)	18	Approx. 200	34 × 19/13 × 7.5

- 1 If the number of exposures remaining is 10,000 or more, the number of exposures remaining display shows "9999".
- 2 Print size at an output resolution of 300 dpi.

Print sizes are calculated by dividing the number of pixels by printer resolution (dpi) and multiplying by 2.54 cm (1 in.). However, even with the same image size setting, images printed at higher resolutions will print smaller than the size indicated, and those printed at lower resolutions will print larger than the size indicated.

## WB White Balance

Set to  (Auto) → MENU (Shooting menu) →  White balance

The human brain is able to adapt to changes in the color of the light source, with the result that white objects appear white whether seen in the shade, direct sunlight, or under incandescent lighting. Digital cameras can mimic this adjustment of the human eye by processing images according to the color of the light source. This is known as “white balance”. For natural coloration, choose a white balance setting that matches the light source before shooting.

Although the default setting, **Auto**, can be used under most types of lighting, you can apply the white balance setting suited to a particular light source to achieve more accurate results.

### Auto (default setting)

White balance automatically adjusted to suit lighting conditions. Best choice in most situations. Can be used in most situations.

### Preset manual

Neutral-colored object used as reference to set white balance under unusual lighting conditions, see “Preset Manual” ( 99) for details.

### Daylight

White balance adjusted for direct sunlight.

### Incandescent

Use under incandescent lighting.

### Fluorescent

Use under most types of fluorescent lighting.

### Cloudy

Use when shooting under overcast skies.

### Flash

Use with the flash.

The effects of the selected option can be previewed in the monitor. At settings other than **Auto**, the icon for the current setting is displayed in the monitor ( 6).

### White Balance

This feature cannot be used simultaneously with certain features. → “Functions that Cannot be Applied Simultaneously” ( 109)

### Flash Mode

At white balance settings other than **Auto** or **Flash**, turn the flash off (  32).

## Preset Manual

Preset manual is used with mixed lighting or to compensate for light sources with a strong color cast when the desired effect has not been achieved with white balance settings like **Auto** and **Incandescent** (for example, to make images shot under a lamp with a red shade look as though they had been shot under white light).

**1** Place a white or gray reference object under the lighting that will be used during shooting.

**2** Display the shooting menu (📖 95), use the rotary multi selector to set **White balance** to **PRE Preset manual**, then press the **OK** button.

- The camera zooms in.

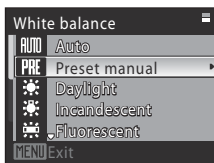

**3** Choose **Measure**.

- To use the most recently measured value for preset manual, choose **Cancel** and press the **OK** button. The most recently measured value will be set for White Balance.

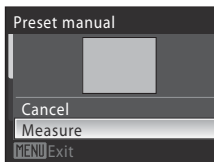

**4** Frame the reference object.

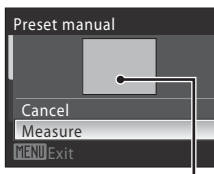

Reference object frame



**5** Press the **OK** button to measure the white balance value.

The shutter is released and the new white balance value is set (no picture is recorded).

### Note on Preset Manual

The camera cannot measure a white balance value for when the flash fires. When shooting with the flash, set **White balance** to **Auto** or **Flash**.

## Metering

Set to  (Auto) → MENU (Shooting menu) →  Metering

The process of measuring the brightness of the subject to determine the exposure is known as Metering.

Choose how the camera meters exposure.

### Matrix (default setting)

Camera sets exposure for entire frame. Recommended in most situations.

### Center-weighted

Camera meters entire frame but assigns greatest weight to subject in center of frame. Classic meter for portraits; preserves background details while letting lighting conditions at center of frame determine exposure. Can be used with focus lock ( 105) to meter off-center subjects.

## Note on Metering

When using digital zoom, **Metering** is set to **Center-weighted**, and the metered area is not displayed in the monitor.

## Metering Area

The active metering area is displayed in the monitor when **Center-weighted** is selected for **Metering**.

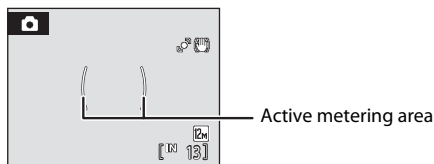



## Continuous

Set to  (Auto) → MENU (Shooting menu) →  Continuous

Change settings for Continuous and BSS (Best Shot Selector).

Flash will be switched off when **Continuous**, **BSS**, or **Multi-shot 16** is selected. Focus, exposure, and white balance are fixed at the values for the first image in each series.

### Single (default setting)

One image is shot each time the shutter-release button is pressed.

### Continuous

While the shutter-release button is held down, the camera shoots up to 10 pictures at a rate of up to about 0.8 frames per second (fps) (when image mode is set to  **Normal (4000)**). Shooting ends when the shutter-release button is released, or ten shots have been taken with the shutter-release button held down.

### BSS (Best shot selector)

BSS is recommended for shooting under low lighting without the flash, with the camera zoomed in, or in other situations in which camera shake is likely to blur pictures. The camera takes up to ten images while the shutter-release button is held down. The sharpest image (image with the most detail) in the series is automatically selected and saved.

### Multi-shot 16

Each time the shutter-release button is pressed all the way down, 16 pictures are shot at about 30 fps and the camera arranges them in a single picture.

- Images are captured with the image mode locked at  **2592**.
- Digital zoom is not available.

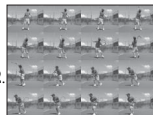

At settings other than **Single**, the indicator for the current setting is displayed in the monitor ( 6).

### Note on Continuous Shooting

- The maximum frame rate with continuous shooting may vary, depending upon the current image mode and the type of memory card used.
- This feature cannot be used simultaneously with certain features. → “Functions that Cannot be Applied Simultaneously” ( 109)

### Note on Best Shot Selector

**BSS** is best suited for shooting stationary subjects. It may not produce the desired results if the subject moves or the composition changes while the shutter-release button is pressed all the way down.

### ✔ Note on Multi-shot 16

Smear (📖 143) visible in the monitor when shooting with **Multi-shot 16** enabled will be recorded with images. Avoiding bright objects such as the sun, reflections of the sun, and electric lights when shooting with **Multi-shot 16** enabled is recommended.

## ISO ISO Sensitivity

Set to 📷 (Auto) → MENU (Shooting menu) → ISO ISO sensitivity

Sensitivity is a measure of how quickly the camera reacts to light. The higher the sensitivity, the less light needed to make an exposure. Although a high ISO rating is suited for taking pictures of subjects in action or in poor lighting, high sensitivity is often associated with “noise” -randomly spaced, brightly colored pixels concentrated in dark parts of the image.

### Auto (default setting)

Sensitivity is ISO 100 in bright places; in dark places the camera automatically raises sensitivity to a maximum of ISO 1600.

### Fixed range auto

Choose the range in which the camera automatically adjusts ISO sensitivity, from **ISO 100-400** or **ISO 100-800**. The camera will not raise sensitivity beyond the maximum value in the selected range. Set the maximum value for ISO sensitivity for effective control over the amount of “grain” that appears in images.

100, 200, 400, 800, 1600, 3200, 6400

ISO Sensitivity will be locked at the specified value.

If ISO sensitivity is locked, **Motion detection** (📖 126) will not function.



At settings other than Auto, the current setting is displayed in the monitor (📖 6).

If **Auto** is selected and the sensitivity is raised above an ISO 100, the **ISO** icon will be displayed (📖 33). If **Fixed range auto** is selected, **ISO** + the maximum value for ISO sensitivity will be displayed.

### ✔ Notes on ISO Sensitivity

This feature cannot be used simultaneously with certain features. → “Functions that Cannot be Applied Simultaneously” (📖 109)

## Color Options

Set to  (Auto) → MENU (Shooting menu) →  Color options

Make colors more vivid or record pictures in monochrome.

 **Standard color (default setting)**  
Use for pictures exhibiting natural color.

 **Vivid color**  
Use to achieve a vivid, “photoprint” effect.

 **Black-and-white**  
Record pictures in black-and-white.

 **Sepia**  
Record pictures in sepia tones.

 **Cyanotype**  
Record pictures in cyan-blue monochrome.

At settings other than **Standard color**, the icon for the current setting is displayed in the monitor ( 6). Monitor color tones also change depending upon the setting.

### Notes on Color Options

This feature cannot be used simultaneously with certain features. → “Functions that Cannot be Applied Simultaneously” ( 109)

## [+] AF-Area Mode

Set to (Auto) → MENU (Shooting menu) → [+]  
AF area mode

Choose how the focus area is determined.

When using digital zoom, the camera will focus on the subject in the center focus area regardless of the applied **AF area mode** option.

### Face priority

If the camera detects a face, it focuses on the face ("Shooting with Face Priority" → 106). If the camera detects multiple faces, the camera focuses on the face closest to the camera. When shooting non-human subjects or when framing the subject in such a way that a face cannot be detected, the AF area mode becomes **Auto**, and the camera automatically selects the focus area (up to nine areas) containing the subject closest to the camera.

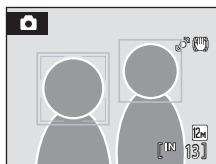

### Auto (default setting)

Camera automatically selects the focus area (one of nine) containing the subject closest to the camera. Press the shutter-release button halfway to activate the focus area. When the shutter-release button is pressed halfway, the focus area selected by the camera will be displayed in the monitor (up to nine areas).

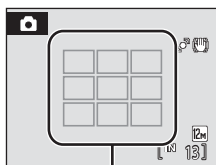

Focus areas

### [+] Manual

Choose the focus area from 99 areas in the screen. This option is suited to situations in which the intended subject is relatively still and not positioned in the center of the frame. Rotate the rotary multi selector or press , , or to select one of 99 focus areas displayed in the monitor's focus-area selection screen, and shoot. To end focus-area selection and adjust the flash mode, macro mode, self-timer and exposure compensation settings, press the button. To return to the focus-area selection screen, press the button again.

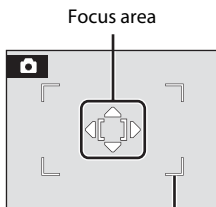

Selectable areas

## Center

The camera focuses on the subject in the center of the frame.

The focus area is always positioned at the center of the screen.

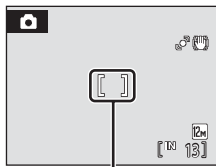

Focus area

## Notes on AF Area Mode

This feature cannot be used simultaneously with certain features. → “Functions that Cannot be Applied Simultaneously” (📖 109)

## Focus Lock

Use focus lock to focus on off-center subjects when center is selected for AF area mode.

The following steps explain the usage of focus lock when **Center** is selected for **AF area mode**.

- 1 Position the subject in the center of the frame.
- 2 Press the shutter-release button halfway.
  - Confirm that the focus area indicator is green.
  - Focus and exposure are locked.
- 3 Continue holding down the shutter-release button halfway and recompose the picture.
  - Be sure that the distance between the camera and the subject does not change.
- 4 Press the shutter-release button the rest of the way down to shoot.



## More Information

See “Autofocus” (📖 29) for more information.

## Shooting with Face Priority

When the camera is pointed at a face, the face is automatically detected and the camera focuses on the face.

The face priority function will be enabled for scenarios such as the following.

- **Face priority** is selected for AF area mode (📖 104)
- When **Scene auto selector** (📖 45), **Portrait** (📖 38) or **Night portrait** (📖 39) is chosen for scene mode
- When using smart portrait mode (📖 51)

### 1 Frame the picture.

- When the camera detects a face, that face will be framed by a yellow double border.

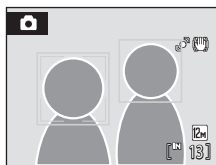

- When the camera detects more than one face, operation varies, depending upon the shooting mode, as follows.



Shooting mode	Faces framed by a double border	Number of faces to be recognized
Auto mode ( <b>Face priority</b> )	The face closest to the camera	Up to 12
<b>Scene auto selector, Portrait or Night portrait</b> scene modes	* The other faces are framed by a single border.	
Smart portrait mode	The face closest to the camera * The other faces are framed by a single border.	Up to 3

### 2 Press the shutter-release button halfway.

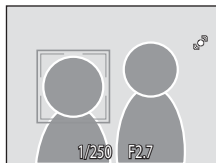
- The camera focuses on the face framed by the double border. The double border will glow green and focus will be locked.
- When the camera is unable to focus on a face, the double border will blink. Press the shutter-release button halfway again and focus.
- Press the shutter-release button all the way down to shoot.
- When using smart portrait mode, even if the shutter-release button is not pressed, the shutter is released automatically if the camera detects that the face framed by the double border is smiling (**Smile timer**) (📖 53).



### Notes on Face Priority

- When **Face priority** is selected for AF area mode, the setting will automatically switch to **Auto** if no face is detected when the shutter-release button is pressed halfway.
- If no face is recognized when the shutter-release button is pressed halfway in the **Portrait** or **Night portrait** scene modes or smart portrait mode, the camera will focus on the subject in the center of the frame.
- Depending on shooting conditions, such as whether or not the subject is facing the camera, faces may not be detected.
- The camera may be unable to detect faces in the following situations:
  - When faces are partially hidden by sunglasses or other obstructions
  - When faces take up too much or too little of the frame
- When there are multiple people in the frame, the face on which the camera focuses depends on a variety of shooting conditions, such as whether or not the subject is facing the camera.
- In some rare cases shooting subjects with which autofocus may not perform as expected ( 29), the subject may not be in focus despite the fact that the double border glows green. Should this occur, switch to auto mode and set AF area mode to **Manual** or **Center**, refocus on another subject positioned at the same distance from the camera as the actual portrait subject, and use focus lock ( 105).
- Images that were taken using face priority will be rotated and displayed automatically according to the orientation of the faces detected, in full-frame and thumbnail playback modes (excluding pictures that were shot using **Continuous**, **BSS** and **Multi-shot 16** ( 101)).

## **Autofocus Mode**

Set to  (Auto) → MENU (Shooting menu) →  Autofocus mode

Choose how the camera focuses.



### **Single AF (default setting)**

Camera focuses when the shutter-release button is pressed halfway.



### **Full-time AF**

Camera focuses continuously until the shutter-release button is pressed down halfway. Use with moving subjects.

A sound will be heard while the camera focuses.



### **Notes on Autofocus Mode**

This feature cannot be used simultaneously with certain features. → “Functions that Cannot be Applied Simultaneously” (📖 109)



### **Notes on the Autofocus Mode Setting for Subject Tracking Mode**

You can set **Autofocus mode** for subject tracking mode. The default setting in subject tracking mode is **Full-time AF**. **Autofocus mode** can be set independently for both subject tracking mode and auto mode.













## Functions that Cannot be Applied Simultaneously

Certain settings in the shooting menu cannot be used with other functions.

Restricted Functions	Setting	Description
Flash mode	Continuous (📖 101)	If set to <b>Continuous</b> , <b>BSS</b> , or <b>Multi-shot 16</b> , the flash cannot be used.
Image mode	Continuous (📖 101)	When using <b>Multi-shot 16</b> , <b>Image mode</b> is fixed at <b>SM Normal (2592)</b> .
Continuous	Self-timer (📖 34)	Fixed at <b>Single</b> when using self-timer.
ISO sensitivity	Continuous (📖 101)	When using <b>Multi-shot 16</b> , <b>ISO sensitivity</b> is set automatically according to the brightness.
White balance	Color Options (📖 103)	When using <b>Black-and-white</b> , <b>Sepia</b> , or <b>Cyanotype</b> , the <b>White balance</b> setting is fixed at <b>Auto</b> .
Autofocus mode	AF-Area Mode (📖 104)	When using <b>Face priority</b> , <b>Autofocus mode</b> is fixed <b>Single AF</b> .
Motion Detection	Continuous (📖 101)	When using <b>Multi-shot 16</b> , <b>Motion detection</b> will not function.
	ISO Sensitivity (📖 102)	If ISO sensitivity is fixed, <b>Motion detection</b> will not function.
Blink Warning	Continuous (📖 101)	If set to <b>Continuous</b> , <b>BSS</b> , or <b>Multi-shot 16</b> , the blink warning will not function.

## Playback Options: The Playback Menu

The following options are available in playback mode.

	<b>Quick retouch</b> <span style="float: right;">📖 71</span>
Easily create retouched images in which contrast and saturation have been enhanced.	
	<b>D-Lighting</b> <span style="float: right;">📖 72</span>
Enhances brightness and contrast in dark portions of pictures.	
	<b>Skin softening</b> <span style="float: right;">📖 73</span>
Make the subject's skin appear smoother.	
	<b>Print set</b> <span style="float: right;">📖 92</span>
Select pictures to print and the number of copies for each.	
	<b>Slide show</b> <span style="float: right;">📖 112</span>
View pictures stored in the internal memory or on a memory card in an automatic slide show.	
	<b>Delete</b> <span style="float: right;">📖 113</span>
Delete selected or all pictures.	
	<b>Protect</b> <span style="float: right;">📖 113</span>
Protect selected pictures from accidental deletion.	
	<b>Rotate image</b> <span style="float: right;">📖 114</span>
Change the orientation of an existing picture.	
	<b>Small picture</b> <span style="float: right;">📖 74</span>
Create a small copy of the current picture.	
	<b>Voice memo</b> <span style="float: right;">📖 67</span>
Record and play voice memo.	
	<b>Copy</b> <span style="float: right;">📖 115</span>
Copy files between memory card and internal memory.	

### Displaying the Playback Menu

Enter the playback mode by pressing the  button (📖 30).

Display the playback menu by pressing the **MENU** button.

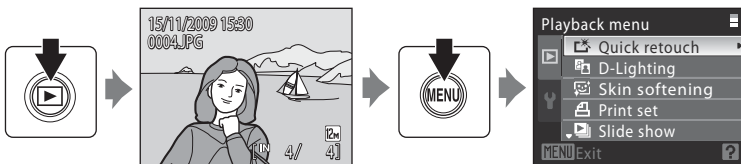

- Use the rotary multi selector to choose and apply settings (📖 10).
- To exit the playback menu, press the **MENU** button.

## Selecting Pictures

The picture selection screen, as shown at right, will be displayed with the following menus:

- **Playback menu:**
  - Select images** in Print set (📖 92)
  - Erase selected images** in Delete (📖 113)
  - Protect (📖 113)
  - Rotate image (📖 114)
  - Selected images** in Copy (📖 115)
- **Setup menu:**
  - Select an image** in Welcome screen (📖 119)



Follow the procedure described below to select pictures.

### 1 Rotate the rotary multi selector, or press ◀ or ▶ to choose the desired picture.

- Only one picture can be selected for **Rotate image** and **Welcome screen**. Proceed to step 3
- Rotate the zoom control to **T** (📄) to switch to full-frame playback, or **W** (📖) to switch to 12 thumbnails display.





### 2 Press ▲ or ▼ to select ON or OFF (or the number of copies).

- When ON is selected, a check mark is displayed in the current picture. Repeat steps 1 and 2 to select additional pictures.





### 3 Press the Ⓞ button to apply picture selection.

## Slide Show

Press the  button (Playback mode) → MENU (Playback menu) →  Slide show



View pictures stored in the internal memory or on a memory card in an automatic slide show.

### 1 Use the rotary multi selector to choose **Start** and press the button.

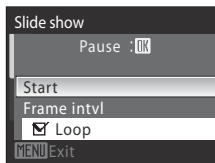
- To change the interval between pictures, choose **Frame intvl**, select the desired interval time, and press the  button before choosing **Start**.
- To repeat the slide show automatically, enable **Loop** and press the  button before choosing **Start**. The check mark () will be added to the loop option when enabled.



### 2 The slide show begins.

- Press the rotary multi selector  while the slide show is in progress to view images in the order recorded (hold down to fast forward), or  to view images in reverse order (hold down to rewind).
- Press the  button to pause the slide show.



### 3 Choose **End** or **Restart**.

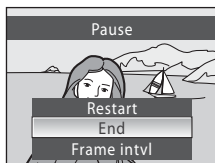

- When the slide show ends or is paused, choose **End** and press the  button to return to the playback menu or choose **Restart** to play the slide show again.



## Notes on Slide Show

- Movies are not included in slide shows.
- Slide shows play for a maximum of 30 minutes, even when **Loop** is selected ( 128).

## Delete

Press the  button (Playback mode) → MENU (Playback menu) →  Delete

Delete selected or all pictures.

### Erase selected images

Delete selected pictures (see “Selecting Pictures” ( 111) for more information).

### Erase all images



Delete all pictures.

## Notes on Deletion

- Once deleted, pictures cannot be recovered. Transfer important images to a computer before deletion.
- pictures marked with the  icon are protected and cannot be deleted.

---

## Protect

Press the  button (Playback mode) → MENU (Playback menu) →  Protect

Protect selected pictures from accidental deletion.

Select the picture and apply the setting in the picture selection screen (see “Selecting Pictures” ( 111) for more information).

Note, however, that formatting the camera’s internal memory or the memory card will permanently erase protected files ( 129).

Protected pictures are recognized by the  icon in playback mode ( 7, 58).





## Rotate Image

Press the  button (Playback mode) → MENU (Playback menu) →  Rotate image

Change the orientation of pictures played back in the camera's monitor after shooting.

Pictures can be rotated 90° clockwise or counterclockwise.

Pictures that were recorded in the portrait (vertical) orientation can be rotated up to 180° in either direction.

Select a picture in the picture selection screen ( 111), and press the  button to display the Rotate image screen. Rotate the rotary multi selector or press  or  to rotate the picture 90°.

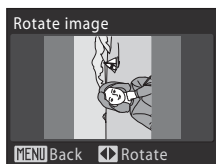

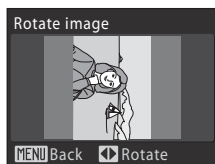
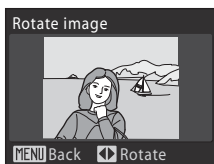

Rotate 90°  
counterclockwise



Rotate 90° clockwise



Press the  button to set the orientation displayed, and save the orientation data with the picture.

## Copy

Press the  button (Playback mode) → MENU (Playback menu) →  Copy

Copy pictures between the internal memory and a memory card.

- Use the rotary multi selector to select an option from the copy screen and press the  button.

- : Copy pictures from internal memory to memory card.
- : Copy pictures from memory card to internal memory.

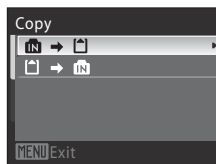



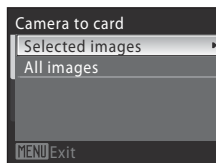

- Select a copy option and press the  button.

- Selected images:** Copy pictures selected from the picture selection screen ( 111).
- All images:** Copy all pictures.



### Notes on Copying Pictures

- JPEG-, AVI-, and WAV-format files can be copied. Files recorded in any other format cannot be copied.
- If voice memos ( 67) are attached to pictures selected for copying, voice memos are copied with the pictures.
- Pictures recorded with another make or model of camera or that have been modified on a computer cannot be copied.
- Edited copies have the same **Protect** ( 92) as the original, but are not marked for **Print set** ( 113).
- Pictures or movies copied from the internal memory or the memory card ( 64) cannot be displayed in the auto sort mode.

### Memory contains no images. Message

















If there are no pictures stored on the memory card when playback mode is applied, the message, **Memory contains no images.**, will be displayed. Press the MENU button to display the copy option screen, and copy the pictures stored in the camera's internal memory to the memory card.

### More Information





See "File and Folder Names" ( 139) for more information.

## Basic Camera Setup: The Setup Menu

The setup menu contains the following options.

	<b>Menus</b> <span style="float: right;">📖 118</span>
	Choose how menus are displayed.
	<b>Welcome screen</b> <span style="float: right;">📖 119</span>
	Select the welcome screen that is displayed when the camera is turned on.
	<b>Date</b> <span style="float: right;">📖 120</span>
	Set camera clock and choose home and destination time zones.
	<b>Monitor settings</b> <span style="float: right;">📖 123</span>
	Adjust monitor brightness and choose display style.
	<b>Date imprint</b> <span style="float: right;">📖 124</span>
	Imprint date on pictures.
	<b>Vibration reduction</b> <span style="float: right;">📖 125</span>
	Reduce the effects of camera shake while shooting.
	<b>Motion detection</b> <span style="float: right;">📖 126</span>
	Adjust the motion detection setting to reduce the effects of camera shake and subject movement when shooting still pictures.
	<b>AF assist</b> <span style="float: right;">📖 127</span>
	Enable or disable AF-assist illumination.
	<b>Digital zoom</b> <span style="float: right;">📖 127</span>
	Enable or disable digital zoom.
	<b>Sound settings</b> <span style="float: right;">📖 128</span>
	Adjust sound settings.
	<b>Auto off</b> <span style="float: right;">📖 128</span>
	Set time before camera enters standby mode to save power.
	<b>Format memory/Format card</b> <span style="float: right;">📖 129</span>
	Format internal memory or memory card.
	<b>Language</b> <span style="float: right;">📖 130</span>
	Choose language used for camera monitor display.
	<b>Video mode</b> <span style="float: right;">📖 130</span>
	Adjust settings necessary for connection to TV.
	<b>Charge by computer</b> <span style="float: right;">📖 131</span>
	Choose whether or not the battery is charged when the camera is connected to a computer via USB cable.
	<b>Blink warning</b> <span style="float: right;">📖 132</span>
	Choose whether or not to detect blinking human subjects when shooting pictures using face priority.



	<b>Reset all</b>	 134
	Restore camera settings to default values.	
	<b>Firmware version</b>	 136
	Display camera firmware version.	

## Displaying the Setup Menu

Choose the  tab in the menu screen.

**1** Press the **MENU** button to display the menu screen.

- When using  (auto) mode, smart portrait mode, subject tracking mode, playback mode, and movie mode
- When using scene mode

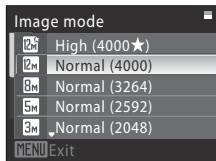
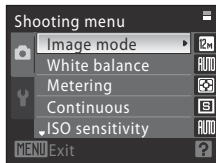

**2** Press  on the rotary multi selector.

- For information on using the rotary multi selector, see “The Rotary Multi Selector” ( 10).
- Tab will be selectable.



**3** Press  or  to select the  tab.

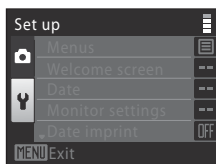

#### 4 Press **▶** or the **OK** button.

- The setup menu options will be selectable.
- Use the rotary multi selector to choose and apply settings (📖 10).
- To exit the setup menu, press the **MENU** button, or press **◀** and select another tab.

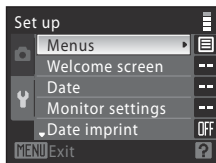

## **MENU** Menu

Press the **MENU** button → **Y** (setup menu) (📖 117) → **MENU** Menu

Choose how menus are displayed.

### Text (default setting)

Menus are displayed in list format.

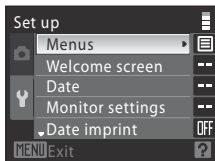

### Icons

All menu options can be displayed in a single page.

Menu name

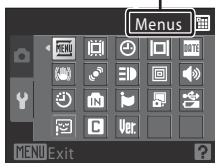

## Welcome Screen

Press the **MENU** button →  (setup menu) (📖 117) →  Welcome screen

Select the welcome screen that is displayed when the camera is turned on.

### None (default setting)

Welcome screen is not displayed.

### COOLPIX

Displays a welcome screen.

### Select an image

Select a picture in the internal memory or on the memory card for the welcome screen. Choose a picture in the picture selection screen (📖 111), and press the  button.

As the selected picture is stored in the camera, the picture will appear in the welcome screen even if the original picture is deleted.

- Pictures taken at an **Image mode** setting (📖 96) of **16:9**, and copies created at a size of 320 × 240 or smaller using the small picture (📖 74) or crop (📖 75) functions, cannot be used.

## Date







Press the MENU button →  (Setup menu) ( 117) →  Date

Set the camera's internal clock.





### Date

Set camera clock to current date and time.

Use the rotary multi selector to set the date and time.

- Highlight an item (day, month, year, hour, minute, and the order in which day, month, and year are displayed): Press  or .
- Edit the highlighted item: Press  or , or rotate the rotary multi selector.
- Finish setting: After selecting the order in which the day, month, and year are displayed, press the  button ( 21).

### Time zone

Set the home time zone () and enable or disable daylight saving time. When the travel destination () is selected, the time difference ( 122) between the travel destination and the home time zone () is automatically calculated and the date and time in the selected region are recorded. Useful when travelling.

## Setting the Travel Destination Time Zone

- 1 Use the rotary multi selector to choose **Time zone** and press the  button.

- The **Time zone** screen is displayed.

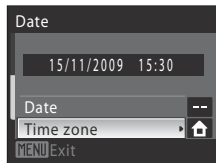

- 2 Choose  **Travel destination** and press the  button.

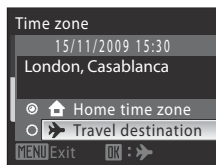

- The date and time displayed on the monitor changes according to the region currently selected.

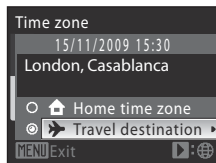

**3** Press **▶**.

- The time zone selection screen is displayed.

**4** Press **◀** or **▶** to choose the travel destination time zone.

- When using the camera in an area where daylight saving time is in effect, press **▲** to set the clock to daylight saving time. When daylight saving time is turned on, the  icon is displayed and the clock advances by one hour. To turn the setting off, press **▼**.
- Press the **OK** button to enter the travel destination time zone.
- While the travel destination time zone is selected, the  icon will be displayed in the monitor when the camera is in shooting mode.

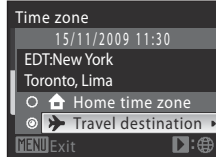
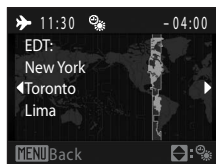
**✓ Backup Battery**

The camera's internal clock uses a backup battery that is independent from the camera's battery. The backup battery is charged while the main battery is installed or while the AC adapter is connected, and will remember the clock settings for several days after about ten hours of charging.

**📎 Home Time Zone**

- To switch to the home time zone, choose **Home time zone** in step 2 and press the **OK** button.
- To change the home time zone, choose **Home time zone** in step 2 and perform the steps for **Travel destination** to set the home time zone.

**📎 Daylight Saving Time**

When daylight saving time starts or ends, turn the daylight saving time option on or off from the time zone selection screen displayed in step 4.

**📎 Imprinting the Date on Pictures**

After setting the date and time, set the **Date imprint** setting in the setup menu (📖 124). Once **Date imprint** is set, the shooting date and time can be imprinted on the image data when taking pictures.

## Basic Camera Setup: The Setup Menu

### Time Zones (📖 21)

The camera supports the time zones listed below.

For time differences not listed below, set the camera clock using **Date**.

UTC +/-	Location	UTC +/-	Location
-11	Midway, Samoa	+1	Madrid, Paris, Berlin
-10	Hawaii, Tahiti	+2	Athens, Helsinki, Ankara
-9	Alaska, Anchorage	+3	Moscow, Nairobi, Riyadh, Kuwait, Manama
-8	PST (PDT): Los Angeles, Seattle, Vancouver	+4	Abu Dhabi, Dubai
-7	MST (MDT): Denver, Phoenix	+5	Islamabad, Karachi
-6	CST (CDT): Chicago, Houston, Mexico City	+5.5	New Delhi
-5	EST (EDT): New York, Toronto, Lima	+6	Colombo, Dhaka
-4	Caracas, Manaus	+7	Bangkok, Jakarta
-3	Buenos Aires, Sao Paulo	+8	Beijing, Hong Kong, Singapore
-2	Fernando de Noronha	+9	Tokyo, Seoul
-1	Azores	+10	Sydney, Guam
±0	London, Casablanca	+11	New Caledonia
		+12	Auckland, Fiji

## Monitor Settings

Press the MENU button → Y (Setup menu) (📖 117) →  Monitor settings

Change the settings for the options below.

### Photo info

Choose information displayed in the monitor during shooting and playback mode.







### Brightness

Choose from five settings for monitor brightness. The default setting is **3**.

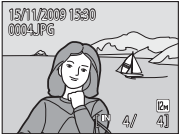
### Photo Info

The following display options are available.

See “The Monitor” (📖 6) for information on indicators in the monitor.

	During Shooting	During Playback
Show info		
Auto info (default setting)	The current settings or operation guide is displayed as in <b>Show info</b> above. After a few seconds, display will be the same as <b>Hide info</b> .	
Hide info		
Framing grid + Auto info	 In  (auto) mode, a framing grid is displayed to help frame pictures; other current settings or operation guide is displayed for a few seconds, as in <b>Auto info</b> above. In other shooting modes, the current settings or operation guide is displayed, as in <b>Auto info</b> above.	 The current settings or operation guide is displayed, as in <b>Auto info</b> above.

### **DATE** Date Imprint

Press the **MENU** button → **Y** (Setup menu) (📖 117) → **DATE** Date imprint

The shooting date and time can be imprinted in pictures at the time of shooting. This information can be printed even from printers that do not support printing of date and time (📖 94).



#### Off (default setting)

Date and time are not imprinted on pictures.

#### Date

The date is imprinted in pictures.

#### Date and time

The date and time are imprinted in pictures.

At settings other than **Off**, the icon for the current setting is displayed in the monitor during shooting (📖 6).

### **✓** Date Imprint



- Imprinted dates form a permanent part of image data and cannot be deleted.
- Dates imprinted at an **Image mode** (📖 96) setting of **TV screen (640)** may be difficult to read. Choose **PC screen (1024)** or larger when using date imprint.
- The date is recorded using the format selected in the setup menu's **Date** option (📖 20, 120).
- Dates cannot be imprinted in the following situations.
  - When using the **Panorama assist** scene mode
  - Movie mode

### **📎** Date Imprint and Print Set

When printing from DPOF-compatible printers which support printing of shooting date and photo information, the date and information can be printed on pictures without date and time imprinted on them, using options in the **Print set** option (📖 92).



## Vibration Reduction

Press the **MENU** button →  (Setup menu) ( 117) →  Vibration reduction

Reduce the effects of camera shake while shooting. Vibration reduction effectively corrects blur, caused by slight hand movement known as camera shake, that commonly occurs when shooting with zoom applied or at slow shutter speeds. Set vibration reduction to **Off** when using a tripod to stabilize the camera during shooting.

### On (default setting)

Vibration reduction is enabled when shooting still pictures and recording movies. Camera detects and factors out panning movements when reducing camera shake. When camera is panned horizontally, for example, vibration reduction reduces only vertical shake. If camera is panned vertically, vibration reduction affects only horizontal shake.

### Off

Vibration reduction is disabled.

When vibration reduction is enabled, the current setting is displayed during shooting (when **Off** is selected, an icon for the current setting is not displayed) ( 6, 25).

## Notes on Vibration Reduction

- Vibration reduction may take a few seconds to activate after the power is turned on, or the camera enters shooting mode from playback mode. Wait until the display stabilizes before shooting.
- Due to characteristics of the vibration reduction function, images displayed in the camera's monitor immediately after shooting may appear blurry.
- Vibration reduction may be unable to completely eliminate the effects of camera shake in some situations.

### **Motion Detection**

Press the **MENU** button →  (Setup menu) (📖 117) →  Motion detection

Enable motion detection to reduce the effects of camera shake and subject movement when shooting still pictures.

#### Auto (default setting)

When camera detects the movement of the subject or camera shake, the shutter speed will be increased for reducing the effects of them.

However, motion detection does not function in the following situations.

- When the flash fires
- In auto mode, when **ISO sensitivity** (📖 102) is fixed
- In auto mode, when **Multi-shot 16** is set (📖 101)
- In the following scene modes: **Sport** (📖 39), **Night portrait** (📖 39), **Fireworks show** (📖 43), and **Backlight** (📖 43)
- When subject tracking mode is selected

#### Off

Motion detection is disabled.

The motion detection setting can be confirmed in the monitor while shooting (📖 6, 25).

The motion detection icon will glow green when the camera detects any vibration and increases the shutter speed. When **Off** is selected, the icon for the current setting is not displayed.

### **Notes on Motion Detection**

- Motion detection may be unable to completely reduce the camera shake and subject movement in some situations.
- Motion detection may not function if the subject exhibits significant movement or is too dark.
- Pictures taken using motion detection may be somewhat grainy.

## AF Assist

Press the MENU button →  (Setup menu) (📖 117) →  AF assist

Enable or disable AF-assist illumination.



### Auto (default setting)

AF-assist illumination will be used to assist the focus operation when the subject is poorly lit. The illuminator has a range of about 3.0 m (9 ft. 10 in.) at the maximum wide-angle position and about 1.0 m (3 ft. 3 in.) at the maximum telephoto position. However, note that for some scene modes, AF-assist illumination turns off automatically (📖 38 to 44) even if **Auto** is set.

### Off

Disable this function. The camera may be unable to focus if lighting is poor.

## Digital Zoom

Press the MENU button →  (Setup menu) (📖 117) →  Digital zoom

Enable or disable digital zoom.

### On (default setting)

When the camera is zoomed in to the maximum optical zoom position, rotating and hold the zoom control at **T** (📖) triggers digital zoom (📖 27).

### Off

Digital zoom will not be activated (except when shooting a movie).

## Notes on Digital Zoom

- When using digital zoom, AF area mode is set to **Center** and cannot be changed (📖 104).
- Digital zoom cannot be used in the following situations.
  - When **Scene auto selector, Portrait** or **Night portrait** is selected for scene mode
  - When smart portrait mode is selected
  - When subject tracking mode is selected
  - When **Multi-shot 16** is selected (📖 101)
  - Before movie recording begins (digital zoom of up to 2x can be applied while movies are being recorded)
- When using digital zoom, **Metering** is set to **Center-weighted**.

## Sound Settings

Press the MENU button →  (Setup menu) ( 117) →  Sound settings

Adjust the following sound settings.

### Button sound

Turn button sound **On** (default setting) or **Off**. A beep will sound once when operations are completed successfully, twice when the camera acquires focus on the subject, and three times when error is detected. Start-up sound will also play when the camera is turned on.

### Shutter sound

Choose shutter sound from **On** (default setting) or **Off**.

## Auto Off

Press the MENU button →  (Setup menu) ( 117) →  Auto off

If no operations are performed for the selected length of time, the monitor will turn off and the camera enters standby mode ( 19) to reduce drain on the batteries. The power-on lamp blinks in standby mode. If no operations are performed for another three minutes, the camera will turn off automatically. Choose the time allowed to elapse before the camera enters standby mode if no operations are performed from **30 s**, **1 min** (default setting), **5 min**, and **30 min**.

### Canceling Standby Mode

Standby mode is canceled when the following buttons are pressed.





- Power switch
- Shutter-release button

### Notes on Auto Off

Regardless of the option selected, the monitor will remain on as follows.

- While a menu is displayed: If auto off is set to **30 s** or **1 min**, it is extended to 3 minutes.
- Slide show playback: maximum of 30 minutes
- AC Adapter EH-62F is connected: 30 minutes

## **Format Memory/Format Card**

Press the **MENU** button →  (Setup menu) ( 117) →  **Format memory/**  
 **Format card**

Use this option to format the internal memory or a memory card.

### **Formatting the Internal Memory**

To format the internal memory, remove the memory card from the camera. The **Format memory** option appears in the setup menu.

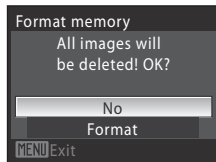

### **Formatting a Memory Card**

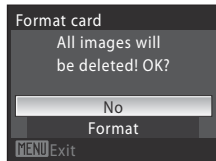

When the memory card is inserted in the camera, the **Format card** option appears in the setup menu.



## **Formatting Internal Memory and Memory Cards**

- Formatting the internal memory or memory cards permanently deletes all data. Be sure to transfer important pictures to a computer before formatting.
- Do not turn the camera off, disconnect the AC adapter, or open the battery-chamber/memory card slot cover during formatting.
- The first time you insert the memory cards used in other devices into this camera, be sure to format them with this camera.

## Language



Press the **MENU** button →  (Setup menu) (📖 117) →  Language

Choose one of 24 languages for display of camera menus and messages.

<b>Čeština</b>	Czech
<b>Dansk</b>	Danish
<b>Deutsch</b>	German
<b>English</b>	(default setting)
<b>Español</b>	Spanish
<b>Ελληνικά</b>	Greek
<b>Français</b>	French
<b>Indonesia</b>	Indonesian
<b>Italiano</b>	Italian
<b>Magyar</b>	Hungarian
<b>Nederlands</b>	Dutch
<b>Norsk</b>	Norwegian

<b>Polski</b>	Polish
<b>Português</b>	Portuguese
<b>Русский</b>	Russian
<b>Suomi</b>	Finnish
<b>Svenska</b>	Swedish
<b>Türkçe</b>	Turkish
<b>عربي</b>	Arabic
<b>中文简体</b>	Simplified Chinese
<b>中文繁體</b>	Traditional Chinese
<b>日本語</b>	Japanese
<b>한글</b>	Korean
<b>ภาษาไทย</b>	Thai



## Video Mode

Press the **MENU** button →  (Setup menu) (📖 117) →  Video mode

Adjust settings for connection to TV.

Choose from **NTSC** or **PAL**.

## Charge by Computer

Press the **MENU** button →  (Setup menu) ( 117) →  Charge by computer

Choose whether or not the battery inserted in the camera is charged when the camera is connected to a computer via USB cable ( 84).

### Auto (default setting)

When the camera is connected to a computer that is running, the battery inserted into the camera is automatically charged using power supplied by the computer.



### Off

The battery inserted into the camera is not charged when the camera is connected to a computer.

## Notes on Connecting the Camera to a Printer

- The battery cannot be charged with connection to a printer, even if the printer complies with the PictBridge standard.
- When **Auto** is selected for **Charge by computer**, it may be impossible to print pictures with direct connection of the camera to some printers. If the **PictBridge** startup screen is not displayed in the monitor after the camera is connected to a printer and turned on, turn the camera off and disconnect the USB cable. Set **Charge by computer** to **Off** and reconnect the camera to the printer.

## **Blink Warning**

Press the **MENU** button →  (Setup menu) (📖 117) →  Blink warning

Choose whether or not blinking eyes are detected when using face priority (📖 106) in the following shooting modes.

-  (auto) mode (when AF area mode is set to **Face priority**) (📖 106)
- **Scene auto selector** (📖 38), **Portrait** (📖 38), or **Night portrait** (📖 39) scene modes

### On

When the camera detects that one or more human subjects have closed their eyes shortly after recognizing the faces and shooting them, the **Did someone blink?** screen will appear on the monitor.

The face of the human subject that may have closed his/her eyes is framed by a yellow border. You can check the picture taken and determine if you need to take the picture again.

→ “Operating the Did someone blink? Screen” (📖 133)

### Off (default setting)

Blink warning doesn't take effect.

## **Note on Blink warning**

132 When continuous is set to **Continuous**, **BSS**, or **Multi-shot 16**, blink warning does not function.









## Operating the Did someone blink? Screen

The following operations can be performed when the **Did someone blink?** screen is displayed.

If no operations are performed for a few seconds, the screen automatically returns to the shooting mode screen.



To	Use	Description
Enlarge and display the detected face	<b>T</b> (Q)	Zoom increases each time the zoom control is rotated to <b>T</b> (Q).
Return to full-frame playback	<b>W</b> (checkered flag)	Rotate the zoom control to <b>W</b> (checkered flag).
Select the face to be displayed		If the camera detects more than one human subject blinking, press ◀ or ▶ during playback zoom to display other faces.
Delete the picture taken		Press the  button.
The camera returns to shooting mode.		Press the  button or the shutter-release button.
		

## Reset All

Press the MENU button →  (Setup menu) (📖 117) →  Reset all

When **Reset** is selected, the camera's settings will be restored to their default values.

## Pop-up Menu

Option	Default value
Flash mode (📖 32)	Auto
Self-timer (📖 34)	OFF
Macro mode (📖 35)	OFF
Exposure compensation (📖 36)	0.0

## Shooting in the Scene Mode

Option	Default value
Scene setting for shooting mode (📖 37)	Scene auto selector
White balance setting in food mode (📖 47)	Center

## Smart Portrait Menu

Option	Default value
Skin softening (📖 52)	Normal
Smile timer (📖 53)	On
Blink proof (📖 52)	Off

## Subject Tracking Menu

Option	Default value
Autofocus mode (📖 56)	Full-time AF
Face priority tracking (📖 56)	On

## Movie Menu

Option	Default value
Movie options (📖 77)	TV movie 640
Autofocus mode (📖 77)	Single AF

## Shooting Menu

Option	Default value
Image mode (📖 96)	 Normal (4000)
White balance (📖 98)	Auto
Metering (📖 100)	Matrix
Continuous (📖 101)	Single
ISO sensitivity (📖 102)	Auto
Color options (📖 103)	Standard color
AF area mode (📖 104)	Auto
Autofocus mode (📖 108)	Single AF

## Setup Menu

Option	Default value
Menus (📖 118)	Text
Welcome screen (📖 119)	None
Photo info (📖 123)	Auto info
Brightness (📖 123)	3
Date imprint (📖 124)	Off
Vibration reduction (📖 125)	On
Motion detection (📖 126)	Auto
AF assist (📖 127)	Auto
Digital zoom (📖 127)	On
Button sound (📖 128)	On
Shutter sound (📖 128)	On
Auto off (📖 128)	1 min
Charge by computer (📖 131)	Auto
Blink warning (📖 132)	Off

## Others

Option	Default value
Paper size (📖 88, 89)	Default
Slide show (📖 112)	3 s

- Choosing **Reset all** also clears the current file number (📖 139) from the memory. Numbering will continue from the lowest number available. To reset file numbering to “0001”, delete all pictures (📖 113) before selecting **Reset all**.
- The following items remain unaffected when the camera is reset with **Reset all**.

### Shooting menu:

Preset manual data (📖 99) acquired for **White balance**

### Setup menu:

**Date** (📖 120), **Language** (📖 130), and **Video mode** (📖 130)

---

## Ver. Firmware Version

Press the MENU button → **Y** (Setup menu) (📖 117) → **Ver.** Firmware version

View the current camera firmware version.

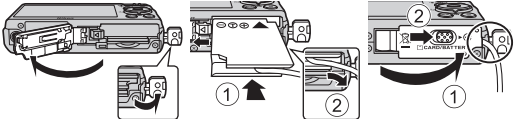

## Optional Accessories

Rechargeable battery	Rechargeable Li-ion Battery EN-EL12
Charging AC Adapter	Charging AC Adapter EH-68P/EH-68P (AR) <sup>1</sup>
Battery charger	Battery Charger MH-65
AC adapter	<p>AC Adapter EH-62F (connect as shown)</p>  <p>Insert the AC adapter cord into the groove deeply in the battery chamber before closing the battery-chamber/memory card slot cover. If part of the cord runs out of the groove, the cover or cord may be damaged when the cover is closed.</p>
USB cable	USB Cable UC-E6
A/V cable	Audio Video Cable EG-CP14

<sup>1</sup> When using in other countries, use a third-party plug adapter as necessary. For more information about plug adapters, consult your travel agency.

## Approved Memory Cards

The following Secure Digital (SD) memory cards have been tested and approved for use in this camera.

- All cards of the designated make and capacity can be used, regardless of speed.

SanDisk	512 MB, 1 GB, 2 GB <sup>1</sup> , 4 GB <sup>2</sup> , 8 GB <sup>2</sup> , 16 GB <sup>2</sup>
TOSHIBA	512 MB, 1 GB, 2 GB <sup>1</sup> , 4 GB <sup>2</sup> , 8 GB <sup>2</sup> , 16 GB <sup>2</sup>
Panasonic	512 MB, 1 GB, 2 GB <sup>1</sup> , 4 GB <sup>2</sup> , 8 GB <sup>2</sup> , 16 GB <sup>2</sup>
Lexar	1 GB, 2 GB <sup>1</sup> , 4 GB <sup>2</sup> , 8 GB <sup>2</sup>

- 1 If the memory card will be used with a card reader or similar device, check that device supports 2 GB cards.
- 2  SDHC-compliant. If the memory card will be used with a card reader or similar device, check that device supports SDHC.

Operation is not guaranteed with other makes of card. Contact the manufacturer for details on the above cards.

Refer to the Nikon website for the latest information on approved cards.

## File and Folder Names

Pictures, movies, and voice memos are assigned file names as follows.

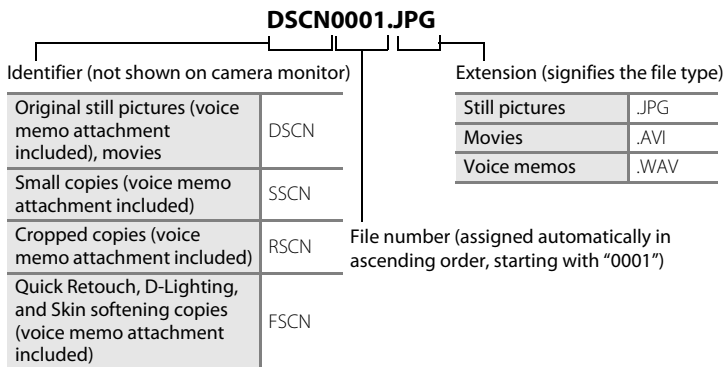

- Files are stored in folders named with a folder number followed by a five-character identifier: "P\_" plus a three-digit sequence number for pictures shot using **Panorama assist** (e.g. "101P\_001"; 📖 49), and "NIKON" for all other pictures (e.g. "100NIKON"). When the number of files within a folder reaches 9999, a new folder will be created. File numbers will be assigned automatically starting with "0001."
- Voice memo file names have the same identifier and file number as the picture to which the voice memo is attached.
- Files copied using **Copy > Selected images** is copied to the current folder, where they are assigned new file numbers in ascending order starting from the largest file number in memory. **Copy > All images** copies all folders from the source medium; file names do not change but new folder numbers are assigned in ascending order, starting from the largest folder number on the destination medium (📖 115).
- A single folder can hold up to 200 pictures; if the current folder already contains 200 pictures, a new folder, named by adding one to the current folder name, will be created the next time a picture is taken. If the current folder is numbered 999 and contains 200 pictures, or a picture is numbered 9999, no further pictures can be taken until the internal memory or memory card is formatted (📖 129), or a new memory card is inserted.

## Caring for the Camera

To ensure continued enjoyment of this Nikon product, observe the following precautions when using or storing the device.

### **Keep dry**

The device will be damaged if immersed in water or subjected to high humidity.

### **Do not drop**

The product may malfunction if subjected to strong shock or vibration.

### **Handle the lens and all moving parts with care**

Do not apply force to the lens, lens cover, monitor, memory card slot or battery chamber. These parts are easily damaged. Applying force to the lens cover could result in camera malfunction or damage to the lens. Should the monitor break, care should be taken to avoid injury caused by broken glass and to prevent the liquid crystal from the display touching the skin or entering the eyes or mouth.

### **Do not point the lens at strong light sources for extended periods**

Avoid pointing the lens at the sun or other strong light sources for extended periods when using or storing the camera. Intense light may cause deterioration of the CCD image sensor, producing a white blur effect in photographs.

### **Keep away from strong magnetic fields**

Do not use or store this device in the vicinity of equipment that generates strong electromagnetic radiation or magnetic fields. Strong static charges or the magnetic fields produced by equipment such as radio transmitters could interfere with the monitor, damage data stored on the memory card, or affect the product's internal circuitry.

### **Avoid sudden changes in temperature**

Sudden changes in temperature, such as when entering or leaving a heated building on a cold day, can cause condensation to form inside the device. To prevent condensation, place the device in a carrying case or a plastic bag before exposing it to sudden changes in temperature.

### **Turn the product off before removing or disconnecting the power source**

Do not remove the battery while the product is on, or while images are being recorded or deleted. Forcibly cutting power in these circumstances could result in loss of data or in damage to product memory or internal circuitry.



 **The Battery**

- Check the battery level when taking the camera out, and charge the battery if necessary. Do not continue charging once the battery is fully charged, as this will result in reduced battery performance. If possible, carry a fully-charged spare battery when taking pictures on important occasions.
- Do not use the battery at ambient temperatures below 0 °C (32 °F) or above 40 °C (104 °F). Failure to observe this precaution could damage the battery or impair its performance.
- Charge the battery in an indoor environment that is between 5 and 35 °C (41 to 95 °F).
- When charging the battery by connecting the COOLPIX S640 to the Charging AC Adapter EH-68P/ EH-68P (AR) or to a computer, the chargeable capacity may decrease when the battery temperature is between 45 to 60 °C (113 to 140 °F). The battery will not charge if its temperature is below 0 °C (32 °F) or above 60 °C (140 °F).
- If an exhausted battery is used at a low temperature, the camera may not turn on. Be sure that the battery is fully charged and spare batteries are prepared before heading outside to take pictures in cold weather. Keep spare batteries in a warm place and exchange as necessary. Once warmed, a cold battery that could not be used temporarily due to lowered performance may recover some of its charge.
- Should the battery terminals become dirty, the camera may not turn on due to poor contact. Wipe the terminals off with a clean, dry cloth before use.
- If the battery will not be used for some time, insert it in the camera and run it flat before removing it for storage. Attach the included terminal cover to the battery and store it in a cool location with an ambient temperature of 15 to 25 °C (59 to 77 °F). Do not store the battery in hot or extremely cold locations.
- While the battery is in storage, charge it at least once every six months and then use the camera to run it flat again before storing it in a cool location.
- Always remove the battery from the camera or battery charger when it is not being used. Left installed, minute amounts of current flow even when unused, and the battery may become excessively drained and no longer function.
- A marked drop in the time a fully-charged battery retains its charge, when used at room temperature, indicates that the battery needs to be replaced. Purchase a new battery.
- Replace the battery when it no longer holds a charge. Used batteries are a valuable resource. Please recycle used batteries in accordance with local regulations.

## Cleaning

<b>Lens</b>	Avoid touching glass parts with your fingers. Remove dust or lint with a blower (typically a small device with a rubber bulb attached to one end that is pumped to produce a stream of air out the other end). To remove fingerprints or other stains that cannot be removed with a blower, wipe the lens with a soft cloth, using a spiral motion that starts at the center of the lens and working toward the edges. If this fails, clean the lens using a cloth lightly dampened with commercial lens cleaner.
<b>Monitor</b>	Remove dust or lint with a blower. To remove fingerprints and other stains, clean the monitor with a soft, dry cloth, being careful not to apply pressure.
<b>Body</b>	Use a blower to remove dust, dirt or sand, then wipe gently with a soft, dry cloth. After using the camera at the beach or seaside, wipe off any sand or salt with a dry cloth lightly dampened with fresh water, then dry thoroughly. Note that foreign matter inside the camera could cause damage not covered by the warranty.

Do not use alcohol, thinner, or other volatile chemicals.

## Storage

Turn the camera off when not in use. Check that the power-on lamp is off before putting the camera away. Remove the battery if the camera will not be used for an extended period. Do not store the camera with naphtha or camphor moth balls, or in any of the following locations:

- Next to equipment that produces strong electromagnetic fields, such as televisions or radios
- Exposed to temperatures below -10 °C (14 °F) or above 50 °C (122 °F)
- Poorly ventilated or subject to humidities of over 60 %

To prevent mold or mildew, take the camera out of storage at least once a month. Turn the camera on and release the shutter a few times before putting the camera away again.



### Notes on the Monitor

- The monitor may contain a few pixels that are always lit or that do not light. This is a characteristic common to all TFT LCD displays, and does not indicate a malfunction. Images recorded using the product will not be affected.
- Images in the monitor may be difficult to see under bright lighting.
- The monitor is lit by an LED backlight. Should the monitor begin to dim or flicker, contact your Nikon-authorized service representative.













### Notes on Smear









White or colored streaks of light may be visible in the monitor with framing of bright subjects. This phenomenon, known as "smear," occurs when extremely bright light strikes the image sensor. This is due to characteristics of the image sensor and does not indicate a malfunction. Smear may also cause partial discoloration in monitor display with shooting.

Smear does not affect recorded images except when shooting with **Continuous** set to **Multi-shot 16** and when recording movies. When shooting in these modes, avoiding bright objects such as the sun, reflections of the sun, and electric lights is recommended.

## Error Messages

















The following table lists the error messages and other warnings displayed in the monitor, as well as the solutions for dealing with them.

Display	Problem	Solution	
 (blinks)	Clock not set.	Set clock.	120
	Battery is running low.	Prepare to charge or change battery.	14, 16
 Battery exhausted.	Battery exhausted.	Charge or replace battery.	14, 16
 Battery temperature high	Battery temperature is high.	Turn off camera, and allow battery to cool down before resuming use. After five seconds, this message will disappear, the monitor will turn off, and the power-on lamp will blink rapidly. After the lamp blinks for three minutes, the camera will turn off automatically, but you can also press the power switch to turn it off manually.	19
 (blinks red)	Camera cannot focus.	<ul style="list-style-type: none"> <li>• Refocus.</li> <li>• Use focus lock.</li> </ul>	28, 29 105
 Please wait for the camera to finish recording.	Camera cannot perform other operations until recording is complete.	Wait until message clears from display automatically when recording is complete.	–
 Memory card is write protected.	Write-protect switch is in "lock" position.	Slide the write-protect switch to "write" position.	23
 This card cannot be used.	Error accessing memory card.	<ul style="list-style-type: none"> <li>• Use an approved card.</li> <li>• Check that connectors are clean.</li> <li>• Confirm that memory card is correctly inserted.</li> </ul>	138 22
 This card cannot be read.			22

Display	Problem	Solution	
 Card is not formatted. Format card? No Yes	Memory card has not been formatted for use in this camera.	All data stored on the memory card will be deleted. If there is any data on the card that you want to keep, select <b>No</b> , and backup the data to a computer before formatting the memory card. To format the memory card, select <b>Yes</b> and press the  button.	23
 Out of memory.	Memory card is full.	<ul style="list-style-type: none"> <li>Choose smaller image mode.</li> <li>Delete unnecessary images.</li> <li>Replace memory card.</li> <li>Remove memory card and use internal memory.</li> </ul>	96 30, 78, 113 22 22
 Image cannot be saved.	Error occurred while recording picture.	Format internal memory or memory card.	129
	Camera has run out of file numbers.	Replace the memory card, or format the internal memory/ memory card.	139
	Picture cannot be used for welcome screen.	The following pictures cannot be used. <ul style="list-style-type: none"> <li>Pictures taken at an <b>Image mode</b> setting of <b>16:9</b></li> <li>Pictures created using the small picture or crop functions that are 320 × 240 or smaller in size</li> </ul>	119
 Sound file cannot be saved.	There is insufficient space to save a copy.	Delete pictures from destination.	113
	The image file cannot have any voice memos attached to it.	<ul style="list-style-type: none"> <li>Choose an image that was taken using this camera.</li> <li>Voice memos cannot be attached onto movies.</li> </ul>	68 –
 A blink was detected in the picture just taken.	Someone may have had their eyes closed when the picture was taken.	Check results in playback mode.	30, 53
 Image cannot be modified.	Cannot edit selected picture.	<ul style="list-style-type: none"> <li>Confirm the conditions that are required for editing.</li> <li>These options cannot be used with movies.</li> </ul>	69 –
 Cannot record movie.	Time out error while recording movie.	Choose memory card with faster write speed.	22

## Error Messages

Display	Problem	Solution																		
<b>i</b> Memory contains no images.	No pictures in the internal memory or memory card.	<ul style="list-style-type: none"> <li>• Pictures stored in the internal memory can only be viewed if no memory card is inserted.</li> <li>• To copy files from internal memory to memory card, press the <b>MENU</b> button to display the <b>Copy</b> screen, then copy the files from internal memory to memory card.</li> </ul>	22 115																	
	No pictures are contained in the folder selected in the auto sort mode.	Select a folder containing the sorted pictures.	64																	
	No pictures can be played back in the auto sort mode.	Play back the pictures using the playback mode or the list by date mode.	65																	
<b>i</b> File contains no image data.	File not created with this camera.	File cannot be viewed on this camera. View file using the computer or any other devices which was used to create or edit this file.	-																	
<b>i</b> This file cannot be played back.				<b>i</b> All images are hidden.	The picture cannot be played back in a slide show.	-	112	<b>i</b> This image cannot be deleted.	Picture is protected.	Disable protection.	113	<b>i</b> Travel destination is in the current time zone.	Destination in same time zone as home.	-	122	Lens error <b>i</b>	Lens error.	Turn camera off and then on again. If error persists, contact retailer or Nikon-authorized service representative.	24	<b>i</b> Communications error
<b>i</b> All images are hidden.	The picture cannot be played back in a slide show.	-	112																	
<b>i</b> This image cannot be deleted.	Picture is protected.	Disable protection.	113																	
<b>i</b> Travel destination is in the current time zone.	Destination in same time zone as home.	-	122																	
Lens error <b>i</b>	Lens error.	Turn camera off and then on again. If error persists, contact retailer or Nikon-authorized service representative.	24																	
<b>i</b> Communications error	Error occurred during communication with printer.	Turn camera off and reconnect cable.	86																	

Display	Problem	Solution	
System error 	Error has occurred in camera's internal circuitry.	Turn camera off, remove and reinsert battery, and turn camera on. If error persists, contact retailer or Nikon-authorized service representative.	14, 19
 Printer error: check printer status.	Printer error.	Check printer. After solving the problem, select <b>Resume</b> and press the  button to resume printing.*	–
 Printer error: check paper	Specified size of paper is not loaded in printer.	Load the specified type of paper, select <b>Resume</b> and press the  button to resume printing.*	–
 Printer error: paper jam	Paper has jammed in the printer.	Remove the jammed paper, select <b>Resume</b> and press the  button to resume printing.*	–
 Printer error: out of paper	No paper is loaded in the printer.	Load the specified type of paper, select <b>Resume</b> and press the  button to resume printing.*	–
 Printer error: check ink	Ink error.	Check ink, select <b>Resume</b> and press the  button to resume printing.*	–
 Printer error: out of ink	Ink cartridge is empty.	Replace ink, select <b>Resume</b> and press the  button to resume printing.*	–
 Printer error: file corrupt	An error caused by the image file has occurred.	Select <b>Cancel</b> and press the  button to cancel printing.	–

\* See the documentation provided with your printer for further guidance and information.

# Troubleshooting

If the camera fails to function as expected, check the list of common problems below before consulting your retailer or Nikon-authorized service representative. Refer to the page numbers in the right-most column for more information.

## Display, Settings and Power Supply

Problem	Cause/Solution	
Monitor is blank.	<ul style="list-style-type: none"><li>• Camera is off.</li><li>• Battery is exhausted.</li><li>• Standby mode for saving power: press the power switch or the shutter-release button.</li><li>• When flash lamp blinks red, flash is charging. Wait until charging has finished.</li></ul>	19 24 13, 19 33
	<ul style="list-style-type: none"><li>• Camera is connected to computer via USB cable.</li><li>• Camera and TV are connected via audio/video cable.</li><li>• The camera cannot be turned on while connected to an electrical outlet via the Charging AC Adapter.</li></ul>	80 79 16
Monitor is hard to read.	<ul style="list-style-type: none"><li>• Adjust monitor brightness.</li><li>• Monitor is dirty. Clean monitor.</li></ul>	123 140
	Camera turns off without warning.	<ul style="list-style-type: none"><li>• Battery is exhausted.</li><li>• Camera has turned off automatically to save power.</li><li>• Battery is cold.</li><li>• The camera turns off if it is connected to the Charging AC Adapter while it is turned on.</li><li>• The camera turns off if the USB cable is disconnected while the camera is connected to a computer or printer. Connect the USB cable again.</li></ul>
Date and time of recording are not correct.		<ul style="list-style-type: none"><li>• Pictures recorded while the clock is not set ("Date not set" indicator blinks during shooting) will have a time stamp of "00/00/0000 00:00"; movies will be dated "01/01/09 00:00." Set the correct date and time using <b>Date</b> in the setup menu. Set the correct date and time using <b>Date</b> in the setup menu.</li><li>• Check camera clock regularly against more accurate timepieces and reset as required.</li></ul>
	No information displayed in monitor.	<b>Hide info</b> is selected for <b>Photo info</b> of the <b>Monitor settings</b> option in the setup menu.
<b>Date imprint</b> not available.	<b>Date</b> has not been set.	20, 120
Date not appearing on pictures even when <b>Date imprint</b> is enabled.	A shooting mode that does not support date imprint is selected.	124











Problem	Cause/Solution	
Camera settings reset.	Backup battery is exhausted; all settings were restored to their default values.	121
Monitor turns off, and the power-on lamp blinks rapidly.	Battery temperature is high. Turn off camera, and allow battery to cool down before resuming use. After the lamp blinks for three minutes, the camera will turn off automatically, but you can also press the power switch to turn it off manually.	19
Battery inserted into the camera is not charged when the camera is connected to a computer.	<ul style="list-style-type: none"> <li>• The battery is not charged when the camera is turned off.</li> <li>• Charging stops if the computer enters sleep mode while the battery is charging. The camera may be turned off.</li> <li>• Depending upon computer specifications, settings, and power supply and allocation, it may be impossible to charge the battery inserted into the camera via computer connection.</li> </ul>	84

## Electronically Controlled Cameras





In extremely rare instances, unusual characters may appear in the monitor and the camera may stop functioning. In most cases, this phenomenon is caused by a strong external static charge. Turn the camera off, remove and replace the battery, then turn the camera on again. In the event of continued malfunction, contact your retailer or Nikon-authorized service representative. Note that disconnecting the power source as described above may result in the loss of any data not recorded to internal memory or the memory card at the time the problem occurred. Data already recorded will not be affected.

## Shooting



Problem	Cause/Solution	
No picture taken when shutter-release button is pressed.	<ul style="list-style-type: none"> <li>When camera is in playback mode, press the  button.</li> <li>When menus are displayed, press the <b>MENU</b> button.</li> <li>Battery is exhausted.</li> <li>When flash lamp blinks red, flash is charging.</li> </ul>	8, 30 12 24 33
Camera cannot focus.	<ul style="list-style-type: none"> <li>The intended subject is one with which autofocus does not perform well.</li> <li>Set <b>AF assist</b> in the setup menu to <b>Auto</b>.</li> <li>Turn camera off and then on again.</li> </ul>	29 127 19
Pictures are blurred.	<ul style="list-style-type: none"> <li>Use flash.</li> <li>Use vibration reduction and motion detection.</li> <li>Use <b>BSS</b> (Best Shot Selector).</li> <li>Use a tripod to stabilize the camera (use with the self-timer for best results).</li> </ul>	32 125, 126 101 34
Streaks of light or partial discoloration appear in the display.	Smear may occur when the lens is aimed at bright subjects. When using the multi-shot 16 shooting and movie modes, we recommend that you avoid shooting when direct sunlight, reflected sunlight, or electric lights are in the display.	102, 143
Bright specks appear in pictures shot using flash.	Flash is reflecting off particles in air. Turn flash  (off).	33
Flash does not fire.	<ul style="list-style-type: none"> <li>Flash is  (off).</li> <li>Some scene modes that cannot turn on flash are selected.</li> <li>Smart portrait mode selected, with <b>Blink proof</b> set to <b>On</b>.</li> <li> mode is selected.</li> <li>Another function that is set now is restricting the flash.</li> </ul>	32 38 53 76 109

Problem	Cause/Solution	
Optical zoom cannot be used.	Optical zoom cannot be used while recording movies.	76
Digital zoom cannot be used.	<ul style="list-style-type: none"> <li>• <b>Digital zoom</b> is set to <b>Off</b> in the setup menu.</li> <li>• Digital zoom cannot be used in the following situations.                             <ul style="list-style-type: none"> <li>- When <b>Scene auto selector, Portrait</b> or <b>Night portrait</b> is selected for scene mode</li> <li>- When subject tracking mode is selected</li> <li>- When smart portrait mode is selected</li> <li>- When <b>Multi-shot 16</b> is selected for <b>Continuous</b></li> <li>- Before movie recording begins (digital zoom of up to 2x can be applied while movies are being recorded)</li> </ul> </li> </ul>	127 38, 39, 45 54 51 101 76
<b>Image mode</b> not available.	Another function that is set now is restricting <b>Image mode</b> .	109
No sound when shutter is released.	<ul style="list-style-type: none"> <li>• <b>Off</b> is selected for <b>Shutter sound</b> of the <b>Sound settings</b> option in the setup menu.</li> <li>• <b>Continuous, BSS, or Multi-shot 16</b> is selected for <b>Continuous</b> in shooting menu.</li> <li>• When <b>Sports, or Museum</b> is selected in scene mode.</li> <li>• <b>Blink proof</b> is set to <b>On</b> for smart portrait mode.</li> <li>•  mode is selected.</li> <li>• Do not block the speaker.</li> </ul>	128 101 39, 42 52 76 4, 26
AF-assist illuminator does not light.	<ul style="list-style-type: none"> <li>• <b>Off</b> is selected for <b>AF assist</b> in the setup menu.</li> <li>• AF-assist illuminator turns off automatically in some scene modes.</li> </ul>	127 38 – 43
Pictures appear smeared.	Lens is dirty. Clean lens.	140
Colors are unnatural.	White balance does not match light source.	98
Randomly spaced bright pixels (“noise”) appear in image.	The subject is dark, so shutter speed is too slow or ISO sensitivity is too high. Noise can be reduced by: <ul style="list-style-type: none"> <li>• Use flash.</li> <li>• Specifying a lower ISO sensitivity setting.</li> <li>• Using a scene mode which has noise reduction ability.</li> </ul>	32 102 38
Pictures are too dark (underexposed).	<ul style="list-style-type: none"> <li>• Flash is  (off).</li> <li>• Flash window is blocked.</li> <li>• Subject is beyond flash range.</li> <li>• Adjust exposure compensation.</li> <li>• Raise the ISO sensitivity.</li> <li>• Subject is backlit. Use <b>Backlight</b> or change the flash mode to .</li> </ul>	32 26 32 36 102 32, 43
Pictures are too bright (overexposed).	Adjust exposure compensation.	36

## Troubleshooting

Problem	Cause/Solution	
Unexpected results occurred when flash is set to auto with red-eye reduction.	When  (auto with red-eye reduction) or “fill flash with slow sync and red-eye reduction” of the <b>Night portrait</b> scene mode is applied during shooting, In-Camera Red-Eye Fix may, in very rare cases, be applied to areas not affected by red-eye. Set a flash mode other than  (auto with red-eye reduction) and select a scene mode other than <b>Night portrait</b> , then shoot.	32, 39
Skin softening results are not as expected.	<ul style="list-style-type: none"> <li>• Skin softening may not produce the desired results depending on shooting conditions.</li> <li>• For pictures with four or more faces, try using <b>Skin softening</b> in the playback menu.</li> </ul>	53 73
Saving images takes time.	<p>It may take more time to save images in the following situations.</p> <ul style="list-style-type: none"> <li>• When the noise reduction function is in operation</li> <li>• When flash is set to  (auto with red-eye reduction)</li> <li>• When using skin softening while shooting</li> </ul>	33, 38 33 38, 39, 52

## Playback

Problem	Cause/Solution	
File cannot be played back.	File was overwritten or renamed by computer or another make or model of camera.	–
Cannot zoom in on picture.	Playback zoom cannot be used with movies, small pictures, or cropped copies smaller than 320 × 240 pixels.	–
Cannot record voice memo.	<ul style="list-style-type: none"> <li>• Voice memos cannot be attached to movies.</li> <li>• Voice memos cannot be attached to pictures taken by other cameras. Voice memos that are attached to the picture using other cameras cannot be played back on this camera.</li> </ul>	78 67
Cannot use quick retouch, D-Lighting, skin softening, small picture, or crop options	<ul style="list-style-type: none"> <li>• These options cannot be used with movies.</li> <li>• These options cannot be used with pictures taken when  <b>16:9 (3968)</b> is applied in the <b>Image mode</b> setting.</li> <li>• Select pictures that support quick retouch, D-Lighting, skin softening, small picture, or crop.</li> <li>• Pictures taken with another make or model of camera cannot be edited.</li> <li>• Other cameras may be unable to play back, or transfer to a computer, pictures edited with this camera.</li> </ul>	78 96 69 69 69

Problem	Cause/Solution	
Pictures not displayed on television.	<ul style="list-style-type: none"> <li>• The <b>Video mode</b> setting in setup menu has not been set correctly.</li> </ul>	130
	<ul style="list-style-type: none"> <li>• Memory card contains no pictures. Replace memory card. Remove memory card to play back pictures from internal memory.</li> </ul>	22
The recorded pictures are not displayed in auto sort mode.	<ul style="list-style-type: none"> <li>• The picture you want to display is sorted in another folder.</li> </ul>	64
	<ul style="list-style-type: none"> <li>• Pictures recorded by another camera, and pictures copied using <b>Copy</b> on another camera cannot be displayed in the auto sort mode.</li> </ul>	115
	<ul style="list-style-type: none"> <li>• Pictures in the internal memory or memory card may not be displayed if overwritten on a computer.</li> </ul>	–
	<ul style="list-style-type: none"> <li>• Up to 999 images can be added to each folder in the auto sort mode. If the desired folder already contains 999 pictures, new pictures cannot be added.</li> </ul>	65
Nikon Transfer does not start when camera is connected.	<ul style="list-style-type: none"> <li>• Camera is off.</li> </ul>	19
	<ul style="list-style-type: none"> <li>• Battery is exhausted.</li> </ul>	24
	<ul style="list-style-type: none"> <li>• USB cable is not correctly connected.</li> </ul>	81
	<ul style="list-style-type: none"> <li>• Camera is not recognized by the computer.</li> </ul>	–
	<ul style="list-style-type: none"> <li>• Confirm that the operating system used is compatible with the camera.</li> </ul>	80
	<ul style="list-style-type: none"> <li>• Computer is not set to launch Nikon Transfer automatically. For more information on Nikon Transfer, refer to help information contained in Nikon Transfer.</li> </ul>	83
The PictBridge startup screen is not displayed when the camera is connected to a printer.	With some PictBridge-compatible printers, the PictBridge startup screen may not be displayed and it may be impossible to print pictures when <b>Auto</b> is selected for the <b>Charge by computer</b> option in the setup menu. Set the <b>Charge by computer</b> option to <b>Off</b> and reconnect the camera to the printer.	131
Pictures to be printed are not displayed.	<ul style="list-style-type: none"> <li>• Memory card contains no pictures. Replace memory card.</li> <li>• Remove memory card to print pictures from internal memory.</li> </ul>	22
Cannot select paper size with camera.	Paper size cannot be selected from the camera in the following situations, even for PictBridge compatible printers. Use the printer to select page size.	88, 89
	<ul style="list-style-type: none"> <li>• The page size selected using the camera is not compatible with the printer.</li> </ul>	–
	<ul style="list-style-type: none"> <li>• A printer that automatically sets the paper size is being used.</li> </ul>	–

# Specifications

## Nikon COOLPIX S640 Digital Camera

Type	Compact digital camera
Effective pixels	12.2 million
Image sensor	<sup>1</sup> /2.33-in. CCD; approx. 12.39 million total pixels
Lens	5× optical zoom, NIKKOR lens
Focal length	5.0-25.0mm (equivalent with 35mm [135] format picture angle: 28-140mm)
f/-number	f/2.7-6.6
Construction	7 elements in 6 groups
Digital zoom	Up to 4× (equivalent with 35mm [135] format picture angle: approx. 560mm)
Vibration reduction	Lens shift
Autofocus (AF)	Contrast-detect AF
Focus range (from lens)	<ul style="list-style-type: none"><li>• [W]: Approx. 45 cm (1 ft. 6 in.) to ∞, [T]: Approx. 70 cm (2 ft. 4 in.) to ∞</li><li>• Macro mode: Approx. 2 cm (0.8 in.) to ∞ (wide-end zoom position)</li></ul>
Focus-area selection	Face priority, auto (9-area automatic selection), manual with 99 focus areas, center
Monitor	2.7-in., approx. 230k-dot, wide viewing angle TFT LCD with anti-reflection coating and 5-level brightness adjustment
Frame coverage (shooting mode)	Approx. 100% horizontal and 100% vertical
Frame coverage (playback mode)	Approx. 100% horizontal and 100% vertical
Storage	
Media	Internal memory (approx. 45 MB), SD (Secure Digital) memory cards
File system	DCF, Exif 2.2, and DPOF compliant
File formats	Still pictures: JPEG Movies: AVI (Motion-JPEG compliant) Sound files: WAV
Image size (pixels)	<ul style="list-style-type: none"><li>• 4000×3000 <b>High (4000★)/Normal (4000)</b></li><li>• 3264×2448 <b>Normal (3264)</b></li><li>• 2592×1944 <b>Normal (2592)</b></li><li>• 2048×1536 <b>Normal (2048)</b></li><li>• 1024×768 <b>PC screen (1024)</b></li><li>• 640×480 <b>TV screen (640)</b></li><li>• 3968×2232 <b>16:9 (3968)</b></li></ul>
ISO sensitivity (Standard output sensitivity)	<ul style="list-style-type: none"><li>• ISO 100, 200, 400, 800, 1600, 3200, 6400</li><li>• Auto (auto gain from ISO 100 to 1600)</li><li>• Fixed range auto (ISO 100 to 400, 100 to 800)</li></ul>

<b>Exposure</b>	
Metering	224-segment matrix, center-weighted
Exposure control	Programmed auto exposure with motion detection and exposure compensation (–2.0 to +2.0 EV in steps of $\frac{1}{3}$ EV)
Range (ISO 100)	[W]: –1.1 to +15.4 EV [T]: 1.6 to 18.1 EV
<b>Shutter</b>	
Speed	Mechanical and charge-coupled electronic shutter <ul style="list-style-type: none"> <li>• <math>\frac{1}{1500}</math>-8 s (when <b>ISO sensitivity</b> is set to 100, 200, 400)</li> <li>• <math>\frac{1}{1500}</math>-2 s (when <b>ISO sensitivity</b> is set to 800)</li> <li>• <math>\frac{1}{1500}</math>-1 s (when <b>ISO sensitivity</b> is set to <b>Auto</b>, 1600, 3200)</li> <li>• <math>\frac{1}{1500}</math>-<math>\frac{1}{2}</math> s (when <b>ISO sensitivity</b> is set to 6400)</li> <li>• 4 s (<b>Fireworks show</b> scene mode)</li> </ul>
<b>Aperture</b>	
Range	Electronically-controlled ND filter (–2 AV) selection 2 steps (f/2.7 and f/5.4 [W])
Self-timer	Can be selected from 10 and 2 seconds duration
<b>Built-in flash</b>	
Range (approx.) (ISO sensitivity: <b>Auto</b> )	[W]: 0.5 to 8.0 m (1 ft. 8 in. to 26 ft.) [T]: 0.5 to 4.0 m (1 ft. 8 in. to 13 ft.)
Flash control	TTL auto flash with monitor preflashes
<b>Interface</b>	
Data transfer protocol	Hi-Speed USB MTP, PTP
Video output	Can be selected from NTSC and PAL
I/O terminal	Audio/video output; digital I/O
Supported languages	Arabic, Chinese (Simplified and Traditional), Czech, Danish, Dutch, English, Finnish, French, German, Greek, Hungarian, Indonesian, Italian, Japanese, Korean, Norwegian, Polish, Portuguese, Russian, Spanish, Swedish, Thai, Turkish
Power sources	One Rechargeable Li-ion Battery EN-EL12 (supplied) AC Adapter EH-62F (optional)
Charging time	Approx. 4 hours (when using Charging AC Adapter EH-68P/EH-68P (AR) and when no charge remains)
Battery life*	Approx. 270 shots (EN-EL12)
Dimensions (W × H × D)	Approx. 91 × 55 × 20.5 mm (3.6 × 2.2 × 0.8 in.) (excluding projections)
Weight	Approx. 110 g (4.0 oz) (without battery and SD memory card)
<b>Operating environment</b>	
Temperature	0 to 40 °C (32 to 104 °F)
Humidity	Less than 85 % (no condensation)

## Specifications

- Unless otherwise stated, all figures are for a camera with a fully-charged Rechargeable Li-ion Battery EN-EL12 operated at an ambient temperature of 25 °C (77 °F).
- \* Based on Camera and Imaging Products Association (CIPA) standards for measuring the life of camera batteries. Measured at 23 (±2) °C (73 (±4) °F); zoom adjusted with each shot, flash fired with every other shot, image mode set to **12m Normal (4000)**. Battery life may vary depending on shooting interval and length of time menus and images are displayed.

### Rechargeable Li-ion Battery EN-EL12

Type	Rechargeable lithium-ion battery
Rated capacity	DC 3.7 V, 1050 mAh
Operating temperature	0 to 40 °C (32 to 104 °F)
Dimensions (W × H × D)	Approx. 32 × 43.8 × 7.9 mm (1.3 × 1.7 × 0.3 in.)
Weight	Approx. 22.5 g (0.8 oz) (excluding terminal cover)

### Charging AC Adapter EH-68P/EH-68P (AR)

Rated input	AC 100-240 V, 50/60 Hz, 0.065-0.04 A
Rated capacity	6.5–9.6 VA
Rated output	DC 5.0 V, 0.5 A
Operating temperature	0 to 40 °C (32 to 104 °F)
Dimensions (W × H × D)	EH-68P: Approx. 55 × 22 × 65 mm (2.7 × 0.9 × 2.6 in.) EH-68P (AR): Approx. 55 × 51.6 × 66 mm (2.2 × 2.0 × 2.6 in.)
Weight	EH-68P: Approx. 60g (2.1 oz) EH-68P (AR): 65 g (2.3 oz)

## Specifications

- Nikon will not be held liable for any errors this manual may contain.
- The appearance of this product and its specifications are subject to change without notice.



## Supported Standards

- **DCF:** Design Rule for Camera File System is a standard widely used in the digital camera industry to ensure compatibility among different makes of camera.
- **DPOF:** Digital Print Order Format is an industry-wide standard that allows pictures to be printed from print orders stored on the memory card.
- **Exif version 2.2:** This camera supports Exif (Exchangeable Image File Format for Digital Still Cameras) version 2.2, a standard that allows information stored with photographs to be used for optimal color reproduction when images are output from Exif-compliant printers.
- **PictBridge:** A standard developed cooperatively by the digital camera and printer industries, allowing photographs to be output directly to a printer without connecting the camera to a computer.

# Index

## Symbols

AE/AF-L 50

Apply selection button 10

Auto mode 24

Auto sort mode 64

Delete button 30, 31, 68, 78

Exposure compensation 36

Flash mode 32

Help 13

List by date mode 61

Macro mode 35

**MENU** Menu button 12

Movie mode 76

Playback button 9, 30

Playback mode 30

Playback zoom 60

Scene mode 37

Self timer 34

Setup menu 116

Shooting mode button 8

Smart portrait mode 51

Subject tracking mode 54

**T** Tele 27

Thumbnail Playback 57, 59

**W** Wide 27

.AVI 139

.JPG 139

.WAV 139

## A

AC adapter 137

AF area mode 104

AF assist 127

Aperture 28

Audio/video cable 79, 137

Audio/video-in jack 79

Auto 32

Auto mode 24

Auto off 128

Auto sort mode 64

Autofocus 55, 77, 108

Autofocus mode 56, 77, 108

AV cable 79, 137

## B

Backlight 43

Battery 14, 16, 121

Battery chamber 5

Battery charger 18, 137

Battery latch 14

Battery level indicator 24

Battery-chamber/memory card slot cover 14, 22

Beach/snow 40

Best shot selector 101

Black-and-white 103

Blink proof 53

Blink warning 132, 133

BSS 101

Built-in flash 32

Button sound 128

## C

Cable connector 79, 80, 85

Calendar display 59

Center-weighted 100

Charge by computer 131

Charge lamp 17

Charger 16, 137

Charging AC Adapter 16, 137

Close-up 42

Color options 103

Compression ratio 96

Computer 80

Connector cover 5

Continuous 101

Copy 43

Crop 75







Cyanotype 103

## D

Date 20, 120

Date imprint 124

Daylight saving time 20, 121



- Delete 30, 68, 78, 113
- Digital zoom 27, 127
- D-Lighting 72
- DPOF 157
- DPOF print 91
- DSCN 139
- Dusk/dawn  41
- E**
- EH-68P/EH-68P (AR) 16
- EN-EL12 16
- Exposure compensation 36
- Extension 139
- Eyelet for camera strap 5
- E**
- Face priority 104
- Face priority tracking 56
- File name 139
- Fill flash 32
- Fireworks show  43
- Firmware version 136
- Fixed range auto 102
- Flash lamp 33
- Flash mode 32, 33
- Flash off 32
- Focus 28, 77, 104
- Focus indicator 6, 28
- Focus lock 105
- Folder name 139
- Food  42, 47
- Format 23, 129
- Format the internal memory 129
- Formatting 23, 129
- FSCN 139
- Full-frame playback 30, 31
- Full-time AF 77, 108
- H**
- Help 13
- Histogram 10, 36
- I**
- Identifier 139
- Image copy 115
- Image mode 96, 97
- Image size 96
- Internal memory 22
- Internal memory indicator 25
- ISO sensitivity 33, 102
- L**
- Lamp indicator 5
- Landscape  38
- Language 130
- Lens 4, 154
- Lens cover 4
- Li-ion rechargeable battery 14
- List by date menu 63
- List by date mode 61
- Lithium-ion type battery 16, 137
- M**
- Macro mode 35
- Matrix 100
- Memory capacity 24
- Memory card 22, 138
- Memory card slot 22
- Menus 118
- Metering 100
- Microphone 4
- Monitor 6, 142
- Monitor brightness 123
- Monitor display settings 123
- Monitor settings 123
- Motion detection 25, 126
- Movie length 77
- Movie menu 77
- Movie mode 76
- Movie playback 78
- Movie recording 76
- Movie settings 77
- Multi-shot 16 101
- Museum  42
- N**
- Night landscape  41

Night portrait  39  
 Nikon Transfer 80, 81  
 Number of exposures remaining 24, 97

**O**

Optical zoom 27  
 Optional accessories 137

**P**

Panorama assist  44, 49  
 Panorama Maker 80, 83  
 Paper size 88, 89  
 Party/indoor  40  
 PictBridge 85, 157  
 Playback 30, 57, 59, 60, 68, 78  
 Playback menu 110  
 Playback mode 30  
 Playback zoom 60  
 Playback-mode selection menu 9  
 Portrait  38  
 Power 19, 20, 24  
 Power switch 19, 20, 24  
 Preset manual 99  
 Press halfway 13  
 Print 88, 89, 92  
 Print set 92  
 Print Set Date Option 93, 94  
 Printer 85  
 Protect 113

**Q**



Quick retouch 71

**R**

Rechargeable battery 137  
 Red-eye reduction 32, 33  
 Reset all 134  
 Rotary multi selector 20  
 Rotate image 114  
 RSCN 139

**S**

Scene auto selector  38, 45  
 Scene mode 37, 38  
 Self-timer 34

Self-timer lamp 34, 51  
 Sepia 103  
 Setup menu 116  
 Shooting 24, 26, 28  
 Shooting info 10  
 Shooting menu 95  
 Shooting with Face Priority 106  
 Shooting-mode selection menu 8  
 Shutter button 13, 28  
 Shutter sound 128  
 Shutter speed 28  
 Single 101  
 Single AF 77, 108  
 Skin softening 52  
 Slide show 112  
 Slow sync 32  
 Small picture 74  
 Small size 77  
 Smart portrait menu 52  
 Smart portrait mode 51  
 Smile timer 53  
 Software Suite 80  
 Sound settings 128  
 Speaker 4  
 Sports  39  
 SSCN 139  
 Standard color 103  
 Strap 13  
 Subject Tracking Menu 56  
 Subject tracking mode 54  
 Sunset  40

**T**

Tele 27  
 Television 79  
 Thumbnail display 57  
 Time difference 122  
 Time zone 120, 122  
 Tripod socket 5  
 TV Movie 77

**U**

USB cable 81, 86, 137

**V**

Vibration reduction 25, 125

Video mode 130

ViewNX 82

Vivid color 103

Voice memo 67

Volume 68, 78

**W**

Welcome screen 119

White balance 98

Wide 27

**Z**

Zoom control 27



A series of horizontal dashed lines spanning the width of the page, intended for handwriting practice.



# ***Nikon***

No reproduction in any form of this manual, in whole or in part (except for brief quotation in critical articles or reviews), may be made without written authorization from NIKON CORPORATION.



**NIKON CORPORATION**

Fuji Bldg., 2-3 Marunouchi 3-chome,  
Chiyoda-ku, Tokyo 100-8331, Japan

© 2009 Nikon Corporation

Printed in Europe  
CT9G01(11)  
6MM70511-01