

# OLYMPUS®

<http://www.olympus.com/>

## OLYMPUS IMAGING EUROPA GMBH

Premises: Wendenstrasse 14 – 18, 20097 Hamburg, Germany  
Tel.: +49 40 - 23 77 3-0 / Fax: +49 40 - 23 07 61  
Goods delivery: Bredowstrasse 20, 22113 Hamburg, Germany  
Letters: Postfach 10 49 08, 20034 Hamburg, Germany

### European Technical Customer Support:

Please visit our homepage <http://www.olympus-europa.com>  
or call our TOLL FREE NUMBER\*: **00800 - 67 10 83 00**

for Austria, Belgium, Denmark, Finland, France, Germany, Luxemburg, Netherlands,  
Norway, Portugal, Spain, Sweden, Switzerland, United Kingdom.

\* Please note some (mobile) phone services / provider do not permit access or request an  
additional prefix to +800 numbers.

For all not listed European Countries and in case that you can't get connected  
to the above mentioned number please make use of the following

CHARGED NUMBERS: **+49 180 5 - 67 10 83** or **+49 40 - 237 73 48 99**.

Our Technical Customer Support is available from 9 am to 6 pm MET (Monday to Friday).

### Authorized Distributors

**United Kingdom: Olympus Service Department**    **South Africa: City Square Trading 197 (PTY) Ltd.**  
/ Eire    P.O. Box 222    Unit A, The Meadows  
Southall Middlesex UB2 4SH    Meadowbrooke Business Estate  
Tel.: (0207) 2530513    Jacaranda Avenue, Olivedale Ext. 17  
Johannesburg,  
Tel.: +27 11 7042021

**Egypt: Optoscient M. Nagui & Co**  
10. 26th July St., Cairo  
Tel.: +20 2 391 4883

© 2009 OLYMPUS IMAGING CORP.

Printed in Germany · OIME · 12/2008 · Hab. · E0462050

E-30

INSTRUCTION MANUAL

## DIGITAL CAMERA

# E-30

# INSTRUCTION MANUAL

# OLYMPUS®

**Basic guide**

**P. 2**

Review the camera part names, the  
basic steps for shooting and playback,  
and the basic operations.

**Table of Contents**

**P. 24**

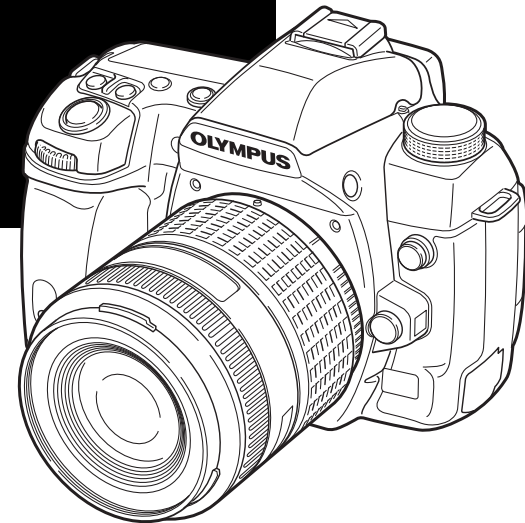

EN

OLYMPUS

- Thank you for purchasing an Olympus digital camera. Before you start to use your new camera, please read these instructions carefully to enjoy optimum performance and a longer service life. Keep this manual in a safe place for future reference.
- We recommend that you take test shots to get accustomed to your camera before taking important photographs.
- The screen and camera illustrations shown in this manual were produced during the development stages and may differ from the actual product.
- The contents in this manual are based on firmware version 1.0 for this camera. If there are addition and/or modification of functions due to firmware update for the camera, the contents will differ. For the latest information, please visit the Olympus website.

# Camera

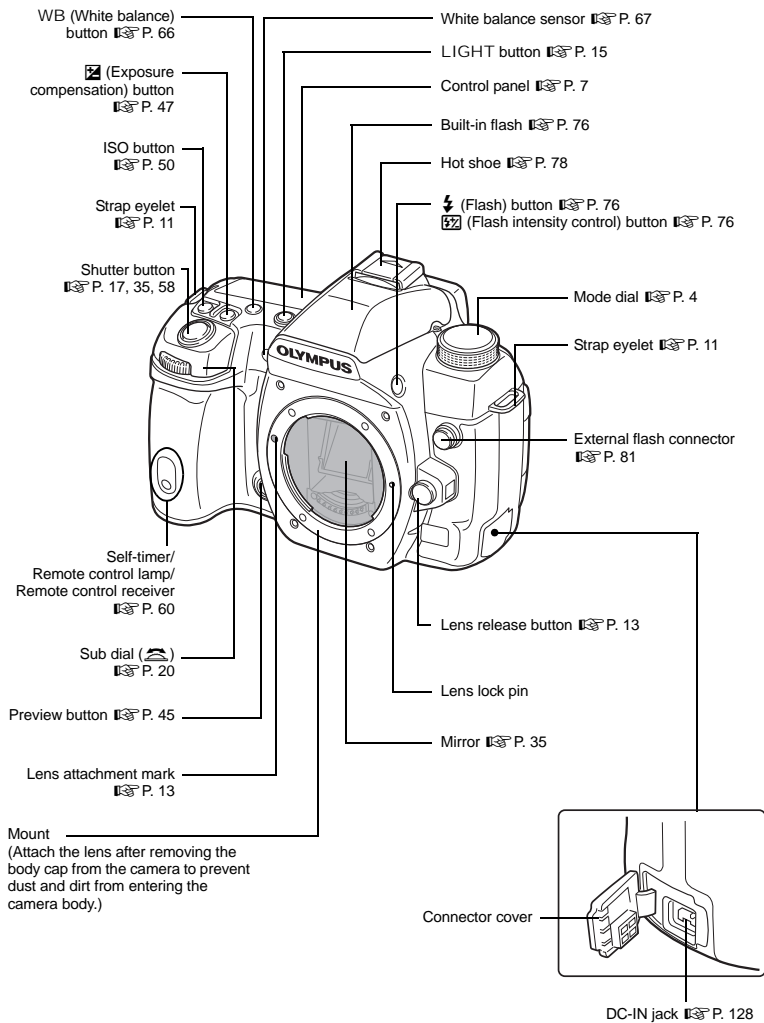

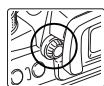

Diopter adjustment dial  
 P. 15

(Metering) button  
 P. 46  
 (Remote control/Self-timer/Sequential shooting) button  
 P. 59-60

AF button P. 53  
 COPY/ (Copy/Print) button  
 P. 90, 112

INFO (Information display) button  
 P. 22, 39, 85

(Erase) button  
 P. 92

Tripod socket

MENU button P. 23

(Live view) button  
 P. 34

IS (Image stabilizer) button  
 P. 62

Power switch  
 P. 15

SSWF indicator  
 P. 15, 125

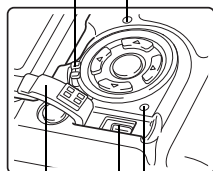

Battery compartment lock  
 P. 12

Eye cup P. 60

Viewfinder P. 6

LCD monitor P. 9, 10, 36

Main dial P. 20

AEL/AFL button  
 P. 35, 48, 95  
 (Protect) button  
 P. 91

Fn button P. 96

(AF target) button  
 P. 55

(Playback) button  
 P. 19, 82

button P. 23

Arrow pad P. 23

Battery compartment cover  
 P. 12

Card cover  
 P. 14

CF card slot P. 14

xD-Picture Card slot P. 14

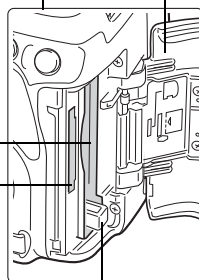

Card access lamp P. 14, 17, 118

Multi-connector P. 87, 113, 117

Connector cover

Eject button  
 P. 14

## Mode dial

The mode dial allows you to change the camera settings easily according to the subject.

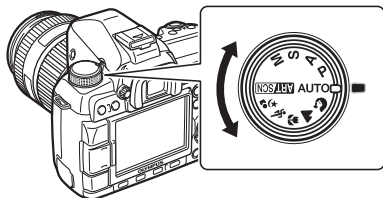







### Advanced shooting modes

- For more advanced shooting and greater creative control, you can set the aperture value and shutter speed.
- The settings made in the advanced shooting modes are retained even if the camera is turned off.

<b>P</b>	Program shooting	Allows you to shoot using an aperture and shutter speed that the camera sets. (P. 42)
<b>A</b>	Aperture priority shooting	Allows you to set the aperture manually. The camera sets the shutter speed automatically. (P. 42)
<b>S</b>	Shutter priority shooting	Allows you to set the shutter speed manually. The camera sets the aperture automatically. (P. 43)
<b>M</b>	Manual shooting	Allows you to set the aperture and shutter speed manually. (P. 44)

### Easy shooting modes

- Select according to the shooting scene. The camera sets the appropriate shooting conditions automatically.
- When rotating the mode dial or turning off the power in the easy shooting modes, functions with changes made to their settings are restored to the factory default settings.

AUTO	AUTO	Allows you to shoot using an optimum aperture and shutter speed that the camera sets. The built-in flash pops up automatically in low-light conditions.
	PORTRAIT	Suitable for shooting a portrait-style image of a person.
	LANDSCAPE	Suitable for shooting landscapes and other outdoor scenes.
	MACRO	Suitable for taking close-up pictures.
	SPORT	Suitable for capturing fast-moving action without blurring.
	NIGHT+PORTRAIT	Suitable for shooting both the main subject and background at night.
	Art filter/Scene	When you select a desired filter or scene, the camera optimizes the shooting conditions for that filter or scene. Most of the functions cannot be changed.

## Setting the art filter/scene

- Set the mode dial to **ART/SCN**.
  - The art filter menu is displayed. Press to display the scene menu.

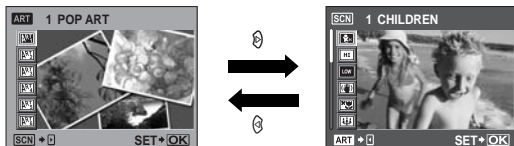

- Use to select the filter or scene.
- Press the button.
  - To change the setting, press the button again to display the menu.

### Types of art filters

Icon	Art filter	Icon	Art filter
	POP ART		LIGHT TONE
	SOFT FOCUS		GRAINY FILM
	PALE&LIGHT COLOR		PIN HOLE

### Types of scene modes

Icon	Mode	Icon	Mode
	CHILDREN		SUNSET
	HIGH KEY		DOCUMENTS
	LOW KEY		PANORAMA
	DIS MODE		FIREWORKS
	NATURE MACRO		BEACH & SNOW
	CANDLE		

- Art filters are not applied to RAW images.
- If the record mode is set to **[RAW]** and art filter is applied, the record mode is automatically set to **[N+RAW]**.
- The grainy appearance of the picture may be emphasized depending on the type of art filter.

# Viewfinder

AF target  P. 55

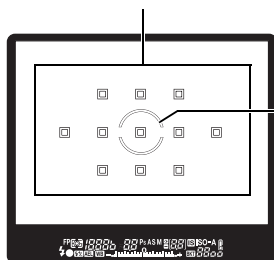

Spot metering area  P. 46

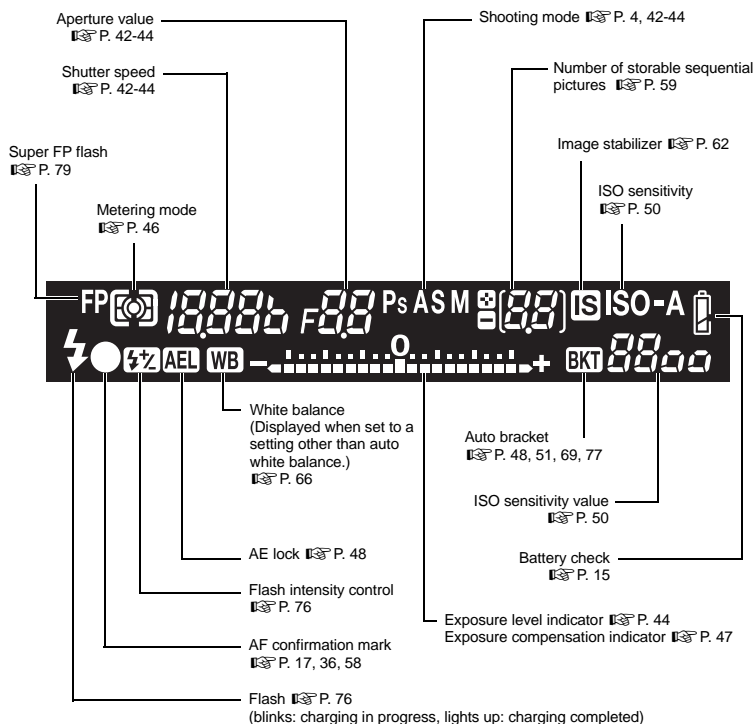

# Control panel

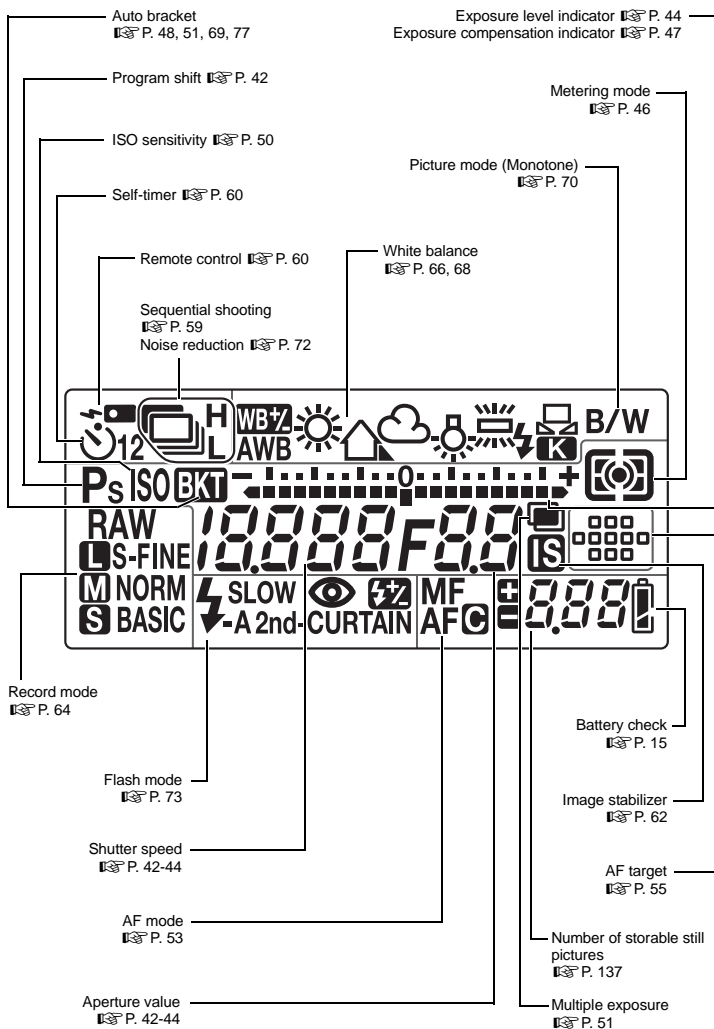

# Super control panel

The following screen allows the display and setting of shooting settings at the same time and is called the super control panel. Press the INFO button to display the super control panel on the LCD monitor.

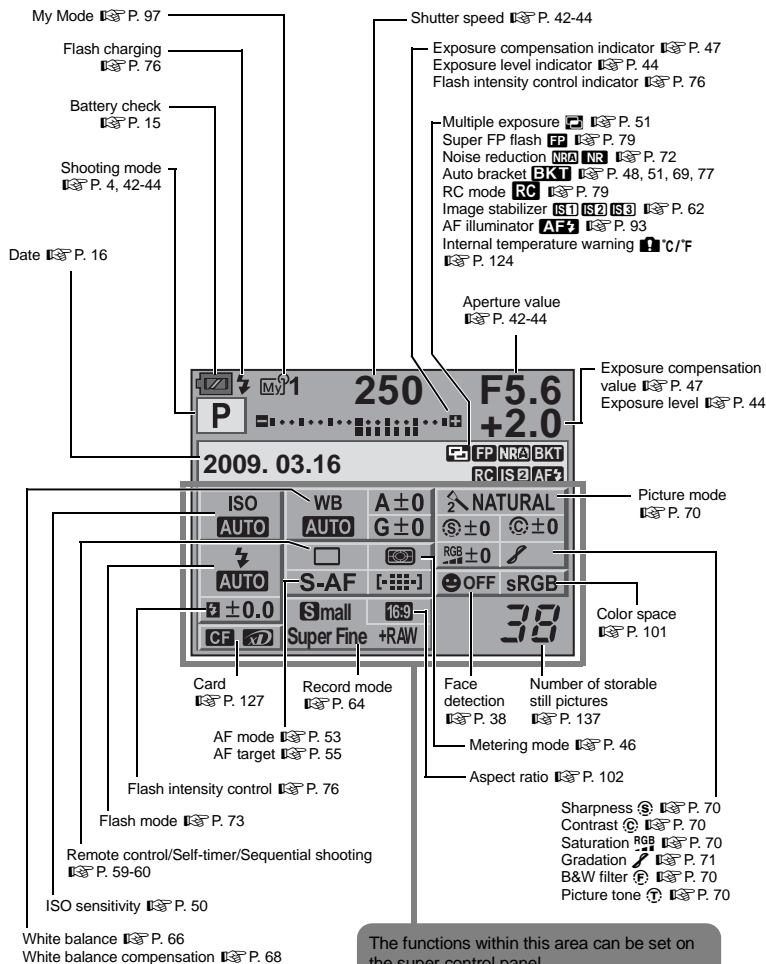

☞ "Setting while looking at the super control panel" (P. 22)



The functions within this area can be set on the super control panel.



# LCD monitor (Live view)

You can use the LCD monitor to view the subject while shooting. Press the  button to use live view.  
 "Using live view" (P. 34)

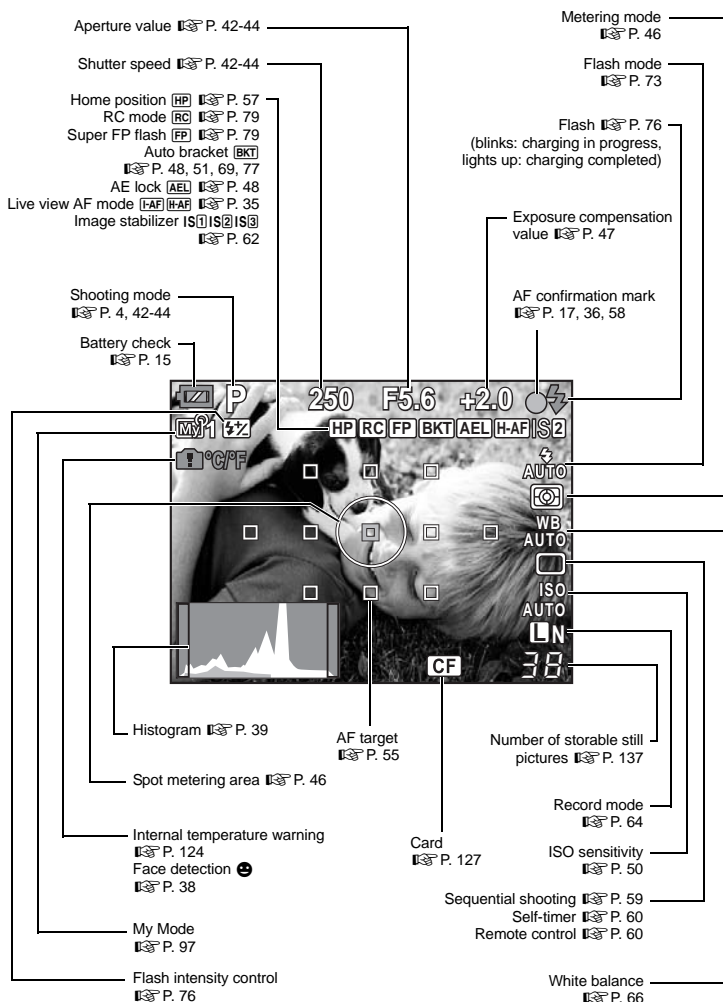

# LCD monitor (Playback)

You can switch the monitor display using the INFO button.

"Information display" (P. 85)

Battery check P. 15

Record mode P. 64

Flash intensity control P. 76

Pixel count, compression rate P. 64

ISO sensitivity P. 50

Exposure compensation P. 47

Selection check mark P. 90, 91, 92

Shooting mode P. 4, 42-44

Protect P. 91

Aperture value P. 42-44

Print reservation  
Number of prints P. 110

Focal length P. 129  
(The focal length is displayed  
in 1 mm units.)

Aspect border P. 102

Shutter speed P. 42-44



Aspect ratio P. 88, 102

Card P. 127

Frame number

File number

Date and time P. 16

AF target P. 55

Histogram P. 85

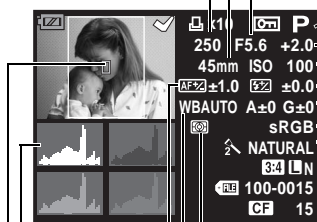

AF adjustment P. 105

Metering mode P. 46

White balance P. 66

Picture mode P. 70

Color space P. 101

White balance compensation P. 68

# Unpack the box contents

The following items are included with the camera.

If anything is missing or damaged, contact the dealer from whom you purchased the camera.



Camera



Body cap



Strap

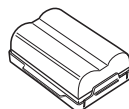

BLM-1 Lithium ion battery

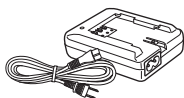

BCM-2 Lithium ion charger

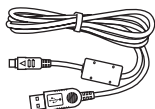

USB cable

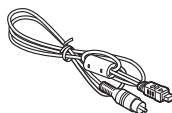

Video cable

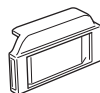

Eyepiece cover

- OLYMPUS Master 2 CD-ROM
- Instruction manual
- Warranty card

## Attaching the strap



Thread the eyepiece cover through one end of the strap. Thread the strap as indicated by the arrows.

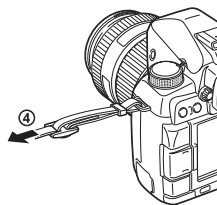
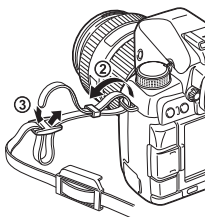

Lastly, pull the strap tight making sure that it is fastened securely.

- Attach the other end of the strap to the other eyelet in the same way.

# Preparing the battery

## 1 Charging the battery

Charging indicator  
Red light: Charging in progress  
Green light: Charging completed  
(Charging time: Approx. 5 hours)

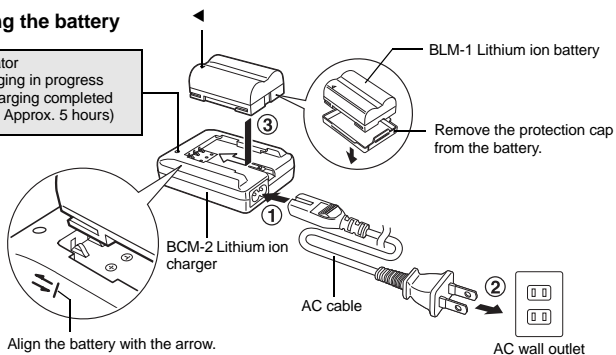

## 2 Loading the battery

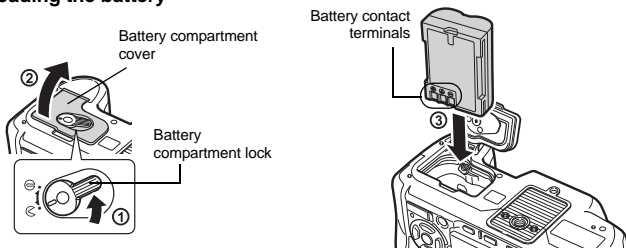

## 3 Close the battery compartment cover and slide the battery compartment lock in the direction of ⊖

### Unloading the battery

Press the battery lock to unlock the battery. Turn the camera upside-down to remove the battery.

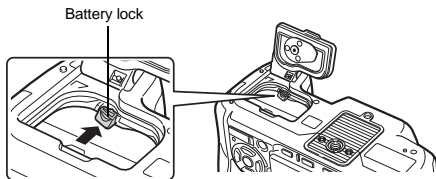

It is recommended to set aside a backup battery for prolonged shooting in case the battery in use drains.

# Attaching a lens to the camera

- 1 Remove the body cap from the camera and the rear cap from the lens

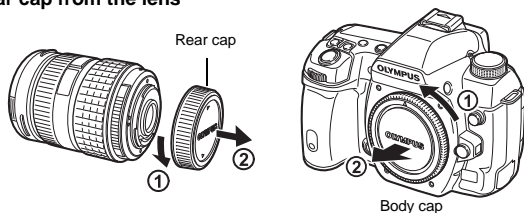

## 2 Attach a lens to the camera

- Align the lens attachment mark (red) on the camera with the alignment mark (red) on the lens, then insert the lens into the camera's body (1).
- Rotate the lens in the direction indicated by the arrow until you hear it click (2).

- Make sure the power switch is set to OFF.
- Do not press the lens release button.

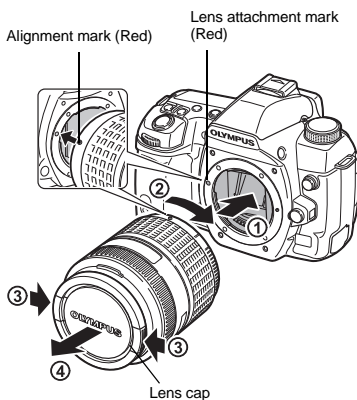

## 3 Remove the lens cap (3, 4)

### Removing the lens from the camera

While pressing the lens release button (1), rotate the lens in the direction of the arrow (2).

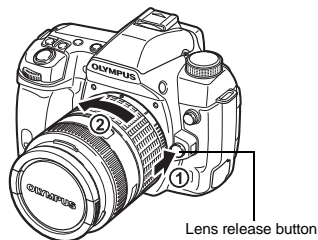

# Loading the card

## CompactFlash/Microdrive

Open the card cover (①, ②).  
Insert the card's contact area into the slot as far as it can go (③).

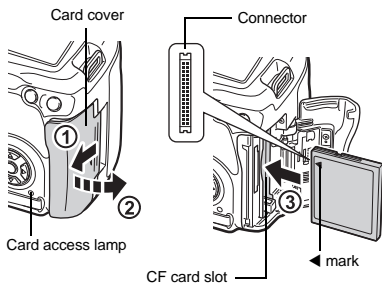

## xD-Picture Card

Open the card cover (①, ②).  
Insert the card until it is locked into place (③).

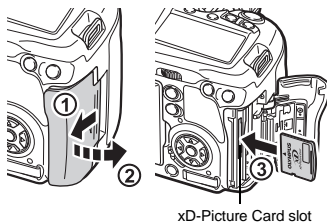

## Removing the card

Never open the card cover while the card access lamp is blinking.

## CompactFlash/Microdrive

- Press the eject button all the way in to make it pop out. Press the eject button again all the way in to eject the card.
- Pull out the card.

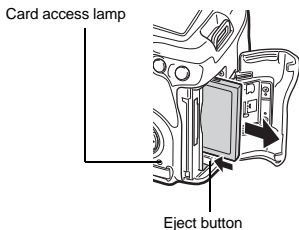

## xD-Picture Card

- Press the inserted card lightly and it will be ejected.
- Pull out the card.

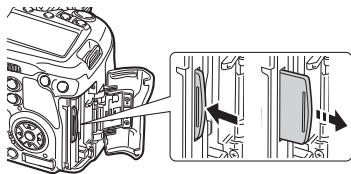

# Power on

## 1 Set the camera's power switch to ON

- To turn off the power, set the power switch to OFF.

### LIGHT button

Turns the control panel light on and off.

### Control panel

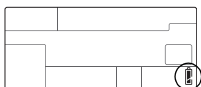

When the camera is turned on, the battery check is displayed on the control panel.

### Mode dial

Set the mode dial to AUTO.



- Lit up (ready for use)
- Lit up (battery power is low)
- Blinks (charging required)

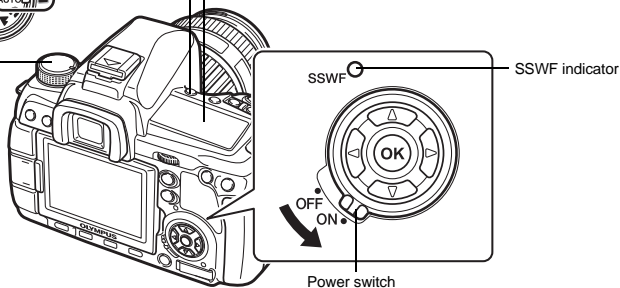

### Dust reduction function operation

The dust reduction function is automatically activated when the camera is turned on. Ultrasonic vibrations are used to remove dust and dirt from the image pickup device's filter surface. The SSWF (Super Sonic Wave Filter) indicator blinks while dust reduction is working.

## Adjusting the viewfinder's diopter

Adjust the viewfinder's diopter in accordance with your vision.

While looking through the viewfinder, rotate the diopter adjustment dial little by little.

When you can see the AF target clearly, adjustment is complete.

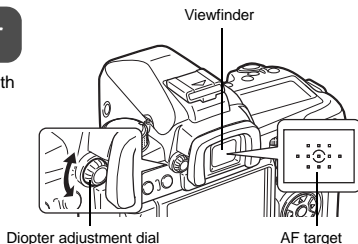

# Setting the date/time

Date and time information is recorded on the card together with the images. The file name is also included with the date and time information. Be sure to set the correct date and time before using the camera.

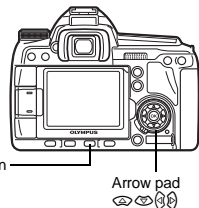

## 1 Press the MENU button

- The menu screen is displayed on the LCD monitor.

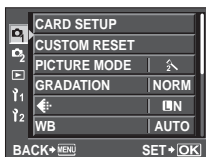

## 2 Use to select [12], then press

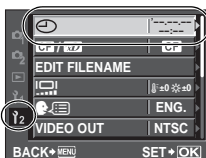

## 3 Use to select [Y/M/D], then press

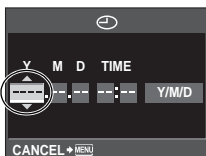

## 4 Use to select [Y], then press

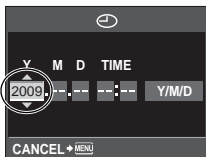

## 5 Repeat this procedure until the date and time are completely set

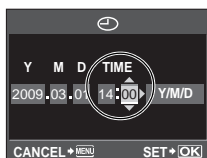

- The time is displayed in the 24-hour format.

## 6 Use to select the date format

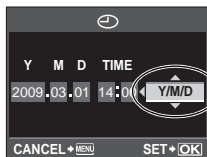

## 7 Press the button

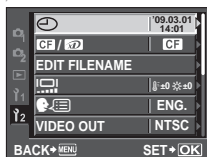

## 8 Press the MENU button to exit



- 1 Place the AF target on the subject while viewing through the viewfinder

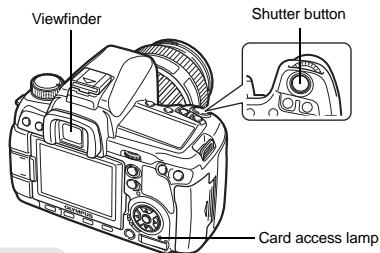

- 2 Adjust the focus

Press the shutter button halfway.

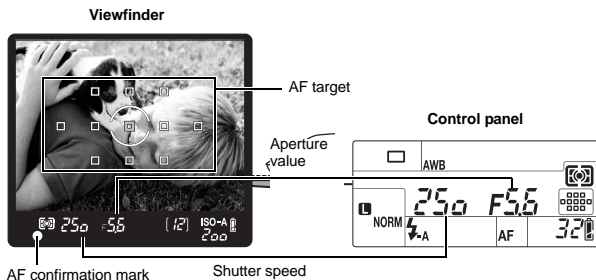

- The focus is locked when a beep tone is output. The AF confirmation mark and the AF target in focus light up in the viewfinder.
- The shutter speed and aperture value that have been set automatically by the camera are displayed.
- The super control panel is not displayed while the shutter button is pressed.

- 3 Release the shutter

Press the shutter button all the way (fully).



- The shutter sounds and the picture is taken.
- The card access lamp blinks and the camera starts recording the picture.

Never remove the battery or card while the card access lamp is blinking. Doing so could destroy stored pictures and prevent storage of pictures you have just taken.

## Holding the camera

Keep your fingers and the strap away from the lens, flash, and the white balance sensor.



Horizontal grip

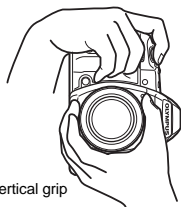

Vertical grip

## Taking a picture while viewing the monitor

It is possible to use the LCD monitor as a viewfinder and check the subject's composition, or shoot while viewing an enlarged display on the LCD monitor.

☞ "Using live view" (P. 34)

### 1 Press the (live view) button to switch to live view

- The subject is displayed on the LCD monitor.

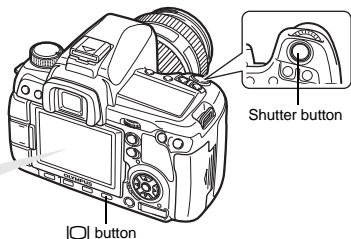

 button

Shutter button

### 2 Press the shutter button to take the picture

- The picture is taken with the focus adjusted.

## When the camera stops operating

If no operations are performed for approximately 8 seconds while the camera is on, the monitor backlight turns off to save battery power (when the super control panel is lit). If no operations are performed for approximately one minute thereafter, the camera enters the sleep mode (standby) and stops operating. The camera activates again when you touch any button (the shutter button,  button, etc.). ☞ "BACKLIT LCD (Backlight timer)" (P. 98), "SLEEP" (P. 98)

# Playback/Erasing

## Playing back images

Pressing the  button displays the last picture taken.

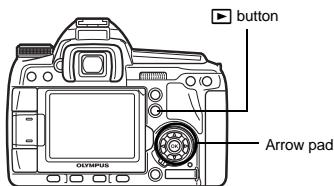

Displays the frame that is stored 10 frames back

Displays the previous frame



Displays the next frame



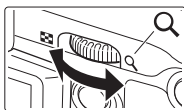
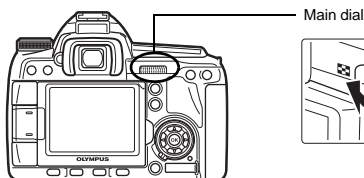

Displays the frame that is stored 10 frames ahead

## Close-up playback

Each time you turn the main dial towards , the image is incrementally enlarged from 2x to 14x.



## Erasing images

Play back the image you want to erase and press the  button. Use   to select [YES] and press the  button to erase.

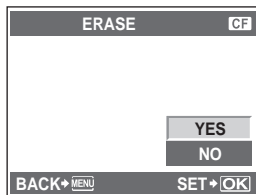
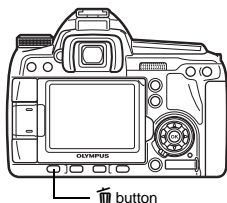

# Basic operations

There are three ways to operate this camera.

## Using the direct buttons to operate the camera P. 21

You can make the function settings with the main dial or sub dial and the direct buttons assigned to a function. Setting information is displayed in the viewfinder and on the control panel and super control panel while you are setting a function. This is useful for operating the camera while composing the subject in the viewfinder and for quickly operating the camera while checking the settings on the control panel.

## Setting while looking at the super control panel P. 22

You can make the function settings with the super control panel on the LCD monitor. You can use the super control panel to view the current settings and directly change the settings.

## Setting on the menu P. 23

You can use the menu to set shooting and playback settings and customize camera functions.

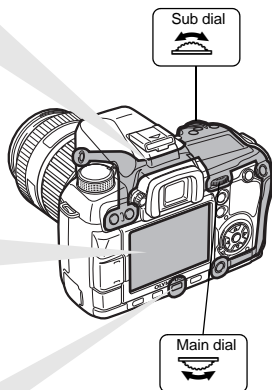

## Descriptions in this manual

The operating instructions of the direct buttons, super control panel and menu are described as follows in this manual.

- “+” indicates operations performed at the same time.
- “>” indicates you should proceed to the next step.

e.g.: When setting the flash intensity control

### Direct button



### Super control panel

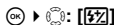

### Menu



## Resetting the camera settings

In **P**, **A**, **S**, and **M** mode, current camera settings (including any changes you have made) are retained when the power is turned off. To reset the camera to the factory default settings, set **[RESET]**.

 “Resetting the camera settings” (P. 108)

# Using the direct buttons to operate the camera

There are two ways to use the direct buttons.

- 1** While holding down a direct button, turn the main dial or sub dial
- Release the button to set the function.
- After pressing one or two buttons at the same time, turn the main dial or sub dial**

- The function remains selected for approximately 8 seconds. You can turn the dial and set the function during that time. If no operations are performed during that time, the setting for that function is then set. "BUTTON TIMER" (P. 97)

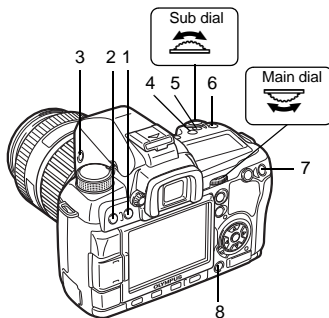

## List of direct buttons

No.	Direct buttons	Dial	Function	Ref. page
1			Sets metering mode	P. 46
			Remote control/Self-timer/Sequential shooting	P. 59-60
2	AF		Sets AF mode	P. 53
1+2	+ AF		AE bracketing	P. 48
3			Sets flash mode	P. 73
			Flash intensity control	P. 76
4	WB		Sets white balance	P. 66
1+4	+ WB		WB bracketing	P. 69
5			Exposure compensation	P. 47
4+5	WB +		WB compensation	P. 68
6	ISO		Sets ISO sensitivity	P. 50
5+6	+ ISO		Reset	P. 108
7			AF target selection	P. 55
8	IS		Sets image stabilizer	P. 62

# Setting while looking at the super control panel

## 1 Press the INFO button to display the super control panel

- Press the INFO button again to turn off the super control panel.
- Press the  button during live view to display the super control panel.

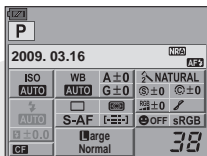
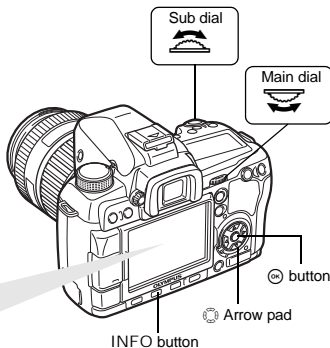

## 2 Press the OK button

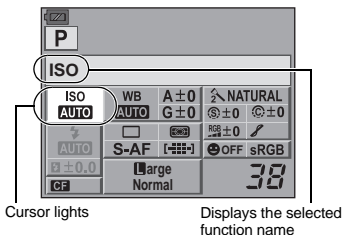

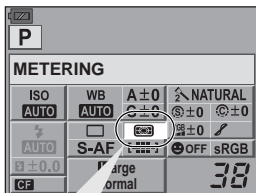

## 3 Use the arrow pad to move the cursor to the function you want to set, and change the setting with the dial

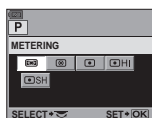

### Direct menu



Press the  button to display the direct menu indicated at the position of the cursor. You can also use the direct menu to change the setting. After changing the setting, press the  button to confirm your setting. If no operation is made within a few seconds, your setting is confirmed and the super control panel is displayed.

For details on the functions that can be set with the super control panel, refer to "Super control panel" (P. 8).

# Setting on the menu

- 1** Press the MENU button to display the menu

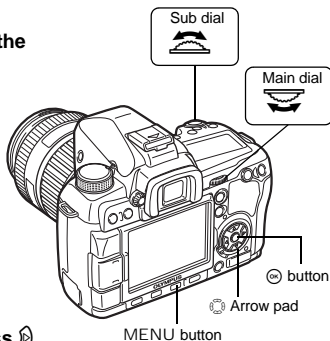
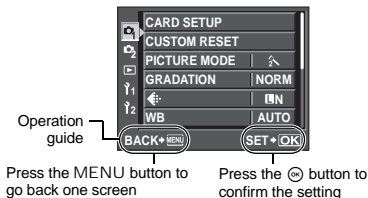

- 2** Use to select a tab, then press

- Shooting menu 1
- Shooting menu 2
- Playback menu
- Custom menu 1: Customizes shooting functions. This menu is further divided into 9 tabs, A through I.
- Custom menu 2: Sets the basic functions of the camera.

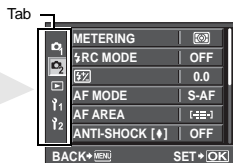

- 3** Use to select a function and to go to the setting screen

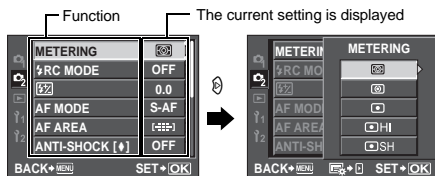

- 4** Press the button to confirm the setting

- Press the MENU button repeatedly to exit the menu.

## Using the dials to select a menu

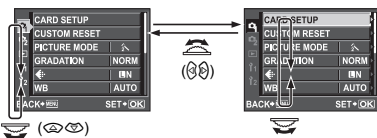

- Selecting a function and rotating the main dial automatically changes the tab and allows you to select a function on the next tab.

For details on the functions that can be set with the menu, refer to "Menu directory" (P. 139).

## Basic guide

2

Identifies the camera part names and describes the basic steps for shooting and playback.

Names of parts and functions .....	2
Camera .....	2
Mode dial .....	4
Viewfinder .....	6
Control panel.....	7
Super control panel.....	8
LCD monitor (Live view).....	9
LCD monitor (Playback).....	10
Preparations for shooting.....	11
Unpack the box contents .....	11
Preparing the battery .....	12
Attaching a lens to the camera .....	13
Loading the card .....	14
Power on.....	15
Setting the date/time .....	16
Shooting.....	17
Playback/Erasing .....	19
Basic operations .....	20
Basic operations .....	20
Using the direct buttons to operate the camera .....	21
Setting while looking at the super control panel.....	22
Setting on the menu.....	23

## 1 Using live view

34

Functions and operations available only during live view will be explained.

Activating live view.....	34
Functions available during live view.....	34
The live view mechanism.....	35
Taking a picture using live view .....	35
AF operation during live view.....	37
Using the face detection function.....	38
Taking a picture using manual focus.....	38
Switching the information display .....	39
Taking a picture while comparing the effect.....	40
Enlarged display operation .....	40
Panorama shooting.....	41



## 2 Exposure

42

Describes functions related to exposure, which is important for shooting. These functions are for determining the aperture value, shutter speed, and other settings by measuring the brightness in the picture.

Program shooting .....	42
Aperture priority shooting .....	42
Shutter priority shooting .....	43
Manual shooting .....	44
Bulb shooting .....	45
Preview function .....	45
Changing the metering mode .....	46
Exposure compensation .....	47
AE lock .....	48
AE bracketing .....	48
ISO sensitivity setting .....	50
ISO bracketing .....	51
Multiple exposure .....	51

## 3 Focusing and shooting functions

53

Describes the optimal focusing methods according to the subject and shooting conditions.

AF mode selection .....	53
S-AF (single AF) .....	53
C-AF (continuous AF) .....	54
MF (manual focus) .....	54
Simultaneous use of S-AF mode and MF mode (S-AF+MF) .....	55
Simultaneous use of C-AF mode and MF mode (C-AF+MF) .....	55
AF target selection .....	55
Registering an AF target mode .....	57
Focus lock – If correct focus cannot be obtained .....	58
Sequential shooting .....	59
Self-timer shooting .....	60
Remote control shooting .....	60
Anti-shock .....	62
Image stabilizer .....	62
Checking the image stabilizer effect with live view .....	63

## 4 Record mode, white balance, and picture mode

64

Describes image adjustment functions specific to digital cameras.

Selecting the record mode .....	64
Recording formats .....	64
Selecting the record mode .....	65
Selecting the white balance .....	66
Setting the auto/preset/custom white balance .....	67
WB compensation .....	68
Setting the one-touch white balance .....	69
WB bracketing .....	69
Picture mode .....	70
Gradation .....	71
Noise reduction .....	72
Noise filter .....	72

## 5 Flash shooting

73

Describes how to shoot with the built-in flash and an external flash.

Flash mode setting .....	73
Built-in flash shooting.....	76
Flash intensity control .....	76
Flash bracketing .....	77
External flash shooting .....	78
Shooting with the Olympus wireless RC flash system.....	79
Using commercially available flashes .....	81

## 6 Playback functions

82

Describes the functions for image playback.

Single-frame/Close-up playback.....	82
Light box display .....	83
Index display/Calendar display .....	84
Information display.....	85
Slideshow .....	86
Rotating images.....	86
Playback on TV.....	87
Editing still images.....	87
Image overlay .....	89
Copying images.....	90
Protecting images.....	91
Erasing images.....	92

## 7 Customizing your camera

93

Describes how to customize the camera's settings.

Custom Menu 1 .....	93
<b>[A]</b> AF/MF .....	93
AF ILLUMINAT. ....	93
FOCUS RING .....	93
C-AF LOCK.....	93
AF AREA POINTER.....	93
AF SENSITIVITY .....	93
[••] SET UP .....	94
RESET LENS.....	94
BULB FOCUSING.....	94
LIVE VIEW AF MODE.....	94
<b>[B]</b> BUTTON/DIAL .....	94
DIAL FUNCTION .....	94
DIAL DIRECTION .....	95
AEL/AFL.....	95
AEL/AFL MEMO .....	96
[Fn] FUNCTION .....	96
MY MODE SETUP.....	97
BUTTON TIMER .....	97
[AF] ⇌ [Fn] .....	97
[AF] FUNCTION.....	97

<b>16</b>	RELEASE/	97
	RLS PRIORITY S/RLS PRIORITY C .....	97
	L fps .....	97
<b>10</b>	DISP/	98
	PC .....	98
	SLEEP .....	98
	BACKLIT LCD (Backlight timer) .....	98
	4 h TIMER (Auto power off) .....	98
	USB MODE .....	98
	LIVE VIEW BOOST .....	99
	LV FRAME RATE .....	99
	FACE DETECT .....	99
	INFO SETTING .....	99
	LEVEL GAUGE .....	99
<b>1E</b>	EXP/	100
	EV STEP .....	100
	ISO STEP .....	100
	ISO-AUTO SET .....	100
	ISO-AUTO .....	100
	AEL Metering .....	100
	BULB TIMER .....	100
<b>1F</b>	CUSTOM .....	101
	X-SYNC .....	101
	SLOW LIMIT .....	101
	+  .....	101
	AUTO POP UP .....	101
<b>1G</b>	/ASPECT/COLOR/WB .....	101
	ALL  .....	101
	COLOR SPACE .....	101
	SHADING COMP. ....	102
	SET .....	102
	PIXEL COUNT .....	102
	IMAGE ASPECT .....	102
	ASPECT SHOOTING .....	103
<b>1H</b>	RECORD/ERASE .....	103
	QUICK ERASE .....	103
	RAW+JPEG ERASE .....	103
	FILE NAME .....	104
	PRIORITY SET .....	104
	dpi SETTING .....	104
<b>1I</b>	UTILITY .....	104
	CLEANING MODE .....	104
	EXT. WB DETECT .....	104
	AF FOCUS ADJ. ....	105
	EXPOSURE SHIFT .....	106
	BATTERY TYPE .....	106
	WARNING LEVEL .....	107
	LEVEL ADJUST .....	107
	Custom Menu 2 .....	107
	(Date/time setting) .....	107
	/  .....	107
	EDIT FILENAME .....	107
	(Monitor brightness adjustment) .....	107
	(Changing the display language) .....	107

VIDEO OUT .....	108
REC VIEW .....	108
PIXEL MAPPING .....	108
FIRMWARE .....	108
Resetting the camera settings .....	108

## **8 Printing**

**110**

Describes how to print your pictures.

Print reservation (DPOF) .....	110
Print reservation .....	110
Single-frame reservation .....	110
All-frame reservation .....	111
Resetting the print reservation data .....	112
Direct printing (PictBridge) .....	112
Connecting the camera to a printer .....	113
Easy printing .....	113
Custom printing .....	114

## **9 Using the OLYMPUS Master software**

**116**

Describes how to transfer and store your camera images to a computer.

Flowchart .....	116
Using the provided OLYMPUS Master software .....	116
What is OLYMPUS Master? .....	116
Connecting the camera to a computer .....	117
Start up the OLYMPUS Master software .....	118
Displaying camera images on a computer .....	118
Downloading and saving images .....	118
Disconnecting the camera from your computer .....	118
Viewing still images .....	119
Transferring images to your computer without using OLYMPUS Master .....	120

## **10 Shooting tips and maintenance**

**121**

Refer to this section for troubleshooting and camera maintenance information.

Shooting tips and information .....	121
Error codes .....	123
Camera maintenance .....	125
Cleaning and storing the camera .....	125
Cleaning mode – Removing dust .....	126
Pixel mapping – Checking the image processing functions .....	126

Refer to this section for information on optional accessories, camera specifications, and other useful shooting information.

Card basics .....	127
Usable cards .....	127
Formatting the card .....	127
Battery and charger .....	128
AC adapter .....	128
Using your charger and AC adapter abroad .....	128
Interchangeable lenses .....	129
ZUIKO DIGITAL interchangeable lens .....	129
E-System Chart .....	130
ZUIKO DIGITAL lens specifications .....	132
Program line diagram (P mode) .....	133
Flash synchronization and shutter speed .....	134
Exposure warning display .....	134
Flash modes that can be set by shooting mode .....	135
White balance color temperature .....	136
Record mode and file size/number of storable still pictures .....	137
Functions that can be registered with My Mode and Custom Reset Setting .....	138
Menu directory .....	139
Specifications .....	144
SAFETY PRECAUTIONS .....	147
Index .....	153

## Quick reference

Shooting		
Taking pictures with automatic settings	Set the mode dial to AUTO and start taking pictures.	P. 4
Correct focus cannot be obtained	Use focus lock.	P. 58
	Select the AF target and take the picture.	P. 55
	The minimum shooting distance varies depending on the lens. Move to the minimum shooting distance of the lens from the subject and take a picture.	P. 129
	The camera may be having difficulty focusing on the subject with auto focus. Lock the focus at the position of the subject in advance or use MF to fix the distance of the focus.	P. 54, P. 58, P. 122
	It may be easier to focus, even in low light situations, when using the AF illuminator.	P. 93
Focusing on one area	Select the AF target and take the picture using the desired AF target.	P. 55
	Use MF. It may be helpful to focus while using live view with an enlarged image.	P. 38, P. 40, P. 54
	Set <b>[AF SENSITIVITY]</b> to <b>[SMALL]</b> and focus using a smaller area.	P. 93
Taking pictures of nearby subjects	Use macro lens for close-up shots.	P. 129
Taking pictures while checking the results	During live view, you can take a picture while checking the white balance, exposure compensation, picture mode, and other settings on the LCD monitor.	P. 34
	You can take a picture while using the live multi view display to compare the effect of white balance or exposure compensation.	P. 40
	You can use the preview function to check the depth of field at a selected aperture value.	P. 45
	You can use live view to check the set exposure conditions.	P. 99
	You can use <b>[TEST PICTURE]</b> to check the image on the LCD monitor without recording the image to a card.	P. 96
Extending the useful life of the battery	Pressing the shutter button halfway, playing back images, and using the live view function over a long period consumes considerable battery power. Limiting these actions will help extend the useful life of the battery.	—
	Set <b>[SLEEP]</b> so that the camera enters sleep mode faster.	P. 98
	Set <b>[BACKLIT LCD]</b> so that the backlight turns off faster.	P. 98
Increasing the number of pictures that can be taken	Reduce the pixel count and compression rate settings.	P. 64, P. 102
	You can insert two types of cards.	P. 14, P. 127

Taking pictures in low light situations without using the flash	Increase the ISO sensitivity.	P. 50
	Set the image stabilizer function.	P. 62
Setting the camera to fire the flash automatically in low light situations	Set the flash setting to <b>[AUTO]</b> .	P. 73
	When the mode dial is set to AUTO, the flash automatically pops up and fires in low light situations.	P. 4, P. 76
Turning off auto firing of the flash	Set the flash setting to <b>[🔒]</b> .	P. 73
	When <b>[AUTO POP UP]</b> is set to <b>[OFF]</b> , the flash will not pop up automatically.	P. 76, P. 101
Taking pictures without whites appearing too white or blacks appearing too dark	Take a picture while checking the histogram.	P. 39
	Take a picture while checking the shutter speed and aperture value displays. If either is blinking, the optimal exposure is not obtained.	P. 42-43, P. 134
	Set the gradation setting to <b>[AUTO]</b> . Subjects with areas of large contrast are adjusted automatically.	P. 71
	Adjust the exposure compensation.	P. 47
Taking monotone pictures	Set <b>[PICTURE MODE]</b> to <b>[MONOTONE]</b> . You can take monotone pictures in black and white, sepia tones, purplish tones, bluish tones, and greenish tones.	P. 70
	Recorded images can be edited into black-and-white or sepia-toned images.	P. 87
	Set the art filter to <b>[GRAINY FILM]</b> .	P. 5
Taking pictures of a subject against backlight	Set the gradation setting to <b>[AUTO]</b> .	P. 71
	Set the flash setting to <b>[🔆]</b> (fill-in flash) and take the picture.	P. 73
	Use spot metering to measure the exposure of the subject in the center of the picture. If the subject is not in the center of the picture, use AE lock to lock the exposure, and then change the composition and take the picture.	P. 46, P. 48
Brightening a dark backlight image	You can adjust the image using <b>[SHADOW ADJ]</b> of <b>[JPEG EDIT]</b> .	P. 87
Taking pictures with a blurred background	Use <b>A</b> (aperture priority) mode to decrease the aperture value as much as possible. You can blur the background more by shooting up close to the subject.	P. 42
Taking pictures that stop the subject in motion or convey a sense of motion	Use the <b>S</b> (shutter priority) mode to take the picture.	P. 43
Taking pictures with the correct color	Set the white balance according to the light source. You can also make fine changes to the settings.	P. 66
	With WB bracket shooting, you can capture 3 to 9 images with different white balance settings for each picture taken. This enables you to take pictures with the desired white balance without having to make fine changes to the settings.	P. 69

Taking pictures so that whites come out white and blacks come out black	Set the spot metering for highlight or shadow control. If the subject is not in the center of the picture, use AE lock to lock the exposure, and then change the composition and take the picture.	P. 46, P. 48
	Adjust the exposure compensation. It may be helpful to use AE bracketing if you are not sure about the exposure compensation value.	P. 47, P. 48
	Set the scene mode to <b>[HIGH KEY]</b> or <b>[LOW KEY]</b> and take a picture.	P. 5
Taking pictures without noise	Set the ISO sensitivity to 200 or another low value.	P. 50
	Set <b>[NOISE REDUCT.]</b> to <b>[AUTO]</b> or <b>[ON]</b> .	P. 72
	When the ISO sensitivity is set to 1600 or another high value, set <b>[NOISE FILTER]</b> to <b>[HIGH]</b> .	P. 72
Making the viewfinder easier to view	Adjust the viewfinder's diopter in accordance with your vision.	P. 15
	If the viewfinder is still difficult to view after adjusting the diopter or you want to use the viewfinder without eyeglasses, you can replace the viewfinder with the optional diopter compensation eyecup.	—
Optimizing the LCD monitor	You can adjust the brightness of the LCD monitor.	P. 107
	During live view, set <b>[LIVE VIEW BOOST]</b> to <b>[ON]</b> to make the subject easier to see without the exposure reflecting on the LCD monitor.	P. 99
Reducing camera shake	Set the image stabilizer function.	P. 62
	Hold the camera firmly when pressing the shutter button. When using a slow shutter speed, be sure to stabilize the camera by using a tripod or similar method.	P. 18
	Fire the flash regardless of the light conditions.	P. 73
	Set the scene mode to <b>[DIS MODE]</b> .	P. 5
	Increase the ISO sensitivity. When ISO is set to <b>[AUTO]</b> , set the upper limit to a high value, such as 800, so that ISO automatically increases in low light situations.	P. 50, P. 100
	Using the self-timer can reduce camera shake that occurs when the shutter button is pressed.	P. 60
Taking pictures while checking the level of the camera	You can display the level gauge to check whether the camera is level.	P. 99
	Display the ruled lines in live view. Compose the shot so that the subject and ruled lines are horizontally and vertically aligned.	P. 39, P. 99

## Playback

Displaying the image after the picture is taken	Set <b>[REC VIEW]</b> . You can set the number of seconds that the image is displayed.	P. 108
Displaying the image after the picture is taken and deleting unneeded images	Set <b>[REC VIEW]</b> to <b>[AUTO  <p>32 EN</p> </b>	





Checking whether the subject is in focus	Use close-up playback to check whether the subject is in focus.	P. 82
Quickly searching for the desired image	Use index display to search from a index of between 4 and 100 frames.	P. 84
	Use calendar display to search by the date the picture was taken.	P. 84
Viewing images on a TV	Use the video cable to play back recorded images on your TV. You can also view the images as a slideshow.	P. 87
Comparing images	You can use light box display to display two frames side by side.	P. 83
	You can play back another image without changing the magnification.	P. 82

Settings		
Saving the settings	You can register two camera settings in <b>[CUSTOM RESET]</b> . Even if the settings are changed, they can be returned to their registered settings by resetting the settings.	P. 108
	You can register up to two current camera settings in <b>[MY MODE SETUP]</b> . Assign My Mode to the <b>Fn</b> button so that you can easily use that function during shooting.	P. 97
Changing the menu display language	You can change the display language.	P. 107

### Indications used in this manual

- The operation button icons on the body of the camera are used to indicate the operation buttons in this manual. See "Names of parts and functions" (📖 P. 2).
- In this manual, 📷 indicates the main dial on the back of the camera.
- In this manual, 📷 indicates the sub dial on the front of the camera.
- The following symbols are used throughout this manual.

 <b>Notes</b>	Important information on factors which may lead to a malfunction or operational problems. Also warns of operations that should be absolutely avoided.
 <b>TIPS</b>	Useful information and hints that will help you get the most out of your camera.
	Reference pages describing details or related information.

## Activating live view



It is possible to use the LCD monitor as a viewfinder. You can view the exposure or white balance effect and the subject's composition while you take the picture.

### 1 Press the button.

- The mirror is raised and the subject is displayed on the LCD monitor.
- When **[AF MODE]** was set to **[C-AF]**, it will be set automatically to **[S-AF]** (or **[S-AF+MF]** in case it was set to **[C-AF+MF]**).

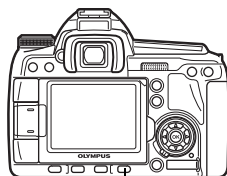





 button



## Functions available during live view

The following functions can be used during live view.



### Focusing during live view

- Taking a picture after selecting the AF system  P. 35
- Taking a picture using focus lock  P. 36
- Taking a picture while adjusting the focus manually  P. 38
- Taking a picture while focusing on a face  P. 38
- Taking a picture while checking the focus by enlarging the zone to be focused  P. 40

### Taking a picture while checking the effect

- Taking a picture after comparing the effect of exposure compensation or white balance  P. 40
- Taking a panoramic picture  P. 41
- Taking a picture while checking the effect of image stabilizer  P. 62

### Switching the indications on the LCD monitor

- Turning off the information display/Displaying the histogram or ruled lines  P. 39
- Checking the subject on the monitor even in low light situations  P. 99

### Notes

- If there is a high-intensity light source within the screen, the image may be displayed darker but will be recorded normally.
- If the live view function is used over a long period, the temperature of the image pickup device rises causing images with high ISO sensitivity to appear noisy and unevenly colored. Either lower the ISO sensitivity or turn off the camera for some time.
- Exchanging the lens will cause live view to stop.
- The following functions are not available during live view.
  - C-AF/AE lock\*/**[AEL/AFL]**
  - \* You can use AE lock when **[LIVE VIEW AF MODE]** is set to **[IMAGER AF]**.
- When **[IMAGER AF]** is selected, you cannot use the AF illuminator.

## The live view mechanism

During live view, the image on the LCD monitor is the same image received by the image pickup device (Live MOS sensor/imager) that is used for shooting. This way you can check on the LCD monitor the effects of exposure compensation or white balance. Moreover, you can also enlarge part of the subject to focus on it or display ruled lines to check that the composition is level.

While the image appears on the LCD monitor during live view, the mirror is raised and the shutter is open. Therefore, you will not be able to check the subject in the viewfinder. Correct metering may not be possible if strong light is coming in through the viewfinder. In such case attach the eyepiece cover.  "Eyepiece cover" (P. 60)

Taking pictures using the viewfinder

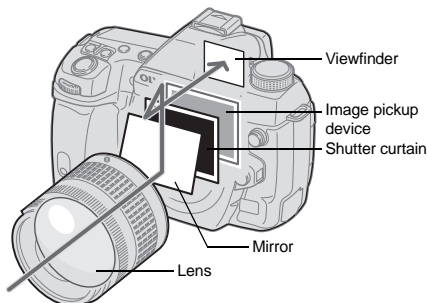

- The light coming in through the lens is reflected on the mirror and you can check the subject in the viewfinder.

Taking pictures using live view

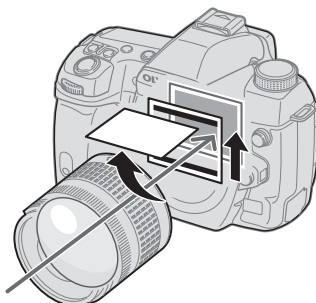

- The mirror is raised and the shutter is open. The image received by image pickup device is displayed on the LCD monitor.

1

Using live view

### Taking a picture using live view

In live view you can choose one of 3 available AF systems. The **[LIVE VIEW AF MODE]** setting will determine when and how focusing is performed.

#### Menu

MENU ▶    **[LIVE VIEW AF MODE]**

#### Characteristics of the live view AF mode

LIVE VIEW AF MODE	Using the shutter button		Focus lock	Restrictions on use
	Halfway down	All the way down		
IMAGER AF (factory default setting)	AF operation using the imager	Shooting	Press the shutter button halfway or press the AEL/AFL button.	* Only possible with compatible lenses.
AF SENSOR	—	AF operation using the AF sensor and then shooting	While holding down the AEL/AFL button, press the shutter button all the way.	None
HYBRID AF	AF operation using the imager (approximate focus)	AF operation using the AF sensor and then shooting	While holding down the AEL/AFL button, press the shutter button all the way.	None

\* For the latest information about Olympus lenses compatible with Imager AF, visit the Olympus website. When you are using a lens that is not compatible with **[IMAGER AF]**, **[HYBRID AF]** will be selected automatically.

**Taking a picture with [IMAGER AF]****1 Press the shutter button halfway.**

- When the focus is locked, the AF confirmation mark and AF target mark light up.

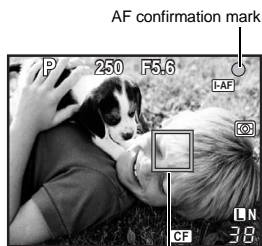
**2 Press the shutter button all the way to take a picture.**

AF target mark

**Taking a picture with [AF SENSOR]****1 Press the shutter button all the way.**

- The mirror is lowered and the picture is taken after the focus is locked.
- The image that was displayed on the monitor before lowering the mirror freezes during focusing.
- If correct focus cannot be obtained, you will hear the sound of the shutter but the picture will not be taken.
- To focus in advance, hold down the AEL/AF-L button and press the shutter button. When the focus is locked, the AF confirmation mark lights up. When the AF confirmation mark is blinking, the focus is not locked.

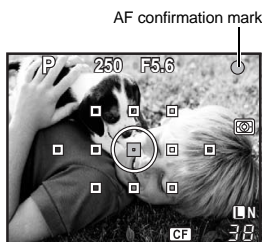

AF confirmation mark

**Taking a picture with [HYBRID AF]****1 Press the shutter button halfway.**

- The Imager AF will be activated and you can check the subject on the LCD monitor.
- When the Imager AF achieves approximate focus, the  mark lights up.

**2 Press the shutter button all the way.**

- The picture is taken in a similar way as when using [AF SENSOR].

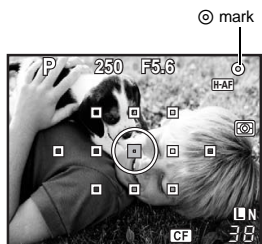
**Shooting while changing the angle of the LCD monitor**

You can change the angle of the LCD monitor on the camera. This enables you to shoot at an awkward angle while checking the subject's composition on the LCD monitor.

- Slowly rotate the LCD monitor within the moveable range.

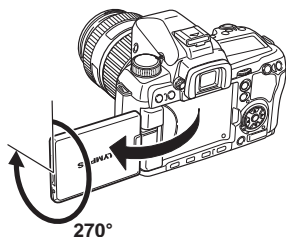

## AF operation during live view

### [IMAGER AF]

When you press the shutter button halfway, AF is performed by the image pickup device.

### [AF SENSOR]

When you press the shutter button all the way, the AF is activated and the picture is taken in the same way as when taking pictures using the viewfinder (AF is not activated on pressing the shutter button halfway).

### [HYBRID AF]

When you press the shutter button halfway, focusing is performed approximately by the Imager AF and you can check the subject on the LCD monitor. When you press the shutter button all the way, the AF is activated in the same way as with the [AF SENSOR] setting. The approximate focusing distance is obtained when the shutter button is pressed halfway so the time it takes to actually take the picture after pressing the shutter button all the way is shortened. When using S-AF+MF, this is very convenient as you can hold the shutter button pressed halfway and finely adjust the focus while checking the LCD monitor.

## Camera status during AF

**Imager AF**

Halfway down

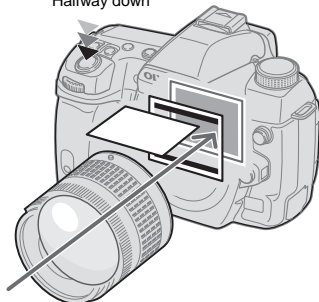

- AF is performed by the image pickup device.

**AF Sensor**

All the way down

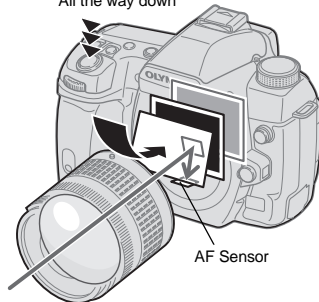

- The mirror is lowered and AF is performed by the AF sensor. (The mirror freezes just before pressing the shutter button all the way.)

## Using the face detection function

By setting [☺ FACE DETECT] to [ON], the camera will detect people's faces in the frame and adjust the focus and metering automatically.

### Direct button

**Fn** (The setting changes each time the button is pressed.)

### Super control panel

☺ ▶ ☺ ▶ [☺ FACE DETECT]

### Menu

MENU ▶ [1] ▶ [☺] ▶ [☺ FACE DETECT] ▶ [ON]

- In order to use the **Fn** button, [**Fn FACE DETECT**] needs to be set up in the menu in advance.  "Fn FUNCTION" (P. 96)
- After setting [☺ FACE DETECT] to [ON] while using the **Fn** button, the following functions are automatically set to the best settings for taking pictures of people.

Function	Setting	Ref. page
METERING		P. 46
GRADATION	AUTO	P. 71
LIVE VIEW AF MODE	IMAGER AF	P. 35
AF MODE	S-AF	P. 53
AF AREA	[⋮]	P. 55

## 1 If the camera detects a face, a frame will be displayed in that location.

- When you press the shutter button, the camera will focus on the position of the face detection frame (however, if a single AF target is selected with [AF AREA], the camera will focus on the AF target selected).
- With [AF SENSOR] or [HYBRID AF], the camera will focus on the AF target that is closest to the face detection frame.

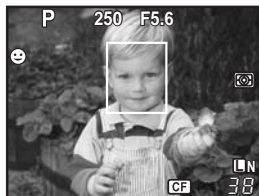

## ! Notes

- During sequential shooting, face detection will work only at the first shot.
- Depending on the subject, the camera may not be able to correctly detect the face.

## Taking a picture using manual focus

During live view, you can take a picture focusing manually while checking the focus on the LCD monitor.

## 1 Set the AF mode to [S-AF+MF] or [MF]. "AF mode selection" (P. 53)

## 2 Adjust the focus by rotating the focus ring.

- In [S-AF+MF] mode, after pressing the shutter button halfway or pressing the AEL/AFL button, you can rotate the focus ring to finely adjust the focus before taking the picture.
- Using the enlarged display can be very convenient when adjusting the focus manually.  "Enlarged display operation" (P. 40)

## Switching the information display

You can switch the information displayed on the monitor by pressing INFO button repeatedly. You can also switch the information displayed by turning the dial while pressing the INFO button.

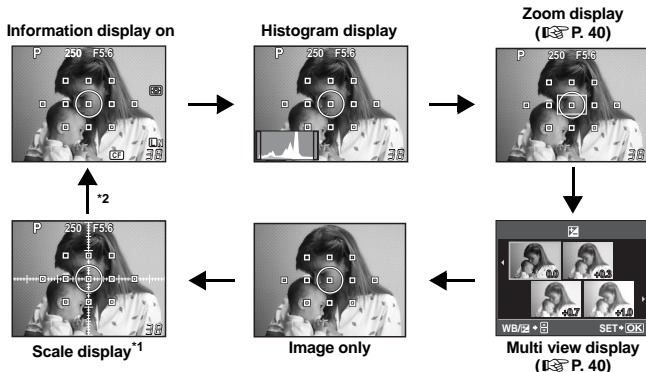

\*1 With [INFO SETTING] (P. 99), you can also select [ ] or [ ] for the ruled line display.

\*2 During multiple exposure shooting (P. 51) or when [LEVEL GAUGE] (P. 99) is set to [ON], the information display switches to "Multiple exposure display" and "Digital level gauge display".

### TIPS

#### To quickly switch to the frequently used display:

→ You can hide the information display for all modes except "Information display on". [INFO SETTING] (P. 99)

#### How to read the histogram:

→ The following shows you how to read the histogram display easily.

- ① If the graph has many peaks around here, the image will appear mostly black.
- ② If the graph has many peaks around here, the image will appear mostly white.
- ③ The part indicated in green in the histogram shows the luminance distribution within the spot metering area.

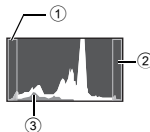

## Taking a picture while comparing the effect

You can check the effect of exposure compensation or white balance on a 4-split screen.

### 1 Press the INFO button repeatedly to display the multi view display.

- “Switching the information display” (P. 39)
- The exposure compensation comparison screen is displayed. Press  $\odot$  to switch to the white balance comparison screen. Press  $\odot$  to switch the screen.

### 2 Use $\odot$ or the dial to select the setting value, then press the $\odot$ button.

- You can take the picture using the set value.



### ! Notes

- Exposure compensation is not available in **M** mode.
- This function cannot be used in **ART/SCN** mode.

## Enlarged display operation

It is possible to enlarge the subject for display. Enlarging the image during MF makes focus confirmation and adjustment easier.

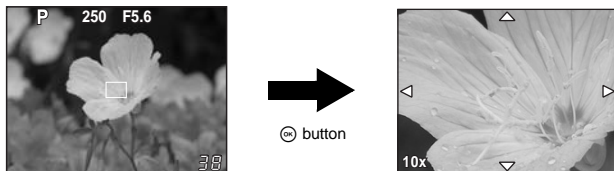

### 1 Press the INFO button repeatedly to display the zoom display.

- “Switching the information display” (P. 39)
- The enlargement frame will be displayed.

### 2 Use $\odot$ to move the frame and press the $\odot$ button.

- The area inside the frame is enlarged and displayed.
- Press and hold the  $\odot$  button to return the enlargement frame to the center after it was moved.

### 3 Turn the dial to change the magnification (5x/7x/10x).

- Use  $\odot$  to scroll the frame even during magnification.
- Pressing the  $\odot$  button will cancel the zoom display.
- During zoom display, AF will not be activated even in the shutter button is pressed all the way. You can take the picture after checking the focus in the zoom display.



## Panorama shooting

You can enjoy panorama shooting easily using the OLYMPUS xD-Picture Card. Using OLYMPUS Master (provided CD-ROM) to join a few images shot where the subject's edges overlap, you can create a single panorama composite image. Panorama shooting is possible up to a maximum of 10 images.

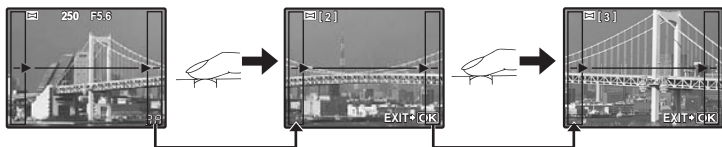

- Try your best to include the common parts of the overlapping images when shooting the subject.

### 1 Set the mode. “Setting the art filter/scene” (P. 5)

- Live view is activated.

### 2 Use to specify the direction for joining, then shoot the subject with the edges overlapping.

- : Joins the next image to the right.
- : Joins the next image to the left.
- : Joins the next image to the top.
- : Joins the next image to the bottom.

- Shoot while changing the composition such that the subject overlaps.
- The focus, exposure, etc. will be determined at the first shot.
- The (warning) mark will be displayed after you have finished taking 10 shots.
- Pressing the button before shooting the first frame returns to the scene mode selection menu.
- Pressing the button in the midst of shooting ends the sequence of panorama shooting, and allows you to continue with the next one.

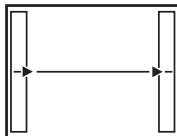

### Notes

- Panorama shooting cannot be done if the OLYMPUS xD-Picture Card is not loaded in the camera.
- During panorama shooting, the image previously taken for position alignment will not be retained. With the frames or other markers for display in the images as a guide, set the composition such that the edges of the overlapping images overlap within the frames.

## Program shooting

P

The camera sets the optimum aperture value and shutter speed automatically according to the subject brightness.

Set the mode dial to **P**.

- When the shutter button is half-pressed, the shutter speed and aperture value are displayed on the viewfinder and control panel.

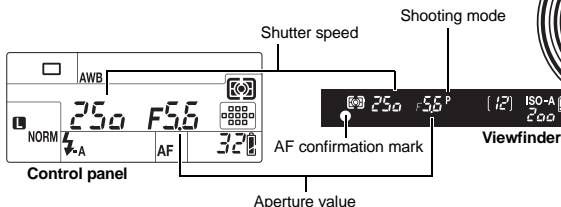
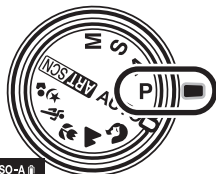
Program shift (**Ps**)

By turning the main dial (or sub dial) in the **P** mode, you can change the combination of aperture and shutter speed while maintaining the optimum exposure.

 "Program line diagram (**P** mode)" (P. 133)

- The program shift setting will not be canceled after shooting. To cancel program shift setting, turn the main dial (or sub dial) until **Ps** disappears from the viewfinder or control panel, or turn off the power.
- Program shift is not available when you are using a flash.

## TIPS

## The shutter speed and aperture value are blinking:

→ The optimum exposure cannot be obtained. For details, see "Exposure warning display" ( P. 134).

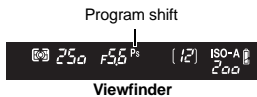

## Aperture priority shooting

A

The camera sets the optimum shutter speed automatically for the aperture value you have selected. When you open the aperture (decrease the aperture value), the camera will focus within a shorter range (shallow depth of field) and produce a picture with a blurred background. When you close the aperture (increase the aperture value), the camera will focus within a longer range. Use this mode when you wish to add changes to the background representation.

When the aperture value (f-number) is decreased



When the aperture value (f-number) is increased



Set the mode dial to **A** and turn the main dial (or sub dial) to set the aperture value.

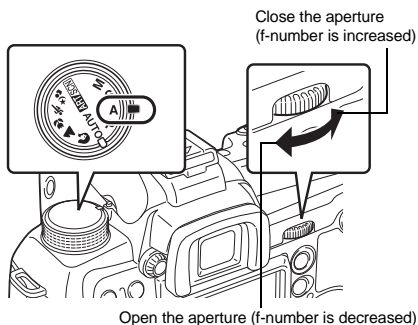
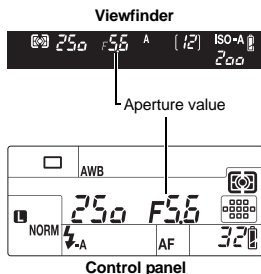

### TIPS

**To check the depth of field with the selected aperture value:**

→ See "Preview function" (P. 45).

**To change the exposure adjustment interval:**

→ This can be set in 1/3 EV, 1/2 EV or 1 EV increments. (EV STEP" (P. 100)

**Shutter speed is blinking:**

→ The optimum exposure cannot be obtained. For details, see "Exposure warning display" (P. 134).

## Shutter priority shooting

S

The camera sets the optimum aperture value automatically for the shutter speed you have selected. Set the shutter speed depending on the type of effect you want. A higher shutter speed allows you to capture a fast-moving subject without blur, and a slower shutter speed blurs a moving subject, creating a feeling of speed or motion. Set the shutter speed depending on the type of effect you want.

A fast shutter speed can freeze a fast action scene without any blur.



A slow shutter speed will blur a fast action scene. This blurring will give the impression of dynamic motion.

Set the mode dial to **S** and turn the main dial (or sub dial) to set the shutter speed.

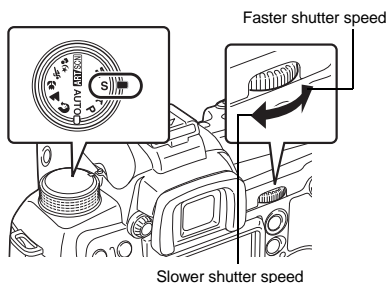
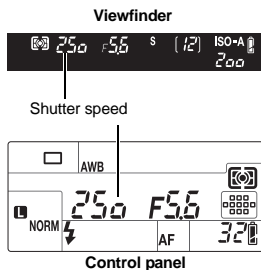

## TIPS

### The picture looks blurred:

- The possibility of camera shake spoiling your picture increases greatly during macro or ultra-telephoto shooting. Raise the shutter speed or use a monopod or tripod to stabilize the camera.
- When the shutter speed is slow, camera shake is more likely to occur. You can reduce camera shake by using the image stabilizer.  "Image stabilizer" (P. 62)

### To change the exposure adjustment interval:

- This can be set in 1/3 EV, 1/2 EV or 1 EV increments.  "EV STEP" (P. 100)

### The aperture value is blinking:

- The optimum exposure cannot be obtained. For details, see "Exposure warning display" ( P. 134).

# 2

## Manual shooting

**M****Exposure**

Allows you to set the aperture and shutter speed manually. You can check how much it differs from the appropriate exposure by using the exposure level indicator. This mode gives you more creative control, allowing you to make whatever settings you like, regardless of the correct exposure.

### Set the mode dial to **M** and turn the dial to set the value.

Aperture value: Turn the main dial to set the value.

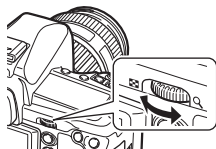

Shutter speed: Turn the sub dial to set the value.

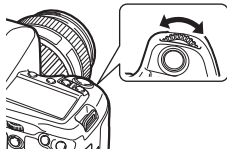

- The range of aperture values available varies with the lens type.
- The shutter speed can be set to 1/8000 – 60 sec. or **[BULB]**.
- In **M** mode the exposure level indicator will appear on the super control panel screen. It shows the difference (ranging from -3 EV to +3 EV) between the exposure value calculated by the currently selected aperture and shutter speed and the exposure value considered optimum by the camera. If the difference exceeds  $\pm 3$  EV, the entire indicator blinks.



### Noise in images

During shooting at slow shutter speeds, noise may appear on-screen. These phenomena are caused when current is generated in those sections of the image pickup device that are not normally exposed to light, resulting in a rise in temperature in the image pickup device or image pickup device drive circuit. This can also occur when shooting with a high ISO setting in a high-temperature environment. To reduce this noise, the camera activates the noise reduction function.

-  "Noise reduction" (P. 72)

## TIPS

### The picture looks blurred:

- The use of a monopod or tripod is recommended when taking a picture at slow shutter speed.
- When the shutter speed is slow, camera shake is more likely to occur. You can reduce camera shake by using the image stabilizer.  "Image stabilizer" (P. 62)

### To change the exposure adjustment interval:

- This can be set in 1/3 EV, 1/2 EV or 1 EV increments.  "EV STEP" (P. 100)

### To switch the operations of the main dial and sub dial:

- You can switch the functions that are set with the main dial and sub dial.  "DIAL FUNCTION" (P. 94)

## ! Notes

- Exposure compensation is not available in **M** mode.

## Bulb shooting

You can take a picture with a bulb exposure time in which the shutter stays open as long as you hold down the shutter button.

Bulb shooting can also be done using an optional remote control (RM-1).  "Bulb shooting with the remote control" (P. 62)

### In **M** mode, set the shutter speed to [BULB].

- "buLb" is displayed in the viewfinder and on the control panel.

## TIPS

### To automatically end bulb shooting after a specified period of time:

- You can set the maximum time for bulb shooting.  "BULB TIMER" (P. 100)

### To fix the focus during manual focus shooting:

- You can fix the focus so the focus does not change even if the focus ring is turned during exposure.  "BULB FOCUSING" (P. 94)

## ! Notes

- The following functions are not available during bulb shooting.  
Sequential shooting/self-timer shooting/AE bracket shooting/image stabilizer/flash bracketing

## Preview function

The viewfinder shows the focused area (depth of field) with the selected aperture value.

### Press the preview button to use the preview function.

- When [**Fn** FUNCTION] is assigned to [PREVIEW] or [LIVE PREVIEW], you can also press the **Fn** button to preview the picture.  
 "Fn FUNCTION" (P. 96)

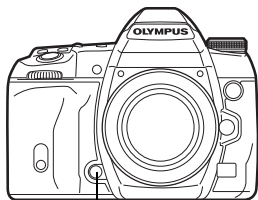

Preview button

## Changing the metering mode



There are 5 ways to measure the subject brightness: Digital ESP metering, Center weighted averaging metering, and 3 types of spot metering. Select the most suitable mode for the shooting conditions.

### Direct button



### Super control panel



### Menu

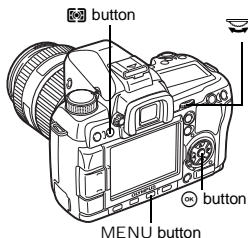
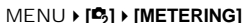

2

Exposure

### Setting display



Viewfinder

- : Digital ESP metering
- : Center weighted averaging metering
- : Spot metering
- : Spot metering – highlight control
- : Spot metering – shadow control

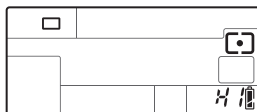

Control panel

### Digital ESP metering

The camera measures the light levels and calculates the light level differences in 49 separate areas of the image. This mode is recommended for general use. Setting the AF synchronized function to **[ESP+AF]** enables metering centered around the AF target that is in focus with AF.

### Center weighted averaging metering

This metering mode provides the average metering between the subject and the background lighting, placing more weight on the subject at the center. Use this mode when you do not want the light level of the background to affect the exposure value.

### Spot metering

The camera meters a very small area around the center of the subject, defined by the spot metering area mark in the viewfinder. Use this mode when there is very strong backlight.

### Spot metering – highlight control

When the overall background is bright, white areas of the image will come out gray if you use the camera's automatic exposure. Using this mode enables the camera to shift to over-exposure, allowing accurate white reproduction.

Metering area is the same as spot metering.

### Spot metering – shadow control

When the overall background is dark, black areas of the image will come out gray if you use the camera's automatic exposure. Using this mode enables the camera to shift to under-exposure, allowing accurate black reproduction. Metering area is the same as spot metering.

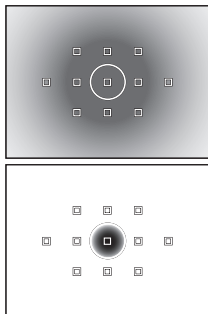

: Metering area

## Exposure compensation



In some situations, you may get better results if you manually compensate (adjust) the exposure value set automatically by the camera. In many cases, bright subjects (such as snow) will turn out darker than their natural colors. Adjusting toward + makes these subjects closer to their real shades. For the same reason, adjust toward – when shooting dark subjects. The exposure can be adjusted in a range of  $\pm 5.0$  EV.



### Direct button

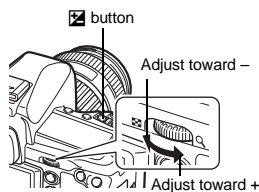



- The exposure compensation indicator is displayed. The exposure compensation indicator will not be displayed when the exposure is compensated by 0.

When set to 1/3 EV increments

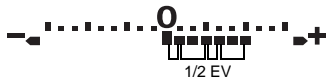

When set to 1/2 EV increments



- If the exposure compensation value exceeds the scale of the exposure compensation indicator, the indicator will blink in the viewfinder and on the control panel. A red  is displayed on the left and right edges of the indicator on the super control panel.





### TIPS

#### To change the exposure adjustment interval:

→ This can be set in 1/3 EV, 1/2 EV or 1 EV increments.  "EV STEP" (P. 100)

#### To adjust the exposure using only the dials:

→ You can set the exposure compensation value without pressing  button.

 "DIAL FUNCTION" (P. 94)

### Notes

- Exposure compensation is not available in **M** and **SCN** modes.

## AE lock

**AEL**

The metered exposure value can be locked with the AEL/AFL button (AE lock). Use AE lock when you want a different exposure setting from the one that would normally apply under the current shooting conditions.

Normally, pressing the shutter button halfway locks both AF (auto focus) and AE (automatic exposure), but you can lock the exposure alone by pressing the AEL/AFL button.

**Press the AEL/AFL button at the position where you wish to lock the metering values and the exposure will be locked. The exposure is locked while the AEL/AFL button is pressed. Now press the shutter button.**

- Releasing the AEL/AFL button cancels AE lock.

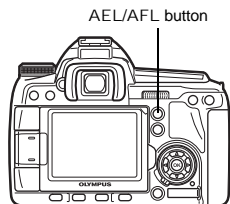

AE lock

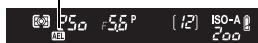

Viewfinder

### TIPS

#### To lock the exposure:

→ You can lock the metering result so that it is not canceled when the AEL/AFL button is released.

☞ "AEL/AFL MEMO" (P. 96)

#### If you find it difficult to press the AEL/AFL button and shutter button at the same time:

→ You can switch the functions of the AEL/AFL button and the Fn button.

☞ "AEL/AFL" (P. 97)

#### To activate AE lock with a set metering mode:

→ You can set the metering mode for locking the exposure with the AE lock.

☞ "AELMetering" (P. 100)

## AE bracketing

The camera automatically shoots a number of pictures at different exposure values for each frame. Even in conditions where correct exposure is difficult to obtain (such as a backlit subject or a scene at dusk), you can pick the picture you prefer from a selected number of frames with a variety of different exposure settings (exposure and compensation values). The pictures are taken in the following order: Picture with optimum exposure, picture adjusted in – direction, and picture adjusted in + direction.

e.g.) When BKT is set to **[3F 1.0EV]**



-1.0EV



±0



+1.0EV



### Compensation value: 0.3, 0.7 or 1.0

- The compensation value will change if the EV step is changed.  "EV STEP" (P. 100)

### Number of frames: 3 or 5

**Direct button**



**Menu**

MENU  $\blacktriangleright$  [C2]  $\blacktriangleright$  [AE BKT]

### Setting display

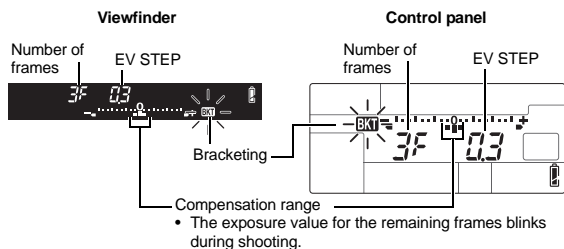

### Start shooting.

- In single-frame shooting, the exposure changes every time the shutter button is pressed.
- In sequential shooting, hold down the shutter button until the selected number of frames are taken.
- Releasing the shutter button stops flash bracketing shooting. When it stops, **BKT** blinks in the viewfinder and on the control panel and **BKT** is displayed in green on the super control panel.

### How AE bracketing compensates exposure in each shooting mode

Depending on the selected shooting mode, exposure is compensated in the following way:

- P** mode : Aperture value and shutter speed
- A** mode : Shutter speed
- S** mode : Aperture value
- M** mode : Shutter speed

### TIPS

#### To apply AE bracketing to the exposure value you have compensated:

- Compensate the exposure value, then use the AE bracketing feature. AE bracketing is applied to the exposure value you have compensated.

The higher the ISO value, the greater the camera's light sensitivity and the better its ability to shoot in low light conditions. However, higher values may give pictures a grainy appearance.

**Direct button**ISO ▶ **Super control panel** ▶ : [ISO]**Menu**MENU ▶  ▶ [ISO]

**[AUTO]** : The sensitivity is set automatically according to the shooting conditions. For **[ISO-AUTO SET]**, you can set the default (value normally used when the optimal exposure can be obtained) and upper limit (upper limit of ISO that automatically changes).  "ISO-AUTO SET" (P. 100)

**[100 – 3200]**: Fixed ISO sensitivity. **[ISO STEP]** can be changed to **[1/3EV]** or **[1EV]**.  "ISO STEP" (P. 100)

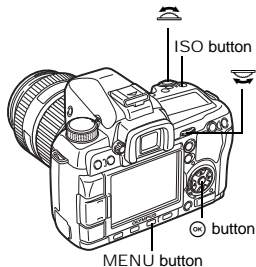
**Setting display****Viewfinder**

When set to **[AUTO]**, the default value is displayed.

AUTO : ISO-A  
100 : 100  
|  
3200 : 3200

- 125 and 1250 are displayed in the viewfinder as 120 and 1200, respectively.

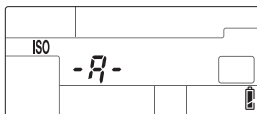
**Control panel**

-A-  
100  
|  
3200

**Display after setting****Viewfinder**

When set to **[AUTO]**, ISO-A and the ISO value determined by the camera are displayed. For all other settings, ISO and the set value are displayed. When set to 2000 or a higher value, ISO blinks.

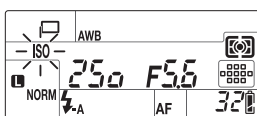
**Control panel**

When set to a setting other than AUTO, ISO is displayed. When set to 2000 or a higher value, ISO blinks.

**TIPS****To automatically set the optimal ISO in M mode:**

→ Normally, the AUTO setting is not available in **M** mode, but you can set it for use in all shooting modes.  "ISO-AUTO" (P. 100)

## ISO bracketing

The camera automatically takes pictures at a different ISO sensitivity with the shutter speed and aperture value fixed. 3 images with different exposures are recorded in the order of the set ISO sensitivity (optimum exposure when set to **[AUTO]**), exposure in the – direction, and exposure in the + direction.

**Compensation value: 0.3, 0.7 or 1.0**

- The compensation value is set in 1/3 EV increments regardless of the ISO step setting.

**Number of frames: 3**

**Menu**

MENU ▶ **[C2]** ▶ **[ISO BKT]**

**Notes**

- Bracketing is performed regardless of the upper limit set with **[ISO-AUTO SET]**.

## Multiple exposure

This overlays multiple frames and saves it as a single image. The image is saved with the record mode set at the time the image is saved.

You can overlay an image while taking a picture or overlay a recorded image in playback mode.

**MULTIPLE EXPOSURE**

In shooting mode, up to 4 frames of pictures taken can be overlaid and saved as a single image. You can also select a stored RAW image and shoot multiple exposures to create an overlay image.

- [FRAME]** : Select from **[2F]**, **[3F]**, or **[4F]** for the number of pictures to take.
- [AUTO GAIN]** : When set to **[ON]**, the brightness of each frame is set to “1/the number of picture taken” and the images are overlaid. When set to **[OFF]**, the images are overlaid with the original brightness of each frame.
- [OVERLAY]** : When set to **[ON]**, a RAW image recorded on a card can be overlaid with multiple exposures and stored as a separate image. The number of pictures taken is one less than the frames set in **[FRAME]**.



**IMAGE OVERLAY**

In playback mode, up to 4 frames of RAW images can be overlaid and saved as a single image.  “Image overlay” (P. 89)

**Menu**

MENU ▶ **[C2]** ▶ **[MULTIPLE EXPOSURE]**

**Setting display**

- When multiple exposure is set,  is displayed on the control panel and super control panel. When shooting is interrupted,  blinks and  is displayed in green on the super control panel.

Control panel

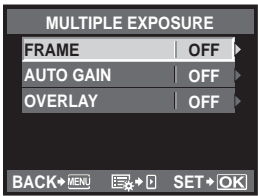
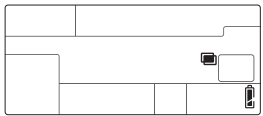

## TIPS

### To cancel the image during shooting:

→ Pressing the  button cancels the last picture taken.

### To shoot multiple exposures while checking the composition for each frame:



→ Take pictures using live view. The overlay images are displayed semi-transparently on the LCD monitor so you can shoot while checking the position of the image overlay.

### To overlay 5 or more frames:

→ To overlay 5 or more frames, save the image as a RAW file and use **[OVERLAY]** to repeat the multiple exposure shooting.



### Notes

- When multiple exposure is set, **[SLEEP]** is set to **[OFF]** automatically.
- RAW images taken with another camera cannot be used for the overlay image.
- When **[OVERLAY]** is set to **[ON]**, the images displayed when a RAW image is selected are developed with the settings at the time of shooting.
- To set the shooting functions, cancel multiple exposure shooting first. Some functions cannot be set.
- Multiple exposure is canceled automatically in the following situations.
  - The camera is turned off/The  button is pressed/The **Fn** button is pressed (when , **[TEST PICTURE]**, or **[MY MODE]** is registered)/The shooting mode is set to a mode other than **P**, **A**, **S**, **M**, or **AUTO**/The lens release button is pressed/The battery power runs out/
  - The card cover is opened/The card is replaced/The LCD monitor is closed/The USB cable is inserted
- The information for the first frame during multiple exposure shooting is displayed as the shooting information.

## AF mode selection

**AF**

The three focus modes S-AF, C-AF, and MF are available with this camera. You can take pictures by combining S-AF or C-AF mode with MF mode.

### Direct button

 AF ▶ 

### Super control panel

 ▶  : [AF MODE]

### Menu

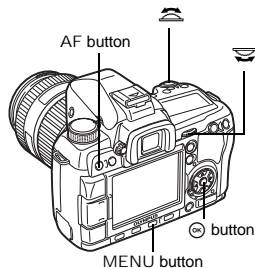
 MENU ▶  ▶ [AF MODE]

## Setting display

### Viewfinder



### Control panel

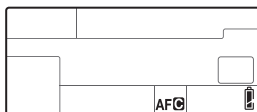

S-AF : *S<sub>AF</sub>*  
 C-AF : *C<sub>AF</sub>*  
 MF : -F  
 S-AF+MF : *S<sub>AF</sub>* -F  
 C-AF+MF : *C<sub>AF</sub>* -F

AF  
 AF   
 MF  
 MFAF  
 MFAF 

## S-AF (single AF)

Focusing is performed once when the shutter button is pressed halfway. If focusing fails, release your finger from the shutter button and press it halfway again. This mode is suitable for taking pictures of still subjects or subjects with limited movement.

### Press the shutter button halfway.

- When the focus is locked, the AF confirmation mark lights up.
- A beep sound is output when the subject is in focus.

### Viewfinder



AF confirmation mark

### TIPS

#### When it is difficult to focus in the AF mode in low-light conditions:

→ The built-in flash can function as an AF illuminator. This makes focusing easier in low-light conditions using AF mode. "AF ILLUMINAT." (P. 93)

#### When you want to quickly switch from AF mode to MF:

→ By registering [MF] to the Fn button, you can press the Fn button to switch to MF mode. "Fn FUNCTION" (P. 96)

#### When you want to be able to shoot even if the subject is not in focus:

→ See "RLS PRIORITY S/RLS PRIORITY C" ( P. 97).

#### To not light up the AF target in the viewfinder when the subject is in focus:

→ The AF target in the viewfinder lights red when the subject is in focus. You can set the AF target so as not to turn on. "AF AREA POINTER" (P. 93)

## C-AF (continuous AF)

The camera repeats focusing while the shutter button remains pressed halfway. When the subject is in motion, the camera focuses on the subject in anticipation of its movement (Predictive AF). Even if the subject moves or you change the composition of the picture, the camera continues trying to focus.

#### Press the shutter button halfway and keep it in this position.

- When the subject is in focus and locked, the AF confirmation mark lights up.
- The AF target does not light up, even when the subject is in focus.
- The camera repeats focusing. Even if the subject moves or even if you change the composition of the picture, focusing is tried continuously.
- A beep sound is output when the subject is in focus. The beep sound is not output after the third continuous AF operation, even when the subject is in focus.

### TIPS

#### The camera focuses on something passing in front of the subject:

→ You can set the camera so as not to change the focus even if the distance to the subject changes. "C-AF LOCK" (P. 93)

## MF (manual focus)

This function allows you to manually focus on any subject.

#### Adjust the focus using the focus ring.

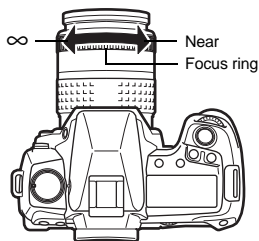

### TIPS

#### To change the rotational direction of the focus ring:

→ You can select the rotational direction of the focus ring to suit your preference for how the lens adjusts to the focusing point. "FOCUS RING" (P. 93)

#### For information on whether the subject is in focus (Focus aid):

→ When you focus the lens on a subject manually (by turning the focus ring), the AF confirmation mark lights. When is set with [AF AREA], AF confirmation lights up if the subject is in focus at the center AF target.

### Simultaneous use of S-AF mode and MF mode (S-AF+MF)

This function allows you to fine-adjust the focus manually by turning the focus ring after AF is performed in the S-AF mode.

- Press the shutter button halfway. After AF is confirmed, rotate the focus ring to fine-adjust the focus.

#### ! Notes

- If the shutter button is pressed again after fine-adjusting the focus with the focus ring, the AF is activated and your adjustments are canceled.

### Simultaneous use of C-AF mode and MF mode (C-AF+MF)

Focus with the focus ring and press the shutter button halfway to activate C-AF mode.

- While the shutter button is kept pressed, MF cannot be used.
- When the shutter button is not pressed, focusing with MF is possible.

#### TIPS

#### Another way to adjust focus manually in C-AF mode:

→ You can set the AEL/AFL button to operate C-AF. "AEL/AFL" (P. 95)

#### ! Notes

- If the shutter button is pressed again after fine-adjusting the focus with the focus ring, the AF is activated and your adjustments are canceled.

### AF target selection

This camera has 11 AF targets for focusing on the subject with auto focus. Select the optimal AF target mode according to your subject and the composition.

There are two AF target modes: All target AF mode, which uses AF at all AF targets, and Single target AF mode, which uses AF centering around one selected AF target.

#### All target AF mode

The camera automatically focuses on the subject in front of the camera from among the 11 AF targets. This is useful for shooting moving subjects or relying on the camera for focusing.

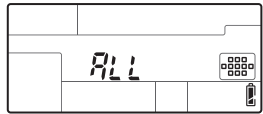
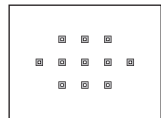

#### [ · ] Single target AF mode ([ · ]s Small-single target AF mode)

The camera focuses using one selected AF target. This is useful for accurately focusing on the subject after composing the shot. With [ · ], you can focus using a range that is somewhat larger than one AF target, but you can only set the range within the AF target. When [SMALL] is selected for [AF SENSITIVITY], the setting display changes to [ · ]s. "AF SENSITIVITY" (P. 93)

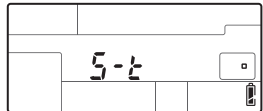
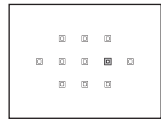

### [::]Dynamic-single target AF mode

If the camera cannot focus on the subject using the selected AF target, the camera focuses using the adjacent AF target.

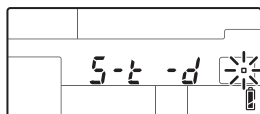
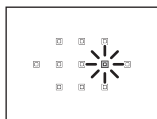
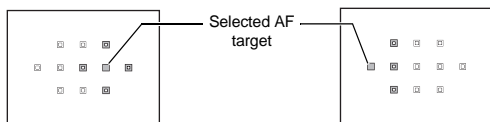

#### Direct button

[::] +

- When the button is released, the currently selected AF target lights. When [·] or [::] is set, you can select the AF target to be used at that point. For operation, refer to Step 2 in "Selecting the AF target position" (P. 56) in the next section.

#### Super control panel

: [AF AREA] +

- When [·] or [::] is set, you can turn the dial to select the AF target.

#### Menu

MENU : [AF AREA]

- When [·] or [::] is set, you can select the AF target with .

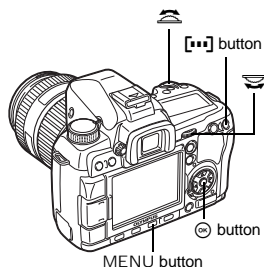

### Selecting the AF target position

Select the AF target to use with Single target AF mode.

- 1 Press the [::] button and release your finger to enable selection of the AF target.

- 2 Use the main dial/sub dial or arrow pad to select the AF target.

- Use the main dial to perform the same operation as , and use the sub dial to perform the same operation as .
- Press the button to return the position of the AF target to the center.

#### TIPS

#### Selecting the operation when the AF target is selected:

→ You can change the operation of the dials and arrow pad for selecting the AF target. "[::] SET UP" (P. 94)

#### Selecting the position of the AF target with the arrow pad without pressing the [::] button:

→ Press the shutter button halfway and release it, then use the arrow pad to change the position of the AF target. "FUNCTION" (P. 97)

#### Notes

- When [LIVE VIEW AF MODE] is set to [IMAGER AF] or [HYBRID AF], you cannot use the dynamic-single target AF mode.

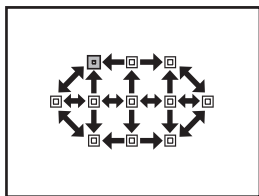



## Registering an AF target mode

You can register a frequently used AF target mode and the position of that AF target. You can then quickly load that registered setting ("home position") and use it when shooting.

### Registering

**1** In the screen of Step 2 of "Selecting the AF target position" (P. 56), press the **Fn** button and  button at the same time.

- The home position is registered at the time the buttons are pressed.
- The home position cannot be registered when operated from a menu.



Indicates that the AF target is being registered.

### Shooting

To use this function, you must assign the **[]HOME** function to the **Fn** button in advance.

 "Fn FUNCTION" (P. 96)

**1** Press the **Fn** button.

- The registered home position is selected. Press this button again to switch to the original AF target mode.

**!** Notes

- The AF sensitivity is not recorded when registering the home position.

## Focus lock – If correct focus cannot be obtained

The camera's auto focus may not be able to focus on the subject in situations such as when the subject is not in the center of the frame. If this happens, the easiest solution is to use focus lock. Use this when composing the subject outside of the AF targets or when the subject is difficult to focus on.

### 1 Adjust the AF target with the subject to be focused and press the shutter button halfway until the AF confirmation mark lights up.

- The focus is locked. The AF confirmation mark and the AF target in focus light up in the viewfinder.
- If the AF confirmation mark blinks, press the shutter button halfway again.
- While the shutter button is being pressed, the super control panel disappears.

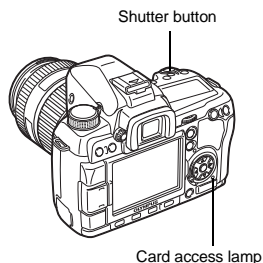

e.g.) The camera focuses using the center AF target.

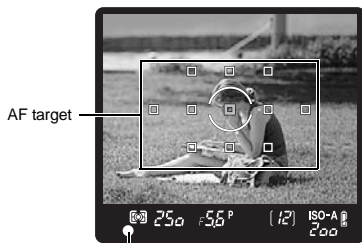

AF confirmation mark

### 2 While pressing the shutter button halfway, move to the desired composition and press the button all the way.

- The card access lamp blinks while the picture is being stored on the card.



### If the subject has lower contrast than its surroundings

If the contrast of the subject is weak, such as when the lighting is insufficient or the subject cannot be seen clearly because of fog, the focus may not be achieved. Focus (focus lock) on a high-contrast object the same distance away as the intended subject, recompose your shot and then take the picture.

## Sequential shooting



- Single-frame shooting Shoots 1 frame at a time when the shutter button is pressed (normal shooting mode).
- Sequential shooting H Shoots at 5 frames/sec. for as long as the shutter button is pressed (during S-AF, MF).
- Sequential shooting L Shoots at the set speed ( "L fps" (P. 97)) for as long as the shutter button is pressed.

- Press the shutter button fully and keep it pressed. The camera will take pictures in sequence until you release the button.
- Focus, exposure, and white balance are locked at the first frame (during S-AF, MF).



Number of sequential shots that can be taken

### Notes

- During sequential shooting, if the battery check blinks due to low battery, the camera stops shooting and starts saving the pictures you have taken on the card. The camera may not save all of the pictures depending on how much battery power remains.

### Setting method

#### Direct button



#### Super control panel

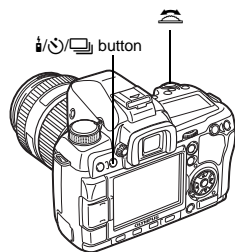
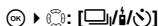

### Setting display

#### Viewfinder



Single-frame shooting

#### Control panel

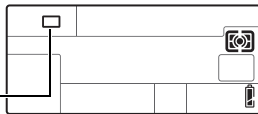

Sequential shooting H	: b-d H	
Sequential shooting L	: b-d L	
12-second self-timer	: SEL F 12	
2-second self-timer	: SEL F 2	
Remote control	: t-d 0	
2-second remote control	: t-d 2	

- Anti-shock display:

A blinking display in the viewfinder or on the control panel and the symbol on the super control panel indicates that anti-shock is activated.

## Self-timer shooting



This function lets you take pictures using the self-timer. You can set the camera to release the shutter after either 12 or 2 seconds. Fix the camera securely on a tripod for self-timer shooting. For the setting method, see "Sequential shooting" (P. 59).

### Press the shutter button all the way.

- When **12s** is selected:  
First, the self-timer lamp lights up for approximately 10 seconds, then it blinks for approximately 2 seconds and the picture is taken.
- When **2s** is selected:  
The self-timer lamp blinks for approximately 2 seconds, and then the picture is taken.
- To cancel the activated self-timer, press the button.

Self-timer lamp

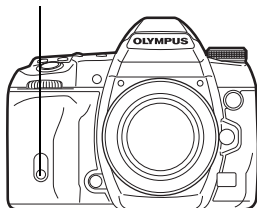

### Notes

- Do not press the shutter button while standing in front of the camera; this could result in the subject being out of focus since focusing is performed when the shutter button is pressed halfway.

3

Focusing and shooting functions

### Eyepiece cover

When shooting without looking through the viewfinder, attach the eyepiece cover to the viewfinder to prevent the light entering the viewfinder from changing the exposure. Attach the eyepiece cover after removing the eyecup as illustrated. The same applies when replacing with an optional eyecup.

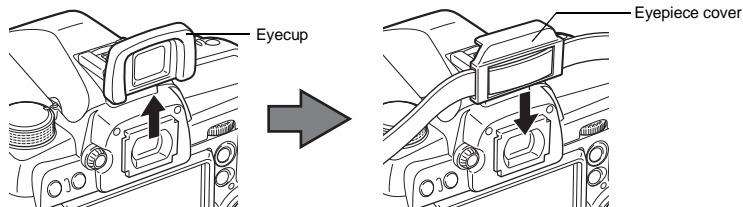

## Remote control shooting



By using the optional remote control (RM-1), you can take a picture with yourself in it or a night scene without touching the camera.

The camera can be set to release the shutter either right away or 2 seconds after the shutter button on the remote control is pressed. Bulb shooting is also possible when using the optional remote control.

For the setting method, see "Sequential shooting" (P. 59).

- Shooting can also be done using an optional remote control cable (RM-UC1).

**Mount the camera securely on a tripod, point the remote control at the remote control receiver on the camera and press the shutter button on the remote control.**

- When **⓪**s is selected:  
The focus and exposure are locked, the remote control lamp blinks and the picture is taken.
- When **Ⓜ**s is selected:  
The focus and exposure are locked, the remote control lamp blinks, and after approximately 2 seconds the picture is taken.

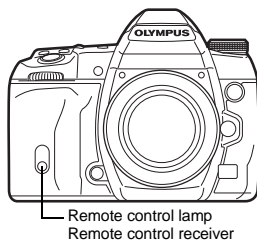

### **Transmitted signal effective area**

Point the remote control at the remote control receiver of the camera within the effective area as shown below.

When powerful lighting such as direct sunlight is shining on the remote control receiver, or when fluorescent light or devices emitting electrical or radio waves are nearby, it could narrow the effective area.

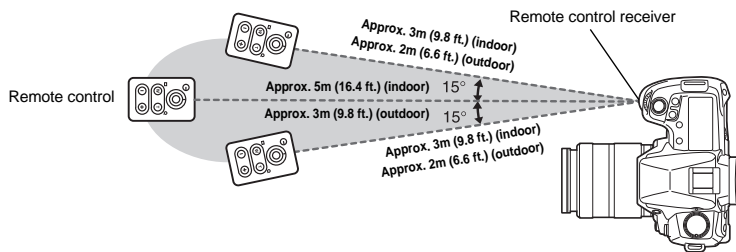

### **TIPS**

**The remote control lamp does not blink after the shutter button on the remote control is pressed:**

- The transmitted signal may not be effective if the remote control receiver is exposed to powerful lighting. Move the remote control closer to the camera and press the shutter button on the remote control again.
- The transmitted signal may not be effective if the remote control is too far from the camera. Move the remote control closer to the camera and press the shutter button on the remote control again.
- There is signal interference. Point the remote control toward the remote control receiver on the camera and press and hold down the CH button and the W or T zoom button on the remote control at the same time for at least three seconds until the remote control lamp on the camera blinks or a beep sound can be heard, indicating that the signal has been received.

**To cancel the remote control shooting mode:**

- The remote control shooting mode will not be canceled after shooting. Press the button to set to (single-frame shooting), etc.

**To use the shutter button on the camera in the remote control shooting mode:**

- The shutter button on the camera still works even in the remote control shooting mode.

### **Notes**

- The shutter will not be released if the subject is not in focus.
- Under bright light conditions, the remote control lamp may be difficult to see, making it hard to determine whether or not the picture has been taken.
- Zoom is not available on the remote control.

## Bulb shooting with the remote control

Set the mode dial to **M**, then set the shutter speed to **[BULB]**.

"Bulb shooting" (P. 45)

Press the **W** button on the remote control to open the shutter. When the time set in "BULB TIMER" ( P. 100) elapses, the shutter closes automatically.

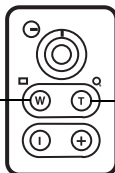

Press the **T** button to close the shutter.

## Anti-shock

**3** You can select the interval from the time the mirror is raised until the shutter is released. This diminishes camera shake caused by vibrations when the mirror moves. This feature can be useful in astrophotography and microscope photography or other photographic situations where a very slow shutter speed is used, and camera vibration needs to be kept to a minimum.

- 1** MENU  $\blacktriangleright$   $\blacktriangleright$  **[ANTI-SHOCK]**
- 2** Select the time delay after the mirror is raised and until the shutter is released from 1 to 30 seconds and press the button.
- 3** Anti-shock is added to the shooting functions individually (single-frame shooting, sequential shooting, self-timer shooting, and remote control shooting). For the setting method, see "Sequential shooting" ( P. 59).

## Image stabilizer

**IS**

You can reduce the amount of camera shake that easily occurs when shooting in low light situations or shooting with high magnification.

- OFF** Image stabilizer is off.
- I.S. 1** Image stabilizer is on.
- I.S. 2** This is used for panning with the camera in the horizontal direction to achieve a blurred background. The horizontal image stabilizer is turned off, and only the vertical image stabilizer is activated.
- I.S. 3** This is used for panning with the camera in the vertical direction to achieve a blurred background (tilting). The vertical image stabilizer is turned off, and only the horizontal image stabilizer is activated.

### Direct button

**IS**  $\blacktriangleright$

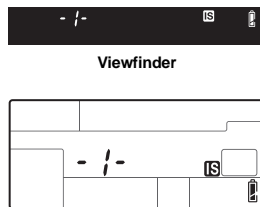

Control panel



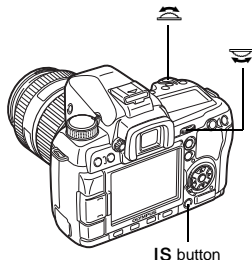

**IS**: OFF  
 **IS**: I.S. 1  
 **IS**: I.S. 2  
 **IS**: I.S. 3



IS button

## Setting the focal length

By setting in advance the focal length of the lens, you can use the image stabilizer function also with lenses other than Four Thirds system lenses. This setting is deactivated when a Four Thirds system lens is attached.

- 1 Press the  button when the image stabilizer is turned on.
- 2 Use the dial or   to set the focal length and press .

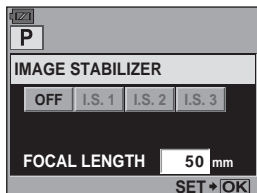

## Focal lengths that can be set (based on a 35-mm camera)

8 mm	10 mm	12 mm	16 mm	18 mm	21 mm	24 mm	28 mm	30 mm	35 mm
40 mm	48 mm	50 mm	55 mm	65 mm	70 mm	75 mm	80 mm	85 mm	90 mm
100 mm	105 mm	120 mm	135 mm	150 mm	180 mm	200 mm	210 mm	250 mm	300 mm
350 mm	400 mm	500 mm	600 mm	800 mm	1000 mm				

- If the focal length of the lens you are using is not listed, select the closest value.

## Checking the image stabilizer effect with live view

You can hold down the **IS** button during live view to see the effect of the image stabilizer on the monitor. While in that position, you can press the shutter button fully to take a picture.

- When **[IMAGE STABILIZER]** is set to **[OFF]**, pressing and holding the **IS** button activates the image stabilizer (**[I.S. 1]**).
- Either releasing the **IS** button or holding down the **IS** button for several seconds turns off the image stabilizer.

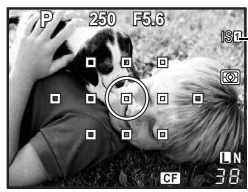

Green light : Image stabilizer active  
Red blinking : Image stabilizer failure

## Notes

- The image stabilizer cannot correct excessive camera shake or camera shake that occurs when the shutter speed is set to the slowest speed. In these cases, it is recommended that you use a tripod.
- When using a tripod, set **[IMAGE STABILIZER]** to **[OFF]**.
- When using a lens with an image stabilization function, turn off the image stabilization function of either the lens or the camera.
- If **[IMAGE STABILIZER]** is set to **[I.S.1]**, **[I.S.2]** or **[I.S.3]** and you turn off the camera, the camera will vibrate. This is due to the camera initializing the image stabilizer mechanism. Without this initialization, the image stabilizer may not be able to achieve the proper effect.
- If the image stabilizer icon blinks in red on the monitor, it indicates a failure of the image stabilizer function. If you take a picture as is, the composition may be off. Consult your Olympus Authorized Service Center.

## Selecting the record mode

You can select a record mode in which to take pictures. Choose the record mode that is best for your purpose (printing, editing on a PC, website editing, etc.).

## Recording formats

### JPEG

For JPEG images, select a combination of image size (**L**, **M**, **S**) and compression rate (SF, F, N, B). An image consists of pixels (dots). When you enlarge an image with a low pixel count, it will be displayed as a mosaic. If an image has a high pixel count, the file size (amount of data) will be larger and the number of storable still pictures will be lower. The higher the compression, the smaller the file size. However, the image will have less clarity when played back.

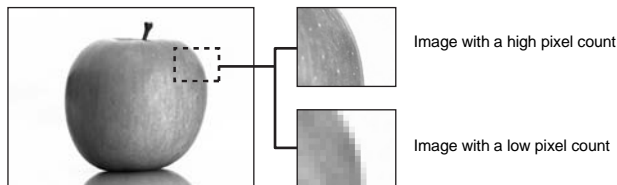

Image becomes clearer

Number of pixels increases

Application	Number of pixels	Pixel count	Compression rate			
			SF (Super Fine) 1/2.7	F (Fine) 1/4	N (Normal) 1/8	B (Basic) 1/12
Select for the print size	<b>L</b> (Large)	4032 x 3024	<b>L</b> SF	<b>L</b> F	<b>L</b> N	<b>L</b> B
		3200 x 2400	<b>M</b> SF	<b>M</b> F	<b>M</b> N	<b>M</b> B
		2560 x 1920				
For small-sized prints and use on a web site	<b>S</b> (Small)	1600 x 1200	<b>S</b> SF	<b>S</b> F	<b>S</b> N	<b>S</b> B
		1280 x 960				
		1024 x 768				
		640 x 480				



## RAW

This is unprocessed data that has not undergone changes in white balance, sharpness, contrast or color. To display as an image on the computer, use OLYMPUS Master. RAW data cannot be displayed on a different camera or by using common software, and it cannot be selected for print reservation. RAW files are assigned an ".ORF" file extension. RAW images can be edited with this camera and saved as JPEG data. "Editing still images" (P. 87)

## Selecting the record mode

### JPEG

For JPEG, you can register 4 combinations of images sizes (**L**, **M**, **S**) and compression rates (SF, F, N, B) from the 12 total combinations available. SET" (P. 102)

When you select the **M** or **S** image size, you can further select the pixel size.

"PIXEL COUNT" (P. 102)

### JPEG+RAW

Records both a JPEG and RAW image at the same time each time you take a picture.

### RAW

Records the image in RAW data format.

e.g.) The following 9 record modes are available when **L**/**F**/**N**/**M**/**N**/**S** are registered

RAW : RAW

JPEG : **L**/**F**/**N**/**M**/**N**/**S**

JPEG+RAW : **L**F+RAW/**N**+RAW/**M**+RAW/**S**+RAW

### Super control panel

: []

### Menu

MENU [] []

### TIPS

#### To quickly set the record mode:

→ By setting [**RAW** ] to the **F<sub>n</sub>** button, you can turn the dial while pressing the **F<sub>n</sub>** button to change the record mode.

Each time you press the **F<sub>n</sub>** button, you can easily switch between JPEG data only and JPEG and RAW data.

"F<sub>n</sub> FUNCTION" (P. 96)

#### To find out the file size/number of storable still pictures for each record mode:

→ "Record mode and file size/number of storable still pictures" ( P. 137)

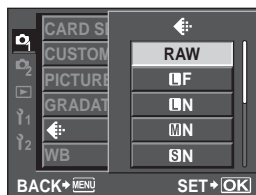
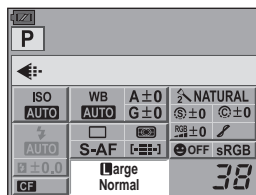

## Selecting the white balance

Color reproduction differs depending on the light conditions. For instance, when daylight or tungsten lighting is reflected on white paper, the shade of white produced will be slightly different for each. With a digital camera, white color can be adjusted to reproduce more natural white with a digital processor. This is called white balance. There are 4 options for setting the WB with this camera.

### Auto white balance [AUTO]

This function enables the camera to automatically detect white in images and adjust the color balance accordingly. Use this mode for general use.

### Preset white balance [☀][🏠][☁][💡][🔦][💡][💡][WB]

8 different color temperatures are preset according to the light source. For example, use preset WB when you want to reproduce more red in the picture of a sunset, or capture a warmer artistic effect under artificial lighting.

### Custom white balance [CWB]

You can set the color temperature from 2000K to 14000K. For details on color temperature, refer to "White balance color temperature" (📖 P. 136).

### One-touch white balance [📷]

You can set the optimum white balance for the shooting conditions by pointing the camera at a white object like a sheet of white paper. The white balance achieved with this setting is saved as one of the preset WB settings.

4

Record mode, white balance, and picture mode

WB mode	Light conditions
AUTO	Used for most light conditions (when there is a white portion framed in the viewfinder). Use this mode for general use.
☀ 5300K	For shooting outdoors on a clear day, or to capture the reds in a sunset or the colors in a fireworks display
🏠 7500K	For shooting outdoors in the shadows on a clear day
☁ 6000K	For shooting outdoors on a cloudy day
💡 3000K	For shooting under a tungsten light
💡 4000K	For shooting under white fluorescent lighting
💡 4500K	For shooting under a neutral white fluorescent lamp
💡 6600K	For shooting under a daylight fluorescent lamp
WB 5500K	For flash shooting
📷	Color temperature set by one-touch WB. 📖 "Setting the one-touch white balance" (P. 69)
CWB	Color temperature set in custom white balance menu. This can be set from 2000K to 14000K. When the value has not been set, it is set to 5400K.

You can adjust the white balance by selecting the appropriate color temperature for the light conditions.

**Direct button** WB ▶

**Super control panel** ▶ : [WB]

- Custom white balance is set by selecting [CWB] and turning the dial while pressing down the button.

**Menu** MENU ▶ ▶ [WB]

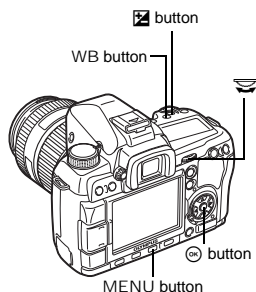

## Setting display



WB mode  
• During custom white balance, the color temperature is displayed.

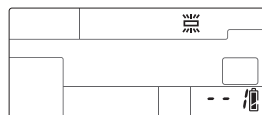

Control panel

-A-	:	AWB
-dL-	:	
-Sh-	:	
-cL-	:	
-LA-	:	
--1	:	--1
--2	:	--2
--3	:	--3
-FL-	:	
-0-	:	-0-
5400	:	5400

### TIPS

#### When subjects that are not white appear white:

→ In the auto WB setting, if there is no near-white color in the image framed in the screen, the white balance will not be correctly determined. In such a case, try preset WB or one-touch WB settings.

#### White balance sensor

This camera has a white balance sensor for determining the light source in the shooting environment. The white balance sensor measures and calculates the infrared and visible light, and determines whether the light source is sunlight, fluorescent lighting, floodlighting, a blue flat lamp, or other lighting. When shooting, be careful not to cover or shade the sensor.

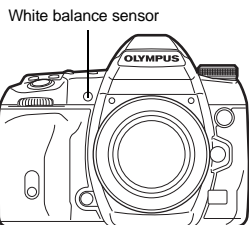

## WB compensation

This function lets you make fine changes to the auto WB and preset WB settings.

### Direct button

WB + : adjust in A direction/  
: adjust in G direction

- Use the sub dial to set in the A direction or the main dial to set in the G direction.

### Super control panel

: [WB%]

### Menu

MENU : [WB]

- Select the white balance to adjust and press .

### Adjusting the white balance in the A direction (Amber-Blue)

Depending on the original WB conditions, the image will become more amber when adjusted toward +, and bluer when adjusted toward –.

### Adjusting the white balance in the G direction (Green-Magenta)

Depending on the original WB conditions, the image will become greener when adjusted toward +, and magenta when adjusted toward –.

- The white balance can be adjusted in 7 increments in each direction.

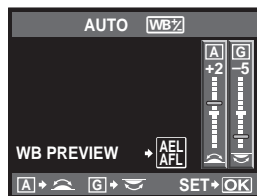

Direct buttons setting screen

4

Record mode, white balance, and picture mode

### Setting display

e.g. 1) When the A direction and G direction are each adjusted toward –

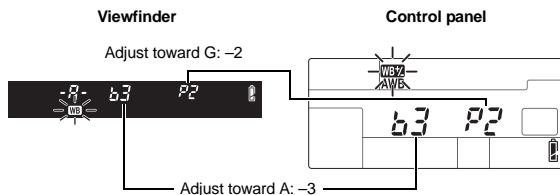

e.g. 2) When the A direction and G direction are each adjusted toward +

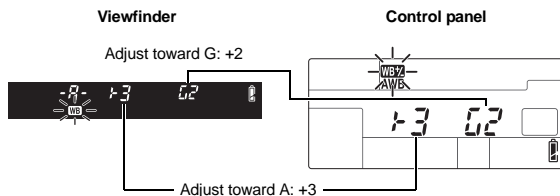

#### TIPS

### Checking the white balance you have adjusted:

→ After setting the compensation value, point the camera at the subject to take test shots. When the AEL/AF-L button is pressed, sample images that have been taken with the current WB settings are displayed.

### Adjusting all WB mode settings at once:

→ See "ALL [WBZ]" (P. 101).

## Setting the one-touch white balance

This function is useful when you need a more precise white balance than preset WB can provide. Point the camera at a sheet of white paper under the light source you want to use to determine the white balance. The optimum white balance for the current shooting conditions can be saved in the camera. This is useful when shooting a subject under natural light, as well as under various light sources with different color temperatures.

Set [Fn] FUNCTION to [ ] beforehand. (P. 96)

- 1 Point the camera at a sheet of white paper.**
  - Position the paper so that it fills the viewfinder. Make sure there are no shadows.
- 2 While holding down the Fn button, press the shutter button.**
  - The one-touch white balance screen appears.
- 3 Select [YES] and press the  $\odot$  button.**
  - The white balance is registered.
  - The registered white balance will be stored in the camera as a preset WB setting. Turning the power off does not erase the data.

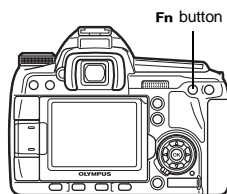

4

Record mode, white balance, and picture mode

#### TIPS

### After pressing the shutter button, [WB NG RETRY] is displayed:

→ When there is not enough white in the image, or when the image is too bright, too dark or the colors look unnatural, you cannot register the white balance. Change the aperture and shutter speed settings, then repeat the procedure from Step 1.

## WB bracketing

Three images with different white balances (adjusted in specified color directions) are automatically created from one shot. One image has the specified white balance, while the others are the same image adjusted in different color directions.

### Direct button

WB +  $\odot$   $\rightarrow$   $\rightarrow$ : EV step in A-B direction/  
 $\leftarrow$ : EV step in G-M direction

- Use the sub dial to set in the A-B direction or the main dial to set in the G-M direction.

### Menu

MENU  $\rightarrow$  [ ]  $\rightarrow$  [WB BKT]

## Setting display

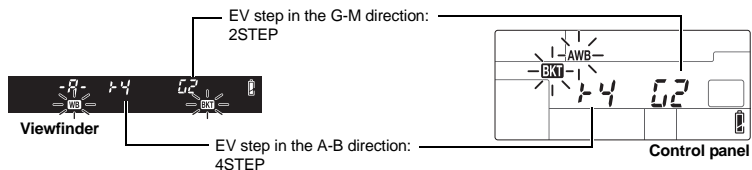

- Select from [OFF], [3F 2STEP], [3F 4STEP], or [3F 6STEP] for the EV step for both the A-B (amber-blue) direction and the G-M (green-magenta) direction.
- When the shutter button is pressed down all the way, 3 images adjusted in specified color directions are automatically created.



Direct buttons setting screen

4

### TIPS

#### To apply WB bracketing to the white balance you have adjusted:

→ Adjust white balance manually, then use the WB bracketing feature. WB bracketing is applied to the white balance you have adjusted.

#### Notes

- During WB bracketing, the camera cannot shoot the pictures if there is not enough memory in the camera and card for storing at least the selected number of frames.

## Picture mode

You can select image tone to create unique image effects. You can also fine-adjust image parameters such as contrast and sharpness for each mode. The adjusted parameters are recorded in each picture effect mode.

- [VIVID] : Produces vivid colors.
- [NATURAL] : Produces natural colors.
- [MUTED] : Produces flat tones.
- [PORTRAIT] : Produces beautiful skin tones.
- [MONOTONE] : Produces black and white tone.
- [CUSTOM] : Select one picture mode, set the parameters, and register the setting. You can also register the gradation to [CUSTOM]. This setting is stored separately from [GRADATION] in the menu. "Gradation" (P. 71)

### Super control panel

: [PICTURE MODE]

### Menu

MENU : [PICTURE MODE]

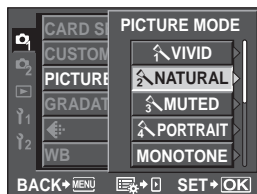

The adjustable parameters vary according to the picture modes.

The individual parameters are as follows.

- [CONTRAST]** : Distinction between light and dark
- [SHARPNESS]** : Sharpness of the image
- [SATURATION]** : Vividness of the color
- [B&W FILTER]** : Creates a black and white image. The filter color is brightened and the complementary color is darkened.

**[N: NEUTRAL]** : Creates a normal black and white image.

**[Ye: YELLOW]** : Reproduces clearly defined white cloud with natural blue sky.

**[Or: ORANGE]** : Slightly emphasizes colors in blue skies and sunsets.

**[R: RED]** : Strongly emphasizes colors in blue skies and brightness of crimson foliage.

**[G: GREEN]** : Strongly emphasizes colors in red lips and green leaves.

**[PICT. TONE]** : Colors the black and white image.

**[N: NEUTRAL]** : Creates a normal black and white image.

**[S: SEPIA]** : Sepia

**[B: BLUE]** : Bluish

**[P: PURPLE]** : Purplish

**[G: GREEN]** : Greenish

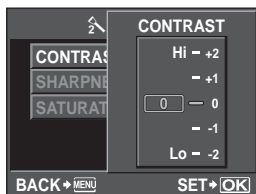
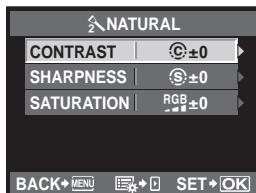

## Gradation

In addition to the **[NORMAL]** gradation setting, you can select from 3 other gradation settings.

**[HIGH KEY]** : Gradation for a bright subject.

**[LOW KEY]** : Gradation for a dark subject.

**[AUTO]** : Divides the image into detailed regions and adjusts the brightness separately for each region. This is effective for images with areas of large contrast in which the whites appear too bright or the blacks appear too dark.

**[NORMAL]** : Use **[NORMAL]** mode for general uses.



**HIGH KEY**

Suitable for a subject that is mostly highlighted.



**LOW KEY**

Suitable for a subject that is mostly shadowed.

### ! Notes

- Contrast adjustment does not work when set to [HIGH KEY], [LOW KEY], or [AUTO].

## Noise reduction

This function reduces the noise that is generated during long exposures. When shooting night scenes, shutter speeds are slower and noise tends to appear in images. With [NOISE REDUCT.], you can let the camera reduce noise automatically to produce clearer images. When set to [AUTO], noise reduction will be activated only when the shutter speed is slow. When set to [ON], noise reduction will always be activated. While noise reduction is activated, it takes about twice the usual time to take a picture.

4

Record mode, white balance, and picture mode



OFF



ON/AUTO

- The noise-reduction process is activated after shooting.
- The card access lamp blinks and [busy] is displayed on the viewfinder while noise reduction is operating. You cannot take more pictures until the card access lamp turns off.

### ! Notes

- During sequential shooting, [NOISE REDUCT.] is [OFF] automatically.
- This function may not work effectively with some shooting conditions or subjects.

Noise reduction [ON]

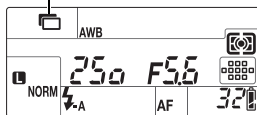

## Noise filter

You can select the noise processing level. Use [STANDARD] for general use. [HIGH] is recommended during high sensitivity shooting.



**Flash mode setting**

The camera sets the flash mode according to various factors such as firing pattern and flash timing. Available flash modes depend on the exposure mode. The flash modes are available to optional external flashes.

**Auto flash AUTO**

The flash fires automatically in low light or backlight conditions. To shoot a subject with backlighting, position the AF target over the subject.

**Flash synchronization speed/Slow limit**

Shutter speed can be changed when the built-in flash fires. "X-SYNC." (P. 101), "SLOW LIMIT" (P. 101)

**Red-eye reduction flash**

In the red-eye reduction flash mode, a series of pre-flashes are emitted just before the regular flash fires. This helps accustom the subject's eyes to the bright light and minimizes the red-eye phenomenon. In **S/M** mode, the flash always fires.



The subject's eyes appear red

**! Notes**

- After the pre-flashes, it takes about 1 second before the shutter is released. Hold the camera firmly to avoid camera shake.
- Effectiveness may be limited if the subject is not looking directly at pre-flashes, or if the shooting range is too far. Individual physical characteristics may also limit effectiveness.

**Slow synchronization (1st curtain)**

The slow synchronization flash is designed for slow shutter speeds. Normally, when shooting with a flash, shutter speeds cannot go below a certain level to prevent camera shake. But when shooting a subject against a night scene, fast shutter speeds can make the background too dark. Slow synchronization allows you to capture both the background and the subject. Since the shutter speed is slow, be sure to stabilize the camera by using a tripod so as not to cause the picture to be blurred.

**1st curtain**

Usually, the flash fires right after the shutter fully opens. This is called 1st curtain. This method is usually used during flash shooting.

## Slow synchronization (2nd curtain) ⚡ SLOW2/2nd CURTAIN

2nd curtain flash fires just before the shutter closes. Changing the flash timing can create interesting effects in your picture, such as expressing the movement of a car by showing the tail-lights streaming backwards. The slower the shutter speed, the better the effects turn out. In **S/M** mode, the flash always fires.

When the shutter speed is set to 2 sec.

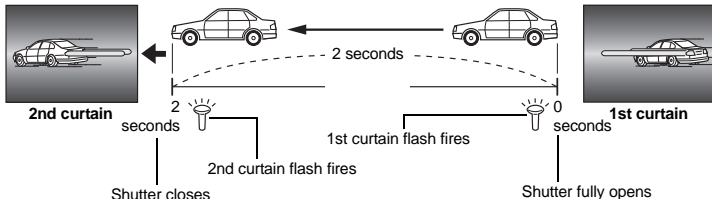

## Slow synchronization (1st curtain)/Red-eye reduction flash 👁 SLOW

While using slow synchronization with flash shooting, you can also use this function to achieve red-eye reduction. When shooting a subject against a night scene, this function allows you to reduce the red-eye phenomenon. As the time from emitting pre-flashes to shooting is long in 2nd curtain synchronization, it is difficult to achieve red-eye reduction. Hence, only 1st curtain synchronization setting is available.

5

Flash shooting

## Fill-in flash ⚡

The flash fires regardless of the light conditions. This mode is useful for eliminating shadows on the subject's face (such as shadows from tree leaves), in a backlight situation, or for correcting the color shift produced by artificial lighting (especially fluorescent light).



### ! Notes

- When the flash fires, the shutter speed is set to 1/250 sec. or less. When shooting a subject against a bright background with the fill-in flash, the background may be overexposed. In this case, use the optional FL-50R external flash or a similar flash and shoot in the Super FP flash mode. 📷 "Super FP flash" (P. 79)

## Flash off 🔕

The flash does not fire.

Even in this mode, the flash can be used as an AF illuminator when it is raised. 📷 "AF ILLUMINAT." (P. 93)

## Manual flash

This allows the built-in flash to output a fixed amount of light. To shoot with manual flash, set the f-number on the lens based on the distance to the subject.

Ratio of amount of light	GN: Guide number ISO 200 (Equivalent to ISO 100)
FULL (1/1)	18 (13)
1/4	9 (6.5)
1/16	4.5 (3.3)
1/64	2.3 (1.6)

Calculate the f-number on the lens using the following formula.

$$\text{Aperture (f-number)} = \frac{\text{GN} \times \text{ISO sensitivity}}{\text{Distance to the subject (m)}}$$

## ISO sensitivity

ISO value	100	200	400	800	1600	3200
ISO sensitivity	1.0	1.4	2.0	2.8	4.0	5.6

## Setting method

### Direct button



### Super control panel

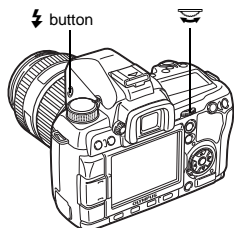

5

Flash shooting

## Setting display

### Viewfinder



Flash mode

### Control panel

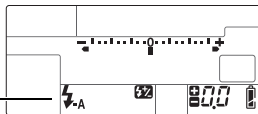

- For details on displaying the settings, refer to “Flash modes that can be set by shooting mode” (P. 135).

## Built-in flash shooting

If you shoot a subject using a lens that is wider than 14mm (equivalent to 28mm on a 35mm film camera), the light emitted by the flash may produce a vignette effect. Whether or not vignetting occurs also depends on lens type and shooting conditions (such as distance to the subject).

### 1 Press the button to raise the built-in flash.

- The built-in flash will pop up automatically and fire in low light conditions under the following modes.

AUTO/

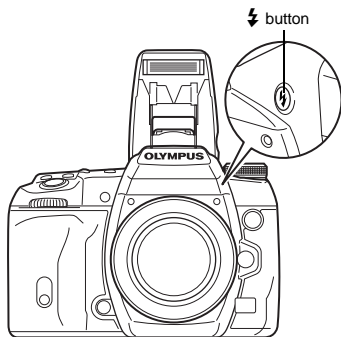

### 2 Press the shutter button halfway.

- The  (flash stand-by) mark lights when the flash is ready to fire. If the mark is blinking, the flash is charging. Wait until charging is complete.

Flash stand-by mark



Viewfinder

### 3 Press the shutter button all the way.

#### TIPS



**When you do not want the flash to pop up automatically:**

→ Set [AUTO POP UP] to [OFF].  "AUTO POP UP" (P. 101)

**To shoot without having to wait for the flash to finish charging:**

→ See "RLS PRIORITY S/RLS PRIORITY C" ( P. 97).

#### Notes

- When [ RC MODE] is set to [ON], the built-in flash will fire only to communicate with the external flash so it will not function as a flash.  "Shooting with the Olympus wireless RC flash system" (P. 79)

## Flash intensity control

The flash intensity can be adjusted from +3 to -3.

In some situations (e.g., when shooting small subjects, distant backgrounds, etc.), you may get better results by adjusting the amount of light emitted by the flash ("flash intensity"). It is useful when you intend to increase the contrast (distinction between light and dark) of images to make the images more vivid.

### Direct button



### Super control panel



### Menu

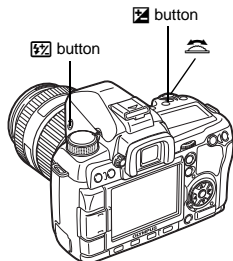

## Setting display

Viewfinder



Control panel



### TIPS

#### To adjust the flash using only the dials:

→ Assign the flash intensity control function to the main dial (or sub dial). [Fn] "DIAL FUNCTION" (P. 94)

### Notes

- This does not work during manual flash.
- This does not work when the flash control mode on the electronic flash is set to MANUAL.
- If flash intensity is adjusted on the electronic flash, it will be combined with the camera's flash intensity setting.
- When [Fn] + [Fn] is set to [ON], the flash intensity value will be added to the exposure compensation value. [Fn] "Fn + Fn" (P. 101)

## Flash bracketing

The camera shoots multiple frames, changing the amount of light emitted by the flash for each shot. The camera shoots 3 frames at a time with the following amount of light: optimum light, light adjusted in the – direction, and light adjusted in the + direction.

### Menu

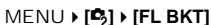

- The compensation value will change according to the EV step. [Fn] "EV STEP" (P. 100)
- In single-frame shooting, the amount of light emitted by the flash changes every time the shutter button is pressed.
- In sequential shooting, hold down the shutter button until the selected number of frames are taken.
- Releasing the shutter button stops flash bracketing shooting. When it stops, [BKT] blinks in the viewfinder and on the control panel and [BKT] is displayed in green on the super control panel.

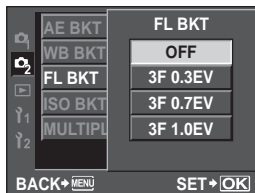

## External flash shooting

In addition to the camera's built-in flash capabilities, you can use any of the external flash units specified for use with this camera. This enables you to take advantage of a wider variety of flash shooting techniques to suit different shooting conditions. The external flashes communicate with the camera, allowing you to control the camera's flash modes with various available flash control modes, such as TTL-AUTO and Super FP flash. An external flash unit specified for use with this camera can be mounted on the camera by attaching it to the camera's hot shoe. You can also attach the flash to the flash bracket on the camera using the bracket cable (optional). Refer to the external flash's manual as well.

### Functions available with external flash units

Optional flash	FL-50R	FL-50	FL-36R	FL-36	FL-20	RF-11	TF-22
Flash control mode	TTL-AUTO, AUTO, MANUAL, FP TTL AUTO, FP MANUAL				TTL-AUTO, AUTO, MANUAL	TTL-AUTO, MANUAL	
GN (Guide number) (ISO100)	GN50 (85 mm <sup>*</sup> ) GN28 (24 mm <sup>*</sup> )		GN36 (85 mm <sup>*</sup> ) GN20 (24 mm <sup>*</sup> )		GN20 (35 mm <sup>*</sup> )	GN11	GN22
RC mode	✓	—	✓	—	—	—	—

\* The focal length of the lens that can be used (Calculated based on 35 mm film camera)

### Notes

- The FL-40 optional flash cannot be used.

5

## Using the external electronic flash

Flash shooting

Be sure to attach the flash to the camera before turning on the flash's power.

### 1 Remove the hot shoe cover by sliding it in the direction indicated by the arrow in the illustration.

- Keep the shoe cover in a safe place to avoid losing it. You can attach the shoe cover to the back of the eyepiece cover, which is attached to the strap. Put the shoe cover back on the camera after removing the external flash.

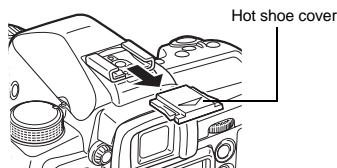

### 2 Attach the electronic flash to the hot shoe on the camera.

- If the lock pin is protruding, turn the shoe lock ring as far as it will go in the direction opposite to LOCK. This will pull the lock pin back inside.

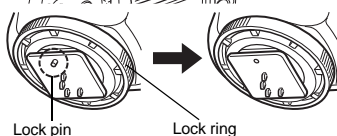

### 3 Turn on the flash.

- When the charge lamp on the flash lights up, charging is complete.
- The flash will be synchronized with the camera at a speed of 1/250 sec. or less.

### 4 Select a flash mode.

### 5 Select the flash control mode.

- TTL-AUTO is recommended for normal use.

### 6 Press the shutter button halfway.

- Shooting information such as ISO sensitivity, aperture value, and shutter speed is communicated between the camera and flash.

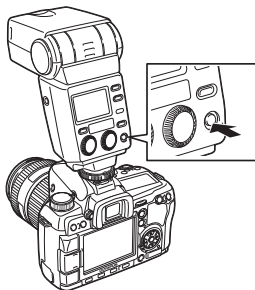

### 7 Press the shutter button all the way.

## Notes

- The built-in flash cannot be used when an external flash is attached to the hot shoe.

## Super FP flash

Super FP flash is available with the FL-50R or FL-36R. You can use the Super FP flash even where normal flashes cannot be used with high shutter speed.

Fill-in flash shooting with the aperture open (such as in outdoor portrait shooting) is also possible with Super FP flash. For details, refer to the external flash's manual.

Super FP flash



## Shooting with the Olympus wireless RC flash system

Wireless flash shooting is possible with the Olympus wireless RC flash system. With this wireless flash system, you can take pictures using multiple wireless flashes and control the flashes in three groups (A, B, and C). The built-in flash is used to communicate between the camera and the external flashes.

For details on using the wireless flash, see the manual of the external flash.

### Wireless flash setup range

Position the wireless flash so that the wireless sensor faces the camera. The setup range guidelines are as shown below. The range changes according to the surrounding environment.

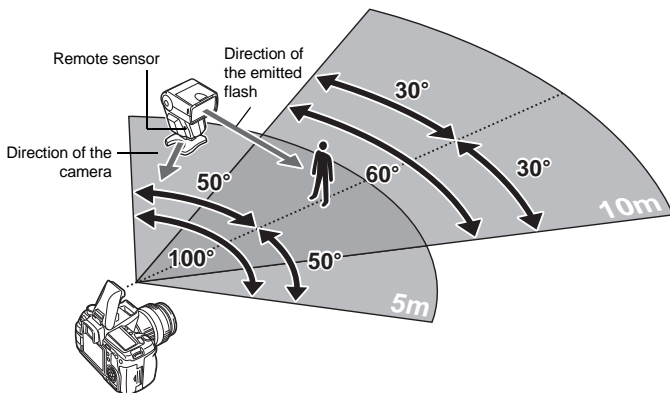

- 1 Position the flash while referring to the “Wireless flash setup range”, and turn on the flash.**
- 2 Press the MODE button on the flash to set it to RC mode, and set the channel and group of the flash.**
- 3 Set RC mode on the camera to [ON].**
  - MENU ▶ [ ] ▶ [RC MODE] ▶ [ON]
  - The super control panel switches to RC mode.
  - You can press the INFO button to switch the super control panel display.

#### 4 Use the super control panel to set the flash mode and other settings for each group.

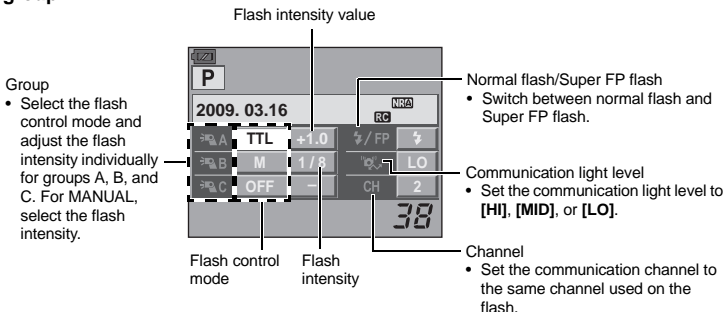

#### 5 Select a flash mode.

- Red-eye reduction flash is not possible in RC mode.

#### 6 Press the button to raise the built-in flash.

#### 7 After shooting preparations are completed, take some test shots to check the flash operation and images.

#### 5 8 Begin shooting while checking the charging completed indications of the camera and flash.

#### Notes

- Although there is no limit to the number of wireless flashes you can use, it is recommended that each group have no more than three flashes to prevent flash malfunction due to mutual interference.
- In RC mode, the built-in flash is used to control the wireless flash. The built-in flash cannot be used for flash shooting in this mode.
- For 2nd curtain synchronization, set the shutter speed and anti-shock settings to within 4 seconds. Wireless flash shooting may not operate properly when using a slower shutter speed or anti-shock setting.



## Using commercially available flashes

You cannot use the camera to adjust the amount of light emitted from a commercially available flash except for a flash specified for use with this camera. To use a commercially available flash, connect it to the hot shoe or connect the synchronization cord to the external flash connector. Set the camera's shooting mode to **M**. For details on non-specified commercial flashes, see "Non-specified commercial flashes" (P. 81).

- 1 Remove the hot shoe cover to connect the flash unit to the camera.**
- 2 Set the shooting mode to **M**, then set the aperture value and shutter speed.**
  - Set the shutter speed to 1/250 sec. or slower. If the shutter speed is faster than this, commercially available flashes cannot be used.
  - A slower shutter speed may produce blurred images.
- 3 Turn on the flash.**
  - Be sure to turn on the flash after attaching the flash unit to the camera.
- 4 Set the ISO sensitivity and aperture value on the camera to match the flash control mode on the flash.**
  - Refer to the flash's manual for instructions on how to set its flash control mode.

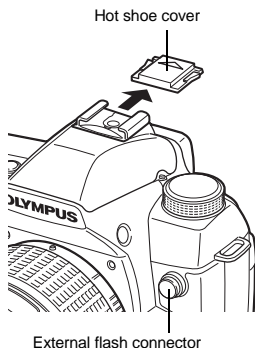

### ! Notes

- The flash fires each time the shutter is released. When you do not need to use the flash, turn off the flash's power.
- Check beforehand that the flash you are using is synchronized with the camera.

### Non-specified commercial flashes

- 1) Some commercially available flashes require a voltage of 250V or more for the synchronization connector. The use of this type of flash can damage the camera or prevent the camera from operating properly. Contact the manufacturer of the flash for the specifications of the flash synchronization connector.
- 2) Some commercially available flashes have a synchronization connector with reversed polarity. This type of flash does not work with this camera. Contact the manufacturer of the flash.
- 3) Exposures when using a flash require that adjustments be made on the flash. If a flash is used in the auto mode, match it with the f-number and ISO sensitivity settings on the camera.
- 4) Even if the flash auto f-number and ISO sensitivity are set the same as on the camera, the correct exposure may not be obtained depending on the shooting conditions. In such a case, adjust the auto f-number or ISO on the flash or calculate the distance in the manual mode.
- 5) Use a flash with an illumination angle that matches the focal length of the lens. The focal length of the lens for 35 mm film is approximately twice as long as the focal length of the lenses designed for this camera.
- 6) Do not use a flash unit or other accessory TTL flash that has additional communication functions other than the specified flashes, since it may not only fail to function normally, but may also cause damage to the camera's circuitry.

## Single-frame/Close-up playback



The basic procedure for viewing pictures are as shown below.

However, before using any of these functions, follow Step 1 below. You can set the camera to automatically switch to single-frame playback mode after shooting. **REC VIEW** (P. 108)

### 1 Press the button (Single-frame playback).

- The last recorded image appears.
- The LCD monitor turns off after more than 1 minute if no operations are performed. The camera will turn off automatically if there is no operation after 4 hours. Turn on the camera again.

### 2 Use to select images you want to view. You can also turn the dial to switch to for close-up playback.

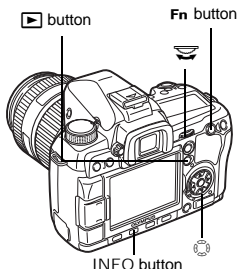

(Single-frame)



- : Displays the frame that is stored 10 frames back
- : Displays the frame that is stored 10 frames ahead
- : Displays the next frame
- : Displays the previous frame

Press the **Fn** button

- Plays back the image at a 10x magnified close-up position.

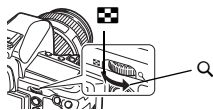

(Close-up playback)

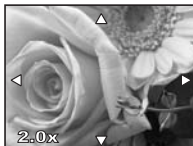

Press to change the close-up position.

Press the **INFO** button

(Close-up position playback)



Press to move the display of the close-up position. When **[FACE DETECT]** (P. 38) is set to **[ON]**, a frame is displayed around a detected face. Press to move the frame to another face.

Press the **INFO** button

(Close-up frame-by-frame playback)



Press to view frame-by-frame close-ups. When **[FACE DETECT]** is set to **[ON]**, press to move to another face in close-up position.

- Press the **INFO** button to return to close-up playback.

- To exit the playback mode, press the button again.
- Pressing the shutter button halfway resumes the shooting mode.

## Light box display

You can view the playback image and another image together on the left and right sides of the monitor. This is useful if you want to compare images you recorded using bracketing.

### 1 Press the [ ] button during single-frame playback.

- The frame being viewed is displayed on the left side of the monitor, and the next frame is displayed on the right side. The image is displayed at the same magnification of the image being viewed.
- The image on the left is the benchmark image.

### 2 Press $\odot$ to select the image on the right.

- You can protect, erase or copy the image on the right.

### 3 Press the [ ] button.

- The camera returns to single-frame playback of the image on the left at the magnification being viewed.

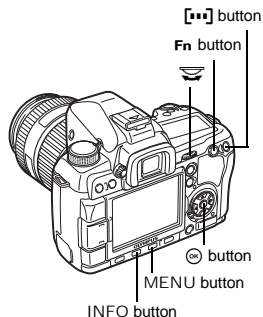

Benchmark image

AF compensation value during shooting

AF compensation value in the telephoto direction

AF compensation value in the wide direction

### Operations during light box display

- Pressing the  $\odot$  button replaces the image on the left with the image on the right and becomes the new benchmark image.
- You can use the dial to change the magnification of both images at the same time.
- Pressing the Fn button or INFO button allows you to move the position of the image on the right with the  $\odot$  button. Pressing the Fn button or INFO button again allows you to move the positions of both images with the  $\odot$  button.

$\odot$  : Selects the right image

$\odot$  : Scrolls the right image

$\odot$  : Scrolls both images in synchronization

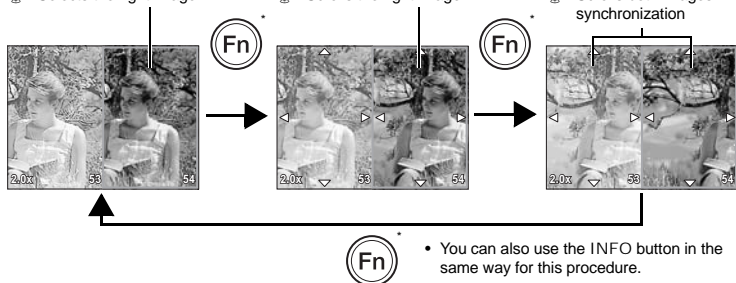

- You can also use the INFO button in the same way for this procedure.

## Index display/Calendar display





This function lets you show several images on the monitor at the same time. This is useful when you want to quickly search a number of pictures to find a particular image.

During single-frame playback, each time you turn the dial toward , the number of images shown changes between 4, 9, 16, 25, 49 and 100 pictures.

 : Moves to the previous frame

 : Moves to the next frame

 : Moves to the upper frame

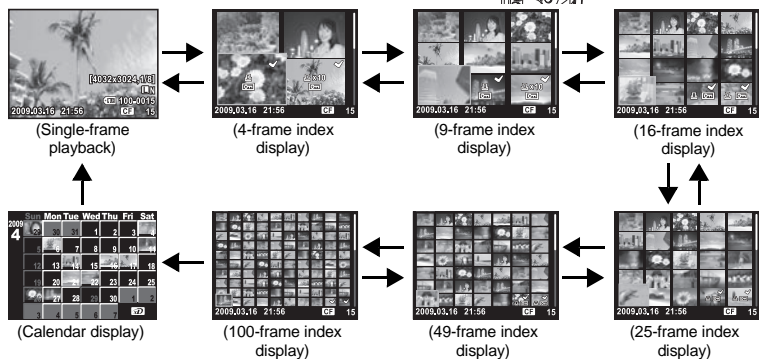
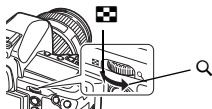
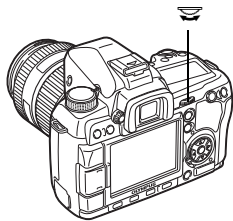

 : Moves to the lower frame

- To return to single-frame playback, turn the main dial to Q.



### Calendar display

With the calendar, you can display images recorded on the card by date. If more than one image was taken on a single date, the image shot first on that date is displayed.

Use  to select a date and press the  button to play back images for the selected date in single-frame display.

This allows you to display detailed information about the image. Luminance information can also be displayed with histogram and highlight graphs.

**Press the INFO button repeatedly until the desired information is displayed. You can also switch the information displayed by turning the dial while pressing the INFO button.**

- This setting is stored and will be shown the next time the information display is called up.

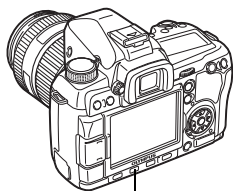

INFO button

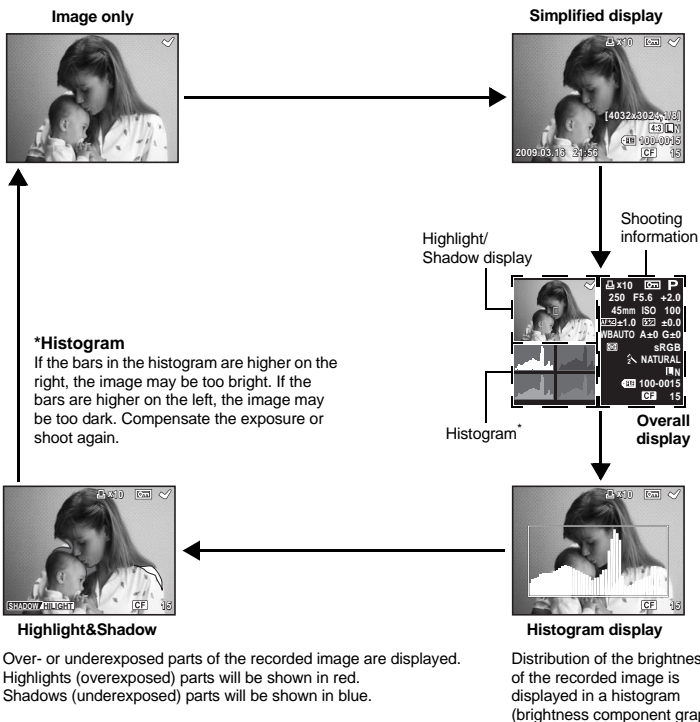
**TIPS**

**To quickly switch to the frequently used display:**

→ You can hide the information display for all modes except "Simplified display". Press "INFO SETTING" (P. 99)

## Slideshow

This function displays images stored on the card one after another. Images are displayed one by one for about 5 seconds starting from the currently displayed image. Slideshow can be performed using index display. You can select the number of frames displayed during slideshow from 1, 4, 9, 16, 25, 49 or 100.

- 1 MENU ▶ [▶] ▶ [🖼️]
- 2 Use to select the number of frames displayed.
- 3 Press the button to start the slideshow.
- 4 Press the button to stop the slideshow.



When selecting [4]

### ! Notes

- If the slideshow is left running for about 30 minutes while using the battery, the camera will turn off automatically.

## Rotating images

This function lets you rotate images and display them vertically on the monitor during single-frame playback. This is useful when taking pictures with the camera held vertically. The images will automatically be displayed in the correct direction even if the camera is rotated.

- 1 MENU ▶ [▶] ▶ [🖼️]
  - When set to [ON], images shot vertically will be automatically rotated and displayed during playback. You can also press the button to rotate and display the image.
  - The rotated image will be recorded on the card in that position.

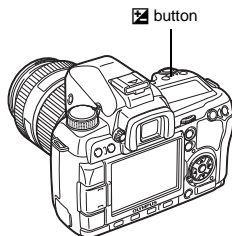

Original image before rotating

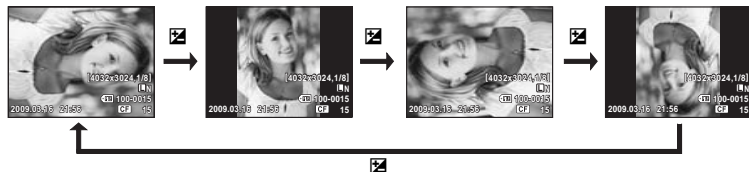

## Playback on TV

Use the video cable provided with the camera to play back recorded images on your TV.

- 1 Turn the camera and TV off, and connect the video cable as illustrated.
- 2 Turn on the TV and set it to the video input mode. For details on switching to the video input mode, refer to the TV's manual.
- 3 Turn the camera on and press the  (playback) button.

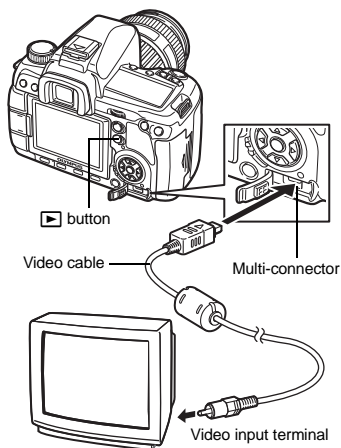

### ! Notes

- To connect the camera to a TV, use the provided video cable.
- Make sure that the camera's video output signal type is the same as the TV's video signal type.  "VIDEO OUT" (P. 108)
- The camera's monitor turns off automatically when the video cable is connected to the camera.
- The image may appear off-center depending on the TV screen.

## Editing still images

Recorded images can be edited and saved as new images. Available editing functions depend on the image format (image record mode).

A JPEG file can be printed as is without modification. A RAW file, on the other hand cannot be printed as is. To print a RAW file, use the RAW edit function to convert the RAW data format to JPEG.

### Editing images recorded in RAW data format

The camera performs image processing (such as white balance and sharpness adjustment) on images in the RAW data format, then saves the data to a new file in the JPEG format. While checking recorded images, you can edit them to your liking.

**Image processing is performed based on the current camera settings. Change the camera settings to suit your preferences before editing.**

## Editing images recorded in JPEG data format

[SHADOW ADJ]

Brightens a dark backlit subject.

[REDEYE FIX]

Reduces the red-eye phenomenon during flash shooting.

[

Set the trimming size with the main dial and the trimming position with the arrow pad.

[BLACK & WHITE]

Creates black and white images.

[SEPIA]

Creates sepia-toned images.

[SATURATION]

Sets the color depth. Adjust the color saturation checking the picture on the screen.

[

Converts the image file size to 1280 x 960, 640 x 480, or 320 x 240.



Images with an aspect ratio other than 4:3 (standard) are converted to the closest image file size.

[ASPECT]

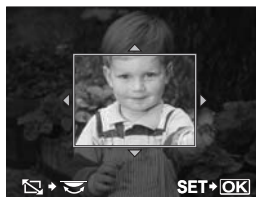
Changes the aspect ratio of images from 4:3 (standard) to [3:2], [16:9], [6:6], [5:4], [7:6], [6:5], [7:5], or [3:4]. After changing the aspect ratio, use the arrow pad to specify the trimming position.



1 MENU ▸ [] ▸ [EDIT] ▸ [RAW/JPEG]

2 Use () () to select an image, then press the () button.

- The camera recognizes the image data format.
- For images recorded in JPEG+RAW, a selection screen will appear, asking you which data to edit.

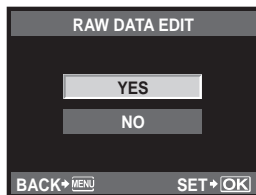
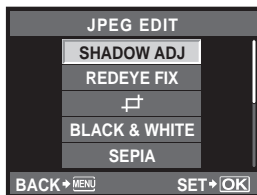
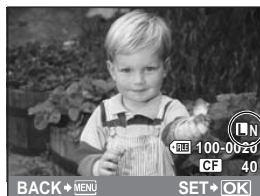

3 The setting screen varies with the image data format. Select the item you want to edit and do the following steps.

Confirm the data format from here.



- The edited image is saved as another image, apart from the original image.
- To exit the edit mode, press the MENU button.

### ! Notes

- Red-eye correction may not work depending on the image. Red-eye correction may affect other parts of the image, as well as the eyes.
- Editing of a JPEG image is not possible in the following cases:
  - When an image is recorded in RAW, when an image is processed on a PC, when there is not enough space in the card memory, when an image is recorded on another camera.
- When resizing () an image, you cannot select a larger number of pixels than was originally recorded.
- [] and [ASPECT] can only be used to edit images with an aspect ratio of 4:3 (standard).



## Image overlay

Up to 4 frames of RAW images taken with the camera can be overlaid and saved as a separate image. The image is saved with the record mode set at the time the image is saved.

- 1 MENU ▶ [▶] ▶ [EDIT] ▶ [IMAGE OVERLAY]
- 2 Select the number of frames to overlay and press the **OK** button.
- 3 Use **◂** to select a frame and press the **OK** button.
  - Repeatedly select images only for the number of frames selected in Step 2.
  - To cancel your selection, press the **OK** button again.
- 4 Use **◂** to select an image, then use **⏪** to select the gain for each image. Press the **OK** button.
  - Select from 0.1 to 2.0.
  - The displayed image changes as the gain is adjusted.
- 5 Use **⏪** to select [YES], then press the **OK** button.

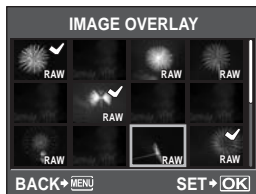



### TIPS

#### To overlay 5 or more frames:





→ To overlay 5 or more frames, save the overlay image as a RAW file and use [IMAGE OVERLAY] repeatedly.

#### Notes

- When the record mode is set to [RAW], the overlay image is saved as [N+RAW].

This function lets you copy images to and from the xD-Picture Card and CompactFlash or Microdrive. This menu can be selected if both cards are inserted. The selected card is the copying source.   "CF/xD" (P. 107)

### Single-frame copy





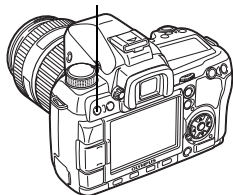



- 1 Play back the image you want to copy and press the COPY/ button.
- 2 Use   to select [YES], then press the  button.

COPY/ button









### Copying selected frames

This function lets you select multiple images and copy them all at the same time during single-frame playback or index display.

- 1 Display the images you want to copy and press the  button.
  - The selected images will be shown with .
  - To cancel your selection, press the  button again.
- 2 Press  to display the next images you want to copy and press the  button.
- 3 After you have selected the images to copy, press the COPY/ button.
- 4 Use   to select [YES], then press the  button.



### Copying all the frames

- 1 MENU  [ ]  [COPY ALL]
- 2 Press .
- 3 Use   to select [YES], then press the  button.



Protect images you do not want to erase. Protected images cannot be erased by the single-frame or all-frame erase function.

### Single-frame protect

Play back the image you want to protect and press the button.

- (protect mark) is displayed on the top right corner of the screen.

#### To cancel the protection

Display the images that are protected and press the button.

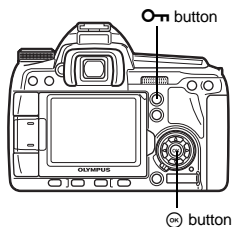

### Protecting selected frames

This function lets you select multiple images and protect them all at the same time during single-frame playback or index display.

- 1 Display the images you want to protect and press the button.
  - The selected images will be shown with .
  - To cancel your selection, press the button again.
  - During index display, press to select the images you want to protect and press the button.
- 2 Press to display the next images you want to protect and press the button.
- 3 After you have selected the images to protect, press the button.

### Canceling all protections

This function lets you cancel the protection of several images at one time.

- 1 MENU ▸ ▸ [RESET PROTECT]
- 2 Use to select [YES], then press the button.

#### ! Notes

- Formatting the card erases all images even if they have been protected.
- "Formatting the card" (P. 127)
- Protected images cannot be rotated even when the button is pressed.

## Erasing images



Lets you erase recorded images. You can select single-frame erase, which erases only the currently displayed image; all-frame erase, which erases all the images stored on the card; or selected frame erase, which erases only the frames selected.

### Notes

- When you perform all-frame or selected frame erase on images recorded using RAW+JPEG, both the RAW and JPEG images are erased. When using single-frame erase, you can select whether to erase the JPEG, RAW, or both RAW and JPEG images. "RAW+JPEG ERASE" (P. 103)
- Protected images cannot be erased. Cancel protected images, then erase them.
- Once erased, images cannot be restored. "Protecting images" (P. 91)

### Single-frame erase

- 1 Display the images you want to erase and press the button.
- 2 Use to select [YES], then press the button.

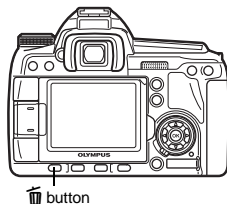

button

### Erasing selected frames

This function lets you erase selected images at one time during single-frame playback or index display.

- 1 Display the images you want to erase and press the button.
  - The selected images will be shown with .
  - To cancel your selection, press the button again.
  - During index display, press to select the images you want to erase and press the button.
- 2 Press to display the next images you want to erase and press the button.
- 3 After you have selected the images to erase, press the .
- 4 Use to select [YES], then press the button.

### All-frame erase

- 1 MENU [M] [CARD SETUP]
  - 2 Use to select [ALL ERASE], then press the .
  - 3 Use to select [YES], then press the .
- All frames will be erased.

### TIPS

#### To erase immediately:

- If you have set "QUICK ERASE" ( P. 103) to [ON], pressing the will erase an image immediately.
- You can set the initial position of the cursor to [YES]. "PRIORITY SET" (P. 104)

## 7 Customizing your camera

Use the custom menus to customize the camera for ease of use. Use Custom Menu 1 to customize the shooting functions and Custom Menu 2 to set the basic camera functions. Custom Menu 1 has 9 tabs (A to I) that are divided according to the functions to be set.

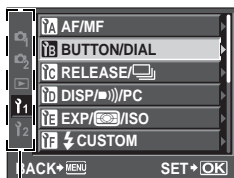

Use  $\leftarrow$   $\rightarrow$  to select [A], then press  $\leftarrow$ .

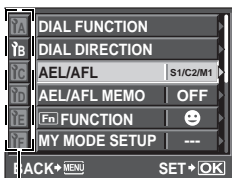

Use  $\leftarrow$   $\rightarrow$  to select tab [A] to [I], then press  $\leftarrow$ .

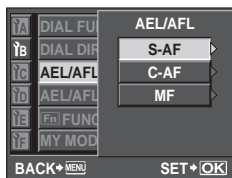

Use  $\leftarrow$   $\rightarrow$  to select a function, then press  $\leftarrow$ .

For details on using the menu lists, see "Setting on the menu" (P. 23).

### Custom Menu 1 ▶ A AF/MF

#### AF ILLUMINAT.

The built-in flash can be set to function as an AF illuminator. This makes focusing easier in low-light conditions using AF mode. To use this function, raise the flash.

#### FOCUS RING

You can customize how the lens adjusts to the focal point by selecting the rotational direction of the focus ring.

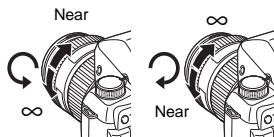

#### C-AF LOCK

When set to [ON], during focusing with C-AF mode, this prevents the focus from changing even if the distance to the subject suddenly changes. This is effective when shooting at a location where something passes in front of or behind the subject.

#### AF AREA POINTER

When set to [OFF], the AF target does not light in the viewfinder when the subject is in focus.

#### AF SENSITIVITY

You can set the range of the AF target for focusing when [AF AREA] is set to [·].

**[NORMAL]** The camera focuses using a range that is somewhat larger than the selected AF target.

**[SMALL]** The camera focuses only within the selected AF target. When [SMALL] is selected, the setting display for [AF AREA] becomes [·].

## [**•••**] SET UP

Selects the operation of the dials or arrow pad when selecting the AF target.

- [OFF]** Stops after moving to the AF target on the end.
- [LOOP]** After moving to the AF target on the end, moves to the AF target on the opposite end of the same row or column. Selects all AF targets before moving to the AF target on the opposite end, and **[AF AREA]** is set to **[**••••**]**.
- [SPIRAL]** After moving to the AF target on the end, moves to the AF target on the opposite end of the next row or column. Selects all AF targets before moving to the AF target on the opposite end, and **[AF AREA]** is set to **[**••••**]**.

e.g.) When moving from the top left AF target to the right

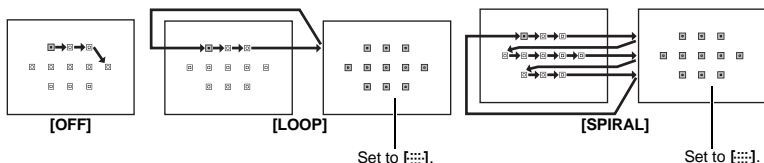

## RESET LENS

When set to **[ON]**, this resets the focus of the lens (infinity) each time the power is turned off.

## BULB FOCUSING

You can set the camera to enable focus adjustments during bulb shooting with MF.

- [ON]** During exposure, you can turn the focus ring and adjust the focus.
- [OFF]** The focus is locked during exposure.

## LIVE VIEW AF MODE

P. 35

7



## Custom Menu 1 ▶ **[B]** BUTTON/DIAL

### DIAL FUNCTION

In **P**, **A**, **S**, or **M** mode, you can assign functions other than the default functions to the main dial and sub dial. You can also switch the operations of the main dial and sub dial for menu operations with the default operations.

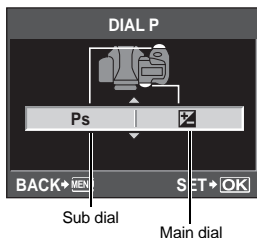
- P** : [**Ps**]/**[**1/2**]**/**[**1/2**]**
- A** : [**FN.**]/**[**1/2**]**/**[**1/2**]**
- S** : [**SHUTTER**]/**[**1/2**]**/**[**1/2**]**
- M** : [**SHUTTER**]/**[FN.]**
- MENU** : [**◀▶**]/**[**↕** / VALUE**]





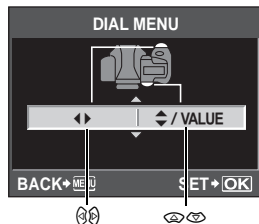

- [**◀▶**] on [**MENU**] means the horizontal operation of the dial (the same as pressing ) . [**↕ / VALUE**] means the vertical operation of the dial (the same as pressing ) .



## DIAL DIRECTION

You can select the rotational direction of the dial and the direction in which the shutter speed/aperture value will increase or decrease.

Setting	  (rotational direction of the dial)	  (rotational direction of the dial)
<b>DIAL1</b>	<ul style="list-style-type: none"> <li>• Slower shutter speed</li> <li>• Open the aperture (f-number is decreased)</li> </ul>	<ul style="list-style-type: none"> <li>• Faster shutter speed</li> <li>• Close the aperture (f-number is increased)</li> </ul>
<b>DIAL2</b>	<ul style="list-style-type: none"> <li>• Faster shutter speed</li> <li>• Close the aperture (f-number is increased)</li> </ul>	<ul style="list-style-type: none"> <li>• Slower shutter speed</li> <li>• Open the aperture (f-number is decreased)</li> </ul>

## AEL/AFL

You can use the AEL/AFL button to perform AF or metering operations instead of using the shutter button.

Select the function of the button to match the operation when the shutter button is pressed.

Select [**mode1**] to [**mode4**] in each focus mode. (You can only select [**mode4**] in C-AF mode.)

Mode	Shutter button function				AEL/AFL button function	
	Half-press		Full press		When holding down AEL/AFL	
	Focus	Exposure	Focus	Exposure	Focus	Exposure
<b>[S-AF]</b>						
<b>mode1</b>	S-AF	Locked	—	—	—	Locked
<b>mode2</b>	S-AF	—	—	Locked	—	Locked
<b>mode3</b>	—	Locked	—	—	S-AF	—
<b>[C-AF]</b>						
<b>mode1</b>	C-AF start	Locked	Locked	—	—	Locked
<b>mode2</b>	C-AF start	—	Locked	Locked	—	Locked
<b>mode3</b>	—	Locked	Locked	—	C-AF start	—
<b>mode4</b>	—	—	Locked	Locked	C-AF start	—
<b>[MF]</b>						
<b>mode1</b>	—	Locked	—	—	—	Locked
<b>mode2</b>	—	—	—	Locked	—	Locked
<b>mode3</b>	—	Locked	—	—	S-AF	—

## Basic operations

- [mode1]** For determining the metered exposure while focusing. AE lock is activated while pressing the AEL/AFL button, allowing you to adjust the focus and determine the exposure separately.
- [mode2]** For determining the exposure when you press the shutter button fully. This is useful for shooting scenes with significant changes in lighting, such as on a stage.
- [mode3]** For focusing with the AEL/AFL button instead of the shutter button.
- [mode4]** Press the AEL/AFL button to focus, and press the shutter button fully to determine the exposure.

## AEL/AFL MEMO

You can lock and maintain the exposure by pressing the AEL/AFL button.

- [ON]** Press the AEL/AFL button to lock and maintain the exposure. Press again to cancel the maintaining of the exposure.
- [OFF]** The exposure will be locked only while the AEL/AFL button is pressed.

## **Fn** FUNCTION

You can assign a function to the **Fn** button.

### **[Fn FACE DETECT]**

Press the **Fn** button to set **[FACE DETECT]** to **[ON]** and activate the optimal settings. Press again to set it to **[OFF]**.  "Using the face detection function" (P. 38), **[FACE DETECT]** (P. 99)

### **[PREVIEW]/[LIVE PREVIEW] (electronic)**

While holding down the **Fn** button, you can use the preview function. When set to **[LIVE PREVIEW]**, pressing the **Fn** button automatically switches the camera to live view for a preview of the picture on the monitor.  "Preview function" (P. 45)



Press the **Fn** button to acquire the WB value.  "Setting the one-touch white balance" (P. 69)

### **[HOME]**

Press the **Fn** button to switch to the registered AF home position. Press the button again to switch to the original AF target mode. If you turn off the camera while it is set to the AF home position, the original position will not be stored.  "Registering an AF target mode" (P. 57)

### **[MF]**

Press the **Fn** button to switch AF mode to **[MF]**. Press the button again to switch to the original AF mode.

### **[RAW]**

Press the **Fn** button to switch from JPEG to JPEG+RAW or from JPEG+RAW to JPEG for the record mode. You can change the record mode by turning the dial while holding down the **Fn** button.

### **[TEST PICTURE]**

Pressing the shutter button while pressing the **Fn** button enables you to check the picture you have just taken on the monitor without having to record the picture to the card. This is useful when you want to see how a picture turned out without saving it.

### **[MY MODE]**

While holding down the **Fn** button, you can take pictures using the camera settings registered in the **[MY MODE SETUP]**.  "MY MODE SETUP" (P. 97)

### **[LEVEL GAUGE]**

Press the **Fn** button to display the level gauge in the viewfinder and on the control panel, and press it again to hide the level gauge display.  "LEVEL GAUGE" (P. 99)

### **[OFF]**

Does not allow function allocation.



## MY MODE SETUP

You can store two frequently used settings as My Mode. You can select which My Mode setting to use in advance by following the steps under "Executing" below. To use My Mode, set **[Fn FUNCTION]** to **[MY MODE]** and hold down the **Fn** button while shooting. "Fn FUNCTION" (P. 96)

### Registering

- 1) Select **[MY MODE1]** or **[MY MODE2]** and press .
- 2) Select **[SET]** and press the button.
  - The current settings are registered in the camera. For details on the functions that can be registered to My Mode, refer to "Functions that can be registered with My Mode and Custom Reset Setting" ( P. 138).
  - To cancel the registration, select **[RESET]**.

### Executing

- 1) Select **[MY MODE1]** or **[MY MODE2]** and press the button.
- 2) Select **[YES]** and press the button.
  - The selected My Mode is set.
  - When shooting, press the shutter button while holding down the **Fn** button.

## BUTTON TIMER

The direct button may remain selected even after it is released.

<b>[OFF]</b>	Available only when the button is pressed.
<b>[3SEC]/[5SEC]/[8SEC]</b>	The button remains selected during the number of seconds indicated.
<b>[HOLD]</b>	The button remains selected until you press it again.

- Buttons that can be set with **[BUTTON TIMER]**  
ISO, WB, , AF,



You can switch the functions of the AEL/AFL button and the **Fn** button. When you select **[ON]**, the AEL/AFL button will function as the **Fn** button, and the **Fn** button will function as the AEL/AFL button.

- The setting also applies to the **Fn** button on the optional power battery holder when attached to the camera.

### FUNCTION

When selecting **[•••]**, you can use the arrow pad to select the position of the AF target. You can perform this operation for several seconds after pressing the shutter button halfway and then releasing it. "Selecting the AF target position" (P. 56)

## Custom Menu 1 ▶ RELEASE/

### RLS PRIORITY S/RLS PRIORITY C

Normally, this camera does not release the shutter while the AF is operating or the flash is charging. If you want to release the shutter without waiting until these operations have completed, use the setting below. You can set the release priority individually in AF mode. RLS PRIORITY S Sets release priority for S-AF mode P. 53. RLS PRIORITY C Sets release priority for C-AF mode P. 54.

### L fps

You can set the number of pictures shot in one second when using sequential shooting with L from **[1fps]** to **[4fps]**.

■))

You can turn off the beep sound that is emitted when the focus locks by pressing the shutter button.

### SLEEP

After a specified period of time elapses with no operations being performed, the camera enters the sleep mode (stand-by) to save battery power. After the super control panel is displayed for a specified period of time, the backlight turns off. After a specific period of time has further passed, the camera enters sleep mode. **[SLEEP]** lets you select sleep timer from **[1MIN]**, **[3MIN]**, **[5MIN]**, or **[10MIN]**. **[OFF]** cancels the sleep mode. The camera activates again as soon as you touch any button (the shutter button, [ ] button, etc.).

### BACKLIT LCD (Backlight timer)

To save battery power, after the super control panel is displayed for a specified period of time, the monitor backlight turns off and the monitor darkens. Select from **[8SEC]**, **[30SEC]**, or **[1MIN]** for the time until the backlight turns off. **[HOLD]** sets the backlight to stay on. The monitor backlight turns on again as soon as you touch any button (the shutter button, arrow pad, etc.).

### 4 h TIMER (Auto power off)

You can set the camera to turn off automatically if not operated for 4 hours. It will not turn off if this is set to **[OFF]**.

### USB MODE

You can connect the camera directly to a computer or printer with the provided USB cable. If you specify the device you are connecting to beforehand, you can skip the USB connection setting procedure normally required every time you connect the cable to the camera. For details on how to connect the camera to either device, refer to "Connecting the camera to a printer" (P. 113) and "Connecting the camera to a computer" (P. 117).

#### [AUTO]

The selection screen for the USB connection will be displayed every time you connect the cable to a computer or printer.

#### [STORAGE]

Allows you to transfer images to a computer. Also, select to use the OLYMPUS Master software via PC connection.

#### [MTP]

Allows you to transfer images to a computer running Windows Vista without using the OLYMPUS Master software.

#### [CONTROL]

Allows you to control the camera from a PC using the optional OLYMPUS Studio.

#### [EASY]

Can be set when connecting the camera to a PictBridge-compatible printer. Pictures can be printed directly without using a PC. "Connecting the camera to a printer" (P. 113)

#### [CUSTOM]

Can be set when connecting the camera to a PictBridge-compatible printer. You can print out pictures with set number of prints, print paper and other settings. "Connecting the camera to a printer" (P. 113)

## LIVE VIEW BOOST

During live view shooting, you can brighten the monitor for easier confirmation on the subject.

### [OFF]

The subject is displayed on the monitor with the brightness level that is adjusted according to the exposure being set. You can shoot while confirming through the monitor in advance to get a picture that is to your liking.

### [ON]

The camera automatically adjusts the brightness level and displays the subject on the monitor for easier confirmation. The effect of the exposure compensation adjustments will not be reflected on the monitor.

## LV FRAME RATE

You can change the frame rate of the live view display.

### [NORMAL]

Gives priority to display details.

### [HIGH]

Gives priority to the speed at which the live view display changes rather than display details. This reduces the phenomenon in which the shutter closes slowly due to a slower frame rate.

## ☺ FACE DETECT



When set to [ON], the camera will detect people's faces and automatically adjust the focus there.  "Using the face detection function" (P. 38)

You can play back close-up images focusing on the subject's face.  "Single-frame/Close-up playback" (P. 82)





## INFO SETTING

Select the information displayed when the INFO button is pressed during live view or playback.

### [▶]INFO

Sets whether to display or hide [IMAGE ONLY], [OVERALL], , [HIGHLIGHT&SHADOW] during playback.  "Information display" (P. 85)

### [LV-INFO]

Sets whether to display or hide , [ZOOM], [MULTI VIEW], [IMAGE ONLY], , , or  during live view.  "Switching the information display" (P. 39)

## LEVEL GAUGE

This camera has an acceleration sensor that enables display of a bi-directional level gauge to detect tilting horizontally and in the forward and backward direction when [LEVEL GAUGE] is set to [ON]. Use this as a guide in situations where you cannot determine whether the camera is level, such as when you cannot see the horizon or skyline on the screen or when the screen is dark while shooting night scenes.

### Viewfinder and control panel indications:

Press the shutter button halfway to display the level gauge in the viewfinder and on the control panel after a few seconds.

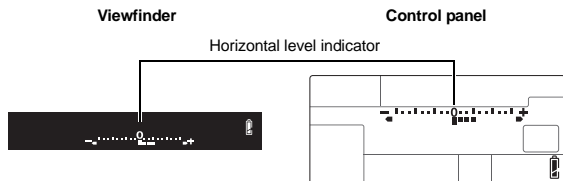

### Monitor indication:

Press the INFO button repeatedly to display the level gauge.  "Switching the information display" (P. 39)



Displayed when outside the display range.

### TIPS

#### To calibrate the level gauge:

→  "LEVEL ADJUST" (P. 107)

#### To easily turn on and off the level gauge:

→ By registering [LEVEL GAUGE] to the Fn button, you can press the Fn button to display or hide the level gauge.  "Fn FUNCTION" (P. 96)

### Notes

- If the camera is tilted forward or backward to a large degree, the error of the horizontal titling increases.

## Custom Menu 1 ▶

### EV STEP

You can select the EV step for exposure parameter setting, such as shutter speed, aperture value, or exposure compensation value, from [1/3EV], [1/2EV], or [1EV].

### ISO STEP

You can select the EV step of the ISO sensitivity from [1/3EV] or [1EV].

### ISO-AUTO SET

You can set the upper limit and default ISO values when ISO is set to [AUTO].

#### [HIGH LIMIT]

This sets the upper limit of the ISO value that automatically changes. The upper limit can be set from 200 to 3200 in 1/3 EV increments.

#### [DEFAULT]

This sets the value to be normally used when the optimum exposure can be obtained. The value can be set from 200 to 3200 in 1/3 EV increments.

### ISO-AUTO

You can set the shooting mode in which the ISO [AUTO] setting is activated.

#### [P/A/S]

The [AUTO] setting is activated in all shooting modes except **M** mode. When [AUTO] is selected in **M** mode, ISO 200 is set.

#### [ALL]

The [AUTO] setting is activated for all shooting modes. The ISO is automatically selected to obtain the optimal ISO even in **M** mode.

### AEL Metering

You can set the metering mode when pressing the AEL/AFL button to lock the exposure.

- [AUTO] performs metering in the mode selected under [METERING].

### BULB TIMER

You can select the maximum time (in minutes) for bulb shooting.

## Custom Menu 1 ▸ CUSTOM

---

### X-SYNC.

---

You can set the shutter speed that will be used when the flash fires. The speed can be set from 1/60 to 1/250 in 1/3 EV increments.

### SLOW LIMIT

---

You can set the slow limit of the shutter speed that will be used when the flash fires. The speed can be set from 1/30 to 1/250 in 1/3 EV increments.



When set to [ON], it will be added to the exposure compensation value and flash intensity control will be performed.

### AUTO POP UP

---

In AUTO or scene mode, the built-in flash pops up automatically in low light or backlight conditions. When set to [OFF], the built-in flash will not pop up automatically.

## Custom Menu 1 ▸ ◀- /ASPECT/COLOR/WB

---

### ALL

---

You can apply the same compensation value to all the white balance modes at once.

**[ALL SET]**

The same compensation value applies to all WB modes.

**[ALL RESET]**

The WB compensation value settings applied to each WB mode are all cleared at once.

### **If you select [ALL SET]**

1) Use to select the color direction.

Toward A: Amber-Blue/Toward G: Green-Magenta

2) Use to set the compensation value. "WB compensation" (P. 68)

Releasing the AEL/AFL button takes a sample image. You can check the white balance you have adjusted.

### **If you select [ALL RESET]**

1) Use to select [YES].

### COLOR SPACE

---

You can select how colors are reproduced on the monitor or printer. The first character in image file names indicates the current color space. "FILE NAME" (P. 104)

Pmdd0000.jpg

└─ P: sRGB  
   └─ : Adobe RGB

**[sRGB]**

Standardized color space for Windows.

**[Adobe RGB]**

Color space that can be set with Adobe Photoshop.

## SHADING COMP.

In some cases, the edges of the image may be shadowed due to the properties of the lens. The shading compensation function compensates by increasing brightness at the dark edge of the image. This function is especially useful when a wide-angle lens is used.

### Notes

- This function is not available when a teleconverter or an extension tube is attached to the camera.
- At higher ISO settings, noise in image edges may be conspicuous.

### SET

You can combine 3 image sizes and 4 compression rates and register 4 combinations. Select the registered setting with [◀SET].

☞ "Selecting the record mode" (P. 64)

Register 4 different combinations of image settings.

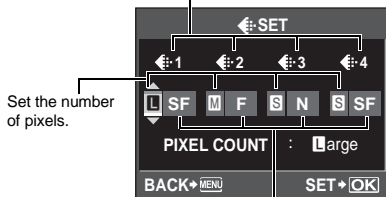

## PIXEL COUNT

You can set the pixel size for the image size [M] and [S].

[Middle] Select [3200 x 2400], [2560 x 1920], or [1600 x 1200].

[Small] Select [1280 x 960], [1024 x 768], or [640 x 480].

## IMAGE ASPECT

You can change the aspect ratio (horizontal-to-vertical ratio) when taking pictures using live view. Depending on your preference, you can set the aspect ratio to [4:3] (standard), [3:2], [16:9], [6:6], [5:4] (for 8" x 10" prints), [7:6]/[6:5] (for 10" x 12" prints), [7:5], or [3:4]. JPEG images are trimmed and saved according to the aspect ratio.

### Notes

- RAW images are not trimmed and are recorded with the aspect ratio information at the time of shooting.
- During RAW image playback, images are displayed with a border based on the aspect ratio.

### TIPS

To use [IMAGE ASPECT] when taking pictures using the viewfinder:

→ Set [ASPECT SHOOTING] to [ALL].

☞ "ASPECT SHOOTING" (P. 103)

To change the aspect ratio of recorded images:

→ You can only change the aspect ratio when the aspect ratio of the image is set to [4:3].

☞ "Editing still images" (P. 87)

To trim recorded images:

→ You can only trim images when the aspect ratio of the image is set to [4:3].

☞ "Editing still images" (P. 87)

## ASPECT SHOOTING

When the aspect ratio for shooting is set to a setting other than [4:3], select whether the setting is effective only when taking pictures using live view, or anytime when taking pictures using the viewfinder or live view.

[LV] The setting is only effective when taking pictures using live view.

[ALL] The setting is effective when taking pictures using the viewfinder or live view.

### ! Notes

- When taking pictures using the viewfinder, images are not trimmed and are recorded with the aspect ratio information at the time of shooting. During playback, images are displayed with a border based on the aspect ratio.
- The aspect border is not displayed in the viewfinder. When taking pictures using the viewfinder, refer to the diagram to the right.

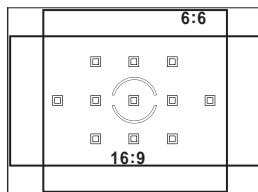



Viewfinder

## Custom Menu 1 ▶ RECORD/ERASE

### QUICK ERASE

You can erase the picture you have just taken immediately using the  button.

[OFF] When the  button is pressed, the confirmation screen appears, asking you if you want to erase the picture.

[ON] Pressing the  button erases the picture immediately.

### RAW+JPEG ERASE

You can select the method to erase images recorded in RAW+JPEG. This function can only be used to erase one frame.

[JPEG] Erases all JPEG image files, leaving only the RAW image files.

[RAW] Erases all RAW image files, leaving only the JPEG image files.

[RAW+JPEG] Erases both image file types.

### ! Notes

- This function is effective only if deleting one frame. For all-frame erase or erasing selected frames, both RAW and JPEG will be erased regardless of this setting.

## FILE NAME

When you take a picture, the camera assigns it a unique file name and saves it in a folder. File names are assigned as shown in the illustration below.

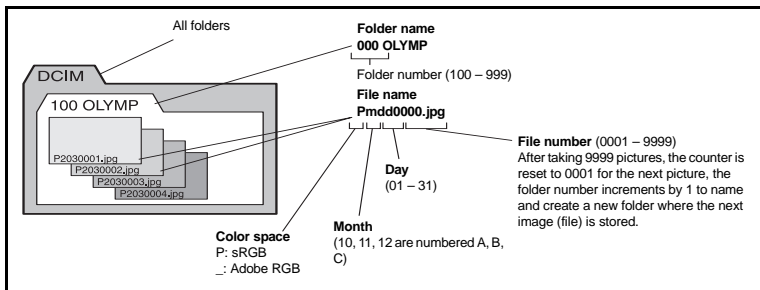

### [AUTO]

Even when a new card is inserted, the folder numbers are retained from the previous card. If the new card contains an image file whose file number coincides with one saved on the previous card, the new card's file numbers start at the number following the highest number on the previous card.

### [RESET]

When a new card is inserted, folder numbers start at 100 and file numbers start at 0001. If a card containing images is inserted, the file numbers start at the number following the highest file number on the card.

## PRIORITY SET

You can customize the initial position of the cursor ([YES] or [NO]) on the Erasing images or Formatting the card screen.

### dpi SETTING

You can set the resolution for printing images in advance. The set value is recorded on the card with the images.

- [AUTO] Automatically set according to the image size.
- [CUSTOM] You can make the desired setting. Press to display the setting screen.

## Custom Menu 1 UTILITY

### CLEANING MODE

P. 126

### EXT. WB DETECT

You can disable the white balance sensor used to determine the light source during auto white balance. This is useful when the light source near the sensor and the light source illuminating the subject are different.



## AF FOCUS ADJ.

You can use the AF sensor to fine-adjust the focusing position to a range of  $\pm 20$  steps (-: closer, +: toward  $\infty$ ). Normally, there is no need to change this.

### [SET AF DATA]

Fine-adjust the AF default value and register the setting. You can also register the setting according to the lens.

### [OFF]

AF focus adjustment is not performed.

### [DEFAULT DATA]

Registers and applies all lens AF adjustment values not registered individually.

### [LENS DATA]

Fine-adjusts the AF for each lens. You register the adjustment values for up to 20 lenses.

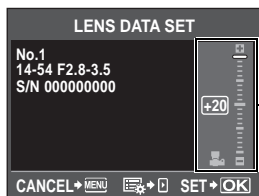

Use to adjust.

## ! Notes

- Depending on the adjustment made, the lens may not focus toward the  $\infty$  or near side.
- When using a teleconverter, the teleconverter and lens are registered as a set.
- Only Four Thirds lenses can be registered.

### [DATA LIST]

This displays the lens information registered with [LENS DATA] from [SET AF DATA]. Select a lens from the list, and then check, delete, or edit the registration information.

When the same lens is registered multiple times, the adjustment value for the lens with is applied.

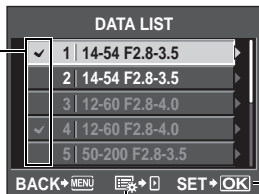

Select this to check, delete, or edit the selected lens.

Select which lens to use when the same lens is registered multiple times.

## TIPS

### To take pictures while slightly changing the AF adjustment value:

→ After fine-adjusting the adjustment value, press the shutter button and repeatedly take pictures before pressing the button.

Note the following when taking pictures to check the AF adjustment value.

- It is recommended that the record mode be set to a setting higher than when taking pictures.
- Be careful of camera shake, subject movement, and changes in the distance to the subject when taking pictures.
- It is recommended that you take a picture of a subject with strong contrast within approximately 3 m (9.8 ft.) in the actual shooting environment (lighting and temperature).
- Avoid taking pictures against backlight.

### To compare the difference in adjustment values:

→ You can use light box display to compare adjustment values. The adjustment values are also displayed during light box display.  "Light box display" (P. 83)

### To register two types of adjustment values (with the focal point of the lens in front of and behind the subject):

→ You can register multiple adjustment values for the same lens. Select the adjustment value to be applied during shooting with the [DATA LIST] screen.

### To register two of the same type of lens individually:

→ You can individually register multiple numbers of the same type of lens.

### To specify and register AF targets, or to register the adjustment values for the wide and telephoto directions of the zoom:

→ On the [LENS DATA SET] screen, press  to make the following settings.

- You can specify individual AF targets and adjust each AF target. Normally, the adjustment values for all AF targets are registered.
- You can register different adjustment values for the wide and telephoto directions of the zoom. Normally, the adjustment value for the telephoto direction is registered.

## EXPOSURE SHIFT





You can adjust the default value for optimal exposure for each metering mode according to your preference. This can be set in 1/6 EV increments ranging from -1.0 EV to +1.0 EV.

### ! Notes

- The exposure compensation can be set from -5.0 EV to +5.0 EV. Setting [EXPOSURE SHIFT] reduces the range of the direction in which the default value is adjusted.
- You cannot check the exposure shift value during shooting. To make normal adjustments to the exposure, perform exposure compensation.  "Exposure compensation" (P. 47)

## BATTERY TYPE



The characteristics of AA batteries may differ depending on the battery type and brand. When using the optional power battery holder (HLD-4) with AA batteries, you can set the battery voltage level of the battery check display according to the battery characteristics. Normally, there is no need to change this.

- |   |  |
|---|--|
|  1 | This is the standard setting for battery characteristics of AA alkaline batteries, Oxyride batteries, and lithium batteries.     |
|  2 | The warning level is set lower than that of  1. |
|  3 | The warning level is set lower than that of  2. |

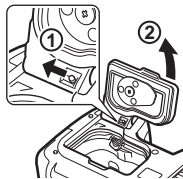
- To attach the power battery holder to the camera, remove the camera's battery cover, as shown in the diagram to the right.





### ! Notes

- Depending on the status of the batteries being used, this function may not work properly.
- The number of pictures that can be taken increases in the order of  1  2  3; however, no more pictures may be able to be taken without a warning display.

## WARNING LEVEL

You can change the timing when  is displayed (lights up). Normally, there is no need to change this.

### Notes

- The battery check display is not a warning that the battery needs to be charged. When  blinks, charge the battery.  "Power on" (P. 15)

## LEVEL ADJUST

You can calibrate the level gauge if you feel that the gauge is not level.

**[RESET]** Resets to the factory default adjustment value.

**[ADJUST]** Sets the current camera position as the zero point.

### Notes

- Set **[ADJUST]** only when the camera is secured in a horizontal position. If the camera is not in a stable position, you may not be able to calibrate the level gauge as desired.

## Custom Menu 2

 (Date/time setting)

 P. 16

/

You can select which card to use when both a CompactFlash and xD-Picture Card are loaded.

## EDIT FILENAME

You can rename image files to make them easier to identify and organize.

The portion of the filename that can be changed depends on the color space.  "COLOR SPACE" (P. 101)



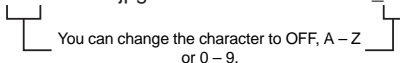

sRGB : Pmdd0000.jpg

AdobeRGB : \_mdd0000.jpg



## (Monitor brightness adjustment)

You can adjust the brightness and color temperature of the monitor. Color temperature adjustment will affect only the LCD monitor display during playback.

Use  to switch between  (color temperature) and  (brightness), and use   to adjust the value between [+7] - [-7].



## (Changing the display language)

You can change the language used for the on-screen display and error messages from ENGLISH to another language.

## VIDEO OUT

You can select NTSC or PAL according to your TV's video signal type.

You will need to set this when you want to connect the camera to a TV and play back images in a foreign country. Make sure the correct video signal type is selected before connecting the video cable. If you use the wrong video signal type, recorded pictures will not play back properly on your TV.

### TV video signal types in major countries and regions

Check the video signal type before connecting the camera to your TV.

NTSC	North America, Japan, Taiwan, Korea
PAL	European countries, China

## REC VIEW

You can display the picture you have just taken on the monitor while it is being recorded to the card, and to select how long the picture is displayed. This is useful for making a brief check of the picture you have just taken. Pressing the shutter button halfway while checking the picture lets you resume shooting immediately.

**[1SEC] – [20SEC]** Selects the number of seconds to display each picture. Can be set in units of 1 second.

**[OFF]** The picture being recorded to the card is not displayed.

**[AUTO] ** Displays the image being recorded, and then switches to playback mode. This is useful for erasing a picture after checking it.



## PIXEL MAPPING

 **P. 126**

## FIRMWARE

Your product's firmware version will be displayed.

When you make inquiries about your camera or accessories or when you want to download software, you will need to state which version of each of the products you are using.

Press . Your product's firmware version will be displayed. Press the  button to return to the previous screen.



### Resetting the camera settings

In **P**, **A**, **S**, and **M** mode, current camera settings (including any changes you have made) are retained when the power is turned off. To reset the camera to the factory default settings, set **[RESET]**. You can register settings in advance to **[RESET1]** and **[RESET2]**. The camera settings at that time are registered in **[RESET1]** and **[RESET2]**. For details on the registered functions, refer to "Functions that can be registered with My Mode and Custom Reset Setting" ( P. 138).

### Registering [RESET1]/[RESET2]

#### Menu

MENU ▶  ▶ **[CUSTOM RESET]**

- 1 Select either [RESET1]/[RESET2] to register and press .**
  - If settings have already been registered, **[SET]** is displayed next to **[RESET1]/[RESET2]**. Selecting **[SET]** again overwrites the registered setting.
  - To cancel the registration, select **[RESET]**.
- 2 Select [SET] and press the .**

## Using reset settings

This resets the camera to the factory default settings. You can also reset the camera to the [RESET1] or [RESET2] setting.

[RESET] Resets to the factory default settings. For the default settings, see "Menu directory" (P. 139).

[RESET1]/[RESET2] Resets to the registered settings.

### Direct buttons

 + ISO

- Holding down the  button and ISO button at the same time for 2 seconds performs [RESET].
- While pressing two buttons at the same time, turn the dial to select the reset setting. Release the button to reset the settings.





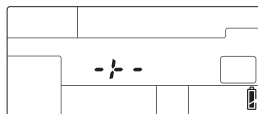

Viewfinder



Control panel





 : RESET

 /  : RESET1

  : RESET2

### Menu

MENU  [P]  [CUSTOM RESET]

- 1 Select [RESET], [RESET1], or [RESET2] and press the  button.
- 2 Use   to select [YES], then press the  button.

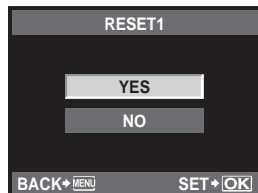

7

Customizing your camera

## Print reservation (DPOF)



### Print reservation

Print reservation allows you to save printing data (the number of prints and the date/time information) with the pictures stored on the card.

Pictures set with print reservation can be printed using the following methods.

#### DPOF (Digital Print Order Format)

This is for saving desired print settings on digital cameras. By entering which images to print and the number of copies of each, the user can easily have the desired images printed by a printer or print lab that supports the DPOF format.

#### Printing using a DPOF-compatible photo lab

You can print the pictures using the print reservation data.

#### Printing using a DPOF-compatible printer

Pictures can be printed directly from a dedicated printer without using a PC. For more details, refer to the printer's manual. A PC card adapter may also be necessary.

#### ! Notes

- DPOF reservations set by another device cannot be changed by this camera. Make changes using the original device. Moreover, setting new DPOF reservations using this camera will erase the previous reservations set by another device.
- Not all functions may be available on all printers or at all photo labs.
- RAW data are not printable.

### Single-frame reservation

Follow the operation guide to set print reservation for a picture.

1 MENU ▶ [▶] ▶ [🖨️]

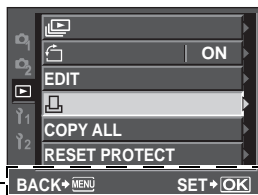

2 Select [🖨️] and press the **OK** button.

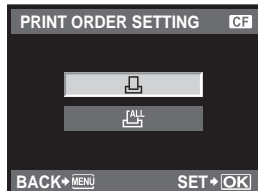

- 3** Press to select the frame that you want to set as print reservation, then press to set the number of prints.

- To set print reservation for several pictures, repeat this step.

- 4** Press the button when you have finished.

- The menu screen for single-frame reservation appears.

- 5** Select the date and time format and press the button.

[NO] The pictures are printed without the date and time.

[DATE] The pictures are printed with the shooting date.

[TIME] The pictures are printed with the shooting time.

- 6** Select [SET] and press the button.

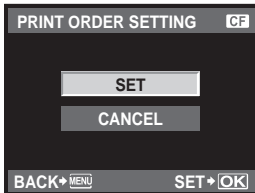
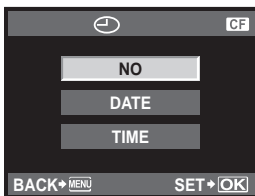

### All-frame reservation

Applies print reservation to all the pictures stored in the card. The number of prints is fixed at 1.

- 1** MENU  $\blacktriangleright$   $\blacktriangleright$
- 2** Select [] and press the button.
- 3** Select the date and time format and press the button.
  - [NO] The pictures are printed without the date and time.
  - [DATE] The pictures are printed with the shooting date.
  - [TIME] The pictures are printed with the shooting time.
- 4** Select [SET] and press the button.

## Resetting the print reservation data

You can reset all print reservation data or just the data for selected pictures.

1 MENU ▶ [▶] ▶ [🖨️]

### Resetting the print reservation data for all pictures

- 2 Select [🖨️] or [🖨️] and press the **OK** button.
- 3 Select [RESET] and press the **OK** button.



### Resetting the print reservation data for a selected picture

- 2 Select [🖨️] and press the **OK** button.
- 3 Select [KEEP] and press the **OK** button.
- 4 Use **⏪** to select the frame with print reservation data you want to reset, then press **0** to set the number of prints to 0.
- 5 Press the **OK** button when you have finished.
- 6 Select the date and time format and press the **OK** button.
  - This setting is applied to all frames with print reservation data.
- 7 Select [SET] and press the **OK** button.

## Direct printing (PictBridge)



8 By connecting the camera to a PictBridge-compatible printer with the USB cable, you can print out recorded pictures directly. To find out if your printer is compatible with PictBridge, refer to the printer's manual.

Printing

### PictBridge

The standard that enables digital cameras and printers made by different manufacturers to be connected, and also allows pictures to be printed directly from the camera.

#### STANDARD

All printers that support PictBridge have standard print settings. By selecting [STANDARD] on the settings screens (P. 114), you can print pictures according to these settings. For details on your printer's standard settings, refer to the printer's manual or contact the printer manufacturer.

- The available print modes and settings such as paper size vary with the type of printer. For details, refer to the printer's manual.
- For details on printing paper types, ink cassettes, etc., refer to the printer's manual.

#### Notes

- Use a fully charged battery or the optional AC adapter for printing.
- Images recorded in RAW data cannot be printed.
- The camera will not enter sleep mode while it is connected to the USB cable.



## Connecting the camera to a printer

Use the provided USB cable to connect the camera to a PictBridge-compatible printer.

### 1 Turn the printer on and connect the camera's multi-connector to the printer's USB port with the USB cable.

- For details on how to turn the printer on and the position of the USB port, refer to the printer's manual.

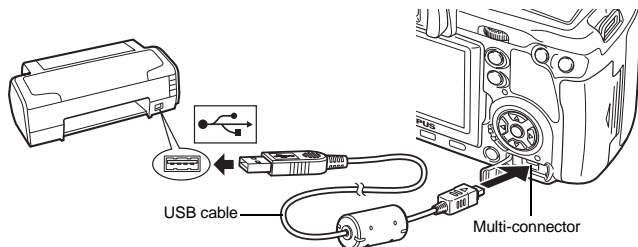

### 2 Turn on the camera.

- The selection screen for the USB connection is displayed.

### 3 Use to select [EASY PRINT] or [CUSTOM PRINT].

#### If you select [EASY PRINT]

- Go to "Easy printing" ( P. 113)

#### If you select [CUSTOM PRINT]

- [ONE MOMENT] is displayed and the camera and printer are connected.

Go to "Custom printing" ( P. 114)

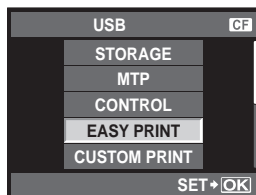

### Notes



- If the screen is not displayed after a few minutes, disconnect the USB Cable and start again from Step 1.

## Easy printing

### 1 Use to display the pictures you want to print on the camera.

- Display the image you want to print on the camera and connect the camera with a printer using a USB cable. The screen on the right appears shortly.

### 2 Press the (print) button.

- The picture selection screen appears when printing is completed. To print another picture, use  to select the image and press the  button.
- To exit, unplug the USB cable from the camera while the picture selection screen is displayed.

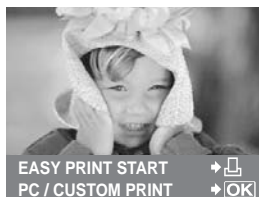

## 1 Follow the operation guide to set a print option.

### Selecting the print mode

Select the type of printing (print mode). The available print modes are as shown below.

- [PRINT]** Prints selected pictures.
- [ALL PRINT]** Prints all the pictures stored in the card and makes one print for each picture.
- [MULTI PRINT]** Prints multiple copies of one image in separate frames on a single sheet.
- [ALL INDEX]** Prints an index of all the pictures stored in the card.
- [PRINT ORDER]** Prints according to the print reservation you made. If there is no picture with print reservation, this is not available. (P. 111)

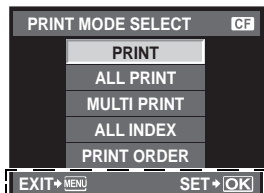

Follow the operation guide displayed here.

### Setting the print paper items

This setting varies with the type of printer. If only the printer's STANDARD setting is available, you cannot change the setting.

- [SIZE]** Sets the paper size that the printer supports.
- [BORDERLESS]** Selects whether the picture is printed on the entire page or inside a blank frame.
- [PICS/SHEET]** Selects the number of pictures per sheet. Displayed when you have selected **[MULTI PRINT]**.

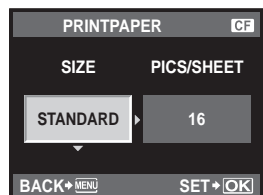
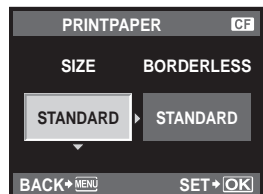

### Selecting pictures you want to print

Select pictures you want to print. The selected pictures can be printed later (single-frame reservation) or the picture you are displaying can be printed right away.

- [PRINT] (OK)** Prints the currently displayed picture. If there is a picture that **[SINGLE PRINT]** reservation has already been applied to, only that reserved picture will be printed.
- [SINGLE PRINT] (▲)** Applies print reservation to the currently displayed picture. If you want to apply reservation to other pictures after applying **[SINGLE PRINT]**, use (◂) to select them.
- [MORE] (◂)** Sets the number of prints and other items for the currently displayed picture, and whether or not to print it. For operation, refer to "Setting printing data" (P. 115) in the next section.



### Setting printing data

Select whether to print printing data such as the date and time or file name on the picture when printing. When the print mode is set to **[ALL PRINT]** and **[OPTION SET]** is selected, the following screen appears.

- [x]** Sets the number of prints.  
**[DATE]** Prints the date and time recorded on the picture.  
**[FILE NAME]** Prints the file name recorded on the picture.  
**[ ]** Trims the picture for printing. Set the trimming size with the main dial and the trimming position with the arrow pad.

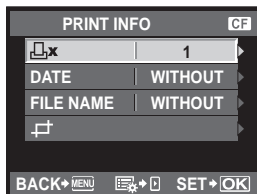

## 2 Once you have set the pictures for printing and printing data, select **[PRINT]**, then press the **[OK]** button.

- [PRINT]** Transfers images you print to the printer.  
**[CANCEL]** Resets the settings. All print reservation data will be lost. If you want to keep the print reservation data and make other settings, press the MENU button. This returns you to the previous setting.

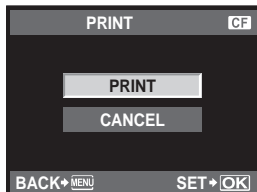

- To stop and cancel printing, press the **[ ]** button.

- [CONTINUE]** Continues printing.  
**[CANCEL]** Cancels printing. All print reservation data will be lost.

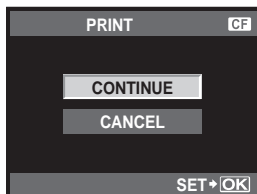

## Flowchart

Just connect the camera to a computer with the USB cable and you can easily transfer images stored on the card to the computer with the provided OLYMPUS Master software.

### Things to prepare

- OLYMPUS Master 2 CD-ROM
- USB cable
- Computer that fulfills the operating environment (For the required operating environment, refer to the OLYMPUS Master installation guide.)

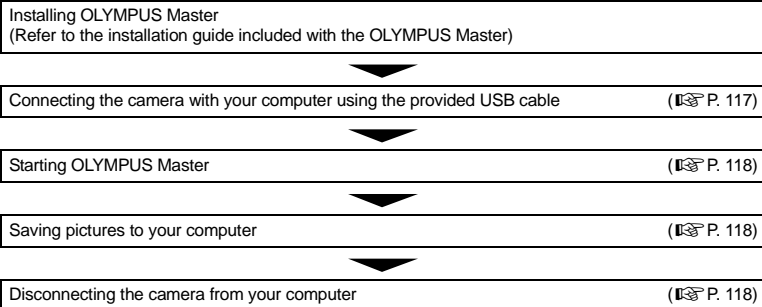

## Using the provided OLYMPUS Master software

### What is OLYMPUS Master?

OLYMPUS Master is an image management program with viewing and editing features for pictures taken with your digital camera. Once installed on your computer, you can take advantage of the following.

- **Transferring images from the camera or removable media to your computer**
- **Viewing images**  
You can also enjoy slideshows and sound playback.
- **Grouping and organizing images**  
You can organize images into albums or folders. Transferred images are automatically organized by shooting date, allowing you to quickly find the particular images you want.
- **Correcting images using filter and correction functions**
- **Editing images**  
You can rotate, trim or change the image size.
- **A variety of printing formats**  
You can easily make prints of your pictures.
- **Updating the camera firmware**
- **Developing RAW images**

For information about OLYMPUS Master's other features, as well as for details on how to use the software, refer to "Help" in OLYMPUS Master software.

## Connecting the camera to a computer

Connect the camera to your computer with the provided USB cable.

### 1 Use the provided USB cable to connect the computer's USB port to the camera's multi-connector.

- The location of the USB port varies with the computer. For details, refer to your computer's manual.

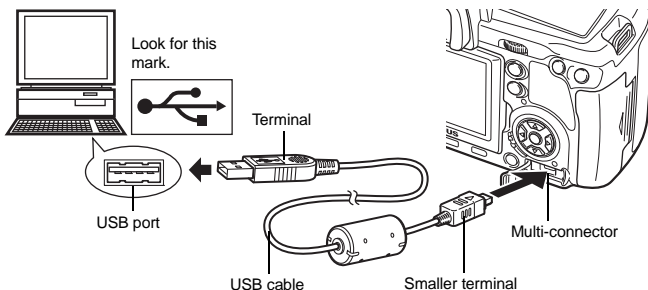

### 2 Set the camera's power switch to ON.

- The selection screen for the USB connection is displayed.

### 3 Press to select [STORAGE]. Press the button.

### 4 The computer recognizes the camera as a new device.

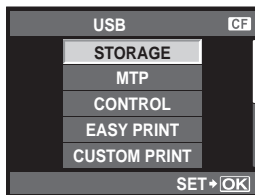

#### Windows

- When you connect the camera to the computer for the first time, the computer automatically recognizes the camera. Click "OK" when the message saying that the installation is completed appears. The computer recognizes the camera as a "Removable Disk ".

#### Macintosh

- iPhoto is the default image management application for Mac OS. When you connect your Olympus digital camera for the first time, iPhoto will start up automatically. Close iPhoto and start OLYMPUS Master.

### Notes

- When the camera is connected to the computer, none of the camera buttons are functional.

## Start up the OLYMPUS Master software

### Windows

- 1 Double-click the “OLYMPUS Master 2” icon  on the desktop.

### Macintosh



- 1 Double-click the “OLYMPUS Master 2” icon  in the “OLYMPUS Master 2” folder.
  - The browse window is displayed.
  - When OLYMPUS Master is started up for the first time after installation, the OLYMPUS Master initial setting screen and user registration screen are displayed before the browse window. Follow the on-screen instructions.

### To exit OLYMPUS Master

- 1 Click “Exit”  on any window.
  - OLYMPUS Master is exited.

## Displaying camera images on a computer

### Downloading and saving images

- 1 Click “Transfer Images”  on the browse window, and then click “From Camera” .
  - The window for selecting the pictures you want to transfer from the camera is displayed. All the images in the camera are displayed.
- 2 Select “New Album” and enter an album name.
- 3 Select the image files and click “Transfer Images”.
  - A window indicating that the download is complete is displayed.
- 4 Click “Browse images now”.
  - The downloaded images are displayed in the browse window.

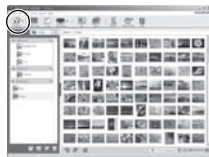

### Disconnecting the camera from your computer

- 1 Make sure that the card access lamp has stopped blinking.

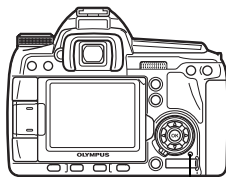

Card access lamp

## 2 Prepare to remove the USB cable.

### Windows

- 1) In the system tray, click the “Unplug or Eject Hardware” icon .
- 2) Click on the pop-up message.
- 3) Click “OK” on the “Safe to Remove Hardware” window.

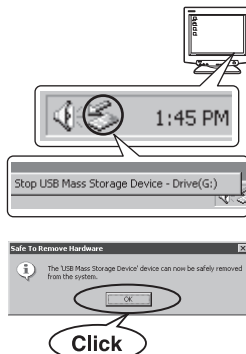

### Macintosh

- 1) The trash icon changes to the eject icon when the “Untitled” or “NO\_NAME” icon on the desktop is dragged. Drag and drop it on the eject icon.



## 3 Unplug the USB cable from the camera.

### ! Notes

- For Windows users:  
When you click “Unplug or Eject Hardware”, a warning message may be displayed. In such case, make sure that no image data is being downloaded from the camera, and that there are no applications open that were accessing the camera image files. Close any such applications and click “Unplug or Eject Hardware” again and then remove the cable.

## Viewing still images

- 1 Click the “Album” tab on the browse window and select the album that you want to view.
  - The selected album image is displayed in the thumbnail area.
- 2 Double-click the still picture thumbnail that you want to view.
  - OLYMPUS Master switches to the image edit window and the picture is enlarged.
  - Click “Back”  to return to the browse window.



## Transferring images to your computer without using OLYMPUS Master

Your camera supports the USB Mass Storage Class. You can transfer images to a computer by connecting the camera to the computer with the provided USB cable. This can be done even without using OLYMPUS Master. The following operating systems are compatible with the USB connection:

Windows : 2000 Professional/XP Home Edition/XP Professional/Vista

Macintosh : Mac OS X v10.3 or later

### ! Notes

- If your computer is running Windows Vista, select **[MTP]** in Step 3 on page 117 to use Windows Photo Gallery.
- Data transfer is not guaranteed in the following environments, even if your computer is equipped with a USB port.
  - Computers with a USB port added by means of an extension card, etc.
  - Computers without a factory-installed OS and home-built computers



**Shooting tips and information****The camera does not turn on even when a battery is loaded****The battery is not fully charged**

- Charge the battery with the charger.

**The battery is temporarily unable to function because of the cold**

- Battery performance declines in low temperatures, and the charge may not be sufficient to turn on the camera. Remove the battery and warm it by putting it in your pocket for a while.

**No picture is taken when the shutter button is pressed****The camera has turned off automatically**

- To save battery power, if there is no operation, the camera goes into sleep mode after a fixed period of time and the camera stops operating. The camera activates again when you touch the shutter button or any other button. The camera will turn off automatically if there is no further operation for 4 hours. The camera will not work until it is turned back on.  "SLEEP" (P. 98), "4 h TIMER (Auto power off)" (P. 98)

**The flash is charging**

- When the flash is activated and the  symbol in the viewfinder is blinking, this indicates that the flash is charging. Wait for the blinking to stop, then press the shutter button.

**Unable to focus**

- When the AF confirmation mark in the viewfinder is blinking, it indicates that the camera is unable to focus using AF. Press the shutter button again.

**Noise reduction is activated**

- When shooting night scenes, shutter speeds are slower and noise tends to appear in images. The camera activates the noise-reduction process after shooting at slow shutter speeds. During which, shooting is not allowed. You can set [NOISE REDUCT.] to [OFF].  "Noise reduction" (P. 72)

**The date and time has not been set****The camera is used with the settings at the time of purchase**

- The date and time of the camera is not set when purchased. Set the date and time before using the camera.  "Setting the date/time" (P. 16)

**The battery has been removed from the camera**

- The date and time settings will be returned to the factory default settings if the camera is left without the battery for approximately 1 day. The settings will be canceled more quickly if the battery was only loaded in the camera for a short time before being removed. Before taking important pictures, check that the date and time settings are correct.

## Subjects that are difficult to focus on

It may be difficult to focus with auto focus in the following situations.

AF confirmation mark is blinking. These subjects are not focused.

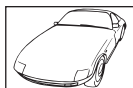

Subject with low contrast

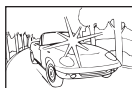

Excessively bright light in center of frame

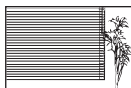

Subject with repeated patterns

AF confirmation mark lights up but the subject is not focused.



Subjects at different distances

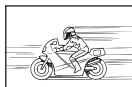

Fast-moving subject



Subject not inside AF area

In any situation, focus on something with high contrast that is at the same distance as the subject, determine the composition and shoot the picture.  "Focus lock – If correct focus cannot be obtained" (P. 58)

## Image taken appears whitish

This may occur when the picture is taken in backlight or semi-backlight conditions. This is due to a phenomenon called flare or ghosting. As far as possible, consider a composition where strong light source is not taken in the picture. Flare may occur even when a light source is not present in the picture. Use a lens hood to shade the lens from the light source. If a lens hood does not have effect, use your hand to shade the lens from the light.

 "Interchangeable lenses" (P. 129)

## Unknown bright dot(s) appear on the subject in the picture taken

This may be due to stuck pixel (s) on the image pickup device. Perform **[PIXEL MAPPING]**. If the problem persists, repeat pixel mapping a few times.  "Pixel mapping – Checking the image processing functions" (P. 126)

## Functions that cannot be selected from menus

Some items may not be selectable from the menus when using the arrow pad.

- Items that cannot be set with the current shooting mode
- Items that cannot be set because of an item that has already been set:  
Combination of **[ ]** and **[NOISE REDUCT.]**, etc.

## Cannot use the Imager AF

Imager AF is available only when using compatible lenses. For the latest information about Olympus lenses compatible with Imager AF, visit the Olympus website.













## Camera vibration when the power is turned off











This is due to the camera initializing the image stabilizer mechanism. Without this initialization, the image stabilizer may not be able to achieve the proper effect.

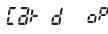

## Set functions are restored to their factory default settings

When you rotate the mode dial or turn off the power in a shooting mode other than **P**, **A**, **S**, or **M**, functions with changes made to their settings are restored to the factory default settings.

## Error codes

Viewfinder indications	Control panel indications	Monitor indication	Possible cause	Corrective action
Normal indication	- - -	 NO CARD	The card is not inserted, or it cannot be recognized.	Insert a card or insert a different card.
	-E-	 CARD ERROR	There is a problem with the card.	Insert the card again. If the problem persists, format the card. If the card cannot be formatted, it cannot be used.
	-P-	 WRITE PROTECT	Writing to the card is prohibited.	The card has been set to read-only setting with the computer. Reset the card with the computer.
	0	 CARD FULL	The card is full. No more pictures can be taken or no more information such as print reservation can be recorded.	Replace the card or erase unwanted pictures. Before erasing, download important images to a PC.
No indication	No indication	 CARD FULL	There is no space in the card and print reservation or new images cannot be recorded.	Replace the card or erase unwanted pictures. Before erasing, download important images to a PC.
No indication	No indication		xD-Picture Cards cannot be read or is not formatted.	<ul style="list-style-type: none"> <li>• Select <b>[xD CARD CLEAN]</b>, press the  button and turn off the camera. Remove the card and wipe dry the metallic surface with a soft, dry cloth.</li> <li>• Select <b>[FORMAT]</b>  <b>[YES]</b>, and then press the  button to format the card. Formatting the card erases all data on the card.</li> </ul>
No indication	No indication	 NO PICTURE	There are no pictures on the card.	The card contains no pictures. Record pictures and play back.

Viewfinder indications	Control panel indications	Monitor indication	Possible cause	Corrective action
No indication	No indication	 PICTURE ERROR	The selected picture cannot be displayed for playback due to a problem with this picture. Or the picture cannot be used for playback on this camera.	Use image processing software to view the picture on a PC. If that cannot be done, the image file is damaged.
No indication	No indication	 THE IMAGE CANNOT BE EDITED	Pictures taken with another camera cannot be edited on this camera.	Use image processing software to edit the picture.
No indication	No indication	 Internal camera temperature is too high. Please wait for cooling before camera use.	Extended use of live view or sequential shooting has increased the internal temperature of the camera.	Wait a moment for the camera to turn off automatically. Allow the internal temperature of the camera to cool before resuming operations.
		 CARD COVER OPEN	The card cover is open.	Close the card cover.
No indication	No indication	 BATTERY EMPTY	The battery is drained.	Charge the battery.
No indication	No indication	 NO CONNECTION	The camera is not connected to the computer or printer correctly.	Disconnect the camera and connect it again correctly.
No indication	No indication	 NO PAPER	There is no paper in the printer.	Load some paper in the printer.
No indication	No indication	 NO INK	The printer has run out of ink.	Replace the ink cartridge in the printer.
No indication	No indication	 JAMMED	The paper is jammed.	Remove the jammed paper.

Viewfinder indications	Control panel indications	Monitor indication	Possible cause	Corrective action
No indication	No indication	SETTINGS CHANGED	The printer's paper cassette has been removed or the printer has been manipulated while making settings on the camera.	Do not manipulate the printer while making settings on the camera.
No indication	No indication	 PRINT ERROR	There is a problem with the printer and/or camera.	Turn off camera and printer. Check the printer and remedy any problems before turning the power on again.
No indication	No indication	 CANNOT PRINT	Pictures recorded on other cameras may not be printed on this camera.	Use a personal computer to print.

## Camera maintenance

### Cleaning and storing the camera

#### Cleaning the camera

Turn off the camera and remove the battery before cleaning the camera.

#### **Exterior:**

- Wipe gently with a soft cloth. If the camera is very dirty, soak the cloth in mild soapy water and wring well. Wipe the camera with the damp cloth and then dry it with a dry cloth. If you have used the camera at the beach, use a cloth soaked in clean water and well wrung.

#### **Monitor and viewfinder:**

- Wipe gently with a soft cloth.

#### **Lens, mirror and focusing screen:**

- Blow dust off the lens, mirror and focusing screen with a commercially available blower. For the lens, wipe gently with a lens cleaning paper.

#### Storage

- When not using the camera for a prolonged period, remove the battery and card. Store the camera in a cool, dry place that is well ventilated.
- Insert the battery periodically and test the camera's functions.

#### Cleaning and checking the image pickup device

This camera incorporates a dust reduction function to keep dust from getting on the image pickup device and to remove any dust or dirt from the image pickup device surface with ultrasonic vibrations. Dust reduction is activated when the power switch is set to ON and when starting and stopping live view. The dust reduction function operates at the same time as the pixel mapping, which checks the image pickup device and image processing circuitry. Since dust reduction is activated every time the camera's power is turned on, the camera should be held upright for the dust reduction function to be effective. The SSWF indicator blinks while dust reduction is working.

 "SSWF indicator" (P. 15)

## Notes

- Do not use strong solvents such as benzene or alcohol, or a chemically treated cloth.
- Avoid storing the camera in places where chemicals are treated, in order to protect the camera from corrosion.
- Mold may form on the lens surface if the lens is left dirty.
- Check each part of the camera before use if it has not been used for a long time. Before taking important pictures, be sure to take a test shot and check that the camera works properly.

## Cleaning mode – Removing dust

If dust or dirt gets on the image pickup device, black dots may appear in the picture. Contact your Olympus Authorized Service Center to have the image pickup device physically cleaned. The image pickup device is a precision device and is easily damaged. When cleaning the image pickup device yourself, be sure to follow the instructions below. If power runs out during cleaning, the shutter will close, which may cause the shutter curtain and mirror to break. Keep an eye on the remaining battery power.

### 1 Remove the lens from the camera, and set the power switch to ON.

### 2 MENU ▸ [F1] ▸ [MENU] ▸ [CLEANING MODE]

### 3 Press , then press the button.

- The camera enters the cleaning mode.

### 4 Press the shutter button all the way.

- The mirror goes up and the shutter curtain opens.

### 5 Clean the image pickup device.

- Carefully blow off any dust on the surface of the image pickup device by using a mechanical blower (commercially available).

### 6 Be careful not to catch the mechanical blower in the shutter curtain when turning the power off to finish cleaning.

- If the camera turns off, the shutter curtain closes, causing the mirror to fall.

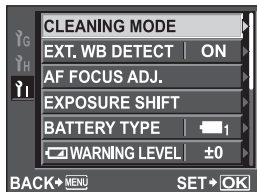

## Notes

- Be careful not to let the mechanical blower (commercially available) touch the image pickup device. If the blower touches the image pickup device, the image pickup device will be damaged.
- Never put the mechanical blower behind the lens mount. If the power turns off, the shutter closes, breaking the shutter curtain.
- Do not use anything other than the mechanical blower. If high-pressure gas is sprayed onto the image pickup device, it will freeze on the image pickup device's surface, damaging the image pickup device.

## Pixel mapping – Checking the image processing functions

The pixel mapping feature allows the camera to check and adjust the image pickup device and image processing functions. After using the monitor or taking continuous shots, wait for at least one minute before using the pixel mapping function to ensure that it operates correctly.

### 1 MENU ▸ [F2] ▸ [PIXEL MAPPING]

### 2 Press , then press the button.

- The [BUSY] bar is displayed when pixel mapping is in progress. When pixel mapping is finished, the menu is restored.

## Notes

- If you accidentally turn the camera off during pixel mapping, start again from Step 1.

## Card basics

### Usable cards

"Card" in this manual refers to a recording medium. This camera can use CompactFlash, Microdrive or xD-Picture Card (optional).

#### CompactFlash

A CompactFlash is a large-capacity solid state flash memory card. You can use commercially available cards.

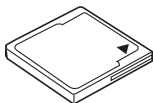

#### Microdrive

A Microdrive is a medium that uses a large-capacity compact hard disk drive. You can use a Microdrive that supports CF+Type II (CompactFlash extension standard).

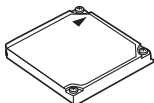

#### xD-Picture Card

An xD-Picture Card is a recording medium used mainly in compact cameras.



### Precautions when using a Microdrive

A Microdrive is a medium that uses a compact hard disk drive. Because the disk drive rotates, a Microdrive is not as resistant to vibration or impact as other cards. Special care is needed when using a Microdrive (especially during recording and playback) to make sure the camera is not subjected to shock or vibrations. Be sure to read the following precautions before using a Microdrive.

Also, refer to the manuals provided with your Microdrive.

- Be very careful when putting the camera down during recording. Place it gently on a firm surface.
- Do not use the camera in places subject to vibrations or excessive shock, such as at a construction site or in a car while driving along a bumpy road.
- Do not take a Microdrive close to areas where it may be exposed to strong magnetism.
- The Microdrive may not function correctly under low air pressure conditions, like in altitudes of 3,000 m (9,843 ft.) and higher.

#### ! Notes

- The data in the card will not be erased completely even after formatting the card or deleting the data. When discarding, destroy the card to prevent leakage of personal information.

### Formatting the card

Non-Olympus cards or cards formatted on a computer must be formatted with the camera before they can be used. All data stored on the card, including protected images, is erased when the card is formatted. When formatting a used card, confirm there are no images that you still want to keep on the card.

- 1 MENU ▸ [M] ▸ [CARD SETUP]
- 2 Use to select [FORMAT], then press the .
- 3 Use to select [YES], then press the button.
  - Formatting is performed.

#### TIPS

#### When inserting cards into the two card slots:

→ Select the card to be used in [[CF]/xD]. "CF/xD" (P. 107)

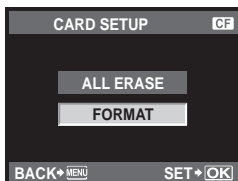

## Battery and charger

- Use the single Olympus lithium-ion battery (BLM-1).  
Other batteries cannot be used.
- The camera's power consumption varies widely with usage and other conditions.
- As the following consume a lot of power even without shooting, the battery will be drained quickly.
  - Performing auto focus repeatedly by pressing the shutter button halfway in shooting mode.
  - Using live view.
  - Displaying images on the LCD monitor for a prolonged period.
  - When connected to a computer or printer.
- When using a drained battery, the camera may turn off without the low battery warning being displayed.
- The battery will not be fully charged at the time of purchase. Charge the battery using the provided charger (BCM-2) before use.
- The normal charging time using the provided charger is approximately 5 hours (estimated).
- Do not use chargers other than the one designated.

## AC adapter

It is recommended to use the AC-1 AC adapter (optional) for prolonged slideshows, transferring pictures to a computer, or other operations that may take a long time to perform.

Do not use other AC adapters.

### ! Notes

- Do not remove the battery or unplug the AC adapter when the camera is on or is connected to another device. This can affect the camera settings and functions.
- Refer to the manual provided with the AC adapter.

## Using your charger and AC adapter abroad

- The charger and AC adapter can be used in most home electrical sources within the range of 100 V to 240 V AC (50/60Hz) around the world. However, depending on the country or area you are in, the AC wall outlet may be shaped differently and the charger or AC adapter may require a plug adapter to match the wall outlet. For details, ask at your local electrical shop or travel agent.
- Do not use commercially available travel adaptors as the charger or AC adapter may malfunction.



## Interchangeable lenses

Select the lens that you want to shoot with.

Use a specified Four Thirds lens (Four Thirds mount). When a non-specified lens is used, auto focus and light metering will not function correctly. In some cases, other functions may not work either.

### FOUR THIRDS mount

Developed by Olympus as the lens mount standard for the Four Thirds system. These all-new interchangeable lenses featuring the Four Thirds mount were developed from the ground up based on optic engineering exclusively for digital cameras.

## ZUIKO DIGITAL interchangeable lens

Four Thirds system interchangeable lens are designed to withstand rigorous professional use. The Four Thirds system makes it possible for a fast lens to be compact and lightweight as well.

### Focal length and depth of field of Four Thirds system lenses

When compared to 35-mm cameras, Four Thirds system cameras achieve different effects at the same focal length and aperture.

#### Focal length

At the same focal length of a 35-mm camera, a Four Thirds system camera can achieve a focal length equivalent to twice that of a 35-mm camera. This enables the design of compact telephoto lenses. A 14-50 mm Four Thirds system lens, for example, is equivalent to a 28-100 mm lens for a 35-mm camera.

- When the image angle of Four Thirds system lens is converted to that of a 35-mm camera, the perspective is the same as that of a 35-mm camera.

#### Depth of Field

A Four Thirds system camera can achieve a depth of field equivalent to two times deeper than that of a 35-mm camera. A Four Thirds system lens with f2.0 brightness, for example, is equivalent to f4.0 when converted to the aperture of a 35-mm camera.

- You can achieve the same amount of background blur as if you were using a 35-mm camera.

#### ! Notes

- When you attach or remove the body cap and lens from the camera, keep the lens mount on the camera pointed downward. This helps prevent dust and other foreign matter from getting inside the camera.
- Do not remove the body cap or attach the lens in dusty places.
- Do not point the lens attached to the camera toward the sun. This may cause the camera to malfunction or even ignite due to the magnifying effect of sunlight focusing through the lens.
- Be careful not to lose the body cap and rear cap.
- Attach the body cap to the camera to prevent dust from getting inside when no lens is attached.

# E-System Chart

## Standard Lenses



**18-35mm (equiv. to 35mm)**  
ZUIKO DIGITAL  
ED 9-18mm 1:4.0-5.6  
Ultra Wide-angle Zoom Lens

Compatible with  
**EC-14/EC-20\***  
Tele  
Converter



**28-84mm (equiv. to 35mm)**  
ZUIKO DIGITAL  
ED 14-42mm 1:3.5-5.6  
Standard Zoom Lens

Compatible with  
**EX-25\*** **EC-14/EC-20\***  
Extension Tele  
Tube Converter  
only at  
50-84mm



**35-90mm (equiv. to 35mm)**  
ZUIKO DIGITAL 17.5-45mm  
1:3.5-5.6 Standard Zoom Lens  
(only available in special kit)

Compatible with  
**EX-25\*** **EC-14/EC-20\***  
Extension Tele  
Tube Converter  
only at  
56-90mm



**36-360mm (equiv. to 35mm)**  
ZUIKO DIGITAL  
ED 18-180mm 1:3.5-6.3  
Super Zoom Lens (10x)

Compatible with  
**EX-25\*** **EC-14/EC-20\***  
Extension Tele  
Tube Converter  
only at  
100-360mm



**50mm (equiv. to 35mm)**  
ZUIKO DIGITAL  
25mm 1:2.8 Pancake  
Fix Focal Lens

Compatible with  
**EX-25\*** **EC-14/EC-20\***  
Extension Tele  
Tube Converter

## Standard Lenses



**70mm (equiv. to 35mm)**  
ZUIKO DIGITAL  
35mm 1:3.5  
Macro Lens

Compatible with  
**EX-25\*** **EC-14/EC-20\***  
Extension Tele  
Tube Converter

**RF-11** **TF-22**  
Ring Flash Twin Flash  
with FR-1 with FR-1



**80-300mm (equiv. to 35mm)**  
ZUIKO DIGITAL  
ED 40-150mm 1:4.0-5.6  
Telephoto Zoom Lens

Compatible with  
**EX-25\*** **EC-14/EC-20\***  
Extension Tele  
Tube Converter



**140-600mm (equiv. to 35mm)**  
ZUIKO DIGITAL  
ED 70-300mm 1:4.0-5.6  
Super Telephoto Zoom Lens

Compatible with  
**EX-25\*** **EC-14/EC-20\***  
Extension Tele  
Tube Converter



**16mm (equiv. to 35mm)**  
ZUIKO DIGITAL  
ED 8mm 1:3.5  
Fisheye Lens

Compatible with  
**EC-14/EC-20\***  
Tele  
Converter



**22-44mm (equiv. to 35mm)**  
ZUIKO DIGITAL  
11-22mm 1:2.8-3.5  
Wide-angle Zoom Lens

Compatible with  
**EC-14/EC-20\*** **TF-22**  
Tele Twin  
Converter Flash

## Pro Lenses



**24-120mm (equiv. to 35mm)**  
ZUIKO DIGITAL  
ED 12-60mm 1:2.8-4.0 SWD  
Standard Zoom Lens

Compatible with  
**EX-25\*** **EC-14/EC-20\***  
Extension Tele  
Tube Converter  
only at 120mm



**28-108mm (equiv. to 35mm)**  
ZUIKO DIGITAL  
14-54mm 1:2.8-3.5 II  
Standard Zoom Lens

Compatible with  
**EX-25\*** **EC-14/EC-20\***  
Extension Tele  
Tube Converter  
only at 108mm  
**TF-22**  
Twin Flash



**100mm (equiv. to 35mm)**  
ZUIKO DIGITAL  
ED 50mm 1:2.0  
Macro Lens

Compatible with  
**EX-25\*** **EC-14/EC-20\***  
Extension Tele  
Tube Converter  
**RF-11** **TF-22**  
Ring Flash Twin Flash  
with FR-1 with FR-1



**100-400mm (equiv. to 35mm)**  
ZUIKO DIGITAL  
ED 50-200mm 1:2.8-3.5 SWD  
Telephoto Zoom Lens

Compatible with  
**EX-25\*** **EC-14/EC-20\***  
Extension Tele  
Tube Converter  
**TF-22**  
Twin Flash

## Top Pro Lenses



**14-28mm (equiv. to 35mm)**  
ZUIKO DIGITAL  
ED 7-14mm 1:4.0  
Super Wide-angle Zoom Lens

Compatible with  
**EC-14/EC-20\***  
Tele  
Converter

## Top Pro Lenses



**28-70mm (equiv. to 35mm)**  
ZUIKO DIGITAL  
ED 14-35mm 1:2.0 SWD  
Standard Zoom Lens

Compatible with  
**EC-14/EC-20**  
Tele  
Converter



**70-200mm (equiv. to 35mm)**  
ZUIKO DIGITAL  
ED 35-100mm 1:2.0  
Telephoto Zoom Lens

Compatible with  
**EX-25\*** **EC-14/EC-20**  
Extension Tele  
Tube Converter  
only at  
120-200mm



**180-500mm (equiv. to 35mm)**  
ZUIKO DIGITAL  
ED 90-250mm 1:2.8  
Telephoto Zoom Lens

Compatible with  
**EX-25\*** **EC-14/EC-20**  
Extension Tele  
Tube Converter



**300mm (equiv. to 35mm)**  
ZUIKO DIGITAL  
ED 150mm 1:2.0  
Fix Focal Lens

Compatible with  
**EX-25\*** **EC-14/EC-20**  
Extension Tele  
Tube Converter



**600mm (equiv. to 35mm)**  
ZUIKO DIGITAL  
ED 300mm 1:2.8  
Fix Focal Lens

Compatible with  
**EX-25\*** **EC-14/EC-20**  
Extension Tele  
Tube Converter  
Drop-in Filter Set included

## Adapters



ZUIKO DIGITAL  
1.4x Tele Converter  
EC-14



ZUIKO DIGITAL  
2.0x Tele Converter  
EC-20



EX-25  
Extension Tube



MF-1  
OM-Adapter

## Remote Control



RM-1  
Remote Control



RM-UC1  
Remote Cable

## Flash System



FL-CB05  
Flash Extension Cable



FP-1\*\*\*  
Flash Power Grip  
(incl. FL-CB02)  
for FL-50R



FL-CB02  
5-pin to hot shoe cable



FL-50R  
Wireless Flash



FL-36R  
Wireless Flash



FL-20  
Flash



FLBA-1  
Flash Bounce Adapter  
(incl. with FL-50R)



FLRA-1  
Flash Reflector Adapter  
(incl. with FL-50R)



FLST-1  
Flash Stand  
(incl. with FL-50R  
and FL-36R)



HV-1  
High Voltage Pack



BN-1  
Ni-MH Battery Pack



AC-2  
AC Adapter

SRF-11  
Ring Flash Set  
(incl. FC-1 / RF-11)



FC-1  
Macro Flash  
Controller



RF-11  
Ring Flash



FR-1  
Flash Adapter Ring  
for 35/50mm Macro



TF-22  
Twin Flash

SHV-1  
Flash High Voltage Set  
(incl. HV-1/BN-1/AC-2)

STF-22  
Twin Flash Set  
(incl. FC-1/TF-22)

## Power Supply



BLM-1  
Li-Ion Battery Pack  
(for E-520/E-3/E-30)



HLD-1  
Power Battery Holder  
(for 2x BLM-1,  
for E-3/E-30)



GS-3  
Grip Strap



BCM-1  
Quick Li-Ion Battery  
Charger



BCM-2  
Li-Ion Battery Charger



AABH-1  
Battery Holder  
(incl. with HLD-1)



AC-1  
Power Supply  
(for E-3/E-30)

## Eye Cups



VA-1  
VariMagni  
Angle Finder



EP-5  
Eye Cup  
(Standard)



EP-6  
Big Eye Cup



EP-7  
Eye Cup



ME-1  
Magnifier Eye  
Cup 1.2x



DE-P3  
Eye Cup  
Dioptric  
Adjustment +3



DE-N3  
Eye Cup  
Dioptric  
Adjustment -3



FS-3\*\*\*\*  
Focusing  
Screen  
(for E-3/E-30)

## E-System Bags



E-System Shoulder Bag II



E-System Backpack II



E-System Swing Bag



E-System Bag Compact II



E-System Bag



E-System Pro Backpack

\*Only with MF. Any mentioned focal lengths are 35mm equivalent values. \*\*AF possible when using center frame. \*\*\*No release via FP-1.

\*\*\*\*Exchange only via Olympus Service Station

Specifications and appearances are subject to change without any notice or obligation on the part of the manufacturer.

## ZUIKO DIGITAL lens specifications

### Names of parts

- ① Hood mount section
- ② Filter mount thread
- ③ Zoom ring
- ④ Focus ring
- ⑤ Mount index
- ⑥ Electrical contacts
- ⑦ Front cap
- ⑧ Rear cap
- ⑨ Lens hood

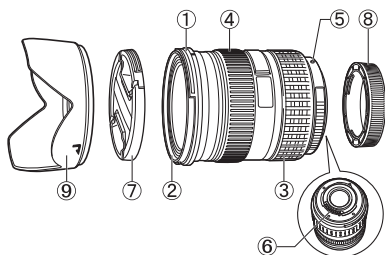

### Attaching the hood

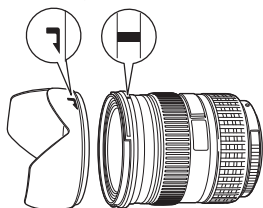

### Storing the hood

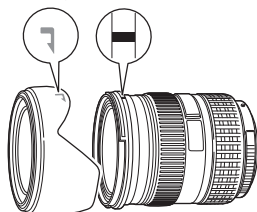

- Use the hood when shooting a backlit subject.

### Main Specifications

Items	14 – 42 mm	14 – 54 mm	12 – 60 mm
Mount	FOUR THIRDS mount		
Focal length	14 – 42 mm	14 – 54 mm	12 – 60 mm
Max. aperture	f3.5 – 5.6	f2.8 – 3.5	f2.8 – 4.0
Image angle	75° – 29°	75° – 23°	84° – 20°
Lens configuration	8 groups, 10 lenses	11 groups, 15 lenses	10 groups, 14 lenses
	Multilayer film coating (partially single layered)		
Iris control	f3.5 – 22	f2.8 – 22	f2.8 – 22
Shooting range	0.25 m – ∞	0.22 m – ∞	0.25 m – ∞
Focus adjustment	AF/MF switching		
Weight (excluding hood and cap)	190 g	435 g	575 g
Dimensions (Max. diameter x overall length)	Ø 65.5 x 61 mm	Ø 73.5 x 88.5 mm	Ø 79.5 x 98.5 mm
Lens hood mount	Bayonet		
Filter mount thread diameter	58 mm	67 mm	72 mm

Can be used with the optional EX-25 extension tube under the following conditions.  
The focus adjustment when EX-25 is used will be MF.

Lens, focal length		Shooting range	Magnification ( ): Calculated based on 35 mm film camera
14 – 42 mm	14 mm	Shooting is not possible since subjects cannot be brought into focus at this focal length.	
	25 mm	13.3 cm	1.02x (2.04x)
	42 mm	16.2 cm – 17.3 cm	0.61 – 0.69x (1.22 – 1.38x)
14 – 54 mm	14 mm	Shooting is not possible since subjects cannot be brought into focus at this focal length.	
	54 mm	17.7 cm – 22.2 cm	0.47 – 0.65x (0.94 – 1.3x)
12 – 60 mm	12 mm	Shooting is not possible since subjects cannot be brought into focus at this focal length.	
	60 mm	21 cm – 25.6 cm	0.43 – 0.58x (0.86 – 1.16x)

### ■ Storage Precautions

- Clean the lens after use. Remove dust and dirt on the surface of the lens with a blower brush or brush. Use commercially available lens cleaning paper to remove the dirt on the lens. Do not use organic solvents.
- Always cap the lens and store it when it is not used.
- Do not store in an area with insect repellent.

### ! Notes on Shooting

- Edges of pictures may be cut off if more than one filter is used or if a thick filter is used.

## Program line diagram (P mode)

In the **P** mode, the camera is programmed such that the aperture value and shutter speed are automatically selected according to the subject's brightness as shown below. The program line diagram varies with the type of lens mounted.

- When using the 14 – 42 mm f3.5 – 5.6 zoom lens (focal length: 14 mm, ISO100)
- Program shift

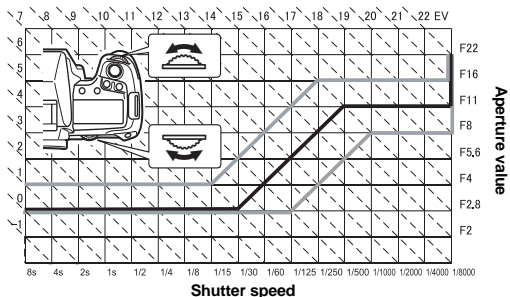

## Flash synchronization and shutter speed



Shooting mode	Flash timing	Upper limit of synchronization timing* <sup>1</sup>	Fixed timing when flash fires* <sup>2</sup>
<b>P</b>	1/ (lens focal length x 2) or synchronization timing, whichever is slower	1/250	1/60
<b>A</b>			
<b>S</b>	The set shutter speed	1/250	—
<b>M</b>			

\*1 Can be changed using menu: 1/60 – 1/250  X-SYNC." (P. 101)

\*2 Can be changed using menu: 1/30 – 1/250  SLOW LIMIT" (P. 101)

## Exposure warning display

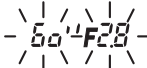
If the optimum exposure cannot be obtained when pressing the shutter button halfway, the display will blink in the viewfinder and on the super control panel.

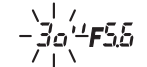
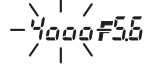
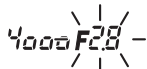
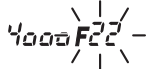
Shooting mode	Warning display example (blinking)	Status	Action
<b>P</b>		The subject is too dark.	<ul style="list-style-type: none"> <li>• Increase the ISO sensitivity.</li> <li>• Use the flash.</li> </ul>
		The subject is too bright.	<ul style="list-style-type: none"> <li>• Decrease the ISO sensitivity.</li> <li>• Use a commercially available ND filter (for adjusting the amount of light).</li> </ul>
<b>A</b>		The subject is underexposed.	<ul style="list-style-type: none"> <li>• Decrease the aperture value.</li> <li>• Increase the ISO sensitivity.</li> </ul>
		The subject is overexposed.	<ul style="list-style-type: none"> <li>• Increase the aperture value.</li> <li>• Decrease the ISO sensitivity or use a commercially available ND filter (for adjusting the amount of light).</li> </ul>
<b>S</b>		The subject is underexposed.	<ul style="list-style-type: none"> <li>• Set the shutter speed slower.</li> <li>• Increase the ISO sensitivity.</li> </ul>
		The subject is overexposed.	<ul style="list-style-type: none"> <li>• Set the shutter speed faster.</li> <li>• Decrease the ISO sensitivity or use a commercially available ND filter (for adjusting the amount of light).</li> </ul>



\* The aperture value at the moment when its indication blinks varies with the lens type and focal length of the lens.

## Flash modes that can be set by shooting mode

Shooting mode	Viewfinder indications	Control panel indications	Super control panel indications	Flash mode	Flash timing	Conditions for firing the flash	Shutter speed limit
AUTO				Auto flash	1st curtain	Fires automatically in dark/backlit <sup>1</sup> conditions	1/30 sec. – 1/250 sec.
				Auto flash (red-eye reduction)			
				Fill-in flash	Always fires		
				Flash off	—	—	—
P A 				Slow synchronization (red-eye reduction)	1st curtain	Fires automatically in dark/backlit <sup>1</sup> conditions	60 sec. – 1/250 sec.
				Slow synchronization (1st curtain)			
				Slow synchronization (2nd curtain)	2nd curtain		
				Manual flash (FULL)	1st curtain	Always fires	
				Manual flash (1/4)			
				Manual flash (1/16)			
				Manual flash (1/64)			

Shooting mode	Viewfinder indications	Control panel indications	Super control panel indications	Flash mode	Flash timing	Conditions for firing the flash	Shutter speed limit
S M	⚡	⚡	⚡	Fill-in flash	1st curtain	Always fires	60 sec. – 1/250 sec.
	⚡ 00	⚡ ⑥	⑥ ⚡	Fill-in flash (red-eye reduction)			
	⚡ OFF	⚡ OFF	④	Flash off			
	⚡ 2	⚡ 2nd-CURTAIN	2nd CURTAIN	Fill-in flash/ Slow synchronization (2nd curtain)	2nd curtain	Always fires	60 sec. – 1/250 sec.
	⚡ FULL	⚡ FULL	⚡ FULL	Manual flash (FULL)	1st curtain		
	⚡ 1-4	⚡ 1-4	⚡ 1/4	Manual flash (1/4)			
	⚡ 1-16	⚡ 1-16	⚡ 1/16	Manual flash (1/16)			
	⚡ 1-64	⚡ 1-64	⚡ 1/64	Manual flash (1/64)			

\*1 When the flash is set to the Super FP mode, it detects backlight with longer duration than for normal flash before emitting light.  "Super FP flash" (P. 79)

\*2 AUTO, ,  cannot be set in NIGHT+PORTRAIT mode.

## White balance color temperature

The higher the color temperature, the richer the light in bluish tones and the poorer in reddish; the lower the color temperature, the richer the light in reddish tones and the poorer in bluish. The spectral balance of different white light sources is rated numerically by color temperature – concept of physics expressed using the Kelvin (K) temperature scale. The color of sunlight and other natural light sources and the color of a light bulb and other artificial light sources can be expressed in terms of color temperature.

It follows, then, that the color temperatures of fluorescent lights make them unsuitable as artificial light sources. There are gaps in the hues from the color temperatures of fluorescent light. If these differences in hue are small, they can be calculated with color temperature and this is called correlated color temperature.

The 4000K, 4500K and 6600K preset settings in this camera are correlated color temperatures, and should not be considered strictly as color temperatures. Use these settings for shooting conditions under fluorescent lights.

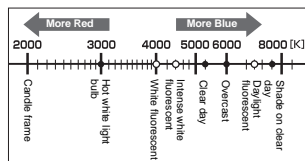

- The color temperatures for each light source indicated in the above scale are approximate.



## Record mode and file size/number of storable still pictures

The file size in the table is approximate for files with a 4:3 aspect ratio.

Record mode	Number of pixels (PIXEL COUNT)	Compression	File format	File size (MB)	Number of storable still pictures (with 1 GB xD-Picture Card)
RAW	4032 x 3024	Loss-less compression	ORF	Approx. 13.9	72
SF		1/2.7		Approx. 8.2	121
F		1/4		Approx. 5.7	175
N		1/8		Approx. 2.7	376
B	3200 x 2400	1/12	JPEG	Approx. 1.8	561
SF		1/2.7		Approx. 5.4	187
F		1/4		Approx. 3.4	300
N		1/8		Approx. 1.7	592
B	2560 x 1920	1/12	JPEG	Approx. 1.2	876
SF		1/2.7		Approx. 3.2	316
F		1/4		Approx. 2.2	466
N		1/8		Approx. 1.1	913
B	1600 x 1200	1/12	JPEG	Approx. 0.8	1361
SF		1/2.7		Approx. 1.3	789
F		1/4		Approx. 0.9	1163
N		1/8		Approx. 0.5	2205
B	1280 x 960	1/12	JPEG	Approx. 0.4	3198
SF		1/2.7		Approx. 0.9	1230
F		1/4		Approx. 0.6	1776
N		1/8		Approx. 0.3	3366
B	1024 x 768	1/12	JPEG	Approx. 0.3	4569
SF		1/2.7		Approx. 0.6	1881
F		1/4		Approx. 0.4	2665
N		1/8		Approx. 0.3	4920
B	640 x 480	1/12	JPEG	Approx. 0.2	6396
SF		1/2.7		Approx. 0.3	4264
F		1/4		Approx. 0.2	5815
N		1/8		Approx. 0.1	9138
B		1/12		Approx. 0.1	12793

Information

### ! Notes

- The number of remaining pictures may change according to the subject or factors like whether print reservations have been made or not. In certain instances, the number of remaining pictures displayed on the viewfinder or the LCD monitor does not change even when you take pictures or stored images are erased.
- The actual file size varies according to the subject.
- The maximum number of storable still pictures displayed on the monitor is 9999.
- The maximum number of storable still pictures displayed on the control panel is 999.

11

## Functions that can be registered with My Mode and Custom Reset Setting

Function	My Mode registration	Custom reset setting registration	Function	My Mode registration	Custom reset setting registration
Image stabilizer	✓	✓	FUNCTION	—	✓
PICTURE MODE	✓	✓	RLS PRIORITY S	✓	✓
GRADATION	✓	✓	RLS PRIORITY C	✓	✓
NOISE REDUCT.	✓	✓	L fps	—	✓
WB	✓	✓	SLEEP	—	✓
METERING	✓	✓	BACKLIT LCD	—	✓
ISO	✓	✓	4 h TIMER	—	—
NOISE FILTER	✓	✓	USB MODE	—	—
Flash mode	✓	✓	LIVE VIEW BOOST	✓	✓
RC MODE	✓	✓	LV FRAME RATE	✓	✓
AF MODE	✓	✓	FACE DETECT	—	✓
AF AREA	✓	✓	INFO SETTING	—	✓
ANTI-SHOCK [♦]	✓	✓	LEVEL GAUGE	—	✓
AE BKT	✓	✓	EV STEP	✓	✓
WB BKT	✓	✓	ISO STEP	✓	✓
FL BKT	✓	✓	ISO-AUTO SET	—	✓
ISO BKT	✓	✓	ISO-AUTO	—	✓
MULTIPLE EXPOSURE	—	✓	AELMetering	—	✓
AF ILLUMINAT.	✓	✓	BULB TIMER	—	✓
FOCUS RING	—	✓	X-SYNC.	✓	✓
C-AF LOCK	—	—	SLOW LIMIT	✓	✓
AF AREA POINTER	—	—	AUTO POP UP	—	✓
AF SENSITIVITY	—	—	ALL  WB	—	—
[••] SET UP	—	—	COLOR SPACE	✓	✓
RESET LENS	—	—	SHADING COMP.	✓	✓
BULB FOCUSING	—	—	SET	—	✓
LIVE VIEW AF MODE	✓	✓	PIXEL COUNT	—	✓
DIAL FUNCTION	—	✓	IMAGE ASPECT	✓	✓
DIAL DIRECTION	—	✓	ASPECT SHOOTING	—	✓
AEL/AFL	—	✓	QUICK ERASE	—	✓
AEL/AFL MEMO	—	✓	RAW+JPEG ERASE	—	✓
FUNCTION	—	✓	FILE NAME	—	—
MY MODE SETUP	—	—	PRIORITY SET	—	—
BUTTON TIMER	—	—	dpi SETTING	—	—
			CLEANING MODE	—	—
			EXT. WB DETECT	✓	✓

Function	My Mode registration	Custom reset setting registration	Function	My Mode registration	Custom reset setting registration
AF FOCUS ADJ.	✓	✓	EDIT FILENAME	—	—
EXPOSURE SHIFT	✓	✓		—	—
BATTERY TYPE	✓	✓		—	—
WARNING LEVEL	—	—	VIDEO OUT	—	—
LEVEL ADJUST	—	—	REC VIEW	—	✓
	—	—	PIXEL MAPPING	—	—
	—	—	FIRMWARE	—	—

✓: Can be registered. —: Cannot be registered.

\* Includes anti-shock.

## Menu directory

### Shooting Menu

Tab	Function	Setting	Ref. page	
	CARD SETUP	ALL ERASE/FORMAT	P. 92 P. 127	
	CUSTOM RESET	RESET	P. 108	
RESET1		SET/RESET		
RESET2		SET/RESET		
PICTURE MODE	VIVID/ NATURAL*/ MUTED/ PORTRAIT/ MONOTONE/CUSTOM		P. 70	
GRADATION	AUTO/NORMAL*/HIGH KEY/LOW KEY		P. 71	
		RAW/ F/ N*/ N/ S/ LF+RAW/ LN+RAW/ MN+RAW/ SN+RAW	P. 64	
WB		AUTO*	A -7 - +7, G -7 - +7	P. 66
		5300K	A -7 - +7, G -7 - +7	
		7500K	A -7 - +7, G -7 - +7	
		6000K	A -7 - +7, G -7 - +7	
		3000K	A -7 - +7, G -7 - +7	
		4000K	A -7 - +7, G -7 - +7	
		4500K	A -7 - +7, G -7 - +7	
		6600K	A -7 - +7, G -7 - +7	
		5500K	A -7 - +7, G -7 - +7	
			A -7 - +7, G -7 - +7	
	CWB	2000K - 14000K		
ISO	AUTO*/100 - 3200		P. 50	
NOISE REDUCT.	OFF/ON/AUTO*		P. 72	
NOISE FILTER	OFF/LOW/STANDARD*/HIGH		P. 72	

Tab	Function	Setting	Ref. page	
2	METERING	ESP + AF/ESP*	P. 46	
	RC MODE	OFF*/ON	P. 79	
		-3.0 - 0.0* - +3.0	P. 76	
	AF MODE	S-AF*/C-AF/MF/S-AF+MF/C-AF+MF	P. 53	
	AF AREA	[:::]*/[·]/[:::]	P. 55	
	ANTI-SHOCK [A]	OFF*/1SEC - 30SEC	P. 62	
	AE BKT	OFF*/3F 0.3EV/3F 0.7EV/3F 1.0EV/5F 0.3EV/5F 0.7EV/5F 1.0EV	P. 48	
	WB BKT	A-B	OFF*/3F 2STEP/3F 4STEP/3F 6STEP	P. 69
		G-M		
	FL BKT	OFF*/3F 0.3EV/3F 0.7EV/3F 1.0EV	P. 77	
ISO BKT	OFF*/3F 0.3EV/3F 0.7EV/3F 1.0EV	P. 51		
MULTIPLE EXPOSURE	FRAME	OFF*/2F/3F/4F	P. 51	
	AUTO GAIN	OFF*/ON		
	OVERLAY	OFF*/ON		

\* Factory default setting

## Playback Menu

Tab	Function	Setting	Ref. page	
▶			P. 86	
		OFF/ON*	P. 86	
	EDIT	RAW/JPEG	RAW DATA EDIT	P. 87
			JPEG EDIT	
		IMAGE OVERLAY	2IMAGES MERGE/3IMAGES MERGE/4IMAGES MERGE	
			P. 110	
	COPY ALL	YES/NO	P. 90	
	RESET PROTECT	YES/NO	P. 91	

\* Factory default setting

## Custom Menu 1

Tab	Function	Setting	Ref. page	
11	AF/MF		P. 93	
	AF ILLUMINAT.	OFF/ON*	P. 93	
	FOCUS RING	/	P. 93	
	C-AF LOCK	OFF*/ON	P. 93	
	AF AREA POINTER	OFF/ON*	P. 93	
	AF SENSITIVITY	NORMAL*/SMALL	P. 93	
	SET UP	OFF*/LOOP/SPIRAL	P. 94	
	RESET LENS	OFF/ON*	P. 94	
	BULB FOCUSING	OFF/ON*	P. 94	
	LIVE VIEW AF MODE	AF SENSOR/HYBRID AF/IMAGER AF*	P. 35	
	BUTTON/DIAL		P. 94	
	DIAL FUNCTION	<b>P</b>	<b>Ps</b> *//	P. 94
		<b>A</b>	FNo.//	
		<b>S</b>	SHUTTER*//	
		<b>M</b>	Main dial: SHUTTER*/FNo. Sub dial: SHUTTER/FNo.*	
		MENU	Main dial:  /  / VALUE*	
			Sub dial:  /  / VALUE	
	DIAL DIRECTION	DIAL1*/DIAL2	P. 95	
	AEL/AFL	S-AF*	mode1*/mode2/mode3	P. 95
C-AF		mode1/mode2*/mode3/mode4		
MF		mode1*/mode2/mode3		
AEL/AFL MEMO	OFF*/ON	P. 96		
FUNCTION	Fn FACE DETECT*/PREVIEW/LIVE PREVIEW// HOME/MF/RAW  /TEST PICTURE/MY MODE/LEVEL GAUGE/OFF	P. 96		
MY MODE SETUP	MY MODE1/MY MODE2	P. 97		
BUTTON TIMER	OFF/3SEC/5SEC/8SEC*/HOLD	P. 97		
	OFF*/ON	P. 97		
FUNCTION	OFF*/	P. 97		
RELEASE/		P. 97		
RLS PRIORITY S	OFF*/ON	P. 97		
RLS PRIORITY C	OFF/ON*	P. 97		
L fps	1fps/2fps/3fps*/4fps	P. 97		

\* Factory default setting

Tab	Function	Setting	Ref. page	
11	DISP/PC		P. 98	
	■))	OFF/ON*	P. 98	
	SLEEP	OFF/1MIN*/3MIN/5MIN/10MIN	P. 98	
	BACKLIT LCD	8SEC*/30SEC*/1MIN/HOLD	P. 98	
	4 h TIMER	OFF/4 h*	P. 98	
	USB MODE	AUTO*/STORAGE/MTP/CONTROL/□EASY/ □CUSTOM	P. 98	
	LIVE VIEW BOOST	OFF*/ON	P. 99	
	LV FRAME RATE	NORMAL*/HIGH	P. 99	
	☺ FACE DETECT	OFF*/ON	P. 38 P. 99	
	INFO SETTING	▶ INFO	IMAGE ONLY/OVERALL/□/□ HIGHLIGHT&SHADOW	P. 99
		LV-INFO	□/□ZOOM/MULTI VIEW/ IMAGE ONLY/□/□/□	
	LEVEL GAUGE	OFF*/ON	P. 99	
	EXP/ISO		P. 100	
	EV STEP	1/3EV*/1/2EV/1EV	P. 100	
	ISO STEP	1/3EV*/1EV	P. 100	
ISO-AUTO SET	HIGH LIMIT	200 – 3200 (800*)	P. 100	
	DEFAULT	200 – 3200 (200*)		
ISO-AUTO	P/A/S*/ALL	P. 100		
AEL Metering	AUTO*/□/□/□HI/□SH	P. 100		
BULB TIMER	1 – 30MIN (8MIN*)	P. 100		
⚡ CUSTOM		P. 101		
⚡ X-SYNC.	1/60 – 1/250 (1/250*)	P. 101		
⚡ SLOW LIMIT	1/30 – 1/250 (1/60*)	P. 101		
□+□	OFF*/ON	P. 101		
AUTO POP UP	OFF/ON*	P. 101		
◀/ASPECT/COLOR/WB		P. 101		
ALL [WB]	ALL SET	A –7 – +7 G –7 – +7	P. 101	
	ALL RESET	YES/NO		
COLOR SPACE	sRGB*/AdobeRGB	P. 101		
SHADING COMP.	OFF*/ON	P. 102		
◀ SET	◀1 – ◀4	□/□/□ SF/F/N/B	P. 102	
PIXEL COUNT	Middle	3200 x 2400/2560 x 1920/ 1600 x 1200	P. 102	
	S small	1280 x 960*/1024 x 768/ 640 x 480		
IMAGE ASPECT	4:3*/3:2/16:9/6:6/5:4/7:6/6:5/7:5/3:4	P. 102		
ASPECT SHOOTING	LV*/ALL	P. 103		
RECORD/ERASE		P. 103		
QUICK ERASE	OFF*/ON	P. 103		
RAW+JPEG ERASE	JPEG/RAW/RAW+JPEG*	P. 103		
FILE NAME	AUTO*/RESET	P. 104		
PRIORITY SET	NO*/YES	P. 104		
dpi SETTING	AUTO*/CUSTOM	P. 104		

Tab	Function	Setting	Ref. page	
11	UTILITY		P. 104	
	CLEANING MODE	—	P. 126	
	EXT. WB DETECT	OFF/ON*	P. 104	
	AF FOCUS ADJ.	SET AF DATA	OFF*/DEFAULT DATA/LENS DATA	P. 105
		DATA LIST	CHECK/DELETE/EDIT	
	EXPOSURE SHIFT		-1 - +1	P. 106
	BATTERY TYPE	1 /  2 /  3	P. 106	
WARNING LEVEL	-2 - 0* - +2	P. 107		
LEVEL ADJUST	RESET/ADJUST	P. 107		

\* Factory default setting

## Custom Menu 2

Tab	Function	Setting	Ref. page	
12		—	P. 16	
	/	/	P. 107	
	EDIT FILENAME	Adobe RGB sRGB	OFF*/A - Z/0 - 9	P. 107
		-7 - +7    -7 - +7	P. 107	
		*1	P. 107	
	VIDEO OUT	*1	P. 108	
	REC VIEW	OFF/AUTO  / 1SEC - 20SEC (5SEC*)	P. 108	
	PIXEL MAPPING	—	P. 126	
	FIRMWARE	—	P. 108	

\* Factory default setting

\*1 Settings differ depending on the region where the camera is purchased.

## Camera specifications

### ■ Product type

Product type	: Single-lens reflex digital camera with interchangeable lens system
Lens	: Zuiko Digital, Four Thirds System Lens
Lens mount	: Four Thirds mount
Equivalent focal length on a 35 mm film camera	: Approx. twice the focal length of the lens

### ■ Image pickup device

Product type	: 4/3" Live MOS sensor
No. of total pixels	: Approx. 13,100,000 pixels
No. of effective pixels	: Approx. 12,300,000 pixels
Screen size	: 17.3 mm (H) x 13.0 mm (V) (0.7" x 0.5")
Aspect ratio	: 1.33 (4:3)

### ■ Viewfinder

Product type	: Eye-level single-lens reflex viewfinder
Field of view	: Approx. 98% (for field of view on recorded images)
Viewfinder magnification	: Approx. 1.02x (-1 m <sup>-1</sup> , 50 mm lens, infinity)
Eye point	: Approx. 24.2 mm (1.0") (-1 m <sup>-1</sup> )
Diopter adjustment range	: -3.0 – +1.0 m <sup>-1</sup>
Optical path fraction	: Quick return half mirror
Depth of field	: Can be checked with the preview button (when PREVIEW registered with the <b>Fn</b> button)
Focusing screen	: Fixed
Eyecup	: Interchangeable

### ■ Live view

	: Uses Live MOS sensor for shooting, adjustable
	: Field of view of 100%

### ■ LCD monitor

Product type	: 2.7" TFT color LCD
Total no. of pixels	: Approx. 230,000 dots

### ■ Shutter

Product type	: Computerized focal-plane shutter
Shutter	: 1/8000 – 60 sec., Bulb shooting

### ■ Auto focus

Product type	: TTL phase-contrast detection system/Imager contrast detection system
Focusing points	: 11 points
AF luminance range	: EV -2 – EV 19 (ISO 100 equivalent, at room temperature 20 °C (68 °F), TTL phase-contrast detection system)
Selection of focusing point	: Auto, Optional
AF illuminator	: The built-in flash provides light

### ■ Exposure control

Metering system	: TTL full-aperture metering system (1) Digital ESP metering (2) Center weighted averaging metering (3) Spot metering (approx. 2% for the viewfinder screen)
Metering range	: EV 1 – 20 (Digital ESP metering, Center weighted average metering, Spot metering) (At room temperature, 50 mm f2, ISO 100)



- Shooting modes : (1) AUTO: Fully automatic  
 (2) **P** : Program AE (Program shift can be performed)  
 (3) **A** : Aperture priority AE  
 (4) **S** : Shutter priority AE  
 (5) **M** : Manual
- ISO sensitivity : 100 – 3200 (1/3, 1 EV step)  
 Exposure compensation : ±5 EV (1/3, 1/2, 1 EV step)
- **White balance**  
 Product type : Image pickup device and white balance sensor  
 Mode setting : Auto, Preset WB (8 settings), Customized WB, One-touch WB
- **Recording**  
 Memory : CF card (Compatible with Type I and II)  
 Microdrive (Compatible with FAT 16/32)  
 xD-Picture Card
- Recording system : Digital recording, JPEG (in accordance with Design rule for Camera File system [DCF]), RAW Data
- Applicable standards : Exif 2.2, Digital Print Order Format (DPOF), PRINT Image Matching III, PictBridge
- **Playback**  
 Playback mode : Single-frame playback, Close-up playback, Index display, Image rotation, Slideshow, Light box display, Calendar display
- Information display : Information display, Histogram display
- **Drive**  
 Drive mode : Single-frame shooting, Sequential shooting, Self-timer, Remote control  
 Sequential shooting : 5 frames/sec.  
 Self-timer : Operation time: 12 sec., 2 sec.  
 Optical remote control : Operation time: 2 sec., 0 sec. (instantaneous shooting)  
 (RM-1 Remote Control [optional])
- **Flash**  
 Synchronization : Synchronized with the camera at 1/250 sec. or less  
 Flash control mode : TTL-AUTO (TTL pre-flash mode), AUTO, MANUAL  
 External flash attachment : Hot shoe, external flash connector (x attachment)  
 Wireless flash function : Compatible with the Olympus wireless RC flash system
- **External connector**  
 USB connector, VIDEO OUT connector, remote cable connector (Multi-connector), DC-IN jack
- **Power supply**  
 Battery : Li-ion Battery (BLM-1) x1  
 AC power : AC adapter (AC-1) (optional)
- **Dimensions/weight**  
 Dimensions : 141.5 mm (W) x 107.5 mm (H) x 75 mm (D) (5.6" x 4.2" x 3.0")  
 (excluding protrusions)  
 Weight : Approx. 655 g (1.4 lb.) (without battery)
- **Operating environment**  
 Temperature : 0 °C – 40 °C (32 °F – 104 °F) (operation)/  
 –20 °C – 60 °C (–4 °F – 140 °F) (storage)  
 Humidity : 30 – 90% (operation)/10 – 90% (storage)

## Battery/charger specifications

### BLM-1 Lithium ion battery

---

MODEL NO.	: PS-BLM1
Product type	: Rechargeable Lithium ion battery
Nominal voltage	: DC 7.2 V
Nominal capacity	: 1500 mAh
No. of charge and discharge times	: Approx. 500 times (varies with usage conditions)
Ambient temperature	: 0 °C – 40 °C (32 °F – 104 °F) (charging) –10 °C – 60 °C (14 °F – 140 °F) (operation) –20 °C – 35 °C (–4 °F – 95 °F) (storage)
Dimensions	: Approx. 39 mm (W) x 55 mm (D) x 21.5 mm (H) (1.5" x 2.2" x 0.8")
Weight	: Approx. 75 g (0.2 lb.) (without protection cap)

### BCM-2 Lithium ion charger

---

MODEL NO.	: PS-BCM2
Rated input	: AC 100 V – 240 V (50/60 Hz)
Rated output	: DC 8.35 V, 400 mA
Charging time	: Approx. 5 hours (room temperature if using BLM-1)
Ambient temperature	: 0 °C – 40 °C (32 °F – 104 °F) (operation)/ –20 °C – 60 °C (–4 °F – 140 °F) (storage)
Dimensions	: Approx. 62 mm (W) x 83 mm (D) x 26 mm (H) (2.4" x 3.3" x 1.0")
Weight	: Approx. 72 g (0.2 lb.) (without AC cable)

**SPECIFICATIONS ARE SUBJECT TO CHANGE WITHOUT ANY NOTICE OR OBLIGATION ON THE PART OF THE MANUFACTURER.**

## SAFETY PRECAUTIONS



**CAUTION**  
RISK OF ELECTRIC SHOCK  
DO NOT OPEN



**CAUTION:** TO REDUCE THE RISK OF ELECTRICAL SHOCK, DO NOT REMOVE COVER (OR BACK). NO USER-SERVICEABLE PARTS INSIDE. REFER SERVICING TO QUALIFIED OLYMPUS SERVICE PERSONNEL.



An exclamation mark enclosed in a triangle alerts you to important operating and maintenance instructions in the documentation provided with the product.



**DANGER**

If the product is used without observing the information given under this symbol, serious injury or death may result.



**WARNING**

If the product is used without observing the information given under this symbol, injury or death may result.



**CAUTION**

If the product is used without observing the information given under this symbol, minor personal injury, damage to the equipment, or loss of valuable data may result.

### **WARNING!**

**TO AVOID THE RISK OF FIRE OR ELECTRICAL SHOCK, NEVER DISASSEMBLE, EXPOSE THIS PRODUCT TO WATER OR OPERATE IN A HIGH HUMIDITY ENVIRONMENT.**

## General Precautions

**Read All Instructions** – Before you use the product, read all operating instructions. Save all manuals and documentation for future reference.

**Cleaning** – Always unplug this product from the wall outlet before cleaning. Use only a damp cloth for cleaning. Never use any type of liquid or aerosol cleaner, or any type of organic solvent to clean this product.

**Attachments** – For your safety, and to avoid damaging the product, use only accessories recommended by Olympus.

**Water and Moisture** – For precautions on products with weatherproof designs, read the weatherproofing sections.

**Location** – To avoid damage to the product, mount the product securely on a stable tripod, stand, or bracket.

**Power Source** – Connect this product only to the power source described on the product label.

**Lightning** – If a lightning storm occurs while using an AC adapter, remove it from the wall outlet immediately.

**Foreign Objects** – To avoid personal injury, never insert a metal object into the product.

**Heat** – Never use or store this product near any heat source such as a radiator, heat register, stove, or any type of equipment or appliance that generates heat, including stereo amplifiers.

## Product Handling Precautions



### **WARNING**

- Do not use the camera near flammable or explosive gases.
- Do not use the flash and LED on people (infants, small children, etc.) at close range.
  - You must be at least 1 m (3 ft.) away from the faces of your subjects. Firing the flash too close to the subject's eyes could cause a momentary loss of vision.

- **Keep young children and infants away from the camera.**
  - Always use and store the camera out of the reach of young children and infants to prevent the following dangerous situations which could cause serious injury:
    - Becoming entangled in the camera strap, causing strangulation.
    - Accidentally swallowing the battery, cards or other small parts.
    - Accidentally firing the flash into their own eyes or those of another child.
    - Accidentally being injured by the moving parts of the camera.
- **Do not look at the sun or strong lights with the camera.**
- **Do not use or store the camera in dusty or humid places.**
- **Do not cover the flash with a hand while firing.**



### CAUTION

- **Stop using the camera immediately if you notice any unusual odors, noise, or smoke around it.**
  - Never remove the batteries with bare hands, which may cause a fire or burn your hands.
- **Never hold or operate the camera with wet hands.**
- **Do not leave the camera in places where it may be subject to extremely high temperatures.**
  - Doing so may cause parts to deteriorate and, in some circumstances, cause the camera to catch fire. Do not use the charger or AC adapter if it is covered (such as a blanket). This could cause overheating, resulting in fire.
- **Handle the camera with care to avoid getting a low-temperature burn.**
  - When the camera contains metal parts, overheating can result in a low-temperature burn. Pay attention to the following:
    - When used for a long period, the camera will get hot. If you hold on to the camera in this state, a low-temperature burn may be caused.
    - In places subject to extremely cold temperatures, the temperature of the camera's body may be lower than the environmental temperature. If possible, wear gloves when handling the camera in cold temperatures.
- **Be careful with the strap.**
  - Be careful with the strap when you carry the camera. It could easily catch on stray objects – and cause serious damage.

## Battery Handling Precautions

Follow these important guidelines to prevent batteries from leaking, overheating, burning, exploding, or causing electrical shocks or burns.



### DANGER

- The camera uses a lithium ion battery specified by Olympus. Charge the battery with the specified charger. Do not use any other chargers.
- Never heat or incinerate batteries.
- Take precautions when carrying or storing batteries to prevent them from coming into contact with any metal objects such as jewelry, pins, fasteners, etc.
- Never store batteries where they will be exposed to direct sunlight, or subjected to high temperatures in a hot vehicle, near a heat source, etc.
- To prevent causing battery leaks or damaging their terminals, carefully follow all instructions regarding the use of batteries. Never attempt to disassemble a battery or modify it in any way, by soldering, etc.
- If battery fluid gets into your eyes, flush your eyes immediately with clear, cold running water and seek medical attention immediately.
- Always store batteries out of the reach of small children. If a child accidentally swallows a battery, seek medical attention immediately.



### WARNING

- Keep batteries dry at all times.
- To prevent batteries from leaking, overheating, or causing a fire or explosion, use only batteries recommended for use with this product.
- Insert the battery carefully as described in the operating instructions.
- If rechargeable batteries have not been recharged within the specified time, stop charging them and do not use them.
- Do not use a battery if it is cracked or broken.
- If a battery leaks, becomes discolored or deformed, or becomes abnormal in any other way during operation, stop using the camera.
- If a battery leaks fluid onto your clothing or skin, remove the clothing and flush the affected area with clean, running cold water immediately. If the fluid burns your skin, seek medical attention immediately.
- Never subject batteries to strong shocks or continuous vibration.



## CAUTION

- Before loading, always inspect the battery carefully for leaks, discoloration, warping, or any other abnormality.
- The battery may become hot during prolonged use. To avoid minor burns, do not remove it immediately after using the camera.
- Always unload the battery from the camera before storing the camera for a long period.
- This camera uses a lithium ion battery specified by Olympus. Do not use any other type of battery. For safe and proper use, read the battery's instruction manual carefully before using it.
- If the battery's terminals get wet or greasy, camera contact failure may result. Wipe the battery well with a dry cloth before use.
- Always charge a battery when using it for the first time, or if it has not been used for a long period.
- When operating the camera with battery power at low temperatures, try to keep the camera and spare battery as warm as possible. A battery that has run down at low temperatures may be restored after it is warmed at room temperature.
- The number of pictures you can take may vary depending on the shooting conditions or battery.
- Before going on a long trip, and especially before traveling abroad, purchase extra batteries.
- A recommended battery may be difficult to obtain while traveling.
- Please recycle batteries to help save our planet's resources. When you throw away dead batteries, be sure to cover their terminals and always observe local laws and regulations.

## Caution for Usage Environment

- To protect the high-precision technology contained in this product, never leave the camera in the places listed below, no matter if in use or storage:
  - Places where temperatures and/or humidity are high or go through extreme changes. Direct sunlight, beaches, locked cars, or near other heat sources (stove, radiator, etc.) or humidifiers.
  - In sandy or dusty environments.
  - Near flammable items or explosives.
  - In wet places, such as bathrooms or in the rain. When using products with weatherproof designs, read their manuals as well.
  - In places prone to strong vibrations.
- Never drop the camera or subject it to severe shocks or vibrations.
- When mounted on a tripod, adjust the position of the camera with the tripod head. Do not twist the camera.
- Do not leave the camera pointed directly at the sun. This may cause lens or shutter curtain damage, color failure, ghosting on the image pickup device, or may possibly cause fires.
- Do not touch electric contacts on cameras and interchangeable lenses. Remember to attach the body cap when removing the lens.
- Before storing the camera for a long period, remove the battery. Select a cool, dry location for storage to prevent condensation or mold from forming inside the camera. After storage, test the camera by turning it on and pressing the shutter release button to make sure that it is operating normally.
- Always observe the operating environment restrictions described in the camera's manual.

## LCD Monitor

- Do not push the monitor forcibly; otherwise the image may become vague, resulting in a playback mode failure or damage to the monitor.
- A strip of light may appear on the top/bottom of the monitor, but this is not a malfunction.
- When a subject is viewed diagonally in the camera, the edges may appear zigzagged on the monitor. This is not a malfunction; it will be less noticeable in playback mode.
- In places subject to low temperatures, the LCD monitor may take a long time to turn on or its color may change temporarily. When using the camera in extremely cold places, it is a good idea to occasionally place it in a warm place. An LCD monitor exhibiting poor performance due to low temperatures will recover in normal temperatures.
- The LCD used for the monitor is made with high-precision technology. However, black spots or bright spots of light may appear constantly on the LCD Monitor. Due to its characteristics or the angle at which you are viewing the monitor, the spot may not be uniform in color and brightness. This is not a malfunction.

## Lens

- Do not immerse in water or splash with water.
- Do not drop or exert strong force on the lens.
- Do not hold at the moving part of the lens.
- Do not touch the lens surface directly.
- Do not touch the contact points directly.
- Do not subject to abrupt temperature changes.
- The operating temperature range is  $-10^{\circ}\text{C}$  –  $40^{\circ}\text{C}$  ( $14^{\circ}\text{F}$  –  $104^{\circ}\text{F}$ ). Always use within this temperature range.

## Legal and Other Notices

- Olympus makes no representations or warranties regarding any damages, or benefit expected by using this unit lawfully, or any request from a third person, which are caused by the inappropriate use of this product.
- Olympus makes no representations or warranties regarding any damages or any benefit expected by using this unit lawfully which are caused by erasing picture data.

## Disclaimer of Warranty

- Olympus makes no representations or warranties, either expressed or implied, by or concerning any content of these written materials or software, and in no event shall be liable for any implied warranty of merchantability or fitness for any particular purpose or for any consequential, incidental or indirect damages (including but not limited to damages for loss of business profits, business interruption and loss of business information) arising from the use or inability to use these written materials or software or equipment. Some countries do not allow the exclusion or limitation of liability for consequential or incidental damages, so the above limitations may not apply to you.
- Olympus reserves all rights to this manual.

## Warning

Unauthorized photographing or use of copyrighted material may violate applicable copyright laws. Olympus assumes no responsibility for unauthorized photographing, use or other acts that infringe upon the rights of copyright owners.

## Copyright Notice

All rights reserved. No part of these written materials or this software may be reproduced or used in any form or by any means, electronic or mechanical, including photocopying and recording or the use of any type of information storage and retrieval system, without the prior written permission of Olympus. No liability is assumed with respect to the use of the information contained in these written materials or software, or for damages resulting from the use of the information contained therein. Olympus reserves the right to alter the features and contents of this publication or software without obligation or advance notice.

## FCC Notice

- Radio and Television Interference  
Changes or modifications not expressly approved by the manufacturer may void the user's authority to operate this equipment. This equipment has been tested and found to comply with the limits for a Class B digital device, pursuant to Part 15 of the FCC Rules. These limits are designed to provide reasonable protection against harmful interference in a residential installation.  
This equipment generates, uses, and can radiate radio frequency energy and, if not installed and used in accordance with the instructions, may cause harmful interference to radio communications.  
However, there is no guarantee that interference will not occur in a particular installation. If this equipment does cause harmful interference to radio or television reception, which can be determined by turning the equipment off and on, the user is encouraged to try to correct the interference by one or more of the following measures:
  - Adjust or relocate the receiving antenna.
  - Increase the distance between the camera and receiver.
  - Connect the equipment to an outlet on a circuit different from that to which the receiver is connected.
  - Consult your dealer or an experienced radio/TV technician for help. Only the OLYMPUS-supplied USB cable should be used to connect the camera to USB enabled personal computers (PC).

Any unauthorized changes or modifications to this equipment would void the user's authority to operate it.

## Use Only Dedicated Rechargeable Battery and Battery Charger

We strongly recommend that you use only the genuine Olympus dedicated rechargeable battery and battery charger with this camera.

Using a non-genuine rechargeable battery and/or battery charger may result in fire or personal injury due to leakage, heating, ignition or damage to the battery. Olympus does not assume any liability for accidents or damage that may result from the use of a battery and/or battery charger that are not genuine Olympus accessories.

## For customers in North and South America

### For customers in USA

Declaration of Conformity

Model Number : E-30

Trade Name : OLYMPUS

Responsible Party : **OLYMPUS IMAGING AMERICA INC.**

Address : 3500 Corporate Parkway, P.O. Box 610, Center Valley,  
PA 18034-0610, USA

Telephone Number: 484-896-5000

Tested To Comply With FCC Standards

FOR HOME OR OFFICE USE

This device complies with Part 15 of the FCC rules. Operation is subject to the following two conditions:

- (1) This device may not cause harmful interference.
- (2) This device must accept any interference received, including interference that may cause undesired operation.

### For customers in Canada

This Class B digital apparatus meets all requirements of the Canadian Interference-Causing Equipment Regulations.

## For customers in Europe



"CE" mark indicates that this product complies with the European requirements for safety, health, environment and customer protection. "CE" mark cameras are intended for sales in Europe.



This symbol [crossed-out wheeled bin WEEE Annex IV] indicates separate collection of waste electrical and electronic equipment in the EU countries. Please do not throw the equipment into the domestic refuse. Please use the return and collection systems available in your country for the disposal of this product.



This symbol [crossed-out wheeled bin Directive 2006/66/EC Annex II] indicates separate collection of waste batteries in the EU countries. Please do not throw the batteries into the domestic refuse. Please use the return and collection systems available in your country for the disposal of the waste batteries.

## Provisions of warranty

1. If this product proves to be defective, although it has been used properly (in accordance with the written Handling Care and Operating instructions supplied with it), during a period of two years from the date of purchase from an authorized Olympus distributor within the business area of Olympus Imaging Europa GmbH as stipulated on the website: <http://www.olympus.com> this product will be repaired, or at Olympus's option replaced, free of charge. To claim under this warranty the customer must take the product and this Warranty Certificate before the end of the two year warranty period to the dealer where the product was purchased or any other Olympus service station within the business area of Olympus Imaging Europa GmbH as stipulated on the website: <http://www.olympus.com>. During the one year period of the World Wide Warranty the customer may turn the product in at any Olympus service station. Please notice that not in all countries such Olympus service station exists.
2. The customer shall transport the product to the dealer or Olympus authorized service station at his own risk and shall be responsible for any costs incurred in transporting the product.
3. This warranty does not cover the following and the customer will be required to pay repair charge, even for defects occurring within the warranty period referred to above.
  - (a) Any defect that occurs due to mishandling (such as an operation performed that is not mentioned in the Handling Care or other sections of the instructions, etc.)
  - (b) Any defect that occurs due to repair, modification, cleaning, etc. performed by anyone other than Olympus or an Olympus authorized service station.
  - (c) Any defect or damage that occurs due to transport, a fall, shock, etc. after purchase of the product.
  - (d) Any defect or damage that occurs due to fire, earthquake, flood damage, thunderbolt, other natural disasters, environmental pollution and irregular voltage sources.
  - (e) Any defect that occurs due to careless or improper storage (such as keeping the product under conditions of high temperature and humidity, near insect repellents such as naphthalene or harmful drugs, etc.), improper maintenance, etc.
  - (f) Any defect that occurs due to exhausted batteries, etc.
  - (g) Any defect that occurs due to sand, mud, etc. entering the inside of the product casing.
  - (h) When this Warranty Certificate is not returned with the product.
  - (i) When any alterations whatsoever are made to the Warranty Certificate regarding the year, month and date of purchase, the customer's name, the dealer's name, and the serial number.
  - (j) When proof of purchase is not presented with this Warranty Certificate.
4. This Warranty applies to the product only; the Warranty does not apply to any other accessory equipment, such as the case, strap, lens cap and batteries.
5. Olympus's sole liability under this warranty shall be limited to repairing or replacing the product. Any liability for indirect or consequential loss or damage of any kind incurred or suffered by the customer due to a defect of the product, and in particular any loss or damage caused to any lenses, films, other equipment or accessories used with the product or for any loss resulting from a delay in repair or loss of data, is excluded. Compelling regulations by law remain unaffected by this.

## Notes regarding warranty maintenance

1. This warranty will only be valid if the Warranty Certificate is duly completed by Olympus or an authorized dealer or other documents contain sufficient proof. Therefore, please make sure that your name, the name of the dealer, the serial number and the year, month and date of purchase are all completed or the original invoice or the sales receipt (indicating the dealer's name, the date of purchase and product type) is attached to this Warranty Certificate. Olympus reserves the right to refuse free-of-charge service if neither Warranty Certificate is completed nor the above document is attached or if the information contained in it is incomplete or illegible.
2. Since this Warranty Certificate will not be re-issued, keep it in a safe place.
- Please refer to the list on the web site: <http://www.olympus.com> for the authorized international Olympus service network.

## Trademarks

- IBM is a registered trademark of International Business Machines Corporation.
- Microsoft and Windows are registered trademarks of Microsoft Corporation.
- Macintosh is a trademark of Apple Inc.
- xD-Picture Card™ is a trademark.
- "Shadow Adjustment Technology" function contains patented technologies from Apical Limited.
- All other company and product names are registered trademarks and/or trademarks of their respective owners.
- The standards for camera file systems referred to in this manual are the "Design Rule for Camera File System/DCF" standards stipulated by the Japan Electronics and Information Technology Industries Association (JEITA).



apical







## Symbols

	97
	101
	98
	107
	141
	143
	96
	97
	98
	140
	102
	139
	140
	107
	96
	94
	98
	98
	79
	101
	101
	93
	94
	97
	98
	100
	101
	101
	103
	104
	70
	70
	70
	70
	98
<b>A</b>	
AC adapter	128
Adobe RGB	101
AE BKT	48
AE bracketing	48
AE lock	48
AEL/AFL	95
AEL/AFL MEMO	96
AELMetering	100
AF AREA	56
AF AREA POINTER	93
AF FOCUS ADJ.	105
AF ILLUMINAT.	93
AF MODE	53
AF SENSITIVITY	93
AF SENSOR	35
AF target mode	57
AF target	55
ALL	101
ALL ERASE	92
All target AF mode	55
ANTI-SHOCK	59, 62
Aperture priority shooting <b>A</b>	42
Aperture value	17, 42, 43
Art filter mode <b>ART</b>	5
Art filter/Scene <b>ARTSCN</b>	4
ASPECT	88
ASPECT SHOOTING	103
Auto flash	73
Auto focus	58, 122
AUTO POP UP	101
AUTO shooting AUTO	4
Auto white balance	66
<b>B</b>	
B (Basic)	64
B&W FILTER	71
BACKLIT LCD	98
Battery	12, 128
BATTERY TYPE	106
BEACH & SNOW	5
BLACK & WHITE	88
BULB FOCUSING	94
Bulb shooting	45, 62
BULB TIMER	100
BUTTON TIMER	97
<b>C</b>	
C-AF (continuous AF)	54
C-AF LOCK	93
C-AF+MF	55
Calendar display	84
CANDLE	5
CARD SETUP	92, 127
Cards	14, 127
Center weighted averaging metering	46
	107
CHILDREN	5
CLEANING MODE	126
Close-up playback <b>Q</b>	82
COLOR SPACE	101

Color temperature .....	134
CompactFlash .....	14, 127
Compression rate .....	64
Continuous AF (C-AF) .....	54
CONTRAST .....	71
CONTROL .....	98
Control panel .....	7
COPY ALL .....	90
Custom printing .....	114
CUSTOM RESET .....	108
Custom white balance CWB .....	66







## D

Date/time setting  .....	16
DIAL DIRECTION .....	95
DIAL FUNCTION .....	94
Digital ESP metering  .....	46
Diopter adjustment .....	15
Direct print .....	112
DIS MODE  .....	5
DOCUMENTS  .....	5
dpi SETTING .....	104
DPOF .....	110
Dust reduction .....	15, 125
Dynamic-single target AF mode  .....	56

## E

Easy printing .....	113
Easy shooting modes .....	4
EDIT FILENAME .....	107
EV STEP .....	100
Exposure compensation  .....	47
EXPOSURE SHIFT .....	106
EXT. WB DETECT .....	104
Eyepiece cover .....	11, 60

## F

F (Fine) .....	64
FACE DETECT  .....	38, 99
FILE NAME .....	104
Fill-in flash  .....	74
FIREWORKS  .....	5
FIRMWARE .....	108
FL BKT .....	77
Flash bracketing .....	77
Flash intensity control  .....	76
Flash mode  .....	73
Flash off  .....	74
Fn FACE DETECT .....	38, 96
Focus lock .....	58
FOCUS RING .....	93
FORMAT .....	127
Four Thirds system lenses .....	129



## G

GRADATION .....	71
GRAINY FILM  .....	5

## H

HIGH KEY  .....	5, 71
Histogram .....	39, 85
Home position  .....	57
HYBRID AF  .....	35





## I

IMAGE ASPECT .....	102
IMAGE OVERLAY .....	51
IMAGE STABILIZER IS .....	62
IMAGER AF  .....	35
Index display  .....	84
INFO SETTING .....	99
Information display .....	39, 85
IS (Image stabilizer) .....	62
ISO .....	50
ISO BKT .....	51
ISO bracketing .....	51
ISO STEP .....	100
ISO-AUTO .....	100
ISO-AUTO SET .....	100

## J



JPEG EDIT .....	87
-----------------	----

## L



 (Large) .....	64
LANDSCAPE  .....	4
Lens .....	13, 129
LEVEL ADJUST .....	107
LEVEL GAUGE .....	96, 99
Light box display .....	83
LIGHT TONE  .....	5
Lithium ion battery .....	12, 128
Lithium ion charger .....	12, 128
LIVE PREVIEW .....	45, 96
Live view .....	34
LIVE VIEW AF MODE .....	35
LIVE VIEW BOOST .....	99
LOW KEY  .....	5, 71
LV FRAME RATE .....	99

## M

 (Middle) .....	64
MACRO  .....	4
Manual flash .....	75

Manual focus (MF) .....	38, 54
Manual shooting <b>M</b> .....	44
METERING .....	46
MF .....	96
MF (manual focus) .....	54
Microdrive .....	14, 127
Monitor brightness adjustment  .....	107
MONOTONE .....	70
MTP .....	98, 120
Multi view display .....	40
MULTIPLE EXPOSURE  .....	51
MY MODE .....	96
MY MODE SETUP .....	97







## N

N (Normal) .....	64
NATURE MACRO  .....	5
NIGHT+PORTRAIT  .....	4
NOISE FILTER .....	72
NOISE REDUCT. .....	72
NTSC .....	108
Number of pixels .....	64

## O

OLYMPUS Master .....	116
Olympus wireless RC flash system .....	79
One-touch white balance  .....	69, 96







## P

PAL .....	108
PALE&LIGHT COLOR  .....	5
PANORAMA  .....	5, 41
PICT. TONE .....	71
PictBridge .....	112
PICTURE MODE .....	70
PIN HOLE  .....	5
Pixel count .....	64, 102
PIXEL MAPPING .....	126
POP ART  .....	5
PORTRAIT  .....	4
Preset white balance .....	66
PREVIEW .....	45, 96
Print reservation .....	110
PRIORITY SET .....	104
Program shift <b>Ps</b> .....	42
Program shooting <b>P</b> .....	42
Protecting  .....	91













## Q





QUICK ERASE .....	103
-------------------	-----

## R

RAW .....	65
RAW DATA EDIT .....	87
RAW  .....	96
RAW+JPEG ERASE .....	103
REC VIEW .....	108
Record mode  .....	64, 135
REDEYE FIX .....	88
Red-eye reduction flash  .....	73
Remote control  .....	60
RESET LENS .....	94
RESET PROTECT .....	91
Resizing  .....	88
RLS PRIORITY C .....	97
RLS PRIORITY S .....	97
Rotating images  .....	86

## S

 (Small) .....	64
S-AF (single AF) .....	53
S-AF+MF .....	55
SATURATION .....	71, 88
Scene mode  .....	5
Self-timer  .....	60
SEPIA .....	88
Sequential shooting H  .....	59
Sequential shooting L  .....	59
SF (Super Fine) .....	64
SHADING COMP. .....	102
SHADOW ADJ .....	88
SHARPNESS .....	71
Shutter priority shooting <b>S</b> .....	43
Shutter speed .....	17, 42, 43
Single AF (S-AF) .....	53
Single target AF mode [ • ] .....	55
Single-frame copy .....	90
Single-frame erase  .....	92
Single-frame playback .....	82
Single-frame protect .....	91
Single-frame shooting  .....	59
SLEEP .....	98
Slideshow  .....	86
Slow synchronization  SLOW .....	73
Slow synchronization  SLOW2/2nd CURTAIN .....	74
Small-single target AF mode [ • ]s .....	55, 93
SOFT FOCUS  .....	5
SPORT  .....	4

Spot metering – highlight control  H /	46
Spot metering – shadow control  S H	46
Spot metering 	46
sRGB	101
STORAGE	98, 117
Strap	11
SUNSET 	5
Super control panel	8, 22
Super FP flash	79

## T

---

TEST PICTURE	96
Trimming 	88, 115

## U

---

USB MODE	98
----------	----

## V

---

VIDEO OUT	108
Viewfinder	6, 15, 17

## W

---

WB	67
WB BKT	69
WB compensation	68
White balance bracketing	69
White balance sensor	67
White balance WB	66

## X

---

xD-Picture Card	14, 127
-----------------	---------

## Z

---

Zoom display	40
ZUIKO DIGITAL interchangeable lens	129















