

OLYMPUS®

<http://www.olympus.com/>

OLYMPUS IMAGING EUROPA GMBH

Premises: Wendenstrasse 14 – 18, 20097 Hamburg, Germany
Tel.: +49 40 - 23 77 3-0 / Fax: +49 40 - 23 07 61
Goods delivery: Bredowstrasse 20, 22113 Hamburg, Germany
Letters: Postfach 10 49 08, 20034 Hamburg, Germany

European Technical Customer Support:

Please visit our homepage <http://www.olympus-europa.com>
or call our TOLL FREE NUMBER*: **00800 - 67 10 83 00**

for Austria, Belgium, Denmark, Finland, France, Germany, Luxemburg, Netherlands,
Norway, Portugal, Spain, Sweden, Switzerland, United Kingdom.

* Please note some (mobile) phone services / provider do not permit access or request an
additional prefix to +800 numbers.

For all not listed European Countries and in case that you can't get connected
to the above mentioned number please make use of the following

CHARGED NUMBERS: **+49 180 5 - 67 10 83** or **+49 40 - 237 73 48 99**.

Our Technical Customer Support is available from 9 am to 6 pm MET (Monday to Friday).

Authorized Distributors

United Kingdom: Olympus Service Department /Eire
P.O. Box 222
Southall Middlesex UB2 4SH
Tel.: (0207) 2530513

South Africa: City Square Trading 197 (PTY) Ltd.
Unit A, The Meadows
Meadowbrooke Business Estate
Jacaranda Avenue, Olivedale Ext. 17
Johannesburg,
Tel.: +27 11 7042021

Egypt: Optoscient M. Nagui & Co
10. 26th July St., Cairo
Tel.: +20 2 391 4883

© 2009 OLYMPUS IMAGING CORP.

Printed in Germany · OIME · 5/2009 · Hab. · E0462361

E-P1

INSTRUCTION MANUAL

OLYMPUS

OLYMPUS®

DIGITAL CAMERA

E-P1

INSTRUCTION MANUAL

Basic guide

P. 2

Review the camera part names, the
basic steps for shooting and playback,
and the basic operations.

Table of Contents

P. 26

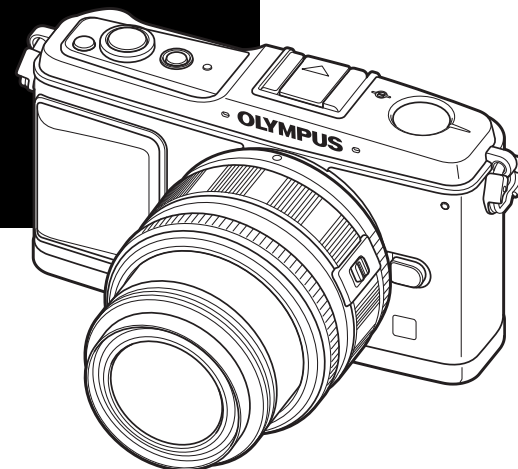

EN

- Thank you for purchasing an Olympus digital camera. Before you start to use your new camera, please read these instructions carefully to enjoy optimum performance and a longer service life. Keep this manual in a safe place for future reference.
- We recommend that you take test shots to get accustomed to your camera before taking important photographs.
- The screen and camera illustrations shown in this manual were produced during the development stages and may differ from the actual product.
- The contents in this manual are based on firmware version 1.0 for this camera. If there are addition and/or modification of functions due to firmware update for the camera, the contents will differ. For the latest information, please visit the Olympus website.

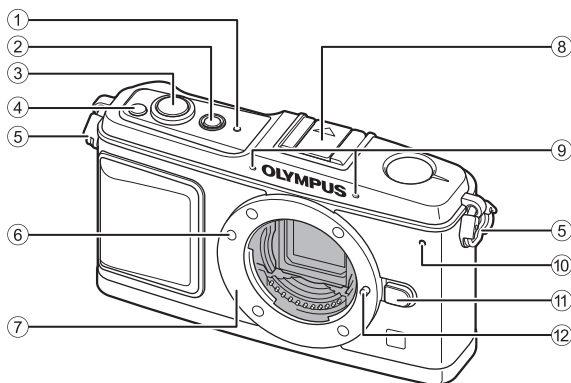

Camera



① SSWF indicator  P. 14, 128

② ON/OFF button  P. 14

③ Shutter button  P. 16, 60

④  (Exposure compensation) button  P. 50

⑤ Strap eyelet  P. 10

⑥ Lens attachment mark  P. 13

⑦ Mount

(Remove the body cap before attaching the lens.)

⑧ Hot shoe  P. 73

⑨ Microphone  P. 78, 90

⑩ Self-timer lamp  P. 62

⑪ Lens release button  P. 13

⑫ Lens lock pin

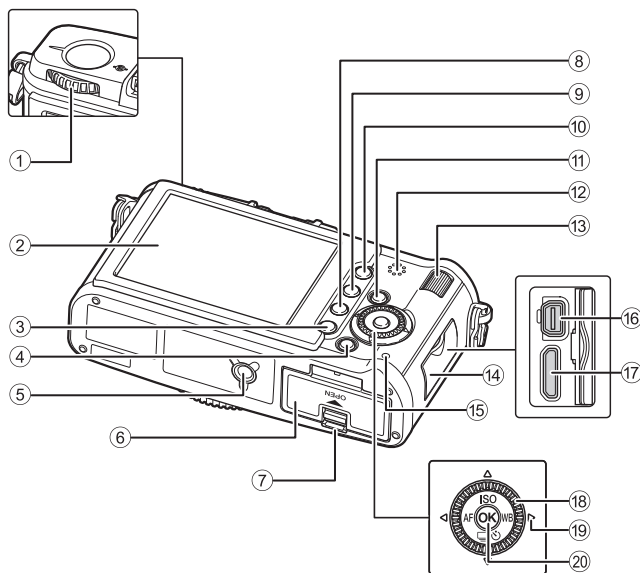

- ① Mode dial P. 4
 ② LCD monitor P. 8, 9
 ③ MENU button P. 24
 ④ INFO (Information display) button P. 23, 41, 83
 ⑤ Tripod socket
 ⑥ Battery/card compartment cover P. 11
 ⑦ Battery/card compartment lock P. 11
 ⑧ (Erase) button P. 92
 ⑨ (Playback) button P. 18, 81
 ⑩ AEL/AFL button P. 51, 99
 ⑪ (Protect) button P. 91
 ⑫ Fn button P. 100
 ⑬ Speaker
 ⑭ Connector cover
 ⑮ Card access lamp P. 16, 122
 ⑯ Multi-connector P. 87, 115, 120
 ⑰ HDMI mini-connector (type C) P. 88
 ⑱ Main dial () P. 19, 20
 ⑲ Arrow pad () P. 20, 21, 24
 Press the main dial in the following places.
 Up:
 Down:
 Left:
 Right:
 ⑳ button P. 24

Mode dial

The mode dial allows you to change the camera settings easily according to the subject.

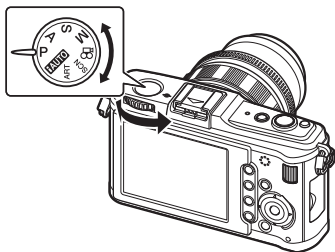

Advanced shooting modes

- For more advanced shooting and greater creative control, you can set the aperture value and shutter speed.
- The settings made in the advanced shooting modes are retained even if the camera is turned off.

P	Program shooting	Allows you to shoot using an aperture and shutter speed that the camera sets. (P. 44)
A	Aperture priority shooting	Allows you to set the aperture manually. The camera sets the shutter speed automatically. (P. 45)
S	Shutter priority shooting	Allows you to set the shutter speed manually. The camera sets the aperture automatically. (P. 46)
M	Manual shooting	Allows you to set the aperture and shutter speed manually. (P. 47)

Easy shooting modes

- Select according to the shooting scene. The camera sets the appropriate shooting conditions automatically.
- When rotating the mode dial or turning off the power in the easy shooting modes, functions with changes made to their settings are restored to the factory default settings.

iAUTO	iAuto	The camera automatically selects an optimal shooting mode from [PORTRAIT] , [LANDSCAPE] , [NIGHT SCENE] , [SPORT] , and [MACRO] . This is a fully automatic mode which allows you to shoot with the optimal settings for the scene by simply pressing the shutter button.
ART	Art filter	When you select a desired filter or scene, the camera optimizes the shooting conditions for that filter or scene.
SCN	Scene	In SCN mode, most of the functions cannot be changed.
MOVIE	Movie	Used for shooting movies. Besides using [P] and [A] , you can record a movie with the art filter.

Setting the art filter/scene

- Set the mode dial to ART or SCN.
 - The art filter menu or scene menu is displayed.



- Use to select the filter or scene.
- Press the button.

Types of art filters

Icon	Art filter	Icon	Art filter
	POP ART		LIGHT TONE
	SOFT FOCUS		GRAINY FILM
	PALE&LIGHT COLOR		PIN HOLE

Types of scene modes

Icon	Mode	Icon	Mode
	PORTRAIT		DIS MODE
	e-PORTRAIT		MACRO
	LANDSCAPE		NATURE MACRO
	LANDSCAPE+PORTRAIT		CANDLE
	SPORT		SUNSET
	NIGHT SCENE		DOCUMENTS
	NIGHT+PORTRAIT		PANORAMA (P. 43)
	CHILDREN		FIREWORKS
	HIGH KEY		BEACH & SNOW
	LOW KEY		

- Art filters and **[e-PORTRAIT]** are not applied to RAW images.
- If the record mode is set to **[RAW]** and art filter is applied, the record mode is automatically set to **[L+N+RAW]**.
- The grainy appearance of the picture may be emphasized depending on the type of art filter.
- When either RAW or JPEG+RAW are set in **[e-PORTRAIT]**, a RAW image and a JPEG ([2560x1920]) with applied effect are saved.
- When JPEG is set in **[e-PORTRAIT]**, two images are saved, one from before application of the effect (with set picture quality) and the other from after application of the effect ([2560x1920]).

Live control

The following screen which simultaneously displays shooting setting functions and associated options is called the live control. Press the  button to display the live control on the LCD monitor. You can set the art filter, the white balance and other effects while checking live view.

 “Using the live control to operate the camera” (P. 22)

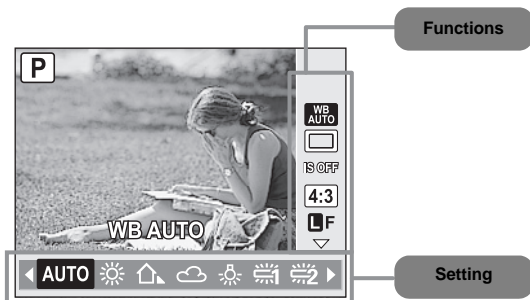

Functions	Setting	Ref. page
Scene mode* ¹		P. 5
Art filter mode* ¹		P. 5
Movie AE mode* ²	[P] [A] [AP] [AP] [AP] [AP] [AP] [AP]	P. 79
White balance	[AUTO] [WB] [CWB]	P. 67
Sequential shooting/ self-timer	[12S] [2S]	P. 61 – 62
Image stabilizer	[OFF] [I.S. 1] [I.S. 2] [I.S. 3] [FOCAL LENGTH]	P. 62
Aspect ratio	[4:3] [16:9] [3:2] [6:6]	P. 40
Record mode	[RAW] [L F] [L N] [L N] [S N] [L F+RAW] [L N+RAW] etc.	P. 64
ISO sensitivity	[AUTO] [100] [125] [160] [200] [250] [320] etc.	P. 53
Flash mode	[AUTO] [SLOW] [SLOW2] etc.	P. 75
Metering mode	[C] [C HI] [C] SH]	P. 49
AF mode	[S-AF] [C-AF] [MF] [S-AF+MF]	P. 56
Face detection	<td>P. 80</td>	P. 80

*1 ART or SCN mode only

*2  mode only

• There may be unavailable menus depending on the selected shooting mode.

Super control panel

The following screen allows the display and setting of shooting settings at the same time and is called the super control panel. On the live control display, press the INFO button to switch to the super control panel.

"Setting while looking at the super control panel" (P. 23)

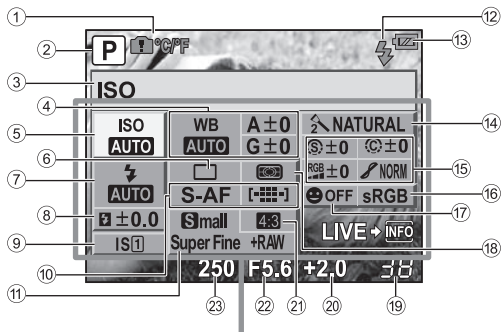

The functions within this area can be set on the super control panel.

- | | |
|---|---|
| <p>① Internal temperature warning
 °C/°F P. 127
 Arrow pad function P. 102</p> <p>② Shooting mode P. 4, 44 – 47</p> <p>③ Function name</p> <p>④ White balance P. 67
 White balance compensation P. 68</p> <p>⑤ ISO sensitivity P. 53</p> <p>⑥ Sequential shooting/self-timer P. 61 – 62</p> <p>⑦ Flash mode P. 75</p> <p>⑧ Flash intensity control P. 77</p> <p>⑨ Image stabilizer P. 62</p> <p>⑩ AF mode P. 56
 AF target P. 58</p> <p>⑪ Record mode P. 64</p> <p>⑫ Flash charging P. 124</p> <p>⑬ Battery check P. 8</p> | <p>⑭ Picture mode P. 71</p> <p>⑮ Sharpness P. 71
 Contrast P. 71
 Saturation P. 71
 Gradation P. 72
 B&W Filter P. 71
 Picture tone P. 71</p> <p>⑯ Color space P. 108</p> <p>⑰ Face detection P. 39, 104</p> <p>⑱ Metering mode P. 49</p> <p>⑲ Number of storable still pictures P. 140</p> <p>⑳ Exposure compensation value P. 50
 Exposure level P. 47</p> <p>㉑ Aspect ratio P. 40</p> <p>㉒ Aperture value P. 44 – 47</p> <p>㉓ Shutter speed P. 44 – 47</p> |
|---|---|

- Movie recording mode is not displayed.

LCD monitor (Live view)

You can use the LCD monitor to view the subject while shooting.

☞ “Using live view” (P. 37)

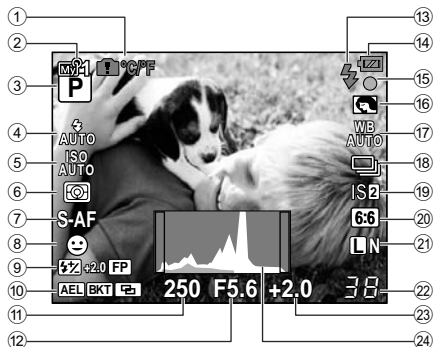

- | | |
|--|--|
| <p>① Internal temperature warning °C/°F
☞ P. 127
Arrow pad function ☞ P. 102</p> <p>② My Mode ☞ P. 101</p> <p>③ Shooting mode ☞ P. 4, 44 – 47</p> <p>④ Flash mode ☞ P. 75</p> <p>⑤ ISO sensitivity ☞ P. 53</p> <p>⑥ Metering mode ☞ P. 49</p> <p>⑦ AF mode ☞ P. 56</p> <p>⑧ Face detection ☞ P. 39, 104</p> <p>⑨ Flash intensity control ☞ P. 77
Super FP flash ☞ P. 74</p> <p>⑩ AE Lock ☞ P. 51
Auto bracket ☞ P. 52, 54, 70, 77
Multiple exposure ☞ P. 54
Home position ☞ P. 59</p> <p>⑪ Shutter speed ☞ P. 44 – 47</p> <p>⑫ Aperture value ☞ P. 44 – 47</p> <p>⑬ Flash ☞ P. 124 (blinks: charging in progress, lights up: charging completed)</p> | <p>⑭ Battery check
 Lit up (green) (ready for use)
 Lit up (green) (Battery is running low)
 Blinks (red) (charging required)</p> <p>⑮ AF confirmation mark ☞ P. 16, 38, 60</p> <p>⑯ Art filter/scene ☞ P. 5</p> <p>⑰ White balance ☞ P. 67</p> <p>⑱ Sequential shooting ☞ P. 61
Self-timer ☞ P. 62</p> <p>⑲ Image stabilizer IS1 IS2 IS3 ☞ P. 62</p> <p>⑳ Aspect ratio ☞ P. 40</p> <p>㉑ Record mode ☞ P. 64</p> <p>㉒ Number of storable still pictures ☞ P. 140
Available recording time</p> <p>㉓ Exposure compensation value ☞ P. 50</p> <p>㉔ Histogram ☞ P. 41</p> |
|--|--|

LCD monitor (Playback)

You can switch the monitor display using the INFO button.





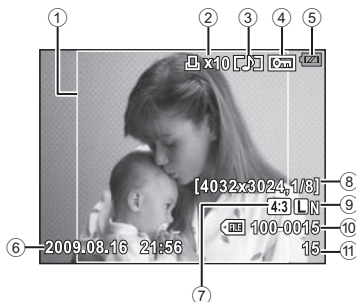



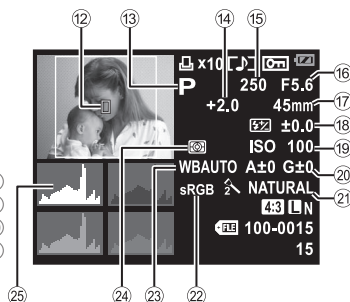













 "Information display" (P. 83)

Simplified display



Overall display



- | | |
|---|---|
| <ul style="list-style-type: none">① Aspect border  P. 40② Print reservation
Number of prints  P. 112③ Sound record  P. 90④ Protect  P. 91⑤ Battery check  P. 8⑥ Date and time  P. 15⑦ Aspect ratio  P. 40, 89⑧ Pixel count, compression rate  P. 64⑨ Record mode  P. 64⑩ File number⑪ Frame number⑫ AF target  P. 58⑬ Shooting mode  P. 4, 44 – 47 | <ul style="list-style-type: none">⑭ Exposure compensation  P. 50⑮ Shutter speed  P. 44 – 47⑯ Aperture value  P. 44 – 47⑰ Focal length  P. 132
(The focal length is displayed in 1 mm units.)⑱ Flash intensity control  P. 77⑲ ISO sensitivity  P. 53⑳ White balance compensation  P. 68㉑ Picture mode  P. 71㉒ Color space  P. 108㉓ White balance  P. 67㉔ Metering mode  P. 49㉕ Histogram  P. 83 |
|---|---|

Unpack the box contents

The following items are included with the camera.

If anything is missing or damaged, contact the dealer from whom you purchased the camera.



Camera



Body cap



Strap



PS-BLS1 (BLS-1)
Lithium ion battery

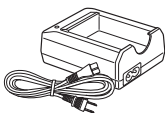

PS-BCS1 (BCS-1)
Lithium ion charger

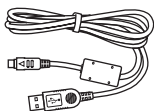

USB cable



AV cable
(Monaural)

- OLYMPUS Master 2 CD-ROM
- Instruction manual
- Warranty card

Attaching the strap

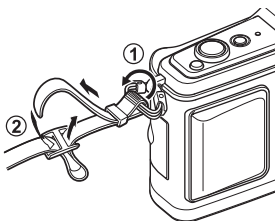

Thread the strap in the direction of the arrows (1, 2).

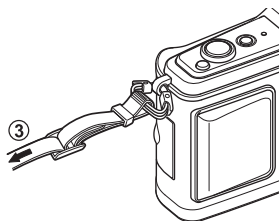

Lastly, pull the strap tight making sure that it is fastened securely (3).

- Attach the other end of the strap to the other eyelet in the same way.

Preparing the Camera

1 Charging the battery

Charging indicator
Amber light: Charging in progress
Blue light: Charging complete
(Charging time: Up to approximately 3 hours 30 minutes).
Amber blinking: Charging error

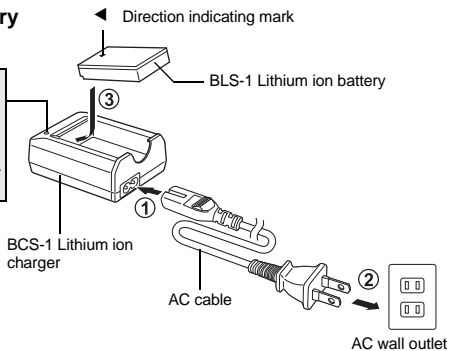

2 Loading the battery

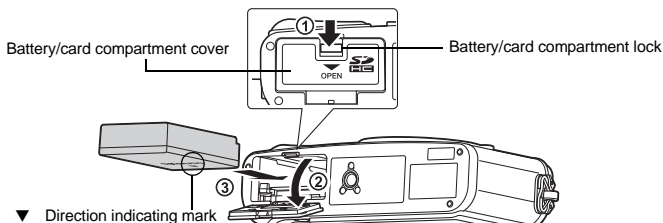

Unloading the battery

Turn off the camera before opening or closing the battery/card compartment cover.

To remove the battery, first push the battery lock knob in the direction of the arrow and then remove.

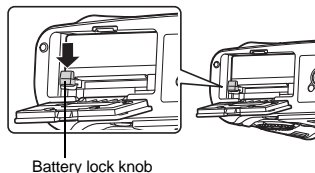

It is recommended to set aside a backup battery for prolonged shooting in case the battery in use drains.

3 Loading the card

- Insert the SD/SDHC card (referred to as “card” in these instructions) until it locks in place.  “Card basics” (P. 130)

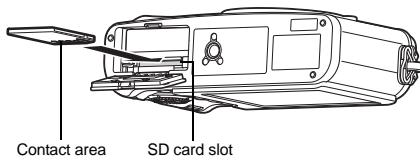

- Turn off the camera before loading or removing the card.

Removing the card

- Press the inserted card lightly and it will be ejected.
- Pull out the card.
- Never open the battery/card compartment cover while the card access lamp is blinking.

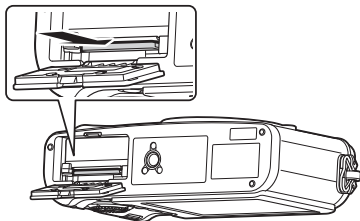

4 Closing the battery/card compartment cover

When using the camera, be sure to close the battery/card compartment cover.

- Close the cover until you hear a click.

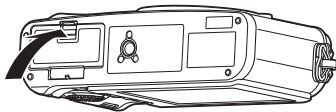

Attaching a lens to the camera

- 1** Remove the body cap from the camera and the rear cap from the lens

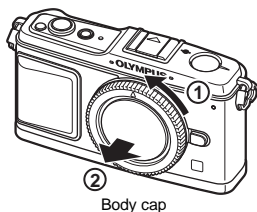
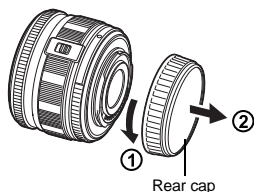

- 2** Attach a lens to the camera

- Align the lens attachment mark (red) on the camera with the alignment mark (red) on the lens, then insert the lens into the camera's body (1).
- Rotate the lens in the direction indicated by the arrow until you hear it click (2).

- Make sure the camera is turned off.
- Do not press the lens release button.
- Do not touch internal portions of the camera.

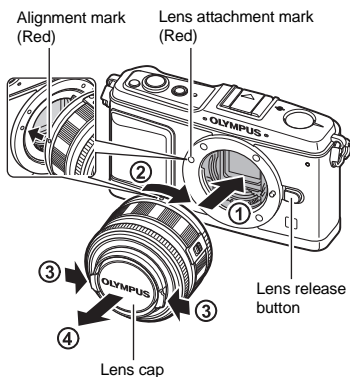

- 3** Remove the lens cap
(3, 4)

Removing the lens from the camera

While pressing the lens release button (1), rotate the lens in the direction of the arrow (2).

 "Interchangeable lenses" (P. 132)

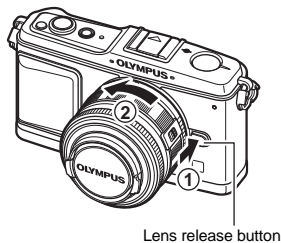

Power on

1 Press the ON/OFF button to turn on the camera

- To turn off the power, press the ON/OFF button again.

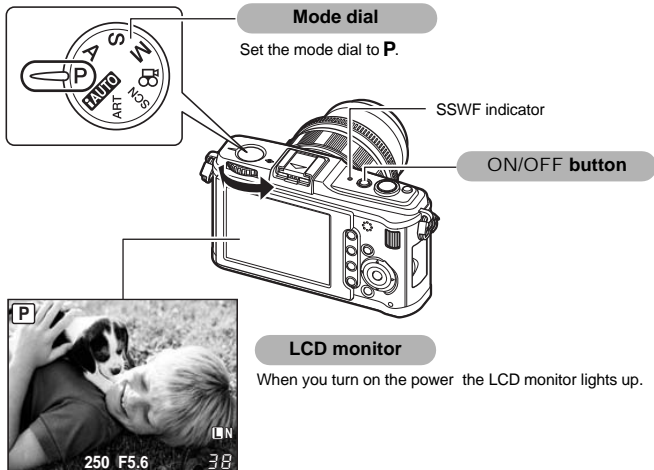

Dust reduction function operation

The dust reduction function is automatically activated when the camera is turned on. Ultrasonic vibrations are used to remove dust and dirt from the image pickup device's filter surface. The SSWF (Super Sonic Wave Filter) indicator blinks while dust reduction is working.

Using separately sold retractable lens

Certain types of lens are retractable and contained within the barrel when stored. You cannot take a picture with the lens retracted. Turn the zoom ring in the direction of arrow (1) to extend the lens (2).

To store, turn the zoom ring in the direction of arrow (4) while sliding the **UNLOCK** switch (3).

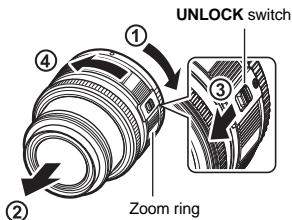

Setting the date/time

Date and time information is recorded on the card together with the images. The file name is also included with the date and time information. Be sure to set the correct date and time before using the camera.

1 Press the MENU button

- The menu screen is displayed on the LCD monitor.

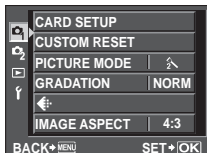

2 Use to select [f], then press

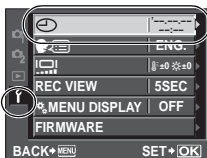

3 Use to select , then press

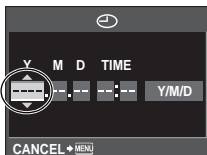

4 Use to select [Y], then press

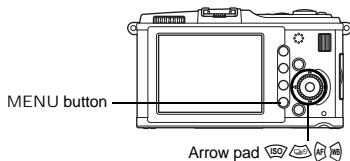
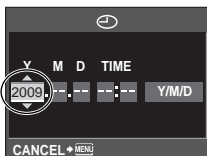

5 Repeat this procedure until the date and time are completely set

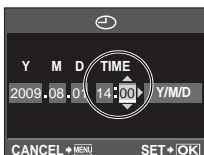

- The time is displayed in the 24-hour format.

6 Use to select the date format

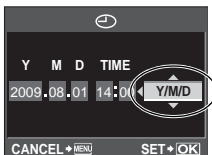

7 Press the button

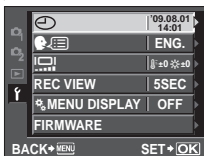

8 Press the MENU button to exit

Shooting

- 1 Select a composition while viewing the LCD monitor

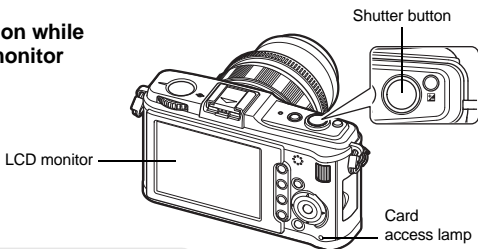

- 2 Adjust the focus

Press the shutter button halfway.

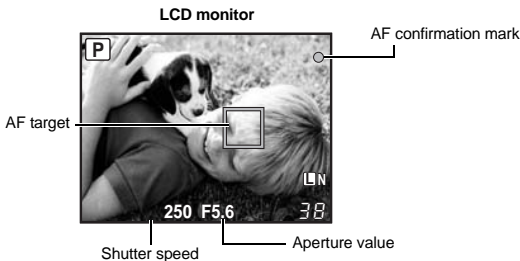

- The focus is locked, the AF confirmation mark appears, and the AF target appears at the focus position.
- The shutter speed and aperture value that have been set automatically by the camera are displayed.

- 3 Release the shutter

Press the shutter button all the way (fully).



- The shutter sounds and the picture is taken.
- The card access lamp blinks and the camera starts recording the picture.

Never remove the battery or card while the card access lamp is blinking. Doing so could destroy stored pictures and prevent storage of pictures you have just taken.

Holding the camera

Keep your fingers and the strap away from the lens.

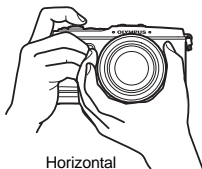

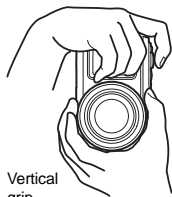

Horizontal grip



Vertical grip

When the camera stops operating

If no operations are performed for approximately one minute, the camera enters the sleep mode (stand-by) and stops operating. The camera activates again when you touch any button (the shutter button,  button, etc.).  "SLEEP" (P. 103)

Playback/Erasing

Playing back images

Pressing the  button displays the last picture taken.

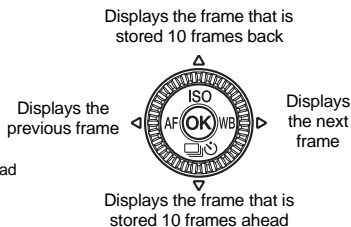
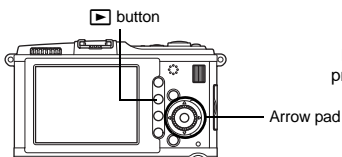



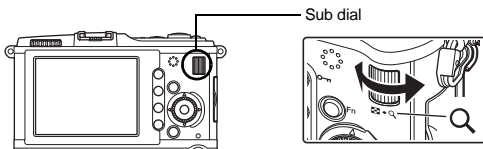

Close-up playback

Each time you turn the sub dial towards **Q**, the image is incrementally enlarged from 2x to 14x.



Erasing images

Playback the image you want to erase and press the  button. Use   to select **[YES]** and press the  button to erase.

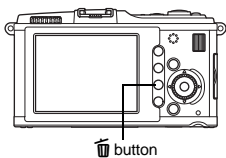

Basic operations

There are three ways to operate this camera.

Using the direct buttons to operate the camera P. 21

You can make the function settings with the main dial or sub dial and the direct buttons assigned to a function. Setting information is displayed on the LCD monitor while you are setting a function.

Setting while looking at the Live control or Super control panel P. 22, 23







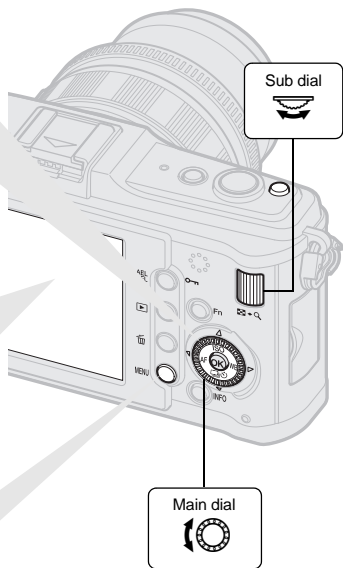

You can make the function settings with the Live control or Super control panel on the LCD monitor. You can use the Live control or Super control panel to view the current settings and directly change the settings.



Setting on the menu P. 24

You can use the menu to set shooting and playback settings and customize camera functions.



Indications used in this manual

- The operation button icons on the body of the camera are used to indicate the operation buttons in this manual. "Names of parts and functions" (P. 2) See.
- In this manual,  indicates turning the main dial.
- In this manual,  indicates turning the sub dial.
- In this manual,  indicates the arrow pad.
     indicate the up, down, left and right buttons of the arrow pad.
- The following symbols are used throughout this manual.

 Notes	Important information on factors which may lead to a malfunction or operational problems. Also warns of operations that should be absolutely avoided.
 TIPS	Useful information and hints that will help you get the most out of your camera.
	Reference pages describing details or related information.

Descriptions in this manual

The operating instructions of the direct buttons, live control, super control panel and menu are described as follows in this manual.

- "+" indicates operations performed at the same time.
- "▶" indicates you should proceed to the next step.

e.g.: When setting the White balance

Direct button

WB

Live control

 ▶ : [WB]

Super control panel

 ▶ INFO ▶ : [WB]

Menu

MENU ▶ [%] ▶ [WB] ▶ [WB]

Resetting the camera settings

In **P**, **A**, **S**, and **M** mode, current camera settings (including any changes you have made) are retained when the power is turned off. To reset the camera to the factory default settings, set [RESET].

 "Resetting the camera settings" (P. 96)

Using the direct buttons to operate the camera

1 Press the button for the function you want to set

- The direct menu is displayed.
- e.g.) Sequential shooting/
self-timer shooting

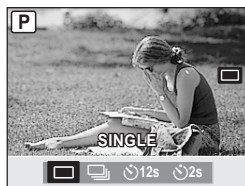

Direct menu

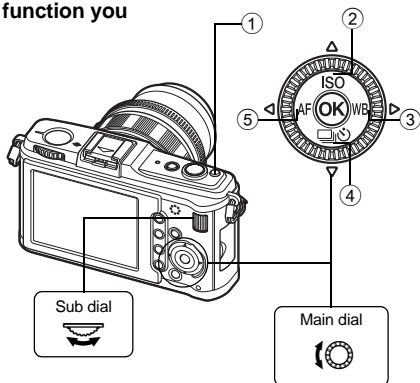

2 Turn the sub dial to change the setting, then press the **OK** button

- The function assigned to the button that was pressed remains selected for approximately 8 seconds. You can turn the sub dial and set the function during that time. If no operations are performed for 8 seconds, the setting for that function is confirmed. "BUTTON TIMER" (P. 101)

List of direct buttons

No.	Direct button	Function	Ref. page
①		Exposure compensation	P. 50
②	ISO	Sets ISO sensitivity	P. 53
③	WB	Sets white balance	P. 67
④		Sequential/Self-timer shooting	P. 61 – 62
⑤	AF	Sets AF mode	P. 56

Using the live control to operate the camera

1 Press the **OK** button to display the live control

- Press the **OK** button again to turn off the live control.

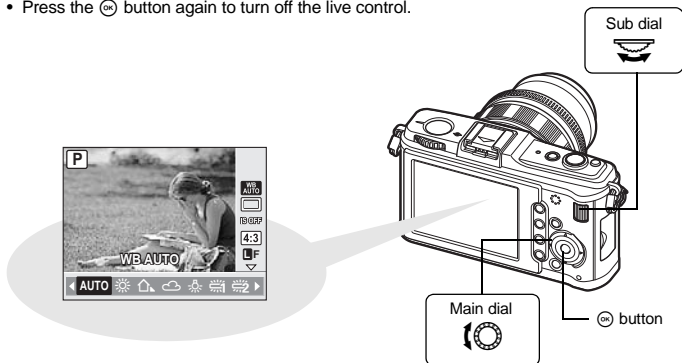

2 Move the cursor to the function you wish to set using the main dial and select settings using the sub dial, then press the **OK** button

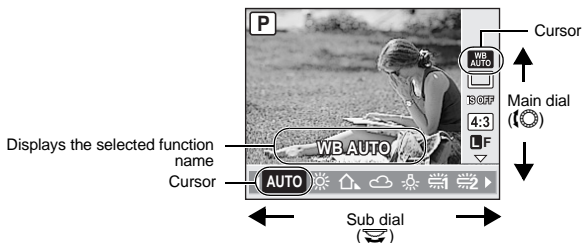

- If no operations are performed for 8 seconds, the setting for that function is confirmed.
- You can use the arrow pad instead of the dials.

For details on the functions that can be set with live control, refer to "Live control" (P. 6).

Setting while looking at the super control panel

1 Press the INFO button while live control is displayed to display the super control panel

- Press the INFO button again to return to the live control.

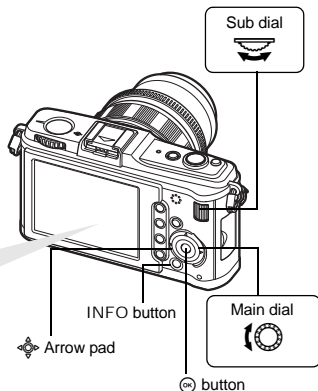
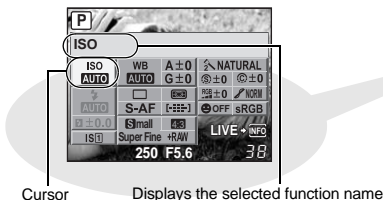

2 Use the Arrow pad to move the cursor to the function you wish to set, and change the settings using the main dial or sub dial

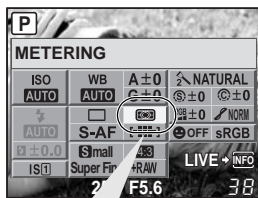

Direct menu



Press the INFO button to display the direct menu indicated at the position of the cursor. You can also use the direct menu to change the setting. After changing the setting, press the INFO button to confirm your setting. If no operation is performed within a few seconds, your setting is confirmed and the camera returns to the shooting mode.

For details on the functions that can be set with the super control panel, refer to "Super control panel" (P. 7).

Setting on the menu

1 Press the MENU button to display the menu

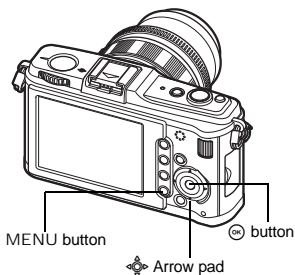
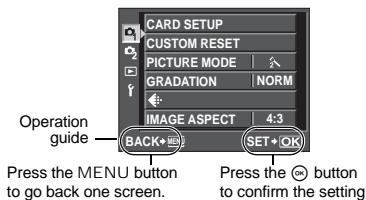

2 Use to select a tab, then press

- Shooting Menu 1
- Shooting Menu 2
- Playback Menu
- Setup Menu: Sets the basic functions of the camera.

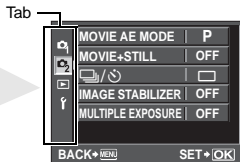

3 Use to select a function, and to go to the settings screen

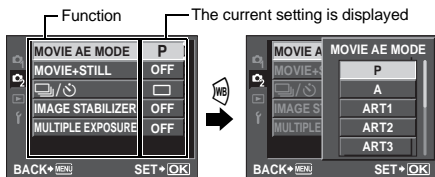

4 Press the button to confirm the setting

- Press the MENU button repeatedly to exit the menu.

For details on the functions that can be set with the menu, refer to "Menu directory" (P. 142).

Displaying the Custom Menu

You can use the Custom Menu to customize the camera settings and operations to suit your personal preferences. Customization is performed from the “Custom Menu” menu. The Custom Menu is added when [% MENU DISPLAY] in the Setup Menu is set to [ON].

For details of the Custom Menu, refer to “Customizing your camera” (👉 P. 97)

1 Press the MENU button to display the menu

2 Use   to select the [f] tab, then press 

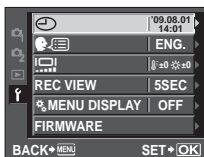

3 Use   to select [% MENU DISPLAY], then press 

4 Use   to select [ON], then press the  button

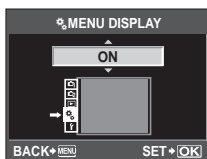

The [%] tab is displayed.

 Custom Menu:
Customizes shooting functions.

The settings on the Custom Menu are for customizing the camera to suit your personal preferences or needs. They are not suited to frequent changing.

The initial menu is more than adequate for setting both simple and advanced shooting functions. Normally, there is no need to display the Custom Menu.

Basic guide

2

Identifies the camera part names and describes the basic steps for shooting and playback.

Names of parts and functions	2
Camera	2
Mode dial.....	4
Live control.....	6
Super control panel	7
LCD monitor (Live view)	8
LCD monitor (Playback)	9
Preparations for shooting.....	10
Unpack the box contents.....	10
Preparing the Camera	11
Attaching a lens to the camera.....	13
Power on	14
Setting the date/time	15
Shooting	16
Playback/Erasing	18
Basic operations	19
Basic operations.....	19
Using the direct buttons to operate the camera	21
Using the live control to operate the camera.....	22
Setting while looking at the super control panel.....	23
Setting on the menu	24

1 Using live view

37

Describes features and operations available during live view.

Functions available during live view	37
The live view mechanism	37
Taking a picture using live view.....	38
Using the face detection function.....	39
Taking a picture using manual focus.....	40
Setting the image aspect	40
Switching the information display.....	41
Taking a picture while comparing the effect	42
Enlarged display operation	42
Panorama shooting.....	43

2 Exposure

44

Describes functions related to exposure, which is important for shooting. These functions are for determining the aperture value, shutter speed, and other settings by measuring the brightness in the picture.

Program shooting.....	44
Aperture priority shooting.....	45
Shutter priority shooting.....	46
Manual shooting.....	47
Bulb shooting.....	48
Preview function.....	48
Changing the metering mode.....	49
Exposure compensation.....	50
AE lock.....	51
AE bracketing.....	52
ISO sensitivity setting.....	53
ISO bracketing.....	54
Multiple exposure.....	54

3 Focusing and shooting functions

56

Describes the optimal focusing methods according to the subject and shooting conditions.

AF mode selection.....	56
S-AF (single AF).....	56
C-AF (continuous AF).....	57
MF (manual focus).....	57
Simultaneous use of S-AF mode and MF mode (S-AF+MF).....	57
AF target selection.....	58
Registering an AF target mode.....	59
Focus lock – If correct focus cannot be obtained.....	60
Sequential shooting.....	61
Self-timer shooting.....	62
Image stabilizer.....	62

4 Record mode, white balance, and picture mode

64

Describes image adjustment functions specific to digital cameras.

Selecting the record mode.....	64
Recording formats.....	64
Selecting the record mode.....	65
Selecting the white balance.....	67
Setting the auto/preset/custom white balance.....	68
WB compensation.....	68
Setting the one-touch white balance.....	69
WB bracketing.....	70
Picture mode.....	71
Gradation.....	72

5 Flash shooting

73

Describes taking pictures with external flash.

External flash shooting.....	73
Using commercially available flashes	74
Flash mode setting.....	75
Flash intensity control	77
Flash bracketing.....	77

6 Recording Movies

78

Describes movie recording method and functions.

Movie recording	78
Changing the settings for movie recording	79
Adding effects to a movie	79
Selecting the record mode	80
Recording Audio when Recording Movie	80
Taking still picture automatically when movie recording ends.....	80

7 Playback functions

81





Describes the functions for image playback.

Single-frame/Close-up playback.....	81
Index display/Calendar display	82
Information display.....	83
Slideshow.....	84
Rotating images	85
Movie playback	86
Playback on TV.....	87
Editing still images	89
Image overlay	90
Protecting images	91
Erasing images	92

8 Setup functions

94















Describes the basic settings for using the camera.



















Setup Menu.....	94
 (Date/time setting).....	94
 (Changing the display language).....	94
 (Monitor brightness adjustment).....	94
REC VIEW.....	95
 MENU DISPLAY.....	95
FIRMWARE.....	95
Resetting the camera settings.....	96

9 Customizing your camera

97

Describes how to customize the camera's settings.

 AF/MF.....	97
AF MODE.....	97
AF AREA.....	97
 SET UP.....	97
RESET LENS.....	98
BULB FOCUSING.....	98
FOCUS RING.....	98
MF ASSIST.....	98
 BUTTON/DIAL.....	98
DIAL FUNCTION.....	98
DIAL DIRECTION.....	99
AEL/AFL.....	99
AEL/AFL MEMO.....	100
 FUNCTION.....	100
 FUNCTION.....	101
MY MODE SETUP.....	101
BUTTON TIMER.....	101
	102
 FUNCTION.....	102
 RELEASE/ 	102
RLS PRIORITY S/RLS PRIORITY C.....	102
 DISP/  /PC.....	102
HDMI.....	102
VIDEO OUT.....	102
	103
SLEEP.....	103
USB MODE.....	103
LIVE VIEW BOOST.....	104
 FACE DETECT.....	104
INFO SETTING.....	104
VOLUME.....	104
 SETUP.....	104

	LEVEL GAUGE	104
	MOVIE 	105
	EXP  /ISO	105
	EV STEP	105
	METERING	105
	AEL Metering	105
	ISO	105
	ISO STEP	105
	ISO-AUTO SET	105
	ISO-AUTO	106
	BULB TIMER	106
	ANTI-SHOCK	106
	BRACKETING	106
	 CUSTOM	106
	FLASH MODE	106
		106
	 X-SYNC	106
	 SLOW LIMIT	106
	 + 	107
	 /COLOR/WB	107
	NOISE REDUCT.	107
	NOISE FILTER	107
	WB	107
	ALL 	108
	COLOR SPACE	108
	SHADING COMP.	108
	 SET	108
	PIXEL COUNT	109
	RECORD/ERASE	109
	QUICK ERASE	109
	RAW+JPEG ERASE	109
	FILE NAME	109
	EDIT FILENAME	110
	PRIORITY SET	110
	dpi SETTING	110
	 UTILITY	110
	PIXEL MAPPING	110
	EXPOSURE SHIFT	110
	 WARNING LEVEL	111
	LEVEL ADJUST	111

10 Printing

112

Describes how to print your pictures.

Print reservation (DPOF)	112
Print reservation	112
Single-frame reservation	113
All-frame reservation	114
Resetting the print reservation data	114
Direct printing (PictBridge)	115
Connecting the camera to a printer	115
Easy printing	116
Custom printing	116

11 Using the OLYMPUS Master software

119

Describes how to transfer and store your camera images to a computer.

Flowchart	119
Using the provided OLYMPUS Master software	119
What is OLYMPUS Master?	119
Connecting the camera to a computer	120
Start up the OLYMPUS Master software	121
Displaying camera images on a computer	121
Downloading and saving images	121
Disconnecting the camera from your computer	122
Viewing still images	123
Transferring images to your computer without using OLYMPUS Master	123

12 Shooting tips and maintenance

124

Refer to this section for troubleshooting and camera maintenance information.

Shooting tips and information	124
Error codes	126
Camera maintenance	128
Cleaning and storing the camera	128
Pixel mapping – Checking the image processing functions	129

Refer to this section for information on optional accessories, camera specifications, and other useful shooting information.

Card basics	130
Usable cards	130
Formatting the card	130
Battery and charger	131
Using your charger abroad	131
Interchangeable lenses.....	132
M.ZUIKO DIGITAL interchangeable lenses.....	132
M.ZUIKO DIGITAL lens specifications	133
Using optical viewfinder (sold separately).....	135
Program line diagram (P mode)	136
Flash synchronization and shutter speed	136
Exposure warning display	137
Flash modes that can be set by shooting mode	138
White balance color temperature	139
Record mode and file size/number of storable still pictures.....	140
Functions that can be registered with My Mode and Custom Reset Setting	141
Menu directory	142
Specifications	147
SAFETY PRECAUTIONS	150
Index	157







Quick reference

Shooting		
Taking pictures with automatic settings	Set the mode dial to IAUTO and start taking pictures.	P. 4
Correct focus cannot be obtained	Use focus lock.	P. 60
	Select the AF target and take the picture.	P. 58
	The minimum shooting distance varies depending on the lens. Move to the minimum shooting distance of the lens from the subject and take a picture.	P. 132
	The camera may be having difficulty focusing on the subject with auto focus. Lock the focus at the position of the subject in advance or use MF to fix the distance of the focus.	P. 57, P. 60, P. 125
Focusing on one area	Select the AF target and take the picture using the desired AF target.	P. 58
	Use MF. It may be helpful to focus while using live view with an enlarged image.	P. 40, P. 42, P. 57
Checking set effect before taking a picture	You can take a picture while using the live multi view display to compare the effect of white balance or exposure compensation.	P. 42
	You can use the preview function to check the depth of field at a selected aperture value.	P. 48
	You can use [TEST PICTURE] to check the image on the LCD monitor without recording the image to a card.	P. 100
Extending the useful life of the battery	Pressing the shutter button halfway and playing back images over a long period of time consumes considerable battery power. Limiting these actions will help extend the useful life of the battery.	—
	Set [SLEEP] so that the camera enters sleep mode faster.	P. 103
Increasing the number of pictures that can be taken	Reduce the pixel count and compression rate settings.	P. 64, P. 108
Taking pictures in low light situations without using the flash	Increase the ISO sensitivity.	P. 53

Taking pictures without white subjects appearing too white or black subjects appearing too dark	Take a picture while checking the histogram.	P. 41
	Take a picture while checking the shutter speed and aperture value displays. If either is blinking, the optimal exposure is not obtained.	P. 44 – 46, P. 137
	Set the gradation setting to [AUTO] . Subjects with areas of large contrast are adjusted automatically.	P. 72
	Adjust the exposure compensation.	P. 50
Taking monotone pictures	Set [PICTURE MODE] to [MONOTONE] . You can take monotone pictures in black and white, sepia tones, purplish tones, bluish tones, and greenish tones.	P. 71
	Recorded images can be edited into black-and-white or sepia-toned images.	P. 89
	Set the art filter to [GRAINY FILM] .	P. 5
Taking pictures of a subject against backlight	Set the gradation setting to [AUTO] .	P. 72
	Use spot metering to measure the exposure of the subject in the center of the picture. If the subject is not in the center of the picture, use AE lock to lock the exposure, and then change the composition and take the picture.	P. 49, P. 51
Brightening a dark backlit image	You can adjust the image using [SHADOW ADJ] of [JPEG EDIT] .	P. 89
Taking pictures with a blurred background	Use A (aperture priority) mode to decrease the aperture value as much as possible. You can blur the background more by shooting up close to the subject.	P. 45
Taking pictures that stop the subject in motion or convey a sense of motion	Use the S (shutter priority) mode to take the picture.	P. 46
Taking pictures with the correct color	Set the white balance according to the light source. You can also make fine changes to the settings.	P. 67
	With WB bracket shooting, you can capture 3 to 9 images with different white balance settings for each picture taken. This enables you to take pictures with the desired white balance without having to make fine changes to the settings.	P. 70
Taking pictures so that whites come out white and blacks come out black	Set the spot metering for highlight or shadow control. If the subject is not in the center of the picture, use AE lock to lock the exposure, and then change the composition and take the picture.	P. 49, P. 51
	Adjust the exposure compensation. It may be helpful to use AE bracketing if you are not sure about the exposure compensation value.	P. 50, P. 52
	Set the scene mode to [HIGH KEY] or [LOW KEY] and take a picture.	P. 5

Taking pictures without noise	Set [NOISE REDUCT.] to [AUTO] or [ON] .	P. 107
	To take pictures in a dark location, set [NOISE FILTER] to [HIGH] .	P. 107
Optimizing the LCD monitor	You can adjust the brightness of the LCD monitor.	P. 94
	During live view, set [LIVE VIEW BOOST] to [ON] to make the subject easier to see without the exposure reflecting on the LCD monitor.	P. 104
Reducing camera shake	Set the image stabilizer function.	P. 62
	Hold the camera firmly when pressing the shutter button. When using a slow shutter speed, be sure to stabilize the camera by using a tripod or similar method.	P. 17
	Use the external flashes.	P. 75
	Set the scene mode to [DIS MODE] .	P. 5
	Increase the ISO sensitivity. When using the [AUTO] setting, set the upper limit of [AUTO] to a higher value.	P. 53, P. 105
	Using the self-timer can reduce camera shake that occurs when the shutter button is pressed.	P. 62
Taking pictures while checking the level of the camera	You can display the level gauge to check whether the camera is level.	P. 104
	Display the ruled lines in live view. Compose the shot so that the subject and ruled lines are horizontally and vertically aligned.	P. 41

Playback			
Displaying the image after the picture is taken	Set [REC VIEW] . You can set the number of seconds that the image is displayed.	P. 95	
Displaying the image after the picture is taken and deleting unneeded images	Set [REC VIEW] to [AUTO Quickly searching for the desired image	Use index display to search from a index of between 4 and 100 frames.	P. 82
Use calendar display to search by the date the picture was taken.	P. 82		
Viewing images on a TV	Use the AV cable or HDMI mini-cable (commercially available) to play back recorded images on your TV. You can also view the images as a slideshow.	P. 87	





Settings		
Saving the settings	You can register two camera settings in [CUSTOM RESET] . Even if the settings are changed, they can be returned to their registered settings by resetting the settings.	P. 96
	You can register up to two current camera settings in [MY MODE SETUP] . Assign My Mode to the Fn button so that you can easily use that function during shooting.	P. 101
Changing the menu display language	You can change the display language.	P. 94
Not all the functions are reset to the factory default settings by [RESET]	The following functions are not returned to the factory default settings by [RESET] . Use the menu to change the respective settings. You can check the default settings in the "Menu directory" ( P. 142). RESET1, RESET2 (Custom reset)/PICTURE MODE/  /  /  /  / DIAL FUNCTION/DIAL DIRECTION/ MY MODE SETUP/VIDEO OUT/ISO-AUTO/[WB?]/EDIT FILENAME/dpi SETTING/EXPOSURE SHIFT/ WARNING LEVEL	P. 96, P. 141

The view of the subject you are taking a picture of on the LCD monitor is called live view. You can view the exposure or white balance effect and the subject's composition while you take a picture.



Functions available during live view

The following functions can be used during live view.



Focusing during live view

- Taking a picture using focus lock  P. 60
- Taking a picture while adjusting the focus manually  P. 40
- Taking a picture while focusing on a face  P. 39
- Taking a picture while checking the focus by enlarging the zone to be focused  P. 42

Taking a picture while checking the effect

- Taking a picture after comparing the effect of exposure compensation or white balance  P. 42
- Taking a panoramic picture  P. 43

Switching the indications on the LCD monitor

- Turning off the information display/Displaying the histogram or ruled lines  P. 41
- Checking the subject on the monitor even in low light situations  P. 104

Notes

- If there is a high-intensity light source within the screen, the image may be displayed darker but will be recorded normally.
- If the live view function is used over a long period, the temperature of the image pickup device rises causing images with high ISO sensitivity to appear noisy and unevenly colored. Either lower the ISO sensitivity or turn off the camera for some time.

The live view mechanism

During live view, the image on the LCD monitor is the same image received by the image pickup device (Live MOS sensor/imager) that is used for shooting. This way you can check the effects of exposure compensation or white balance on the LCD monitor. Moreover, you can also enlarge part of the subject to focus on it or display ruled lines to check that the composition is level.

Taking a picture using live view

Press the shutter button down halfway to perform autofocus using the imager device.

1 Press the shutter button halfway.

- When the focus is locked, the AF confirmation mark (● or ○) and AF target mark light up.
 - : For a high-speed Imager AF-compatible lens which is a Micro Four Thirds system lens or Four Thirds system lens*
 - : Other Four Thirds system lens
 - Check the focus on the LCD monitor.
 - You can enlarge the view and finely adjust the focus.
 - ☞ “Enlarged display operation” (P. 42)

2 Press the shutter button all the way to take a picture.

- You can record sound with the picture you have taken.
 - ☞ “Adding sound to still pictures” (P. 90)

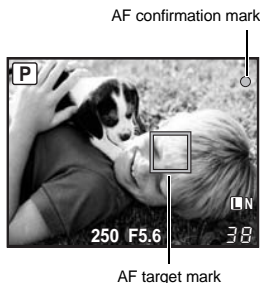

TIPS

To adjust the focus by using manual focus:

- In [**S-AF+MF**] mode or [**MF**] mode, turn the focus ring to enlarge the subject and achieve focus.
 - ☞ “MF ASSIST” (P. 98)

* For the latest information about Olympus Four Thirds lenses compatible with Hi-Speed Imager AF, visit the Olympus website.

Using the face detection function

By setting [☺ FACE DETECT] to [ON], the camera will detect people's faces in the frame and adjust the focus and metering automatically.

Direct button

Fn (The setting changes each time the button is pressed.)

Live control

☺ ▶ [☺]: [☺ FACE DETECT]

Super control panel

☺ ▶ INFO ▶ [☺] ▶ [☺ FACE DETECT]

Menu

MENU ▶ [%] ▶ [☺] ▶ [☺ FACE DETECT]

- In order to use the **Fn** button, [**Fn FACE DETECT**] needs to be set up in the menu in advance. I [☺] "**Fn** FUNCTION" (P. 100)
- After setting [☺ FACE DETECT] to [ON] while using the **Fn** button, the following functions are automatically set to the best settings for taking pictures of people.

Function	Setting	Ref. page
METERING		P. 49
GRADATION	AUTO	P. 72
AF MODE	S-AF	P. 56
AF AREA	[☺]	P. 58

1 If the camera detects a face, a frame will be displayed in that location.

- When you press the shutter button, the camera will focus on the position of the face detection frame (When [☺] is selected in [AF AREA] the camera will focus on that position).

! Notes

- During sequential shooting, face detection will work only at the first shot.
- Depending on the subject, the camera may not be able to correctly detect the face.



Taking a picture using manual focus

You can take a picture focusing manually while checking the focus on the LCD monitor.

- 1 Set the AF mode to [S-AF+MF] or [MF].  “AF mode selection” (P. 56)
- 2 Adjust the focus by rotating the focus ring.
 - In [S-AF+MF] mode, after pressing the shutter button halfway or pressing the AEL/AFL button, you can rotate the focus ring to finely adjust the focus before taking the picture.
 - You can turn off zoom display.  “Enlarged display operation” (P. 42)
 - You can also disallow enlarged view.  “MF ASSIST” (P. 98)

1

Using live view

Setting the image aspect

You can change the aspect ratio (horizontal-to-vertical ratio) when taking pictures using live view. Depending on your preference, you can set the aspect ratio to [4:3] (standard), [16:9], [3:2], or [6:6]. JPEG images are trimmed and saved according to the aspect ratio.

Menu

MENU ▶  ▶ [IMAGE ASPECT]

! Notes

- RAW images are not trimmed and are recorded with the aspect ratio information at the time of shooting.
- During RAW image playback, images are displayed with a border based on the aspect ratio.

TIPS

To change the aspect ratio of recorded images:

→ You can only change the aspect ratio when the aspect ratio of the image is set to [4:3].

 “Editing still images” (P. 89)

To trim recorded images:

→ You can only trim images when the aspect ratio of the image is set to [4:3].

 “Editing still images” (P. 89)

Switching the information display

You can switch the information displayed on the monitor by pressing INFO button repeatedly. You can also switch the information displayed by turning the main dial while pressing the INFO button.

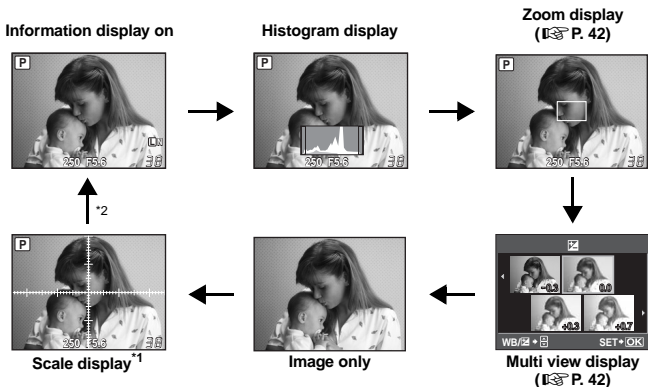

*1 With [INFO SETTING] (P. 104), you can also select [] or [] for the ruled line display.

*2 During multiple exposure shooting (P. 54), the information display then switches to "Multiple exposure display".

When [LEVEL GAUGE] (P. 104) is set to [ON], the information display switches to "Digital level gauge display".

TIPS

To quickly switch to the frequently used display:

→ You can hide the information display for all modes except "Information display on". Press "INFO SETTING" (P. 104)

How to read the histogram:

→ The following shows you how to read the histogram display easily.

- 1 If the graph has many peaks around here, the image will appear mostly black.
- 2 If the graph has many peaks around here, the image will appear mostly white.
- 3 The part indicated in green in the histogram shows the luminance distribution within the spot metering area.

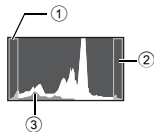

Taking a picture while comparing the effect

You can check the effect of exposure compensation or white balance on a 4-split screen.

1 Press the INFO button repeatedly to display the multi view display.

☞ “Switching the information display” (P. 41)

- The exposure compensation comparison screen is displayed. Press to switch to the white balance comparison screen. Press to switch the screen.



2 Use or the dial to select the setting value, then press the button.

- You can take the picture using the set value.

! Notes

- Exposure compensation is not available in **M** mode.
- This function cannot be used in **FAUTO**, ART or SCN modes.

Enlarged display operation

It is possible to enlarge the subject for display. Enlarging the image during MF makes focus confirmation and adjustment easier.

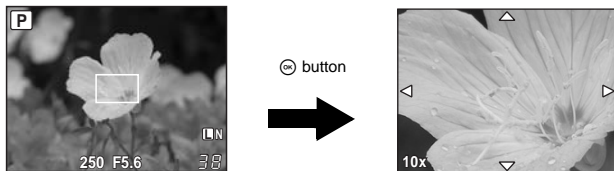

1 Press the INFO button repeatedly to display the zoom display.

☞ “Switching the information display” (P. 41)

- The enlargement frame will be displayed.

2 Use to move the frame and press the button.

- The area inside the frame is enlarged and displayed.
- Press and hold the to return the enlargement frame to the center after it was moved.

3 Turn the sub dial to change the magnification (7x/10x).

- Use to scroll the frame even during magnification.
- Pressing the will cancel the zoom display.

Panorama shooting

You can enjoy panorama shooting easily. Using OLYMPUS Master (provided CD-ROM) to join images where the subject's edges overlap, you can create a single panorama composite image.

Panorama shooting is possible up to a maximum of 10 images.

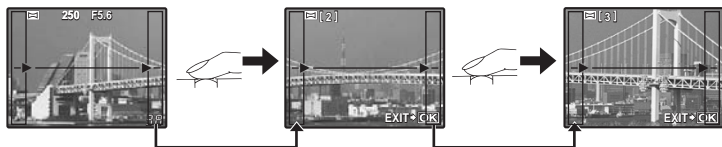

- Try your best to include common parts of the overlapping images when shooting the subject.

1 Set the mode. “Setting the art filter/scene” (P. 5)

2 Use to specify the direction for joining, then shoot the subject with the edges overlapping.

: Joins the next image to the right.

: Joins the next image to the left.

: Joins the next image to the top.

: Joins the next image to the bottom.

- Shoot while changing the composition such that the subject overlaps.

- The focus, exposure, etc. will be determined at the first shot.

- The [2] (warning) mark will be displayed after you have finished taking 10 shots.

- Pressing the button before shooting the first frame returns to the scene mode selection menu.

- Pressing the button in the midst of shooting ends the sequence of panorama shooting, and allows you to continue with the next one.

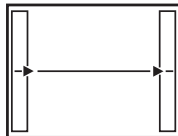

Notes

- During panorama shooting, the image previously taken for position alignment will not be retained. With the frames or other markers for display in the images as a guide, set the composition such that the edges of the overlapping images overlap within the frames.

Program shooting

P

The camera sets the optimum aperture value and shutter speed automatically according to the subject brightness.

Set the mode dial to P.

- When the shutter button is half-pressed, the shutter speed and aperture value are displayed on the LCD monitor.

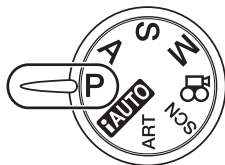

2

Exposure

Shooting mode

LCD monitor



AF confirmation mark

Shutter speed

Aperture value

Program shift (Ps)

By turning the main dial (or sub dial) in the **P** mode, you can change the combination of aperture and shutter speed while maintaining the optimum exposure.

- “Program line diagram (P mode)” (P. 136)
- The program shift setting will not be cancelled after shooting. To cancel the settings, turn the main dial (or sub dial) until the shooting mode indication **Ps** of the LCD monitor changes to **P**. Alternatively, turn off the power.
- Program shift is not available when you are using a flash.

TIPS

The shutter speed and aperture value are blinking:

→ The optimum exposure cannot be obtained. For details, see “Exposure warning display” (P. 137).

Program shift



Aperture priority shooting

A

The camera sets the optimum shutter speed automatically for the aperture value you have selected. When you open the aperture (decrease the aperture value), the camera will focus within a shorter range (shallow depth of field) and produce a picture with a blurred background. When you close the aperture (increase the aperture value), the camera will focus within a longer range. Use this mode when you wish to add changes to the background representation.

When the aperture value (f-number) is decreased



When the aperture value (f-number) is increased



Set the mode dial to **A** and turn the main dial (or sub dial) to set the aperture value.

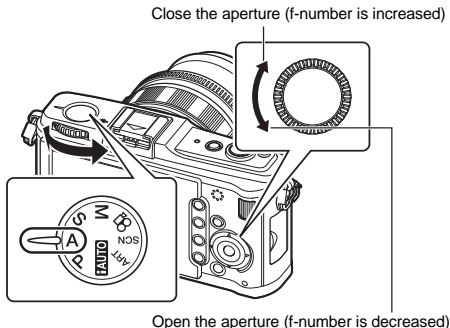

Aperture value

**2**

Exposure

TIPS

To check the depth of field with the selected aperture value:

→ See "Preview function" (P. 48).

To change the exposure adjustment interval:

→ This can be set in 1/3 EV, 1/2 EV or 1 EV increments. P. 105

Shutter speed is blinking:

→ The optimum exposure cannot be obtained. For details, see "Exposure warning display" (P. 137).

Shutter priority shooting

S

The camera sets the optimum aperture value automatically for the shutter speed you have selected. Set the shutter speed depending on the type of effect you want. A higher shutter speed allows you to capture a fast-moving subject without blur, and a slower shutter speed blurs a moving subject, creating a feeling of speed or motion. Set the shutter speed depending on the type of effect you want.

A fast shutter speed can freeze a fast action scene without any blur.



A slow shutter speed will blur a fast action scene. This blurring will give the impression of dynamic motion.

2**Exposure**

Set the mode dial to **S** and turn the main dial (or sub dial) to set the shutter speed.



Shutter speed

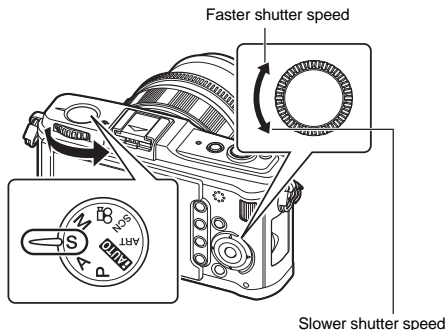

TIPS

The picture looks blurred:

- The possibility of camera shake spoiling your picture increases greatly during macro or ultra-telephoto shooting. Raise the shutter speed or use a monopod or tripod to stabilize the camera.
- When the shutter speed is slow, camera shake is more likely to occur. You can reduce camera shake by using the image stabilizer. "Image stabilizer" (P. 62)

To change the exposure adjustment interval:

- This can be set in 1/3 EV, 1/2 EV or 1 EV increments. "EV STEP" (P. 105)

The aperture value is blinking:

- The optimum exposure cannot be obtained. For details, see "Exposure warning display" (P. 137).

Allows you to set the aperture and shutter speed manually. You can check how much it differs from the appropriate exposure by using the exposure level indicator. This mode gives you more creative control, allowing you to make whatever settings you like, regardless of the correct exposure.

Set the mode dial to M and turn the dial to set the value.

Aperture value: Turn the sub dial to set the value.

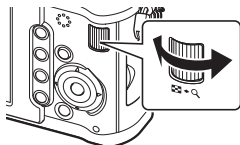

Shutter speed: Turn the main dial to set the value.

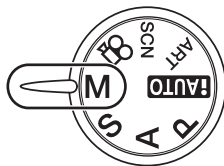
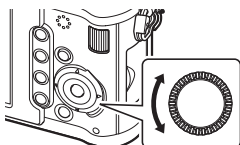

- The range of aperture values available varies with the lens type.
- The shutter speed can be set to 1/4000 – 60 sec. or [BULB].

Noise in images

While shooting at slow shutter speeds, noise may appear on-screen. These phenomena are caused when current is generated in those sections of the image pickup device that are not normally exposed to light, resulting in a rise in temperature in the image pickup device or image pickup device drive circuit. This can also occur when shooting with a high ISO setting in a high-temperature environment. To reduce this noise, the camera activates the noise reduction function.

☞ "NOISE REDUCT." (P. 107)

TIPS

The picture looks blurred:

- The use of a monopod or tripod is recommended when taking a picture at slow shutter speed.
- When the shutter speed is slow, camera shake is more likely to occur. You can reduce camera shake by using the image stabilizer. ☞ "Image stabilizer" (P. 62)

To change the exposure adjustment interval:

- This can be set in 1/3 EV, 1/2 EV or 1 EV increments. ☞ "EV STEP" (P. 105)

To switch the operations of the main dial and sub dial:

- You can switch the functions that are set with the main dial and sub dial.

☞ "DIAL FUNCTION" (P. 98)

! Notes

- Exposure compensation is not available in M mode.

Bulb shooting

You can take a picture with a bulb exposure time in which the shutter stays open as long as you hold down the shutter button.

In **M** mode, set the shutter speed to [BULB].

- [BULB] is displayed on the LCD monitor.

TIPS

To automatically end bulb shooting after a specified period of time:

→ You can set the maximum time for bulb shooting. "BULB TIMER" (P. 106)

To fix the focus during manual focus shooting:

→ You can fix the focus so the focus does not change even if the focus ring is turned during exposure.

"BULB FOCUSING" (P. 98)

! Notes

- The following functions are not available during bulb shooting.
Sequential shooting/self-timer shooting/AE bracket shooting/image stabilizer/flash bracketing

Preview function

You can check the focused area (depth of field) with the selected aperture value on the LCD monitor.

For the preview function to work by pressing the **Fn** button, it is necessary to set the function of the **Fn** button on the menu beforehand. "[Fn] FUNCTION" (P. 100)

Press the **Fn** button to use the preview function.

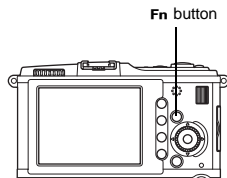

Changing the metering mode

There are 5 ways to measure the subject brightness: Digital ESP metering, Center weighted averaging metering, and 3 types of spot metering. Select the most suitable mode for the shooting conditions.

Live control

 **[METERING]**

Super control panel

 **INFO** **[METERING]**

Menu

MENU **[%]** **[METERING]**

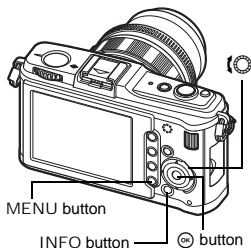

2

Exposure

Digital ESP metering

The camera measures the light levels and calculates the light level differences in 324 separate areas of the image. This mode is recommended for general use.



Center weighted averaging metering

This metering mode provides the average metering between the subject and the background lighting, placing more weight on the subject at the center. Use this mode when you do not want the light level of the background to affect the exposure value.



Spot metering

The camera meters a very small area around the center of the subject, defined by the spot metering area mark on the LCD monitor. Use this mode when there is very strong backlight.

HI Spot metering – highlight control

When the overall background is bright, white areas of the image will come out gray if you use the camera's automatic exposure. Using this mode enables the camera to shift to over-exposure, allowing accurate white reproduction.

Metering area is the same as spot metering.

SH Spot metering – shadow control

When the overall background is dark, black areas of the image will come out gray if you use the camera's automatic exposure. Using this mode enables the camera to shift to under-exposure, allowing accurate black reproduction. Metering area is the same as spot metering.

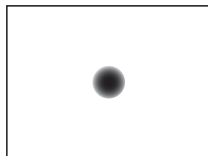

 : Metering area

Exposure compensation



In some situations, you may get better results if you manually compensate (adjust) the exposure value set automatically by the camera. In many cases, bright subjects (such as snow) will turn out darker than their natural colors. Adjusting toward + makes these subjects closer to their real shades. For the same reason, adjust toward – when shooting dark subjects. You can use value in the range ± 3.0 EV to suit the other exposure compensation function.

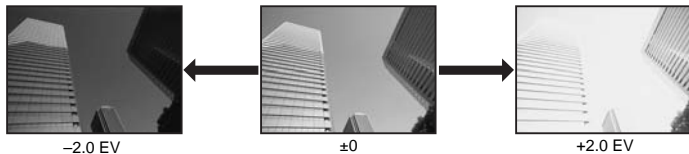

2

Exposure

Direct button



TIPS

To change the exposure adjustment interval:

→ This can be set in 1/3 EV, 1/2 EV or 1 EV increments.

☞ "EV STEP" (P. 105)

To adjust the exposure using only the dial:

→ You can set the exposure compensation value without pressing  button.

☞ "DIAL FUNCTION" (P. 98)



Notes

- Exposure compensation is not available in **M** and **SCN** modes.

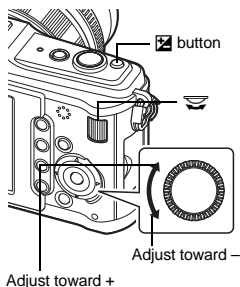

The metered exposure value can be locked with the AEL/AFL button (AE lock). Use AE lock when you want a different exposure setting from the one that would normally apply under the current shooting conditions.

Normally, pressing the shutter button halfway locks both AF (auto focus) and AE (automatic exposure), but you can lock the exposure alone by pressing the AEL/AFL button.

Press the AEL/AFL button at the position where you wish to lock the metering values and the exposure will be locked. The exposure is locked while the AEL/AFL button is pressed. Now press the shutter button.

- Releasing the AEL/AFL button cancels AE lock.

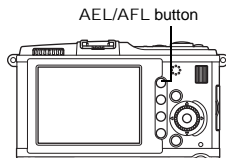

2

Exposure

TIPS

To lock the exposure:

- You can lock the metering result so that it is not cancelled when the AEL/AFL button is released.

☞ "AEL/AFL MEMO" (P. 100)

To activate AE lock with a set metering mode:

- You can set the metering mode for locking the exposure with the AE lock.

☞ "AEL Metering" (P. 105)



AE lock

AE bracketing

The camera automatically shoots a number of pictures at different exposure values for each frame. Even in conditions where correct exposure is difficult to obtain (such as a backlit subject or a scene at dusk), you can pick the picture you prefer from a selected number of frames with a variety of different exposure settings (exposure and compensation values). The pictures are taken in the following order: Picture with optimum exposure, picture adjusted in – direction, and picture adjusted in + direction.

e.g.) When BKT is set to **[3F 1.0EV]**



-1.0 EV



±0



+1.0 EV

Compensation value: 0.3, 0.7 or 1.0

- The compensation value will change if the EV step is changed. “EV STEP” (P. 105)

Number of frames: 3

Menu

MENU ▶ [%] ▶ [] ▶ [BRACKETING] ▶ [AE BKT]

Start shooting.

- In single-frame shooting, the exposure changes every time the shutter button is pressed.
- In sequential shooting, hold down the shutter button until the selected number of frames are taken.
- Releasing the shutter button stops flash bracketing shooting. When it stops, **[BKT]** is displayed in green on the LCD monitor.

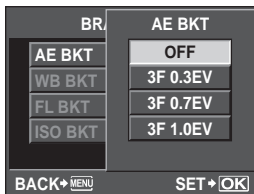

How AE bracketing compensates exposure in each shooting mode

Depending on the selected shooting mode, exposure is compensated in the following way:

P mode : Aperture value and shutter speed

A mode : Shutter speed

S mode : Aperture value

M mode : Shutter speed

TIPS

To apply AE bracketing to the exposure value you have compensated:

- Compensate the exposure value, then use the AE bracketing feature. AE bracketing is applied to the exposure value you have compensated.

The larger the ISO value, the darker the location in which you can shoot. However, increasing the ISO value leads to increased noise (graininess) in the picture. ISO200, which gives optimal noise and gradation balance, is recommended for normal use.

For a slower shutter speed or when you want to open the aperture, use ISO100.

Direct button

ISO

Live control

☉ ▶ [ISO]

Super control panel

☉ ▶ INFO ▶ [ISO]

Menu

MENU ▶ [%] ▶ [ISO] ▶ [ISO]

[AUTO] : The sensitivity is set automatically according to the shooting conditions. For **[ISO-AUTO SET]**, you can set the default (value normally used when the optimal exposure can be obtained) and upper limit (upper limit of ISO that automatically changes).  "ISO-AUTO SET" (P. 105)

[100 – 6400] : Fixed ISO sensitivity **[ISO STEP]** can be changed to 1/3 EV or 1EV increments.  "ISO STEP" (P. 105)

TIPS**To automatically set the optimal ISO in M mode:**

→ Normally, the AUTO setting is not available in **M** mode, but you can set it for use in all shooting modes.  "ISO-AUTO" (P. 106)

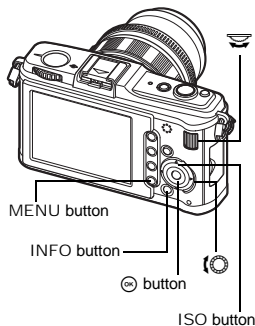

ISO bracketing

The camera automatically takes pictures at a different ISO sensitivity with the shutter speed and aperture value fixed. 3 images with different exposures are recorded in the order of the set ISO sensitivity (optimum exposure when set to **[AUTO]**), exposure in the - direction, and exposure in the + direction.

Compensation value: 0.3, 0.7 or 1.0

- The compensation value is set in 1/3 EV increments regardless of the ISO step setting.

Number of frames: 3

Menu

MENU ▶ [☰] ▶ [] ▶ **[BRACKETING]** ▶ **[ISO BKT]**

Notes

- Bracketing is performed regardless of the upper limit set with **[ISO - AUTO SET]**.

Multiple exposure

This overlays multiple frames and saves the result as a single image. The image is saved with the record mode set at the time the image is saved.

You can overlay an image while taking a picture or overlay a recorded image in playback mode.

MULTIPLE EXPOSURE

In shooting mode, 2 frames of pictures taken can be overlaid and saved as a single image. You can also select a stored RAW image and shoot multiple exposures to create an overlay image.

[FRAME] : Select **[2F]**.

[AUTO GAIN] : When set to **[ON]**, the brightness of each frame is set to 1/2 and the images are overlaid. When set to **[OFF]**, the images are overlaid with the original brightness of each frame.

[OVERLAY] : Then set to **[ON]**, a RAW image recorded on a card can be overlaid with multiple exposures and stored as a separate image. The number of pictures taken is one.

IMAGE OVERLAY

In playback mode, up to 3 frames of RAW images can be overlaid and saved as a single image.

☰ "Image overlay" (P. 90)

Menu

MENU ▶ [☰] ▶ **[MULTIPLE EXPOSURE]**

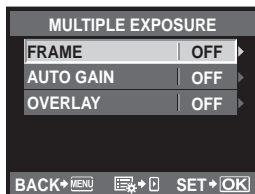

Setting display

- When multiple exposure is set, [] is displayed on the LCD monitor. When shooting is interrupted, [] is displayed in green.

To cancel the image during shooting:

→ Pressing the  button cancels the last picture taken.

To shoot multiple exposures while checking the composition for each frame:

→ The overlay images are displayed semi-transparently on the LCD monitor so you can shoot while checking the position of the image overlay.

To overlay 3 or more frames:

→ To overlay 3 or more frames, save the image as a RAW file and use **[OVERLAY]** to repeat the multiple exposure shooting.

**Notes**

- When multiple exposure is set, **[SLEEP]** is set to **[OFF]** automatically.
- RAW images taken with another camera cannot be used for the overlay image.
- When **[OVERLAY]** is set to **[ON]**, the images displayed when a RAW image is selected are developed with the settings at the time of shooting.
- To set the shooting functions, cancel multiple exposure shooting first. Some functions cannot be set.
- Multiple exposure is cancelled automatically from the first picture in the following situations.
 - The camera is turned off/The  button is pressed/The MENU button is pressed/The shooting mode is set to a mode other than **P, A, S, M**/The lens release button is pressed/
 - The battery power runs out/The USB cable, AV cable and/or HDMI mini-cable is inserted
- The information for the first frame during multiple exposure shooting is displayed as the shooting information.
- When a RAW image is selected using **[OVERLAY]**, the JPEG image for the image recorded in JPEG+RAW is displayed.
- When shooting multiple exposures using bracketing, priority is given to multiple exposure shooting. While the overlay image is being saved, bracketing is reset to the factory default setting.

3 Focusing and shooting functions

AF mode selection

AF

The three focus modes S-AF, C-AF, and MF are available with this camera. You can take pictures by combining S-AF mode with MF mode.

Direct button

AF

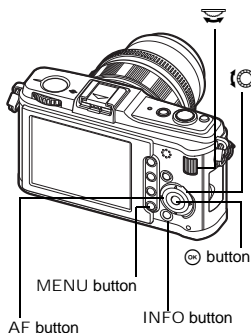
Live controlOK ▶ : [AF MODE]**Super control panel**OK ▶ INFO ▶ : [AF MODE]**Menu**MENU ▶  ▶  ▶ [AF MODE]

S-AF (single AF)

Focusing is performed once when the shutter button is pressed halfway. If focusing fails, release your finger from the shutter button and press it halfway again. This mode is suitable for taking pictures of still subjects or subjects with limited movement.

Press the shutter button halfway.

- When the focus is locked, the AF confirmation mark lights up on the LCD monitor.
- A beep sound is outputted when the subject is in focus.

TIPS**When you want to quickly switch from AF mode to MF:**

→ By registering [MF] to the Fn button, you can press the Fn button to switch to MF mode.  "Fn FUNCTION" (P. 100)

When you want to be able to shoot even if the subject is not in focus:

→ See "RLS PRIORITY S/RLS PRIORITY C" ( P. 102).

3

Focusing and shooting functions

C-AF (continuous AF)

The camera repeats focusing while the shutter button remains pressed halfway. Even if the subject moves or you change the composition of the picture, the camera continues trying to focus.

Press the shutter button halfway and keep it in this position.

- When the subject is in focus and locked, the AF confirmation mark lights up on the LCD monitor.
- The AF target does not light up, even when the subject is in focus.
- The camera repeats focusing. Even if the subject moves or even if you change the composition of the picture, focusing is tried continuously.
- A beep sound is outputted when the subject is in focus. The beep sound is not outputted after the third continuous AF operation, even when the subject is in focus.
- This feature is not supported in Four Thirds system lenses.

MF (manual focus)

This function allows you to manually focus on any subject.

Adjust the focus using the focus ring.

- Turn the focus ring and the view will switch to zoom display automatically. You can disallow zoom display.  "MF ASSIST" (P. 98)

TIPS

To change the rotational direction of the focus ring:

- You can select the rotational direction of the focus ring to suit your preference for how the lens adjusts to the focusing point.  "FOCUS RING" (P. 98)

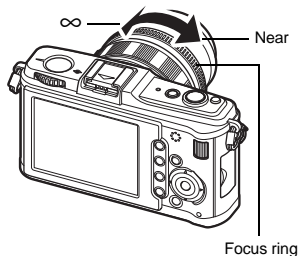

Simultaneous use of S-AF mode and MF mode (S-AF+MF)

This function allows you to fine-adjust the focus manually by turning the focus ring after AF is performed in the S-AF mode.

- Press the shutter button halfway. After AF is confirmed, rotate the focus ring to fine-adjust the focus.

Notes

- If the shutter button is pressed again after fine-adjusting the focus with the focus ring, the AF is activated and your adjustments are cancelled.

AF target selection

This camera has 11 AF targets for focusing on the subject with auto focus. Select the optimal AF target mode according to your subject and the composition. There are two AF target modes: All target AF mode, which uses AF at all AF targets, and Single target AF mode, which uses AF centering around one selected AF target.

[⋮] All target AF mode

The camera focuses automatically on one of the 11 AF targets. Use this feature when you wish to leave focusing to the camera.

[·] Single target AF mode

The camera focuses using one selected AF target. This is useful for accurately focusing on the subject after composing the shot.

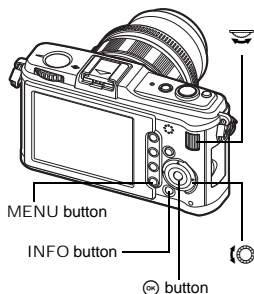
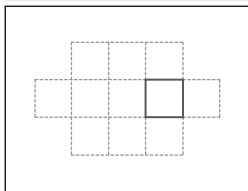
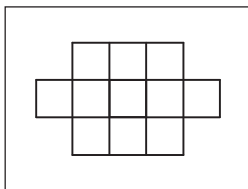

Live control

ON ▶ : [AF AREA]

Super control panel

ON ▶ INFO ▶ : [AF AREA]

Menu

MENU ▶ ▶ ▶ [AF AREA]

- The currently selected AF target lights. When [·] is set, you can select the AF target to be used at that point. For operation, refer to Step 2 in "Selecting the AF target mode and position" (P. 59) in the next section.

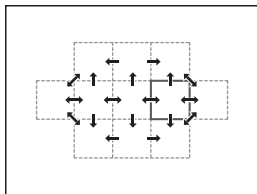

Selecting the AF target mode and position

Select the AF target mode or select the AF target to use with Single target AF mode.

- 1 Using [AF AREA] select [·] to enable selection of the AF target mode and position.
- 2 Use the main dial and sub dial or arrow pad to select the AF target.

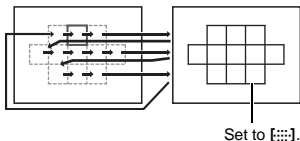

TIPS

Selecting the position of the AF target with the arrow pad.

→ Press the shutter button halfway and release it, then use the arrow pad to change the position of the AF target.

"d" FUNCTION" (P. 102)

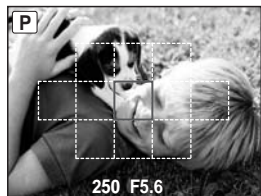

Registering an AF target mode

You can register a frequently used AF target mode and the position of that AF target. You can then quickly load that registered setting ("home position") and use it when shooting.

Registering

- 1 In the screen of Step 2 of "Selecting the AF target mode and position" (P. 59), press the **Fn** button and button at the same time.

- The home position is registered at the time the buttons are pressed.
- The home position cannot be registered when operated from a menu.

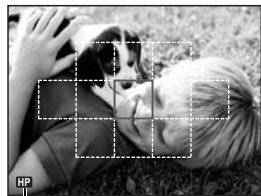

Indicates that the AF target is being registered.

Shooting

To use this function, you must assign the []HOME] function to the **Fn** button in advance.

"Fn" FUNCTION" (P. 100)

- 1 Press the **Fn** button.
 - The registered home position is selected. Press this button again to switch to the original AF target mode.

Focus lock – If correct focus cannot be obtained

If the camera's focus does not focus, the easiest solution is to use the focus lock. Use this when composing the subject outside of the AF targets or when the subject is difficult to focus on.

1 Adjust 1 selected AF target to the subject to be focused and press the shutter button halfway until the AF confirmation mark lights up. (Single target AF mode)

- The focus is locked. The AF confirmation mark and the AF target in focus light up on the LCD monitor.
- If the AF confirmation mark blinks, press the shutter button halfway again.
- The AF target mark is displayed for only a moment when the shutter button is pressed halfway.

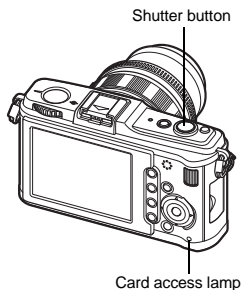

e.g.) The camera focuses using the center AF target.



AF confirmation mark



2 While pressing the shutter button halfway, move to the desired composition and press the button all the way.

- The card access lamp blinks while the picture is being stored on the card.

If the subject has lower contrast than its surroundings

If the contrast of the subject is weak, such as when the lighting is insufficient or the subject cannot be seen clearly because of fog, the focus may not be achieved. Focus (focus lock) on a high-contrast object the same distance away as the intended subject, recompose your shot and then take the picture.

Sequential shooting



- Single-frame shooting Shoots 1 frame at a time when the shutter button is pressed (normal shooting mode).
- Sequential shooting Shoots at approximately 3 frames/sec. for as long as the shutter button is pressed (during S-AF, MF).
- Press the shutter button fully and keep it pressed. The camera will take pictures in sequence until you release the button.
 - Focus, exposure, and white balance are locked at the first frame (during S-AF, MF).

! Notes

- During sequential shooting, if the battery check blinks due to low battery, the camera stops shooting and starts saving the pictures you have taken on the card. The camera may not save all of the pictures depending on how much battery power remains.

Direct button



Live control



Super control panel



- Anti-shock display:
The symbol on the LCD monitor indicates that anti-shock is activated.
 "ANTI-SHOCK" (P. 106)

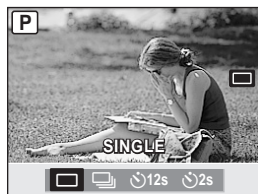
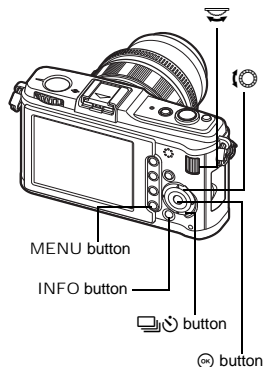

Self-timer shooting



This function lets you take pictures using the self-timer. You can set the camera to release the shutter after either 12 or 2 seconds. Fix the camera securely on a tripod for self-timer shooting. For the setting method, see "Sequential shooting" (P. 61).

Press the shutter button all the way.

- When 12s is selected: First, the self-timer lamp lights up for approximately 10 seconds, then it blinks for approximately 2 seconds and the picture is taken.
- When 2s is selected : The self-timer lamp blinks for approximately 2 seconds, and then the picture is taken.
- To cancel the activated self-timer, press the button.

Notes

- Do not press the shutter button while standing in front of the camera; this could result in the subject being out of focus since focusing is performed when the shutter button is pressed halfway.

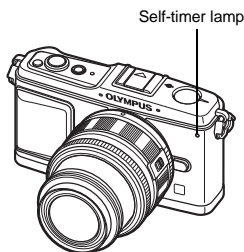

Self-timer lamp

Image stabilizer

You can reduce the amount of camera shake that can occur when shooting in low light situations or shooting with high magnification.

- OFF** Image stabilizer is off.
- I.S. 1** Image stabilizer is on.
- I.S. 2** This is used for panning with the camera in the horizontal direction to achieve a blurred background. The horizontal image stabilizer is turned off, and only the vertical image stabilizer is activated.
- I.S. 3** This is used for panning with the camera in the vertical direction to achieve a blurred background (tilting). The vertical image stabilizer is turned off, and only the horizontal image stabilizer is activated.

Live control

[IMAGE STABILIZER]

Super control panel

[IMAGE STABILIZER]

Menu

MENU [IMAGE STABILIZER]

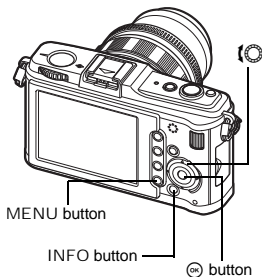





MENU button

INFO button

OM button

Setting the focal length

By setting the focal length of the lens in advance, you can use the image stabilizer function with lenses other than Micro Four Thirds/Four Thirds system lenses. This setting is deactivated when a Micro Four Thirds/Four Thirds system lens is attached.

- 1 Press the  button when the image stabilizer is turned on.
- 2 Use the sub dial or   to set the focal length and press .



Focal lengths that can be set

8mm	10mm	12mm	16mm	18mm	21mm	24mm	28mm	30mm	35mm
40mm	48mm	50mm	55mm	65mm	70mm	75mm	80mm	85mm	90mm
100mm	105mm	120mm	135mm	150mm	180mm	200mm	210mm	250mm	300mm
350mm	400mm	500mm	600mm	800mm	1,000mm				

- If the focal length of the lens you are using is not listed, select the closest value.

Notes

- The image stabilizer cannot correct excessive camera shake or camera shake that occurs when the shutter speed is set to the slowest speed. In these cases, it is recommended that you use a tripod.
- When using a tripod, set **[IMAGE STABILIZER]** to **[OFF]**.
- When using a lens with an image stabilization function, turn off the image stabilizer function of either the lens or the camera.
- If **[IMAGE STABILIZER]** is set to **[I.S.1]**, **[I.S.2]** or **[I.S.3]** and you turn off the camera, the camera will vibrate. This is due to the camera initializing the image stabilizer mechanism. Without this initialization, the image stabilizer may not be able to achieve the proper effect.
- You may notice an operating sound or vibration when the image stabilizer is activated.
- If the image stabilizer icon blinks in red on the monitor, it indicates a failure of the image stabilizer function. If you take a picture as is, the composition may be off. Consult your Olympus Authorized Service Center.
- The image stabilizer will not activate at shutter speeds of over 2 seconds.
- If the internal temperature of the camera exceeds the specified temperature, the image stabilizer is deactivated and the image stabilizer icon lights red on the monitor.

Selecting the record mode

You can select a record mode in which to take pictures. Choose the record mode that is best for your purpose (printing, editing on a PC, website editing, etc.).

Recording formats

JPEG

For JPEG images, select a combination of image size (**L**, **M**, **S**) and compression rate (SF, F, N, B). An image consists of pixels (dots). When you enlarge an image with a low pixel count, it will be displayed as a mosaic. If an image has a high pixel count, the file size (amount of data) will be larger and the number of storable still pictures will be lower. The higher the compression, the smaller the file size. However, the image will have less clarity when played back.

4

Record mode, white balance, and picture mode

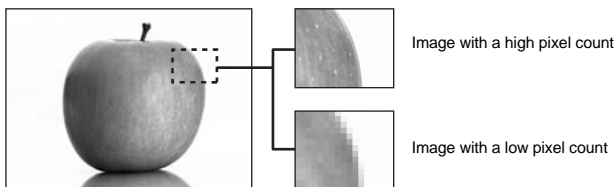



Image becomes clearer

Application	Number of pixels	Pixel count	Compression rate			
			SF (Super Fine) 1/2.7	F (Fine) 1/4	N (Normal) 1/8	B (Basic) 1/12
Select for the print size	L (Large)	4032 x 3024	L SF	L F	L N	L B
		3200 x 2400	M SF	M F	M N	M B
	2560 x 1920					
	1600 x 1200					
For small-sized prints and use on a web site	S (Small)	1280 x 960	S SF	S F	S N	S B
		1024 x 768				
		640 x 480				

RAW

This is unprocessed data that has not undergone changes in white balance, sharpness, contrast or color. To display as an image on the computer, use OLYMPUS Master. RAW data cannot be displayed on a different camera or by using common software, and it cannot be selected for print reservation. RAW files are assigned an ".ORF" file extension.

RAW images can be edited with this camera and saved as JPEG data.  "Editing still images" (P. 89)

Selecting the record mode

JPEG

For JPEG, you can register 4 combinations of images sizes (**L**, **M**, **S**) and compression rates (SF, F, N, B) from the 12 total combinations available.  "SET" (P. 108)

When you select the **M** or **S** image size, you can further select the pixel size.

 "PIXEL COUNT" (P. 109)

JPEG+RAW

Records both a JPEG and RAW image at the same time each time you take a picture.

RAW

Records the image in RAW data format.

e.g.) The following 9 record modes are available when **L**F/**L**N/**M**N/**S**N are registered

RAW : RAW

JPEG : **L**F/**L**N/**M**N/**S**N

JPEG+RAW : **L**F+RAW/**L**N+RAW/**M**N+RAW/**S**N+RAW

Live control

[Fn]

Super control panel

INFO [Fn]

Menu

MENU [Fn] [STILL PICTURE]

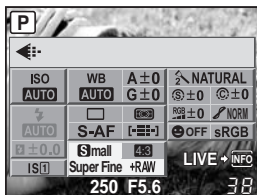

TIPS

To quickly set the record mode:

→ By setting [RAW] to the Fn button, you can turn the main dial while pressing the Fn button to change the record mode. Each time you press the Fn button, you can easily switch between JPEG data only and JPEG and RAW data.

"Fn FUNCTION" (P. 100)

To find out the file size/number of storable still pictures for each record mode:

→ "Record mode and file size/number of storable still pictures" (P. 140)

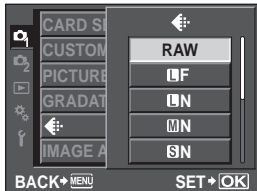

4

Record mode, white balance, and picture mode

Selecting the white balance

Color reproduction differs depending on light conditions. For instance, when daylight or tungsten lighting is reflected on white paper, the shade of white produced will be slightly different for each. With a digital camera, white color can be adjusted to reproduce more natural white with a digital processor. This is called white balance. There are 4 options for setting the WB with this camera.

Auto white balance [AUTO]

This function enables the camera to automatically detect white in images and adjust the color balance accordingly. Use this mode for general use.

Preset white balance











8 different color temperatures are preset according to the light source. For example, use preset WB when you want to reproduce more red in the picture of a sunset, or capture a warmer artistic effect under artificial lighting.

Custom white balance [CWB]

You can set the color temperature from 2000K to 14000K. For details on color temperature, refer to "White balance color temperature" (P. 139).

One-touch white balance

You can set the optimum white balance for the shooting conditions by pointing the camera at a white object like a sheet of white paper. The white balance achieved with this setting is saved as one of the preset WB settings.

WB mode	Light conditions
AUTO	Used for most light conditions (when there is a white portion framed on the LCD monitor). Use this mode for general use.
 5300K	For shooting outdoors on a clear day, or to capture the reds in a sunset or the colors in a fireworks display
 7500K	For shooting outdoors in the shadows on a clear day
 6000K	For shooting outdoors on a cloudy day
 3000K	For shooting under a tungsten light
 4000K	For shooting under white fluorescent lighting
 4500K	For shooting under a neutral white fluorescent lamp
 6600K	For shooting under a daylight fluorescent lamp
 5500K	For flash shooting
	Color temperature set by one-touch WB.  "Setting the one-touch white balance" (P. 69)
CWB	Color temperature set in custom white balance menu. This can be set from 2000K to 14000K. When the value has not been set, it is set to 5400K.

You can adjust the white balance by selecting the appropriate color temperature for the light conditions.

Direct button WB

Live control ► : [WB]

Super control panel ► INFO ► : [WB]

- Custom white balance is set by selecting [CWB] and turning the sub dial while pressing down the button.

Menu MENU ► ► ► [WB]

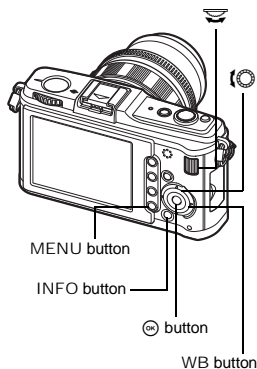

4

TIPS

When subjects that are not white appear white:

- In the auto WB setting, if there is no near-white color in the image framed in the screen, the white balance will not be correctly determined. In such a case, try preset WB or one-touch WB settings.



WB compensation

This function lets you make fine changes to the auto WB and preset WB settings.

Super control panel ► INFO ► : [WB%]

Menu MENU ► ► ► [WB]

- Select the white balance to adjust and press .

Adjusting the white balance in the A direction (Amber-Blue)

Depending on the original WB conditions, the image will become more amber when adjusted toward +, and bluer when adjusted toward –.

Adjusting the white balance in the G direction (Green-Magenta)

Depending on the original WB conditions, the image will become greener when adjusted toward +, and magenta when adjusted toward –.

- The white balance can be adjusted in 7 increments in each direction.

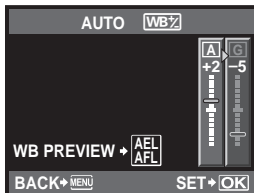

TIPS

Checking the white balance you have adjusted:

→ After setting the compensation value, point the camera at the subject to take test shots. When the AEL/AFL button is pressed, sample images that have been taken with the current WB settings are displayed.

Adjusting all WB mode settings at once:

→ See "ALL [WBZ]" (P. 108).

Setting the one-touch white balance

This function is useful when you need a more precise white balance than preset WB can provide. Point the camera at a sheet of white paper under the light source you want to use to determine the white balance. The optimum white balance for the current shooting conditions can be saved in the camera. This is useful when shooting a subject under natural light, as well as under various light sources with different color temperatures.

Set [Fn FUNCTION] to [WB] beforehand. (P. 100)

- 1 Point the camera at a sheet of white paper.**
 - Position the paper to fill the screen and unshadowed.
- 2 While holding down the Fn button, press the shutter button.**
 - The one-touch white balance screen appears.
- 3 Select [YES] and press the \odot button.**
 - The white balance is registered.
 - The registered white balance will be stored in the camera as a preset WB setting. Turning the power off does not erase the data.

TIPS

After pressing the shutter button, [WB NG RETRY] is displayed:

→ When there is not enough white in the image, or when the image is too bright, too dark or the colors look unnatural, you cannot register the white balance. Change the aperture and shutter speed settings, then repeat the procedure from Step 1.

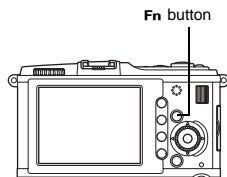

WB bracketing

Three images with different white balances (adjusted in specified color directions) are automatically created from one shot. One image has the specified white balance, while the others are the same image adjusted in different color directions.

Menu

MENU ▶ [☰] ▶ [WB] ▶ [BRACKETING] ▶ [WB BKT]

- Select from [OFF]/[3F 2STEP]/[3F 4STEP], or [3F 6STEP] for the EV step for both the A-B (amber-blue) direction and the G-M (green-magenta) direction.
- When the shutter button is pressed down all the way, 3 images adjusted in specified color directions are automatically created.

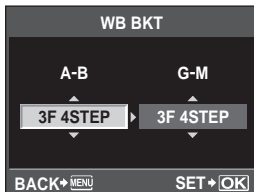

4

TIPS

To apply WB bracketing to the white balance:

→ Adjust white balance manually, then use the WB bracketing feature. WB bracketing is applied to the white balance you have adjusted.



Notes

- During WB bracketing, the camera cannot shoot the pictures if there is not enough memory in the camera and card for storing at least the selected number of frames.

Picture mode

You can select image tone to create unique image effects. You can also fine-adjust image parameters such as contrast and sharpness for each mode. The adjusted parameters are recorded in each picture effect mode.

- [**VIVID**] : Produces vivid colors.
- [**NATURAL**] : Produces natural colors.
- [**MUTED**] : Produces flat tones.
- [**PORTRAIT**] : Produces beautiful skin tones.
- [**MONOTONE**] : Produces black and white tone.
- [**CUSTOM**] : Select one picture mode, set the parameters, and register the setting. You can also register the gradation to [**CUSTOM**]. This setting is stored separately from [**GRADATION**] in the menu. "Gradation" (P. 72)

Super control panel

INFO :
[**PICTURE MODE**]

Menu

MENU :
[**PICTURE MODE**]

The adjustable parameters vary according to the picture modes.

The individual parameters are as follows.

- [**CONTRAST**] : Distinction between light and dark
- [**SHARPNESS**] : Sharpness of the image
- [**SATURATION**] : Vividness of the color
- [**B&W FILTER**] : Creates a black and white image. The filter color is brightened and the complementary color is darkened.

[**N: NEUTRAL**] : Creates a normal black and white image.

[**Ye: YELLOW**] : Reproduces clearly defined white cloud with natural blue sky.

[**Or: ORANGE**] : Slightly emphasizes colors in blue skies and sunsets.

[**R: RED**] : Strongly emphasizes colors in blue skies and brightness of crimson foliage.

[**G: GREEN**] : Strongly emphasizes colors in red lips and green leaves.

[**PICT. TONE**] : Colors the black and white image.

[**N: NEUTRAL**] : Creates a normal black and white image.

[**S: SEPIA**] : Sepia

[**B: BLUE**] : Bluish

[**P: PURPLE**] : Purplish

[**G: GREEN**] : Greenish

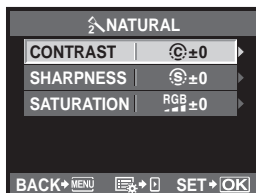
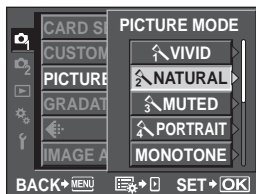

4

Record mode, white balance, and picture mode

Gradation

In addition to the **[NORMAL]** gradation setting, you can select from 3 other gradation settings.

- [HIGH KEY]** : Gradation for a bright subject.
[LOW KEY] : Gradation for a dark subject.
[AUTO] : Divides the image into detailed regions and adjusts the brightness separately for each region. This is effective for images with areas of large contrast in which the whites appear too bright or the blacks appear too dark.
- [NORMAL]** : Use **[NORMAL]** mode for general uses.



HIGH KEY

Suitable for a subject that is mostly highlighted.



LOW KEY

Suitable for a subject that is mostly shadowed.

4

Record mode, white balance, and picture mode

Super control panel

 : **[GRADATION]**

Menu

MENU  : **[GRADATION]**

Notes

- Contrast adjustment does not work when set to **[HIGH KEY]**, **[LOW KEY]**, or **[AUTO]**.

External flash shooting

With this camera, you can use one of the separately sold external flash units to achieve a flash suited to your needs.

The external flashes communicate with the camera, allowing you to control the camera's flash modes with various available flash control modes, such as TTL-AUTO and Super FP flash. An external flash unit specified for use with this camera can be mounted on the camera by attaching it to the camera's hot shoe. You can also attach the flash to the flash bracket on the camera using the bracket cable (optional).

Refer to the external flash's manual as well.

Functions available with external flash units

Optional flash	FL-50R	FL-36R	FL-20	FL-14	RF-11	TF-22
Flash control mode	TTL-AUTO, AUTO, MANUAL, FP TTL AUTO, FP MANUAL		TTL-AUTO, AUTO, MANUAL		TTL-AUTO, MANUAL	
GN (Guide number) (ISO100)	GN50 (85 mm*) GN28 (24 mm*)	GN36 (85 mm*) GN20 (24 mm*)	GN20 (35 mm*)	GN14 (28 mm*)	GN11	GN22

* The focal length of the lens that can be used (Calculated based on 35 mm film camera)

Using the external electronic flash

Be sure to attach the flash to the camera before turning on the flash's power.

- 1 Remove the hot shoe cover by sliding it in the direction indicated by the arrow in the illustration.

- Keep the shoe cover in a safe place to avoid losing it, and put it back on the camera after flash shooting.

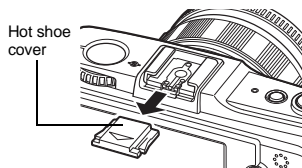

- 2 Attach the electronic flash to the hot shoe on the camera.

- If the lock pin is protruding, turn the shoe lock ring as far as it will go in the direction opposite to LOCK. This will pull the lock pin back inside.

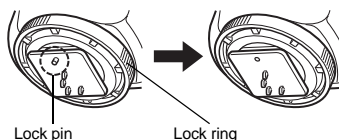

- 3 Turn on the flash.**
 - When the charge lamp on the flash lights up, charging is complete.
 - The flash will be synchronized with the camera at a speed of 1/180 sec. or less.
- 4 Select a flash mode.**
- 5 Select the flash control mode.**
 - TTL-AUTO is recommended for normal use.
- 6 Press the shutter button halfway.**
 - Shooting information such as ISO sensitivity, aperture value, and shutter speed is communicated between the camera and flash.
- 7 Press the shutter button all the way.**

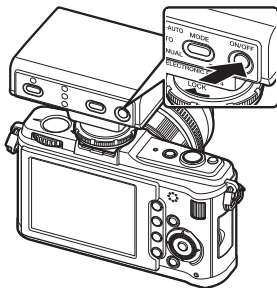

Super FP flash

Super FP flash is available with the FL-50R or FL-36R.

You can use the Super FP flash even where normal flashes cannot be used with high shutter speed. Fill-in flash shooting with the aperture open (such as in outdoor portrait shooting) is also possible with Super FP flash. For details, refer to the external flash's manual.

Using commercially available flashes

5

You cannot use the camera to adjust the amount of light emitted from a commercially available flash except for a flash specified for use with this camera. To use a commercially available flash, connect it to the hot shoe. Set the camera's shooting mode to **M**.

Flash shooting

Non-specified commercial flashes

- 1) Exposures when using a flash require that adjustments be made on the flash. If a flash is used in the auto mode, match it with the f-number and ISO sensitivity settings on the camera.
- 2) Even if the flash auto f-number and ISO sensitivity are set the same as on the camera, the correct exposure may not be obtained depending on the shooting conditions. In such a case, adjust the auto f-number or ISO on the flash or calculate the distance in the manual mode.
- 3) Use a flash with an illumination angle that matches the focal length of the lens. The focal length of the lens for 35 mm film is approximately twice as long as the focal length of the lenses designed for this camera.
- 4) Do not use a flash unit or other accessory TTL flash that has additional communication functions other than the specified flashes, since it may not only fail to function normally, but may also cause damage to the camera's circuitry.

Set when using the external flash which is sold separately. The camera sets the flash mode according to various factors such as firing pattern and flash timing. Available flash modes depend on the exposure mode.

Auto flash AUTO

The flash fires automatically in low light or backlight conditions. To shoot a subject with backlighting, position the AF target over the subject.

Flash synchronization speed/Slow limit

Shutter speed can be changed when the flash fires. "X-SYNC." (P. 106), "SLOW LIMIT" (P. 106)

Red-eye reduction flash

In the red-eye reduction flash mode, a series of pre-flashes are emitted just before the regular flash fires. This helps accustom the subject's eyes to the bright light and minimizes the red-eye phenomenon. In **S/M** mode, the flash always fires.



The subject's eyes appear red

Notes

- After the pre-flashes, it takes about 1 second before the shutter is released. Hold the camera firmly to avoid camera shake.
- Effectiveness may be limited if the subject is not looking directly at pre-flashes, or if the shooting range is too far. Individual physical characteristics may also limit effectiveness.

Slow synchronization (1st curtain) SLOW

The slow synchronization flash is designed for slow shutter speeds. Normally, when shooting with a flash, shutter speeds cannot go below a certain level to prevent camera shake. But when shooting a subject against a night scene, fast shutter speeds can make the background too dark. Slow synchronization allows you to capture both the background and the subject. Since the shutter speed is slow, be sure to stabilize the camera by using a tripod so as not to cause the picture to be blurred.



1st curtain

Usually, the flash fires right after the shutter fully opens. This is called 1st curtain. This method is usually used during flash shooting.

Slow synchronization (2nd curtain) ⚡ SLOW/2nd CURTAIN

2nd curtain flash fires just before the shutter closes. Changing the flash timing can create interesting effects in your picture, such as expressing the movement of a car by showing the tail-lights streaming backwards. The slower the shutter speed, the better the effects turn out. In **S/M** mode, the flash always fires.

When the shutter speed is set to 2 sec.

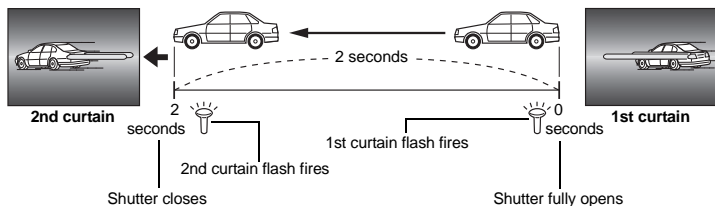

Slow synchronization (1st curtain)/Red-eye reduction flash ⦿ SLOW

While using slow synchronization with flash shooting, you can also use this function to achieve red-eye reduction. When shooting a subject against a night scene, this function allows you to reduce the red-eye phenomenon. As the time from emitting pre-flashes to shooting is long in 2nd curtain synchronization, it is difficult to achieve red-eye reduction. Hence, only 1st curtain synchronization setting is available.

5

Flash shooting

Fill-in flash ⚡

The flash fires regardless of the light conditions. This mode is useful for eliminating shadows on the subject's face (such as shadows from tree leaves), in a backlight situation, or for correcting the color shift produced by artificial lighting (especially fluorescent light).



! Notes

- When the flash fires, the shutter speed is set to 1/180 sec. or less. When shooting a subject against a bright background with the fill-in flash, the background may be overexposed. In this case, use the optional FL-50R external flash or a similar flash and shoot in the Super FP flash mode. 📖 "Super FP flash" (P. 74)

Flash off ⚡

The flash does not fire.

Flash intensity control

The flash intensity can be adjusted from +3 to -3.

In some situations (e.g., when shooting small subjects, distant backgrounds, etc.), you may get better results by adjusting the amount of light emitted by the flash ("flash intensity"). It is useful when you intend to increase the contrast (distinction between light and dark) of images to make the images more vivid.

Super control panel

☰ ▶ INFO ▶ : [52]

Menu

MENU ▶ [52] ▶ [52] ▶ [52]

! Notes

- This does not work when the flash control mode on the electronic flash is set to MANUAL.
- If flash intensity is adjusted on the electronic flash, it will be combined with the camera's flash intensity setting.
- When [52]+[52] is set to [ON], the flash intensity value will be added to the exposure compensation value.

"[52]+[52]" (P. 107)

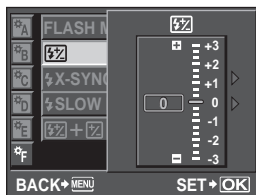
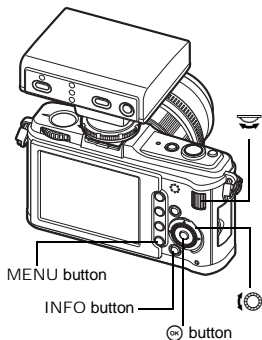

5

Flash shooting

Flash bracketing

The camera shoots multiple frames, changing the amount of light emitted by the flash for each shot. The camera shoots 3 frames at a time with the following amount of light: optimum light, light adjusted in the - direction, and light adjusted in the + direction.

Menu

MENU ▶ [52] ▶ [52] ▶ [BRACKETING] ▶ [FL BKT]

- The compensation value will change according to the EV step. "EV STEP" (P. 105)
- In single-frame shooting, the amount of light emitted by the flash changes every time the shutter button is pressed.
- In sequential shooting, hold down the shutter button until the selected number of frames are taken.
- Releasing the shutter button stops flash bracketing shooting. When it stops, [BKT] is displayed in green on the LCD monitor.

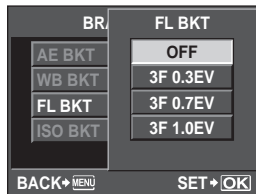

Movie recording



You can record high-definition movies. Stereo sound is recorded simultaneously. In addition to using the **[P]** mode in which optimal aperture values are set automatically according to the brightness of the subject and the **[A]** mode in which changes are applied to the depiction of the background, you can use art filtering effects to to enrich the expressiveness of your movies.

1 Set the mode dial to .

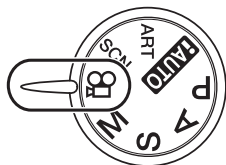

2 Press the shutter button halfway down and focus on what you wish record.

- Focusing is achieved by autofocus, and the AF confirmation mark lights up.

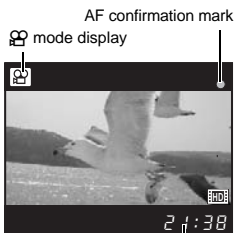

Available recording time

3 Press the shutter button all the way to begin recording.

- Sound recording begins simultaneously (when **[MOVIE]** is set to **[ON]**).
- "Recording Audio when Recording Movie" (P. 80)



Total recording time

4 Press the shutter button all the way to end recording.

TIPS

Autofocus is not working properly:

- Press the AEL/AFL button for AF operation.
- The sound of the lens triggering will be recorded.

! Notes

- When recording a movie, you cannot change the settings for exposure compensation and aperture value.
- In movie mode, **[IMAGE STABILIZER]** provides electronic stabilization. When you use this function, the recorded image is enlarged by a small amount. Also, **[I.S.1]** will operate regardless of the settings for **[I.S.1]**, **[I.S.2]** and **[I.S.3]**.
- Stabilization is not possible when the camera shake is excessive.
- When using a lens with an image stabilization function, turn off the image stabilizer function of either the lens or the camera.
- You cannot use **[😊 FACE DETECT]** in movie mode.
- With some types of media, you cannot record to the end of the available time and recording is canceled automatically during operation. Also, the size of any given file is limited to 2 GB.
- When the inside of the camera becomes hot, shooting is automatically stopped to protect the camera.
- You cannot make a further recording while the card access lamp is blinking at the end of a recording.
- With some art filters, **[C-AF]** operation is limited.
- It is recommended to use a SD speed class 6 compatible card for movie shooting.

Changing the settings for movie recording

Adding effects to a movie

Live control

[Fn] ▶ **[Fn]** ▶ **[MOVIE AE MODE]**

Menu

[MENU] ▶ **[Fn]** ▶ **[MOVIE AE MODE]**

- Select using **[Fn]** **[Fn]**, then press the **[Fn]** button.
- [P]** Optimal aperture is set automatically according to the brightness of the subject.
- [A]** Depiction of background is changed by setting the aperture. Turn the sub dial to set the aperture.
- [ART1]~[ART6]** Movie is recorded with characteristics of art filter mode.
- [Fn]** "Setting the art filter/scene" (P. 5)

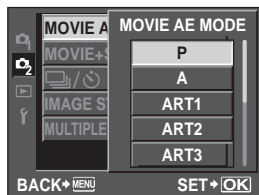

Selecting the record mode

Live control

ON ▶ () ▶ []

Menu

MENU ▶ [] ▶ [] ▶ [MOVIE]

Movie Record Mode

Record mode	Application
HD	The number of pixels is 1280 x 720. You can record high-definition movies.
SD	The number of pixels is 640 x 480.

Recording Audio when Recording Movie



Set to [ON] to record sound simultaneously when movie recording begins.

Live control

ON ▶ () ▶ [MOVIE]

Menu

MENU ▶ [] ▶ [MOVIE]

- Select using  , then press the ON button.

! Notes

- When recording sound in a movie, the sound of the lens triggering and camera operating may be recorded. If desired, you can reduce these sounds by shooting with [AF MODE] set to [S-AF], or by limiting the amount of times you press the buttons.

6



Recording Movies

Taking still picture automatically when movie recording ends

Set to [ON] to take a still picture when you perform the operation to end recording of a movie. This feature is useful when you want to record a still picture as well as the movie.

Menu

MENU ▶ [] ▶ [MOVIE+STILL]

- Select using  , then press the ON button.

Single-frame/Close-up playback



The basic procedure for viewing pictures are as shown below. However, before using any of these functions, follow Step 1 below. You can set the camera to automatically switch to single-frame playback mode after shooting. "REC VIEW" (P. 95)

1 Press the button (Single-frame playback).

- The last recorded image appears.
- The sound recorded when taking the picture is played back simultaneously.
- The LCD monitor turns off after more than 1 minute if no operations are performed.

2 Use to select images you want to view. You can also turn the sub dial to switch to for close-up playback.

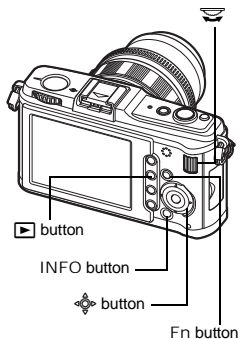

(Single-frame playback)



- : Displays the frame that is stored 10 frames back
- : Displays the frame that is stored 10 frames ahead
- : Displays the next frame
- : Displays the previous frame

Press the **Fn** button

- Plays back the image at a 10x magnified close-up position.



(Close-up playback)

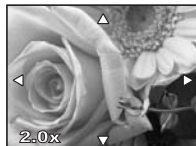

Press to change the close-up position.

Press the **INFO** button

(Close-up position playback)



Press to move the display of the close-up position.

When [**FACE DETECT**] (P. 39) is set to [ON], a frame is displayed around a detected face. Press to move the frame to another face.

Press the **INFO** button

(Close-up frame-by-frame playback)



Press to view frame-by-frame close-ups.

When [**FACE DETECT**] is set to [ON], press to move to another face in close-up position.

- Press the **INFO** button to return to close-up playback.

- To exit the playback mode, press the button again.
- Pressing the shutter button halfway resumes the shooting mode.

Index display/Calendar display





This function lets you show several images on the monitor at the same time. This is useful when you want to quickly search a number of pictures to find a particular image.

During single-frame playback, each time you turn the sub dial toward , the number of images shown changes between 4, 9, 16, 25, 49 and 100 pictures.

 : Moves to the previous frame

 : Moves to the next frame

 : Moves to the upper frame

 : Moves to the lower frame

• To return to single-frame playback, turn the sub dial to .

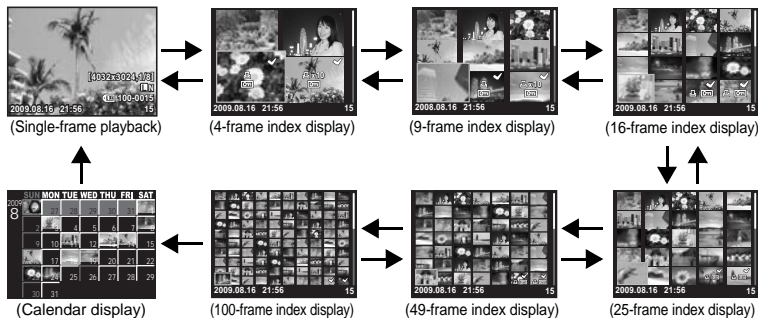
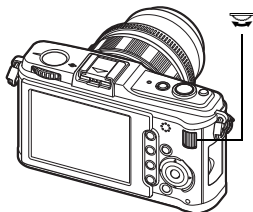



7

Playback functions

Calendar display

With the calendar, you can display images recorded on the card by date. If more than one image was taken on a single date, the image shot first on that date is displayed.

Use  to select a date and press the  button to play back images for the selected date in single-frame display.

This allows you to display detailed information about the image. Luminance information can also be displayed with histogram and highlight graphs.

Press the INFO button repeatedly until the desired information is displayed.

- This setting is stored and will be shown the next time the information display is called up.

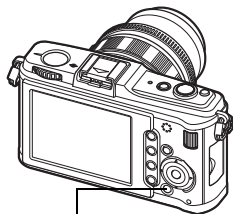

INFO button

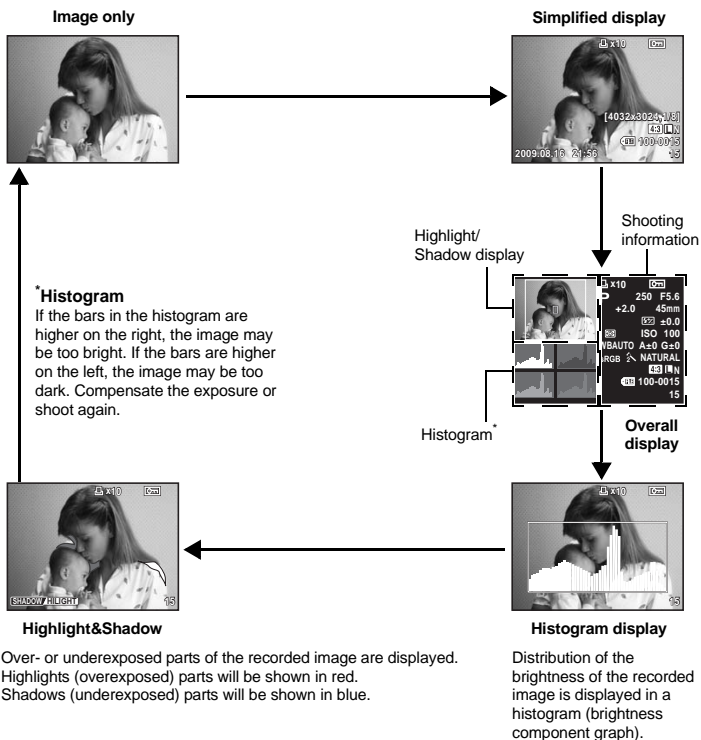
TIPS

To quickly switch to the frequently used display:

- You can hide the information display for all modes except "Simplified display". "INFO SETTING" (P. 104)

Slideshow

This function displays images stored on the card one after another. The images are played back in order, starting with the displayed image.

1 MENU ▶ [▶] ▶ [📷]

- Press the  button during playback to select slideshow.

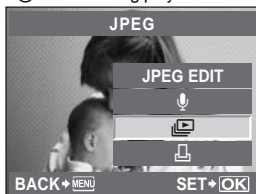

2 Perform slideshow settings.

[START] : Perform slideshow using current settings.

[BGM] : Set BGM (5 types) or turn BGM **[OFF]**.

[SLIDE] : Set type of slideshow to execute.

3 Select **[START]** and press the button.

- The slideshow will start.

4 Press the button to stop the slideshow.

Operations during slideshow

- Turn the main dial to adjust the overall volume (only when playing back sound using the camera speaker).
- Turn the sub dial to adjust the balance between BGM and recorded sound.

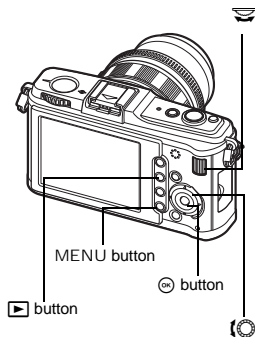

7

Playback functions

TIPS

To change the interval between slides in the slideshow:

- You can set the interval at which to switch between still pictures and the movie playback time.
 "📷 SETUP" (P. 104)

Notes

- If the slideshow is left running for about 30 minutes, the camera will turn off automatically.

Rotating images

This function lets you rotate images and display them vertically on the monitor during single-frame playback. This is useful when taking pictures with the camera held vertically. The images will automatically be displayed in the correct direction even if the camera is rotated.

1 MENU ▶ [] ▶ []

- When set to **[ON]**, images shot vertically will be automatically rotated and displayed during playback. You can also press the  button to rotate and display the image.
- The rotated image will be recorded on the card in that position.
- Rotating playback is not available for movies.

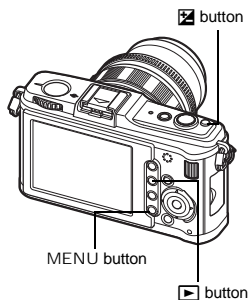

Original image before rotating

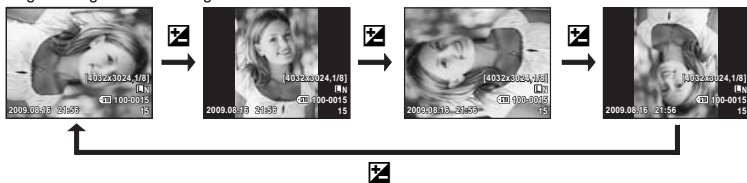

Movie playback

- 1 Select a movie, and press the **OK** button.
- 2 Select [MOVIE PLAY] and press the **OK** button.
 - Playback will start.

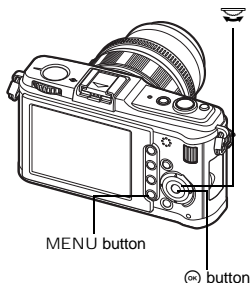
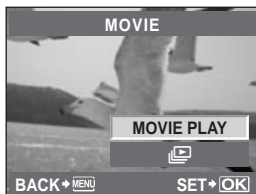

Operations during movie playback

- Volume: Turn the main dial to adjust the volume of the sound from the camera speaker.
- Rewind/Fast-forward: Select using **REW** / **FF**.



Playing time/total recording time

7

Playback functions

- On pressing the **OK** button to pause the movie, you can perform movie operations using the arrow pad.

1 : Displays first frame.

2 : Displays last frame.

3 : Continues playback while pressed.

4 : Continues reverse playback while pressed.

5 : Starts playback.

To stop playback

Press the MENU button.



Playback on TV

Use the AV cable provided with the camera to playback recorded images on your TV. You can playback high-definition images on a high-definition TV by connecting it to the camera using a commercially available HDMI mini-cable.

Connection via AV cable

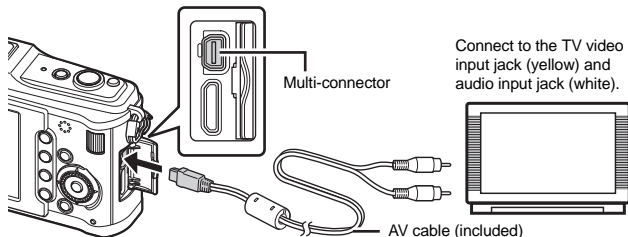

- 1 Connect the TV and camera.
- 2 Use the camera to select the video signal format that matches that of the connected TV ([NTSC]/[PAL]).  “VIDEO OUT” (P. 102)
- 3 Turn on TV, and change [INPUT] to [VIDEO (an input jack connected to the camera)].

Notes

- The camera's monitor turns off automatically when the AV cable is connected to the camera.
- Press the  button when connecting via an AV cable.
- For details on changing the input source of the TV, refer to the TV's instruction manual.
- Depending on the TV's settings, the displayed images and information may become cropped.

Connection via HDMI mini-cable

- Be sure to turn off the camera and the TV before connecting the mini-cable.

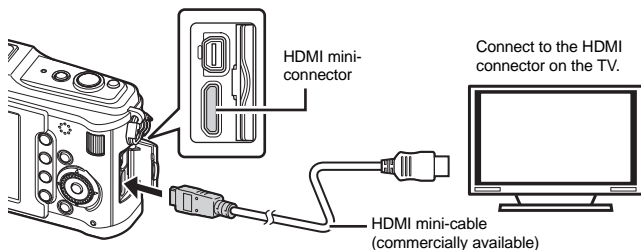

- 1 Connect the HDMI mini-cable to the HDMI connector of the TV.
- 2 Connect the HDMI mini-cable to the HDMI connector of the camera.
- 3 Turn on the TV and switch [INPUT] to [HDMI INPUT].
- 4 Turn on the camera.

! Notes

- For details on changing the input source of the TV, refer to the TV's instruction manual.
- Use an HDMI mini-cable that matches the HDMI mini connector on the camera and the HDMI connector on the TV.
- When the camera and TV are connected by both an AV cable and an HDMI mini-cable, HDMI will take priority.
- Depending on the TV's settings, the displayed images and information may become cropped.
- When you connect to a TV via an HDMI mini-cable, you can select the format of the digital video signal. "HDMI" (P. 102)
- You cannot shoot pictures or movies when the HDMI cable is connected.
- Do not connect the camera to other HDMI output devices. Doing so may damage the camera.
- HDMI output is not performed while connected via USB to a computer or printer.

Editing still images

Recorded images can be edited and saved as new images. Available editing functions depend on the image format (image record mode).

A JPEG file can be printed as is without modification. A RAW file, on the other hand cannot be printed as is. To print a RAW file, use the RAW edit function to convert the RAW data format to JPEG.

Editing images recorded in RAW data format

The camera performs image processing (such as white balance and sharpness adjustment) on images in the RAW data format, then saves the data to a new file in the JPEG format. While checking recorded images, you can edit them to your liking.

Image processing is performed based on the current camera settings. Change the camera settings to suit your preferences before editing.

Editing images recorded in JPEG data format

[SHADOW ADJ] Brightens a dark backlit subject.

[REDEYE FIX] Reduces the red-eye phenomenon during flash shooting.

[]

Set the trimming size with the main dial and the trimming position with the arrow pad.

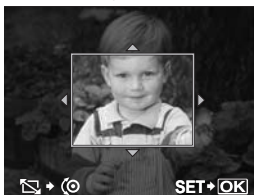

[ASPECT]

Changes the aspect ratio of images from 4:3 (standard) to **[3:2]**, **[16:9]**, or **[6:6]**. After changing the aspect ratio, use the arrow pad to specify the trimming position.

[BLACK & WHITE] Creates black and white images.

[SEPIA] Creates sepia-toned images.

[SATURATION] Sets the color depth. Adjust the color saturation checking the picture on the screen.

[]

Converts the image file size to 1280 x 960, 640 x 480, or 320 x 240. Images with an aspect ratio other than 4:3 (standard) are converted to the closest image file size.

[e-PORTRAIT]

Makes skin look smooth and translucent.

• You may not be able to compensate depending on the image if face detection fails.

1 MENU ▶ [] ▶ [EDIT] ▶ [SEL. IMAGE]

- Selection is also possible during playback by pressing the **[]** button.

2 Use **[]** to select an image, then press the **[]** button.

- The camera recognizes the image data format.
- For images recorded in JPEG+RAW, a selection screen will appear, asking you which data to edit.
- You cannot edit movies.

Confirm the data format from here.

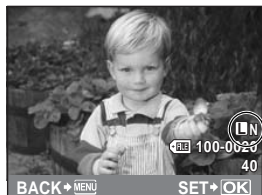

- 3** The setting screen varies with the image data format. Select the item you want to edit and do the following steps.

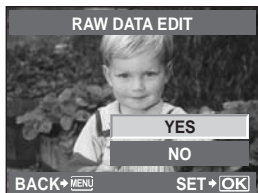
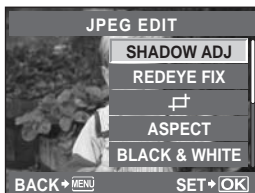

- The edited image is saved as another image, apart from the original image.
- To exit the edit mode, press the MENU button.

! Notes

- Red-eye correction may not work depending on the image. Red-eye correction may affect other parts of the image, as well as the eyes.
- Editing of a JPEG image is not possible in the following cases:
When an image is recorded in RAW, when an image is processed on a PC, when there is not enough space in the card memory, when an image is recorded on another camera.
- When resizing ([]) an image, you cannot select a larger number of pixels than was originally recorded.
- [] and [ASPECT] can only be used to edit images with an aspect ratio of 4:3 (standard).

Adding sound to still pictures

When playing back still pictures a maximum of 30 seconds of sound can be added (recorded) (you can add this as a memo after shooting pictures).

- 1** MENU ▶ [] ▶ [EDIT] ▶ [SEL. IMAGE] ▶ []

- Selection is also possible during playback by pressing the button.

- 2** Select using , then press the button.

- [NO] : No sound is recorded.
[START] : Audio recording starts.
[YES] : Erases added sound.

! Notes

- You cannot record sound for protected images.
- To stop recording part-way through, press the button.

Image overlay

Up to 3 frames of RAW images taken with the camera can be overlaid and saved as a separate image. The image is saved with the record mode set at the time the image is saved.

- 1** MENU ▶ [] ▶ [EDIT] ▶ [IMAGE OVERLAY]

- Selection is also possible during playback by pressing the button.

- 2** Select the number of frames to overlay and press the button.

3 Use to select a frame and press the button.

- Repeatedly select images only for the number of frames selected in Step 2.
- To cancel your selection, press the  button again.



4 Use to select an image, then use to select the gain for each image. Press the button.

- Select from 0.1 to 2.0.
- The displayed image changes as the gain is adjusted.

5 Use to select [YES], then press the button.

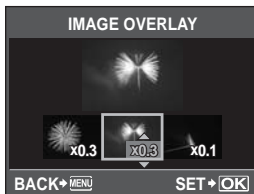

TIPS

To overlay 4 or more frames:

→ To overlay 4 or more frames, save the overlay image as a RAW file and use [IMAGE OVERLAY] repeatedly.

Notes

- When the record mode is set to [RAW], the overlay image is saved as [LN+RAW].
- When selecting a frame to overlay, the JPEG images for images recorded in JPEG+RAW are displayed.

Protecting images



7

Protect images you do not want to erase. Protected images cannot be erased by the single-frame or all-frame erase function.

Single-frame protect

Play back the image you want to protect and press the  button.

-  (protect mark) is displayed on the top right corner of the screen.





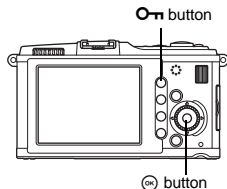

To cancel the protection

Display the images that are protected and press the  button.







Protecting selected frames

During index display you can select multiple images and protect them all at the same time.



- 1** During index display, select the images you want to protect using , then press the  button.
 - The selected images will be shown with .
 - To cancel your selection, press the  button again.
- 2** Press  to select the next images you want to protect, then press the  button.
- 3** After you have selected the images to protect, press the  button.

Canceling all protections

This function lets you cancel the protection of several images at one time.

- 1** MENU \blacktriangleright  \blacktriangleright [RESET PROTECT]
- 2** Use   to select [YES], then press the  button.

Notes



- Formatting the card erases all images even if they have been protected.
 "Formatting the card" (P. 130)
- Protected images cannot be rotated even when the  button is pressed.

Erasing images







Lets you erase recorded images. You can select single-frame erase, which erases only the currently displayed image; all-frame erase, which erases all the images stored on the card; or selected frame erase, which erases only the frames selected.

Notes

- When you perform all-frame or selected frame erase on images recorded using RAW+JPEG, both the RAW and JPEG images are erased. When using single-frame erase, you can select whether to erase the JPEG, RAW, or both RAW and JPEG images.  "RAW+JPEG ERASE" (P. 109)
- Protected images cannot be erased. Cancel protected images, then erase them.
- You cannot restore images which have been erased. Be careful not to erase important data.
 "Protecting images" (P. 91)





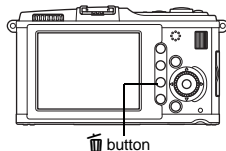



Single-frame erase

- 1 Display the images you want to erase and press the  button.
- 2 Use   to select [YES], then press the  button.











Erasing selected frames

During index display, you can select multiple images and erase them all at the same time.



- 1 Select the images you wish to erase on the index display, then press .
 - The selected images will be shown with .
 - To cancel your selection, press the  button again.
- 2 Press  to select the next images you want to protect, then press the  button.
- 3 After you have selected the images to erase, press the .
- 4 Use   to select [YES], then press the  button.

All-frame erase

- 1 MENU  [P]  [CARD SETUP]
- 2 Use   to select [ALL ERASE], then press the  button.
- 3 Use   to select [YES], then press the  button.
 - All frames will be erased.

TIPS

To erase immediately:

- If you have set "QUICK ERASE" ( P. 109) to [ON], pressing the  button will erase an image immediately.
- You can set the initial position of the cursor to [YES].  "PRIORITY SET" (P. 110)

Setup Menu

Use the Setup Menu to set the basic camera functions.

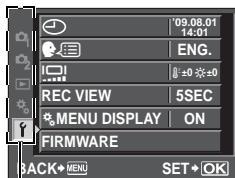

Use to select [f], then press .

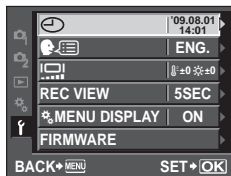

Use to select a function, then press .

For details on using the menu lists, see "Setting on the menu" (P. 24).

(Date/time setting)

P. 15

(Changing the display language)

You can change the language used for the on-screen display and error messages from ENGLISH to another language.

(Monitor brightness adjustment)

You can adjust the brightness and color temperature of the monitor. Color temperature adjustment will affect only the LCD monitor display during playback.

Use to switch between (color temperature) and (brightness), and use to adjust the value between [+7] - [-7].

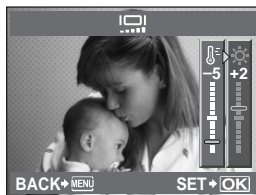

REC VIEW

You can display the picture you have just taken on the monitor while it is being recorded to the card, and to select how long the picture is displayed. This is useful for making a brief check of the picture you have just taken. Pressing the shutter button halfway while checking the picture lets you resume shooting immediately.

[1SEC] – [20SEC] Selects the number of seconds to display each picture. Can be set in units of 1 second.

[OFF] The picture being recorded to the card is not displayed.

[AUTO▶] Displays the image being recorded, and then switches to playback mode. This is useful for erasing a picture after checking it.

⌘ MENU DISPLAY

 P. 25

FIRMWARE

Your product's firmware version will be displayed.

When you make inquiries about your camera or accessories or when you want to download software, you will need to state which version of each of the products you are using.

Resetting the camera settings

In **P**, **A**, **S**, or **M** mode, current camera settings (including any changes you have made) are retained when the power is turned off. To reset the camera to the factory default settings, select **[RESET]**. You can register settings in advance to **[RESET1]** and **[RESET2]**. The camera settings at that time are registered in **[RESET1]** and **[RESET2]**. For details on the registered functions, refer to "Functions that can be registered with My Mode and Custom Reset Setting" (P. 141).

Registering **[RESET1]**/**[RESET2]**

Menu

MENU ▶ **[P]** ▶ **[CUSTOM RESET]**

- 1 Select either **[RESET1]**/**[RESET2]** to register and press **[OK]**.
 - If settings have already been registered, **[SET]** is displayed next to **[RESET1]**/**[RESET2]**. Selecting **[SET]** again overwrites the registered setting.
 - To cancel the registration, select **[RESET]**.
- 2 Select **[SET]** and press the **[OK]** button.

Using reset settings

This resets the camera to the factory default settings. You can also reset the camera to the **[RESET1]** or **[RESET2]** setting.

[RESET] Resets to the factory default settings. For the default settings, see "Menu directory" (P. 142).

[RESET1]/**[RESET2]** Resets to the registered settings.

Menu

MENU ▶ **[P]** ▶ **[CUSTOM RESET]**

- 1 Select **[RESET]**, **[RESET1]**, or **[RESET2]** and press the **[OK]** button.
- 2 Use **[Left]** **[Right]** to select **[YES]**, then press the **[OK]** button.

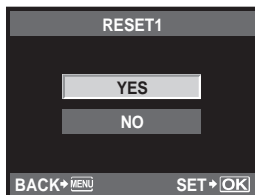

9 Customizing your camera

Use the Custom Menu to customize the shooting functions. The Custom Menu has 9 tabs (A to H) that are divided according to the functions to be set.

In the default setting, the Custom Menu is not displayed. To customize the functions, set [CUSTOM DISPLAY] in the Setup Menu to [ON] to display the Custom Menu. (P. 25)

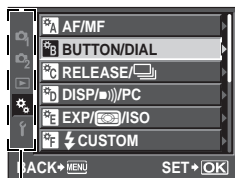

Use to select [CUSTOM], then press .

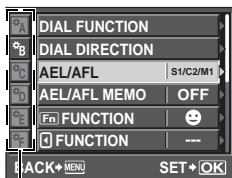

Use to select tab [DIAL FUNCTION], then press .

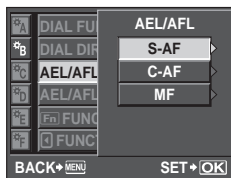

Use to select a function, then press .

For details on using the menu lists, see "Setting on the menu" (P. 24).

A AF/MF

AF MODE

P. 56

AF AREA

P. 58

[AF] SET UP

Selects the operations of dials or arrow pad when selecting the AF target.

[OFF] Stops after moving to the AF target on the end.

[LOOP] After moving to the AF target on the end, moves to the AF target on the opposite end of the same row or column. Selects all AF targets before moving to the AF target on the opposite end, and [AF AREA] is set to [:::].

[SPIRAL] After moving to the AF target on the end, moves to the AF target on the opposite end of the next row or column. Selects all AF targets before moving to the AF target on the opposite end, and [AF AREA] is set to [:::].

e.g.) When moving from the top left AF target to the right

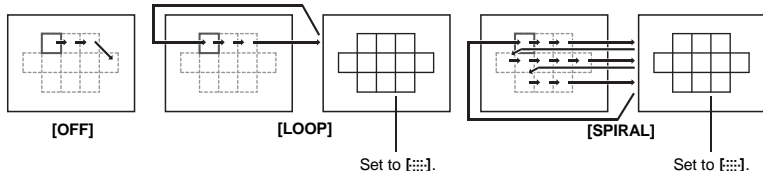

RESET LENS

When set to **[ON]**, this resets the focus of the lens (infinity) each time the power is turned off.

BULB FOCUSING

You can set the camera to enable focus adjustments during bulb shooting with MF.

[ON] During exposure, you can turn the focus ring and adjust the focus.

[OFF] The focus is locked during exposure.

FOCUS RING

You can customize how the lens adjusts to the focal point by selecting the rotational direction of the focus ring.

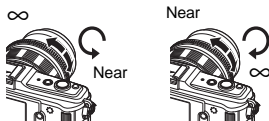

MF ASSIST

When **[AFMODE]** is set to **[S-AF+MF]** or **[MF]**, turn the focus ring for automatic zoom display.

FUNCTION BUTTON/DIAL

DIAL FUNCTION

In **P**, **A**, **S**, or **M** mode, you can assign functions other than the default functions to the main dial and sub dial. You can also switch the operations of the main dial and sub dial for menu operations with the default operations.

P : [Ps]/[Z]/[Z]
A : [FNo.]/[Z]/[Z]
S : [SHUTTER]/[Z]/[Z]
M : [SHUTTER]/[FNo.]
MENU : [L/R]/[D / VALUE]

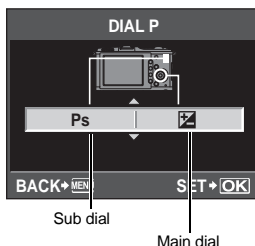

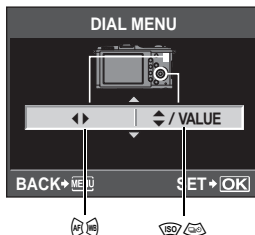

- In **[MENU]**, **[L/R]** indicates dial operations corresponding to horizontal direction (L/R) operations. **[D / VALUE]** indicates dial operations corresponding to vertical direction (D / VALUE) operations.



DIAL DIRECTION

You can select the rotational direction of the dial and the direction in which the shutter speed/aperture value will increase or decrease.

Setting	 (rotational direction of the dial)	 (rotational direction of the dial)
DIAL1	<ul style="list-style-type: none"> Slower shutter speed Open the aperture (f-number is decreased) 	<ul style="list-style-type: none"> Faster shutter speed Close the aperture (f-number is increased)
DIAL2	<ul style="list-style-type: none"> Faster shutter speed Close the aperture (f-number is increased) 	<ul style="list-style-type: none"> Slower shutter speed Open the aperture (f-number is decreased)

AEL/AFL

You can use the AEL/AFL button to perform AF or metering operations instead of using the shutter button.

Select the function of the button to match the operation when the shutter button is pressed. Select **[mode1]** to **[mode4]** in each focus mode. (You can only select **[mode4]** in C-AF mode.)

Mode	Shutter button function				AEL/AFL button function	
	Half-press		Full press		When holding down AEL/AFL	
	Focus	Exposure	Focus	Exposure	Focus	Exposure
[S-AF]						
mode1	S-AF	Locked	—	—	—	Locked
mode2	S-AF	—	—	Locked	—	Locked
mode3	—	Locked	—	—	S-AF	—
[C-AF]						
mode1	C-AF start	Locked	Locked	—	—	Locked
mode2	C-AF start	—	Locked	Locked	—	Locked
mode3	—	Locked	Locked	—	C-AF start	—
mode4	—	—	Locked	Locked	C-AF start	—
[MF]						
mode1	—	Locked	—	—	—	Locked
mode2	—	—	—	Locked	—	Locked
mode3	—	Locked	—	—	S-AF	—

Basic operations

- [mode1]** For determining the metered exposure while focusing. AE lock is activated while pressing the AEL/AFL button, allowing you to adjust the focus and determine the exposure separately.
- [mode2]** For determining the exposure when you press the shutter button fully. This is useful for shooting scenes with significant changes in lighting, such as on a stage.
- [mode3]** For focusing with the AEL/AFL button instead of the shutter button.
- [mode4]** Press the AEL/AFL button to focus, and press the shutter button fully to determine the exposure.

You can lock and maintain the exposure by pressing the AEL/AFL button.

[ON] Press the AEL/AFL button to lock and maintain the exposure. Press again to cancel the maintaining of the exposure.

[OFF] The exposure will be locked only while the AEL/AFL button is pressed.

Fn FUNCTION

You can assign a function to the **Fn** button.

[Fn FACE DETECT]

Press the **Fn** button to set **[☺ FACE DETECT]** to **[ON]** and activate the optimal settings. Press again to set it to **[OFF]**.

 "Using the face detection function" (P. 39), "☺ FACE DETECT" (P. 104)

[PREVIEW] (electronic)

While holding down the **Fn** button, you can use the preview function.

 "Preview function" (P. 48)



Press the **Fn** button to acquire the WB value.

 "Setting the one-touch white balance" (P. 69)

[HOME]

Press the **Fn** button to switch to the registered AF home position. Press the button again to switch to the original AF target mode. If you turn off the camera while it is set to the AF home position, the original position will not be stored.

 "Registering an AF target mode" (P. 59)

[MF]

Press the **Fn** button to switch AF mode to **[MF]**. Press the button again to switch to the original AF mode.

[RAW <->]

Press the **Fn** button to switch from JPEG to JPEG+RAW or from JPEG+RAW to JPEG for the record mode.

You can change the record mode by turning the sub dial while holding down the **Fn** button.

[TEST PICTURE]

Pressing the shutter button while pressing the **Fn** button enables you to check the picture you have just taken on the monitor without having to record the picture to the card. This is useful when you want to see how a picture turned out without saving it.

[MY MODE]

While holding down the **Fn** button, you can take pictures using the camera settings registered in the **[MY MODE SETUP]**.

 "MY MODE SETUP" (P. 101)

[BACKLIT LCD]

Press the **Fn** button to turn the LCD monitor off. This function is useful when you are using the optional optical viewfinder. Press the **Fn** button again to turn the LCD monitor on.

[OFF]

Does not allow function allocation.

4 FUNCTION

Other functions can be assigned to the **4** button.

[AF MODE]

"AF mode selection" (P. 56)

[METERING]

"Changing the metering mode" (P. 49)

[FLASH MODE]

"Flash shooting" (P. 73)

[BACKLIT LCD]

"[Fn] FUNCTION" (P. 100)

[IMAGE STABILIZER]

"Image stabilizer" (P. 62)

MY MODE SETUP

You can store two frequently used settings as My Mode. You can select which My Mode setting to use in advance by following the steps under "Executing" below. To use My Mode, set **[Fn FUNCTION]** to **[MY MODE]** and hold down the **Fn** button while shooting. "[Fn FUNCTION]" (P. 100)

Registering

- 1) Select **[MY MODE1]** or **[MY MODE2]** and press .
- 2) Select **[SET]** and press the button.
 - The current settings are registered in the camera. For details on the functions that can be registered to My Mode, refer to "Functions that can be registered with My Mode and Custom Reset Setting" (P. 141).
 - To cancel the registration, select **[RESET]**.

Executing

- 1) Select **[MY MODE1]** or **[MY MODE2]** and press the button.
- 2) Select **[YES]** and press the button.
 - The selected My Mode is set.
 - When shooting, press the shutter button while holding down the **Fn** button.

BUTTON TIMER

The direct button may remain selected even after it is released.

[OFF]

Do not retain selection.

[3SEC]/[5SEC]/[8SEC]

The button remains selected during the number of seconds indicated.

[HOLD]

The button remains selected until you press it again.

- Buttons that can be set with **[BUTTON TIMER]**
ISO, , WB, AF,



You can switch the functions of the AEL/AFL button and the **Fn** button. When you select **[ON]**, the AEL/AFL button will function as the **Fn** button, and the **Fn** button will function as the AEL/AFL button.

FUNCTION

You can set the function of the arrow pad.

[OFF] To prevent malfunction, the functions assigned to the arrow pad will not be activated when the button is pressed.

[ON] The functions assigned to the arrow pad will be activated.

[] You can use the arrow pad to select the position of the AF target. Selection is possible after the shutter button is pressed halfway and released.

"Selecting the AF target mode and position" (P. 59)

RELEASE/

RLS PRIORITY S/RLS PRIORITY C

In this camera, the shutter does usually not work during AF. However, by applying this setting you can work the shutter before AF is completed. If you want to release the shutter without waiting until these operations have completed, use the setting below. You can set the release priority individually in AF mode.

RLS PRIORITY S Sets release priority for S-AF mode (P. 56).

RLS PRIORITY C Sets release priority for C-AF mode (P. 57).

DISP//PC

HDMI

Selecting the digital video signal format for connecting to a TV via an HDMI mini-cable.

[1080i] Play back in 1080i format.

[720p] Play back in 720p format.

[480p/576p] Play back in 480p/576p format (when **[VIDEO OUT]** is set to **[PAL]**, play back in 576p format).



Notes

- When set to **[1080i]**, 1080i format takes priority for HDMI output. However, if this setting does not match the input setting of the TV, the resolution is changed first to 720p and then to 480p. For details on changing the input setting of the TV, refer to the TV's instruction manual.

VIDEO OUT

You can select NTSC or PAL according to your TV's video signal type.

You will need to set this when you want to connect the camera to a TV and play back images in a foreign country. Make sure the correct video signal type is selected before connecting the video cable. If you use the wrong video signal type, recorded pictures will not play back properly on your TV.

TV video signal types in major countries and regions

Check the video signal type before connecting the camera to your TV.

NTSC	North America, Japan, Taiwan, Korea
PAL	European countries, China

■)))



When set to **[OFF]**, you can turn off the beep sound that is emitted when the focus locks by pressing the shutter button.

SLEEP

After a specified period of time elapses with no operations being performed, the camera enters the sleep mode (stand-by) to save battery power. **[SLEEP]** lets you select sleep timer from **[1MIN]**, **[3MIN]**, **[5MIN]**, or **[10MIN]**. **[OFF]** cancels the sleep mode.

The camera activates again as soon as you touch any button (the shutter button,  button, etc.).

USB MODE

You can connect the camera directly to a computer or printer with the provided USB cable. If you specify the device you are connecting to beforehand, you can skip the USB connection setting procedure normally required every time you connect the cable to the camera. For details on how to connect the camera to either device, refer to "Connecting the camera to a printer" ( P. 115) and "Connecting the camera to a computer" ( P. 120).

[AUTO]

The selection screen for the USB connection will be displayed every time you connect the cable to a computer or printer.

[STORAGE]

Allows you to transfer images to a computer. Also, select to use the OLYMPUS Master software via PC connection.

[MTP]

Allows you to transfer images to a computer running Windows Vista without using the OLYMPUS Master software.

[PRINT]

Can be set when connecting the camera to a PictBridge-compatible printer. You can print out pictures with set number of prints, print paper and other settings.

 "Connecting the camera to a printer" (P. 115)

LIVE VIEW BOOST

During live view shooting, you can brighten the monitor for easier confirmation on the subject.
[OFF]

The subject is displayed on the monitor with the brightness level that is adjusted according to the exposure being set. You can shoot while confirming through the monitor in advance to get a picture that is to your liking.

[ON]

The camera automatically adjusts the brightness level and displays the subject on the monitor for easier confirmation. The effect of the exposure compensation adjustments will not be reflected on the monitor.



☹ FACE DETECT





When set to **[ON]**, the camera will detect people's faces and automatically adjust the focus there.  "Using the face detection function" (P. 39)

You can play back close-up images focusing on the subject's face.  "Single-frame/Close-up playback" (P. 81)

INFO SETTING

Select the information displayed when the INFO button is pressed during live view or playback.

[▶ INFO] Sets whether to display or hide **[IMAGE ONLY]**, **[OVERALL]**, , **[HIGHLIGHT&SHADOW]** during playback.  "Information display" (P. 83)

[LV-INFO] Sets whether to display or hide , **[ZOOM]**, **[MULTI VIEW]**, **[IMAGE ONLY]**, , , or  during live view.  "Switching the information display" (P. 41)

VOLUME

You can adjust the speaker volume from 0 to 5.

SETUP

Setting the playback method during slideshow playback.

[SLIDE INTERVAL] Sets interval at which to switch images from 2 – 10 seconds.

[MOVIE INTERVAL] When playing a movie, select **[FULL]** to play the entire movie, or **[SHORT]** to play to a section part-way through.

9

LEVEL GAUGE

Detect tilting horizontally and in the forward and backward direction when **[LEVEL GAUGE]** is set to **[ON]**. Use this as a guide in situations where you cannot determine whether the camera is level, such as when you cannot see the horizon or skyline on the screen or when the screen is dark while shooting night scenes.

Monitor indication:

Press the INFO button repeatedly to display the level gauge.  "Switching the information display" (P. 41)

TIPS

To calibrate the level gauge:

→  "LEVEL ADJUST" (P. 111)

! Notes

- If the camera is tilted forward or backward to a large degree, the error of the horizontal titling increases.



Displayed when the display range is exceeded.

MOVIE

Set to [ON] to record sound when shooting movies.

EXP//ISO

EV STEP

You can select the EV step for exposure parameter setting, such as shutter speed, aperture value, or exposure compensation value, from [1/3EV], [1/2EV], or [1EV].

METERING

 P. 49

AEL Metering

You can set the metering mode when pressing the AEL/AFL button to lock the exposure.

- [AUTO] performs metering in the mode selected under [METERING].

ISO

 P. 53

ISO STEP

You can select the EV step of the ISO sensitivity from [1/3EV] or [1EV].

ISO-AUTO SET

You can set the upper limit and default ISO values when ISO is set to [AUTO].

[HIGH LIMIT]

This sets the upper limit of the ISO value that automatically changes. The upper limit can be set from 200 to 6400 in 1/3 EV increments.

[DEFAULT]

This sets the value to be normally used when the optimum exposure can be obtained. The value can be set from 200 to 6400 in 1/3 EV increments.

ISO-AUTO

You can set the shooting mode in which the ISO **[AUTO]** setting is activated.

[P/A/S]

The **[AUTO]** setting is activated in all shooting modes except **M** mode. When **[AUTO]** is selected in **M** mode, ISO 200 is set.

[ALL]

The **[AUTO]** setting is activated for all shooting modes. The ISO is automatically selected to obtain the optimal ISO even in **M** mode.

BULB TIMER

You can select the maximum time (in minutes) for bulb shooting.

ANTI-SHOCK

You can select the interval between fully pressing the shutter button and releasing the shutter to be anywhere from 1/8 to 30 seconds.

This diminishes camera shake caused by vibrations. This feature is useful in situations such as microscope photography and astrophotography.



Notes

- Anti-shock is added to the shooting functions individually (single-frame shooting, sequential shooting and self-timer shooting). "Sequential shooting" (P. 61)

BRACKETING

The camera automatically shoots a number of pictures at different exposure values for each frame.

[AE BKT] P. 52

[WB BKT] P. 70

[FL BKT] P. 77

[ISO BKT] P. 54



CUSTOM

FLASH MODE

P. 75

9



P. 77

X-SYNC.

You can set the shutter speed that will be used when the flash fires. The speed can be set from 1/60 to 1/180 in 1/3 EV increments.

SLOW LIMIT

You can set the slow limit of the shutter speed that will be used when the flash fires. The speed can be set from 1/30 to 1/180 in 1/3 EV increments.



When set to **[ON]**, it will be added to the exposure compensation value and flash intensity control will be performed.

← /COLOR/WB

NOISE REDUCT.

This function reduces the noise that is generated during long exposures. When shooting night scenes, shutter speeds are slower and noise tends to appear in images. With **[NOISE REDUCT.]**, you can let the camera reduce noise automatically to produce clearer images. When set to **[AUTO]**, noise reduction will be activated only when the shutter speed is slow. When set to **[ON]**, noise reduction will always be activated.

When set to **[OFF]**



When set to **[ON]** or **[AUTO]**

- While noise reduction is activated, it takes about twice the usual time to take a picture.
- The noise-reduction process is activated after shooting.
- During processing the card access lamp blinks. You cannot take more pictures until the card access lamp turns off.

Notes

- During sequential shooting, **[NOISE REDUCT.]** is **[OFF]** automatically.
- This function may not work effectively with some shooting conditions or subjects.

NOISE FILTER

You can select the noise processing level. Use **[STANDARD]** for general use. **[HIGH]** is recommended during high sensitivity shooting.

WB

 P. 67

ALL

You can apply the same compensation value to all the white balance modes at once.

[ALL SET]

The same compensation value applies to all WB modes.



[ALL RESET]

The WB compensation value settings applied to each WB mode are all cleared at once.

If you select [ALL SET]

1) Use  to select the color direction.

Toward A: Amber-Blue/Toward G: Green-Magenta

2) Use  to set the compensation value.  "WB compensation" (P. 68)

Releasing the AEL/AFL button takes a sample image. You can check the white balance you have adjusted.

If you select [ALL RESET]

1) Use  to select [YES].

COLOR SPACE

You can select how colors are reproduced on the monitor or printer. The first character in image file names indicates the current color space.

 "FILE NAME" (P. 109)

Pmdd0000.jpg

[sRGB]

Standardized color space for Windows.

└─ P : sRGB

[Adobe RGB]

Color space that can be set with Adobe Photoshop.

└─ _ : Adobe RGB

SHADING COMP.

In some cases, the edges of the image may be shadowed due to the properties of the lens. The shading compensation function compensates by increasing brightness at the dark edge of the image. This function is especially useful when a wide-angle lens is used.

Notes

- This function is not available when a teleconverter or an extension tube is attached to the camera.
- At higher ISO settings, noise in image edges may be conspicuous.

SET

You can combine 3 image sizes and 4 compression rates and register 4 combinations with .

 "Selecting the record mode" (P. 64)

Register 4 different combinations of image settings.

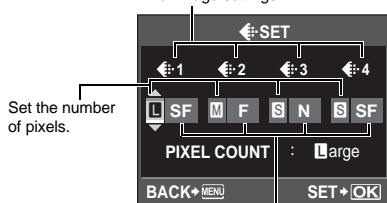

PIXEL COUNT

You can set the pixel size for the image size **[M]** and **[S]**.

[Middle] Select **[3200 x 2400]**, **[2560 x 1920]**, or **[1600 x 1200]**.

[Small] Select **[1280 x 960]**, **[1024 x 768]**, or **[640 x 480]**.

RECORD/ERASE

QUICK ERASE

You can erase the picture you have just taken immediately using the **[Erase]** button.

[OFF] When the **[Erase]** button is pressed, the confirmation screen appears, asking you if you want to erase the picture.

[ON] Pressing the **[Erase]** button erases the picture immediately.

RAW+JPEG ERASE

You can select the method to erase images recorded in RAW+JPEG. This function can only be used to erase one frame.

[JPEG] Erases all JPEG image files, leaving only the RAW image files.

[RAW] Erases all RAW image files, leaving only the JPEG image files.

[RAW+JPEG] Erases both image file types.

Notes

- This function is effective only if deleting one frame. For all-frame erase or erasing selected frames, both RAW and JPEG will be erased regardless of this setting.

FILE NAME

When you take a picture, the camera assigns it a unique file name and saves it in a folder. File names are assigned as shown in the illustration below.

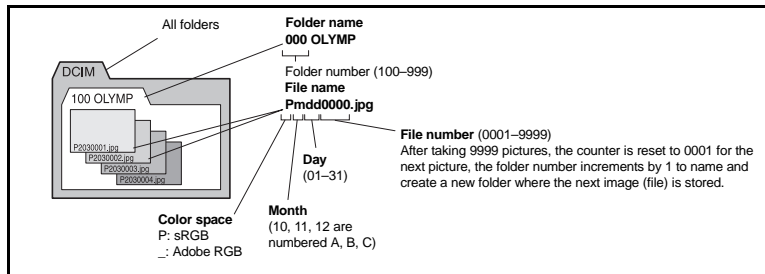

[AUTO]

Even when a new card is inserted, the folder numbers are retained from the previous card. If the new card contains an image file whose file number coincides with one saved on the previous card, the new card's file numbers start at the number following the highest number on the previous card.

[RESET]

When you insert a new card, the folder numbers starts at 100 and the file name starts at 0001. If a card containing images is inserted, the file numbers start at the number following the highest file number on the card.

EDIT FILENAME

You can rename image files to make them easier to identify and organize.

The portion of the filename that can be changed depends on the color space.  "COLOR SPACE" (P. 108)

sRGB : Pmdd0000.jpg AdobeRGB : _mdd0000.jpg

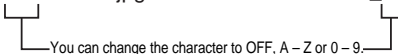

You can change the character to OFF, A - Z or 0 - 9.

PRIORITY SET

You can customize the initial position of the cursor (**[YES]** or **[NO]**) on the Erasing images or Formatting the card screen.

dpi SETTING

You can set the resolution for printing images in advance. The set value is recorded on the card with the images.

[AUTO]

Automatically set according to the image size.

[CUSTOM]

You can make the desired setting. Press  to display the setting screen.

UTILITY

PIXEL MAPPING

 P. 129

9

EXPOSURE SHIFT

You can adjust the default value for optimal exposure for each metering mode according to your preference. This can be set in 1/6 EV increments ranging from -1.0 EV to +1.0 EV.

Notes

- The exposure compensation can be set from -3.0 EV to +3.0 EV. Setting **[EXPOSURE SHIFT]** reduces the range of the direction in which the default value is adjusted.
- You cannot check the exposure shift value during shooting. To make normal adjustments to the exposure, perform exposure compensation.  "Exposure compensation" (P. 50)

WARNING LEVEL

You can change the timing when  is displayed (lights up). Normally, there is no need to change this.

 "LCD monitor (Live view)" (P. 8)

Notes

- The battery check display is not a warning that the battery needs to be charged. When  blinks, charge the battery.

LEVEL ADJUST

You can calibrate the level gauge.

[RESET] Resets to the factory default adjustment value.

[ADJUST] Sets the current camera position as the zero point.

Notes

- Set **[ADJUST]** only when the camera is secured in a horizontal position. If the camera is not in a stable position, you may not be able to calibrate the level gauge as desired.

Print reservation (DPOF)



Print reservation

Print reservation allows you to save printing data (the number of prints and the date/time information) with the pictures stored on the card.

Pictures set with print reservation can be printed using the following methods.

DPOF (Digital Print Order Format)

This is for saving desired print settings on digital cameras. By entering which images to print and the number of copies of each, the user can easily have the desired images printed by a printer or print lab that supports the DPOF format.

Printing using a DPOF-compatible photo lab

You can print the pictures using the print reservation data.

Printing using a DPOF-compatible printer

Pictures can be printed directly from a dedicated printer without using a PC. For more details, refer to the printer's manual. A PC card adapter may also be necessary.

! Notes

- DPOF reservations set by another device cannot be changed by this camera. Make changes using the original device. Moreover, setting new DPOF reservations using this camera will erase the previous reservations set by another device.
- Not all functions may be available on all printers or at all photo labs.
- Print reservation is not available for RAW data.
- Print reservation is not available for movie images.

Single-frame reservation

Follow the operation guide to set print reservation for a picture.

- MENU** ▶ ▶
 - Selection is also possible during playback by pressing the button.

- Select and press the button.

- Press to select the frame that you want to set as print reservation, then press to set the number of prints.
 - To set print reservation for several pictures, repeat this step.

- Press the button when you have finished.
 - The menu screen for single-frame reservation appears.

- Select the date and time format and press the button.
 - [NO]** The pictures are printed without the date and time.
 - [DATE]** The pictures are printed with the shooting date.
 - [TIME]** The pictures are printed with the shooting time.

- Select **[SET]** and press the button.

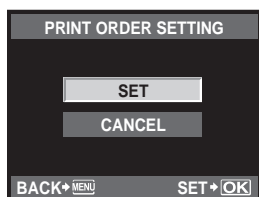
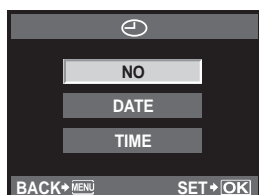
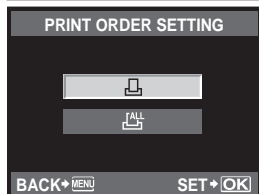

All-frame reservation

Applies print reservation to all the pictures stored in the card. The number of prints is fixed at 1.

- 1 MENU ▶ [▶] ▶ [📄]
- 2 Select [ALL] and press the **OK** button.
- 3 Select the date and time format and press the **OK** button.
[NO] The pictures are printed without the date and time.
[DATE] The pictures are printed with the shooting date.
[TIME] The pictures are printed with the shooting time.
- 4 Select [SET] and press the **OK** button.

Resetting the print reservation data

You can reset all print reservation data or just the data for selected pictures.

- 1 MENU ▶ [▶] ▶ [📄]

Resetting the print reservation data for all pictures

- 2 Select [📄] or [ALL] and press the **OK** button.
- 3 Select [RESET] and press the **OK** button.



Resetting the print reservation data for a selected picture

- 2 Select [📄] and press the **OK** button.
- 3 Select [KEEP] and press the **OK** button.
- 4 Use **▲** **▶** **◀** **▼** to select the frame with print reservation data you want to reset, then press **0** to set the number of prints to 0.
- 5 Press the **OK** button when you have finished.
- 6 Select the date and time format and press the **OK** button.
• This setting is applied to all frames with print reservation data.
- 7 Select [SET] and press the **OK** button.

Direct printing (PictBridge)



By connecting the camera to a PictBridge-compatible printer with the USB cable, you can print out recorded pictures directly. To find out if your printer is compatible with PictBridge, refer to the printer's manual.

PictBridge

The standard that enables digital cameras and printers made by different manufacturers to be connected, and also allows pictures to be printed directly from the camera.

STANDARD

All printers that support PictBridge have standard print settings. By selecting **[PictBridge STANDARD]** on the settings screens (P. 117), you can print pictures according to these settings. For details on your printer's standard settings, refer to the printer's manual or contact the printer manufacturer.

- The available print modes and settings such as paper size vary with the type of printer. For details, refer to the printer's manual.
- For details on printing paper types, ink cassettes, etc., refer to the printer's manual.



Notes

- Use a fully charged battery for printing.
- Images recorded in RAW data cannot be printed.
- You cannot print movie images.
- The camera will not enter sleep mode while it is connected to the USB cable.

Connecting the camera to a printer

Use the provided USB cable to connect the camera to a PictBridge-compatible printer.

1 Turn the printer on and connect the camera's multi-connector to the printer's USB port with the USB cable.

- For details on how to turn the printer on and the position of the USB port, refer to the printer's manual.

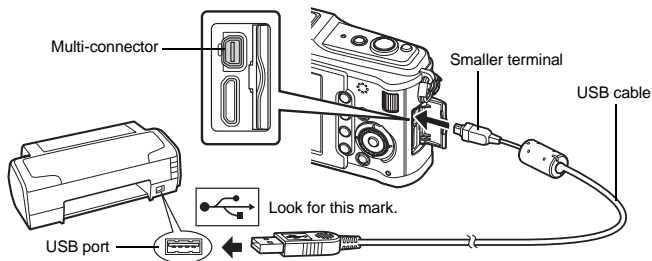

2 Turn on the camera.

- The selection screen for the USB connection is displayed.

3 Use to select [PRINT].

- [ONE MOMENT] is displayed and the camera and printer are connected.

Go to "Custom printing" ( P. 116).

! Notes

- If the screen is not displayed after a few minutes, disconnect the USB Cable and start again from Step 1.

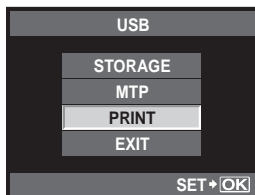



Easy printing

1 Use to display the pictures you want to print on the camera.

- Display the image you want to print on the camera and connect the camera with a printer using a USB cable. The screen on the right appears shortly.

2 Press .

- The picture selection screen appears when printing is completed. To print another picture, use   to select the image and press the  button.
- To exit, unplug the USB cable from the camera while the picture selection screen is displayed.

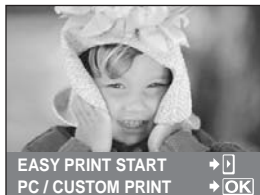

Custom printing

1 Follow the operation guide to set a print option.

Selecting the print mode

Select the type of printing (print mode). The available print modes are as shown below.

[PRINT]	Prints selected pictures.
[ALL PRINT]	Prints all the pictures stored in the card and makes one print for each picture.
[MULTI PRINT]	Prints multiple copies of one image in separate frames on a single sheet.
[ALL INDEX]	Prints an index of all the pictures stored in the card.
[PRINT ORDER]	Prints according to the print reservation you made. If there is no picture with print reservation, this is not available. ( P. 113)

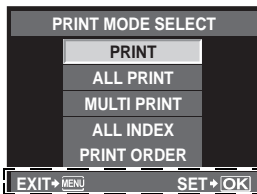

Follow the operation guide displayed here.

Setting the print paper items

This setting varies with the type of printer. If only the printer's STANDARD setting is available, you cannot change the setting.

- [SIZE]** Sets the paper size that the printer supports.
- [BORDERLESS]** Selects whether the picture is printed on the entire page or inside a blank frame.

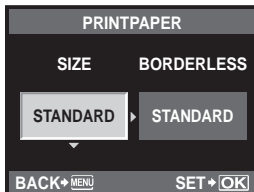

- [PICS/SHEET]** Selects the number of pictures per sheet. Displayed when you have selected **[MULTI PRINT]**.

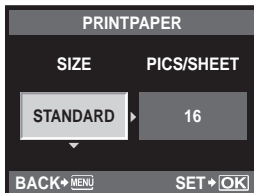

Selecting pictures you want to print

Select pictures you want to print. The selected pictures can be printed later (single-frame reservation) or the picture you are displaying can be printed right away.

- [PRINT]** (OK) Prints the currently displayed picture. If there is a picture that **[SINGLE PRINT]** reservation has already been applied to, only that reserved picture will be printed.
- [SINGLE PRINT]** (⏏) Applies print reservation to the currently displayed picture. If you want to apply reservation to other pictures after applying **[SINGLE PRINT]**, use (⏏) to select them.
- [MORE]** (⏏) Sets the number of prints and other items for the currently displayed picture, and whether or not to print it.
For operation, refer to "Setting printing data" (P. 118) in the next section.



Setting printing data

Select whether to print printing data such as the date and time or file name on the picture when printing. When the print mode is set to **[ALL PRINT]** and **[OPTION SET]** is selected, the following screen appears.

- [x]** Sets the number of prints.
[DATE] Prints the date and time recorded on the picture.
[FILE NAME] Prints the file name recorded on the picture.
[Trims the picture for printing. Set the trimming size with the main dial and the trimming position with the arrow pad.

2 Once you have set the pictures for printing and printing data, select **[PRINT]**, then press the button.

- [PRINT]** Transfers images you print to the printer.
[CANCEL] Resets the settings. All print reservation data will be lost. If you want to keep the print reservation data and make other settings, press the MENU button. This returns you to the previous setting.

- To stop and cancel printing, press the button.

- [CONTINUE]** Continues printing.
[CANCEL] Cancels printing. All print reservation data will be lost.

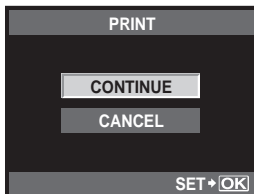
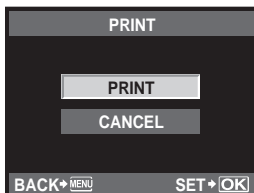
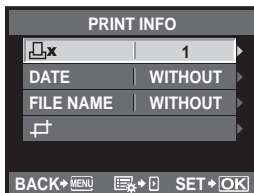

Flowchart

Just connect the camera to a computer with the USB cable and you can easily transfer images stored on the card to the computer with the provided OLYMPUS Master software.

Things to prepare

- OLYMPUS Master 2 CD-ROM
- USB cable
- Computer that fulfills the operating environment
(For the required operating environment, refer to the OLYMPUS Master installation guide.)

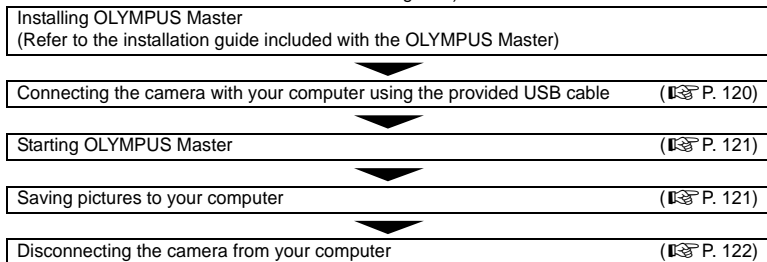

Using the provided OLYMPUS Master software

What is OLYMPUS Master?

OLYMPUS Master is an image management program with viewing and editing features for pictures taken with your digital camera. Once installed on your computer, you can take advantage of the following.

- **Transferring images from the camera or removable media to your computer**
- **Viewing images**
You can also enjoy slideshows and sound playback.
- **Grouping and organizing images**
You can organize images into albums or folders. Transferred images are automatically organized by shooting date, allowing you to quickly find the particular images you want.
- **Correcting images using filter and correction functions**
- **Editing images**
You can rotate, trim or change the image size.
- **A variety of printing formats**
You can easily make prints of your pictures.
- **Updating the camera firmware**
- **Developing RAW images**

For information about OLYMPUS Master's other features, as well as for details on how to use the software, refer to "Help" in OLYMPUS Master software.

Connecting the camera to a computer

Connect the camera to your computer with the provided USB cable.

1 Use the provided USB cable to connect the computer's USB port to the camera's multi-connector.

- The location of the USB port varies with the computer. For details, refer to your computer's manual.

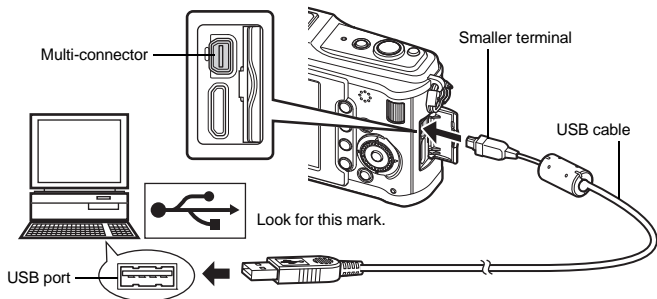

2 Turn on the camera.

- The selection screen for the USB connection is displayed.

3 Press $\left[\text{ISO} \right]$ $\left[\text{Fn} \right]$ to select [STORAGE]. Press the $\left[\text{OK} \right]$ button.

4 The computer recognizes the camera as a new device.

Windows

- When you connect the camera to the computer for the first time, the computer automatically recognizes the camera. Click "OK" when the message saying that the installation is completed appears. The computer recognizes the camera as a "Removable Disk .

Macintosh

- iPhoto is the default image management application for Mac OS. When you connect your Olympus digital camera for the first time, iPhoto will start up automatically. Close iPhoto and start OLYMPUS Master.

! Notes

- When the camera is connected to the computer, none of the camera buttons are functional.

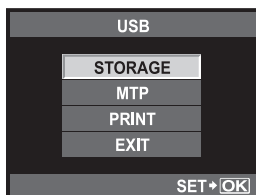

Start up the OLYMPUS Master software

Windows

- 1 Double-click the “OLYMPUS Master 2” icon  on the desktop.

Macintosh



- 1 Double-click the “OLYMPUS Master 2” icon  in the “OLYMPUS Master 2” folder.
 - The browse window is displayed.
 - When OLYMPUS Master is started up for the first time after installation, the OLYMPUS Master initial setting screen and user registration screen are displayed before the browse window. Follow the on-screen instructions.

To exit OLYMPUS Master

- 1 Click “Exit”  on any window.
 - OLYMPUS Master is exited.

Displaying camera images on a computer

Downloading and saving images

- 1 Click “Transfer Images”  on the browse window, and then click “From Camera” .
 - The window for selecting the pictures you want to transfer from the camera is displayed. All the images in the camera are displayed.

- 2 Select “New Album” and enter an album name.
- 3 Select the image files and click “Transfer Images”.
 - A window indicating that the download is complete is displayed.

- 4 Click “Browse images now”.
 - The downloaded images are displayed in the browse window.



Disconnecting the camera from your computer

- 1 Make sure that the card access lamp has stopped blinking.

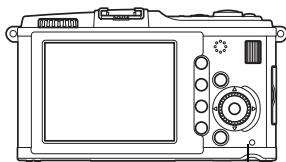

Card access lamp

- 2 Prepare to remove the USB cable.

Windows

- 1) In the system tray, click the "Unplug or Eject Hardware" icon.
- 2) Click on the pop-up message.
- 3) Click "OK" on the "Safe to Remove Hardware" window.

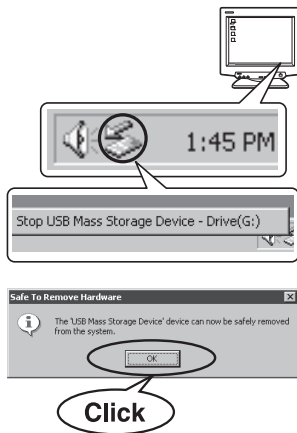

Macintosh

- 1) The trash icon changes to the eject icon when the "Untitled" or "NO_NAME" icon on the desktop is dragged. Drag and drop it on the eject icon.

- 3 Unplug the USB cable from the camera.

Notes

- For Windows users:
When you click "Unplug or Eject Hardware", a warning message may be displayed. In such case, make sure that no image data is being downloaded from the camera, and that there are no applications open that were accessing the camera image files. Close any such applications and click "Unplug or Eject Hardware" again and then remove the cable.



Viewing still images

- 1 Click the "Album" tab on the browse window and select the album that you want to view.
 - The selected album image is displayed in the thumbnail area.
- 2 Double-click the still picture thumbnail that you want to view.
 - OLYMPUS Master switches to the image edit window and the picture is enlarged.
 - Click "Back"  to return to the browse window.



Transferring images to your computer without using OLYMPUS Master

Your camera supports the USB Mass Storage Class. You can transfer images to a computer by connecting the camera to the computer with the provided USB cable. This can be done even without using OLYMPUS Master. The following operating systems are compatible with the USB connection:

Windows : 2000 Professional/XP Home Edition/XP Professional/Vista

Macintosh : Mac OS X v10.3 or later

! Notes

- If your computer is running Windows Vista, select **[MTP]** in Step 3 on page 120 to use Windows Photo Gallery.
- Data transfer is not guaranteed in the following environments, even if your computer is equipped with a USB port.
 - Computers with a USB port added by means of an extension card, etc.
 - Computers without a factory-installed OS and home-built computers

Shooting tips and information

The camera does not turn on even when a battery is loaded

The battery is not fully charged

- Charge the battery with the charger.

The battery is temporarily unable to function because of the cold

- Battery performance declines in low temperatures, and the charge may not be sufficient to turn on the camera. Remove the battery and warm it by putting it in your pocket for a while.

No picture is taken when the shutter button is pressed

The camera has turned off automatically

- To save battery power, if there is no operation, the camera goes into sleep mode after a fixed period of time and the camera stops operating. The camera activates again when you touch the shutter button or any other button.  "SLEEP" (P. 103)
After a further fixed period of time has elapsed, the camera power turns off.

The flash is charging

- On the LCD monitor, the  mark blinks when charging is in progress. Wait for the blinking to stop, then press the shutter button.

Unable to focus

- When the AF confirmation mark on the LCD monitor is blinking, it indicates that the camera is unable to focus using AF. Press the shutter button again.

Noise reduction is activated

- When shooting night scenes, shutter speeds are slower and noise tends to appear in images. The camera activates the noise-reduction process after shooting at slow shutter speeds. During which, shooting is not allowed. You can set [NOISE REDUCT.] to [OFF].
 "NOISE REDUCT." (P. 107)

The date and time has not been set

The camera is used with the settings at the time of purchase

- The date and time of the camera is not set when purchased. Set the date and time before using the camera.  "Setting the date/time" (P. 15)

The battery has been removed from the camera

- The date and time settings will be returned to the factory default settings if the camera is left without the battery for approximately 1 day. The settings will be cancelled more quickly if the battery was only loaded in the camera for a short time before being removed. Before taking important pictures, check that the date and time settings are correct.

Subjects that are difficult to focus on

It may be difficult to focus with auto focus in the following situations.

AF confirmation mark is blinking.
These subjects are not focused.



Subject with low contrast



Excessively bright light in center of frame

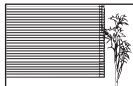

Subject with repeated patterns

AF confirmation mark lights up but the subject is not focused.



Subjects at different distances

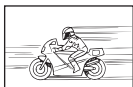

Fast-moving subject



Subject not inside AF area



In any situation, focus on something with high contrast that is at the same distance as the subject, determine the composition and shoot the picture.  "Focus lock – If correct focus cannot be obtained" (P. 60)

Image taken appears whitish

This may occur when the picture is taken in backlight or semi-backlight conditions. This is due to a phenomenon called flare or ghosting. As far as possible, consider a composition where strong light source is not taken in the picture. Flare may occur even when a light source is not present in the picture. Use a lens hood to shade the lens from the light source. If a lens hood does not have effect, use your hand to shade the lens from the light.

 "Interchangeable lenses" (P. 132)

Unknown bright dot(s) appear on the subject in the picture taken

This may be due to stuck pixel (s) on the image pickup device. Perform **[PIXEL MAPPING]**. If the problem persists, repeat pixel mapping a few times.  "Pixel mapping – Checking the image processing functions" (P. 129)

Functions that cannot be selected from menus

Some items may not be selectable from the menus when using the arrow pad.

- Items that cannot be set with the current shooting mode
- Items that cannot be set because of an item that has already been set:
Combination of  and **[NOISE REDUCT.]**, etc.













Camera vibration when the power is turned off









This is due to the camera initializing the image stabilizer mechanism. Without this initialization, the image stabilizer may not be able to achieve the proper effect.

Set functions are restored to their factory default settings

When you rotate the mode dial or turn off the power in a shooting mode other than **P**, **A**, **S**, or **M**, functions with changes made to their settings are restored to the factory default settings.

Error codes

Monitor indication	Possible cause	Corrective action
 NO CARD	The card is not inserted, or it cannot be recognized.	Insert a card or insert a different card.
 CARD ERROR	There is a problem with the card.	Insert the card again. If the problem persists, format the card. If the card cannot be formatted, it cannot be used.
 WRITE PROTECT	Writing to the card is prohibited.	The card write-protect switch is set to the [LOCK] side. Release the switch.  P. 130
 CARD FULL	The card is full. No more pictures can be taken or no more information such as print reservation can be recorded.	Replace the card or erase unwanted pictures. Before erasing, download important images to a PC.
 CARD FULL	There is no space in the card and print reservation or new images cannot be recorded.	Replace the card or erase unwanted pictures. Before erasing, download important images to a PC.
	Card cannot be read. Card may not have been formatted.	<ul style="list-style-type: none"> • Select [CLEAN CARD], press the  button and turn off the camera. Remove the card and wipe dry the metallic surface with a soft, dry cloth. • Select [FORMAT] ▶ [YES], and then press the  button to format the card. Formatting the card erases all data on the card.
 NO PICTURE	There are no pictures on the card.	The card contains no pictures. Record pictures and play back.
 PICTURE ERROR	The selected picture cannot be displayed for playback due to a problem with this picture. Or the picture cannot be used for playback on this camera.	Use image processing software to view the picture on a PC. If that cannot be done, the image file is damaged.
 THE IMAGE CANNOT BE EDITED	Pictures taken with another camera cannot be edited on this camera.	Use image processing software to edit the picture.

Monitor indication	Possible cause	Corrective action
 °C/°F	The internal temperature of the camera has risen due to sequential shooting.	Turn off the camera and wait for the internal temperature to cool.
 Internal camera temperature is too high. Please wait for cooling before camera use.		Wait a moment for the camera to turn off automatically. Allow the internal temperature of the camera to cool before resuming operations.
 BATTERY EMPTY	The battery is drained.	Charge the battery.
 NO CONNECTION	The camera is not connected to the computer or printer correctly.	Disconnect the camera and connect it again correctly.
 NO PAPER	There is no paper in the printer.	Load some paper in the printer.
 NO INK	The printer has run out of ink.	Replace the ink cartridge in the printer.
 JAMMED	The paper is jammed.	Remove the jammed paper.
SETTINGS CHANGED	The printer's paper cassette has been removed or the printer has been manipulated while making settings on the camera.	Do not manipulate the printer while making settings on the camera.
 PRINT ERROR	There is a problem with the printer and/or camera.	Turn off camera and printer. Check the printer and remedy any problems before turning the power on again.
 CANNOT PRINT	Pictures recorded on other cameras may not be printed on this camera.	Use a personal computer to print.

Cleaning and storing the camera

Cleaning the camera

Turn off the camera and remove the battery before cleaning the camera.

Exterior:

- Wipe gently with a soft cloth. If the camera is very dirty, soak the cloth in mild soapy water and wring well. Wipe the camera with the damp cloth and then dry it with a dry cloth. If you have used the camera at the beach, use a cloth soaked in clean water and well wrung.

LCD monitor:

- Wipe gently with a soft cloth.

Lens:

- Blow dust off the lens with a commercially available blower. For the lens, wipe gently with a lens cleaning paper.

Storage

- When not using the camera for a prolonged period, remove the battery and card. Store the camera in a cool, dry place that is well ventilated.
- Insert the battery periodically and test the camera's functions.

Cleaning and checking the image pickup device

This camera incorporates a dust reduction function to keep dust from getting on the image pickup device and to remove any dust or dirt from the image pickup device surface with ultrasonic vibrations. The dust reduction function operates when the camera is turned on. The dust reduction function operates at the same time as the pixel mapping, which checks the image pickup device and image processing circuitry. Since dust reduction is activated every time the camera's power is turned on, the camera should be held upright for the dust reduction function to be effective. The SSWF indicator blinks while dust reduction is working.

 "Dust reduction function operation" (P. 14)



Notes

- Do not use strong solvents such as benzene or alcohol, or a chemically treated cloth.
- Avoid storing the camera in places where chemicals are treated, in order to protect the camera from corrosion.
- Mold may form on the lens surface if the lens is left dirty.
- Check each part of the camera before use if it has not been used for a long time. Before taking important pictures, be sure to take a test shot and check that the camera works properly.

Pixel mapping – Checking the image processing functions

The pixel mapping feature allows the camera to check and adjust the image pickup device and image processing functions. After using the monitor or taking continuous shots, wait for at least one minute before using the pixel mapping function to ensure that it operates correctly.

1 MENU ▶ [⚙️] ▶ [📷] ▶ [PIXEL MAPPING]

2 Press , then press the  button.

- The [BUSY] bar is displayed when pixel mapping is in progress. When pixel mapping is finished, the menu is restored.

Notes

- If you accidentally turn the camera off during pixel mapping, start again from Step 1.

Card basics

Usable cards

"Card" in this manual refers to a recording medium. The only cards usable with this camera are SD memory cards and SDHC memory cards (sold separately) which conform to the SD standard. For the latest information, please visit the Olympus website.

SD card write protect switch

The SD card body has a write protect switch. If you set the switch to the "LOCK" side, you will not be able to write to the card, delete data or format. Return the switch to enable writing.



! Notes

- The data in the card will not be erased completely even after formatting the card or deleting the data. When discarding, destroy the card to prevent leakage of personal information.



Formatting the card

Cards formatted on a computer or other camera must be formatted with the camera before they can be used.

All data stored on the card, including protected images, is erased when the card is formatted. When formatting a used card, confirm there are no images that you still want to keep on the card.

- MENU \blacktriangleright [M] \blacktriangleright [CARD SETUP]
- Use \leftarrow [ISO] \rightarrow [M] to select [FORMAT]. Press the \odot button.
- Use \leftarrow [ISO] \rightarrow [M] to select [YES]. Press the \odot button.
 - Formatting is performed.

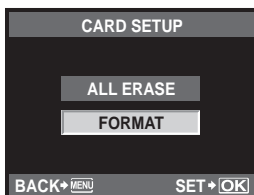

Battery and charger

- Use the single Olympus lithium-ion battery (BLS-1). Other batteries cannot be used.
- The camera's power consumption varies widely with usage and other conditions.
- As the following consume a lot of power even without shooting, the battery will be drained quickly.
 - Performing auto focus repeatedly by pressing the shutter button halfway in shooting mode.
 - Displaying images on the LCD monitor for a prolonged period.
 - When connected to a computer or printer.
- When using a drained battery, the camera may turn off without the low battery warning being displayed.
- The battery will not be fully charged at the time of purchase. Charge the battery using the provided charger (BCS-1) before use.
- The normal charging time using the provided charger is approximately 3 hours 30 minutes (estimated).
- Do not use chargers other than the one designated.

! Notes

- There is a risk of explosion if the battery is replaced with the incorrect battery type. Dispose of the used battery following the instructions: "Battery Handling Precautions" (P. 151)

Using your charger abroad

- The charger can be used in most home electrical sources within the range of 100V to 240 V AC (50/60 Hz) around the world. However, depending on the country or area you are in, the AC wall outlet may be shaped differently and the charger may require a plug adapter to match the wall outlet. For details, ask at your local electrical shop or travel agent.
- Do not use commercially available travel adaptors as the charger may malfunction.

Interchangeable lenses

Select the lens that you want to shoot with.

Use a specified lens (Micro Four Thirds mount). To use the "Four Thirds System Lens", an adapter (sold separately) is required. An adapter to allow use of an OM system lens is also available (sold separately).

M.ZUIKO DIGITAL interchangeable lenses

This is an interchangeable lens specifically for use with the "Micro Four Thirds system" which is a smaller, thinner version of the "Four Thirds system".

Focal length and depth of field of Micro Four Thirds system lenses

When compared to 35-mm cameras, Micro Four Thirds system cameras achieve different effects at the same focal length and aperture.

Focal length

At the same focal length of a 35-mm camera, a Four Thirds system camera can achieve a focal length equivalent to twice that of a 35-mm camera. This enables the design of compact telephoto lenses. For instance, a Micro Four Thirds system lens 14 – 42 mm is equivalent to a 28 – 84 mm lens for a 35-mm camera.

- When the image angle of a Micro Four Thirds system lens is converted to that of a 35-mm camera, the perspective is the same as that of a 35-mm camera.

Depth of Field

A Micro Four Thirds system camera can achieve a depth of field equivalent to two times deeper than that of a 35-mm camera. A Micro Four Thirds system lens with f2.8 brightness, for example, is equivalent to f5.6 when converted to the aperture of a 35-mm camera.

- You can achieve the same amount of background blur as if you were using a 35-mm camera.



Notes

- When you attach or remove the body cap and lens from the camera, keep the lens mount on the camera pointed downward. This helps prevent dust and other foreign matter from getting inside the camera.
- Do not remove the body cap or attach the lens in dusty places.
- Do not point the lens attached to the camera toward the sun. This may cause the camera to malfunction or even ignite due to the magnifying effect of sunlight focusing through the lens.
- Be careful not to lose the body cap and rear cap.
- Attach the body cap to the camera to prevent dust from getting inside when no lens is attached.

M.ZUIKO DIGITAL lens specifications

Names of parts

- ① Filter mount thread
- ② Zoom ring
- ③ Focus ring
- ④ Mount index
- ⑤ Electrical contacts
- ⑥ Front cap
- ⑦ Rear cap

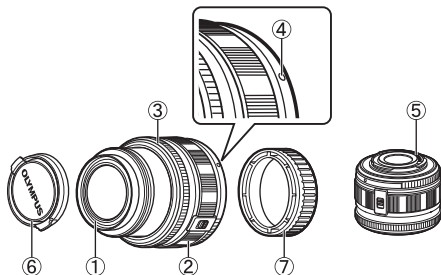

Lens and camera combinations

Lens	Camera	Attachment	AF	Metering
Micro Four Thirds system lens	Micro Four Thirds system camera	Yes	Yes	Yes
Four Thirds system lens		Attachment possible with mount adapter	Yes*1	Yes
OM System lenses			No	Yes*2
Micro Four Thirds system lens	Four Thirds System Camera	No	No	No

*1 [C-AF] of [AF MODE] cannot be used.

*2 Accurate metering not possible.

Micro Four Thirds system lenses and Micro Four Thirds system cameras have the mark shown to the right.



■ Main Specifications

Items	14 – 42 mm	17 mm
Mount	Micro Four Thirds mount	
Focal length	14 – 42 mm	17 mm
Max. aperture	f3.5 – 5.6	f2.8
Image angle	75.4° – 28.9°	64.9°
Lens configuration	8 groups, 9 lenses	4 groups, 6 lenses
	Multilayer film coating (partially single layered)	
Iris control	f3.5 – 22	f2.8 – 22
Shooting range	0.25 m – ∞	0.2 m – ∞
Focus adjustment	AF/MF switching	
Weight (excluding hood and cap)	150 g	71 g
Dimensions (Max. diameter x overall length)	Ø 62 x 43.5 mm	Ø 57 x 22 mm
Filter mount thread diameter	40.5 mm	37 mm

- It is recommended to extend the retractable lens before turning the power on. Also, do not retract the lens while the power is on.

■ Storage Precautions

- Clean the lens after use. Remove dust and dirt on the surface of the lens with a blower brush or brush. Use commercially available lens cleaning paper to remove the dirt on the lens. Do not use organic solvents.
- Always cap the lens and store it when it is not used.
- Do not store in an area with insect repellent.

! Notes on Shooting

- Edges of pictures may be cut off if more than one filter is used or if a thick filter is used.

Using optical viewfinder (sold separately)

If you use the optical viewfinder (sold separately: VF-1), you can view the shooting screen in the finder. This is convenient when you are in a bright location, such as under direct sunlight, where it is difficult to view the monitor (Kits including the VF-1 are available).

1 Slide off the hot shoe cover.

- Keep the shoe cover in a safe place to avoid losing it.

2 Align the optical viewfinder with the hot shoe on the camera body, and slide it in until it stops.

- Insert the optical viewfinder by pushing on a lower part of it.

1 Turn on the camera, and select [BACKLIT LCD] “[Fn] FUNCTION” (P. 100) or “[Q] FUNCTION” (P. 101)

- Each time you press the Fn button or Q button, the LCD monitor turns on or off.

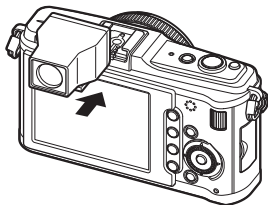

! Notes on looking after the viewfinder

- View frame is equivalent to 17mm. Use the display frame in the viewfinder as a guide for the shooting range. Check the correct shooting range on the LCD monitor.
- You cannot use an external flash and the optical viewfinder at the same time.
- When carrying the camera, do not hold it by the optical viewfinder. The camera may separate from the optical viewfinder and drop.
- Do not leave the finder or the camera with the finder attached in a location subject to direct sunlight.

Program line diagram (P mode)

In the **P** mode, the camera is programmed such that the aperture value and shutter speed are automatically selected according to the subject's brightness as shown below. The program line diagram varies with the type of lens mounted.

- When using the (14 – 42 mm F3.5 – 5.6) zoom lens (focal length: 14 mm)
- Program shift

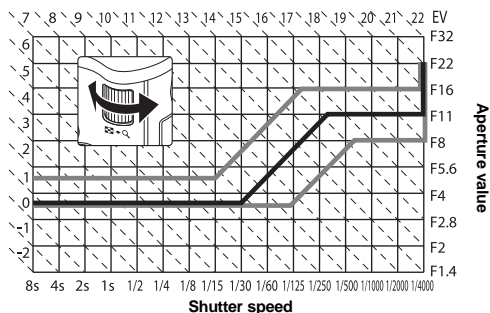

Flash synchronization and shutter speed





Shooting mode	Flash timing	Upper limit of synchronization timing ^{*1}	Fixed timing when flash fires ^{*2}
P	1/ (lens focal length x 2) or synchronization timing, whichever is slower	1/180	1/60
A			—
S	The set shutter speed	1/180	—
M			—

*1 Can be changed using menu: 1/60 – 1/180 "X-SYNC." (P. 106)

*2 Can be changed using menu: 1/30 – 1/180 "SLOW LIMIT" (P. 106)

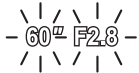



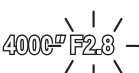
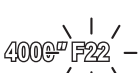





Exposure warning display

If the optimum exposure cannot be obtained when pressing the shutter button halfway, the display will blink on the LCD monitor.

Shooting mode	Warning display example (blinking)	Status	Action
P		The subject is too dark.	<ul style="list-style-type: none"> • Increase the ISO sensitivity. • Use the flash.
		The subject is too bright.	<ul style="list-style-type: none"> • Decrease the ISO sensitivity. • Use a commercially available ND filter (for adjusting the amount of light).
A		The subject is underexposed.	<ul style="list-style-type: none"> • Decrease the aperture value. • Increase the ISO sensitivity.
		The subject is overexposed.	<ul style="list-style-type: none"> • Increase the aperture value. • Decrease the ISO sensitivity or use a commercially available ND filter (for adjusting the amount of light).
S		The subject is underexposed.	<ul style="list-style-type: none"> • Set the shutter speed slower. • Increase the ISO sensitivity.
		The subject is overexposed.	<ul style="list-style-type: none"> • Set the shutter speed faster. • Decrease the ISO sensitivity or use a commercially available ND filter (for adjusting the amount of light).

- The aperture value at the moment when its indication blinks varies with the lens type and focal length of the lens.

Flash modes that can be set by shooting mode

Shooting Mode	Super control panel	Flash Mode	Flash timing	Conditions for firing the flash	Shutter speed limit	
P A	 AUTO	Auto flash	1st curtain	Fires automatically in dark/backlit ^{*1} conditions	1/30 sec. – 1/180 sec.	
		Auto flash (red-eye reduction)				
		Fill-in flash		Always fires		
			Flash off	—	—	—
		 SLOW	Slow synchronization (red-eye reduction)	1st curtain	Fires automatically in dark/backlit ^{*1} conditions	60 sec. – 1/180 sec.
		 SLOW	Slow synchronization (1st curtain)			
		 SLOW2	Slow synchronization (2nd curtain)	2nd curtain		
S M		Fill-in flash	1st curtain	Always fires	60 sec. – 1/180 sec.	
		Fill-in flash (red-eye reduction)				
			Flash off	—	—	—
		2nd CURTAIN	Fill-in flash/Slow synchronization (2nd curtain)	2nd curtain	Always fires	60 sec. – 1/180 sec.

*1 When the flash is set to the Super FP mode, it detects backlight with longer duration than for normal flash before emitting light.  "Super FP flash" (P. 74)

- AUTO,  can be set in **FAUTO** mode.

White balance color temperature

The higher the color temperature, the richer the light in bluish tones and the poorer in reddish; the lower the color temperature, the richer the light in reddish tones and the poorer in bluish. The spectral balance of different white light sources is rated numerically by color temperature – concept of physics expressed using the Kelvin (K) temperature scale. The color of sunlight and other natural light sources and the color of a light bulb and other artificial light sources can be expressed in terms of color temperature. It follows, then, that the color temperatures of fluorescent lights make them unsuitable as artificial light sources. There are gaps in the hues from the color temperatures of fluorescent light. If these differences in hue are small, they can be calculated with color temperature and this is called correlated color temperature. This camera is preset with correlated color temperatures of 4,000K, 4,500K and 6,600K. Strictly speaking, these are not color temperatures. Use these settings for shooting conditions under fluorescent lights.

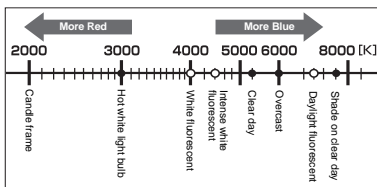

- The color temperatures for each light source indicated in the above scale are approximate.

Record mode and file size/number of storable still pictures

The file size in the table is approximate for files with a 4:3 aspect ratio.

Record mode	Number of pixels (PIXEL COUNT)	Compression	File format	File size (MB)	Number of storable still picture (with 1GB SD/SDHC card)
RAW	4032 x 3024	Loss-less compression	ORF	Approx. 14	54
L ^{SF}		1/2.7		Approx. 8.4	101
L ^F		1/4		Approx. 5.9	145
L ^N		1/8		Approx. 2.7	320
L ^B	3200 x 2400	1/12	JPEG	Approx. 1.8	477
M ^{SF}		1/2.7		Approx. 5.6	154
M ^F		1/4		Approx. 3.4	255
M ^N		1/8		Approx. 1.7	504
M ^B	1/12	Approx. 1.2		747	
M ^{SF}	2560 x 1920	1/2.7		Approx. 3.2	269
M ^F		1/4		Approx. 2.2	395
M ^N		1/8		Approx. 1.1	776
M ^B		1/12		Approx. 0.8	1143
M ^{SF}	1600 x 1200	1/2.7		Approx. 1.3	673
M ^F		1/4		Approx. 0.9	993
M ^N		1/8		Approx. 0.5	1893
M ^B		1/12		Approx. 0.4	2753
S ^{SF}	1280 x 960	1/2.7		Approx. 0.9	1044
S ^F		1/4		Approx. 0.6	1514
S ^N		1/8		Approx. 0.3	2884
S ^B		1/12	Approx. 0.3	4038	
S ^{SF}	1024 x 768	1/2.7	Approx. 0.6	1594	
S ^F		1/4	Approx. 0.4	2243	
S ^N		1/8	Approx. 0.3	4038	
S ^B		1/12	Approx. 0.2	5507	
S ^{SF}	640 x 480	1/2.7	Approx. 0.3	3563	
S ^F		1/4	Approx. 0.2	5048	
S ^N		1/8	Approx. 0.2	8654	
S ^B		1/12	Approx. 0.1	10096	

! Notes

- The number of remaining pictures may change according to the subject, whether or not print reservations have been made, and other factors. In certain instances, the number of remaining pictures displayed on the LCD monitor will not change even when you take pictures or erase stored images.
- The actual file size varies according to the subject.
- The maximum number of storable still pictures displayed on the monitor is 9999.
- For the available recording time for movies, see the Olympus homepage.

Functions that can be registered with My Mode and Custom Reset Setting





Function	My Mode registration	Custom reset setting registration	Function	My Mode registration	Custom reset setting registration
	✓	✓	SLEEP	—	✓
Image stabilizer	✓	✓	USB MODE	—	—
	✓	✓	LIVE VIEW BOOST	✓	✓
Flash mode	✓	✓	FACE DETECT	—	—
PICTURE MODE	✓	✓	INFO SETTING	—	✓
GRADATION	✓	✓	EV STEP	✓	✓
	STILL	✓	METERING	✓	✓
	PICTURE	✓	AEL Metering	—	✓
	MOVIE	—	ISO	✓	✓
IMAGE ASPECT	✓	✓	ISO STEP	✓	✓
	✓	✓	ISO-AUTO SET	—	✓
AE BKT	✓	✓	ISO-AUTO	—	✓
WB BKT	✓	✓	BULB TIMER	—	✓
FL BKT	✓	✓	ANTI-SHOCK []	✓	✓
ISO BKT	✓	✓	X-SYNC.	✓	✓
MULTIPLE EXPOSURE	—	—	SLOW LIMIT	✓	✓
	—	✓	+	—	✓
	—	—	NOISE REDUCT.	✓	✓
	—	—	NOISE FILTER	✓	✓
REC VIEW	—	✓	WB	✓	✓
	—	—		✓	✓
FIRMWARE	—	—	ALL	—	—
AF MODE	STILL	✓	COLOR SPACE	✓	✓
	PICTURE	✓	SHADING COMP.	✓	✓
	MOVIE	—	SET	—	✓
AF AREA	✓	✓	PIXEL COUNT	—	✓
FOCUS RING	—	✓	QUICK ERASE	—	✓
DIAL FUNCTION	—	✓	RAW+JPEG ERASE	—	✓
DIAL DIRECTION	—	✓	FILE NAME	—	—
AEL/AFL	—	✓	PRIORITY SET	—	—
AEL/AFL MEMO	—	✓	dpi SETTING	—	—
FUNCTION	—	✓	EDIT FILENAME	—	—
MY MODE SETUP	—	—	PIXEL MAPPING	—	—
BUTTON TIMER	—	—	EXPOSURE SHIFT	✓	✓
	—	✓	MF ASSIST	—	✓
FUNCTION	—	✓	LEVEL GAUGE	—	✓
FUNCTION	—	✓	HDMI	—	—
RLS PRIORITY S	✓	✓	MOVIE+STILL	—	✓
RLS PRIORITY C	✓	✓	MOVIE	—	✓
VIDEO OUT	—	—			

✓: Can be registered. —: Cannot be registered

* Includes anti-shock.

Menu directory

Shooting Menu

Tab	Function	Setting	Ref. page	
	CARD SETUP	ALL ERASE/FORMAT	P. 93 P. 130	
	CUSTOM RESET	RESET		P. 96
		RESET1	SET/RESET	
		RESET2	SET/RESET	
	PICTURE MODE	VIVID/NATURAL/MUTED* PORTRAIT/ MONOTONE/CUSTOM		P. 71
	GRADATION	AUTO/NORMAL* HIGH KEY/LOW KEY		P. 72
		STILL PICTURE	RAW/LF/LN*/MN/SN/LF+RAW/LN+RAW/ MN+RAW/SN+RAW	P. 64
MOVIE		HD*/SD	P. 80	
IMAGE ASPECT	4:3/16:9/3:2/6:6		P. 40	
	MOVIE AE MODE	P*/A/ [P1] / [P2] / [P3] / [P4] / [P5]	P. 79	
	MOVIE+STILL	OFF*/ON	P. 80	
		<input type="checkbox"/> */ <input type="checkbox"/> / [P1] / [P2] / [P3] / [P4] / [P5] / <input type="checkbox"/>	P. 61 – P. 62	
	IMAGE STABILIZER	OFF*/I.S. 1/I.S. 2/I.S. 3	P. 62	
	MULTIPLE EXPOSURE	FRAME	OFF*/2F	P. 54
		AUTO GAIN	OFF*/ON	
OVERLAY		OFF*/ON		

* Factory default setting

Playback Menu

Tab	Function	Setting	Ref. page	
		START	P. 84	
		BGM		MELANCHOLY*/NOSTALGIC/LOVE/JOY/ COOL/OFF
		SLIDE		ALL*/STILL PICTURE/MOVIE
		OFF/ON*		P. 85
	EDIT	SEL. IMAGE	RAW DATA EDIT	P. 89
			JPEG EDIT	SHADOW ADJ/REDEYE FIX//ASPECT/BLACK & WHITE/SEPIA/ SATURATION// e-PORTRAIT
			NO/ START/YES	P. 90
		IMAGE OVERLAY	2IMAGES MERGE/3IMAGES MERGE	P. 90
				P. 112
	RESET PROTECT	YES/NO		P. 92

* Factory default setting

Setup Menu

Tab	Function	Setting	Ref. page
		—	P. 15
		*1	P. 94
		-7 - +7 -7 - +7 (±0, ±0)	P. 94
	REC VIEW	OFF/AUTO//1SEC - 20 SEC (5 SEC)	P. 95
	MENU DISPLAY	OFF*/ON	P. 25
	FIRMWARE	—	P. 95

* Factory default setting

*1 Settings differ depending on the region where the camera is purchased.

Custom Menu

Tab	Function	Setting	Ref. page	
	AF/MF		P. 97	
	AF MODE	STILL PICTURE MOVIE	S-AF*/C-AF/MF/S-AF+MF	P. 56
	AF AREA	*/		
	SET UP	OFF/LOOP/SPIRAL*		P. 97
	RESET LENS	OFF/ON*		P. 98
	BULB FOCUSING	OFF/ON*		P. 98
	FOCUS RING	/		P. 98
	MF ASSIST	OFF/ON*		P. 98

* Factory default setting

Tab	Function	Setting		Ref. page	
	BUTTON/DIAL			P. 98	
	DIAL FUNCTION	P	Ps*//		P. 98
		A	FNo.*//		
		S	SHUTTER*//		
		M	Main dial: SHUTTER*/FNo. Sub dial: SHUTTER/FNo.*		
		MENU	Main dial: //VALUE* Sub dial: //VALUE		
	DIAL DIRECTION	DIAL1*/DIAL2		P. 99	
	AEL/AFL	S-AF*	mode1*/mode2/mode3		P. 99
		C-AF	mode1/mode2*/mode3/mode4		
		MF	mode1*/mode2/mode3		
	AEL/AFL MEMO	OFF*/ON		P. 100	
	FUNCTION	Fn FACE DETECT*/PREVIEW//[] HOME/MF/RAW -/TEST PICTURE/MY MODE/BACKLIT LCD/OFF		P. 100	
	FUNCTION	AF MODE*/METERING/FLASH MODE/BACKLIT LCD/IMAGE STABILIZER		P. 101	
	MY MODE SETUP	MY MODE1/ MY MODE2		P. 101	
	BUTTON TIMER	3SEC/5SEC/8SEC*/HOLD/OFF		P. 101	
		OFF*/ON		P. 102	
	FUNCTION	OFF/ON*/[]		P. 102	
	RELEASE/			P. 102	
	RLS PRIORITY S	OFF*/ON		P. 102	
	RLS PRIORITY C	OFF/ON*		P. 102	
	DISP//PC			P. 102	
	HDMI	1080i*/720p/480p/576p		P. 102	
	VIDEO OUT	*1		P. 102	
		OFF/ON*		P. 103	
	SLEEP	OFF/1MIN*/3MIN/5MIN/10MIN		P. 103	
	USB MODE	AUTO*/STORAGE/MTP/PRINT		P. 103	
	LIVE VIEW BOOST	OFF*/ON		P. 104	
FACE DETECT	OFF*/ON		P. 39 P. 104		
INFO SETTING	INFO	IMAGE ONLY/OVERALL// HIGHLIGHT&SHADOW		P. 104	
	LV-INFO	/ZOOM/MULTI VIEW/ IMAGE ONLY/			
VOLUME	0 - 5 (3*)		P. 104		
SETUP	SLIDE INTERVAL	2 SEC - 10 SEC (3 SEC*)		P. 104	
	MOVIE INTERVAL	FULL/SHORT*			
LEVEL GAUGE	OFF*/ON		P. 104		
MOVIE	OFF/ON*		P. 80 P. 105		

* Factory default setting

*1 Settings differ depending on the region where the camera is purchased.

Tab	Function	Setting	Ref. page		
	EXP//ISO		P. 105		
	EV STEP	1/3EV*/1/2EV/1EV	P. 105		
	METERING			P. 49	
	AEL Metering	AUTO*////		P. 105	
	ISO	AUTO*/100 – 6400		P. 53	
	ISO STEP	1/3EV*/1EV		P. 105	
	ISO-AUTO SET	HIGH LIMIT	200 – 6400 (1600*)	P. 105	
		DEFAULT	200 – 6400 (200*)		
	ISO-AUTO	P/A/S */ALL		P. 106	
	BULB TIMER	1MIN – 30MIN (8 MIN*)		P. 106	
	ANTI-SHOCK	OFF*/1/8 SEC – 30 SEC		P. 106	
	BRACKETING	AE BKT	OFF*/3F 0.3EV/3F 0.7EV/ 3F 1.0EV	P. 52	
		WB BKT	A – B	OFF*/3F 2STEP/3F 4STEP/3F 6STEP	P. 70
			G – M		
		FL BKT	OFF*/3F 0.3EV/3F 0.7EV/ 3F 1.0EV	P. 77	
	ISO BKT	OFF*/3F 0.3EV/3F 0.7EV/ 3F 1.0EV	P. 54		
		CUSTOM		P. 106	
FLASH MODE	AUTO *////// SLOW/ SLOW/ SLOW 2/ 2nd CURTAIN		P. 75		
	-3.0 – 0.0* – +3.0		P. 77		
X-SYNC.	1/60 – 1/180 (1/180*)		P. 106		
SLOW LIMIT	1/30 – 1/180 (1/60*)		P. 106		
+	OFF /ON		P. 107		

Tab	Function	Setting	Ref. page	
	←/COLOR/WB		P. 107	
	NOISE REDUCT.	OFF/ON/AUTO*	P. 107	
	NOISE FILTER	OFF/LOW/STANDARD*/HIGH	P. 107	
	WB	AUTO*	A -7 - +7, G -7 - +7	P. 67
		5,300K	A -7 - +7, G -7 - +7	
		7,500K	A -7 - +7, G -7 - +7	
		6,000K	A -7 - +7, G -7 - +7	
		3,000K	A -7 - +7, G -7 - +7	
		4,000K	A -7 - +7, G -7 - +7	
		4,500K	A -7 - +7, G -7 - +7	
		6,600K	A -7 - +7, G -7 - +7	
		5,500K	A -7 - +7, G -7 - +7	
			A -7 - +7, G -7 - +7	
	CWB	2,000K - 14,000K		
	ALL	ALL SET	A -7 - +7, G -7 - +7	P. 108
		ALL RESET	YES/NO	
	COLOR SPACE	sRGB*/AdobeRGB		P. 108
	SHADING COMP.	OFF*/ON		P. 108
	← SET	←1 - ←4	/ / SF/F/N/B	P. 108
	PIXEL COUNT	iddle	3200 x 2400/2560 x 1920*/1600 x 1200	P. 109
		mall	1280 x 960*/1024 x 768/640 x 480	
	RECORD/ERASE		P. 109	
	QUICK ERASE	OFF*/ON	P. 109	
	RAW+JPEG ERASE	JPEG/RAW/RAW+JPEG*	P. 109	
	FILE NAME	AUTO*/RESET	P. 109	
	EDIT FILENAME	Adobe RGB	P. 110	
		sRGB		
	PRIORITY SET	NO*/YES	P. 110	
	dpi SETTING	AUTO*/CUSTOM	P. 110	
	UTILITY		P. 110	
	PIXEL MAPPING	—	P. 129	
	EXPOSURE SHIFT		-1 - 0* - +1	
	WARNING LEVEL	-2 - 0* - +2	P. 111	
	LEVEL ADJUST	RESET/ADJUST	P. 111	

* Factory default setting

Specifications

Camera specifications

■ Product type

Product type	: Digital camera with interchangeable lens system
Lens	: M.Zuiko Digital, Micro Four Thirds System Lens
Lens mount	: Micro Four Thirds mount
Equivalent focal length on a 35 mm film camera	: Approx. twice the focal length of the lens

■ Image pickup device

Product type	: 4/3" Live MOS sensor
No. of total pixels	: Approx. 13,060,000 pixels
No. of effective pixels	: Approx. 12,300,000 pixels
Screen size	: 17.3 mm (H) x 13.0 mm (V) (0.7" x 0.5")
Aspect ratio	: 1.33 (4:3)

■ Live view

	: Uses Live MOS sensor
	: Field of view of 100%

■ LCD monitor

Product type	: 3.0" TFT color LCD
Total no. of pixels	: Approx. 230,000 dots

■ Shutter

Product type	: Computerized focal-plane shutter
Shutter	: 1/4000 – 60 sec., Bulb shooting

■ Auto focus

Product type	: Imager contrast detection system
Focusing points	: 11 points
Selection of focusing point	: Auto, Optional

■ Exposure control

Metering system	: TTL metering system (imager metering) (1) Digital ESP metering (2) Center weighted averaging metering (3) Spot metering
Metered range	: EV0 – 18 (Digital ESP metering/Center weighted metering/Spot metering)
Shooting modes	: (1) AUTO : iAuto (2) P : Program AE (Program shift can be performed) (3) A : Aperture priority AE (4) S : Shutter priority AE (5) M : Manual (6) ART : Art filter (7) SCN : Scene (8)  : Movie
ISO sensitivity	: 100 – 6400 (1/3, 1 EV step)
Exposure compensation	: ±3EV (1/3, 1/2, 1 EV step)

■ White balance

Product type	: Image pickup device
Mode setting	: Auto, Preset WB (8 settings), Customized WB, One-touch WB

■ Recording

Memory	: SD memory card SDHC memory card
Recording system	: Digital recording, JPEG (in accordance with Design rule for Camera File system [DCF]), RAW Data
Applicable standards	: Exif 2.2, Digital Print Order Format (DPOF), PRINT Image Matching III, PictBridge
Sound with still pictures	: Wave format
Movie	: AVI Motion JPEG
Audio	: PCM 44.1 kHz (stereo)

■ Playback

Display format	: Single-frame playback, Close-up playback, Index display, Image rotation, Calendar display
----------------	---

■ Drive

Drive mode	: Single-frame shooting, Sequential shooting, Self-timer
Sequential shooting	: 3 frames/sec.
Self-timer	: Operation time: 12 sec., 2 sec.

■ External flash

Synchronization	: Synchronized with the camera at 1/180 sec. or less
Flash control mode	: TTL-AUTO (TTL pre-flash mode), AUTO, MANUAL
Flash attachment	: Hot shoe

■ External connector

Multi-connector (USB connector, AV connector), HDMI mini connector (Type C)

■ Power supply

Battery	: Li-ion Battery (BLS-1) x1
---------	-----------------------------

■ Dimensions/weight

Dimensions	: 120.5 mm (W) x 70.0 mm (H) x 35.0 mm (D) (4.7" x 2.8" x 1.3") (excluding protrusions)
Weight	: Approx. 335 g (0.7 lb.) (without battery)

■ Operating environment

Temperature	: 0 °C – 40 °C (32 °F – 104 °F) (operation/ –20 °C – 60 °C (–4 °F – 140 °F) (storage)
Humidity	: 30 – 90% (operation)/10 – 90% (storage)

HDMI, the HDMI logo and High-Definition Multimedia Interface are trademarks or registered trademarks of HDMI Licensing LLC.

HDMI™
HIGH-DEFINITION MULTIMEDIA INTERFACE

Battery/charger specifications

BLS-1 Lithium ion battery

MODEL NO.	: PS-BLS1
Product type	: Rechargeable Lithium ion battery
Nominal voltage	: DC 7.2V
Nominal capacity	: 1150mAh
No. of charge and discharge times	: Approx. 500 times (varies with usage conditions)
Ambient temperature	: 0 °C – 40 °C (32 °F – 104 °F) (charging) –10 °C – 60 °C (14 °F – 140 °F) (operation) –20 °C – 35 °C (–4 °F – 95 °F) (storage)
Dimensions	: Approx. 35.5 mm (W) x 55 mm (D) x 12.8 mm (H) (1.4" x 2.2" x 0.5")
Weight	: Approx. 46 g (0.1lb.)

BCS-1 Lithium ion charger

MODEL NO.	: PS-BCS1
Rated input	: AC 100V – 240V (50/60Hz)
Rated output	: DC 8.35V, 400mA
Charging time	: Approx. 3 hours 30 minutes (room temperature if using BLS-1)
Ambient temperature	: 0 °C – 40 °C (32 °F – 104 °F) (operation)/ –20 °C – 60 °C (–4 °F – 140 °F) (storage)
Dimensions	: Approx. 62 mm (W) x 83 mm (D) x 38 mm (H) (2.4" x 3.3" x 1.5")
Weight	: Approx. 72 g (0.2lb.) (without AC cable)

SPECIFICATIONS ARE SUBJECT TO CHANGE WITHOUT ANY NOTICE OR OBLIGATION ON THE PART OF THE MANUFACTURER.

SAFETY PRECAUTIONS



CAUTION

RISK OF ELECTRIC SHOCK
DO NOT OPEN



CAUTION: TO REDUCE THE RISK OF ELECTRICAL SHOCK, DO NOT REMOVE COVER (OR BACK). NO USER-SERVICEABLE PARTS INSIDE. REFER SERVICING TO QUALIFIED OLYMPUS SERVICE PERSONNEL.



An exclamation mark enclosed in a triangle alerts you to important operating and maintenance instructions in the documentation provided with the product.



DANGER

If the product is used without observing the information given under this symbol, serious injury or death may result.



WARNING

If the product is used without observing the information given under this symbol, injury or death may result.



CAUTION

If the product is used without observing the information given under this symbol, minor personal injury, damage to the equipment, or loss of valuable data may result.

WARNING!

TO AVOID THE RISK OF FIRE OR ELECTRICAL SHOCK, NEVER DISASSEMBLE, EXPOSE THIS PRODUCT TO WATER OR OPERATE IN A HIGH HUMIDITY ENVIRONMENT.

General Precautions

Read All Instructions – Before you use the product, read all operating instructions. Save all manuals and documentation for future reference.

Cleaning – Always unplug this product from the wall outlet before cleaning. Use only a damp cloth for cleaning. Never use any type of liquid or aerosol cleaner, or any type of organic solvent to clean this product.

Attachments – For your safety, and to avoid damaging the product, use only accessories recommended by Olympus.

Water and Moisture – For precautions on products with weatherproof designs, read the weatherproofing sections.

Location – To avoid damage to the product, mount the product securely on a stable tripod, stand, or bracket.

Power Source – Connect this product only to the power source described on the product label.

Foreign Objects – To avoid personal injury, never insert a metal object into the product.

Heat – Never use or store this product near any heat source such as a radiator, heat register, stove, or any type of equipment or appliance that generates heat, including stereo amplifiers.

Product Handling Precautions



WARNING

- Do not use the camera near flammable or explosive gases.
- Do not use the flash and LED on people (infants, small children, etc.) at close range.
 - You must be at least 1 m (3 ft.) away from the faces of your subjects. Firing the flash too close to the subject's eyes could cause a momentary loss of vision.
- Keep young children and infants away from the camera.
 - Always use and store the camera out of the reach of young children and infants to prevent the following dangerous situations which could cause serious injury:
 - Becoming entangled in the camera strap, causing strangulation.
 - Accidentally swallowing the battery, cards or other small parts.
 - Accidentally firing the flash into their own eyes or those of another child.
 - Accidentally being injured by the moving parts of the camera.
- Do not look at the sun or strong lights with the camera.
- Do not use or store the camera in dusty or humid places.
- Do not cover the flash with a hand while firing.



CAUTION

- Stop using the camera immediately if you notice any unusual odors, noise, or smoke around it.
 - Never remove the batteries with bare hands, which may cause a fire or burn your hands.
- Never hold or operate the camera with wet hands.
- Do not leave the camera in places where it may be subject to extremely high temperatures.
 - Doing so may cause parts to deteriorate and, in some circumstances, cause the camera to catch fire. Do not use the charger if it is covered (such as a blanket). This could cause overheating, resulting in fire.
- Handle the camera with care to avoid getting a low-temperature burn.
 - When the camera contains metal parts, overheating can result in a low-temperature burn. Pay attention to the following:
 - When used for a long period, the camera will get hot. If you hold on to the camera in this state, a low-temperature burn may be caused.
 - In places subject to extremely cold temperatures, the temperature of the camera's body may be lower than the environmental temperature. If possible, wear gloves when handling the camera in cold temperatures.
- Be careful with the strap.
 - Be careful with the strap when you carry the camera. It could easily catch on stray objects – and cause serious damage.

Battery Handling Precautions

Follow these important guidelines to prevent batteries from leaking, overheating, burning, exploding, or causing electrical shocks or burns.



DANGER

- The camera uses a lithium ion battery specified by Olympus. Charge the battery with the specified charger. Do not use any other chargers.
- Never heat or incinerate batteries.
- Take precautions when carrying or storing batteries to prevent them from coming into contact with any metal objects such as jewelry, pins, fasteners, etc.
- Never store batteries where they will be exposed to direct sunlight, or subjected to high temperatures in a hot vehicle, near a heat source, etc.
- To prevent causing battery leaks or damaging their terminals, carefully follow all instructions regarding the use of batteries. Never attempt to disassemble a battery or modify it in any way, by soldering, etc.
- If battery fluid gets into your eyes, flush your eyes immediately with clear, cold running water and seek medical attention immediately.
- Always store batteries out of the reach of small children. If a child accidentally swallows a battery, seek medical attention immediately.



WARNING

- Keep batteries dry at all times.
- To prevent batteries from leaking, overheating, or causing a fire or explosion, use only batteries recommended for use with this product.
- Insert the battery carefully as described in the operating instructions.
- If rechargeable batteries have not been recharged within the specified time, stop charging them and do not use them.
- Do not use a battery if it is cracked or broken.
- If a battery leaks, becomes discolored or deformed, or becomes abnormal in any other way during operation, stop using the camera.
- If a battery leaks fluid onto your clothing or skin, remove the clothing and flush the affected area with clean, running cold water immediately. If the fluid burns your skin, seek medical attention immediately.
- Never subject batteries to strong shocks or continuous vibration.



CAUTION

- Before loading, always inspect the battery carefully for leaks, discoloration, warping, or any other abnormality.
- The battery may become hot during prolonged use. To avoid minor burns, do not remove it immediately after using the camera.
- Always unload the battery from the camera before storing the camera for a long period.
- This camera uses a lithium ion battery specified by Olympus. Do not use any other type of battery. For safe and proper use, read the battery's instruction manual carefully before using it.
- If the battery's terminals get wet or greasy, camera contact failure may result. Wipe the battery well with a dry cloth before use.
- Always charge a battery when using it for the first time, or if it has not been used for a long period.
- When operating the camera with battery power at low temperatures, try to keep the camera and spare battery as warm as possible. A battery that has run down at low temperatures may be restored after it is warmed at room temperature.
- The number of pictures you can take may vary depending on the shooting conditions or battery.
- Before going on a long trip, and especially before traveling abroad, purchase extra batteries. A recommended battery may be difficult to obtain while traveling.
- Please recycle batteries to help save our planet's resources. When you throw away dead batteries, be sure to cover their terminals and always observe local laws and regulations.

Caution for Usage Environment

- To protect the high-precision technology contained in this product, never leave the camera in the places listed below, no matter if in use or storage:
 - Places where temperatures and/or humidity are high or go through extreme changes. Direct sunlight, beaches, locked cars, or near other heat sources (stove, radiator, etc.) or humidifiers.
 - In sandy or dusty environments.
 - Near flammable items or explosives.
 - In wet places, such as bathrooms or in the rain. When using products with weatherproof designs, read their manuals as well.
 - In places prone to strong vibrations.
- Never drop the camera or subject it to severe shocks or vibrations.
- When mounted on a tripod, adjust the position of the camera with the tripod head. Do not twist the camera.
- Do not leave the camera pointed directly at the sun. This may cause lens or shutter curtain damage, color failure, ghosting on the image pickup device, or may possibly cause fires.
- Do not touch electric contacts on cameras and interchangeable lenses. Remember to attach the body cap when removing the lens.
- Before storing the camera for a long period, remove the battery. Select a cool, dry location for storage to prevent condensation or mold from forming inside the camera. After storage, test the camera by turning it on and pressing the shutter release button to make sure that it is operating normally.
- Always observe the operating environment restrictions described in the camera's manual.
- Do not directly touch or wipe the image pickup device of the camera.

LCD Monitor

- Do not push the monitor forcibly; otherwise the image may become vague, resulting in a playback mode failure or damage to the monitor.
- A strip of light may appear on the top/bottom of the monitor, but this is not a malfunction.
- When a subject is viewed diagonally in the camera, the edges may appear zigzagged on the monitor. This is not a malfunction; it will be less noticeable in playback mode.
- In places subject to low temperatures, the LCD monitor may take a long time to turn on or its color may change temporarily. When using the camera in extremely cold places, it is a good idea to occasionally place it in a warm place. An LCD monitor exhibiting poor performance due to low temperatures will recover in normal temperatures.
- The LCD used for the monitor is made with high-precision technology. However, black spots or bright spots of light may appear constantly on the LCD Monitor. Due to its characteristics or the angle at which you are viewing the monitor, the spot may not be uniform in color and brightness. This is not a malfunction.

Lens

- Do not immerse in water or splash with water.
- Do not drop or exert strong force on the lens.
- Do not hold at the moving part of the lens.
- Do not touch the lens surface directly.
- Do not touch the contact points directly.
- Do not subject to abrupt temperature changes.
- The operating temperature range is -10°C -40°C (14°F -104°F). Always use within this temperature range.

Legal and Other Notices

- Olympus makes no representations or warranties regarding any damages, or benefit expected by using this unit lawfully, or any request from a third person, which are caused by the inappropriate use of this product.
- Olympus makes no representations or warranties regarding any damages or any benefit expected by using this unit lawfully which are caused by erasing picture data.

Disclaimer of Warranty

- Olympus makes no representations or warranties, either expressed or implied, by or concerning any content of these written materials or software, and in no event shall be liable for any implied warranty of merchantability or fitness for any particular purpose or for any consequential, incidental or indirect damages (including but not limited to damages for loss of business profits, business interruption and loss of business information) arising from the use or inability to use these written materials or software or equipment. Some countries do not allow the exclusion or limitation of liability for consequential or incidental damages, so the above limitations may not apply to you.
- Olympus reserves all rights to this manual.

Warning

Unauthorized photographing or use of copyrighted material may violate applicable copyright laws. Olympus assumes no responsibility for unauthorized photographing, use or other acts that infringe upon the rights of copyright owners.

Copyright Notice

All rights reserved. No part of these written materials or this software may be reproduced or used in any form or by any means, electronic or mechanical, including photocopying and recording or the use of any type of information storage and retrieval system, without the prior written permission of Olympus. No liability is assumed with respect to the use of the information contained in these written materials or software, or for damages resulting from the use of the information contained therein. Olympus reserves the right to alter the features and contents of this publication or software without obligation or advance notice.

FCC Notice

• Radio and Television Interference

Changes or modifications not expressly approved by the manufacturer may void the user's authority to operate this equipment. This equipment has been tested and found to comply with the limits for a Class B digital device, pursuant to Part 15 of the FCC Rules. These limits are designed to provide reasonable protection against harmful interference in a residential installation.

This equipment generates, uses, and can radiate radio frequency energy and, if not installed and used in accordance with the instructions, may cause harmful interference to radio communications.

However, there is no guarantee that interference will not occur in a particular installation. If this equipment does cause harmful interference to radio or television reception, which can be determined by turning the equipment off and on, the user is encouraged to try to correct the interference by one or more of the following measures:

- Adjust or relocate the receiving antenna.
- Increase the distance between the camera and receiver.
- Connect the equipment to an outlet on a circuit different from that to which the receiver is connected.
- Consult your dealer or an experienced radio/TV technician for help. Only the OLYMPUS-supplied USB cable should be used to connect the camera to USB enabled personal computers (PC).

Any unauthorized changes or modifications to this equipment would void the user's authority to operate it.

Use Only Dedicated Rechargeable Battery and Battery Charger

We strongly recommend that you use only the genuine Olympus dedicated rechargeable battery and battery charger with this camera.

Using a non-genuine rechargeable battery and/or battery charger may result in fire or personal injury due to leakage, heating, ignition or damage to the battery. Olympus does not assume any liability for accidents or damage that may result from the use of a battery and/or battery charger that are not genuine Olympus accessories.

For customers in North and South America

For customers in USA

Declaration of Conformity

Model Number : E-P1

Trade Name : OLYMPUS

Responsible Party : **OLYMPUS IMAGING AMERICA INC.**

Address : 3500 Corporate Parkway, P.O. Box 610, Center Valley,
PA 18034-0610, USA

Telephone Number: 484-896-5000

Tested To Comply With FCC Standards

FOR HOME OR OFFICE USE

This device complies with Part 15 of the FCC rules. Operation is subject to the following two conditions:

- (1) This device may not cause harmful interference.
- (2) This device must accept any interference received, including interference that may cause undesired operation.

For customers in Canada

This Class B digital apparatus meets all requirements of the Canadian Interference-Causing Equipment Regulations.

For customers in Europe



"CE" mark indicates that this product complies with the European requirements for safety, health, environment and customer protection. "CE" mark cameras are intended for sales in Europe.



This symbol [crossed-out wheeled bin WEEE Annex IV] indicates separate collection of waste electrical and electronic equipment in the EU countries.
Please do not throw the equipment into the domestic refuse.
Please use the return and collection systems available in your country for the disposal of this product.



This symbol [crossed-out wheeled bin Directive 2006/66/EC Annex II] indicates separate collection of waste batteries in the EU countries.
Please do not throw the batteries into the domestic refuse.
Please use the return and collection systems available in your country for the disposal of the waste batteries.

Provisions of warranty

1. If this product proves to be defective, although it has been used properly (in accordance with the written Handling Care and Operating instructions supplied with it), during a period of two years from the date of purchase from an authorized Olympus distributor within the business area of Olympus Imaging Europa GmbH as stipulated on the website: <http://www.olympus.com> this product will be repaired, or at Olympus's option replaced, free of charge. To claim under this warranty the customer must take the product and this Warranty Certificate before the end of the two year warranty period to the dealer where the product was purchased or any other Olympus service station within the business area of Olympus Imaging Europa GmbH as stipulated on the website: <http://www.olympus.com>. During the one year period of the World Wide Warranty the customer may turn the product in at any Olympus service station. Please notice that not in all countries such Olympus service station exists.
2. The customer shall transport the product to the dealer or Olympus authorized service station at his own risk and shall be responsible for any costs incurred in transporting the product.
3. This warranty does not cover the following and the customer will be required to pay repair charge, even for defects occurring within the warranty period referred to above.
 - (a) Any defect that occurs due to mishandling (such as an operation performed that is not mentioned in the Handling Care or other sections of the instructions, etc.)
 - (b) Any defect that occurs due to repair, modification, cleaning, etc. performed by anyone other than Olympus or an Olympus authorized service station.
 - (c) Any defect or damage that occurs due to transport, a fall, shock, etc. after purchase of the product.
 - (d) Any defect or damage that occurs due to fire, earthquake, flood damage, thunderbolt, other natural disasters, environmental pollution and irregular voltage sources.
 - (e) Any defect that occurs due to careless or improper storage (such as keeping the product under conditions of high temperature and humidity, near insect repellents such as naphthalene or harmful drugs, etc.), improper maintenance, etc.
 - (f) Any defect that occurs due to exhausted batteries, etc.
 - (g) Any defect that occurs due to sand, mud, etc. entering the inside of the product casing.
 - (h) When this Warranty Certificate is not returned with the product.
 - (i) When any alterations whatsoever are made to the Warranty Certificate regarding the year, month and date of purchase, the customer's name, the dealer's name, and the serial number.
 - (j) When proof of purchase is not presented with this Warranty Certificate.
4. This Warranty applies to the product only; the Warranty does not apply to any other accessory equipment, such as the case, strap, lens cap and batteries.
5. Olympus's sole liability under this warranty shall be limited to repairing or replacing the product. Any liability for indirect or consequential loss or damage of any kind incurred or suffered by the customer due to a defect of the product, and in particular any loss or damage caused to any lenses, films, other equipment or accessories used with the product or for any loss resulting from a delay in repair or loss of data, is excluded. Compelling regulations by law remain unaffected by this.

Notes regarding warranty maintenance

1. This warranty will only be valid if the Warranty Certificate is duly completed by Olympus or an authorized dealer or other documents contain sufficient proof. Therefore, please make sure that your name, the name of the dealer, the serial number and the year, month and date of purchase are all completed or the original invoice or the sales receipt (indicating the dealer's name, the date of purchase and product type) is attached to this Warranty Certificate. Olympus reserves the right to refuse free-of-charge service if neither Warranty Certificate is completed nor the above document is attached or if the information contained in it is incomplete or illegible.
2. Since this Warranty Certificate will not be re-issued, keep it in a safe place.
 - Please refer to the list on the web site: <http://www.olympus.com> for the authorized international Olympus service network.

Trademarks

- IBM is a registered trademark of International Business Machines Corporation.
- Microsoft and Windows are registered trademarks of Microsoft Corporation.
- Macintosh is a trademark of Apple Inc.
- SDHC logo is a trademark.
- "Shadow Adjustment Technology" function contains patented technologies from Apical Limited.



- All other company and product names are registered trademarks and/or trademarks of their respective owners.
- The standards for camera file systems referred to in this manual are the "Design Rule for Camera File System/DCF" standards stipulated by the Japan Electronics and Information Technology Industries Association (JEITA).

Symbols

	102
	107
	103
	94
	100
	97
	108
	111
	100
	101
	102
	106
	106
	97, 143
	25
	143
	104
	94, 143
	142
	142
	97
	98
	102
	102
	105
	106
	107
	109
	110

A

Adding sound to still pictures	90
Adobe RGB	108
AE BKT	52
AE bracketing	52
AE lock	51
AEL/AFL	99
AEL/AFL MEMO	100
AEL Metering	105
AF AREA	58
AF MODE	56, 101
AF SENSITIVITY	97
AF target mode	59
AF target	58
ALL	108
ALL ERASE	93
All target AF mode	58
ANTI-SHOCK	61, 62
Aperture priority shooting A	45
Aperture value	16, 44, 45

Art filter mode ART	5
ASPECT	89
Auto flash	75
Auto focus	60, 125
Auto white balance	67

B

B (Basic)	64
B&W FILTER	71
BACKLIT LCD	100
Battery	11, 131
BEACH & SNOW	5
BGM	84
BLACK & WHITE	89
BRACKETING	52, 54, 70, 77, 106
BULB FOCUSING	98
Bulb shooting	48
BULB TIMER	106
BUTTON TIMER	101



C

C-AF (continuous AF)	57
Calendar display	82
CANDLE	5
Card	130
CARD SETUP	93, 130
Center weighted averaging metering	49
CHILDREN	5
Close-up playback Q	81
COLOR SPACE	108
Color temperature	139
Compression rate	64
Continuous AF (C-AF)	57
CONTRAST	71
CUSTOM RESET	96
Custom white balance CWB	67







D

Date/time setting	15
DIAL DIRECTION	99
DIAL FUNCTION	98
Digital ESP metering	49
Direct print	115
DIS MODE	5
DOCUMENTS	5
dpi SETTING	110
DPOF	112
Dust reduction	14, 128

E

Easy printing	116
Easy shooting modes	4
EDIT FILENAME	110
e-PORTRAIT 	5, 89
EV STEP	105
Exposure compensation 	50
EXPOSURE SHIFT	110



F

F (Fine)	64
FACE DETECT 	39, 104
FILE NAME	109
Fill-in flash 	76
FIREWORKS 	5
FIRMWARE	95
FL BKT	77
Flash bracketing	77
Flash intensity control 	77
FLASH MODE 	75
Flash off 	76
Fn FACE DETECT	39
Focus lock	60
FOCUS RING	98
FORMAT	130
Four Thirds system lenses	132



G

GRADATION	72
GRAINY FILM 	5

H

HD	80
HDMI	88, 102
HIGH KEY 	5, 72
Histogram	41, 83
Home position 	59





I

iAUTO shooting 	4
IMAGE ASPECT	40
IMAGE OVERLAY	54, 90
IMAGE STABILIZER IS	62
Index display 	82
INFO SETTING	104
Information display	41, 83
IS (Image stabilizer)	62
ISO	53
ISO BKT	54
ISO bracketing	54
ISO STEP	105
ISO-AUTO	106
ISO-AUTO SET	105







J

JPEG EDIT	89
-----------------	----





L













L (Large)	64
LANDSCAPE 	5
LANDSCAPE+PORTRAIT 	5
Lens	13, 132
LEVEL ADJUST	111
LEVEL GAUGE	104
LIGHT TONE 	5
Lithium ion battery	11, 131
Lithium ion charger	11, 131
Live control	6, 22
LIVE VIEW BOOST	104
LOW KEY 	5, 72















M

M (Middle)	64
M.ZUIKO DIGITAL interchangeable lens	132
MACRO 	5
Manual focus (MF)	40, 57
Manual shooting M	47
METERING	49, 101
MF	100
MF (manual focus)	57
MF ASSIST	98
Micro Four Thirds system lenses	132
Monitor brightness adjustment 	94
MONOTONE	71
MOVIE 	80, 105
MOVIE AE MODE	79
MOVIE PLAY	86
Movie shooting 	78
MOVIE+STILL	80
MTP	103, 123
Multi view display	42
MULTIPLE EXPOSURE 	54
MUTED 	71
MY MODE	100
MY MODE SETUP	101

N

N (Normal)	64
NATURAL 	71
NATURE MACRO 	5
NIGHT SCENE 	5
NIGHT+PORTRAIT 	5
NOISE FILTER	107
NOISE REDUCT.	107
NTSC	103
Number of pixels	64

O	
OLYMPUS Master	119
One-touch white balance 	69, 100
P	
PAL	103
PALE&LIGHT COLOR 	5
PANORAMA 	5, 43
PICT. TONE	71
PictBridge	115
PICTURE MODE	71
PIN HOLE 	5
Pixel count	64, 109
PIXEL MAPPING	129
POP ART 	5
PORTRAIT 	5
PORTRAIT 	71
Preset white balance	67
PREVIEW	48, 100
PRINT	103, 116
Print reservation	112
PRIORITY SET	110
Program shift Ps	44
Program shooting P	44
Protecting On	91
Q	
QUICK ERASE	109
R	
RAW	65
RAW DATA EDIT	89
RAW 	100
RAW+JPEG ERASE	109
REC VIEW	95
Record mode 	64, 80, 140
REDEYE FIX	89
Red-eye reduction flash 	75
RESET LENS	98
RESET PROTECT	92
Resizing 	89
RLS PRIORITY C	102
RLS PRIORITY S	102
Rotating images 	85
S	
 (Small)	64
S-AF (single AF)	56
S-AF+MF	57
SATURATION	71, 89
Scene mode SCN	5
SD	80
SD/SDHC card	12, 130

Self-timer 	62
SEPIA	89
Sequential shooting 	61
SF (Super Fine)	64
SHADING COMP.	108
SHADOW ADJ	89
SHARPNESS	71
Shutter priority shooting S	46
Shutter speed	16, 44, 46
Single AF (S-AF)	56
Single target AF mode [•]	58
Single-frame erase 	93
Single-frame playback	81
Single-frame protect	91
Single-frame shooting 	61
SLEEP	103
SLIDE	84
Slideshow 	84
Slow synchronization  SLOW	75
Slow synchronization  SLOW2/ 2nd CURTAIN	76
SOFT FOCUS 	5
SPORT 	5
Spot metering – highlight control  HI	49
Spot metering – shadow control  SH	49
Spot metering 	49
sRGB	108
STORAGE	103
Strap	10
SUNSET 	5
Super control panel	7, 23
Super FP flash	74
T	
TEST PICTURE	100
Trimming 	89, 118
U	
USB MODE	103
V	
VIVID 	71
VOLUME	104
W	
WB	68
WB BKT	70
WB compensation	68
White balance bracketing	70
White balance WB	67
Z	
Zoom display	42

