

# **OLYMPUS**

DIGITAL CAMERA

*STYLUS-7020/μ-7020*

*STYLUS-7010/μ-7010*

**Instruction Manual**

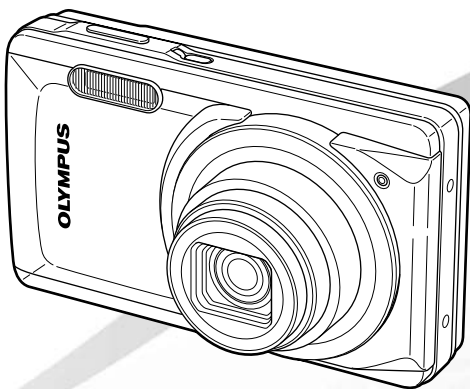

- Thank you for purchasing an Olympus digital camera. Before you start to use your new camera, please read these instructions carefully to enjoy optimum performance and a longer service life. Keep this manual in a safe place for future reference.
- We recommend that you take test shots to get accustomed to your camera before taking important photographs.
- In the interest of continually improving products, Olympus reserves the right to update or modify information contained in this manual.
- The screen and camera illustrations shown in this manual were produced during the development stages and may differ from the actual product. Unless otherwise specified, the explanation about these illustrations is provided for STYLUS-7020/μ-7020.

## Step 1

### Checking the contents of the box



Digital Camera



Strap

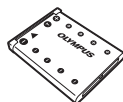

LI-42B Lithium-Ion Battery



LI-41C Battery Charger



USB Cable



AV Cable



microSD Attachment

Other accessories not shown: Instruction Manual (this manual), OLYMPUS Master 2, warranty card  
Contents may vary depending on purchase location.

## Step 2

### Preparing the Camera

"Preparing the Camera" (p. 10)

## Step 3

### Shooting and Playing Back Images

"Shooting, Playback, and Erasing" (p. 14)

## Step 4

### How to Use the Camera

"Three Ways to Adjust Settings" (p. 3)

## Step 5

### Printing

"Direct printing (PictBridge)" (p. 43)  
"Print Reservations (DPOF)" (p. 46)

## Contents

➤ Names of Parts .....	6	➤ Menus for Playback, Editing, and Printing Functions .....	32
➤ Preparing the Camera .....	10	➤ Menus for Other Camera Settings .....	37
➤ Shooting, Playback, and Erasing .....	14	➤ Printing .....	43
➤ Using Shooting Modes .....	17	➤ Using OLYMPUS Master 2 .....	48
➤ Using Shooting Functions .....	19	➤ Usage Tips .....	50
➤ Using Playback Features .....	23	➤ Appendix .....	55
➤ Menus for Shooting Functions .....	25	➤ Index .....	70

## Three Ways to Adjust Settings

### Using the Menu

Various camera settings can be accessed through the menus, including functions used during shooting and playback and the date/time and screen display.

- Some menus may not be selectable due to combinations of functions that have been set or the selected **SCN** mode (p. 29).

- Set the mode dial to a position other than **AUTO**.





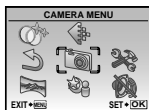

- The  symbol in "Menu Settings" (p. 25 to 42) indicates available shooting modes.

- Press the **MENU** button.

- This example describes how to use the menus to set the [DIGITAL ZOOM].



Shooting mode top menu

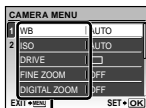

- Use    to select the desired menu, and press the  button.

- Pressing and holding the  button displays an explanation (menu guide) of the selected option.

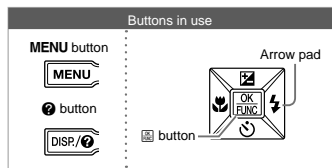

Submenu 1





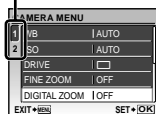

- Use   to select the desired submenu 1, and press the  button.

Page tab

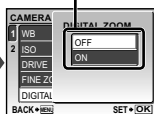



Submenu 2



- To quickly move to the desired submenu, press  to highlight the page tab, and then use   to move the page tab. Press  to return to the submenu 1.

- Some menus include submenus that appear by pressing the  button.

- Use   to select the submenu 2, and press the  button.

- Once a setting is selected, the display returns to the previous screen.

- There may be additional operations. "Menu Settings" (p. 25 to 42)

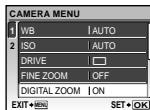

- Press the **MENU** button to complete the setting.

## Using the Direct Buttons

Frequently used shooting functions can be accessed using the direct buttons.



Shutter button (p. 14)



Zoom button (p. 19)



button (exposure compensation) (p. 20)

button (macro) (p. 20)

button (flash) (p. 19)

button (self-timer) (p. 21)

button (playback) (p. 15, p. 32)



DISP. button (change information display/  
menu guide/check date and time) (p. 3, p. 13,  
p. 21)



OR button (panorama/magic filter/  
Shadow Adjustment Technology/multi window/  
backlight boost/erase) (p. 16, p. 22)

## Using the FUNC Menu (p. 22)

Frequently used shooting menu functions can be set with fewer steps using the FUNC menu.

button (p. 3, p. 22)

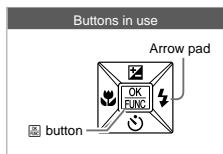

# Menu Index

## Menus for Shooting Functions

When the mode dial is set to a shooting mode position (AUTO ), settings can be adjusted.

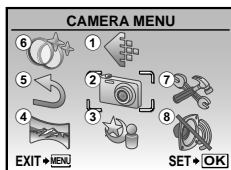

Shooting mode top menu

- |   |   |   |
|---|---|---|
| <ul style="list-style-type: none"> <li>①  IMAGE QUALITY ..... p.25</li> <li>②  CAMERA MENU</li> <li>    WB ..... p.26</li> <li>    ISO ..... p.26</li> <li>    DRIVE ..... p.26</li> <li>    FINE ZOOM ..... p.27</li> <li>    DIGITAL ZOOM ..... p.27</li> <li>    ESP/ ..... p.27</li> <li>    AF MODE ..... p.27</li> <li>    🎤 (Sound recording).... p.28</li> <li>    IMAGE STABILIZER<br/>    (Still images)/<br/>    DIS MOVIE MODE<br/>    (Movies) ..... p.28</li> </ul> | <ul style="list-style-type: none"> <li>③  SHADOW ADJ..... p.28</li> <li>    <b>SCN</b> ..... p.29</li> <li>④  PANORAMA ..... p.30</li> <li>⑤  RESET ..... p.31</li> <li>⑥  MAGIC FILTER ..... p.31</li> <li>⑦  SETUP</li> <li>    MEMORY FORMAT/<br/>    FORMAT ..... p.37</li> <li>    BACKUP ..... p.37</li> <li>    🗣️ (Language) ..... p.37</li> <li>    PW ON SETUP ..... p.37</li> <li>    MENU COLOR ..... p.38</li> <li>    SOUND SETTINGS..... p.38</li> </ul> | <ul style="list-style-type: none"> <li>REC VIEW ..... p.38</li> <li>FILE NAME ..... p.39</li> <li>PIXEL MAPPING ..... p.39</li> <li> (Monitor) ..... p.40</li> <li> (Date/time) ..... p.40</li> <li>DUALTIME ..... p.40</li> <li>PIC ORIENTATION' ..... p.40</li> <li>VIDEO OUT ..... p.41</li> <li>HDMI' ..... p.42</li> <li>POWER SAVE ..... p.42</li> <li>⑧  SILENT MODE ..... p.42</li> </ul> |
|---|---|---|

\* STYLUS-7020/μ-7020 only

## Menus for Playback, Editing, and Printing Functions

When the mode dial is set to the position, settings can be adjusted.



Playback mode top menu

- |   |   |  |
|---|---|--|
| <ul style="list-style-type: none"> <li>①  SLIDESHOW ..... p.32</li> <li>②  PERFECT FIX ..... p.32</li> <li>③  BEAUTY FIX ..... p.33</li> <li>④  EDIT</li> <li>     (Resize) ..... p.33</li> <li>     (Crop) ..... p.33</li> <li>    COLOR EDIT ..... p.34</li> <li>    CALENDAR ..... p.34</li> </ul> | <ul style="list-style-type: none"> <li>FACE FOCUS ..... p.34</li> <li>INDEX ..... p.35</li> <li>EDIT ..... p.35</li> <li>⑤  PLAYBACK MENU</li> <li>     (Protect) ..... p.35</li> <li>     (Rotate) ..... p.35</li> <li>    🎤 (Add sound to still<br/>    images) ..... p.36</li> </ul> | <ul style="list-style-type: none"> <li>⑥  ERASE ..... p.36</li> <li>⑦  PRINT ORDER ..... p.36</li> <li>⑧  SETUP'</li> <li>⑨  SILENT MODE ..... p.42</li> </ul> |
|---|---|--|

\* Same as "Menus for shooting functions"



# Names of Parts

## Camera unit

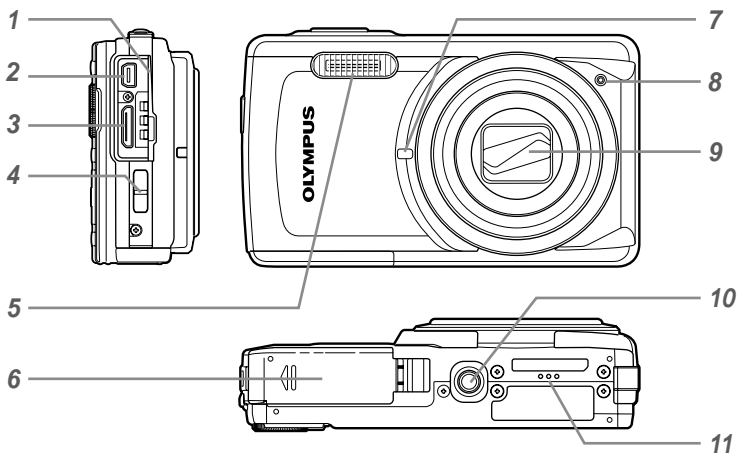

### STYLUS-7010/ $\mu$ -7010

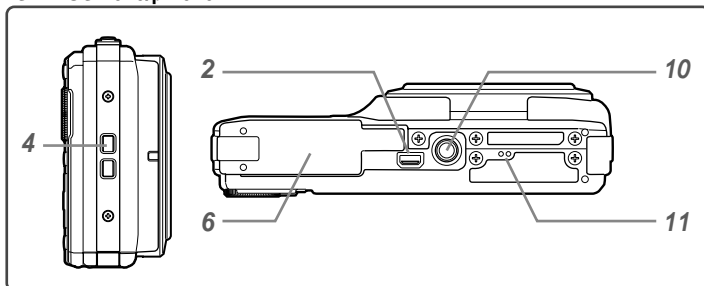

- |   |   |              |    |                      |          |
|---|---|--------------|----|----------------------|----------|
| 1 | Connector cover .....                   | p.41, 43, 48 | 7  | Self-timer lamp..... | p.21     |
| 2 | Multi-connector .....                   | p.41, 43, 48 | 8  | Microphone.....      | p.28, 36 |
| 3 | HDMI mini connector* .....              | p.41         | 9  | Lens.....            | p.55     |
| 4 | Strap eyelet.....                       | p.10         | 10 | Tripod socket .....  | —        |
| 5 | Flash.....                              | p.19         | 11 | Speaker .....        | —        |
| 6 | Battery/card compartment cover<br>..... | p.11, 51     |    |                      |          |

\* STYLUS-7020/ $\mu$ -7020 only

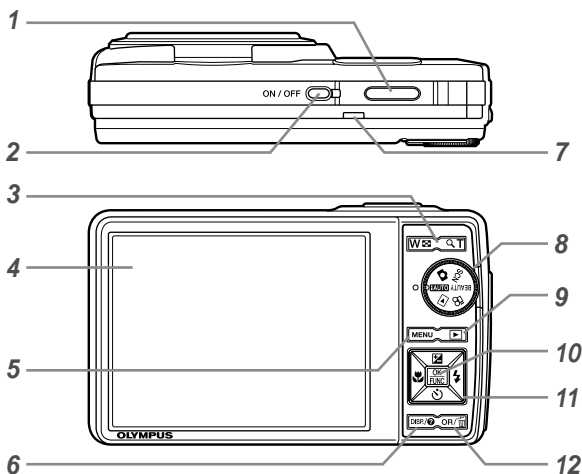

- |   |  |                    |    |  |            |
|---|--|--------------------|----|--|------------|
| 1 | Shutter button   | p.14, 50           | 10 | button (OK/FUNC)   | p.3, 22    |
| 2 | ON/OFF button  | p.14               | 11 | Arrow pad  | p.3, 4, 12 |
| 3 | Zoom button  | p.19, 23           |    | button (exposure compensation)   | p.20       |
| 4 | Monitor  | p.8, 14, 40, 50    |    | button (macro)   | p.20       |
| 5 | MENU button  | p.3, 5             |    | button (self-timer)  | p.21       |
| 6 | DISP./ button (change information display/menu guide/ check date and time) | p.3, 13, 21        |    | button (flash)   | p.19       |
| 7 | Card access lamp   | p.56               | 12 | OR/ button (panorama/magic filter/ Shadow Adjustment Technology/ multi window/backlight boost/erase) | p.16, 22   |
| 8 | Mode dial  | p.3, 5, 14, 15, 17 |    |  |            |
| 9 | button (playback)  | p.15, 32           |    |  |            |

Shooting mode display

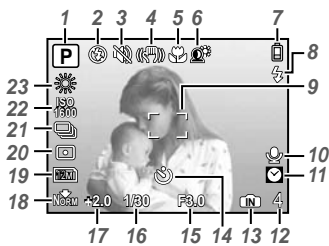

Still image

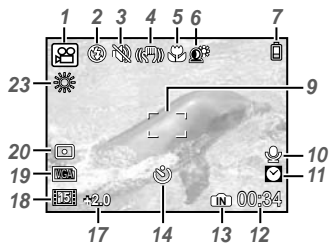

Movie

- 1 Shooting mode..... p.14, 17
- 2 Flash mode..... p.19
- 3 Silent mode..... p.42
- 4 Image stabilization(still images)/  
Digital image stabilization(movie) ... p.28
- 5 Macro/super macro..... p.20
- 6 Shadow Adjustment Technology  
..... p.22, 28
- 7 Battery check..... p.10, 51
- 8 Flash standby/camera shake warning/  
flash charge ..... p.50
- 9 AF target mark ..... p.14
- 10 Recording with sound ..... p.18, 28

- 11 Dualtime..... p.40
- 12 Number of storable still pictures/  
remaining recording time .... p.14, 18, 57
- 13 Current memory..... p.56
- 14 Self-timer ..... p.21
- 15 Aperture value ..... p.14
- 16 Shutter speed ..... p.14
- 17 Exposure compensation ..... p.20
- 18 Compression/frame rate ..... p.25
- 19 Image size ..... p.25
- 20 Metering..... p.27
- 21 Drive ..... p.26
- 22 ISO..... p.26
- 23 White balance..... p.26



## Playback mode display

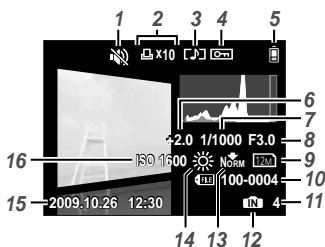

Still image

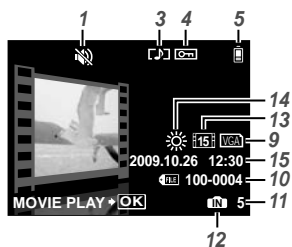

Movie

- |  |  |
|--|--|
| <p><b>1</b> Silent mode ..... p.42</p> <p><b>2</b> Print reservation/<br/>number of prints ..... p.46/p.45</p> <p><b>3</b> Recording with sound ..... p.18, 28, 36</p> <p><b>4</b> Protect ..... p.35</p> <p><b>5</b> Battery check ..... p.10, 51</p> <p><b>6</b> Exposure compensation ..... p.20</p> <p><b>7</b> Shutter speed ..... p.14</p> <p><b>8</b> Aperture value ..... p.14</p> | <p><b>9</b> Image size ..... p.25</p> <p><b>10</b> File number ..... p.39</p> <p><b>11</b> Frame number<br/>Elapsed time/total recording time<br/>..... p.15, 16</p> <p><b>12</b> Current memory ..... p.56</p> <p><b>13</b> Compression/frame rate ..... p.25</p> <p><b>14</b> White balance ..... p.26</p> <p><b>15</b> Date and time ..... p.13, 40</p> <p><b>16</b> ISO ..... p.26</p> |
|--|--|



# Preparing the Camera

## Attaching the camera strap

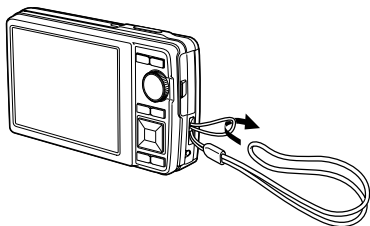

- ⚠ Pull the strap tight so that it does not come loose.

## Charging the battery

- ⚠ The included battery charger (AC cable type or plug-in type) differs depending on the region where you purchased the camera. If you received a plug-in type battery charger, plug it directly into an AC outlet.

### Example: AC cable type battery charger

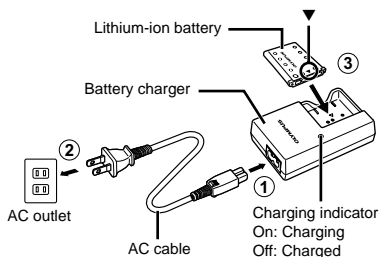

- ⚠ Battery comes partially charged. Before use, be sure to charge the battery until the charging indicator light turns off (up to 2 hours).
- ⚠ If the charging indicator does not light or it blinks, the battery may not be inserted correctly or the battery or the charger may be broken.
- ⚠ For details on the battery and the charger, see "Battery and charger" (p. 55).

### When to charge the battery

Charge the battery when the following error message appears:

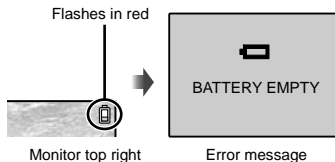

## Loading the battery and the xD-Picture Card™ (sold separately) into the camera

- ❗ Do not insert anything other than an xD-Picture Card or the microSD Attachment into the camera.

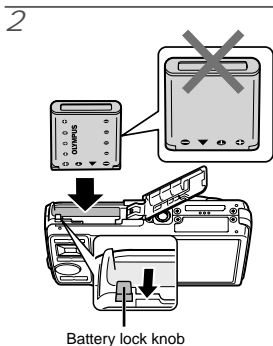
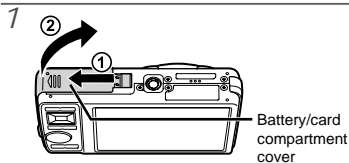

- ❗ The battery has a front side and a back side. Insert the battery from ▼ so that the ⊕ is in the direction of the battery lock knob.
- ❗ Insert the battery while sliding the battery lock knob in the direction of the arrow.
- ❗ Sliding the battery lock knob in the direction of the arrow to unlock, and then remove the battery.
- ❗ If you insert the battery incorrectly, you will not be able to remove it. Do not use force. Contact authorized distributors/service centers.
- ❗ Damage to the battery exterior (scratches, etc.) may produce heat or an explosion.
- ❗ Turn off the camera before opening or closing the battery/card compartment cover.
- ❗ When using the camera, be sure to close the battery/card compartment cover.

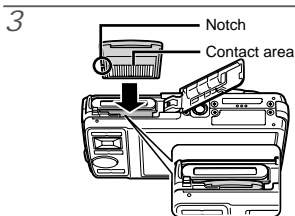

- ❗ Insert the card straight in until it clicks into place.
- ❗ Do not touch the contact area directly with your hand.

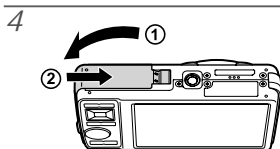

- ❗ This camera can take pictures using the internal memory when no xD-Picture Card (sold separately) is inserted. "Using an xD-Picture Card" (p. 56)
- ❗ "Number of storable pictures (still pictures)/ continuous recording length (movies) in the internal memory and xD-Picture Card" (p. 57)

### To remove the xD-Picture Card

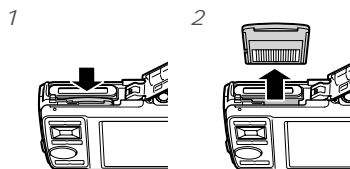

- ❗ Press in the card until it clicks and comes out slightly. Then grasp the card and pull it out.

## Using a microSD card/ microSDHC card (sold separately)

A microSD card or microSDHC card (hereafter both will be referred to as microSD card) is also compatible with this camera using the microSD Attachment.

! "Using the microSD Attachment" (p. 58)

### 1 Insert the microSD card into the microSD Attachment.

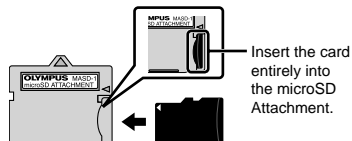

### 2 Insert the microSD Attachment into the camera.

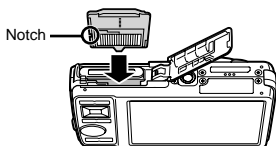

### To remove the microSD card

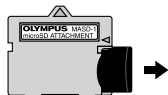

- ! Pull the microSD card straight out.
- ! Do not touch the contact area of the microSD Attachment or microSD card directly with your hand.

## Arrow pad and operation guide

The symbols  $\triangle$ ,  $\nabla$ ,  $\square$ ,  $\leftarrow$ ,  $\rightarrow$ ,  $\updownarrow$ ,  $\boxtimes$  displayed on various settings and movie playback screens indicate that the arrow pad is to be used.

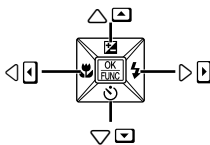
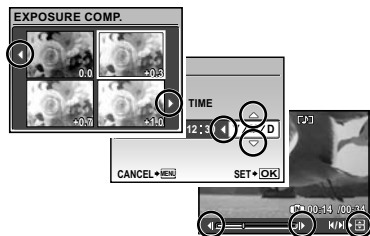

Arrow pad

Operation guides displayed at the bottom of the screen indicate that the **MENU** button,  $\boxtimes$  button, zoom button, or  $\boxtimes$  button is to be used.

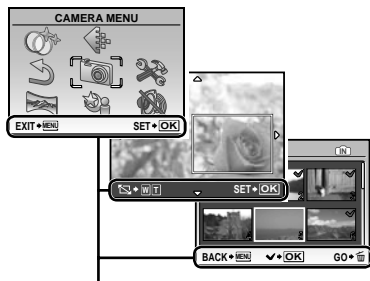

Operation guide

## Setting the date and time

The date and time set here are used to image file names, date prints, and other data.

### 1 Press the ON/OFF button to turn on the camera.

- The date and time setting screen is displayed when the date and time are not set.

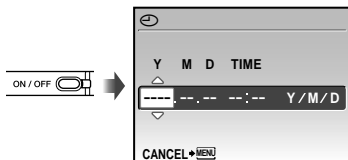

Date and time setting screen

### 2 Use to select the year for [Y].

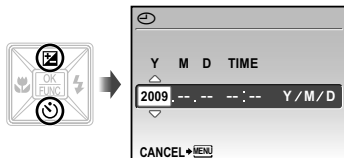

### 3 Press to save the setting for [Y].

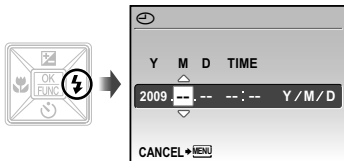

### 4 As in Steps 2 and 3, use and the button to set [M] (month), [D] (day), [TIME] (hours and minutes) and [Y/M/D] (date order).

- ! For precise time setting, press the button as the time signal strikes 00 seconds.
- ! To change the date and time, adjust the setting from the menu. (Date/time) (p. 40)

#### To check the date and time

Press the DISP. button while the camera is turned off. The current time is displayed for approx. 3 seconds.

## Changing the display language

The language of the menu and error messages displayed on the monitor is selectable.

### 1 Press the MENU button, and press to select (SETUP).

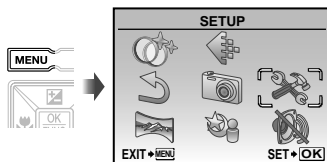

### 2 Press the button.

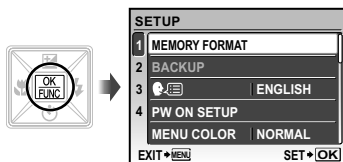

### 3 Use to select and press the button.

### 4 Use to select your language and press the button.

### 5 Press the MENU button.

# Shooting, Playback, and Erasing

## Shooting with optimum aperture value and shutter speed (P mode)

In this mode, automatic camera shooting can be used while also allowing changes to a wide range of other shooting menu functions, such as exposure compensation, white balance and so on as needed.

### 1 Set the mode dial to .



### 2 Press the ON/OFF button to turn on the camera.

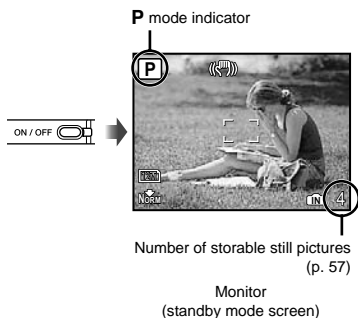

- Press the ON/OFF button again to turn off the camera.

### 3 Hold the camera, and compose the shot.

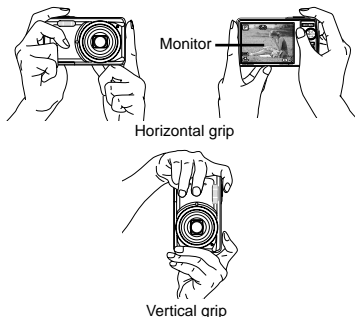

- When holding the camera, take care not to cover the flash with your fingers, etc.

### 4 Press the shutter button halfway down to focus on the subject.

- When the camera focuses on the subject, the exposure is locked (shutter speed and aperture value are displayed), and the AF target mark changes to green.
- The camera was unable to focus if the AF target mark flashes red. Try focusing again.

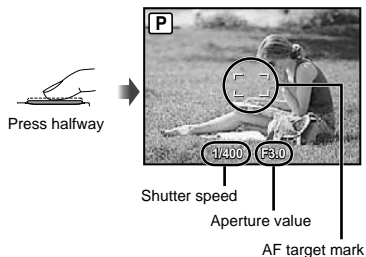

- "Focusing" (p. 52)

- 5 To take the picture, gently press the shutter button all the way down while being careful not to shake the camera.

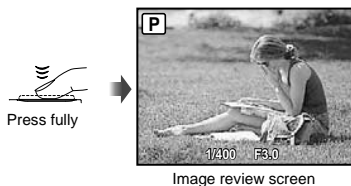

### To view images during shooting

Pressing the button enables playback of images. To return to shooting, either press the button again or press the shutter button halfway down.

### To shoot movies

"Shooting movies ( mode)" (p. 18)

## Viewing images

- 1 Set the mode dial to .

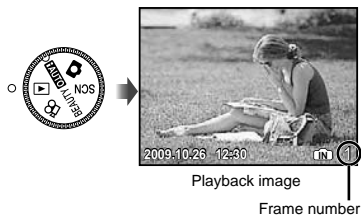

- 2 Use to select an image.

Displays 10 frames before the current image

Displays next image

Displays previous image

Displays 10 frames after the current image



- The display size of the images can be changed. "Index view, calendar view, and close-up view" (p. 23)

### To play back movies

Select a movie, and press the button.



## Operations during movie playback

**Volume:** During playback, press  $\blacktriangleleft$ / $\blacktriangleright$ .  
**Fast-forward/rewind:** Select with  $\blacktriangleleft$ / $\blacktriangleright$ . Each time a button is pressed, the playback speed cycles through 2x, 20x, and standard (1x) speed in the direction of the pressed button.  
**Pause:** Press the  $\square$  button.

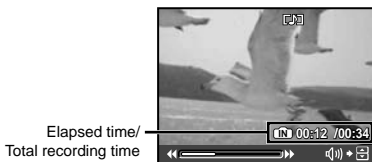

During playback

**First (last) frame/frame advance:**  
While paused, press  $\blacktriangleleft$  to display the first frame, and press  $\blacktriangleright$  to display the last frame. Pressing  $\blacktriangleleft$  makes the camera play back in a reverse motion, and pressing  $\blacktriangleright$  makes the camera play back normally. Press the  $\square$  button to resume playback.



During pause

## To stop movie playback

Press the **MENU** button.

## Erasing images during playback (Single image erase)

- 1 Press the  $\square$  button when the playback image to be erased is displayed.

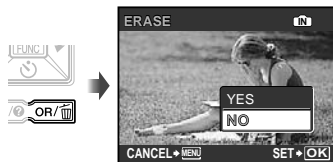

- 2 Press  $\blacktriangleleft$  to select [YES], and press the  $\square$  button.

 [ERASE] (p. 36)



# Using Shooting Modes

This section describes the available shooting modes. Depending on the mode, some settings can be changed. For details on the functions that can be adjusted, see “Menus for Shooting Functions” on page 25.

## Using the best shooting mode for the scene (**SCN** mode)

### 1 Set the mode dial to **SCN**.



- Press and hold the button to display a description of the selected mode.

### 2 Use to select the best shooting mode for the scene, and press the button.

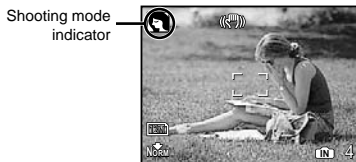

- ! To change to another scene mode, use the menu. [ **SCN**] (p. 29)

## Smoothing out skin tone and texture (**BEAUTY** mode)

The camera finds a person's face and gives the skin a smooth, translucent look for taking the picture.

### 1 Set the mode dial to **BEAUTY**.

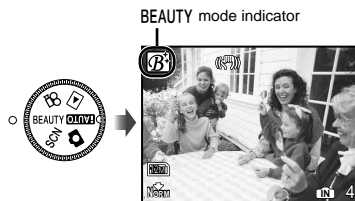

### 2 Point the camera toward the subject. Check the frame appearing around the face detected by the camera, and then press the shutter button to take the picture.

- The unedited image and edited image are both saved.
- If the image cannot be retouched, only the unedited image is saved.
- ! The frame may not appear or may take some time to appear for some subjects. In addition, this function may have no visible effect on some subjects.
- ! The [IMAGE SIZE] of the retouched image is limited to [] or lower.

## Shooting with automatic settings (FAUTO mode)

The camera will automatically select the optimal shooting mode for the scene. This is a fully automatic mode that allows you to take a picture suited to the scene by simply pressing the shutter button. Settings in the shooting function menu are not available in FAUTO mode.

### 1 Set the mode dial to FAUTO.

The indicator changes to the icon for the scene mode selected by the camera.

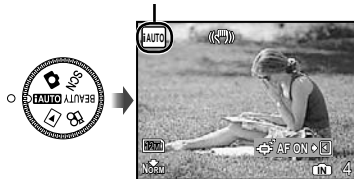

- Press the shutter button halfway down or press the DISP. button to check which shooting mode the camera has automatically selected.
- ! Depending on the shooting scene, the camera may not select the intended shooting mode.
- ! If the camera cannot determine the best shooting mode, the picture will be taken in P mode.

### To focus on a moving subject continuously (AF Tracking)

Press  $\left[ \frac{1}{2} \right]$  to enter the AF tracking standby condition. For details on procedure to start tracking, see "To focus on a moving subject continuously (AF Tracking)" (p. 28).

## Shooting movies (MOV mode)

Audio is recorded simultaneously.

### 1 Set the mode dial to MOV.

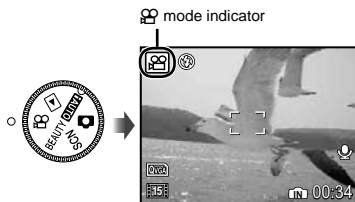

### Using the zoom

You cannot use the optical zoom while shooting a movie. Please use the [DIGITAL ZOOM] (p. 27)

### To shoot a movie with digital image stabilization

[DIS MOVIE MODE] (p. 28)

### 2 Press the shutter button halfway down to focus on the subject, and gently press the button all the way down to start recording.

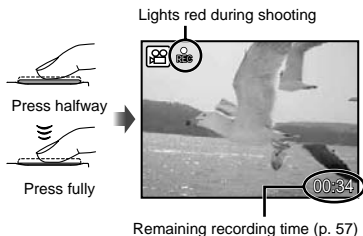

Remaining recording time (p. 57)

### 3 Gently press the shutter button all the way down to stop recording.



# Using Shooting Functions

In addition to the wide variety of shooting modes, the camera has functions that broaden the expressive range and shooting options available to the photographer.

## Using the optical zoom

Pressing the zoom button adjusts the shooting range.

Pressing the wide (W) button

Pressing the telephoto (T) button

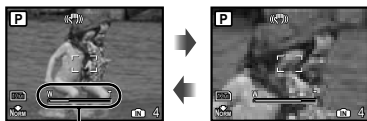

Zoom bar

- ⚠ Optical zoom: 7x / Digital zoom: 5x
- ⚠ Use of [IMAGE STABILIZER] (still images)/ [DIS MOVIE MODE] (movies) (p. 28) is recommended when shooting with the telephoto zoom.

### To take larger images without reducing image quality

[FINE ZOOM] (p. 27)

### To take larger images

[DIGITAL ZOOM] (p. 27)

- ⚠ The zoom bar appearance identifies the status of the fine zoom/digital zoom.

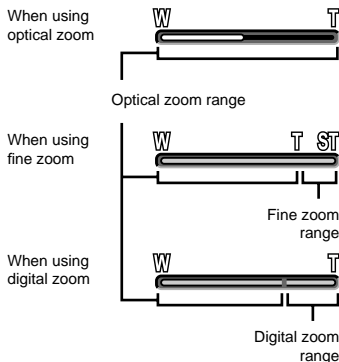

## Using the flash

The flash functions can be selected to best match the shooting conditions and render the desired image.

### 1 Press the button.



### 2 Use to select the setting option, and press the button to set.

Item	Description
FLASH AUTO	The flash fires automatically in low-light or backlight conditions.
REDEYE	Pre-flashes are emitted to reduce the occurrence of red-eye in your photos.
FILL IN	The flash fires regardless of the available light.
FLASH OFF	The flash does not fire.

## Adjusting the brightness (Exposure compensation)

The standard brightness (appropriate exposure) set by the camera based on the shooting mode (except for **FAUTO**) can be adjusted brighter or darker to obtain a desired shot.

### 1 Press the button.

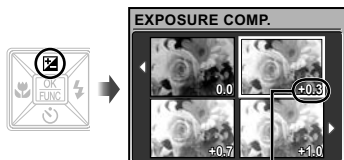

Exposure compensation value

### 2 Use to select the image showing the desired brightness, and then press the button.

## Shooting close-ups (Macro shooting)

This function enables the camera to focus and shoot subjects at close distances.

### 1 Press the button.





### 2 Use to select the setting option, and press the button to set.

Item	Description
OFF	Macro mode is deactivated.
MACRO	This enables shooting as close as 10 cm/3.9 in. <sup>1)</sup> (60 cm/23.6 in. <sup>2)</sup> to the subject.
SUPER MACRO <sup>3)</sup>	This enables shooting as close as 2 cm/0.8 in. to the subject. Subjects at 70 cm/27.6 in. or farther cannot be brought into focus.

<sup>1)</sup> When the zoom is at the widest (W) position.

<sup>2)</sup> When the zoom is at the most telephoto (T) position.

<sup>3)</sup> The zoom is automatically fixed.

 The flash (p. 19) and zoom (p. 19) cannot be set when  SUPER MACRO is selected.

## Using the self-timer

After the shutter button is pressed all the way down, the picture is taken after a time delay.

### 1 Press the button.



### 2 Use to select the setting option, and press the button to set.

Item	Description
OFF	This cancels the self-timer.
ON	The self-timer lamp turns on for approx. 10 seconds, then blinks for approx. 2 seconds, and then the picture is taken.

 Self-timer shooting is automatically canceled after one shot.

### To cancel the self-timer after it starts

Press the  button again.

## Changing the shooting information display

The display of shooting information on the monitor can be changed to best match the situation; for example, the information can be removed if there is a need for a clear view of the subject or a grid can be displayed to assist with precise composition.

### 1 Press the DISP. button.

- The displayed shooting information changes in the order shown below each time the button is pressed. "Shooting mode display" (p. 8)

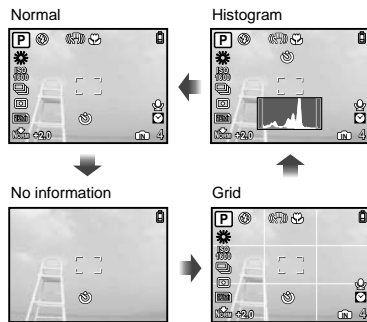

### Reading a histogram

If the peak fills too much of the frame, the image will appear mostly white.

If the peak fills too much of the frame, the image will appear mostly black.

The green section shows luminance distribution within the screen's center.

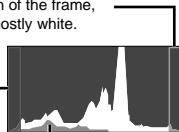





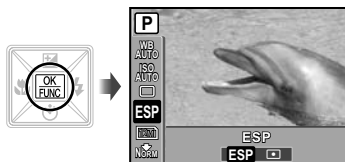

## Using the FUNC menu

The FUNC menu provides the following menu functions that can be quickly accessed, adjusted and set.

- [WB] (p. 26)
- [ESP/□] (p. 27)
- [ISO] (p. 26)
- [ IMAGE QUALITY] (p. 25)
- [DRIVE] (p. 26)

- 1 Press the  button while ready to take a picture.



- 2 Use   to select the menu function and   to select the setting option, and then press the  button to set.



## Quickly calling and using shooting functions

The following menu functions can be quickly called and used.



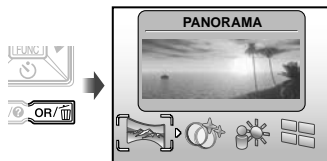

- [PANORAMA] (p. 30)
- [MAGIC FILTER] (p. 31)
- [SHADOW ADJ] (p. 28)
- [MULTI WINDOW] (p. 22)

- 1 Press the  button.



- 2 Use   to select the menu function, and press the  button to set.

### To use the effects preview screen (Multi window)

Selecting an option from [ZOOM], [EXPOSURE COMP.], [WB] or [ESP/□] shows 4 preview images that reflect the adjusted values of the selected shooting function. Use     to select the desired image, and press the  button.

## Brightening the monitor (Backlight boost)

Pressing and holding the  button brightens the monitor. The monitor returns to the original brightness if no operation is performed for 10 seconds.



# Using Playback Features

## Index view, calendar view, and close-up view

Index view and calendar view enable quick selection of a target image. Close-up view (up to 10x magnification) allows checking of image details.

### 1 Press the zoom button.

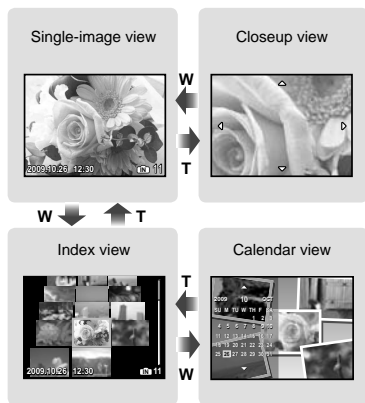

### To select an image in index view

Use to select an image, and press the button to display the selected image in single-image view.

### To select images in calendar view

Use to select a date, and press the button to view the images taken on the selected date.

### To scroll an image in close-up view

Use to move the viewing area.

## Changing the image information display

A set of shooting information displayed on the screen can be changed.

### 1 Press the DISP. button.

- The displayed image information changes in the order shown below each time the button is pressed.

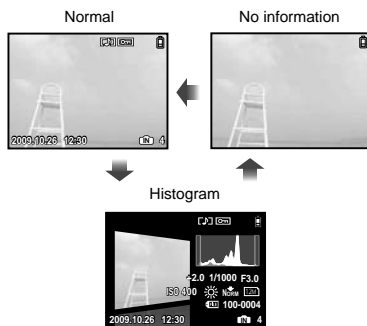

! "Reading a histogram" (p. 21)

## Playing back panorama images

Panorama images that were combined together using [COMBINE IN CAMERA 1] or [COMBINE IN CAMERA 2] can be scrolled for viewing.

- ! "Creating panoramic images [PANORAMA]" (p. 30)

### 1 Select a panorama image during playback.

- ! "Viewing images" (p. 15)





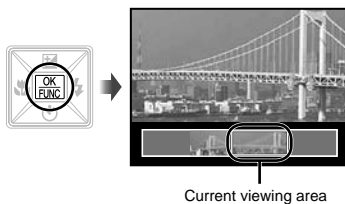

### 2 Press the button.



#### To control panorama image playback

**Zoom in/Zoom out:** Press the zoom button to pause playback and enlarge/shrink the image.

**Playback direction:** Press     to pause playback and scroll the image in the direction of the pressed button.

**Pause:** Press the  button.

**Restart scrolling:** Press the  button.

**Stop playback:** Press the **MENU** button.



# Menus for Shooting Functions

When the mode dial is set to a shooting mode (AUTO SCN BEAUTY ), settings can be adjusted.

- indicates positions of the mode dial at which the function can be set.
- The default settings of the function are highlighted in .

## Selecting the appropriate image quality for your application [ IMAGE QUALITY]

### IMAGE QUALITY



### Still images

Submenu 1	Submenu 2	Application
IMAGE SIZE	12M (3968×2976)	Suitable for printing pictures over A3 (11×17 in.).
	5M (2560×1920)	Suitable for printing pictures at A4 (8.5×11 in.).
	3M (2048×1536)	Suitable for printing pictures up to A4 (8.5×11 in.).
	2M (1600×1200)	Suitable for printing pictures at A5 (5×7 in.).
	1M (1280×960)	Suitable for printing pictures at postcard size.
	VGA (640×480)	Suitable for viewing pictures on a TV or using pictures on emails and web sites.
	16:9 <sup>*1</sup> (3968×2232)	Suitable for conveying the expansiveness of subjects such as landscapes and utilizing the entire screen for viewing pictures on a widescreen TV. Also used for printing pictures at A3 (11×17 in.).
16:9 <sup>*2</sup> (1920×1080)	Suitable for conveying the expansiveness of subjects such as landscapes and utilizing the entire screen for viewing pictures on a widescreen TV. Also used for printing pictures at A5 (5×7 in.).	
COMPRESSION	FINE	Shooting at high quality.
	NORMAL	Shooting at normal quality.

<sup>\*1</sup> This menu is available only for STYLUS-7020/μ-7020.

<sup>\*2</sup> [16:9] is displayed in STYLUS-7010/μ-7010.

### Movies

Submenu 1	Submenu 2	Application
IMAGE SIZE	VGA	Sets image size to 640 × 480. Allows for full-screen television display.
	QVGA	Sets image size to 320 × 240.
FRAME RATE	30fps <sup>*1</sup>	Allows for a smoother image. For prioritizing image quality when shooting.
	15fps <sup>*1</sup>	Setting for shooting with standard image quality. For prioritizing movie length when shooting.

<sup>\*1</sup> frames per second

- "Number of storable pictures (still pictures)/continuous recording length (movies) in the internal memory and xD-Picture Card" (p. 57)

## Adjusting to a natural color scheme [WB]

📷 CAMERA MENU ▶ WB

🔘 : 📷 SCN BEAUTY 📷

Submenu 2	Application
AUTO	The camera automatically adjusts the white balance according to the shooting conditions.
☀️	For shooting outdoors under a clear sky
☁️	For shooting outdoors under a cloudy sky
💡	For shooting under tungsten lighting
💡	For shooting under daylight fluorescent lighting (household lighting, etc.)
💡	For shooting under neutral fluorescent lighting (desk lamps, etc.)
💡	For shooting under white fluorescent lighting (offices, etc.)

## Selecting the ISO sensitivity [ISO]

📷 CAMERA MENU ▶ ISO

🔘 : 📷

- ❗ Abbreviation for the International Organization for Standardization. ISO standards specify the sensitivity for digital cameras and film, thus codes such as "ISO 100" are used to represent sensitivity.
- ❗ In the ISO setting, although smaller values result in less sensitivity, sharp images can be taken under fully lit conditions. Larger values result in higher sensitivity, and images can be taken at fast shutter speeds even under low light conditions. However, high sensitivity introduces noise into the resulting picture, which may give it a grainy appearance.

Submenu 2	Application
AUTO	The camera automatically adjusts the sensitivity according to the shooting conditions.
HIGH ISO AUTO	The camera uses a higher sensitivity compared to [AUTO] to minimize blur caused by a moving subject or by camera shake.
64/100/200/400/800/1600	Set ISO sensitivity to a numerical value.

## Shooting pictures sequentially while the shutter button is held down [DRIVE]

📷 CAMERA MENU ▶ DRIVE

🔘 : 📷 SCN

Submenu 2	Application
📷	One frame is shot each time the shutter button is pressed.
📷 <sup>1</sup>	Take sequential shots using the focus, brightness (exposure) and white balance set in the first frame.
📷	The camera takes sequential shots at a faster speed than in [📷].
📷	The camera takes sequential shots at approximately 11 frames/sec.

<sup>1</sup> The shooting speed varies depending on the settings for [📷 IMAGE QUALITY] (p. 25).

- ❗ When set to [📷], the flash (p.19) cannot be set to [REDEYE]. In addition, when set to [📷], the flash is limited to either [📷 (FILL IN)] or [📷 (FLASH OFF)]. When set to [📷], the flash is fixed to [📷 (FLASH OFF)].
- ❗ When set to [📷] or [📷], [IMAGE SIZE] is limited to [📷] or lower, and [ISO] is fixed to [AUTO]. Moreover, [FINE ZOOM] (p. 27) and [DIGITAL ZOOM] (p. 27) are not available.
- ❗ When set to [📷], [📷], or [📷], [📷] (sound recording) (p. 28) is not available.

### Shooting at higher magnifications than optical zoom without reducing the image quality [FINE ZOOM]

CAMERA MENU ► FINE ZOOM

: SCN BEAUTY

Submenu 2	Application
OFF	Only optical zoom is used to zoom in for shooting.
ON	Optical zoom and image cropping are combined to zoom in for shooting (Approx. 43x (max.)).

- This function will not reduce image quality because it does not convert images with fewer pixels into images with more pixels by adding pixels to a cropped image.
- When set to [ON], [IMAGE SIZE] is limited to [5M] or lower.
- This setting is not available when [DIGITAL ZOOM] is set to [ON].
- This function is not available when [s] SUPER MACRO (p. 20) is selected.

### Shooting at higher magnifications than optical zoom [DIGITAL ZOOM]

CAMERA MENU ► DIGITAL ZOOM

: SCN BEAUTY

Submenu 2	Application
OFF	Only optical zoom is used to zoom in for shooting.
ON	Optical zoom and digital zoom are combined to zoom in for shooting (Approx. 35x (max.)).

- The setting is not available when [FINE ZOOM] is set to [ON].
- This function is not available when [s] SUPER MACRO (p. 20) is selected.

### Selecting the method for measuring the brightness [ESP/spot]

CAMERA MENU ► ESP/spot

: SCN

Submenu 2	Application
ESP	Shoots to obtain a balanced brightness over the entire screen (Meters the brightness at the center and surrounding areas of the screen separately).
(spot)	Shoots the subject at the center during backlighting.

- When set to [ESP], the center may appear dark when shooting against strong backlighting.

### Selecting the focusing area [AF MODE]



CAMERA MENU ► AF MODE

: SCN

Submenu 2	Application
FACE DETECT <sup>1</sup>	This is used for taking pictures of people (The camera automatically detects a face and a frame appears. Press the shutter button halfway down, and when the face is in focus, the green AF target mark appears. The orange target mark indicates that the area other than the face is in focus).
iESP	This enables you to compose the shot without worrying about the focusing position. The camera finds the subject to focus on and automatically adjusts the focus.
SPOT	The camera focuses on the subject located within the AF target mark.
AF TRACKING	The camera tracks the subject movement automatically to focus on it continuously.

<sup>1</sup> For some subjects, the frame may not appear or may take some time to appear.

### To focus on a moving subject continuously (AF Tracking)

- ① Hold the camera to align the AF target mark on the subject and press .
  - ② When the camera recognizes the subject, the AF target mark automatically tracks the subject movement to focus on it continuously.
  - ③ To cancel the tracking, press  or any other buttons.
- ❗ Depending on the subjects or the shooting conditions, the camera may be unable to lock the focus or fail to track the subject movement.
  - ❗ When the camera fails to track the subject movement, the AF target mark changes to red.

### Recording sound when shooting still images [U]

 CAMERA MENU ► 

 :  SCN

Submenu 2	Application
OFF	No sound is recorded.
ON	The camera automatically starts recording for approx. 4 seconds after taking the picture. This is useful for recording notes or comments about the picture.

- ❗ When recording, aim the microphone (p. 6) at the source of the sound you want to record.

### Reducing the blur caused by the camera shake when shooting [IMAGE STABILIZER] (still images) / [DIS MOVIE MODE] (movies)

 CAMERA MENU ► IMAGE STABILIZER / DIS MOVIE MODE

 :  SCN BEAUTY 

Submenu 2	Application
OFF	The image stabilizer is deactivated. This is recommended for shooting when the camera is fixed in place on a tripod or other stable surface.
ON	The image stabilizer is activated.

- ❗ The camera's default settings are [IMAGE STABILIZER] (still images) to [ON] and [DIS MOVIE MODE] (movies) to [OFF].
- ❗ There may be a noise coming from inside the camera when the shutter button is pressed with [IMAGE STABILIZER] (still images) set to [ON].
- ❗ Images may not be stabilized if camera shake is too severe.
- ❗ When the shutter speed is extremely slow, such as when taking still shots or taking pictures at night, the stabilizer may not be as effective.
- ❗ When shooting while the [DIS MOVIE MODE] (movies) is set to [ON], the image will be enlarged somewhat before saving.

### Brightening the subject against backlight [SHADOW ADJ]

 CAMERA MENU ► SHADOW ADJ

 :  SCN BEAUTY 

Submenu 2	Application
OFF	Shoots without using [SHADOW ADJ].
ON	The camera finds a person's face that has been darkened by backlight and makes it appear brighter for taking the picture. (Point the camera toward the subject. Check the frame that appears around the face detected by the camera, and then press the shutter button to take the picture.)















- ❗ For some subjects, the frame may not appear or may take some time to appear.
- ❗ When set to [ON], [ESP/] (p. 27) is automatically fixed to [ESP], and [AF MODE] (p. 27) is automatically fixed to [FACE DETECT].

## Selecting a scene mode according to the shooting situation [ **SCN**]

### **SCN**

 : **SCN**

- ! In **SCN** mode, the optimum shooting settings are pre-programmed for specific shooting scenes. For this reason, settings may not be changed in some modes.



Submenu 1	Application
<ul style="list-style-type: none"> <li> PORTRAIT/</li> <li> LANDSCAPE/</li> <li> NIGHT SCENE<sup>1)</sup>/</li> <li> NIGHT+PORTRAIT/</li> <li> SPORT/</li> <li> INDOOR/</li> <li> CANDLE/</li> <li> SELF PORTRAIT/</li> <li> SUNSET<sup>1)</sup>/</li> <li> FIREWORKS<sup>1)</sup>/</li> <li> CUISINE/</li> <li> DOCUMENTS/</li> <li> BEACH &amp; SNOW/</li> <li> PRE-CAPTURE MOVIE/</li> <li> PET</li> </ul>	<p>The camera takes a picture using the optimum settings for the scene conditions.</p>



- <sup>1)</sup> When the subject is dark, noise reduction is automatically activated. This approximately doubles the shooting time, during which no other pictures can be taken.

### Shooting with a selected scene





"Using the best shooting mode for the scene (**SCN** mode)" (p. 17)

### Capturing the perfect moment when shooting ( **PRE-CAPTURE MOVIE** mode)

- Use  to select [ **PRE-CAPTURE MOVIE**], and press the  button to set.
  - This function is ready for shooting immediately after setting this option.
- Press the shutter button to start movie shooting.
  - After shooting stops, the camera saves a 7-second movie, including up to 2 seconds of recording time taken before the shutter button was pressed, to the memory card.
  - The optical zoom and auto focus function are available during movie recording.

- ! Sound is not recorded.
- ! The AF target mark is not displayed.
- ! Select [IMAGE SIZE] from [VGA] or [QVGA], and select [FRAME RATE] from [ 30] 30fps) or [ 15] 15fps).

### Taking pictures of a moving subject like a pet ( **PET**) mode)

- Use  to select [ **PET**], and press the  button to set.
- Hold the camera to align the AF target mark on the subject and press .
  - When the camera recognizes the subject, the AF target mark automatically tracks the subject movement to focus on it continuously. "To focus on a moving subject continuously (AF Tracking)" (p. 28).

## Creating panoramic images

### [ PANORAMA]

#### PANORAMA



Submenu 2	Application
COMBINE IN CAMERA 1**	Three frames are taken and combined by the camera. The user only composes the shots so that the target marks and pointers overlap, and the camera automatically releases the shutter. The shooting functions are already preset to the optimum settings for panoramic shooting.
COMBINE IN CAMERA 2	Three frames are taken and combined by the camera. The user composes the shots using the guide frame and manually releases the shutter.
COMBINE IN PC	The frames that were taken are combined into a panorama image using the OLYMPUS Master 2 software from the provided CD-ROM. Pictures are taken in the last [ISO] or [SCN] settings. (Excluding certain scenes.)

\*\* Not available in **SCN** mode (p. 17).

- The [ IMAGE QUALITY] (p. 25) setting cannot be changed.
- The focus, exposure (p. 14), zoom position (p. 19), and [WB] (p. 26) are locked at the first frame.
- The flash (p. 19) is fixed to (FLASH OFF) mode.
- "Playing back panorama images" (p. 24)

## Taking pictures with

### [COMBINE IN CAMERA 1]

- ① Press the shutter button to take the first frame.
- ② Move the camera slightly in the direction of the second frame.



Screen when combining images from left to right

- ③ Move the camera slowly while keeping it straight, and stop the camera where the pointer and target mark overlap.
  - The camera releases the shutter automatically.



- To combine only two pictures, press the button before taking a third frame.
- ④ Repeat Step ③ to take a third frame.
    - After the third frame is taken, the camera automatically processes the frames and the combined panorama image is displayed.
  - To exit the panorama function without saving an image, press the **MENU** button.
  - If the shutter does not automatically release, try [COMBINE IN CAMERA 2] or [COMBINE IN PC].

## Taking pictures with [COMBINE IN CAMERA 2]

- Use to specify at which edge the next picture is to be connected.

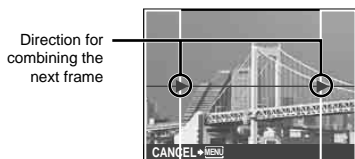

- Press the shutter button to take the first frame.

- A guide frame appears as a reference.

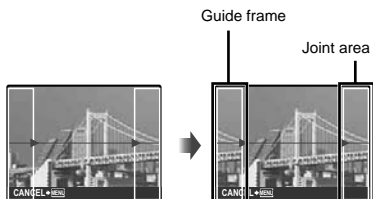

1st frame

- Compose the next shot so that the joint area overlaps the guide frame.



Composition of the 2nd frame

- Press the shutter button to take the next shot.

- To combine only two pictures, press the button before taking the third frame.

- Repeat steps ③ and ④ to take a third frame.

- After the third frame is taken, the camera automatically processes the frames and the combined panorama image is displayed.

- To exit the panorama function without saving an image, press the **MENU** button.

## Taking pictures with [COMBINE IN PC]

- Use to select the direction that the frames are combined.
  - Press the shutter button to take the first frame, and then compose the second shot.
    - Compose the shot using the guide frame so that the two adjacent frames overlap.
  - Repeat Step ② until the number of required frames are taken, and then press the button when done.
- When the mark is displayed, you cannot continue shooting any further. Panorama shooting is possible for up to 10 frames.
  - Refer to the OLYMPUS Master 2 help guide for details on how to make panorama images.

## Restoring the shooting functions to the default settings [↶ RESET]

↶ RESET



Submenu 1	Application
YES	Restores the following menu functions to the default settings: <ul style="list-style-type: none"> <li>Flash (p. 19)</li> <li>Exposure compensation (p. 20)</li> <li>Macro (p. 20)</li> <li>Self-timer (p. 21)</li> <li>[ IMAGE QUALITY] (p. 25)</li> <li>[ PANORAMA] (p. 30)</li> <li>[ SCN] (p. 29)</li> <li>Shooting information display (p. 21)</li> <li>[ MAGIC FILTER] (p. 31)</li> <li>Menu functions in [ CAMERA MENU] (p. 26 to 28)</li> </ul>
NO	The current settings are not changed.

## Shooting with special effects [ MAGIC FILTER]

MAGIC FILTER



- Use to select the desired effect, and press the button.
- After selecting the desired effect by pressing the button, all functions except zoom cannot be changed.

# Menus for Playback, Editing, and Printing Functions

! The default settings of the function are highlighted in  .

When the mode dial is set to , settings can be adjusted during image playback.

## Playing back pictures automatically [ SLIDESHOW]



### SLIDESHOW

Submenu 1	Submenu 2 <sup>2</sup>	Submenu 3	Application
ALL/ STILL PICTURE/ MOVIE/CALENDAR <sup>1</sup>	NORMAL/ NEXT PAGE 1/ NEXT PAGE 2/ FLIP/SWIVEL/ZOOM UP/ SLIDE/FADER/ CHECKERBOARD/ BLINDS/RANDOM	STYLUS-7020/μ-7020: OFF/STANDARD/ SPEED/CYBER/AQUA/ SHINY STYLUS-7010/μ-7010: OFF/1/2	Selects, respectively, the content to be included in the slideshow, the type of transition effect used between slides, and the background music options.

<sup>1</sup> When [CALENDER] is selected, the calendar view screen will appear. Selecting the date in the calendar view screen displays Submenu 3.

<sup>2</sup> Only when [STILL PICTURE] is selected in Submenu 1.

### To start a slideshow

The slideshow starts after confirming [BGM] settings and pressing the  button. To stop the slideshow, press the  button or the **MENU** button.





## Retouching images [ PERFECT FIX]

### PERFECT FIX

! Depending on the picture, the editing may not be effective.

! The retouching process may lower the image resolution.

Submenu 1	Application
ALL	[SHADOW ADJ] and [REDEYE FIX] are applied together.
SHADOW ADJ	Only sections darkened by backlighting and dim lighting are brightened.
REDEYE FIX	Eyes that are reddened by the flash are corrected.

- 1 Select a correction item using , , and press the  button.
- 2 Use  to select an image for retouching, and press the  button.
  - The retouched image is saved as a separate image.



## Retouching the skin and eyes

### [] BEAUTY FIX

#### BEAUTY FIX

- ⓘ Depending on the picture, the editing may not be effective.

Submenu 1	Submenu 2	Application
ALL	—	[CLEAR SKIN], [SPARKLE EYE] and [DRAMATIC EYE] are applied together.
CLEAR SKIN	SOFT/AVG/ HARD	Makes skin look smooth and translucent. Select the correction effect from 3 levels.
SPARKLE EYE	—	Enhances the contrast of the eyes.
DRAMATIC EYE	—	Enlarges the subject's eyes.

- Use to select a correction item, and press the button.
- Use to select an image for retouching, and press the button.
  - The retouched image is saved as a separate image.

### When [CLEAR SKIN] is selected

Use to select the retouching level, and press the button.



## Changing the image size []

### EDIT

Submenu 2	Application
VGA 640 x 480	This saves a lower-resolution copy of the selected image for use in e-mail attachments and other applications.
QVGA 320 x 240	

- Use to select an image and press the button.
- Use to select an image size and press the button.
  - The resized image is saved as a separate image.

## Cropping a picture []

### EDIT

- Use to select an image, and press the button.
- Use the zoom button to select the size of the cropping frame, and use to move the frame.



- Press the button after you have selected the area to trim.
  - The edited image is saved as a separate image.

## Changing the color tone of image [COLOR EDIT]

EDIT ► COLOR EDIT

Submenu 2	Application
Black & white	This changes the image to black and white.
Sepia	This changes the image to a sepia tone.
Saturation (hard)	This increases the color saturation of the image.
Saturation (soft)	This slightly increases the color saturation of the image.

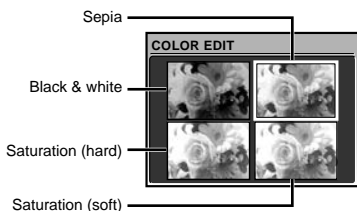

- Use  $\leftarrow \rightarrow$  to select an image, and press the  $\left[ \text{OK} \right]$  button.
- Use  $\left[ \text{Left} \right] \left[ \text{Right} \right] \left[ \text{Up} \right] \left[ \text{Down} \right]$  to select the desired color, and press the  $\left[ \text{OK} \right]$  button.
  - The image with the selected color is saved as a separate image.

## Adding a calendar to an image [CALENDAR]

EDIT ► CALENDAR

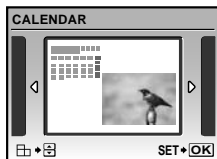

- Use  $\leftarrow \rightarrow$  to select an image, and press the  $\left[ \text{OK} \right]$  button.
- Use  $\leftarrow \rightarrow$  to select a calendar. Use  $\left[ \text{Left} \right] \left[ \text{Right} \right]$  to select the image orientation, and then press the  $\left[ \text{OK} \right]$  button.
- Use  $\left[ \text{Left} \right] \left[ \text{Right} \right]$  to select the Year of the calendar, and press  $\left[ \text{OK} \right]$ .
- Use  $\left[ \text{Left} \right] \left[ \text{Right} \right]$  to select the Month of the calendar, and press the  $\left[ \text{OK} \right]$  button.
  - The edited image is saved as a separate image.

## Highlighting a face with blurry effect around it [FACE FOCUS]

EDIT ► FACE FOCUS

- !** A face that is largest and facing front in the picture is detected as a target. In some images, such target may not be detected, and editing cannot be performed.

1 Use  $\leftarrow \rightarrow$  to select an image, and press the  $\left[ \text{OK} \right]$  button.

  - The edited image is saved as a separate image.

## Creating an index of 9 frames from a movie [INDEX]

EDIT ► INDEX



- Use  $\leftarrow$  and  $\rightarrow$  to select a movie, and press the  $\left[ \text{MENU} \right]$  button.
- Use  $\leftarrow$  and  $\rightarrow$  to select the first frame, and press the  $\left[ \text{MENU} \right]$  button.
- Use  $\leftarrow$  and  $\rightarrow$  to select the last frame, and press the  $\left[ \text{MENU} \right]$  button.

- Nine frames are extracted from a movie and saved as a new still image (INDEX).

## Extracting a clip from a movie [EDIT]

EDIT ► EDIT

Submenu 2	Application
NEW FILE	The original movie is left unchanged, and a clip from the movie is saved as a separate movie.
OVERWRITE	A portion of the original movie overwrites and replaces the original movie.

- Use  $\leftarrow$  and  $\rightarrow$  to select a movie.
- Use  $\leftarrow$  and  $\rightarrow$  to select either [NEW FILE] or [OVERWRITE] and press the  $\left[ \text{MENU} \right]$  button.
- Use  $\leftarrow$  and  $\rightarrow$  to select the first frame of the clip to be extracted, and press the  $\left[ \text{MENU} \right]$  button.

- While selecting the first or last frame, pressing  $\leftarrow$  and  $\rightarrow$  moves to the first/last frame of the movie.

- Use  $\leftarrow$  and  $\rightarrow$  to select the last frame of the clip to be extracted, and press the  $\left[ \text{MENU} \right]$  button.

- The extracted movie clip is saved.

## Protecting images [ON]

PLAYBACK MENU ► ON

- ! Protected images cannot be erased by [ERASE] (p. 16), [SEL. IMAGE], or [ALL ERASE] (p. 36), but all images are erased by [MEMORY FORMAT]/[FORMAT] (p. 37).

Submenu 2	Application
OFF	Images can be erased.
ON	Images are protected so that they cannot be erased except by formatting of the internal memory/card.

- Use  $\leftarrow$  and  $\rightarrow$  to select an image.
- Use  $\leftarrow$  and  $\rightarrow$  to select [ON].
- If necessary, repeat Steps ① and ② to protect other images, and press the  $\left[ \text{MENU} \right]$  button.

## Rotating images [ROT]

PLAYBACK MENU ► ROT

Submenu 2	Application
$\curvearrowright$ +90°	The image is rotated 90° clockwise.
$\blacksquare$ 0°	The image is not rotated.
$\curvearrowleft$ -90°	The image is rotated 90° counter-clockwise.

- Use  $\leftarrow$  and  $\rightarrow$  to select an image.
- Use  $\leftarrow$  and  $\rightarrow$  to select the rotation direction.
- If necessary, repeat Steps ① and ② to adjust settings for other images, and press the  $\left[ \text{MENU} \right]$  button.

- ! The new picture orientations will be saved even after the power is turned off.

## Adding sound to still images [U]

▶ PLAYBACK MENU ▶ U

Submenu 2	Application
YES	The camera adds (records) sound for approx. 4 seconds while playing back the image. This is useful for recording notes or comments about the image.
NO	No sound is recorded.

- 1 Use to select an image.
- 2 Aim the microphone toward the sound source.

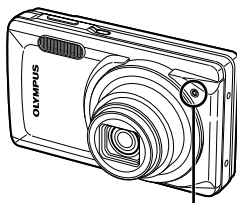

Microphone

- 3 Use to select [YES], and press the button.
  - Recording starts.

## Erasing images [ERASE]

ERASE

- ! Before erasing, check that no important data is left in the internal memory or card.

Submenu 1	Application
SEL. IMAGE	Images are individually selected and erased.
ALL ERASE	All images in the internal memory or card are erased.

- ! When erasing pictures in the internal memory, do not insert the card into the camera.
- ! When erasing pictures from the card, insert a card into the camera in advance.

### To individually select and erase images [SEL. IMAGE]

- 1 Use to select [SEL. IMAGE], and press the button.
- 2 Use to select the image to be erased, and press the button to add a mark to the image.



mark

- 3 Repeat Step 2 to select the images to be erased, and then press the button to erase the selected images.
- 4 Use to select [YES], and press the button.
  - The images with a mark are erased.

### To erase all images [ALL ERASE]

- 1 Use to select [ALL ERASE], and press the button.
- 2 Use to select [YES], and press the button.

## Saving print settings to the image data [PRINT ORDER]

PRINT ORDER

- ! "Print Reservations (DPOF)" (p. 46)
- ! Print reservation can be set only for still images that are recorded to the card.

# Menus for Other Camera Settings

! The default settings of the function are highlighted in  .

## Erasing data completely [MEMORY FORMAT]/[FORMAT]

SETUP ► MEMORY FORMAT/FORMAT

- ! Before formatting, check that no important data is left in the internal memory or card.
- ! Non-Olympus cards and cards that have been formatted by a computer must be formatted with this camera before use.

Submenu 2	Application
YES	Completely erases the image data in the internal memory <sup>1</sup> or card (including protected images).
NO	Cancels formatting.

<sup>1</sup> Be sure to remove the card before formatting the internal memory.

## Copying images from the internal memory to the card [BACKUP]

SETUP ► BACKUP

Submenu 2	Application
YES	Backs up image data from the internal memory to the card.
NO	Cancels the backup.

- ! It takes some time to back up data. Check that the battery has sufficient power before starting the backup, or use a separately sold AC adapter.  
"Using an AC adapter (STYLUS-7020/µ-7020 only)" (p. 56)

## Changing the display language [ ]

SETUP ► [ ]

! "Changing the display language" (p. 13)

Submenu 2	Application
Languages <sup>1</sup>	The language for the menus and error messages displayed on the monitor is selected.

<sup>1</sup> The available languages vary depending on the country and/or region where the camera was purchased.

## Setting the startup display screen and sound when the camera is turned on [PW ON SETUP]

SETUP ► PW ON SETUP

Submenu 2	Submenu 3	Application
SCREEN	OFF	No image is displayed.
	1	A preset image <sup>1</sup> is displayed.
VOLUME <sup>2</sup>	2	A still image stored in the internal memory or card is registered for display. (This option leads to the setup screen.)
	OFF (No sound)/LOW/HIGH	The volume of the startup sound is selected.

<sup>1</sup> This image cannot be changed.

<sup>2</sup> When [SCREEN] is set to [OFF], this setting is not available.

### To register a startup image

- ① Select [2] in submenu 3 for [SCREEN] and press the [ ] button.
- ② Use [ ] to select the image to be registered, and press the [ ] button.



## Selecting the menu screen color and background [MENU COLOR]



 SETUP ► MENU COLOR

Submenu 2	Application
NORMAL/COLOR 1/ COLOR 2/COLOR 3	Selects the menu screen color or background image according to your preference.

## Selecting the camera sound and its volume [SOUND SETTINGS]

 SETUP ► SOUND SETTINGS

Submenu 2	Submenu 3	Submenu 4	Application
BEEP	SOUND TYPE	1/2	Selects the operating sound and volume of the camera buttons (except the shutter button).
	VOLUME	OFF (No sound)/ LOW/HIGH	
SHUTTER SOUND	SOUND TYPE	1/2/3	Selects the shutter sound and volume.
	VOLUME	OFF (No sound)/ LOW/HIGH	
	OFF (No sound)/ LOW/HIGH	—	Adjusts the warning sound volume.
 VOLUME	OFF (No sound) or 5 volume levels	—	Adjusts the image playback volume.

 To turn off all sounds at once, make the setting from  SILENT MODE] (p. 42).

## Viewing the image immediately after shooting [REC VIEW]

 SETUP ► REC VIEW

Submenu 2	Application
OFF	The image being recorded is not displayed. This allows the user to prepare for the next shot while following the subject in the monitor after shooting.
ON	The image being recorded is displayed. This allows the user to make a brief check of the image that was just taken.

 Even when set to [ON], you can resume shooting while the image is being displayed.

## Resetting the file names of pictures [FILE NAME]

SETUP ► FILE NAME

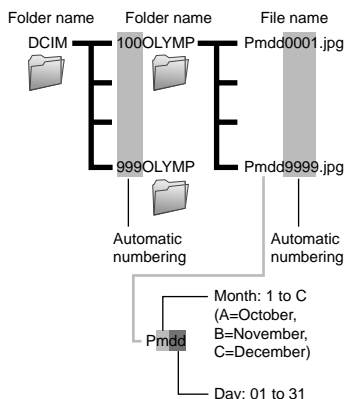

## Adjusting the CCD and the image processing function [PIXEL MAPPING]

SETUP ► PIXEL MAPPING

- ! This function has already been adjusted at factory shipping, and no adjustment is needed right after purchase. Approximately once a year is recommended.
- ! For best results, wait at least one minute after taking or viewing pictures before performing pixel mapping. If the camera is turned off during pixel mapping, be sure to perform it again.

### To adjust the CCD and the image processing function

Press the button when [START] (submenu 2) is displayed.

- The camera checks and adjusts the CCD and the image processing function at the same time.

Submenu 2	Application
RESET	This resets the sequential number for the folder name and file name whenever a new card is inserted. <sup>*1</sup> This is useful when grouping images on separate cards.
AUTO	Even when a new card is inserted, this continues the numbering for the folder name and file name from the previous card. This is useful for managing all image folder names and files names with sequential numbers.

<sup>\*1</sup> The number for the folder name is reset to 100, and the one for the file name is reset to 0001.

## Adjusting the brightness of the monitor [ ]



### To adjust the monitor brightness

- Use to adjust the brightness while viewing the screen, and then press the button.



## Setting the date and time [ ]



- “Setting the date and time” (p. 13)

### To select the date display order

- Press after setting Minute, and use to select the date display order.

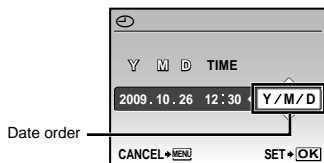

## Setting the date and time for another time zone [DUALTIME]



- When [DUALTIME] is set to [ON], the date and time set here are used in image file names, dated prints and other data.

Submenu 2	Submenu 3	Application
OFF	—	Switches to the date and time set in [ ].
ON	(Proceeds to the setting screen <sup>1</sup> .)	The date and time settings from [DUALTIME] are used in file names, dated prints and other data.

<sup>1</sup> The setting procedure is identical to that in “Setting the date and time” (p. 13).

- The date display order is the same as that set with [ ].

## Automatically rotating images shot with the camera in a vertical position during playback [PIC ORIENTATION] (STYLUS-7020/μ-7020 only)



- During shooting, the (p.35) setting on the playback menu is set automatically.
- This function may not work properly if the camera is facing upwards or downwards during shooting.

Submenu 2	Application
OFF	Information about the vertical/horizontal orientation of the camera during shooting is not recorded with images. Images shot with the camera in a vertical position are not rotated during playback.
ON	Information about the vertical/horizontal orientation of the camera during shooting is recorded with images. Images are automatically rotated during playback.



## Selecting the video signal system to match your TV [VIDEO OUT]

### SETUP ► VIDEO OUT

- ! The TV video signal system varies depending on the countries and regions. Before viewing camera images on your TV, select the video output according to your TV's video signal type.

Submenu 2	Application
NTSC	The camera is compatible with TVs in North America, Taiwan, Korea, Japan and others.
PAL	The camera is compatible with TVs in Europe, China and others.

- ! The factory default settings differ according to the region where the camera is sold.

### To play back camera images on a TV

- ① Connect the TV and camera.

• Connection via AV cable

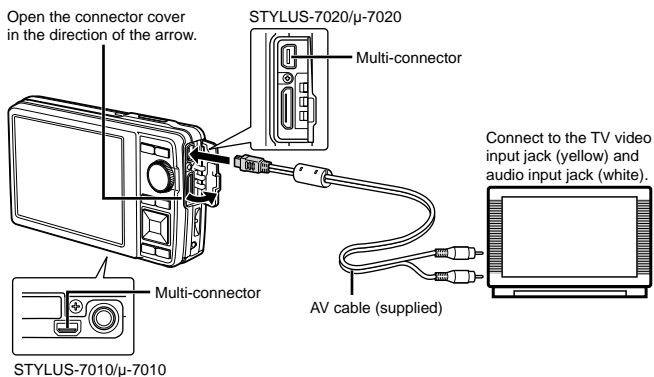

• Connection via HDMI cable (STYLUS-7020/μ-7020 only)

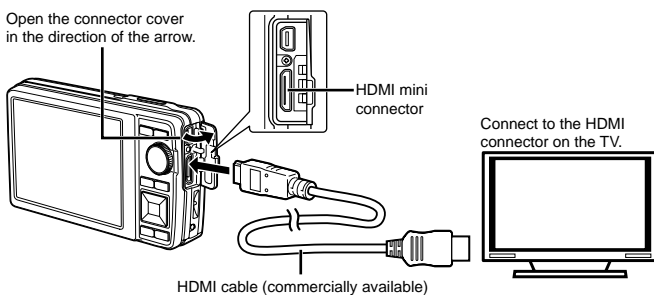

- ② Use the camera to select the video signal format that matches that of the connected TV ((NTSC)/(PAL)).
- ③ Turn on the TV, and change "INPUT" to "VIDEO (an input jack connected to the camera)."

- ! For details on changing the input source of the TV, refer to the TV's instruction manual.
- ! Set the mode dial to  when connecting via an AV cable.
- ! Use an HDMI cable that matches the HDMI mini connector on the camera and the HDMI connector on the TV.
- ! The movie playback screen cannot be displayed when connecting via an HDMI cable. In addition, the sound will not be played.
- ! When the camera and TV are connected by both an AV cable and an HDMI cable, the HDMI cable will take priority.
- ! Depending on the TV's settings, the displayed images and information may become cropped.

### Selecting the digital video signal format for connecting to a TV via an HDMI cable [HDMI] (STYLUS-7020/ $\mu$ -7020 only)

 SETUP ► HDMI

- ! "To play back camera images on a TV" (p. 41)

Submenu 2	Application
480p	Images are played back in 480p format.
720p	Images are played back in 720p format.
1080i	Images are played back in 1080i format.

- ! When set to [1080i], 1080i format takes priority for HDMI output. However, if this setting does not match the input setting of the TV, the signal format is changed first to 720p and then to 480p. For details on changing the input setting of the TV, refer to the TV's instruction manual.

### Saving battery power between shots [POWER SAVE]

 SETUP ► POWER SAVE

Submenu 2	Application
OFF	Cancels [POWER SAVE].
ON	When the camera is not being used for approx. 10 seconds, the monitor automatically turns off to save battery power.

#### To resume standby mode

Press any button or turn the mode dial.

### Turning off the camera sounds [SILENT MODE]

 SILENT MODE

Submenu 1	Application
OFF	This activates the individual settings of [SOUND SETTINGS].
ON	The electronic sounds (operating sound, shutter sound, warning sound) and playback sounds are muted.

- ! [SOUND SETTINGS] (p. 38)

## Direct printing (PictBridge<sup>1</sup>)

By connecting the camera to a PictBridge-compatible printer, you can print images directly without using a computer.







To find out if your printer supports PictBridge, refer to the printer's instruction manual.

<sup>1</sup> PictBridge is a standard for connecting digital cameras and printers of different makers and printing out pictures directly.

- ! The printing modes, paper sizes, and other parameters that can be set with the camera vary depending on the printer that is used. For details, refer to the printer's instruction manual.
- ! For details on the available paper types, loading paper, and installing ink cassettes, refer to the printer's instruction manual.

## Printing images at the printer's standard settings [EASY PRINT]

### 1 Display the image to be printed on the monitor.

- ! "Viewing images" (p. 15)
- ! Printing can also be started when the camera is turned off. After performing Step 2, use   to select [EASY PRINT], press the  button. Use   to select an image, and press the  button.

### 2 Turn on the printer, and then connect the printer and camera.

Open the connector cover in the direction of the arrow.

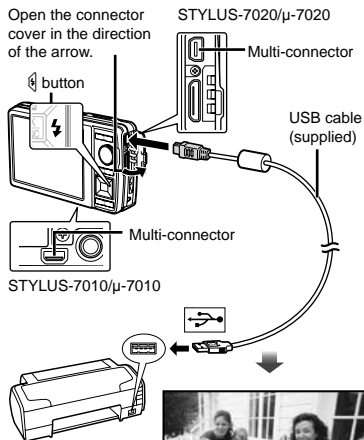

### 3 Press to start printing.

### 4 To print another image, use to select an image, and press the button.

#### To exit printing

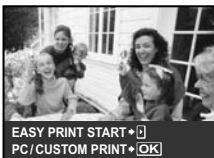

After a selected image is displayed on the screen, disconnect the USB cable from the camera and printer.

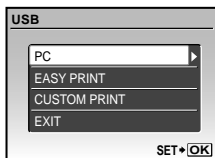

## Changing the printer's settings for printing [CUSTOM PRINT]

- 1 Follow Steps 1 and 2 for [EASY PRINT] (p. 43), and press the  button.





- 2 Use   to select [CUSTOM PRINT], and press the  button.

- 3 Use   to select the print mode, and press the  button.



Submenu 2	Application
PRINT	This prints the image selected in Step 6.
ALL PRINT	This prints all images stored in the internal memory or card.
MULTI PRINT	This prints an image multiple times on one page. Several layout options are available.
ALL INDEX	This prints an index of all images stored in the internal memory or card.
PRINT ORDER <sup>*1</sup>	This prints images based on the print reservation data on the card.

<sup>\*1</sup> [PRINT ORDER] is available only when print reservations have been made. "Print Reservations (DPOF)" (p. 46)

- 4 Use   to select [SIZE] (Submenu 3), and press .

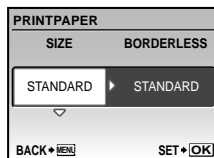
! If the [PRINTPAPER] screen is not displayed, the [SIZE], [BORDERLESS] and [PICS/SHEET] are set to the printer's standard.



- 5 Use   to select the [BORDERLESS] or [PICS/SHEET] settings, and press the .

Submenu 4	Application
OFF/ON <sup>*1</sup>	The image is printed with a border around it ([OFF]). The image is printed to fill the entire paper ([ON]).
(The number of images per sheet varies depending on the printer.)	The number of images per sheet ([PICS/SHEET]) is selectable only when [MULTI PRINT] is selected in Step 3.

<sup>\*1</sup> The available settings for [BORDERLESS] vary depending on the printer.

! If [STANDARD] is selected in Steps 4 and 5, the image is printed at the printer's standard settings.



6 Use to select an image.

7 Press to make a [SINGLEPRINT] reservation for the displayed image. Press to make detailed printer settings for the current image.

To make detailed printer settings

- ① Use to make settings and press the button.

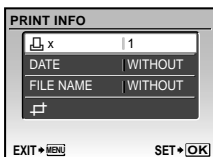

Submenu 5	Submenu 6	Application
	0 to 10	This selects the number of prints.
DATE	WITH/ WITHOUT	Selecting [WITH] prints the images with the date. Selecting [WITHOUT] prints the images without the date.
FILE NAME	WITH/ WITHOUT	Selecting [WITH] prints the file name on the image. Selecting [WITHOUT] does not print any file name on the image.
	(Proceeds to the setting screen.)	This selects a portion of the image for printing.

To crop an image ()

- ① Use the zoom button to select the size of the cropping frame, use to move the frame, and then press the button.



- ② Use to select [OK], and press the button.



8 If necessary, repeat Steps 6 and 7 to select the image to be printed, make the detailed settings, and set [SINGLEPRINT].

9 Press the button.

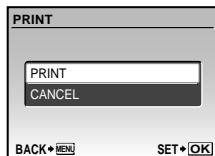



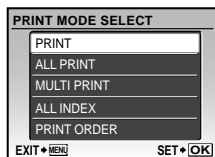

10 Use to select [PRINT], and press the button.

- Printing starts.
- When [OPTION SET] is selected in [ALL PRINT] mode, the [PRINT INFO] screen is displayed.
- After printing has finished, [PRINT MODE SELECT] will be displayed.



### To cancel printing

- 1 Press the  button while [TRANSFERRING] is displayed.
- 2 Select [CANCEL] using   and then press the  button.

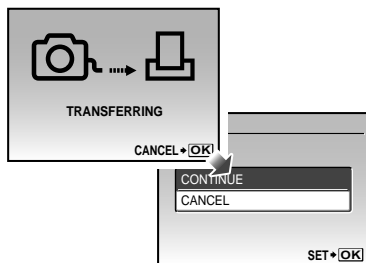

11 Press the MENU button.

12 When the message [REMOVE USB CABLE] is displayed, disconnect the USB cable from the camera and printer.

### Print Reservations (DPOF<sup>1</sup>)





In print reservations, the number of prints and date imprint option are saved in the image on the card. This enables easy printing at a printer or print shop supporting DPOF by using only the print reservations on the card without a computer or a camera.

<sup>1</sup> DPOF is a standard for storing automatic printout information from digital cameras.





- ! Print reservations can be set only for the images stored on the card. Insert a card with recorded images before making print reservations.
- ! DPOF reservations set by another DPOF device cannot be changed by this camera. Make changes using the original device. Making new DPOF reservations with this camera will erase the reservations made by the other device.
- ! DPOF print reservations can be made for up to 999 images per card.

### Single-frame print reservations

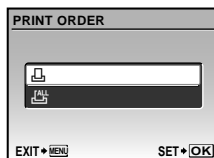





- 1 Set the mode dial to , and then press the MENU button to display the top menu.
- 2 Use   to select [] PRINT ORDER], and press the  button.

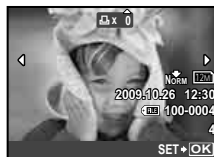

- 3 Use   to select []>, and press the  button.



- 4 Use  to select the image for print reservation. Use   to select the quantity. Press the  button.



- 5 Use to select the [DATE] (date print) screen option, and press the button.

Submenu 2	Application
NO	This prints the image only.
DATE	This prints the image with the shooting date.
TIME	This prints the image with the shooting time.



- 6 Use to select [SET], and press the button.

*Reserving one print each of all images on the card*

- 1 Follow Steps 1 and 2 in (p. 46).
- 2 Use to select , and press the button.
- 3 Follow Steps 5 and 6 in .

*Resetting all print reservation data*

- 1 Set the mode dial to , and then press the MENU button to display the top menu.
- 2 Use to select , and press the button.

- 3 Use to select either or , and press the button.

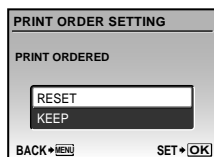

- 4 Use to select [RESET], and press the button.

*Resetting the print reservation data for selected images*

- 1 Follow Steps 1 and 2 of “Resetting all print reservation data” (p. 47).
- 2 Use to select , and press the button.
- 3 Use to select [KEEP] and press the button.
- 4 Use to select the image with the print reservation you want to cancel. Use to set the print quantity to “0”.
- 5 If necessary, repeat Step 4, and then press the button when finished.

- 6 Use to select the [DATE] (date print) screen option, and press the button.
  - The settings are applied to the remaining images with the print reservation data.
- 7 Use to select [SET], and press the button.

# Using OLYMPUS Master 2

## System requirements and installation of OLYMPUS Master 2

Install the OLYMPUS Master 2 software by referring to the included installation guide.

## Connecting the camera to a computer

### 1 Make sure the camera is turned off.

- The monitor is off.
- The lens is retracted.

### 2 Connect the camera to a computer.

- The camera automatically turns on.

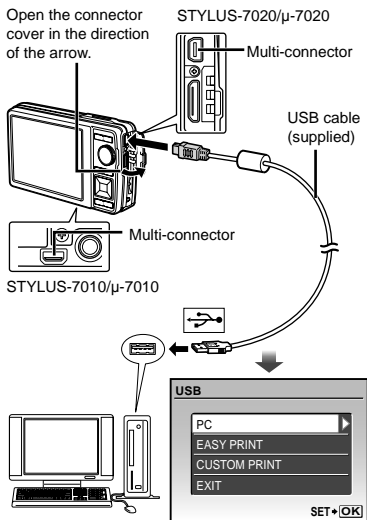

- ! Locate the position of the USB port by referring to your computer's instructions manual.

### 3 Use to select [PC], and press the button.

- The computer automatically detects the camera as a new device on the first connection.

#### Windows

After the computer detects the camera, a message indicating the success of the operation will appear. Confirm the message by clicking "OK." The camera is recognized as a removable disk.

#### Macintosh

When iPhoto started, exit iPhoto and start OLYMPUS Master 2.

- ! While the camera is connected to the computer, shooting functions are disabled.
- ! Connecting the camera to a computer via a USB hub may cause unstable operation.
- ! When [MTP] is set for the submenu that appears by pressing after selecting [PC] in Step 3, images cannot be transferred to a computer using OLYMPUS Master 2.

## Starting OLYMPUS Master 2

### 1 Double-click the OLYMPUS Master 2 icon.

#### Windows

appears on the desktop.

#### Macintosh

appears in the OLYMPUS Master 2 folder.

- Browse window appears after starting the software.
- ! When OLYMPUS Master 2 is started for the first time after installation, "Default Settings" and "Registration" screens will appear. Follow the instructions on the screen.



## Operating OLYMPUS Master 2

When OLYMPUS Master 2 is started, a Quick Start Guide will appear on the screen to help you become familiar with the software. If the Quick Start Guide is not displayed, click  in the toolbar to show the Guide.



For details on the operation, refer to the help guide of the software.

## Transferring and saving images without using OLYMPUS Master 2

This camera is compatible with the USB Mass Storage Class. You can transfer and save the image data on your computer while the camera and the computer are connected.

### System requirements

Windows : Windows 2000 Professional/  
XP Home Edition/  
XP Professional/Vista

Macintosh : Mac OS X v10.3 or later

- ❗ On a computer running Windows Vista, if [MTP] is set for the submenu that appears by pressing  after selecting [PC] in Step 3 of "Connecting the camera to a computer" (p. 48), Windows Photo Gallery will become available.
- ❗ Even if a computer has USB ports, proper operation is not guaranteed in the following cases:
  - Computers with USB ports installed using an expansion card, etc.
  - Computers without a factory-installed OS and home-built computers

If the camera does not work as intended, or if an error message is displayed on the screen, and you are unsure of what to do, refer to the information below to fix the problem(s).

## Troubleshooting

### Battery

**“The camera does not work even when battery is installed.”**

- Insert recharged battery in the correct direction.  
“Charging the battery” (p. 10), “Loading the battery and the xD-Picture Card™ (sold separately) into the camera” (p. 11)
- Battery performance may have been reduced temporarily due to low temperature. Take the battery out of the camera and warm them by putting them in your pocket for a while.

### Card/Internal memory

**“An error message is displayed.”**

“Error message” (p. 51)

### Shutter button

**“No picture is taken when the shutter button is pressed.”**

- Set the mode dial to a position other than .
- Cancel sleep mode

To save battery power, the camera automatically goes into sleep mode and the monitor turns off if there is no operation for 3 minutes when the camera is turned on. No picture is taken even if the shutter button is fully pressed in this mode. Operate the zoom button or other buttons to restore the camera from sleep mode before taking a picture. If the camera is left on for 12 minutes, it automatically turns off. Press the **ON/OFF** button to turn the camera on.

- Wait until  (flash charge) stops blinking before taking pictures.
- With prolonged camera use, the internal temperature may increase, resulting in automatic shutdown. If this occurs, remove the battery from the camera and wait until the camera has sufficiently cooled. The camera's external temperature may also increase during use, however this is normal and does not indicate malfunction.

### Monitor

**“It is difficult to see the image on the monitor.”**

- Condensation<sup>1</sup> may have formed inside the monitor. Turn off the power, and wait for the camera body to become acclimated to the surrounding temperature and dry out before taking pictures.  
<sup>1</sup> Dew drops can form in the camera when it is suddenly taken from a cold location into a warm, humid room.

**“Vertical lines appear on the screen.”**

- Vertical lines may appear on the screen when the camera is pointed at an extremely bright subject in situations such as clear weather conditions. The lines do not appear, however, in the final still image.

**“The light is caught in the picture”**

- Shooting with flash in dark situations results in an image with many flash reflections on dust in the air.

### Date and time function

**“Date and time settings return to the default setting.”**

- If the battery is removed and left out of the camera for about 3 days<sup>2</sup>, the date and time settings return to the default settings and must be reset.  
<sup>2</sup> The time until the date and time settings return to the default setting varies depending on how long the battery has been loaded.  
“Setting the date and time” (p. 13)









### Other





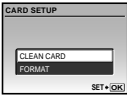
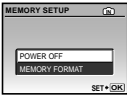

**“There is a noise coming from inside the camera during shooting.”**

- The movement of the lens may make a noise even if the camera is not being operated because the autofocus function is active when the camera is ready to shoot.

## Error message

- ⚠ When one of the messages below is displayed on the monitor, check the corrective action.

Error message	Corrective action
 <b>CARD ERROR</b>	<b>Card problem</b> Insert a new card.
 <b>WRITE PROTECT</b>	<b>Card problem</b> Use a computer to cancel the read-only setting.
 <b>MEMORY FULL</b>	<b>Internal memory problem</b> <ul style="list-style-type: none"> <li>Insert a card.</li> <li>Erase unwanted images.<sup>1</sup></li> </ul>
 <b>CARD FULL</b>	<b>Card problem</b> <ul style="list-style-type: none"> <li>Replace the card.</li> <li>Erase unwanted images.<sup>1</sup></li> </ul>
	<b>Card problem</b> <ul style="list-style-type: none"> <li>Use <math>\leftarrow</math>/<math>\rightarrow</math> to select [CLEAN CARD], and press the <math>\text{OK}</math> button. Take out the card, wipe the contact area (p. 56) with a soft, dry cloth, and then load the card again.</li> <li>Use <math>\leftarrow</math>/<math>\rightarrow</math> to select [FORMAT], and press the <math>\text{OK}</math> button. Next, use <math>\leftarrow</math>/<math>\rightarrow</math> to select [YES], and then press the <math>\text{OK}</math> button.<sup>2</sup></li> </ul>
	<b>Internal memory problem</b> Use $\leftarrow$ / $\rightarrow$ to select [MEMORY FORMAT], and press the $\text{OK}$ button. Next, use $\leftarrow$ / $\rightarrow$ to select [YES], and press the $\text{OK}$ button. <sup>2</sup>
 <b>NO PICTURE</b>	<b>Internal memory/Card problem</b> Take pictures before viewing them.
 <b>PICTURE ERROR</b>	<b>Problem with selected image</b> Use photo retouching software, etc., to view the image on a computer. If the image still cannot be viewed, the image file is corrupted.
 <b>THE IMAGE CANNOT BE EDITED</b>	<b>Problem with selected image</b> Use photo retouching software, etc., to edit the image on a computer.
 <b>CARD-COVER OPEN</b>	<b>Operation problem</b> Close the battery/card compartment cover.

Error message	Corrective action
 <b>BATTERY EMPTY</b>	<b>Battery problem</b> Charge the battery.
 <b>NO CONNECTION</b>	<b>Connection problem</b> Connect the camera and computer or printer correctly.
 <b>NO PAPER</b>	<b>Printer problem</b> Load paper into the printer.
 <b>NO INK</b>	<b>Printer problem</b> Refill the ink in the printer.
 <b>JAMMED</b>	<b>Printer problem</b> Remove the jammed paper.
<b>SETTINGS CHANGED<sup>3</sup></b>	<b>Printer problem</b> Return to the status where the printer can be used.
 <b>PRINT ERROR</b>	<b>Printer problem</b> Turn off the camera and printer, check the printer for any problems, and then turn the power on again.
 <b>CANNOT PRINT<sup>4</sup></b>	<b>Problem with selected image</b> Use a computer to print.

<sup>1</sup> Before erasing important images, download them to a computer.

<sup>2</sup> All data will be erased.

<sup>3</sup> This is displayed, for instance, when the printer's paper tray has been removed. Do not operate the printer while making the print settings on the camera.

<sup>4</sup> This camera may be unable to print images taken by other cameras.

## Shooting tips

When you are unsure of how to take a picture that you envision, refer to the information below.

### Focusing



#### “Focusing on the subject”

- **Taking a picture of a subject not in the center of the screen**

After focusing on an object at the same distance as the subject, compose the shot, and take the picture.

“Pressing the shutter button halfway” (p. 14)

- **Set [AF MODE] (p. 27) to [IESP].**
- **Taking a picture in [AF TRACKING] mode (p. 27).**

The camera tracks the subject movement automatically to focus on it continuously.

- **Taking a picture of subjects where autofocus is difficult**

In the following cases, after focusing on an object (by pressing the shutter button halfway down) with high contrast at the same distance as the subject, compose the shot and take the picture.

Subjects with low contrast



When extremely bright objects appear in the center of the screen



Object with no vertical lines<sup>1</sup>

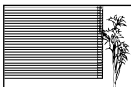

<sup>1</sup> It is also effective to compose the shot by holding the camera vertically to focus and then returning to the horizontal position to take the picture.

When objects are at different distances



Fast-moving object

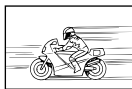

When the subject is not in the center of the frame



### Camera shake



#### “Taking pictures without camera shake”

- **Taking pictures using [IMAGE STABILIZER] (p. 28)**

When a picture is taken of a shadowy subject, the CCD<sup>1</sup> shifts to correct for camera shake even if the ISO speed is not increased. This function is also effective when taking pictures at a high zoom magnification.

<sup>1</sup> A device that takes light received through the lens and converts it into electric signals.

- **Shooting movies using [DIS MOVIE MODE] (p. 28)**
- **Taking pictures using [SPORT] in SCN mode (p. 29)**

The [SPORT] mode uses a fast shutter speed and can reduce the blur incurred by a moving subject.

- **Taking pictures at a high ISO sensitivity**

If a high ISO speed is selected, pictures can be taken at a high shutter speed even at locations where a flash cannot be used.

[ISO] (p. 26)

## Exposure (brightness)



### “Taking pictures with the right brightness”

- **Taking pictures of a subject against a backlight**

A face against the backlight is brightened.

[SHADOW ADJ] (p. 22, 28)

- **Taking pictures using [FACE DETECT] for [AF MODE] (p. 27)**

Appropriate exposure is obtained for a face against the backlight, and the face is brightened.

- **Taking pictures using [ ] for [ESP/ ] (p. 27)**

Brightness is matched with a subject in the center of the screen and the image is not affected by background light.

- **Taking pictures using [ ] (FILL IN) (p. 19) flash**

A subject against the backlight is brightened.

- **Taking pictures of a white beach or snow scene**

Set the mode to [ ] BEACH & SNOW] (p. 29)

- **Taking pictures using exposure compensation (p. 20)**

Adjust the brightness while viewing the screen for taking the picture. Normally, taking pictures of white subjects (such as snow) results in images that are darker than the actual subject. Use the [ ] button to adjust in the positive (+) direction to express whites as they appear.

When taking pictures of black subjects, on the other hand, it is effective to adjust in the negative (-) direction.

## Color hue

# WB

### “Taking pictures that capture natural colors”

- **Taking pictures by selecting [WB] (p. 26)**

Best results in most environments can normally be obtained with the [AUTO] setting, but for some subjects, you should try experimenting with different settings. (This is especially true for sunshade under a clear sky, mixed natural and artificial light settings, and so on.)

## Image quality



### “Taking sharper pictures”

- **Taking pictures with the optical zoom**

Avoid using [DIGITAL ZOOM] (p. 27) to take pictures.

- **Taking pictures at a low ISO sensitivity**

If the picture is taken with a high ISO sensitivity, noise (small colored spots and color unevenness that were not in the original image) can occur, and the image can appear grainy.

[ISO] (p. 26)

## Panorama



### “Taking pictures so that the frames are stitched smoothly”

- **A tip for panoramic shooting**

Taking pictures by pivoting with the camera at the center prevents shifting of the image. When taking pictures of close objects in particular, pivoting with the lens end at the center produces favorable results.

[ ] PANORAMA] (p. 30)

## Batteries



### “Making batteries last longer”

- **Avoid any of the following operations when not actually taking pictures because they deplete the battery power**

- Repeatedly pressing the shutter button halfway
- Repeatedly using the zoom

- Set [POWER SAVE] (p. 42) to [ON]

## Playback



### “Playing images in the internal memory or card”

- Remove the card when playing images in the internal memory
  - “Loading the battery and the xD-Picture Card™ (sold separately) into the camera” (p. 11)
  - “Using a microSD card/microSDHC card (sold separately)” (p. 12)

### “Viewing images with high picture quality on a high-definition TV” (STYLUS-7020/μ-7020 only)

- Connect the camera to the TV using an HDMI cable (commercially available)
  - “To play back camera images on a TV” (p. 41)
  - “Selecting the digital video signal format for connecting to a TV via an HDMI cable [HDMI]” (p. 42)

## Editing



### “Erasing the sound recorded to a still image”

- Record over the sound with silence when playing back the image
  - [🔊] (Add sound to still images) (p. 36)

## Camera care

### Exterior

- Wipe gently with a soft cloth. If the camera is very dirty, soak the cloth in mild soapy water and wring well. Wipe the camera with the damp cloth and then dry it with a dry cloth. If you have used the camera at the beach, use a cloth soaked in clean water and wrung well.

### Monitor

- Wipe gently with a soft cloth.

### Lens

- Blow dust off the lens with a commercial blower, then wipe gently with a lens cleaner.

### Battery/Charger

- Wipe gently with a soft, dry cloth.
  - ! Do not use strong solvents, such as benzene or alcohol, or chemically treated cloth.
  - ! Mold may form on the lens surface if the lens is left dirty.

## Storage

- When storing the camera for extended periods, remove the battery, AC adapter and card, and keep in a cool, dry place that is well ventilated.
- Periodically insert the battery and test the camera functions.
  - ! Avoid leaving the camera in places where chemical products are handled since this may result in corrosion.

## Battery and charger

- This camera uses one Olympus lithium-ion battery (LI-42B/LI-40B). No other type of batteries can be used.
  - ! CAUTION:  
There is a risk of explosion if the battery is replaced with the incorrect battery type. Dispose of the used battery following the instructions. "Battery Handling Precautions" (p. 61)
- Power consumption by the camera varies depending on which functions are used.
- During the conditions described below, power is consumed continuously and the battery becomes exhausted quickly.
  - The zoom is used repeatedly.
  - The shutter button is pressed halfway repeatedly in shooting mode, activating the auto focus.
  - A picture is displayed on the monitor for an extended period of time.
  - The camera is connected to a computer or printer.
- Using an exhausted battery may cause the camera to turn off without displaying the battery level warning.
- The rechargeable battery is not fully charged at the time of purchase. Charge the battery fully with LI-41C/LI-40C charger before use.
- The provided rechargeable battery usually takes approximately 2 hours to charge (varies with usage).
- The supplied LI-41C battery charger is used only for LI-42B/LI-40B battery. Do not charge other type of battery with the supplied battery charger. It might cause explosion, leaking, overheating or fire.
- For plug-in type battery charger:  
This power unit is intended to be correctly orientated in a vertical or floor mount position.

## Using an AC adapter (STYLUS-7020/ $\mu$ -7020 only)

An AC adapter is useful for time-consuming tasks such as image downloads to a computer or when running a slideshow for a long period of time.

To use an AC adapter for this camera, the multiadapter cable (CB-MA1 or CB-MA3/separately sold) is required. Do not use any other AC adapter with this camera.

## Using your charger and AC adapter abroad

- The charger and AC adapter can be used in most home electrical sources within the range of 100 V to 240 V AC (50/60Hz) around the world. However, AC wall outlets are shaped differently in different countries or regions. Therefore, the charger and AC adapter may require a plug adapter to match your wall outlet. For details, ask at your local electrical shop or travel agent.
- Do not use travel voltage converters as they could damage your charger and AC adapter.

## Using an xD-Picture Card

A card (and also internal memory) corresponds to the film in a film camera. The recorded images (data) can be erased, and they can be retouched with the use of a computer. Cards can be removed from the camera and exchanged, but it is not possible to remove or exchange the internal memory. Use of larger capacity cards enables you to take more pictures.

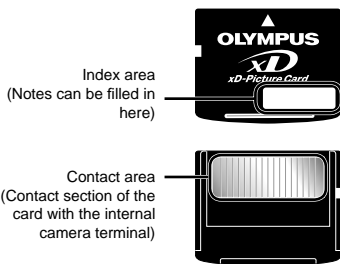

! Do not touch the contact area directly.

### Cards compatible with this camera

xD-Picture Card (16MB to 2GB)  
(TypeH/M/M+, Standard)

### Using a new card

Before using a non-Olympus card or a card that was used for another purpose in a computer or other device, use [MEMORY FORMAT]/[FORMAT] (p. 37) to format the card.

### Checking the image saving location

The current memory indicator shows whether the internal memory or card is being used during shooting and playback.

### Current memory indicator

Internal memory is being used

None: Card is being used

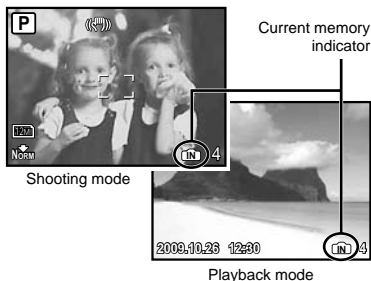

! Even if [MEMORY FORMAT]/[FORMAT], [ERASE], [SEL. IMAGE], or [ALL ERASE] is performed, the data in the card is not completely erased. When disposing of the card, damage the card to prevent the disclosure of personal data.

### Readout/recording process of the card

Never open the battery/card compartment cover or unplug the USB cable while the camera is reading or writing data, which is indicated by blinking of the card access lamp. This can not only damage the image data but also render the internal memory or card unusable.

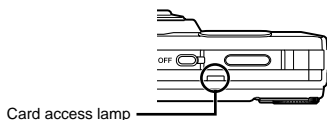



## Number of storable pictures (still pictures)/continuous recording length (movies) in the internal memory and xD-Picture Card

### Still pictures

IMAGE SIZE	COMPRES- SION	Number of storable still pictures							
		Internal memory				Using a 1GB xD-Picture Card			
		STYLUS-7020/ μ-7020		STYLUS-7010/ μ-7010		STYLUS-7020/ μ-7020		STYLUS-7010/ μ-7010	
		With sound	Without sound	With sound	Without sound	With sound	Without sound	With sound	Without sound
[12M] 3968×2976	FINE	2	2	6	6	173	174	173	174
	NORM	5	5	12	12	340	343	340	343
[5M] 2560×1920	FINE	6	6	14	14	404	410	404	410
	NORM	11	12	27	28	770	789	770	789
[3M] 2048×1536	FINE	9	9	22	22	615	627	615	627
	NORM	17	18	41	42	1,142	1,184	1,142	1,184
[2M] 1600×1200	FINE	14	15	34	35	954	984	954	984
	NORM	26	28	62	65	1,728	1,827	1,728	1,827
[1M] 1280×960	FINE	21	22	50	52	1,390	1,453	1,390	1,453
	NORM	36	39	85	92	2,369	2,558	2,369	2,558
[VGA] 640×480	FINE	75	89	177	209	4,920	5,814	4,920	5,814
	NORM	122	163	287	383	7,995	10,660	7,995	10,660
[VGA] <sup>1</sup> 3968×2232	FINE	3	3	–	–	230	231	–	–
	NORM	6	6	–	–	447	453	–	–
[SMB] <sup>2</sup> 1920×1080	FINE	13	14	32	33	900	927	900	927
	NORM	24	25	57	60	1,599	1,683	1,599	1,683

<sup>1</sup> This menu is available only for STYLUS-7020/μ-7020.

<sup>2</sup> [16:9] is displayed in STYLUS-7010/μ-7010.

### Movies

IMAGE SIZE	FRAME RATE	Continuous recording length		
		Internal memory		Using a 1 GB xD-Picture Card
		STYLUS-7020/ μ-7020	STYLUS-7010/ μ-7010	STYLUS-7020/μ-7020 STYLUS-7010/μ-7010
		With sound		With sound
[VGA] 640×480	[30] [FPS]	8 sec.	20 sec.	9 min. 25 sec.*
	[15] [FPS]	17 sec.	40 sec.	18 min. 44 sec.
[QVGA] 320×240	[30] [FPS]	23 sec.	54 sec.	25 min. 26 sec.
	[15] [FPS]	46 sec.	1 min. 48 sec.	50 min. 7 sec.

\* When using a TypeM or Standard xD-Picture Card, the maximum length is 40 seconds.

! The maximum file size for recording a single movie is 2GB regardless of card capacity.

### Increasing the number of pictures that can be taken

Connect the camera to a computer or other device to save any important images, and then erase the images in the internal memory or card.

[ERASE] (p. 16), [SEL. IMAGE] (p. 36), [ALL ERASE] (p. 36), [MEMORY FORMAT]/[FORMAT] (p. 37)

- ❗ Do not use the bundled microSD Attachment with Olympus digital cameras that do not support it. Do not use it with other brands of digital cameras, computers, printers and other devices that support xD-Picture Card media. Doing so may damage the pictures taken and/or cause the device to malfunction.
- ❗ If the microSD card cannot be removed, do not use force. Contact authorized distributors/service centers.

### Cards compatible with this camera

microSD card/microSDHC card



- ❗ For a list of tested microSD cards, please visit our website (<http://www.olympus.com/>).

### Sending images

You can send images to a computer or a PictBridge-compatible printer by using the USB cable provided with the camera. To send data to other devices, remove the microSD Attachment from the camera and use a commercially available microSD card adapter.

### Handling precautions

Do not touch the contact area of the microSD Attachment or microSD card. Doing so may cause failure in reading the images. When fingerprints or stains are found on the contact area, wipe the area with a soft dry cloth.

	<b>CAUTION</b> <b>RISK OF ELECTRIC SHOCK</b> <b>DO NOT OPEN</b>	
CAUTION: TO REDUCE THE RISK OF ELECTRICAL SHOCK, DO NOT REMOVE COVER (OR BACK). NO USER-SERVICEABLE PARTS INSIDE. REFER SERVICING TO QUALIFIED OLYMPUS SERVICE PERSONNEL.		



An exclamation mark enclosed in a triangle alerts you to important operating and maintenance instructions in the documentation provided with the product.



#### DANGER

If the product is used without observing the information given under this symbol, serious injury or death may result.



#### WARNING

If the product is used without observing the information given under this symbol, injury or death may result.



#### CAUTION

If the product is used without observing the information given under this symbol, minor personal injury, damage to the equipment or loss of valuable data may result.

<b>WARNING!</b> <b>TO AVOID THE RISK OF FIRE OR ELECTRICAL SHOCK, NEVER DISASSEMBLE, EXPOSE THIS PRODUCT TO WATER OR OPERATE IN A HIGH HUMIDITY ENVIRONMENT.</b>
---

## General Precautions

**Read All Instructions** — Before you use the product, read all operating instructions. Save all manuals and documentation for future reference.

**Cleaning** — Always unplug this product from the wall outlet before cleaning. Use only a damp cloth for cleaning. Never use any type of liquid or aerosol cleaner or any type of organic solvent to clean this product.

**Attachments** — For your safety and to avoid damaging the product, use only accessories recommended by Olympus.

**Water and Moisture** — For precautions on products with weatherproof designs, read the weatherproofing sections.

**Location** — To avoid damage to the product, mount the product securely on a stable tripod, stand, or bracket.

**Power Source** — Connect this product only to the power source described on the product label.

**Lightning** — If a lightning storm occurs while using an AC adapter, remove it from the wall outlet immediately.

**Foreign Objects** — To avoid personal injury, never insert a metal object into the product.

**Heat** — Never use or store this product near any heat source, such as a radiator, heat register, stove or any type of equipment or appliance that generates heat, including stereo amplifiers.

## Handling the Camera

### WARNING

- **Do not use the camera near flammable or explosive gases.**
- **Do not use the flash and LED on people (infants, small children, etc.) at close range.**
  - You must be at least 1 m (3 ft.) away from the faces of your subjects. Firing the flash too close to the subject's eyes could cause a momentary loss of vision.
- **Keep young children and infants away from the camera.**
  - Always use and store the camera out of the reach of young children and infants to prevent the following dangerous situations which could cause serious injury:
    - Becoming entangled in the camera strap, causing strangulation.
    - Accidentally swallowing the battery, cards or other small parts.
    - Accidentally firing the flash into their own eyes or those of another child.
    - Accidentally being injured by the moving parts of the camera.
- **Do not look at the sun or strong lights with the camera.**
- **Do not use or store the camera in dusty or humid places.**
- **Do not cover the flash with a hand while firing.**
- **Do not insert anything into the microSD Attachment other than the microSD card.**

This attachment is exclusive for use of microSD cards only. Other types of cards cannot be installed.
- **Do not insert anything other than an xD-Picture Card or the microSD Attachment into the camera.**

If you insert a card by mistake, such as a microSD card, do not use force. Contact authorized distributors/service centers.

## CAUTION

- **Stop using the camera immediately if you notice any unusual odors, noise or smoke around it.**
  - Do not remove the battery with bare hands. Doing so may cause a fire or burn your hands.
- **Never hold or operate the camera with wet hands.**
- **Do not leave the camera in places where it may be subject to extremely high temperatures.**
  - Doing so may cause parts to deteriorate and, in some circumstances, cause the camera to catch fire. Do not use the charger or AC adapter if it is covered (such as a blanket). This could cause overheating, resulting in fire.
- **Handle the camera with care to avoid getting a low-temperature burn.**
  - The camera contains metal parts. Overheating can result in a low-temperature burn. Pay attention to the following:
    - When used for a long period, the camera will get hot. If you hold on to the camera in this state, a low-temperature burn may be caused.
    - In places subject to extremely cold temperatures, the temperature of the camera's body may be lower than the environmental temperature. If possible, wear gloves when handling the camera in cold temperatures.
- **Be careful with the strap.**
  - Be careful with the strap when you carry the camera. It could easily catch on stray objects and cause serious damage.

## Battery Handling Precautions

**Follow these important guidelines to prevent batteries from leaking, overheating, burning, exploding or causing electrical shocks or burns.**

### DANGER

- The camera uses a lithium-ion battery specified by Olympus. Charge the battery with the specified charger. Do not use any other chargers.
- Never heat or incinerate batteries.
- Take precautions when carrying or storing batteries to prevent them from coming into contact with any metal objects such as jewelry, pins, fasteners, etc.
- Never store batteries where they will be exposed to direct sunlight or subjected to high temperatures in a hot vehicle, near a heat source, etc.
- To prevent causing battery leaks or damaging their terminals, carefully follow all instructions regarding the use of batteries. Never attempt to disassemble a battery or modify it in any way, solder, etc.
- If battery fluid gets into your eyes, flush your eyes immediately with clear, cold running water and seek medical attention immediately.
- Always store batteries out of the reach of small children. If a child accidentally swallows a battery, seek medical attention immediately.

### WARNING

- Keep batteries dry at all times.
- To prevent batteries from leaking, overheating or causing a fire or explosion, use only batteries recommended for use with this product.
- Insert the battery carefully as described in the operating instructions.
- If rechargeable batteries have not been recharged within the specified time, stop charging them and do not use them.
- Do not use a battery if it is cracked or broken.
- If a battery leaks, becomes discolored or deformed, or becomes abnormal in any other way during operation, stop using the camera.
- If a battery leaks fluid onto your clothing or skin, remove the clothing and flush the affected area with clean, running cold water immediately. If the fluid burns your skin, seek medical attention immediately.
- Never subject batteries to strong shocks or continuous vibration.

### CAUTION

- Before loading, always inspect the battery carefully for leaks, discoloration, warping or any other abnormality.
- The battery may become hot during prolonged use. To avoid minor burns, do not remove it immediately after using the camera.
- Always unload the battery from the camera before storing the camera for a long period.

## Caution for Usage Environment

- To protect the high-precision technology contained in this product, never leave the camera in the places listed below, no matter if in use or storage:
  - Places where temperatures and/or humidity are high or go through extreme changes, such as in direct sunlight, at beaches, in locked cars or near other heat sources (stove, radiator, etc.) or humidifiers.
  - In sandy or dusty environments.
  - Near flammable items or explosives.
  - In wet places, such as bathrooms or in the rain. When using products with weatherproof designs, read their manuals as well.
  - In places prone to strong vibrations.
- Never drop the camera or subject it to severe shocks or vibrations.
- When mounted on a tripod, adjust the position of the camera with the tripod head. Do not twist the camera.
- Do not touch electric contacts on cameras.
- Do not leave the camera pointed directly at the sun. This may cause lens or shutter curtain damage, color failure, ghosting on the CCD or possibly fires.
- Do not push or pull severely on the lens.
- Before storing the camera for a long period, remove the batteries. Select a cool, dry location for storage to prevent condensation or mold from forming inside the camera. After storage, test the camera by turning it on and pressing the shutter button to make sure that it is operating normally.
- Always observe the operating environment restrictions described in the camera's manual.

## Battery Handling Precautions

- This camera uses a lithium-ion battery specified by Olympus. Do not use any other type of battery.
- If the battery's terminals get wet or greasy, camera contact failure may result. Wipe the battery well with a dry cloth before use.
- Always charge a battery when using it for the first time, or if it has not been used for a long period.
- When operating the camera with battery power at low temperatures, try to keep the camera and spare battery as warm as possible. A battery that has run down at low temperatures may be restored after it is warmed at room temperature.
- The number of pictures you can take may vary depending on the shooting conditions or battery.
- Before going on a long trip, and especially before traveling abroad, purchase extra batteries. A recommended battery may be difficult to obtain while traveling.
- Please recycle batteries to help save our planet's resources. When you throw away dead batteries, be sure to cover their terminals and always observe local laws and regulations.

## LCD Monitor

- Do not push the monitor forcibly; otherwise the image may become vague, resulting in a playback mode failure or damage to the monitor.
- A strip of light may appear on the top/bottom of the monitor, but this is not a malfunction.
- When a subject is viewed diagonally in the camera, the edges may appear zigzagged on the monitor. This is not a malfunction; it will be less noticeable in playback mode.
- In places subject to low temperatures, the LCD monitor may take a long time to turn on or its color may change temporarily. When using the camera in extremely cold places, it is a good idea to occasionally place it in a warm place. An LCD monitor exhibiting poor performance due to low temperatures will recover in normal temperatures.
- The LCD used for the monitor is made with high-precision technology. However, black spots or bright spots of light may appear constantly on the LCD monitor. Due to its characteristics or the angle at which you are viewing the monitor, the spot may not be uniform in color and brightness. This is not a malfunction.

## Legal and Other Notices

- Olympus makes no representations or warranties regarding any damages or benefit expected by using this unit lawfully, or any request from a third person, which are caused by the inappropriate use of this product.
- Olympus makes no representations or warranties regarding any damages or any benefit expected by using this unit lawfully which are caused by erasing picture data.

## Disclaimer of Warranty

- Olympus makes no representations or warranties, either expressed or implied, by or concerning any content of these written materials or software, and in no event shall be liable for any implied warranty of merchantability or fitness for any particular purpose or for any consequential, incidental or indirect damages (including but not limited to damages for loss of business profits, business interruption and loss of business information) arising from the use or inability to use these written materials or software or equipment. Some countries do not allow the exclusion or limitation of liability for consequential or incidental damages or of the implied warranty, so the above limitations may not apply to you.
- Olympus reserves all rights to this manual.

## Warning

Unauthorized photographing or use of copyrighted material may violate applicable copyright laws. Olympus assumes no responsibility for unauthorized photographing, use or other acts that infringe upon the rights of copyright owners.

## Copyright Notice

All rights reserved. No part of these written materials or this software may be reproduced or used in any form or by any means, electronic or mechanical, including photocopying and recording or the use of any type of information storage and retrieval system, without the prior written permission of Olympus. No liability is assumed with respect to the use of the information contained in these written materials or software, or for damages resulting from the use of the information contained therein. Olympus reserves the right to alter the features and contents of this publication or software without obligation or advance notice.

## FCC Notice

- Radio and Television Interference
- Changes or modifications not expressly approved by the manufacturer may void the user's authority to operate this equipment. This equipment has been tested and found to comply with the limits for a Class B digital device, pursuant to Part 15 of the FCC Rules. These limits are designed to provide reasonable protection against harmful interference in a residential installation.
- This equipment generates, uses, and can radiate radio frequency energy and, if not installed and used in accordance with the instructions, may cause harmful interference to radio communications.
- However, there is no guarantee that interference will not occur in a particular installation. If this equipment does cause harmful interference to radio or television reception, which can be determined by turning the equipment off and on, the user is encouraged to try to correct the interference by one or more of the following measures:
  - Adjust or relocate the receiving antenna.
  - Increase the distance between the camera and receiver.
  - Connect the equipment to an outlet on a circuit different from that to which the receiver is connected.
  - Consult your dealer or an experienced radio/TV technician for help. Only the OLYMPUS-supplied USB cable should be used to connect the camera to USB enabled personal computers (PC).

Any unauthorized changes or modifications to this equipment would void the user's authority to operate it.

## Use Only Dedicated Rechargeable Battery, Battery Charger and AC adapter

We strongly recommend that you use only the genuine Olympus dedicated rechargeable battery, battery charger and AC adapter with this camera. Using a non-genuine rechargeable battery, battery charger and/or AC adapter may result in fire or personal injury due to leakage, heating, ignition or damage to the battery. Olympus does not assume any liability for accidents or damage that may result from the use of a battery, battery charger and/or AC adapter that are not genuine Olympus accessories.

## Representative plug of power supply cord of countries/regions around the world



A Type  
(American Type)



B Type  
(British Type)



BF Type  
(British Type)



B3 Type  
(British Type)



C Type  
(CEE Type)



SE Type  
(CEE Type)



O Type  
(Oceania Type)

The representative supply voltage and plug type are described in this chart.  
Depending on the area, different types of plugs and supply voltages are used.

Attention: Power cord meeting demands from each country shall be used.

- For only the United States

Use a UL Listed, 1.8 - 3 m (6 - 10 ft), Type SPT-2 or NISPT-2, AWG no. 18 power supply cord, rated for 125 V 7 A, with a non-polarized NEMA 1-15P plug rated for 125 V 15 A".

### Europe

Countries/Regions	Voltage	Frequency (Hz)	Plug type
Austria	230	50	C
Belgium	230	50	C
Czech	220	50	C
Denmark	230	50	C
Finland	230	50	C
France	230	50	C
Germany	230	50	C
Greece	220	50	C
Hungary	220	50	C
Iceland	230	50	C
Ireland	230	50	C/BF
Italy	220	50	C
Luxemburg	230	50	C
Netherlands	230	50	C
Norway	230	50	C
Poland	220	50	C
Portugal	230	50	C
Romania	220	50	C
Russia	220	50	C
Slovak	220	50	C
Spain	127/230	50	C
Sweden	230	50	C
Switzerland	230	50	C
UK	240	50	BF

### Asia

Countries/Regions	Voltage	Frequency (Hz)	Plug type
China	220	50	A
Hong Kong	200/220	50	BF
India	230/240	50	C
Indonesia	127/230	50	C
Japan	100	50/60	A
Korea (rep)	220	60	C
Malaysia	240	50	BF
Philippines	220/230	60	A/C
Singapore	230	50	BF
Taiwan	110	60	A
Thailand	220	50	C/BF
Vietnam	220	50	A/C

### Oceania

Countries/Regions	Voltage	Frequency (Hz)	Plug type
Australia	240	50	O
New Zealand	230/240	50	O

### North America

Countries/Regions	Voltage	Frequency (Hz)	Plug type
Canada	120	60	A
USA	120	60	A

### Central America

Countries/Regions	Voltage	Frequency (Hz)	Plug type
Bahamas	120/240	60	A
Costa Rica	110	60	A
Cuba	110/220	60	A/C
Dominican (rep)	110	60	A
El Salvador	110	60	A
Guatemala	120	60	A
Honduras	110	60	A
Jamaica	110	50	A
Mexico	120/127	60	A
Nicaragua	120/240	60	A
Panama	110/220	60	A

### South America

Countries/Regions	Voltage	Frequency (Hz)	Plug type
Argentina	220	50	C/BF/O
Brazil	127/220	60	A/C
Chile	220	50	C
Colombia	120	60	A
Peru	220	60	A/C
Venezuela	120	60	A

### Middle East

Countries/Regions	Voltage	Frequency (Hz)	Plug type
Iran	220	50	C/BF
Iraq	220	50	C/BF
Israel	230	50	C
Saudi Arabia	127/220	50	A/C/BF
Turkey	220	50	C
UAE	240	50	C/BF

### Africa

Countries/Regions	Voltage	Frequency (Hz)	Plug type
Algeria	127/220	50	C
Congo (dem)	220	50	C
Egypt	220	50	C
Ethiopia	220	50	C
Kenya	240	50	C/BF
Nigeria	230	50	C/BF
South Africa	220/230	50	C/BF
Tanzania	230	50	C/BF
Tunisia	220	50	C

## For customers in North and South America

### For customers in USA

Declaration of Conformity

Model Number : STYLUS-7020/ $\mu$ -7020,  
STYLUS-7010/ $\mu$ -7010

Trade Name : OLYMPUS

Responsible Party :  
OLYMPUS IMAGING AMERICA INC.

Address : 3500 Corporate Parkway,  
P.O. Box 610, Center  
Valley, PA 18034-0610,  
U.S.A.

Telephone Number : 484-896-5000

Tested To Comply With FCC Standards  
FOR HOME OR OFFICE USE

This device complies with Part 15 of the FCC rules.

Operation is subject to the following two conditions:

- (1) This device may not cause harmful interference.
- (2) This device must accept any interference received, including interference that may cause undesired operation.

### For customers in Canada

This Class B digital apparatus meets all requirements of the Canadian Interference-Causing Equipment Regulations.

## OLYMPUS WORLDWIDE LIMITED WARRANTY - IMAGING PRODUCTS

Olympus warrants that the enclosed Olympus® imaging product(s) and related Olympus® accessories (individually a "Product" and collectively the "Products") will be free from defects in materials and workmanship under normal use and service for a period of one (1) year from the date of purchase.

If any Product proves to be defective within the one-year warranty period, the customer must return the defective Product to any of Olympus Service Centers, following the procedure set forth below (See "WHAT TO DO WHEN SERVICE IS NEEDED").

Olympus, at its sole discretion, will repair, replace, or adjust the defective Product, provided that Olympus investigation and factory inspection disclose that (a) such defect developed under normal and proper use and (b) the Product is covered under this limited warranty.

Repair, replacement, or adjustment of defective Products shall be Olympus's sole obligation and the customer's sole remedy hereunder.

The customer is liable and shall pay for shipment of the Products to the Olympus Service Center.

Olympus shall not be obligated to perform preventive maintenance, installation, deinstallation, or maintenance.

Olympus reserves the right to (i) use reconditioned, refurbished, and/or serviceable used parts (that meet Olympus's quality assurance standards) for warranty or any other repairs and (ii) make any internal or external design and/or feature changes on or to its products without any liability to incorporate such changes on or to the Products.



## WHAT IS NOT COVERED BY THIS LIMITED WARRANTY

Excluded from this limited warranty and not warranted by Olympus in any fashion, either express, implied, or by statute, are:

- (a) products and accessories not manufactured by Olympus and/or not bearing the "OLYMPUS" brand label (the warranty coverage for products and accessories of other manufacturers, which may be distributed by Olympus, is the responsibility of the manufacturers of such products and accessories in accordance with the terms and duration of such manufacturers' warranties);
- (b) any Product which has been disassembled, repaired, tampered with, altered, changed, or modified by persons other than Olympus's own authorized service personnel unless repair by others is made with the written consent of Olympus;
- (c) defects or damage to the Products resulting from wear, tear, misuse, abuse, negligence, sand, liquids, impact, improper storage, nonperformance of scheduled operator and maintenance items, battery leakage, use of non-"OLYMPUS" brand accessories, consumables, or supplies, or use of the Products in combination with non-compatible devices;
- (d) software programs;
- (e) supplies and consumables (including but not limited to lamps, ink, paper, film, prints, negatives, cables and batteries); and/or
- (f) Products which do not contain a validly placed and recorded Olympus serial number, unless they are a model on which Olympus does not place and record serial numbers.

EXCEPT FOR THE LIMITED WARRANTY SET FORTH ABOVE, OLYMPUS MAKES NO AND DISCLAIMS ALL OTHER REPRESENTATIONS, GUARANTIES, CONDITIONS, AND WARRANTIES CONCERNING THE PRODUCTS, WHETHER DIRECT OR INDIRECT, EXPRESS OR IMPLIED, OR ARISING UNDER ANY STATUTE, ORDINANCE, COMMERCIAL USAGE OR OTHERWISE, INCLUDING BUT NOT LIMITED TO ANY WARRANTY OR REPRESENTATION AS TO THE SUITABILITY, DURABILITY, DESIGN, OPERATION, OR CONDITON OF THE PRODUCTS (OR ANY PART THEREOF) OR THE MERCHANTABILITY OF THE PRODUCTS OR THEIR FITNESS FOR A PARTICULAR PURPOSE, OR RELATING TO THE INFRINGEMENT OF ANY PATENT, COPYRIGHT, OR OTHER PROPRIETARY RIGHT USED OR INCLUDED THEREIN.

IF ANY IMPLIED WARRANTIES APPLY AS A MATTER OF LAW, THEY ARE LIMITED IN DURATION TO THE LENGTH OF THIS LIMITED WARRANTY.

SOME STATES MAY NOT RECOGNIZE A DISCLAIMER OR LIMITATION OF WARRANTIES AND/OR LIMITATION OF LIABILITY SO THE ABOVE DISCLAIMERS AND EXCLUSIONS MAY NOT APPLY.

THE CUSTOMER MAY ALSO HAVE DIFFERENT AND/OR ADDITIONAL RIGHTS AND REMEDIES THAT VARY FROM STATE TO STATE.

THE CUSTOMER ACKNOWLEDGES AND AGREES THAT OLYMPUS SHALL NOT BE RESPONSIBLE FOR ANY DAMAGES THAT THE CUSTOMER MAY INCUR FROM DELAYED SHIPMENT, PRODUCT FAILURE, PRODUCT DESIGN, SELECTION, OR PRODUCTION, IMAGE OR DATA LOSS OR IMPAIRMENT OR FROM ANY OTHER CAUSE, WHETHER LIABILITY IS ASSERTED IN CONTRACT, TORT (INCLUDING NEGLIGENCE AND STRICT PRODUCT LIABILITY) OR OTHERWISE. IN NO EVENT SHALL OLYMPUS BE LIABLE FOR ANY INDIRECT, INCIDENTAL, CONSEQUENTIAL OR SPECIAL DAMAGES OF ANY KIND (INCLUDING WITHOUT LIMITATION LOSS OF PROFITS OR LOSS OF USE), WHETHER OR NOT OLYMPUS SHALL BE OR SHOULD BE AWARE OF THE POSSIBILITY OF SUCH POTENTIAL LOSS OR DAMAGE.

Representations and warranties made by any person, including but not limited to dealers, representatives, salespersons, or agents of Olympus, which are inconsistent or in conflict with or in addition to the terms of this limited warranty, shall not be binding upon Olympus unless reduced to writing and approved by an expressly authorized officer of Olympus.

This limited warranty is the complete and exclusive statement of warranty which Olympus agrees to provide with respect to the Products and it shall supersede all prior and contemporaneous oral or written agreements, understandings, proposals, and communications pertaining to the subject matter hereof.

This limited warranty is exclusively for the benefit of the original customer and cannot be transferred or assigned.

## WHAT TO DO WHEN SERVICE IS NEEDED

The customer must transfer any image or other data saved on a Product to another image or data storage medium and/or remove any film from the Product prior to sending the Product to Olympus for service.

IN NO EVENT SHALL OLYMPUS BE RESPONSIBLE FOR SAVING, KEEPING OR MAINTAINING ANY IMAGE OR DATA SAVED ON A PRODUCT RECEIVED BY IT FOR SERVICE, OR ON ANY FILM CONTAINED WITHIN A PRODUCT RECEIVED BY IT FOR SERVICE, NOR SHALL OLYMPUS BE RESPONSIBLE FOR ANY DAMAGES IN THE EVENT ANY IMAGE OR DATA IS LOST OR IMPAIRED WHILE SERVICE IS BEING PERFORMED (INCLUDING, WITHOUT LIMITATION, DIRECT, INDIRECT, INCIDENTAL, CONSEQUENTIAL OR SPECIAL DAMAGES, LOSS OF PROFITS OR LOSS OF USE), WHETHER OR NOT OLYMPUS SHALL BE OR SHOULD BE AWARE OF THE POSSIBILITY OF SUCH POTENTIAL LOSS OR IMPAIRMENT.

Package the Product carefully using ample padding material to prevent damage in transit and either deliver it to the Authorized Olympus Dealer that sold you the Product or ship it postage prepaid and insured to any of our Olympus Service Centers. When returning Products for service, your package should include the following:

- 1 Sales receipt showing date and place of purchase.
- 2 Copy of this limited warranty **bearing the Product serial number corresponding to the serial number on the Product** (unless it is a model on which Olympus does not place and record serial numbers).
- 3 A detailed description of the problem.
- 4 Sample prints, negatives, digital prints (or files on disk) if available and related to the problem.

When service is completed, the Product will be returned to you postage prepaid.

## WHERE TO SEND PRODUCT FOR SERVICE

See "WORLDWIDE WARRANTY" for the nearest service center.

## INTERNATIONAL WARRANTY SERVICE

International warranty service is available under this warranty.

## For customers in Europe



"CE" mark indicates that this product complies with the European requirements for safety, health, environment and customer protection. "CE" mark cameras are intended for sales in Europe.



This symbol [crossed-out wheeled bin WEEE Annex IV] indicates separate collection of waste electrical and electronic equipment in the EU countries. Please do not throw the equipment into the domestic refuse.



Please use the return and collection systems available in your country for the disposal of this product.



This symbol [crossed-out wheeled bin Directive 2006/66/EC Annex II] indicates separate collection of waste batteries in the EU countries. Please do not throw the batteries into the domestic refuse. Please use the return and collection systems available in your country for the disposal of the waste batteries.

## Provisions of Warranty

- 1 If this product proves to be defective, although it has been used properly (in accordance with the written Handling Care and Operating instructions supplied with it), during the applicable national warranty period and has been purchased from an authorized Olympus distributor within the business area of Olympus Imaging Europa GmbH as stipulated on the website: <http://www.olympus.com> this product will be repaired, or at Olympus's option replaced, free of charge. To claim under this warranty the customer must take the product before the end of the applicable national warranty period to the dealer where the product was purchased or any other Olympus service station within the business area of Olympus Imaging Europa GmbH as stipulated on the website: <http://www.olympus.com>. During the one year period of the World Wide Guarantee the customer may turn the product in at any Olympus service station. Please notice that not in all countries such Olympus service station exists.
- 2 The customer shall transport the product to the dealer or Olympus authorized service station at his own risk and shall be responsible for any costs incurred in transporting the product.

## Provisions of Guarantee

- 1 "OLYMPUS IMAGING CORP., Shinjuku Monolith, 2-3-1 Nishi-Shinjuku, Shinjuku-ku, Tokyo 163-0914, Japan grants a one year World Wide Guarantee. This worldwide Guarantee must be presented at an Olympus authorized repair service station before any repair can be made under conditions of this Guarantee. This Guarantee is valid only if the Guarantee Certificate and proof of purchase are presented at the Olympus repair service station. Please note that this Guarantee is in addition to and does not affect the customer's legal warranty rights under the applicable national legislation governing the sale of consumer goods mentioned above.

- 2 This Guarantee does not cover the following and the customer will be required to pay repair charge, even for defects occurring within the Guarantee period referred to above.
- Any defect that occurs due to mishandling (such as an operation performed that is not mentioned in the Handling Care or other sections of the instructions, etc.)
  - Any defect that occurs due to repair, modification, cleaning, etc. performed by anyone other than Olympus or an Olympus authorized service station.
  - Any defect or damage that occurs due to transport, a fall, shock, etc. after purchase of the product.
  - Any defect or damage that occurs due to fire, earthquake, flood damage, thunderbolt, other natural disasters, environmental pollution and irregular voltage sources.
  - Any defect that occurs due to careless or improper storage (such as keeping the product under conditions of high temperature and humidity, near insect repellents such as naphthalene or harmful drugs, etc.), improper maintenance, etc.
  - Any defect that occurs due to exhausted batteries, etc.
  - Any defect that occurs due to sand, mud, etc. entering the inside of the product casing.
  - When the Guarantee Certificate is not returned with the product.
  - When any alterations whatsoever are made to the Guarantee Certificate regarding the year, month and date of purchase, the customer's name, the dealer's name, and the serial number.
  - When proof of purchase is not presented with this Guarantee Certificate.
- 3 This Guarantee applies to the product only; the Guarantee does not apply to any other accessory equipment, such as the case, strap, lens cap and batteries.
- 4 Olympus's sole liability under this Guarantee shall be limited to repairing or replacing the product. Any liability under the Guarantee for indirect or consequential loss or damage of any kind incurred or suffered by the customer due to a defect of the product, and in particular any loss or damage caused to any lenses, films, other equipment or accessories used with the product or for any loss resulting from a delay in repair or loss of data, is excluded. Compelling regulations by law remain unaffected by this.

## Notes regarding Guarantee maintenance

- This Guarantee will only be valid if the Guarantee Certificate is duly completed by Olympus or an authorized dealer or other documents contain sufficient proof. Therefore, please make sure that your name, the name of the dealer, the serial number and the year, month and date of purchase are all completed or the original invoice or the sales receipt (indicating the dealer's name, the date of purchase and product type) is attached to this Guarantee Certificate. Olympus reserves the right to refuse free-of-charge service if neither Guarantee Certificate is completed nor the above document is attached or if the information contained in it is incomplete or illegible.
- Since this Guarantee Certificate will not be re-issued, keep it in a safe place.
  - Please refer to the list on the website: <http://www.olympus.com> for the authorized international Olympus service network.

## Trademarks

- IBM is a registered trademark of International Business Machines Corporation.
- Microsoft and Windows are registered trademarks of Microsoft Corporation.
- Macintosh is a trademark of Apple Inc.
- xD-Picture Card™ is a trademark.
- microSD is a trademark of the SD Association.
- All other company and product names are registered trademarks and/or trademarks of their respective owners.
- The standards for camera file systems referred to in this manual are the "Design rule for Camera File system/DCF" standards stipulated by the Japan Electronics and Information Technology Industries Association (JEITA).

## SPECIFICATIONS

### Camera

<b>Product type</b>	: Digital camera (for shooting and displaying)
<b>Recording system</b>	
<b>Still pictures</b>	: Digital recording, JPEG (in accordance with Design rule for Camera File system (DCF))
<b>Applicable standards</b>	: Exif 2.2, Digital Print Order Format (DPOF), PRINT Image Matching III, PictBridge
<b>Sound with still pictures</b>	: Wave format
<b>Movie</b>	: AVI Motion JPEG
<b>Memory</b>	: Internal memory xD-Picture Card (16 MB to 2 GB) (TypeH/M/M+, Standard) microSD card/microSDHC card (when using the included microSD Attachment)
<b>No. of effective pixels</b>	: 12,000,000 pixels
<b>Image pickup device</b>	: 1/2.33" CCD (primary color filter), 12,700,000 pixels (gross)
<b>Lens</b>	: Olympus lens 5.0 to 35.0 mm, f3.0 to 5.9 (equivalent to 28 to 196 mm on a 35 mm camera)
<b>Photometric system</b>	: Digital ESP metering, spot metering system
<b>Shutter speed</b>	: 4 to 1/2000 sec.
<b>Shooting range</b>	: 0.7 m (2.3 ft.) to ∞ (normal) 0.1 m (0.3 ft.) to ∞ (W), 0.6 m (2.0 ft.) to ∞ (T) (macro mode) 0.02 m (0.8 in.) to 0.7 m (2.3 ft.) (W only) (super macro mode)
<b>Monitor</b>	: STYLUS-7020/μ-7020: 3.0" TFT color LCD display, 230,000 dots STYLUS-7010/μ-7010: 2.7" TFT color LCD display, 230,000 dots
<b>Connector</b>	: STYLUS-7020/μ-7020: DC-IN jack, USB connector, A/V OUT jack (Multi-connector)/HDMI mini connector STYLUS-7010/μ-7010: USB connector, A/V OUT jack (Multi-connector)
<b>Automatic calendar system</b>	: 2000 up to 2099
<b>Operating environment</b>	
<b>Temperature</b>	: 0 °C to 40 °C (32 °F to 104 °F) (operation)/ -20 °C to 60 °C (-4 °F to 140 °F) (storage)
<b>Humidity</b>	: 30 % to 90 % (operation)/10 % to 90 % (storage)
<b>Power supply</b>	: One Olympus lithium-ion battery (LI-42B/LI-40B) or Olympus AC adapter <sup>1</sup>
<b>Dimensions</b>	: STYLUS-7020/μ-7020: 97.5 mm (W) × 56.7 mm (H) × 26.2 mm (D) (3.8 × 2.2 × 1.0 in.) (excluding protrusions) STYLUS-7010/μ-7010: 97.5 mm (W) × 55.7 mm (H) × 26.2 mm (D) (3.8 × 2.2 × 1.0 in.) (excluding protrusions)
<b>Weight</b>	: STYLUS-7020/μ-7020: 133 g (4.7 oz) (excluding battery and card) STYLUS-7010/μ-7010: 125 g (4.4 oz) (excluding battery and card)

<sup>1</sup> STYLUS-7020/μ-7020 only.

HDMI, the HDMI Logo and High-Definition Multimedia Interface are trademarks or registered trademarks of HDMI Licensing LLC.

**HDMI**™  
HIGH-DEFINITION MULTIMEDIA INTERFACE

## Lithium-ion battery (LI-42B)

<b>Product type</b>	: Lithium-ion rechargeable battery
<b>Standard voltage</b>	: DC 3.7 V
<b>Standard capacity</b>	: 740 mAh
<b>Battery life</b>	: Approx. 300 full charges (varies on usage)
<b>Operating environment</b>	
<b>Temperature</b>	: 0 °C to 40 °C (32 °F to 104 °F) (charging)/ -10 °C to 60 °C (14 °F to 140 °F) (operation)/ -20 °C to 35 °C (-4 °F to 95 °F) (storage)
<b>Dimensions</b>	: 31.5 mm (W) × 39.5 mm (H) × 6.0 mm (D) (1.2 × 1.6 × 0.2 in.)
<b>Weight</b>	: Approx. 15 g (0.5 oz)

## Battery charger (LI-41C)

<b>Model No.</b>	: LI-41CAA/LI-41CAB/LI-41CBA/LI-41CBB
<b>Power requirements</b>	: AC 100 to 240 V (50/60 Hz)
<b>Output</b>	: DC 4.2 V, 600 mA
<b>Charging time</b>	: Approx. 2 hours (when charging the supplied LI-42B battery)
<b>Operating environment</b>	
<b>Temperature</b>	: 0 °C to 40 °C (32 °F to 104 °F) (operation)/ -20 °C to 60 °C (-4 °F to 140 °F) (storage)
<b>Dimensions</b>	: 62.0 mm (W) × 23.5 mm (H) × 90.0 mm (D) (2.4 × 0.9 × 3.5 in.)
<b>Weight</b>	: Approx. 65 g (2.3 oz)

## microSD Attachment

<b>Product type</b>	: Attachment for microSD
<b>Operating Environment</b>	
<b>Temperature</b>	: -10 °C to 40 °C (14 °F to 104 °F) (operation)/ -20 °C to 65 °C (-4 °F to 149 °F) (storage)
<b>Humidity</b>	: 95% and below (operation)/85% and below (storage)
<b>Dimensions</b>	: 25.0 mm (W) × 20.3 mm (H) × 1.7 mm (D) (1.0 × 0.8 × 0.07 in.) (Handle: 2.2 mm (0.09 in.))
<b>Weight</b>	: Approx. 0.9 g (0.03 oz)

Design and specifications subject to change without notice.



## A

AF MODE .....	27
AF target mark .....	14
AF TRACKING .....	18, 27
Aperture value .....	14
AV cable .....	2, 41





## B

Backlight boost .....	22
BACKUP .....	37
Battery .....	2, 10, 11, 50, 53, 55
Battery Charger .....	2, 10, 55
BEAUTY mode .....	17
BEAUTY FIX  .....	33
BEEP .....	38
Black & White .....	34





## C

CALENDAR .....	34
Calendar view .....	23
CAMERA MENU  .....	5, 26
CLEAR SKIN .....	33
Close-up view .....	23
COLOR EDIT .....	34
Color hue .....	53
COMPRESSION .....	25
Connecting	
TV .....	41
Printer .....	43
PC .....	48
Continuous recording length .....	57
Cropping  .....	33, 45
CUSTOM PRINT .....	44

## D

Date and time  .....	13, 40
DIGITAL ZOOM .....	19, 27
Direct printing .....	43
DIS MOVIE MODE  .....	28
Display language   .....	13, 37
DPOF .....	46
DRAMATIC EYE .....	33
DRIVE .....	26
DUALTIME .....	40

## E

EASY PRINT .....	43
EDIT  .....	5, 33, 54
ERASE  .....	
Single image erase .....	16
SEL. IMAGE .....	36
ALL ERASE .....	36
Error message .....	51
ESP/  .....	27
ESP .....	27
Exposure .....	14, 53
Exposure compensation  .....	20

## F

FACE DETECT .....	27
FACE FOCUS .....	34
FILE NAME .....	39
FILL IN .....	19
FINE ZOOM .....	27
Flash .....	19
FLASH AUTO .....	19
FLASH OFF .....	19
Focusing .....	14, 27, 52
FORMAT .....	37, 51
FRAME RATE .....	25
FUNC menu .....	22

## G

Grid .....	21
------------	----

## H

HDMI .....	42
HDMI cable .....	41
Histogram .....	21, 23

## I

<b>IAUTO</b> mode .....	18
iESP .....	27
IMAGE QUALITY  .....	25
IMAGE SIZE .....	25
IMAGE STABILIZER .....	28
INDEX .....	35
Index view .....	23

Information display.....	21, 23
Internal memory.....	11, 56
ISO.....	26

## L

Lithium-ion battery .....	2, 10, 55
---------------------------	-----------

## M

MACRO 	20
MAGIC FILTER 	31
MEMORY FORMAT .....	37, 51
MENU COLOR .....	38
microSD Attachment.....	2, 12, 58
microSD card.....	12, 58
Monitor brightness 	40
Movie 	18
MTP .....	48, 49
MULTI WINDOW .....	22







## N

NTSC.....	41
Number of storable pictures.....	57

## O



OLYMPUS Master 2 .....	2, 30, 48
Optical zoom.....	19

## P









PAL.....	41
PANORAMA 	30
PERFECT FIX 	32
PIC ORIENTATION.....	40
PictBridge .....	43
PIXEL MAPPING .....	39
Playback 	15, 54
PLAYBACK MENU 	5, 35
POWER SAVE.....	42
PRINT ORDER 	36, 46
Protecting images 	35
PW ON SETUP.....	37

## R

REC VIEW .....	38
REDEYE .....	19
REDEYE FIX .....	32
RESET 	31

Resize 	33
Rotating images 	35

## S

Saturation .....	34
<b>SCN</b> 	17, 29
Self-timer .....	21
Sepia.....	34
Sequential shooting.....	26
SETUP 	37
SHADOW ADJ.....	22, 28, 32
Shooting still picture 	14
SHUTTER SOUND.....	38
Shutter speed .....	14
SILENT MODE 	42
Single-frame shooting.....	26
Sleep mode.....	50
SLIDESHOW 	32
Sound recording 	28, 36
SOUND SETTINGS.....	38
SPARKLE EYE .....	33
SPOT (AF MODE) .....	27
Spot  (ESP/  ) .....	27
Strap .....	2, 10
SUPER MACRO 	20

## U

USB Cable.....	2, 43, 48
----------------	-----------

## V

VIDEO OUT.....	41
Volume.....	16, 38

## W

Warning sound 	38
WB.....	26

## X

xD-Picture Card .....	11, 56
-----------------------	--------

# OLYMPUS®

<http://www.olympus.com/>

## OLYMPUS IMAGING CORP.

Shinjuku Monolith, 3-1 Nishi-Shinjuku 2-chome, Shinjuku-ku, Tokyo, Japan

## OLYMPUS IMAGING AMERICA INC.

3500 Corporate Parkway, P.O. Box 610, Center Valley, PA 18034-0610, U.S.A. Tel. 484-896-5000

### Technical Support (USA)

24/7 online automated help: <http://www.olympusamerica.com/support>

Phone customer support: Tel. 1-888-553-4448 (Toll-free)

Our phone customer support is available from 8 am to 10 pm

(Monday to Friday) ET

<http://olympusamerica.com/contactus>

Olympus software updates can be obtained at: <http://www.olympusamerica.com/digital>

## OLYMPUS IMAGING EUROPA GMBH

Premises: Wendenstrasse 14-18, 20097 Hamburg, Germany

Tel: +49 40-23 77 3-0 / Fax: +49 40-23 07 61

Goods delivery: Bredowstrasse 20, 22113 Hamburg, Germany

Letters: Postfach 10 49 08, 20034 Hamburg, Germany

### European Technical Customer Support:

Please visit our homepage <http://www.olympus-europa.com>

or call our TOLL FREE NUMBER\* : **00800 - 67 10 83 00**

for Austria, Belgium, Denmark, Finland, France, Germany, Italy, Luxemburg, Netherlands,  
Norway, Portugal, Spain, Sweden, Switzerland, United Kingdom

\* Please note some (mobile) phone services providers do not permit access or request an  
additional prefix to +800 numbers.

For all European Countries not listed and in case that you can't get connected

to the above mentioned number, please make use of the following

CHARGED NUMBERS: **+49 180 5 - 67 10 83** or **+49 40 - 237 73 4899**

Our Technical Customer Support is available from 9 am to 6 pm MET (Monday to Friday)