

OLYMPUS[®]

DIGITAL CAMERA

STYLUS TOUGH-8000 / μ TOUGH-8000

Instruction Manual

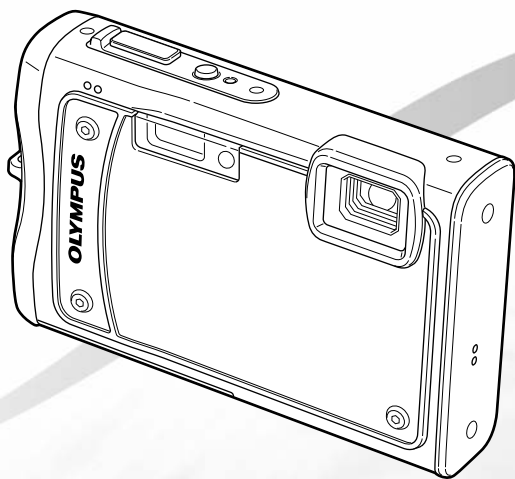

- Thank you for purchasing an Olympus digital camera. Before you start to use your new camera, please read these instructions carefully to enjoy optimum performance and a longer service life. Keep this manual in a safe place for future reference.
- We recommend that you take test shots to get accustomed to your camera before taking important photographs.
- In the interest of continually improving products, Olympus reserves the right to update or modify information contained in this manual.
- The screen and camera illustrations shown in this manual were produced during the development stages and may differ from the actual product.

Step 1

Checking the contents of the box



Digital camera



Strap



LI-50B Lithium Ion Battery



AC adaptor (F-1AC)



or



USB cable



AV cable



OLYMPUS Master 2 CD-ROM



microSD Attachment

Other accessories not shown: Instruction Manual (this manual), warranty card
Contents may vary depending on purchase location.

Step 2

Preparing the Camera

"Preparing the Camera" (p. 10)

Step 3

Shooting and Playing Back Images

"Shooting, Viewing, and Erasing" (p. 16)

Step 4

How to Use the Camera

"Four Types of Setting Operations" (p. 3)

Step 5

Printing

"Direct printing (PictBridge)" (p. 51)

"Print Reservations (DPOF)" (p. 54)

Contents

➤ Names of Parts	6	➤ Menus for Playback, Editing, and Printing Functions.....	37
➤ Preparing the Camera	10	➤ Menus for Other Camera Settings	42
➤ Shooting, Viewing, and Erasing.....	16	➤ Printing.....	51
➤ Using Shooting Modes.....	19	➤ Using OLYMPUS Master 2.....	57
➤ Using Shooting Functions.....	22	➤ Usage Tips	59
➤ Using Playback Features	27	➤ Appendix	64
➤ Menus for Shooting Functions.....	29	➤ Index	79

Four Types of Setting Operations

Using the Menu

Various camera settings can be accessed through the menus, including functions used during shooting and playback and the date/time and screen display.

- There may be unavailable menus depending on the other related settings or the selected **SCN** mode (p. 33).

1 Set the mode dial to a position other than **AUTO**.

- The  symbol in "Menu Settings" (p. 29 to 50) indicates available shooting modes.







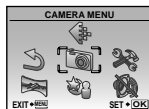

2 Press the **MENU** button.

- This example describes how to set the [DIGITAL ZOOM].



Shooting mode top menu

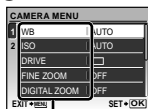

3 Use     to select the desired menu, and press the  button.

- Pressing and holding the  button displays an explanation (menu guide) of the selected option.

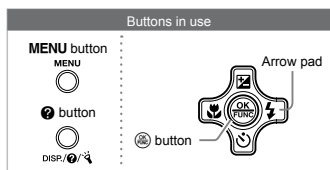

Submenu 1





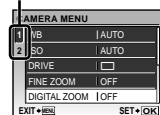

4 Use   to select the desired Submenu 1, and press the  button.

Page tab

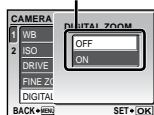



Submenu 2



- To quickly move to the desired submenu, press  to highlight the page tab, and then use   to move the page tab. Press  to return to the Submenu 1.

- Some menu include submenus that appear by pressing the  button.

5 Use   to select the Submenu 2, and press the  button.

- Once a setting is adjusted, the display returns to the previous screen.

- There may be additional operations. "Menu Settings" (p. 29 to 50)

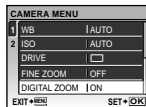

6 Press the **MENU** button to complete the setting.

Using the Direct Buttons

Frequently used shooting functions can be accessed using the direct buttons.

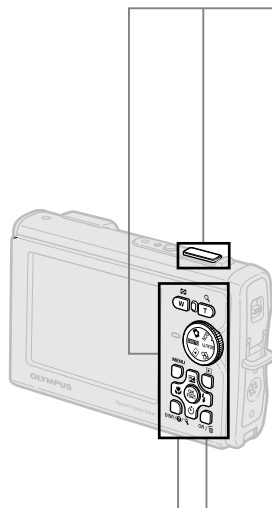

Shutter button (p. 15)



Zoom button (p. 22, p. 27)



☒ button (exposure compensation) (p. 23)

🌿 button (macro) (p. 23)

⚡ button (flash) (p. 22)

🕒 button (self-timer) (p. 24)



▶ button (playback) (p. 17)

DISP./📄/💡 button (information display change/menu guide/date and time check/LED illuminator) (p. 3, p. 14, p. 24)

OR/📄 button (panorama/tap control/Shadow Adjustment Technology/multi window/erase) (p. 18, p. 26)

Using the FUNC Menu (p. 25)

Frequently used shooting menu functions can be set with less steps using the FUNC menu.

📄 button (p. 3, p. 25)

Buttons in use

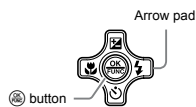

Operating the camera by tapping the body (p. 49)

You can operate the camera by tapping the body when [TAP CONTROL] is [ON].

To set [TAP CONTROL] to [ON]

- 1 Tap the top surface of the camera twice.
 - The [TAP CONTROL] settings screen displays.
- 2 Tap the top surface of the camera twice.
 - The setting is confirmed.

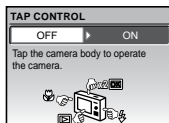
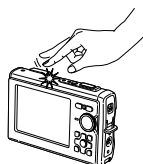

Menu Index

Menus for Shooting Functions

When the mode dial is set to a shooting mode position (AUTO, SCN, BEAUTY, etc.), settings can be adjusted.

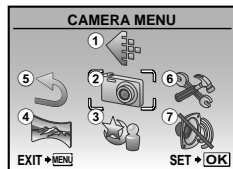

Shooting mode top menu

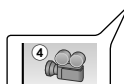

Only for mode

- | | | |
|-----------------------------|--------------------------|---------------------------|
| ① IMAGE QUALITY..... p.29 | ③ SCENE MODE..... p.33 | REC VIEW..... p.44 |
| ② CAMERA MENU | ④ PANORAMA..... p.34 | FILE NAME..... p.45 |
| WB..... p.30 | ④ MOVIE p.36 | PIXEL MAPPING..... p.45 |
| ISO..... p.30 | ⑤ RESET p.36 | ! (Monitor)..... p.46 |
| DRIVE..... p.31 | ⑥ SETUP | (Date/time)..... p.46 |
| FINE ZOOM..... p.31 | MEMORY FORMAT/ | DUALTIME..... p.46 |
| DIGITAL ZOOM p.31 | FORMAT p.42 | VIDEO OUT..... p.47 |
| ESP/..... p.32 | BACKUP..... p.42 | POWER SAVE..... p.48 |
| AF MODE p.32 | (Language)..... p.42 | LED ILLUMINATOR..... p.48 |
| (Sound recording) p.32 | PW ON SETUP p.43 | MANOMETER p.48 |
| IMAGE STABILIZER | MENU COLOR p.43 | m/ft..... p.48 |
| (Still images)/ | SOUND SETTINGS..... p.44 | TAP CONTROL p.49 |
| DIS MOVIE MODE | | ⑦ SILENT MODE p.50 |
| (Movies)..... p.32 | | |

Menus for Playback, Editing, and Printing Functions

When the mode dial is set to the position, settings can be adjusted.

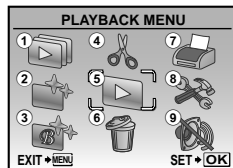
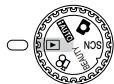

Playback mode top menu

- | | | |
|---------------------------|--|--|
| ① SLIDESHOW p.37 | CALENDAR..... p.39 | ⑥ ERASE..... p.40 |
| ② PERFECT FIX p.37 | INDEX..... p.39 | ⑦ PRINT ORDER..... p.41 |
| ③ BEAUTY FIX..... p.37 | ⑤ PLAYBACK MENU | ⑧ SETUP |
| ④ EDIT | (Protect)..... p.39 | Same as "Menus for Shooting Functions" |
| (Resize)..... p.38 | (Rotate)..... p.40 | ⑨ SILENT MODE p.50 |
| (Crop)..... p.38 | (Add sound to still images) p.40 | |
| COLOR EDIT..... p.38 | | |



Names of Parts

Camera unit

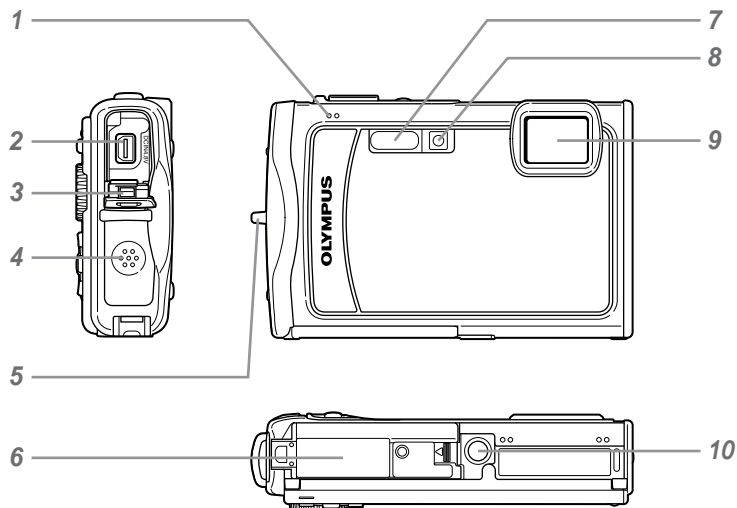

- | | | | | | |
|---|--------------------------------------|------------------|----|---------------------------------------|----------|
| 1 | Microphone | p.32, 40 | 7 | Flash | p.22 |
| 2 | Multi-connector | p.47, 51, 57 | 8 | Self-timer lamp/LED illuminator | p.24, 48 |
| 3 | Connector cover | p.47, 51, 57, 70 | 9 | Lens | p.64 |
| 4 | Speaker | — | 10 | Tripod socket | — |
| 5 | Strap eyelet..... | p.10 | | | |
| 6 | Battery/card compartment cover | p.10, 60, 70 | | | |

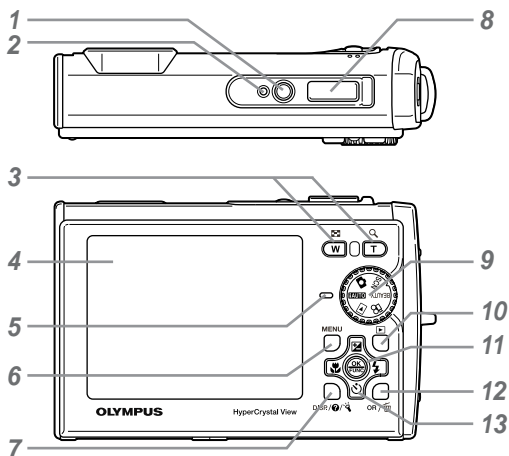

- | | |
|--|--|
| <p>1 ON/OFF button p.14</p> <p>2 Underwater sensor p.19, 26, 30</p> <p>3 Zoom button..... p.22, 27</p> <p>4 Monitor..... p.8, 16, 46, 59</p> <p>5 Card access lamp/
charging indicator p.66/p.12</p> <p>6 MENU button..... p.3, 5</p> <p>7 DISP.// button
(information display change/
menu guide/date and time check/
LED illuminator) p.3, 14, 24</p> <p>8 Shutter button p.16, 59</p> | <p>9 Mode dial p.3, 5, 16, 17, 19</p> <p>10 button (playback) p.17</p> <p>11 button (OK/FUNC)..... p.3, 25</p> <p>12 OR/ button (panorama/tap control/
Shadow Adjustment Technology/
multi window/erase) p.18, 26</p> <p>13 Arrow pad p.3, 4, 13</p> <p> button
(exposure compensation)..... p.23</p> <p> button (macro) p.23</p> <p> button (self-timer) p.24</p> <p> button (flash)..... p.22</p> |
|--|--|

Shooting mode display

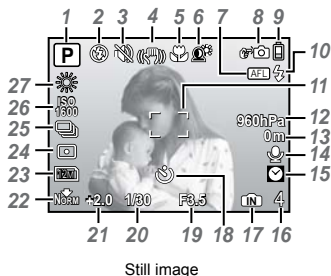

Still image

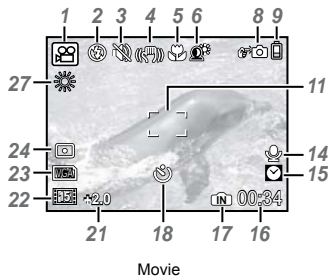

Movie

- | | |
|---|--|
| <p>1 Shooting mode..... p.19, 21</p> <p>2 Flash mode p.22</p> <p>3 Silent mode..... p.50</p> <p>4 Image stabilization (still images)/
Digital image stabilization (movies)
..... p.32</p> <p>5 Macro/super macro/
S-macro LED mode p.23</p> <p>6 Shadow Adjustment Technology ... p.33</p> <p>7 AF lock..... p.19</p> <p>8 Tap control p.4, 34, 49</p> <p>9 Battery check..... p.12, 60</p> <p>10 Flash standby/camera shake warning/
flash charge p.59</p> <p>11 AF target mark..... p.16</p> <p>12 Atmospheric/
hydraulic pressure p.48</p> | <p>13 Altitude/water depth p.48</p> <p>14 Sound record p.21, 32</p> <p>15 Dual time..... p.46</p> <p>16 Number of storable still pictures/
remaining recording time
..... p.16, 21, 67</p> <p>17 Current memory p.66</p> <p>18 Self-timer p.24</p> <p>19 Aperture value p.16</p> <p>20 Shutter speed p.16</p> <p>21 Exposure compensation p.23</p> <p>22 Compression/Frame rate p.29</p> <p>23 Image size p.29</p> <p>24 Metering..... p.32</p> <p>25 Drive p.31</p> <p>26 ISO..... p.30</p> <p>27 White balance p.30</p> |
|---|--|

Playback mode display

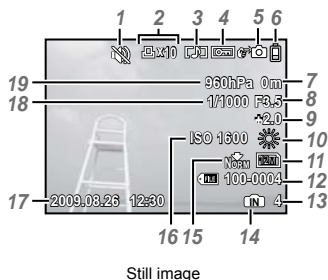

Still image

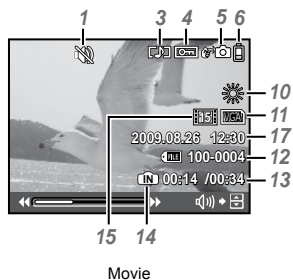

Movie

1	Silent mode.....	p.50
2	Print reservation/ number of prints.....	p.54/p.53
3	Sound record.....	p.21, 32, 40, 63
4	Protect.....	p.39
5	Tap control.....	p.4, 34, 49
6	Battery check.....	p.12, 59
7	Altitude/water depth.....	p.48
8	Aperture value.....	p.16
9	Exposure compensation.....	p.23
10	White balance.....	p.30
11	Image size.....	p.29

12	File number.....	p.45
13	Frame number Elapsed time/total recording time	p.18
14	Current memory.....	p.66
15	Compression/Frame rate.....	p.29
16	ISO.....	p.30
17	Date and time.....	p.14, 46
18	Shutter speed.....	p.16
19	Atmospheric/ hydraulic pressure.....	p.48



Preparing the Camera

Attaching the camera strap

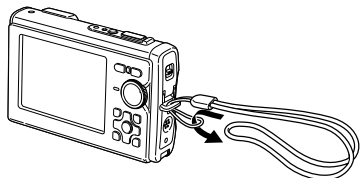

- ! Pull the strap tight so that it does not come loose.

Loading the battery and the xD-Picture Card™ (sold separately) into the camera

- ! Do not insert anything other than an xD-Picture Card or the microSD Attachment into the camera.

1

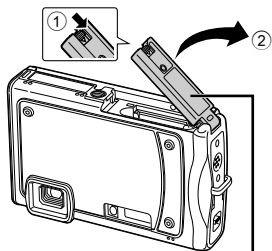

Battery/card compartment cover

2

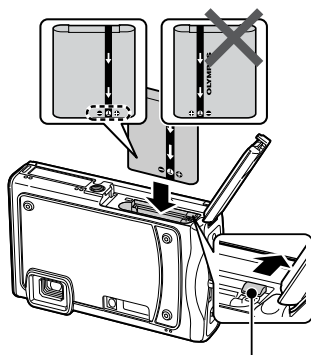

Battery lock knob

- ! The battery has front side and back side. Insert the battery in the correct direction as illustrated. If the battery is not inserted correctly, the camera does not operate.
- ! Insert the battery while sliding the battery lock knob in the direction of the arrow.
- ! Sliding the battery lock knob in the direction of the arrow to unlock, and then remove the battery.
- ! Be sure to turn off the camera when you open or close the battery/card compartment cover.

3

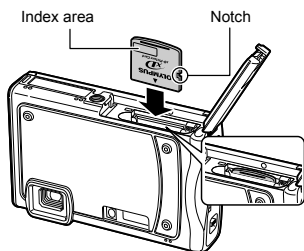

- ❗ Insert the card straight in until it clicks into place.
- ❗ Do not touch the contact area on the card.

4

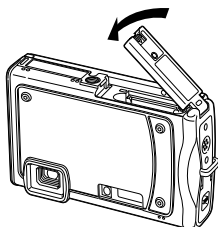

- ❗ This camera allows the user to take pictures using the internal memory even when no xD-Picture Card (sold separately) is inserted. "Using an xD-Picture Card" (p. 66)
- ❗ "Number of storable pictures (still pictures)/ continuous recording length (movies) in the internal memory and xD-Picture card" (p. 67)

To remove the xD-Picture Card

①

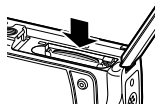

②

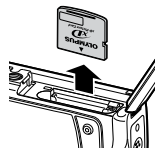

- ❗ Press in the card until it clicks and comes out slightly, and then grasp the card to pull it out.

Charging the battery

- ❗ The included AC adaptor (F-1AC/with an AC cable or plug-in type) differs depending on the region where you purchased the camera. If you received a plug-in type AC adaptor, plug it directly into an AC outlet.
- ❗ The included AC adaptor (F-1AC) has been designed to be used only for charging. Make sure that operations such as shooting, viewing images and so on are not being used while the AC adaptor is connected to the camera.

Example: AC adaptor with an AC cable

1

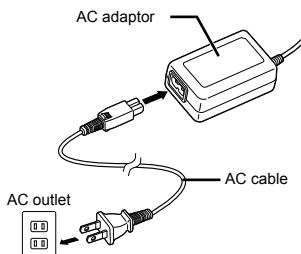

2

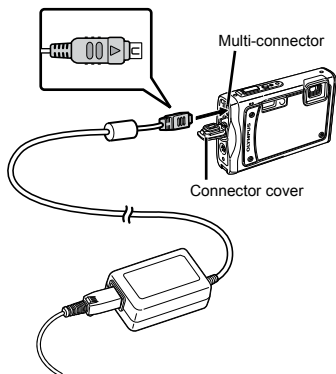

When to charge the battery

Charge the battery when the error message shown below appears.

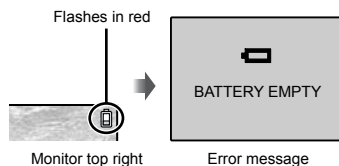

3

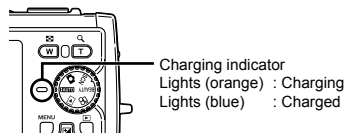

- ❗ Battery comes partially charged. Before use, be sure to charge the battery until the charging indicator goes off (for approx. 2.5 hours).
- ❗ If the charging indicator does not light or it blinks, there may be cases in which the connections are not correct, or the battery, camera, and/or AC adaptor may be damaged.
- ❗ For details on the battery and the AC adaptor, see "Battery, AC adaptor (included), Charger (sold separately)" (p. 64).

Using a microSD card/ microSDHC card (sold separately)

microSD card/microSDHC card (hereinafter referred to as "microSD card") is also compatible with this camera by using the microSD Attachment.

! "Using a microSD Attachment" (p. 68)

1 Insert the microSD card into the Attachment.

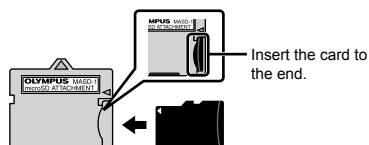

2 Insert the microSD Attachment into the camera.

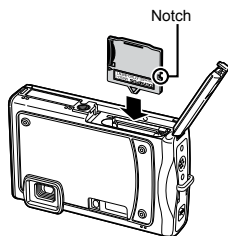

To remove the microSD card

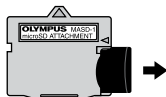

- ! Pull the microSD card straight out.
- ! Do not touch the contact area on the microSD Attachment and microSD card.

Arrow pad and operation guide

The symbols \triangle ∇ \triangleleft \triangleright , \square \square \square displayed on various setting and movie playback screens indicate that arrow pad are used.

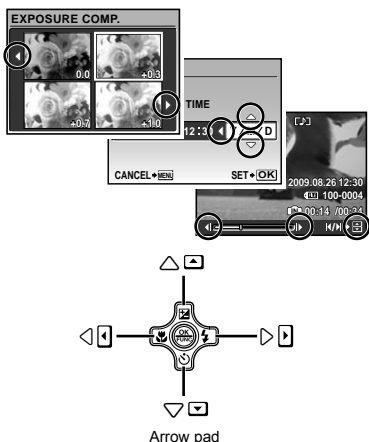

Operation guides displayed at the bottom of the screen indicate that the **MENU** button, \square button, zoom button, or \square button is used.

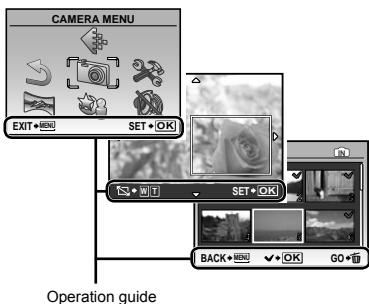

Setting the date and time

The date and time set here are saved to image file names, date prints, and other data.

1 Press the ON/OFF button to turn on the camera.

- The date and time setting screen is displayed when the date and time are not set.

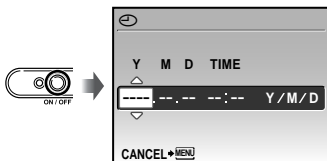

Date and time setting screen

2 Use the OK button to select the year for [Y].

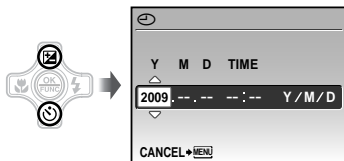

3 Press the OK button to save the setting for [Y].

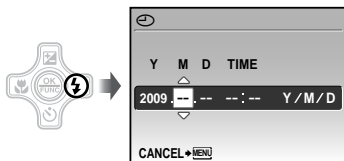

4 As in steps 2 and 3, use the OK button and the DISP button to set [M] (month), [D] (day), and [TIME] (hours and minutes), and [Y/M/D] (date order).

- For precise time setting, press the DISP button as the time signal strikes 00 seconds.
- To change the date and time, adjust the setting from the menu. [Date/time] (p. 46)

To check the date and time

Press the DISP. button while the camera is turned off. The current time is displayed for approx. 3 seconds.

Changing the display language

The language for the menu and error messages displayed on the monitor is selectable.

1 Press the MENU button, and press the OK button to select [SETUP].

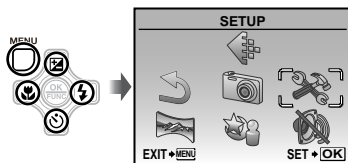

2 Press the OK button.

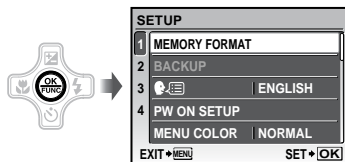

-
- 3 Use   to select  and press the  button.

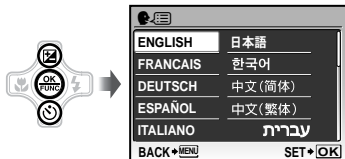

-
- 4 Use     to select your language and press the  button.

-
- 5 Press the MENU button.



Shooting, Viewing, and Erasing

Shooting with optimum aperture value and shutter speed (P mode)

In this mode, automatic camera shooting can be used while also allowing changes to a wide range of other shooting menu functions, such as exposure compensation, white balance, and so on when needed.

1 Set the mode dial to .



2 Press the ON/OFF button to turn on the camera.

Number of storable still pictures (p. 67)

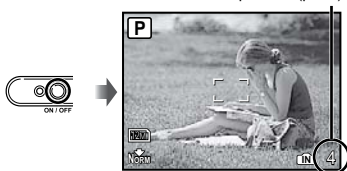

Monitor
(standby mode screen)

 Press the ON/OFF button again to turn off the camera.

3 Hold the camera, and compose the shot.

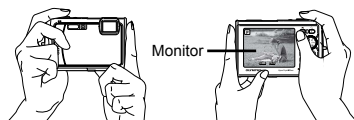

Horizontal grip

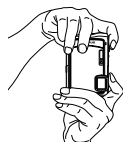

Vertical grip

 When holding the camera, take care not to cover the flash with your fingers, etc.

4 Press the shutter button halfway down to focus on the subject.

- When the camera focuses on the subject, the exposure is locked (shutter speed and aperture value are displayed), and the AF target mark changes to green.
- The camera was unable to focus if the AF target mark flashes red. Try focusing again.

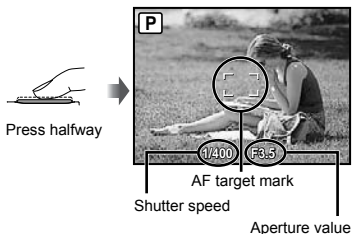

 "Focusing" (p. 61)

- 5 To take the picture, gently press the shutter button all the way down while being careful not to shake the camera.

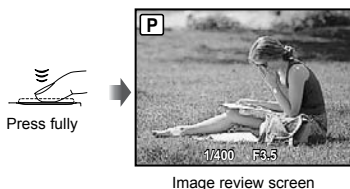

To view images during shooting

Pressing the button enables playback of images. To return to shooting, either press the button again or press the shutter button halfway down.

- ! You can operate the camera by tapping the body when [TAP CONTROL] is [ON]. [TAP CONTROL] (p. 49)

To shoot movies

"Shooting movies (mode)" (p. 21)

Viewing images

- 1 Set the mode dial to .

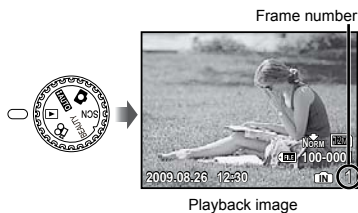

- 2 Use to select an image.

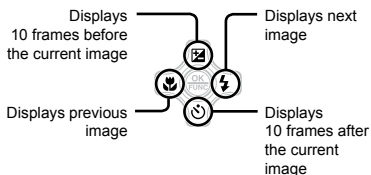

- ! The display size of the images can be changed. "Index view, calendar view, and close-up view" (p. 27)

To play back movies

Select a movie, and press the button.



Movie

Operations during movie playback

Volume: During playback, press .
Fast-forward/rewind: Select with .
Each time a button is pressed, the playback speed cycles through 2x, 20x, and standard (1x) speed in the direction of the pressed button.

Pause: Press the button.

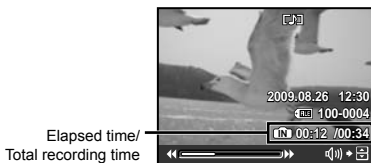

During playback

First (last) frame/frame advance:
During pause, press to display the first frame, and press to display the last frame. Playback is reversed while is pressed, playback occurs normally while is pressed. Press the button to resume playback.



During pause

To stop movie playback

Press the **MENU** button.

Erasing images during playback (Single image erase)

- 1 Press the button when the playback image to be erased is displayed.



- 2 Press to select [YES], and press the button.

[ERASE] (p. 40)



Using Shooting Modes

This section describes the available shooting modes. Depending on the mode, some settings can be changed. For details on the functions that can be adjusted, see "Menus for Shooting Functions" on page 29.

Using the best mode for the shooting scene (**SCN** mode)

1 Set the mode dial to **SCN**.



- An explanation of the selected mode is displayed while the  button is pressed and held.





2 Use to select the best shooting mode for the scene, and press the button.

Icon indicating the scene mode that is set



- ! To change to another scene mode, use the menu. [ SCENE MODE] (p. 33)

To take underwater photos





Select [ UNDERWATER SNAPSHOT], [ UNDERWATER WIDE1], [ UNDERWATER WIDE2]¹, [ UNDERWATER MACRO].

When the mode dial is set to **SCN** during underwater shooting (i.e., while the underwater sensor is responding), the above mentioned 4 modes appear before other modes.

¹ When set to [ UNDERWATER WIDE2], the focus distance is automatically fixed to approx. 5.0 m (16.4 ft.).

- ! Be sure to use an underwater case when using the camera at depths exceeding 10 m (32.8 ft.).
- ! When [MANOMETER] (p. 48) is set to [ON], the altitude/water depth (atmospheric/hydraulic pressure) appears on the shooting standby mode screen as a rough guide. "Shooting mode display" (p. 8)
- ! "Important information about water and shock resistant features" (p. 68)

To lock the focus distance for underwater shoots (AF lock)

When [ UNDERWATER SNAPSHOT], [ UNDERWATER WIDE1], or, [ UNDERWATER MACRO] is selected, press .

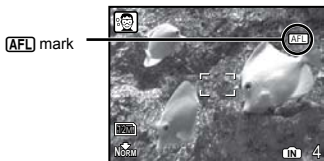

- ! To cancel, press  again to clear the **AF-L** mark.

Enhancing skin tone and texture (BEAUTY mode)

The camera finds a person's face and gives the skin a smooth, translucent look for taking the picture.

1 Set the mode dial to BEAUTY.

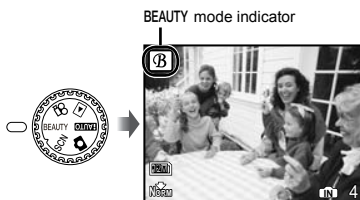

2 Point the camera toward the subject. Check the frame appearing around the face detected by the camera, and then press the shutter button to take the picture.

- The unedited image and edited image are both saved.
- If the image cannot be retouched, only the unedited image is saved.
- ! For some subjects, the frame may not appear, may take some time to appear, or the editing may not be effective.
- ! The [IMAGE SIZE] of the retouched image is limited to [2M] or lower.

Shooting with automatic settings (FAUTO mode)

The camera will automatically select the optimal shooting mode for the scene. This is a fully automatic mode that allows you to take a picture suited to the scene by simply pressing the shutter button. Settings in the shooting function menu are not available in FAUTO mode.

1 Set the mode dial to FAUTO.

The indicator changes to the icon for the scene mode selected by the camera.

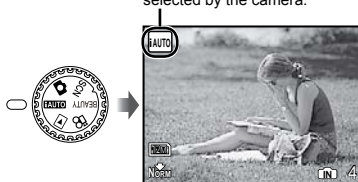

- Press the shutter button halfway down or press the DISP. button to check which shooting mode the camera has automatically selected.
- ! In some cases, the camera may not select the desired shooting mode.
- ! When the camera cannot identify which is the optimal mode, P mode will be selected.

Shooting movies (M mode)

Audio is recorded with the movie.

1 Set the mode dial to M.

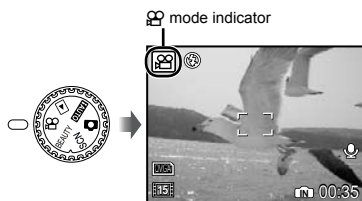

To zoom while shooting a movie

The optical zoom is not available while shooting a movie.

Use [DIGITAL ZOOM] (p. 31).

To shoot a movie with digital image stabilization

[DIS MOVIE MODE] (p. 32)

2 Press the shutter button halfway down to focus on the subject, and gently press the button all the way down to start recording.

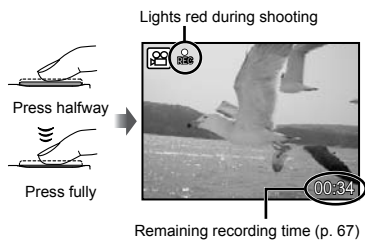

3 Gently press the shutter button all the way down to stop recording.



Using Shooting Functions

In addition to the wide variety of shooting modes, the camera has functions that broaden the expressive range and shooting options available to the photographer.

Using the optical zoom

Pressing the zoom button adjusts the shooting range.

Pressing the wide (W) button Pressing the telephoto (T) button



Zoom bar

- ! Optical zoom: 3.6x, Digital zoom: 5.0x.
- ! Use of [IMAGE STABILIZER] (Still image)/ [DIS MOVIE MODE] (Movie) (p. 32) is recommended when shooting with the telephoto zoom.

To take larger images without reducing image quality

[FINE ZOOM] (p. 31)

To take larger images

[DIGITAL ZOOM] (p. 31)

- ! The zoom bar appearance identifies the status of the fine zoom/digital zoom.

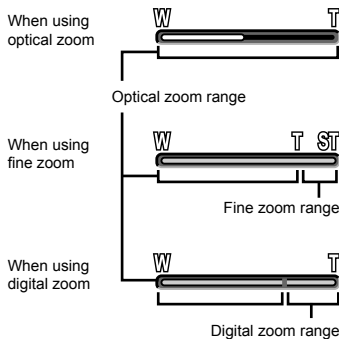

Using the flash

The flash functions can be selected to best match the shooting conditions and render the desired image.

1 Press the button.

- ! You can operate the camera by tapping the body when [TAP CONTROL] is [ON]. [TAP CONTROL] (p. 49)



- 2 Use to select the setting option, and press the to set.

Item	Description
FLASH AUTO	The flash fires automatically in low-light or backlight conditions.
REDEYE	This emits pre-flashes to reduce the occurrence of red eye in your photos.
FILL IN	The flash fires regardless of the available light.
FLASH OFF	The flash does not fire.

Adjusting the brightness (Exposure compensation)

The standard brightness (appropriate exposure) set by the camera based on the shooting mode (except for **IAUTO**) can be adjusted brighter or darker to obtain a desired shot.

- 1 Press the button.

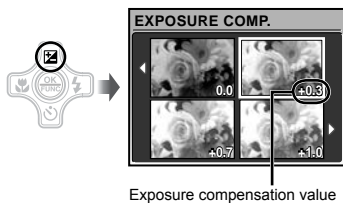

- 2 Use to select the desired brightness image, and press the button.

Shooting closeups (Macro shooting)

This function enables the camera to focus and shoot subjects at close distances.

- 1 Press the button.

- ! You can operate the camera by tapping the body when [TAP CONTROL] is [ON].
[TAP CONTROL] (p. 49)



- 2 Use to select the setting option, and press the button to set.

Item	Description
OFF	Macro mode is deactivated.
MACRO	This enables shooting as close as 10 cm/3.9 in. ¹ (30 cm/11.8 in. ²) to the subject.
SUPER MACRO ³	This enables shooting as close as 2 cm/0.8 in. to the subject. Subjects at 50 cm/19.7 in. or farther cannot be brought into focus.
S-MACRO LED ^{3,4}	The LED illuminator lights the area 7 to 20 cm (2.8 to 7.9 in.) from the lens, while the shutter button is pressed halfway down.

¹ When the zoom is at the widest (W) position.

² When the zoom is at the most telephoto (T) position.

³ The zoom is automatically fixed.

⁴ [ISO] (p. 30) is automatically fixed to [AUTO].

- ! The flash (p. 22) and zoom (p. 22) cannot be set when [s/w] or [s/w] is selected.

Using the self-timer

After the shutter button is pressed all the way down, the picture is taken after a time delay.

1 Press the button.



2 Use to select the setting option, and press the button to set.

Item	Description
OFF	This cancels the self-timer.
ON	The self-timer lamp turns on for approx. 10 seconds, and then blinks for approx. 2 seconds, and then the picture is taken.

- ! Self-timer shooting is automatically canceled after one shot.

To cancel the self-timer after it starts

Press the  button again.

Using the LED illuminator

In a dark location, the LED illuminator can be used as an auxiliary light to see things or compose shots.

1 Set [LED ILLUMINATOR] (p. 48) to [ON].

2 Press and hold the button down until the LED illuminator lights up.

- If you perform an operation when the LED illuminator is on, it will illuminate up to approx. 90 seconds.

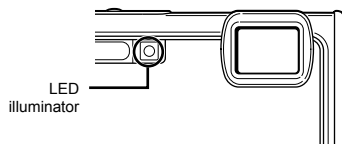

- ! The LED illuminator turns off if no operation is performed for approx. 30 seconds.
- ! Even when the camera's power is turned off, if the  button is pressed until the LED illuminator lights up, it lights for 30 seconds.

To turn the LED illuminator off

Press and hold the  button down, until the LED illuminator turns off.

Changing the shooting information display

The display of the screen information can be changed to best match the situation, such as for the need of clear view of the screen or for making a precise composition by using the grid display.

1 Press the DISP. button.

- The displayed shooting information changes in the order shown below each time the button is pressed. "Shooting mode display" (p. 8)

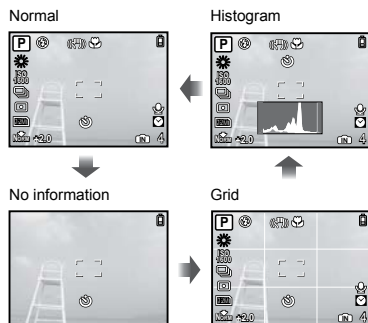

Reading a histogram

If the peak fills too much of the frame, the image will appear mostly white.

If the peak fills too much of the frame, the image will appear mostly black.

The green section shows the luminance distribution in the center area of the monitor.



Using the FUNC menu

The FUNC menu provides the following menu functions that can be quickly called and set.

- [WB] (p. 30)
- [ESP/□] (p. 32)
- [ISO] (p. 30)
- [◀ IMAGE QUALITY] (p. 29)
- [DRIVE] (p. 31)

1 Press the button.

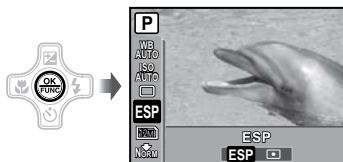

2 Use to select the menu function and to select the setting option, and then press the button to set.

Quickly calling and using shooting functions

The following menu functions can be quickly called and used.

- [PANORAMA] (p. 34)
- [SHADOW ADJ] (p. 33)
- [TAP CONTROL] (p. 49)
- [MULTI WINDOW] (p. 26)

1 Press the OR/ button.

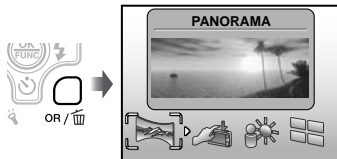

2 Use the button to select the menu function, and press the button to set.

To use the effects preview screen (Multi window)

Selecting an option from [ZOOM], [EXPOSURE COMP.], [WB] or [ESP/] shows 4 preview images that reflect the adjusted values of the selected shooting function. Use the buttons to select the desired image, and press the button.

Brightening the monitor (Backlight boost)

Pressing and holding the OR/ button brightens the monitor. The monitor returns to the original brightness if no operation is performed for 10 seconds.

- ! During underwater shooting (i.e., while the underwater sensor is responding), the backlight boost operates automatically.

Using Playback Features

Index view, calendar view, and close-up view

Index view and calendar view enable quick selection of a target image. Close-up view (up to 10x magnification) allows checking of image details.

1 Press the zoom button.

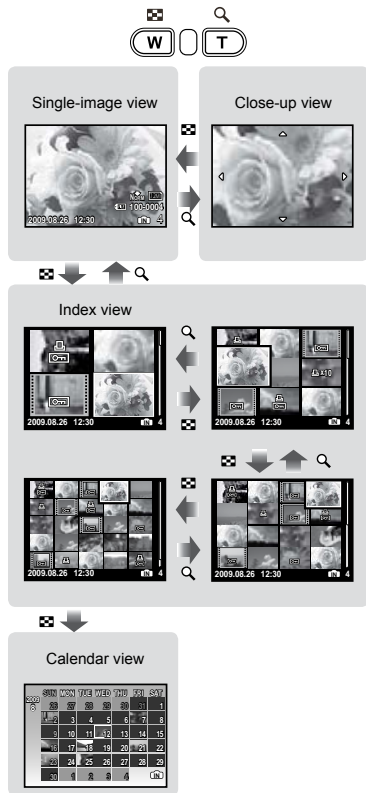

To select an image in index view

Use to select an image, and press the button to display the selected image in single-image view.

To select images in calendar view

Use to select a date and press the button or T on the zoom button to view the images taken on the selected date.

To scroll an image in close-up view

Use to move the viewing area.

Changing the image information display

Shooting information displayed on the screen can be changed.

1 Press the DISP. button.

- The displayed image information changes in the order shown below each time the button is pressed.

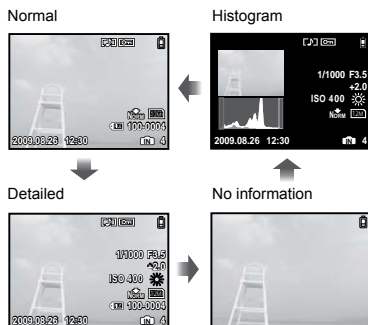

! "Reading a histogram" (p. 25)

Playing back panorama images

Panorama images that were combined together using [COMBINE IN CAMERA 1] or [COMBINE IN CAMERA 2] can be scrolled for viewing.

- ! "Creating panoramic images [PANORAMA]" (p. 34)

1 Select a panorama image during playback.

- ! "Viewing images" (p. 17)

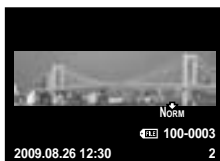



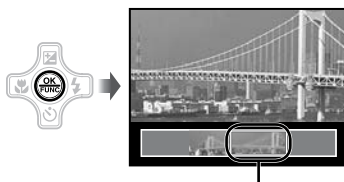

2 Press the button.





Current viewing area

To control panorama image playback

Zoom in/Zoom out: Press the zoom button.



Playback direction: Press     to scroll in the direction of the pressed button.



Pause: Press the  button.

Restart scrolling: Press the  button.

Stop playback: Press the **MENU** button.

Menus for Shooting Functions

When the mode dial is set to a shooting mode position (**FAUTO**  **SCN BEAUTY** ) , settings can be adjusted.

-  indicates positions of the mode dial at which the function can be set.
-  The default settings of the function are highlighted in .

Selecting the appropriate image quality for your application [IMAGE QUALITY]



IMAGE QUALITY

 : **FAUTO**  **SCN BEAUTY** 

Still images

Submenu 1	Submenu 2	Application
IMAGE SIZE	12M (3968×2976)	Suitable for printing pictures over A3 (11×17 in.).
	5M (2560×1920)	Suitable for printing pictures at A4 (8.5×11 in.).
	3M (2048×1536)	Suitable for printing pictures up to A4 (8.5×11 in.).
	2M (1600×1200)	Suitable for printing pictures at A5 (5×7 in.).
	1M (1280×960)	Suitable for printing pictures at postcard size.
	VGA (640×480)	Suitable for viewing pictures on a TV or using pictures on emails and web sites.
	16:9 (1920×1080)	Suitable for playing pictures on wide screen TV.
COMPRESSION	FINE	Shooting at high quality.
	NORMAL	Shooting at normal quality.

Movies

Submenu 1	Submenu 2	Application
IMAGE SIZE	VGA (640×480) / QVGA (320×240)	Select the image quality based on the image size and frame rate. Higher frame rates provide smoother movies.
FRAME RATE	 30 ¹ /s 30fps ¹ /  15 ¹ /s 15fps ¹	

¹ frames per second

-  “Number of storable pictures (still pictures)/continuous recording length (movies) in the internal memory and xD-Picture Card” (p. 67)







Adjusting to a natural color scheme [WB]

 CAMERA MENU ► WB



 :  SCN BEAUTY 

Still images/

Movies (During non-water shooting)

Submenu 2	Application
AUTO	The camera automatically adjusts the white balance according to the shooting scene.
	For shooting outdoors under a clear sky
	For shooting outdoors under a cloudy sky
	For shooting under tungsten lighting
	For shooting under daylight fluorescent lighting (household lighting, etc.)
	For shooting under neutral fluorescent lighting (desk lamps, etc.)
	For shooting under white fluorescent lighting (offices, etc.)

Movies (During underwater shooting)

Submenu 2	Application
  	For shooting underwater.

Selecting the ISO sensitivity [ISO]

 CAMERA MENU ► ISO



- ! Abbreviation for the International Organization for Standardization. ISO standards specify the sensitivity for digital cameras and film, thus codes such as "ISO 100" are used to represent sensitivity.
- ! In the ISO setting, although smaller values result in less sensitivity, sharp images can be taken under fully lit conditions. Larger values result in higher sensitivity, and images can be taken at fast shutter speeds even under dimly lit conditions. However, high sensitivity introduces electrostatic noise into the resulting picture, which may give it a grainy appearance.

Submenu 2	Application
AUTO	The camera automatically adjusts the sensitivity according to the shooting scene.
HIGH ISO AUTO	The camera uses a higher sensitivity compared to [AUTO] to minimize blur caused by a moving subject or by camera shake.
64/100/200/400/ 800/1600	The ISO (sensitivity) setting is fixed by manually selecting it.

Shooting pictures sequentially while the shutter button is held down [DRIVE]

CAMERA MENU ► DRIVE



Submenu 2	Application
	One frame is shot each time the shutter button is pressed.
	Sequential shooting at the focus, brightness (exposure), and white balance that is locked in the first frame.
	Sequential shooting at a higher speed than .

*1 The shooting speed varies depending on the settings for [IMAGE QUALITY] (p. 29).

- ! When set to , (Sound recording) (p. 32) is not available.
- ! When set to , flash is set fixed (FLASH OFF) and [ISO] is fixed to [AUTO].
- ! When set to , [IMAGE SIZE] is limited to or lower. Moreover, [FINE ZOOM] (p. 31), [DIGITAL ZOOM] (p. 31), and (Sound recording) (p. 32) are not available.

Shooting at higher magnifications than optical zoom without reducing the image quality [FINE ZOOM]

CAMERA MENU ► FINE ZOOM



Submenu 2	Application
OFF	Only optical zoom is used to zoom in for shooting.
ON	Optical zoom and image cropping are combined to zoom in for shooting (Approx. 2.1x (max.)).

- ! This function will not reduce the image quality since it does not convert the data with fewer pixels into the data with larger pixels.
- ! When set to [ON], [IMAGE SIZE] is limited to or lower.
- ! This function is not available when [DIGITAL ZOOM] is [ON].
- ! This function is not available when [SUPER MACRO] (p. 23) or [S-MACRO LED] (p. 23) is selected.

Shooting at higher magnifications than optical zoom [DIGITAL ZOOM]

CAMERA MENU ► DIGITAL ZOOM



Submenu 2	Application
OFF	Only optical zoom is used to zoom in for shooting.
ON	Optical zoom and digital zoom are combined to zoom in for shooting (Approx. 1.8x (max.)).

- ! This function is not available when [FINE ZOOM] is [ON].
- ! This function is not available when [SUPER MACRO] (p. 23) or [S-MACRO LED] (p. 23) is selected.

Selecting the range for measuring the brightness [ESP/[]]

CAMERA MENU ► ESP/[]

: SCN

Submenu 2	Application
ESP	Shoots to obtain a balanced brightness over the entire screen. (Meters the brightness at the center and surrounding areas of the screen separately.)
[] (spot)	Shoots the subject at the center during backlighting.

- ⚠ When set to [ESP], the center may appear dark when shooting against strong backlighting.

Selecting the focusing area [AF MODE]

CAMERA MENU ► AF MODE

: SCN

Submenu 2	Application
FACE DETECT ¹	This is used for taking pictures of people. (The camera automatically detects a face and displays a frame on the monitor). Press the shutter button halfway, when the camera focuses on a face the AF target mark lights green. When the AF target mark lights orange, this indicates the camera has focused on something other than a face.
iESP	This enables you to compose the shot without worrying about the focusing position. The camera finds the subject to focus on and automatically adjusts the focus.
SPOT	The camera focuses on the subject within the AF target mark.

¹ For some subjects, the frame may not appear or may take some time to appear.

Recording sound when shooting still images []

CAMERA MENU ►

: SCN

Submenu 2	Application
OFF	No sound is recorded.
ON	The camera automatically starts recording for approx. 4 seconds after taking the picture. This is useful for recording notes or comments about the picture.

- ⚠ When recording, aim the microphone (p. 6) at the source of the sound you want to record.

Reducing the blur caused by the camera shake when shooting [IMAGE STABILIZER] (still images) / [DIS MOVIE MODE] (movies)

CAMERA MENU ► IMAGE STABILIZER / DIS MOVIE MODE

: SCN BEAUTY

Submenu 2	Application
OFF	The image stabilizer is deactivated. This is recommended for shooting when the camera is fixed in place on a tripod or other stable surface.
ON	The image stabilizer is activated.

- ⚠ The camera's default settings are [IMAGE STABILIZER] (still images) to [ON] and [DIS MOVIE MODE] (movies) to [OFF].
- ⚠ While [IMAGE STABILIZER] (still images) is set to [ON], noises may occur from the inside of the camera if the shutter button is pressed.
- ⚠ Images may not be stabilized if camera shake is too severe.
- ⚠ When the shutter speed is extremely slow, such as when taking still shots or taking pictures at night, the stabilizer may not be as effective.
- ⚠ When shooting while the [DIS MOVIE MODE] (movies) is set to [ON], the image will be enlarged somewhat before saving.

Brightening the subject against backlight [SHADOW ADJ]

CAMERA MENU ► SHADOW ADJ

: SCN BEAUTY

Submenu 2	Application
OFF	Shoots without using [SHADOW ADJ].
ON	The camera finds a person's face that has been darkened by backlight and makes it appear brighter for taking the picture. (Point the camera toward the subject. Check the frame that appears around the face detected by the camera, and then press the shutter button to take the picture.)

- For some subjects, the frame may not appear or may take some time to appear.
- When set to [ON], [ESP/] (p. 32) is automatically fixed to [ESP], and [AF MODE] (p. 32) is automatically fixed to [FACE DETECT].

Selecting a scene mode according to the shooting situation [SCENE MODE]

SCENE MODE

: SCN

- In **SCN** mode, the optimum shooting settings are pre-programmed for specific shooting scenes. For this reason, settings may not be changed in some modes.

Submenu 1	Application
PORTRAIT/ LANDSCAPE/ NIGHT SCENE ¹⁾ / NIGHT+PORTRAIT ¹⁾ / SPORT/ INDOOR/ CANDLE ¹⁾ / SELF PORTRAIT/ SUNSET ¹⁾ / FIREWORKS ¹⁾ / CUISINE/ DOCUMENTS/ BEACH & SNOW/ UNDERWATER SNAPSHOT/ 1 UNDERWATER WIDE1/ 2 UNDERWATER WIDE2/ UNDERWATER MACRO/ PRE-CAPTURE MOVIE/ SNOW	The camera takes a picture in the mode for the shooting scene.

- ¹⁾ When the subject is dark, noise reduction is automatically activated. This approximately doubles the shooting time, during which no other pictures can be taken.

To shoot with the selected mode

“Using the best mode for the shooting scene (**SCN** mode)” (p. 19)

Capturing the perfect moment when shooting ([PRE-CAPTURE MOVIE] mode)

- Use to select [PRE-CAPTURE MOVIE], and then press the button to set.
 - This function is ready for shooting immediately after setting this option.
- Press the shutter button to start movie shooting.
 - A 7-second movie, including 2-second movie immediately before pressing the shutter button, is taken.
 - The optical zoom and auto focus function are available during movie recording.

- Sound is not recorded.
- AF target mark does not appear on the monitor.
- Select [IMAGE SIZE] from [VGA] or [QVGA], and select [FRAME RATE] from 30fps or 15fps.

Tapping the camera to shoot a picture ([SNOW] mode)

- Select [SNOW], and then press the button.
 - [TAP CONTROL] (p. 49) automatically becomes active and the camera can be operated by tapping.
- Tap the back of the camera body twice.
 - [SELFTIMER] becomes active and the picture is automatically taken after 2 seconds.

Creating panoramic images

PANORAMA]

PANORAMA



Submenu 1	Application
COMBINE IN CAMERA 1 ^{1 12}	Three frames are taken and combined by the camera. The user only composes the shots so that the target marks and pointers overlap, and the camera automatically releases the shutter. The shooting functions are already preset to the optimum settings for panoramic shooting.
COMBINE IN CAMERA 2 ^{1 12}	Three frames are taken and combined by the camera. The user composes the shots using the guide frame and manually releases the shutter.
COMBINE IN PC	The frames that were taken are combined into a panorama image using the OLYMPUS Master 2 software from the provided CD-ROM. Pictures are taken in the last [ISO] or [SCENE MODE] settings (except for some scene modes).

¹ Not available in **SCN** mode (p. 19).

² The [IMAGE QUALITY] (p. 29) setting cannot be changed.

- The focus, exposure (p. 23), zoom position (p. 22), and [WB] (p. 30) are locked at the first frame.
- The flash (p. 22) is fixed to (FLASH OFF) mode.
- Panorama images can be edited using [SHADOW ADJ] (p. 33), [COLOR EDIT] (p. 38) only.
- "Playing back panorama images" (p. 28)

Taking pictures with [COMBINE IN CAMERA 1]

- 1 Press the shutter button to take the first frame.
- 2 Move the camera slightly in the direction of the second frame.



Screen when combining images from left to right

- 3 Move the camera slowly while keeping it straight, and stop the camera where the pointer and target mark overlap.

- The camera releases the shutter automatically.



- ! To combine only two pictures, press the button before taking the third frame.
- 4 Take the third frame in the same way as Step 3.

- After the third frame is taken, the camera automatically processes the frames and the combined panorama image is displayed.

- ! To cancel making panoramic picture during shooting, press the **MENU** button.

- ! When the shutter does not automatically release, try [COMBINE IN CAMERA 2] or [COMBINE IN PC].

Taking pictures with [COMBINE IN CAMERA 2]

- 1 Use to select the direction that the frames are combined.



- 2 Press the shutter button to take the first frame.

- A guide frame appears as a reference.

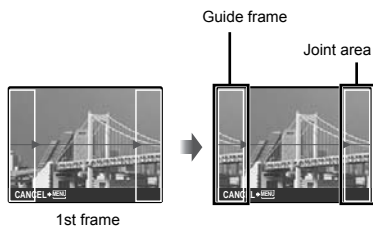



- 3 Compose the second shot so that the joint area overlaps the guide frame.



Composition of the 2nd frame

- ④ Press the shutter button to take the second frame.
- ! To combine only two pictures, press the  button before taking the third frame.
- ⑤ Take the third frame in the same way as Steps ③ to ④.
 - After the third frame is taken, the camera automatically processes the frames and the combined panorama image is displayed.
- ! To cancel making panoramic picture during shooting, press the **MENU** button.

Taking pictures with [COMBINE IN PC]

- ① Use  to select the direction that the frames are combined.
- ② Press the shutter button to take the first frame, and then compose the second shot.
 - Compose the shot using the guide frame so that the two adjacent frames overlap.
- ③ Repeat Step ② until the number of required frames are taken, and then press the  button when finished.
- ! When the  mark is displayed, you cannot continue shooting any further. Panorama shooting is possible for up to 10 frames.
- ! Refer to the OLYMPUS Master 2 help guide for details on how to make panorama images.

Selecting movie shooting mode [MOVIE]

 MOVIE



Submenu 1	Application
NON-WATER MOVIE	The optical zoom is not available during movie recording but the sound can be recorded.
UNDERWATER MOVIE	The optical zoom is available during movie recording but the sound cannot be recorded.

- ! First the [MOVIE] setting screen appears when you set the mode dial to  during underwater shooting (i.e., while the underwater sensor is responding).

Restoring the shooting functions to the default settings [RESET]

 RESET

 : **FAUTO**  **SCN** **BEAUTY** 

Submenu 1	Application
YES	Restores the following menu functions to the default settings. <ul style="list-style-type: none"> • Flash (p. 22) • Exposure compensation (p. 23) • Macro (p. 23) • Self-timer (p. 24) • [IMAGE QUALITY] (p. 29) • Menu functions in [CAMERA MENU] (p. 30 to 33)
NO	The current settings are not changed.

Menus for Playback, Editing, and Printing Functions

The default settings of the function are highlighted in .

When the mode dial is set to the position, settings can be adjusted.

Playing back automatically [SLIDESHOW]

SLIDESHOW

Submenu 1	Submenu 2	Submenu 3	Application
ALL/ STILL PICTURE/ MOVIE/CALENDAR	NORMAL ¹ / FADER ¹ /SLIDE ¹ / ZOOM ¹ /date ²	OFF/1/2	Selects the range of images for the slideshow, the type of transition effect ([TYPE]) used between images, and the background music ([BGM]).

¹ Only when [STILL PICTURE] is selected in Submenu 1.

² Only when [CALENDAR] is selected in Submenu 1.

To start a slideshow

After pressing the button to make the [BGM] settings, the slideshow starts. To stop the slideshow, press the button or the **MENU** button.

[BGM] is not available when [SILENT MODE] (p. 50) is set to [ON].

Retouching images [PERFECT FIX]

PERFECT FIX

Depending on the picture, the editing may not be effective.

The retouching process may lower the image resolution.

Submenu 1	Application
ALL	[SHADOW ADJ] and [REDEYE FIX] are applied together.
SHADOW ADJ	Only sections darkened by backlighting and dim lighting are brightened.
REDEYE FIX	Eyes that are reddened by the flash are corrected.

① Use to select a correction method and press the button.

② Use to select an image for retouching, and press the button.

- The retouched image is saved as a separate image.

Retouching the skin and eyes [BEAUTY FIX]

BEAUTY FIX

Depending on the picture, the editing may not be effective.

Submenu 1	Submenu 2	Application
ALL	—	[CLEAR SKIN], [SPARKLE EYE] and [DRAMATIC EYE] are applied together.
CLEAR SKIN	SOFT/AVG/ HARD	Makes skin look smooth and translucent. Select the desired effect from among 3 levels.
SPARKLE EYE	—	Enhances the contrast of the eyes.
DRAMATIC EYE	—	Enlarges the subject's eyes.

① Use to select a correction method, and press the button.

② Use to select an image for retouching, and press the button.

- The retouched image is saved as a separate image.

When [CLEAR SKIN] is selected

Use to select the retouching level, and press the button.



Changing the image size []

EDIT ►

Submenu 2	Application
VGA 640 × 480	This saves a high-resolution image as a separate image with a smaller size for use in e-mail attachments and other applications.
VGA 320 × 240	

- 1 Use to select an image.
- 2 Use to select an image size and press the button.

- The image with the selected size is saved as a separate image.

Cropping a picture []

EDIT ►

- 1 Use to select an image, and press the button.
- 2 Use the zoom button to select the size of the cropping frame, and use to move the frame.



- 3 Press the button.
- The edited image is saved as a separate image.

Changing the color tone of image [COLOR EDIT]

EDIT ► COLOR EDIT

Submenu 2	Application
Black & white	This changes the image to black and white.
Sepia	This changes the image to a sepia tone.
Saturation (hard)	This increases the color saturation of the image.
Saturation (soft)	This slightly increases the color saturation of the image.

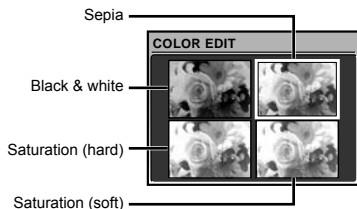

- 1 Use to select an image, and press the button.
 - 2 Use to select the desired color, and press the button.
- The image with the selected color is saved as a separate image.

Adding a calendar to an image [CALENDAR]

EDIT ► CALENDAR

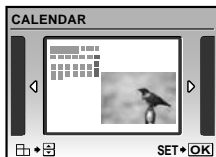

- 1 Use to select an image, and then press the button.
 - 2 Use to select a calendar, and use to select the image orientation, and press the button.
 - 3 Use to select the Year of the calendar, and then press .
 - 4 Use to select the Month of the calendar, and then press the button.
- The edited image is saved as a separate image.

Creating an index of 9 frames from a movie [INDEX]

EDIT ► INDEX

- 1 Use to select a movie, and press the button.



- This function extracts 9 frames from a movie and saves them as a new picture (INDEX) containing thumbnails of each frame.

Protecting images [On]

PLAYBACK MENU ► On

- ! Protected images cannot be erased by [ERASE] (p. 18), [SEL. IMAGE], or [ALL ERASE] (p. 40), but all images are erased by [MEMORY FORMAT]/[FORMAT] (p. 42).

Submenu 2	Application
OFF	Images can be erased.
ON	Images are protected so that they cannot be erased except by formatting of the internal memory/card.

- 1 Use to select an image.
- 2 Use to select [ON].
- 3 If necessary, repeat Steps 1 and 2 to protect other images, and press the button.

Rotating images [🔄]

▶ PLAYBACK MENU ▶ 📷

Submenu 2	Application
🔄 +90°	The image is rotated 90° clockwise.
■ 0°	The image is not rotated.
🔄 -90°	The image is rotated 90° counter-clockwise.

- 1 Use [📷] to select an image.
 - 2 Use [🔄] to select the rotation direction.
 - 3 If necessary, repeat Steps 1 and 2 to adjust settings for other images, and press the [OK] button.
- ! The new picture orientation will be saved even after the power is turned off.

Adding sound to still images [🎤]

▶ PLAYBACK MENU ▶ 🎤

Submenu 2	Application
YES	The camera adds (records) sound for approx. 4 seconds while playing back the image. This is useful for recording notes or comments about the image.
NO	No sound is recorded.

- 1 Use [📷] to select an image.
- 2 Aim the microphone towards the sound source.

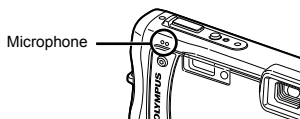

- 3 Use [🎤] to select [YES], and press the [OK] button.
- Recording starts.

Erasing images [🗑️ ERASE]

🗑️ ERASE

- ! Check each picture before erasing to avoid erasing any important pictures you may want to keep.

Submenu 1	Application
SEL. IMAGE	Images are individually selected and erased.
ALL ERASE	All images in the internal memory or card are erased.

- ! When erasing pictures in the internal memory, do not insert the card into the camera.
- ! When erasing pictures from the card, insert a card into the camera in advance.

To individually select and erase images [SEL. IMAGE]

- 1 Use [📷] to select [SEL. IMAGE], and press the [OK] button.
- 2 Use [📷] to select the image to be erased, and press the [OK] button to add a ✓ mark to the image.



- 3 Repeat Step 2 to select the images to be erased, and then press the [🗑️] button to erase the selected images.
 - 4 Use [📷] to select [YES], and press the [OK] button.
- The images with a ✓ mark are erased.

To erase all images [ALL ERASE]

- 1 Use [📷] to select [ALL ERASE], and press the [OK] button.
- 2 Use [📷] to select [YES], and press the [OK] button.



Saving print settings to the image data

[🖨️] PRINT ORDER

🖨️ PRINT ORDER



- ❗ “Print Reservations (DPOF)” (p. 54)
- ❗ Print reservation can only be set for still images that are recorded to the card.

Menus for Other Camera Settings

 The default settings of the function are highlighted in .

Erasing data completely [MEMORY FORMAT]/[FORMAT]

 SETUP ► MEMORY FORMAT/FORMAT

-  Before formatting, check that no important data is left in the internal memory or card.
-  Non-Olympus cards and cards that have been formatted by a computer must be formatted with this camera before use.

Submenu 2	Application
YES	Completely erases the image data in the internal memory ^{*1} or card (including protected images).
NO	Cancels formatting.

^{*1} Be sure to remove the card before formatting the internal memory.

Copying images in the internal memory to the card [BACKUP]

 SETUP ► BACKUP

Submenu 2	Application
YES	Backs up image data in the internal memory to the card.
NO	Cancels the backup.

-  It takes some time to back up data. Check that the battery has sufficient power before starting the backup, or use a separately sold AC adapter.
“Using a separately sold AC adapter” (p. 65)

Changing the display language

 SETUP ► 

-  “Changing the display language” (p. 14)

Submenu 2	Application
Languages ^{*1}	The language for the menus and error messages displayed on the monitor is selected.

^{*1} The available languages vary depending on the country and/or region where the camera was purchased.

Setting the startup display screen and sound when the camera is turned on [PW ON SETUP]

SETUP ► PW ON SETUP



Submenu 2	Submenu 3	Application
SCREEN	OFF	No image is displayed.
	1	A preset image ¹ is displayed.
	2	A still image stored in the internal memory or card is registered for display. (This option leads to the setup screen.)
VOLUME ^{2 3}	OFF (No sound)/ LOW/HIGH	The volume of the startup sound is selected.

¹ This image cannot be changed.

² When [SCREEN] is set to [OFF], this setting is not available.

³ When [SILENT MODE] (p. 50) is set to [ON], this setting is not available.

To register a startup image

- 1 Select [2] in Submenu 3 for [SCREEN], and press the  button.
- 2 Use  to select the image to be registered, and press the  button.

Selecting the menu screen color and background [MENU COLOR]

SETUP ► MENU COLOR

Submenu 2	Application
NORMAL/COLOR 1/ COLOR 2/COLOR 3	Selects the menu screen color or background image according to your preference.

Selecting the camera sound and its volume [SOUND SETTINGS]

🔊 SETUP ▶ SOUND SETTINGS

Submenu 2	Submenu 3	Submenu 4	Application
BEEP	SOUND TYPE	1/2	Selects the operating sound and volume of the camera buttons (except the shutter button).
	VOLUME	OFF (No sound)/ LOW/HIGH	
SHUTTER SOUND	SOUND TYPE	1/2/3	Selects the type and volume of the shutter sound.
	VOLUME	OFF (No sound)/ LOW/HIGH	
🔊	OFF (No sound)/ LOW/HIGH	—	Adjusts the warning sound volume.
▶ VOLUME	OFF (No sound)/ LOW/HIGH	—	Adjusts the image playback volume.

🔇 To turn off all sounds at once, adjust the setting from [🔇 SILENT MODE] (p. 50).

Viewing the image immediately after shooting [REC VIEW]

📺 SETUP ▶ REC VIEW

Submenu 2	Application
OFF	The image being recorded is not displayed. This allows the user to prepare for the next shot while following the subject in the monitor after shooting.
ON	The image being recorded is displayed. This allows the user to briefly check the image that was just taken.

🔇 Even when set to [ON], you can resume shooting while the image is being displayed.

Resetting the file name numbers of pictures [FILE NAME]

SETUP ► FILE NAME

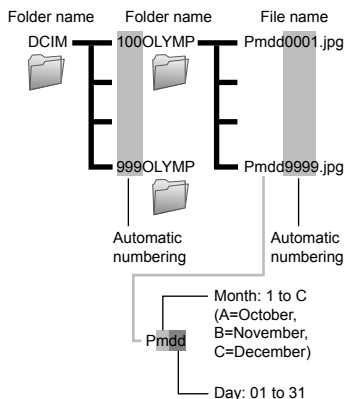

Submenu 2	Application
RESET	This resets the sequential number for the folder name and file name whenever a new card is inserted. ¹ This is useful when grouping images on separate cards.
AUTO	Even when a new card is inserted, this continues the numbering for the folder name and file name from the previous card. This is useful for managing all image folder names and files names with sequential numbers.

¹ The number for the folder name is reset to 100, and the one for the file name is reset to 0001.

Adjusting the CCD and adjusting the image processing function [PIXEL MAPPING]

SETUP ► PIXEL MAPPING

- ! This function has already been adjusted at factory shipping, and no adjustment is needed right after purchase. Approximately once a year is recommended.
- ! For best results, wait at least one minute after taking or viewing pictures before performing pixel mapping. If the camera is turned off during pixel mapping, be sure to perform it again.

To adjust the CCD and the image processing function

Press the button when [START] (Submenu 2) is displayed.

- The camera checks and adjusts the CCD and the image processing function at the same time.

Adjusting the brightness of the monitor [!☺]

SETUP ▶

To adjust the monitor brightness

- Use to adjust the brightness while viewing the screen, and then press the button.



Setting the date and time [☺]

SETUP ▶

- “Setting the date and time” (p. 14)

To select the date and time display order

- Press after setting “Minute”, and use to select the date display order.

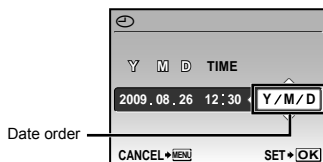

Setting the date and time for another time zone [DUALTIME]

SETUP ▶ DUALTIME

- By setting [DUALTIME] to [ON] and setting the date and time, the set date and time is reflected in the image file names, date prints and so on.

Submenu 2	Submenu 3	Application
OFF	—	Switches to the date and time set in [☺] (Date/time).
ON	(Proceeds to the setting screen ^{*1} .)	Switches to the date and time that were set in [DUALTIME] when using the camera in another time zone.

^{*1} The setting procedure is identical to that in “Setting the date and time” (p. 14).

- The date display order is the same as that set with [☺].

Selecting the video signal system to match your TV [VIDEO OUT]

SETUP ► VIDEO OUT

- ⚠ The TV video signal system varies depending on the countries and regions. Before viewing camera images on your TV, select the video output according to your TV's video signal type.





Submenu 2	Application
NTSC	Connecting the camera to a TV in North America, Taiwan, Korea, Japan, and so on
PAL	Connecting the camera to a TV in European countries, China, and so on

- ⚠ The factory default settings differ according to the region where the camera is sold.

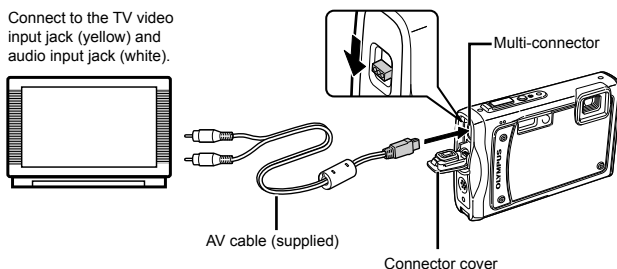
To play back camera images on a TV

- 1 Connect the TV and camera.



- 2 Use the camera to select the same video signal system as the one of connected TV ([NTSC]/[PAL]).
- 3 Turn on the TV, and change "INPUT" to "VIDEO (an input jack connected to the camera)."
- ⚠ For details on changing the input source of the TV, refer to the TV's instruction manual.
- 4 Set the mode dial to , and use    to select the image for playback.
- ⚠ Depending on the TV's settings, the displayed images and information may become cropped.

Saving battery power between shots [POWER SAVE]

SETUP ► POWER SAVE

Submenu 2	Application
OFF	Cancels [POWER SAVE].
ON	When the camera is not being used for approx. 10 seconds, the monitor automatically turns off to save battery power.

To resume standby mode

Press any button or turn the mode dial.

Using the LED illuminator as an auxiliary light [LED ILLUMINATOR]

SETUP ► LED ILLUMINATOR

Submenu 2	Application
OFF	Disables the LED illuminator.
ON	Enables the LED illuminator.

! "Using the LED illuminator" (p. 24)

Displaying the current altitude/ water depth (atmospheric/hydraulic pressure) [MANOMETER]



SETUP ► MANOMETER

- ! The readings may have a margin of error depending on meteorological conditions. Use the readings only for your reference.

Submenu 2	Application
OFF	Cancels the manometer display.
ON	Displays the current altitude/water depth (atmospheric/hydraulic pressure) in the shooting standby mode screen. (-10 m to 5,000 m)
CALIBRATE	Proceed to the setting screen. See below.

- ! When set to [ON], a warning message appears in the monitor as a water depth close to 10 m (32.8 ft) is reached.

To adjust the altitude/water depth display

- ① Use   to select the current altitude/water depth, and press the  button to set.

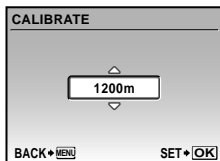

Selecting the display units for the manometer [m/ft]

SETUP ► m/ft

Submenu 2	Application
m	This displays in meters.
ft	This displays in feet.

Operating the camera by tapping the body [TAP CONTROL]

SETUP ► TAP CONTROL

Submenu 2	Application
OFF	Cancels [TAP CONTROL].
ON	[TAP CONTROL] is activated.
CALIBRATE	Adjusts the tap strength and intervals between multiple taps on each side of the camera body. (top, left, right, & back)

Functions available when [TAP CONTROL] is set to [ON]

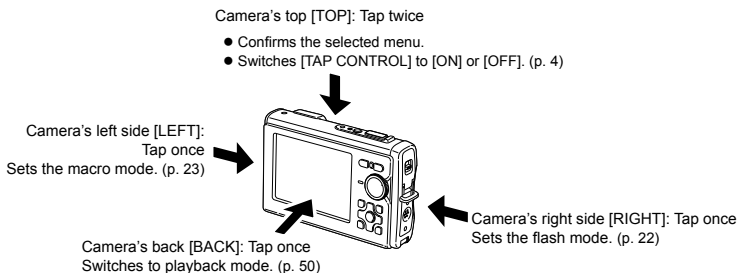

Operating during shooting mode (Example: Flash mode)

- 1 Tap the right side of the camera body once.
 - The flash mode selection screen is displayed.
 - 2 Tap the right or left side of the camera body to select a function.
 - 3 Tap the top of the camera body twice to confirm your selection.
- ! Tap the camera firmly using the pad of your finger.
- ! When the camera is stabilized on a tripod for example, tap control may not work properly.
- ! To prevent dropping the camera when using tap control, strap the camera to your wrist.

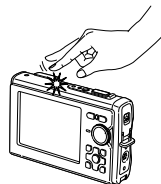

Operating during playback mode

When switched to playback mode by tapping the back of the camera body once, the operations below can be used.

Display next image: Tap the right side of the camera once.

Display previous image: Tap the left side of the camera once.

Start slideshow: Tap the top surface of the camera twice. (The slideshow will automatically start for all images stored in internal memory or on the card, with [BGM] set to [OFF].)

Display next image during a slideshow: Tilt the camera right or tap the right side of the camera once.

Display previous image during a slideshow: Tap the left side of the camera once.

Stop slideshow: Tap the top surface of the camera twice.

Return to the shooting mode: Tap the back side of the camera once.

When tapping the camera's top

To adjust the tap control

- 1 Select [CALIBRATE] in Submenu 2 and press the button.
 - 2 Select the part to adjust with and and press the button.
 - 3 Select the [STR] setting with and and press the button.
 - 4 Select the [INTVL] setting with and and press the button.
- ! Check the operation of the camera by tapping on the camera after making the settings.

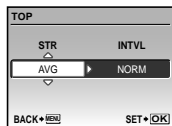

Turning off the camera sounds [SILENT MODE]

SILENT MODE

Submenu 1	Application
OFF	Activates the [SOUND SETTINGS] setting.
ON	The electronic sounds (operating sound, shutter sound, warning sound) and playback sounds are muted.

- ! [SOUND SETTINGS] (p. 44)

Printing

Direct printing (PictBridge^{*1})

By connecting the camera to a PictBridge-compatible printer, you can print images directly without using a computer.

To find out if your printer supports PictBridge, refer to the printer's instruction manual.

^{*1} PictBridge is a standard for connecting digital cameras and printers of different makers and printing out pictures directly.

- ⚠ The printing modes, paper sizes, and other parameters that can be set with the camera vary depending on the printer that is used. For details, refer to the printer's instruction manual.
- ⚠ For details on the available paper types, loading paper, and installing ink cassettes, refer to the printer's instruction manual.

Printing images at the printer's standard settings [EASY PRINT]

1 Display the image to be printed on the monitor.

- ⚠ "Viewing images" (p. 17)
- ⚠ Printing can also be started when the camera is turned off. After performing Step 2, use to select [EASY PRINT], press the button. Use to select an image, and press the button.

2 Turn on the printer, and then connect the printer and camera.

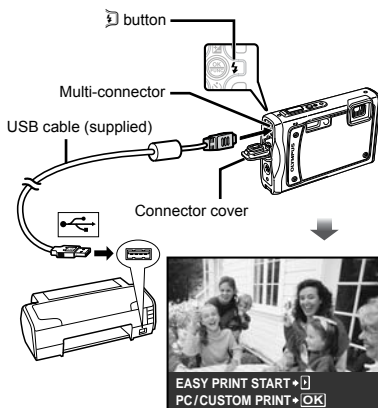

3 Press to start printing.

4 To print another image, use to select an image, and press the button.

To exit printing

After a selected image is displayed on the screen, disconnect the USB cable from the camera and printer.



Changing the printer's settings for printing [CUSTOM PRINT]

- 1 Follow Steps 1 and 2 for [EASY PRINT] (p. 51), then press the  button.

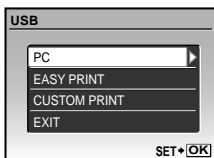



- 2 Use  to select [CUSTOM PRINT], and press the  button.

- 3 Use  to select the print mode, and press the  button.



Submenu 2	Application
PRINT	This prints the image selected in Step 6.
ALL PRINT	This prints all images stored in the internal memory or card.
MULTI PRINT	This prints one image in a multiple layout format.
ALL INDEX	This prints an index of all images stored in the internal memory or card.
PRINT ORDER ¹	This prints images based on the print reservation data on the card.

¹ [PRINT ORDER] is available only when print reservations have been made. "Print Reservations (DPOF)" (p. 54)

- 4 Use  to select [SIZE] (Submenu 3), and press .

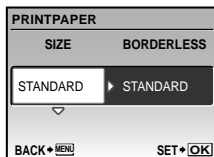
-  If the [PRINTPAPER] screen is not displayed, the [SIZE], [BORDERLESS], and [PICS/SHEET] are set to the printer's standard.



- 5 Use  to select the [BORDERLESS] or [PICS/SHEET] settings, and press the  button.

Submenu 4	Application
OFF/ON ¹	The image is printed with a border around it ([OFF]). The image is printed to fill the entire paper ([ON]).
(The number of images per sheet varies depending on the printer.)	The number of images per sheet ([PICS/SHEET]) is selectable only when [MULTI PRINT] is selected in Step 3.

¹ The available settings for [BORDERLESS] vary depending on the printer.

-  If [STANDARD] is selected in Steps 4 and 5, the image is printed at the printer's standard settings.



6 Use to select an image.

7 Press to make a [SINGLE PRINT] reservation for the current image. Press if you wish to adjust detailed printer settings for the current image.

To adjust detailed printer settings

- 1 Use to adjust the detailed printer settings, and press the button.

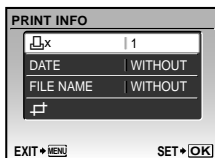

Submenu 5	Submenu 6	Application
	0 to 10	This selects the number of prints.
DATE	WITH/ WITHOUT	Selecting [WITH] prints the images with the date. Selecting [WITHOUT] prints the images without the date.
FILE NAME	WITH/ WITHOUT	Selecting [WITH] prints the file name on the image. Selecting [WITHOUT] does not print any file name on the image.
	(Proceeds to the setting screen.)	This selects a portion of the image for printing.

To crop an image []

- 1 Use the zoom button to select the size of the cropping frame, use to move the frame, and then press the button.



- 2 Use to select [OK], and press the button.



8 If necessary, repeat Steps 6 and 7 to select the image to be printed, make the detailed settings, and set [SINGLEPRINT].

9 Press the button.

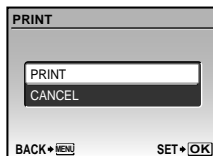

10 Use to select [PRINT], and press the button.

- Printing starts.
- When [OPTION SET] is selected in [ALL PRINT] mode, [PRINT INFO] screen is displayed.
- When printing is finished, the [PRINT MODE SELECT] screen is displayed.

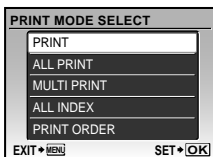

To cancel printing

- 1 Press the while [TRANSFERRING] is displayed.
- 2 Use to select [CANCEL], then press the button.

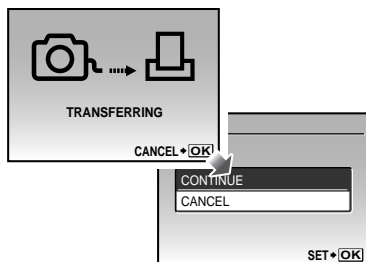

11 Press the MENU button.

12 When the message [REMOVE USB CABLE] is displayed, disconnect the USB cable from the camera and printer.

Print Reservations (DPOF^{*1})

In print reservations, the number of prints and date imprint option are saved in the image on the card. This enables easy printing at a printer or print shop supporting DPOF by using only the print reservations on the card without a computer or a camera.

*1 DPOF is a standard for storing automatic printout information from digital cameras.

- ! Print reservations can be set only for the images stored on the card. Insert a card with recorded images before making print reservations.
- ! DPOF reservations set by another DPOF device cannot be changed by this camera. Make changes using the original device. Making new DPOF reservations with this camera will erase the reservations made by the other device.
- ! DPOF print reservations can be made for up to 999 images per card.

Single-frame print reservations

- 1 Set the mode dial to , and then press the MENU button to display the top menu.
- 2 Use to select [PRINT ORDER], and press the button.

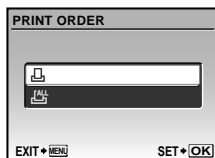

- 3 Use to select [1], and press the button.



- 4 Use to select the image for print reservation. Use to select the quantity. Press the button.



- 5 Use to select the [☺] (date print) screen option, and press the button.

Submenu 2	Application
NO	This prints the image only.
DATE	This prints the image with the shooting date.
TIME	This prints the image with the shooting time.



- 6 Use to select [SET], and press the button.

Reserving one print each of all images on the card [1]

- 1 Follow Steps 1 and 2 in [1] (p. 54).
- 2 Use to select [1], and press the button.
- 3 Follow Steps 5 to 6 in [1].

Resetting all print reservation data

- 1 Set the mode dial to , and then press the MENU button to display the top menu.
- 2 Use to select [PRINT ORDER], and press the button.
- 3 Select either [1] or [1], and press the button.

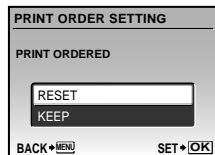

- 4 Use to select [RESET], and press the button.

Resetting the print reservation data for selected images

- 1 Follow Steps 1 and 2 of “Resetting all print reservation data” (p. 55).

- 2 Use to select , and press the button.

- 3 Use to select [KEEP] and press the button.

- 4 Use to select the image with the print reservation you want to cancel. Use to set the print quantity to “0”.

- 5 If necessary, repeat Step 4, and then press the button when finished.

- 6 Use to select the (date print) screen option, and press the button.
 - The settings are applied to the remaining images with the print reservation data.

- 7 Use to select [SET], and press the button.

Using OLYMPUS Master 2

System requirements and installation of OLYMPUS Master 2

Install the OLYMPUS Master 2 software by referring to the included installation guide.

Connecting the camera to a computer

1 Make sure the camera is turned off.

- The monitor is off.

2 Connect the camera to a computer.

- The camera automatically turns on.

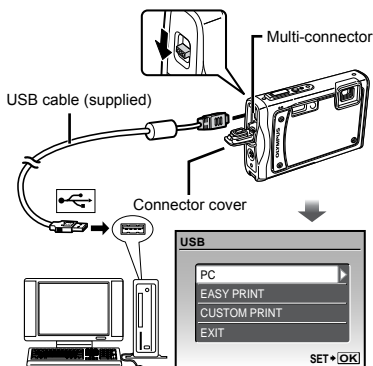

- ! You can charge the battery by selecting [EXIT] and pressing the button.
- ! The [USB] screen above does not appear and charging may automatically start in cases where there is an insufficient charge or the camera is connected to a computer via a USB hub.
- ! Locate the position of the USB port by referring to your computer's instructions manual.

3 Use to select [PC], and press the button.

- The computer automatically detects the camera as a new device on the first connection.

Windows

After the computer detects the camera, a message indicating the completion of the setting appears. Confirm the message and click "OK". The camera is recognized as a removable disk.

Macintosh

When iPhoto started, exit iPhoto and start OLYMPUS Master 2.

- ! While the camera is connected to the computer, shooting functions are disabled.
- ! Connecting the camera to a computer via a USB hub may cause unstable operation.
- ! When [MTP] is set for the submenu that appears by pressing after selecting [PC] in Step 3, images cannot be transferred to a computer using OLYMPUS Master 2.

Starting OLYMPUS Master 2

1 Double-click the OLYMPUS Master 2 icon.

Windows

- appears on the desktop.

Macintosh

- appears in the OLYMPUS Master 2 folder.
- Browse window appears after starting the software.
- ! When you start OLYMPUS Master 2 for the first time after installation, "Default Settings" and "Registration" screens appear. Follow the instructions on the screen.

Operating OLYMPUS Master 2

When OLYMPUS Master 2 is started, Quick Start Guide appears on the screen that helps you to handle the camera without any question. When the Quick Start Guide is not displayed, click  in the toolbar to show the Guide.



For details on the operation, refer to the help guide of the software.



Transferring and saving images without using OLYMPUS Master 2

This camera is compatible with the USB Mass Storage Class. You can transfer and save the image data on your computer while the camera and the computer are connected.

System requirements

Windows : Windows 2000 Professional/
XP Home Edition/
XP Professional/Vista

Macintosh : Mac OS X v10.3 or later

-  On a computer running Windows Vista, if [MTP] is set for the submenu that appears by pressing  after selecting [PC] in Step 3 of "Connecting the camera to a computer" (p. 57), Windows Photo Gallery will become available.
-  Even if a computer has USB ports, proper operation is not guaranteed in the following cases.
 - Computers with USB ports installed using an expansion card, etc.
 - Computers without a factory-installed OS and home-built computers

Usage Tips

If the camera does not work as intended, or if an error message is displayed on the screen, and you are unsure of what to do, refer to the information below to fix the problem(s).

Troubleshooting

Battery

“The camera does not work even when battery is installed”

- Insert recharged battery in the correct direction.
“Charging the battery” (p. 11), “Loading the battery and the xD-Picture Card™ (sold separately) into the camera” (p. 10)
- Battery performance may have been reduced temporarily due to low temperature. Take the battery out of the camera, and warm it by putting it in your pocket for a while.

Card/Internal memory

“An error message is displayed”



“Error message” (p. 10)

Shutter button

“No picture is taken when the shutter button is pressed”

- Cancel sleep mode.

To save battery power, the camera automatically goes into sleep mode and the monitor turns off if there is no operation after 3 minutes when the camera is turned on. No picture is taken even if the shutter button is fully pressed in this mode. Operate the zoom button or other buttons to restore the camera from sleep mode before taking a picture. If the camera is left for 15 minutes, it automatically turns off. Press the **ON/OFF** button to turn on the camera.

- Set the mode dial to a position other than .
- Wait until  (flash charge) stops blinking before taking pictures.

Monitor

“Difficult to see”

- Condensation^{*1} may have formed. Turn off the power and wait for the camera body to become acclimated to the surrounding temperature and dry out before taking pictures.

^{*1} Dew drops can form in the camera when it is suddenly taken from a cold location into a warm, humid room.

“Vertical lines appear on the screen”

- Vertical lines may appear on the screen at times such as when the camera is pointed at an extremely bright subject under a clear sky. The lines do not appear, however, in the final image.

“The light is caught in the picture”

- Shooting with flash in dark situations results in an image with many flash reflections on dust in the air.

Date and time function

“Date and time settings return to the default setting”

- If the battery is removed and left out of the camera for about 1 day^{*2}, the date and time settings return to the default setting and must be reset.

^{*2} The time until the date and time settings return to the default setting varies depending on how long the battery have been loaded.

“Setting the date and time” (p. 14)

Others





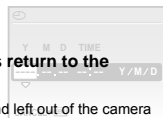
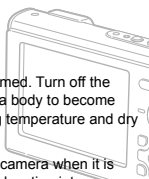
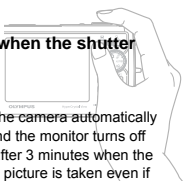
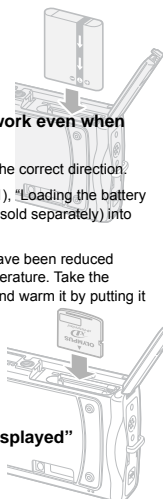









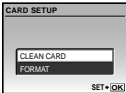







“Noises occur from the inside of the camera in shooting standby mode”

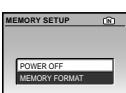







- Auto focusing operation may cause lens movement noises even if you do not make any camera operation.



Error message

- When one of the messages below is displayed on the monitor, check the corrective action.

Error message	Corrective action
 CARD ERROR	Card problem Insert a new card.
 WRITE PROTECT	Card problem Use a computer to cancel the read-only setting.
 MEMORY FULL	Internal memory problem <ul style="list-style-type: none"> Insert a card. Erase unwanted images.^{*1}
 CARD FULL	Card problem <ul style="list-style-type: none"> Replace the card. Erase unwanted images.^{*1}
	Card problem <ul style="list-style-type: none"> Use   to select [CLEAN CARD], and press the  button. Take out the card, wipe the contact area (p. 66) with a soft, dry cloth, and then load the card again. Use   to select [FORMAT], and press the  button. Next, use   to select [YES], and press the  button.^{*2}
	Internal memory problem Use   to select [MEMORY FORMAT], and press the  button. Next, use   to select [YES], and press the  button. ^{*2}
 NO PICTURE	Internal memory/Card problem Take pictures before viewing them.
 PICTURE ERROR	Problem with selected image Use photo retouch software, etc. to view the image on a computer. If the image still cannot be viewed, the image file is corrupted.

Error message	Corrective action
 THE IMAGE CANNOT BE EDITED	Problem with selected image Use photo retouch software, etc. to edit the image on a computer.
 CARD-COVER OPEN	Operation problem Close the battery/card compartment cover.
 BATTERY EMPTY	Battery problem Charge the battery.
 NO CONNECTION	Connection problem Connect the camera and computer or printer correctly.
 NO PAPER	Printer problem Load paper into the printer.
 NO INK	Printer problem Refill the ink in the printer.
 JAMMED	Printer problem Remove the jammed paper.
SETTINGS CHANGED ^{*3}	Printer problem Return to the status where the printer can be used.
 PRINT ERROR	Printer problem Turn off the camera and printer, check the printer for any problems, and then turn the power on again.
 CANNOT PRINT ^{*4}	Problem with selected image Use a computer to print.

^{*1} Before erasing important images, download them to a computer.

^{*2} All data will be erased.

^{*3} This is displayed, for instance, when the printer's paper tray has been removed. Do not operate the printer while making the print settings on the camera.

^{*4} This camera may be unable to print images taken by other cameras.

Shooting tips

When you are unsure of how to take a picture that you envision, refer to the information below.

Focusing



“Focusing on the subject”

- **Taking a picture of a subject not in the center of the screen**

After focusing on an object at the same distance as the subject, compose the shot, and take the picture.

Pressing the shutter button halfway (p. 16)

AF lock (p. 19)

- **Set [AF MODE] (p. 32) to [IESP]**
- **Taking a picture of subjects where autofocus is difficult**

In the following cases, after focusing on an object (by pressing the shutter button halfway down) with high contrast at the same distance as the subject, compose the shot, and take the picture.

Subjects with low contrast



When extremely bright objects appear in the center of the screen



Object with no vertical lines¹

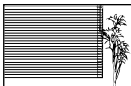

¹ It is also effective to compose the shot by holding the camera vertically to focus, and then returning to the horizontal position to take the picture.

When objects are at different distances



Fast-moving object

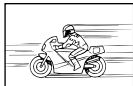

The subject is not in the center of the frame



Camera shake



“Taking pictures (or movies) without camera shake”

- **Taking pictures using [IMAGE STABILIZER] (p. 32)**

When a picture is taken of a shadowy subject, the CCD¹ shifts to correct for camera shake even if the ISO speed is not increased. This function is also effective when taking pictures at a high zoom magnification.

¹ A device that takes light received through the lens and converts it into electric signals.

- **Shooting movies using [DIS MOVIE MODE] (p. 32)**

- **Taking picture with [SPORT] (p. 33)**

Since you can take pictures with a high shutter speed by setting [SPORT], it's also effective for blurry subjects.

- **Taking pictures at a high ISO sensitivity**

If a high ISO sensitivity is selected, pictures can be taken at a high shutter speed even at locations where a flash cannot be used.

[ISO] (p. 30)

Exposure (brightness)



“Taking pictures with the right brightness”

- **Taking pictures of a subject against a backlight**

A face against the backlight is brightened.

[SHADOW ADJ] (p. 33)

- **Taking pictures using [FACE DETECT] for [AF MODE] (p. 32)**

Appropriate exposure is obtained for a face against the backlight, and the face is brightened.

- **Taking pictures using [] for [ESP/] (p. 32)**

The picture can be taken based on the brightness at the center of the monitor, so it's not affected by the light in the background.

- **Taking pictures using [FILL IN] (p. 23) flash**

A subject against a backlight is brightened.

- **Taking pictures of a white beach or snow scene**

Set the mode to [BEACH & SNOW], [SNOW] (p. 33)

- **Taking pictures using exposure compensation (p. 23)**

Adjust the brightness while viewing the screen for taking the picture. Normally, taking pictures of white subjects (such as snow) results in images that are darker than the actual subject. Use the [] button to adjust in the positive (+) direction to express whites as they appear. When taking pictures of black subjects, on the other hand, it is effective to adjust in the negative (-) direction.

Color hue



“Taking pictures with colors at the same shade as they appear”

- **Taking pictures by selecting [WB] (p. 30)**

Best results in most environments can normally be obtained with the AUTO setting, but for some subjects, you should try experimenting with different settings. (This is especially true for sunshade under a clear sky, mixed natural and artificial light settings, and so on.)

Image quality



“Taking sharper pictures”

- **Taking pictures with the optical zoom**

Avoid using [DIGITAL ZOOM] (p. 31) to take pictures.

- **Taking pictures at a low ISO sensitivity**

If the picture is taken with a high ISO sensitivity, noise (small colored spots and color unevenness that were not in the original image) can occur, and the image can appear grainy.

[ISO] (p. 30)

Panorama



“Taking pictures so that the frames are stitched smoothly”

- **A tip for panoramic shooting**

Taking pictures by pivoting with the camera at the center prevents shifting of the image. When taking pictures of close objects in particular, pivoting with the lens end at the center produces favorable results.

[PANORAMA] (p. 34)

Battery



“Making battery last longer”

- Avoid performing the following operations as much as possible as they use up battery power even if no pictures are actually taken
 - Repeatedly pressing the shutter button halfway.
 - Repeatedly using the zoom.
- Set [POWER SAVE] (p. 48) to [ON]

Playback/Editing tips

Playback



“Viewing images in the internal memory and card”

- Remove the card when viewing pictures in the internal memory.
 - “Loading the battery and the xD-Picture Card™ (sold separately) into the camera” (p. 10)
 - “Using the microSD card/microSDHC card (sold separately)” (p. 13)

Editing



“Erasing the sound recorded to a still image”

- Record over the sound with silence when playing back the image
 - [🔊] (Add sound to still images) (p. 40)

Camera care

Exterior

- Wipe gently with a soft cloth. If the camera is very dirty, soak the cloth in mild soapy water and wring well. Wipe the camera with the damp cloth and then dry it with a dry cloth. If you have used the camera at the beach, use a cloth soaked in clean water and wrung well.
- If any dirt, dust, sand, or other foreign material adheres to the periphery of the lens cover after use, or the lens cover does not move smoothly, wash the camera using the method described on P. 69.

Monitor

- Wipe gently with a soft cloth.

Lens

- Blow dust off the lens with a commercial blower, then wipe gently with a lens cleaner.

Battery/AC adaptor

- Wipe gently with a soft, dry cloth.
 - ⚠ Do not use strong solvents such as benzene or alcohol, or chemically treated cloth.
 - ⚠ Mold may form on the lens surface if the lens is left dirty.

Storage

- When storing the camera for extended periods, remove the battery, AC adaptor and card, and keep in a cool, dry place that is well ventilated.
- Periodically insert the battery and test the camera functions.
 - ⚠ Avoid leaving the camera in places where chemical products are handled since this may result in corrosion.

Battery, AC adaptor (included), Charger (sold separately)

- This camera uses one Olympus lithium ion battery (LI-50B). No other type of batteries can be used.
 - ⚠ **Caution:**
There is a risk of explosion if the battery is replaced with the incorrect battery type. Dispose of the used battery following the instructions in "Battery Handling Precautions" (p. 73).
- Power consumption by the camera varies depending on which functions are used.
- During the conditions described below, power is consumed continuously and the battery becomes exhausted quickly.
 - The zoom is used repeatedly.
 - The shutter button is pressed halfway repeatedly in shooting mode, activating the auto focus.
 - A picture is displayed on the monitor for an extended period of time.
 - The camera is connected to a computer or printer.
- Using an exhausted battery may cause the camera to turn off without displaying the battery level warning.
- The rechargeable battery is not fully charged at the time of purchase. Charge the battery fully with the included AC adaptor (F-1AC) or the separately sold AC adaptor (D-7AC)/charger (LI-50C) before use.
- When the included AC adaptor (F-1AC) is used, charging usually takes approximately 2.5 hours (varies on usage).
- The included AC adaptor (F-1AC) has been designed to be used only for charging. Make sure that operations such as shooting, viewing images and so on are not being used while the AC adaptor is connected to the camera.
- The included AC adaptor (F-1AC) is designed to be used only with this camera. Other cameras cannot be charged with this AC adaptor.
- For plug-in type AC adaptor:
The included AC adaptor (F-1AC) is intended to be correctly orientated in a vertical or floor mount position.

Charging the battery by connecting the camera to a computer

To charge the battery, connect the camera to a computer via USB cable, select [EXIT] in the [USB] screen below, and press the  button.

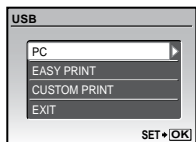

- ❗ If the camera is connected to a printer or an old computer, the operation may be unstable, or charging may take longer than that with the included AC adaptor. Charging time varies depending on the performance of a computer or printer. (There may be cases in which it takes approx. 10 hours.)
- ❗ Even if [REMOVE USB CABLE] is displayed, the battery is charging while the charging indicator is lit in orange. Be sure to remove the USB cable after the battery is charged (the charging indicator turns to blue).
- ❗ If the camera without a battery is connected to a computer, by inserting a battery into the camera, the camera will start charging without showing the [USB] screen above.

Using a separately sold AC adaptor

An AC adaptor (D-7AC/separately sold) is useful for time-consuming tasks such as image downloads to a computer or when running a slideshow for a long period of time. To use a separately sold AC adaptor for this camera, the multi-adaptor (CB-MA1/separately sold) is required. The battery can also be charged by connecting the camera with its power turned off to the AC adaptor. Do not use any other AC adaptor with this camera.

Using a separately sold charger

A charger (LI-50C/separately sold) can be used to charge the battery. In this case, remove the battery from the camera and set the battery to the charger.

Using your charger and AC adaptor abroad

- The charger and AC adaptor can be used in most home electrical sources within the range of 100 V to 240 V AC (50/60Hz) around the world. However, depending on the country or area you are in, the AC wall outlet may be shaped differently and the charger and AC adaptor may require a plug adaptor to match the wall outlet. For details, ask at your local electrical shop or travel agent.
- Do not use travel voltage converters as they could damage your charger and AC adaptor.

Using an xD-Picture Card

A card (and internal memory) also corresponds to the film that records images in a film camera. Otherwise, the recorded images (data) can be erased, and retouching is also available with the use of a computer. Cards can be removed from the camera and exchanged, but this is not possible with the internal memory. Use of larger capacity cards enables you to take more pictures.

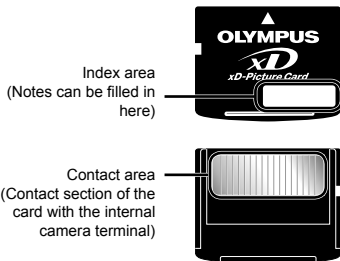

! Do not touch the contact area directly.

Cards compatible with this camera

xD-Picture Card (16MB to 2GB)
(TypeH/M/M+, Standard)

Using a new card

Before using a non-Olympus card or a card that was used for another purpose in a computer or other device, use [MEMORY FORMAT]/[FORMAT] (p. 42) to format the card.

Checking the image saving location

The memory indicator shows whether the internal memory or card is being used during shooting and playback.

Current memory indicator

INT: Internal memory is being used
None: Card is being used

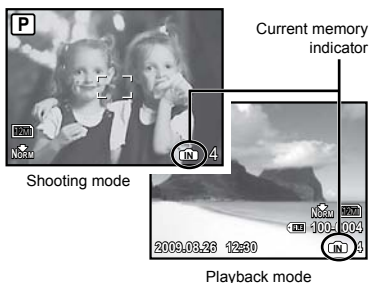

! Even if [MEMORY FORMAT]/[FORMAT], [ERASE], [SEL. IMAGE], or [ALL ERASE] is performed, the data in the card is not completely erased. When disposing of the card, damage the card to prevent the disclosure of personal data.

Readout/recording process of the card

Never open the battery/card compartment cover or unplug the USB cable while the camera is reading or writing data, which is indicated by blinking of the card access lamp. This can not only damage the image data but also render the internal memory or card unusable.

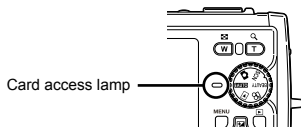

Number of storable pictures (still pictures)/continuous recording length (movies) in the internal memory and xD-Picture Card

Still pictures

IMAGE SIZE		COMPRES- SION	Number of storable still pictures			
			Internal memory		Using a 1GB card (xD-Picture Card)	
			With sound	Without sound	With sound	Without sound
12M	3968×2976	FINE	7	7	173	174
		NORM	15	15	340	343
5M	2560×1920	FINE	18	18	404	410
		NORM	36	37	820	841
3M	2048×1536	FINE	27	28	615	627
		NORM	55	58	1254	1305
2M	1600×1200	FINE	46	47	1031	1066
		NORM	87	93	1938	2063
1M	1280×960	FINE	70	74	1560	1640
		NORM	131	144	2907	3198
VGA	640×480	FINE	228	271	4920	5815
		NORM	368	496	7996	10661
16:9	1920×1080	FINE	42	44	954	984
		NORM	82	87	1827	1938

Movies

IMAGE SIZE		FRAME RATE	Continuous recording length			
			Internal memory		Using a 1 GB card (xD-Picture Card)	
			With sound	Without sound	With sound	Without sound
VGA	640×480	30	25 sec.	25 sec.	9 min. 21 sec.*	9 min. 23 sec.*
		15	49 sec.	50 sec.	18 min. 37 sec.	18 min. 47 sec.
QVGA	320×240	30	59 sec.	59 sec.	22 min. 3 sec.	22 min. 17 sec.
		15	1 min. 56 sec.	1 min. 59 sec.	43 min. 37 sec.	44 min. 32 sec.

When [MOVIE] (p. 36) is set to [NON-WATER MOVIE], see "With sound", and for [UNDERWATER MOVIE], see "Without sound."

The maximum file size of a single movie is 2 GB, regardless of the capacity of the card.

* The maximum length is 10 seconds when using a TypeM or Standard xD-Picture Card.

Increasing the number of pictures that can be taken

Either erase unwanted images, or connect the camera to a computer or other device to save the images, and then erase the images in the internal memory or card.

[ERASE] (p. 18), [SEL. IMAGE] (p. 40), [ALL ERASE] (p. 40), [MEMORY FORMAT]/[FORMAT] (p. 42)

Using a microSD Attachment

❗ Do not use the attachment with Olympus digital cameras that do not support this microSD Attachment, as well as with other brands of digital cameras, computers, printers, and other devices that support xD-Picture Card. Doing so not only may damage the pictures taken, but may also result in the malfunction of the device.

❗ If the microSD card cannot be removed, do not use force. Contact authorized distributors/service centers.

Cards compatible with this camera

microSD card/microSDHC card

❗ For a list of tested microSD cards, please visit our website (<http://www.olympus.com/>).

Sending images

You can send images to a computer or printer by using the USB cable provided with the camera.

To send data to other devices, remove the attachment from the camera and use a commercially available microSD card adapter.

Handling precautions

Do not touch the contact area of the attachment or microSD card. Doing so may cause failure in reading the images. When fingerprints or stains are found on the contact area, wipe the area with a soft dry cloth.

Important information about water and shock resistant features

Water resistance: The waterproof feature is warranted^{*1} to operate at depths up to 10 m (32.8 feet) for up to one hour. The waterproof feature may be compromised if the camera is subject to substantial or excessive impact.

Shock resistance: The anti-shock feature warrants^{*2} the operation of the camera against accidental impact incurred from everyday use of your digital compact camera. The anti-shock feature does not unconditionally warrant all defective operation or cosmetic damage. Cosmetic damage, such as scratches and dents, are not covered under the warranty.

As with any electronic device, proper care and maintenance are required to preserve the integrity and operation of your camera. To maintain camera performance, please take your camera to the nearest Olympus Authorized Service Center to have it inspected after any major impact. In the event the camera is damaged as a result of negligence or misuse, the warranty will not cover costs associated with the service or repair of your camera. For additional information on our warranty, please visit to the Olympus website for your local area. Please observe the following care instructions for your camera.

*1 As determined by Olympus pressure testing equipment in accordance with IEC Standard Publication 529 IPX8 - This means that the camera can be used normally under water at a specified water pressure.

*2 This anti-shock performance is confirmed by Olympus' testing conditions in accordance with MIL-STD-810F, Method 516.5, Procedure IV (Transit Drop Test). For more details of Olympus' testing conditions, please refer to the Olympus website for your local area.

Before Use:

- Check the camera for foreign material including dirt, dust or sand.
- Be sure to close the battery/card compartment cover and connector cover firmly so that each lock makes clicking sound.
- Do not open the battery/card compartment cover and connector cover with wet hands, while under water, or in a damp or dusty environment (e.g. beach).

After Use:

- Be sure to wipe off any excess water or debris after using the camera under water.
- **After the camera is used under seawater, immerse the camera in a bucket containing fresh water for about 10 minutes (with the battery/card compartment cover and connector cover firmly closed). After that, dry the camera in a shade with good ventilation.**
- **Water drops may be observed on the inner surface of the battery/card compartment cover or connector cover after you open each cover. If any water drops are found, be sure to wipe them off before using the camera.**

Notes after use

- Foreign materials may be attached to the periphery of the lens cover from using the camera in conditions with foreign materials such as dirt, dust or sand, or when the lens cover is not moving smoothly. If you continue to use the camera in such conditions, the lens could become damaged or the lens cover could stick causing additional damage to the camera. To avoid such damage, wash the camera using the following method.

- ① Insert the battery and close the battery/card compartment cover and connector cover firmly so that each lock makes the clicking sound.
- ② Fill a bucket with fresh water, immerse the camera in the bucket with the lens surface downward and shake the camera thoroughly.
- ③ Press the **ON/OFF** button several times in the water and close/open the lens cover repeatedly.
- ④ Furthermore, shake the camera further with the cover opened.

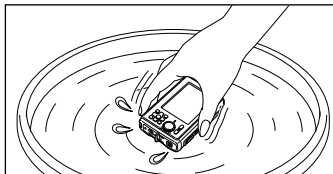

Follow the Steps ① to ④, then check if the lens cover moves smoothly. If the lens cover does not move smoothly, rinse the lens face by placing it directly under a strong stream of tap water and pressing the **ON/OFF** button repeatedly.

Storage and Maintenance



- Do not leave the camera in an environment at high temperature (40°C (104°F) or more) or at low temperature (-10°C (14°F) or less). Failure to do so may break down water resistance.
- Do not use chemicals for cleaning, rust prevention, anti-fogging, repairing, etc. Failure to do so may break down water resistance.
- **Do not leave the camera in water for a long time. Failure to do so will cause damage to the camera's appearance and/or deteriorate water resistance.**
- **In order to preserve the water resistant feature, as with any underwater housing, it is recommended that the waterproof packing (and seals) are replaced annually. For the Olympus distributors or service stations where the waterproof packing can be replaced, visit Olympus website for your local area.**

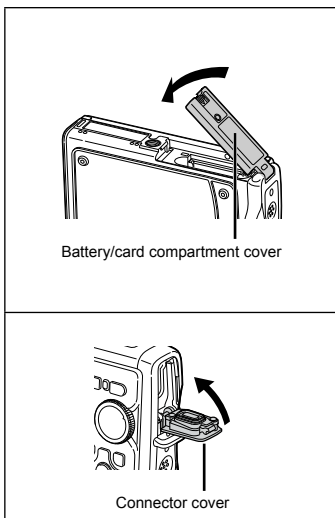



Closing Battery/card compartment cover and Connector cover



- ⚠ The included accessories (e.g. AC adaptor) do not offer shock or water resistance.

SAFETY PRECAUTIONS

	CAUTION RISK OF ELECTRIC SHOCK DO NOT OPEN	
CAUTION: TO REDUCE THE RISK OF ELECTRICAL SHOCK, DO NOT REMOVE COVER (OR BACK). NO USER-SERVICEABLE PARTS INSIDE. REFER SERVICING TO QUALIFIED OLYMPUS SERVICE PERSONNEL.		

-  An exclamation mark enclosed in a triangle alerts you to important operating and maintenance instructions in the documentation provided with the product.
-  **DANGER** If the product is used without observing the information given under this symbol, serious injury or death may result.
-  **WARNING** If the product is used without observing the information given under this symbol, injury or death may result.
-  **CAUTION** If the product is used without observing the information given under this symbol, minor personal injury, damage to the equipment, or loss of valuable data may result.

WARNING!
TO AVOID THE RISK OF FIRE OR ELECTRICAL SHOCK, NEVER DISASSEMBLE, EXPOSE THIS PRODUCT TO WATER OR OPERATE IN A HIGH HUMIDITY ENVIRONMENT.

General Precautions

- Read All Instructions** — Before you use the product, read all operating instructions. Save all manuals and documentation for future reference.
- Cleaning** — Always unplug this product from the wall outlet before cleaning. Use only a damp cloth for cleaning. Never use any type of liquid or aerosol cleaner, or any type of organic solvent to clean this product.
- Attachments** — For your safety, and to avoid damaging the product, use only accessories recommended by Olympus.
- Water and Moisture** — For precautions on products with weatherproof designs, read the weatherproofing sections.
- Location** — To avoid damage to the product, mount the product securely on a stable tripod, stand, or bracket.
- Power Source** — Connect this product only to the power source described on the product label.
- Lightning** — If a lightning storm occurs while using an AC adapter, remove it from the wall outlet immediately.
- Foreign Objects** — To avoid personal injury, never insert a metal object into the product.
- Heat** — Never use or store this product near any heat source such as a radiator, heat register, stove, or any type of equipment or appliance that generates heat, including stereo amplifiers.

Handling the Camera

WARNING

- Do not use the camera near flammable or explosive gases.
- Do not use the flash and LED on people (infants, small children, etc.) at close range.
 - You must be at least 1 m (3 ft.) away from the faces of your subjects. Firing the flash too close to the subject's eyes could cause a momentary loss of vision.
- Keep young children and infants away from the camera.
 - Always use and store the camera out of the reach of young children and infants to prevent the following dangerous situations which could cause serious injury:
 - Becoming entangled in the camera strap, causing strangulation.
 - Accidentally swallowing the battery, cards or other small parts.
 - Accidentally firing the flash into their own eyes or those of another child.
 - Accidentally being injured by the moving parts of the camera.
- Do not look at the sun or strong lights with the camera.
- Do not use or store the camera in dusty or humid places.
- Do not cover the flash with a hand while firing.
- Do not insert anything into the microSD Attachment other than the microSD card. This attachment is exclusive for use of microSD cards only. Other types of cards cannot be installed.
- Do not insert anything other than an xD-Picture Card or the microSD Attachment into the camera
If you insert a card by mistake, such as a microSD card, do not use force. Contact authorized distributors/service centers.

CAUTION

- Stop using the camera immediately if you notice any unusual odors, noise, or smoke around it.
 - Never remove the batteries with bare hands, which may cause a fire or burn your hands.
- Do not leave the camera in places where it may be subject to extremely high temperatures.
 - Doing so may cause parts to deteriorate and, in some circumstances, cause the camera to catch fire. Do not use the charger or AC adapter if it is covered (such as a blanket). This could cause overheating, resulting in fire.
- Handle the camera with care to avoid getting a low-temperature burn.
 - When the camera contains metal parts, overheating can result in a low-temperature burn. Pay attention to the following:
 - When used for a long period, the camera will get hot. If you hold on to the camera in this state, a low-temperature burn may be caused.
 - In places subject to extremely cold temperatures, the temperature of the camera's body may be lower than the environmental temperature. If possible, wear gloves when handling the camera in cold temperatures.
- Be careful with the strap.
 - Be careful with the strap when you carry the camera. It could easily catch on stray objects and cause serious damage.
- Do not touch the metallic parts of the camera for a long period of time at low temperatures.
 - This may damage your skin. At low temperatures, handle the camera while wearing gloves.

Battery Handling Precautions

Follow these important guidelines to prevent batteries from leaking, overheating, burning, exploding, or causing electrical shocks or burns.

DANGER

- The camera uses a lithium ion battery specified by Olympus. Charge the battery with the specified AC adaptor or charger. Do not use any other AC adaptors or chargers.
- Never heat or incinerate batteries.
- Take precautions when carrying or storing batteries to prevent them from coming into contact with any metal objects such as jewelry, pins, fasteners, etc.
- Never store batteries where they will be exposed to direct sunlight, or subjected to high temperatures in a hot vehicle, near a heat source, etc.
- To prevent causing battery leaks or damaging their terminals, carefully follow all instructions regarding the use of batteries. Never attempt to disassemble a battery or modify it in any way, solder, etc.
- If battery fluid gets into your eyes, flush your eyes immediately with clear, cold running water and seek medical attention immediately.
- Always store batteries out of the reach of small children. If a child accidentally swallows a battery, seek medical attention immediately.

WARNING

- Keep batteries dry at all times.
- To prevent batteries from leaking, overheating, or causing a fire or explosion, use only batteries recommended for use with this product.
- Insert the battery carefully as described in the operating instructions.
- If rechargeable batteries have not been recharged within the specified time, stop charging them and do not use them.
- Do not use a battery if it is cracked or broken.
- If a battery leaks, becomes discolored or deformed, or becomes abnormal in any other way during operation, stop using the camera.
- If a battery leaks fluid onto your clothing or skin, remove the clothing and flush the affected area with clean, running cold water immediately. If the fluid burns your skin, seek medical attention immediately.
- Never subject batteries to strong shocks or continuous vibration.

CAUTION

- Before loading, always inspect the battery carefully for leaks, discoloration, warping, or any other abnormality.
- The battery may become hot during prolonged use. To avoid minor burns, do not remove it immediately after using the camera.
- Always unload the battery from the camera before storing the camera for a long period.

Caution for Usage Environment

- To protect the high-precision technology contained in this product, never leave the camera in the places listed below, no matter if in use or storage:
 - Places where temperatures and/or humidity are high or go through extreme changes. Direct sunlight, beaches, locked cars, or near other heat sources (stove, radiator, etc.) or humidifiers.
 - In sandy or dusty environments.
 - Near flammable items or explosives.
 - In wet places, such as bathrooms or in the rain. When using products with weatherproof designs, read their manuals as well.
 - In places prone to strong vibrations.
- Never drop the camera or subject it to severe shocks or vibrations.
- When mounted on a tripod, adjust the position of the camera with the tripod head. Do not twist the camera.
- Do not touch electric contacts on cameras.
- Do not leave the camera pointed directly at the sun. This may cause lens or shutter curtain damage, color failure, ghosting on the CCD, or may possibly cause fires.
- Do not push or pull severely on the lens.
- Before storing the camera for a long period, remove the batteries. Select a cool, dry location for storage to prevent condensation or mold from forming inside the camera. After storage, test the camera by turning it on and pressing the shutter button to make sure that it is operating normally.
- Always observe the operating environment restrictions described in the camera's manual.
- The altitude/depth measurement function is not approved by an official institution. Use the readings only for your reference.

Battery Handling Precautions

- This camera uses a lithium ion battery specified by Olympus. Do not use any other type of battery.
- If the battery's terminals get wet or greasy, camera contact failure may result. Wipe the battery well with a dry cloth before use.
- Always charge a battery when using it for the first time, or if it has not been used for a long period.
- When operating the camera with battery power at low temperatures, try to keep the camera and spare battery as warm as possible. A battery that has run down at low temperatures may be restored after it is warmed at room temperature.
- The number of pictures you can take may vary depending on the shooting conditions or battery.
- Before going on a long trip, and especially before traveling abroad, purchase extra batteries. A recommended battery may be difficult to obtain while traveling.
- Please recycle batteries to help save our planet's resources. When you throw away dead batteries, be sure to cover their terminals and always observe local laws and regulations.

LCD Monitor

- Do not push the monitor forcibly; otherwise the image may become vague, resulting in a playback mode failure or damage to the monitor.
- A strip of light may appear on the top/bottom of the monitor, but this is not a malfunction.
- When a subject is viewed diagonally in the camera, the edges may appear zigzagged on the monitor. This is not a malfunction; it will be less noticeable in playback mode.
- In places subject to low temperatures, the LCD monitor may take a long time to turn on or its color may change temporarily. When using the camera in extremely cold places, it is a good idea to occasionally place it in a warm place. An LCD monitor exhibiting poor performance due to low temperatures will recover in normal temperatures.
- The LCD used for the monitor is made with high-precision technology. However, black spots or bright spots of light may appear constantly on the LCD monitor. Due to its characteristics or the angle at which you are viewing the monitor, the spot may not be uniform in color and brightness. This is not a malfunction.

Legal and Other Notices

- Olympus makes no representations or warranties regarding any damages, or benefit expected by using this unit lawfully, or any request from a third person, which are caused by the inappropriate use of this product.
- Olympus makes no representations or warranties regarding any damages or any benefit expected by using this unit lawfully which are caused by erasing picture data.

Disclaimer of Warranty

- Olympus makes no representations or warranties, either expressed or implied, by or concerning any content of these written materials or software, and in no event shall be liable for any implied warranty of merchantability or fitness for any particular purpose or for any consequential, incidental or indirect damages (including but not limited to damages for loss of business profits, business interruption and loss of business information) arising from the use or inability to use these written materials or software or equipment. Some countries do not allow the exclusion or limitation of liability for consequential or incidental damages, so the above limitations may not apply to you.
- Olympus reserves all rights to this manual.

Warning

Unauthorized photographing or use of copyrighted material may violate applicable copyright laws. Olympus assumes no responsibility for unauthorized photographing, use or other acts that infringe upon the rights of copyright owners.

Copyright Notice

All rights reserved. No part of these written materials or this software may be reproduced or used in any form or by any means, electronic or mechanical, including photocopying and recording or the use of any type of information storage and retrieval system, without the prior written permission of Olympus. No liability is assumed with respect to the use of the information contained in these written materials or software, or for damages resulting from the use of the information contained therein. Olympus reserves the right to alter the features and contents of this publication or software without obligation or advance notice.

For customers in Europe



"CE" mark indicates that this product complies with the European requirements for safety, health, environment and customer protection. "CE" mark cameras are intended for sales in Europe.



This symbol [crossed-out wheeled bin WEEE Annex IV] indicates separate collection of waste electrical and electronic equipment in the EU countries. Please do not throw the equipment into the domestic refuse.

Please use the return and collection systems available in your country for the disposal of this product.



This symbol [crossed-out wheeled bin Directive 2006/66/EC Annex II] indicates separate collection of waste batteries in the EU countries. Please do not throw the batteries into the domestic refuse. Please use the return and collection systems available in your country for the disposal of the waste batteries.

Use Only Dedicated Rechargeable Battery, Battery Charger and AC adaptor

We strongly recommend that you use only the genuine Olympus dedicated rechargeable battery, battery charger and AC adaptor with this camera. Using a non-genuine rechargeable battery, battery charger and/or AC adaptor may result in fire or personal injury due to leakage, heating, ignition or damage to the battery. Olympus does not assume any liability for accidents or damage that may result from the use of a battery, battery charger and/or AC adaptor that are not genuine Olympus accessories.

Provisions of warranty

- If this product proves to be defective, although it has been used properly (in accordance with the written Safety Precautions and Operating instructions supplied with it), during a period of two years from the date of purchase from an authorized Olympus distributor within the business area of Olympus Imaging Europa GmbH as stipulated on the website: <http://www.olympus.com> this product will be repaired, or at Olympus's option replaced, free of charge. To claim under this warranty the customer must take the product and this Warranty Certificate before the end of the two year warranty period to the dealer where the product was purchased or any other Olympus service station within the business area of Olympus Imaging Europa GmbH as stipulated on the website: <http://www.olympus.com>. During the one year period of the World Wide Warranty the customer may turn the product in at any Olympus service station. Please notice that not in all countries such Olympus service station exists.

- 2 The customer shall transport the product to the dealer or Olympus authorized service station at his own risk and shall be responsible for any costs incurred in transporting the product.
 - 3 This warranty does not cover the following and the customer will be required to pay repair charge, even for defects occurring within the warranty period referred to above.
 - a. Any defect that occurs due to mishandling (such as an operation performed that is not mentioned in the Safety Precautions or other sections of the instructions, etc.)
 - b. Any defect that occurs due to repair, modification, cleaning, etc. performed by anyone other than Olympus or an Olympus authorized service station.
 - c. Any defect or damage that occurs due to transport, a fall, shock, etc. after purchase of the product.
 - d. Any defect or damage that occurs due to fire, earthquake, flood damage, thunderbolt, other natural disasters, environmental pollution and irregular voltage sources.
 - e. Any defect that occurs due to careless or improper storage (such as keeping the product under conditions of high temperature and humidity, near insect repellents such as naphthalene or harmful drugs, etc.), improper maintenance, etc.
 - f. Any defect that occurs due to exhausted batteries, etc.
 - g. Any defect that occurs due to sand, mud, etc. entering the inside of the product casing.
 - h. When this Warranty Certificate is not returned with the product.
 - i. When any alterations whatsoever are made to the Warranty Certificate regarding the year, month and date of purchase, the customer's name, the dealer's name, and the serial number.
 - j. When proof of purchase is not presented with this Warranty Certificate.
 - 4 This Warranty applies to the product only; the Warranty does not apply to any other accessory equipment, such as the case, strap, lens cap and batteries.
 - 5 Olympus's sole liability under this warranty shall be limited to repairing or replacing the product. Any liability for indirect or consequential loss or damage of any kind incurred or suffered by the customer due to a defect of the product, and in particular any loss or damage caused to any lenses, films, other equipment or accessories used with the product or for any loss resulting from a delay in repair or loss of data, is excluded. Compelling regulations by law remain unaffected by this.
- Notes regarding warranty maintenance**
- 1 This warranty will only be valid if the Warranty Certificate is duly completed by Olympus or an authorized dealer or other documents contain sufficient proof. Therefore, please make sure that your name, the name of the dealer, the serial number and the year, month and date of purchase are all completed or the original invoice or the sales receipt (indicating the dealer's name, the date of purchase and product type) is attached to this Warranty Certificate. Olympus reserves the right to refuse free-of-charge service if neither Warranty Certificate is completed nor the above document is attached or if the information contained in it is incomplete or illegible.
 - 2 Since this Warranty Certificate will not be re-issued, keep it in a safe place.
- * Please refer to the list on the website: <http://www.olympus.com> for the authorized international Olympus service network.

Trademarks

- IBM is a registered trademark of International Business Machines Corporation.
- Microsoft and Windows are registered trademarks of Microsoft Corporation.
- Macintosh is a trademark of Apple Inc.
- xD-Picture Card™ is a trademark.
- microSD is a trademark of the SD Association.
- All other company and product names are registered trademarks and/or trademarks of their respective owners.
- The standards for camera file systems referred to in this manual are the "Design rule for Camera File system/DCF" standards stipulated by the Japan Electronics and Information Technology Industries Association (JEITA).

SPECIFICATIONS

Camera

Product type	: Digital camera (for shooting and displaying)
Recording system	
Still pictures	: Digital recording, JPEG (in accordance with Design rule for Camera File system (DCF))
Applicable standards	: Exif 2.2, Digital Print Order Format (DPOF), PRINT Image Matching III, PictBridge
Sound with still pictures	: Wave format
Movie	: AVI Motion JPEG
Memory	: Internal memory xD-Picture Card (16 MB to 2 GB) (TypeH/MM+, Standard) microSD card/microSDHC card (with the supplied microSD Attachment)
No. of effective pixels	: 12,000,000 pixels
Image pickup device	: 1/2.33" CCD (primary color filter), 12,700,000 pixels (gross)
Lens	: Olympus lens 5.0 to 18.2 mm, f3.5 to 5.1 (equivalent to 28 to 102 mm on a 35mm camera)
Photometric system	: Digital ESP metering, spot metering system
Shutter speed	: 4 to 1/2000 sec.
Shooting range	: 0.5 m (1.6 ft.) to ∞ (W/T) (normal) 0.1 m (0.3 ft.) to ∞ (W), 0.3 m (1.0 ft.) to ∞ (T) (macro mode) 0.02 m (0.8 in.) to 0.5 m (1.6 ft.) (W only) (super macro mode) 0.07 m (2.8 in.) to 0.2 m (0.7 ft.) (W only) (S-macro LED mode)
Monitor	: 2.7" TFT color LCD display, 230,000 dots
Flash charge time	: Approx. 3.5 sec. (for full flash discharge at room temperature using a new fully charged battery)
Connector	: Multi-connector (DC-IN jack USB connector, A/V OUT jack)
Automatic calendar system	: 2000 up to 2099
Water resistance	
Type	: Equivalent to IEC Standard publication 529 IPX8 (under OLYMPUS test conditions), available in 10 m (32.8 feet) deep water
Meaning	: Camera can normally be used under water at a specified water pressure.
Dust resistance	: IEC Standard publication 529 IP6X (under OLYMPUS test conditions)
Operating environment	
Temperature	: -10 °C to 40 °C (14 °F to 104 °F) (operation/ -20 °C to 60 °C (-4 °F to 140 °F) (storage)
Humidity	: 30 % to 90 % (operation)/10 % to 90 % (storage)
Power supply	: One Olympus lithium ion battery (LI-50B) or Olympus AC adapter (D-7AC/separately sold)
Dimensions	: 95.0 mm (W) × 61.7 mm (H) × 21.5 mm (D) (3.7 × 2.4 × 0.8 in.) (excluding protrusions)
Weight	: 182 g (5.9 oz) (excluding battery and card)

"Shadow Adjustment Technology" function contains patented technologies from Apical Limited.



Lithium ion battery (LI-50B)

Product type	: Lithium ion rechargeable battery
Model No.	: LI-50BA/LI-50BB
Standard voltage	: DC 3.7 V
Standard capacity	: 925 mAh
Battery life	: Approx. 300 full charges (varies on usage)
Operating environment	
Temperature	: 0°C to 40°C (32°F to 104°F) (charging)/ -10°C to 60°C (14°F to 140°F) (operation)/ -10°C to 35°C (14°F to 95°F) (storage)
Dimensions	: 34.4 mm (W) × 40.0 mm (H) × 7.0 mm (D) (1.4 × 1.6 × 0.3 in.)
Weight	: Approx. 20 g (0.7 oz)

AC adaptor (F-1AC)

Model No.	: F-1AC-1/F-1AC-2/F-1AC-3
Power requirements	: AC 100 to 240 V (50/60 Hz)
Output	: DC 5 V, 700 mA
Charging time	: Approx. 2.5 hours
Operating environment	
Temperature	: 0°C to 40°C (32°F to 104°F) (operation)/ -20°C to 60°C (-4°F to 140°F) (storage)
Dimensions	: 48.0 mm (W) × 60.0 mm (H) × 21.0 mm (D) (1.9 × 2.4 × 0.8 in.) (F-1AC-1)/ 39.0 mm (W) × 67.0 mm (H) × 21.0 mm (D) (1.5 × 2.6 × 0.8 in.) (F-1AC-2)/ 50.0 mm (W) × 70.0 mm (H) × 21.0 mm (D) (2.0 × 2.8 × 0.8 in.) (F-1AC-3)
Weight	: Approx. 80.0 g (2.8 oz) (F-1AC-1)/ Approx. 70.0 g (2.5 oz) (F-1AC-2)/ Approx. 90.0 g (3.2 oz) (F-1AC-3)
Connecting cord length	: Approx. 1.5 m (4.9 ft.)

Using in low temperatures

Low temperature operation of the optional Olympus xD-Picture Card and lithium ion battery are guaranteed to 0°C (32°F). However, the following have been tested for use with this product in temperatures up to -10°C (14°F).

Olympus xD-Picture Card

	16MB	32MB	64MB	128MB	256MB	512MB	1GB	2GB
Standard	✓	✓	✓	✓	✓	✓		
TypeM/M+					✓	✓	✓	✓
TypeH					✓	✓	✓	✓

✓ Operation confirmed

Olympus lithium ion battery

LI-50B

- The number of storable still pictures is reduced in low temperatures.

microSD Attachment

Product type	: Attachment for microSD card
Operating Environment	
Temperature	: -10°C to 40°C (14 to 104°F) (operation)/ -20°C to 65°C (-4 to 149°F) (storage)
Humidity	: 95% and below (operation)/85% and below (storage)
Dimensions	: 25.0 mm (W) x 20.3 mm (H) x 1.7 mm (D) (1.0 x 0.8 x 0.07 in.) (Handle:2.2 mm (0.09 in.))
Weight	: Approx. 0.9 g (0.03 oz)

Design and specifications subject to change without notice.



A

AC adapter.....	2, 65
AF lock.....	19
AF MODE.....	32
ALL (PERFECT FIX).....	37
ALL (SLIDESHOW).....	37
ALL INDEX.....	52
ALL PRINT.....	52
All-image print reservation 	55
AUTO (FILE NAME).....	45
AUTO (ISO).....	30
AUTO (WB).....	30
AV cable.....	2, 47

B

BACKUP.....	42
Battery.....	2, 10, 59, 63, 64
BEAUTY mode.....	20
BEAUTY FIX 	37
BEEP.....	44
BGM.....	37
Black & White.....	38

C





CALENDAR.....	39
CALENDAR (SLIDESHOW).....	37
CALIBRATE.....	49
Calendar view.....	27
CAMERA MENU 	30
Card.....	10, 13, 66
CLEAR SKIN.....	37
Close-up view 	27
Cloudy day 	30
COLOR 1/2/3.....	43
COLOR EDIT.....	38
COMBINE IN CAMERA1.....	34
COMBINE IN CAMERA2.....	34
COMBINE IN PC.....	34
COMPRESSION.....	29
Connection	
To Computer.....	57
To Printer.....	51
To Television.....	47

Cropping a picture 	38, 53
CUSTOM PRINT.....	52



D

DATE (☺).....	55
DATE (PRINT INFO).....	53
Date and time (☺).....	14, 46
DIGITAL ZOOM.....	31
Direct printing.....	51
Display language 	14, 42
DIS MOVIE MODE (Movies).....	32
DPOF.....	54
DRAMATIC EYE.....	37
DRIVE.....	31
DUALTIME.....	46

E

EASY PRINT.....	51
EDIT 	38, 39
Erase	
ALL ERASE.....	40
ERASE 	40
SEL. IMAGE.....	40
Single image erase.....	18
ESP.....	32
ESP/ 	32
Exposure.....	16
Exposure compensation 	23

F



FACE DETECT.....	32
FADER (SLIDESHOW).....	37
FILE NAME.....	45
File name.....	45
FILE NAME (PRINT INFO).....	53
FILL IN 	23
FINE.....	29
FINE ZOOM.....	31
FLASH AUTO.....	23
Flash charge.....	59
Flash mode 	22
FLASH OFF (☺).....	23

Fluorescent lamp1/2/3 	30
FORMAT	42
Format	42
FRAME RATE	29
FUNC menu	25

H

High speed sequential shooting 	31
Histogram display	25, 27





I

I AUTO mode.....	20
iESP	32
IMAGE QUALITY 	29
IMAGE SIZE	29
IMAGE STABILIZER (Still images)	32
INDEX.....	39
Index view 	27
Information displays.....	25, 27
Internal memory.....	11, 67
ISO.....	30

L

LED ILLUMINATOR.....	24, 48
Lithium ion battery	2

M

MACRO 	23
Macro mode 	23
MEMORY FORMAT	42
Menu.....	3
MENU COLOR	43
Menu guide	3
microSD Attachment.....	2, 13, 68
microSD card.....	13, 68
microSDHC card.....	13, 68
Monitor brightness adjustment 	46
MOVIE 	36
MOVIE (SLIDESHOW)	37
MULTI PRINT	52
MULTI WINDOW	26







N

NO (⊖)	55
NORMAL	29
NORMAL (MENU COLOR).....	43
NORMAL (SLIDESHOW)	37
NTSC	47
Number of prints ().....	53



O

OLYMPUS Master 2	2, 57
Optical zoom.....	22

















P

PAL	47
PANORAMA 	34
Panorama playback.....	28
PC.....	57
PERFECT FIX 	37
PictBridge	51
Picture rotation 	40
PIXEL MAPPING	45
PLAYBACK MENU 	39, 40
Playback mode 	17
Playback on a TV.....	47
POWER SAVE	48
PRINT ORDER	52
PRINT ORDER 	41
Print reservations.....	54
Printing pictures.....	51
Protect 	39
PW ON SETUP.....	43



R

REC VIEW	44
REDEYE 	23
REDEYE FIX	37
RESET 	36
RESET (FILE NAME)	45
Resizing 	38

S

Saturation (Hard).....	38
Saturation (Soft).....	38
SCN (SCENE MODE) 	19, 33
SCREEN.....	43
SELFTIMER 	24
Sepia.....	38
Sequential shooting 	31
SETUP 	42
SHADOW ADJ.....	26, 33
Shooting mode.....	19
Shooting movies 	21
Shooting still pictures (Full auto mode) FAUTO	20
Shooting still pictures 	16
SHUTTER SOUND.....	44
SILENT MODE 	50
Single-image print reservation 	54
Single-frame shooting 	31
SLIDE (SLIDESHOW).....	37
SLIDESHOW 	37
S-MACRO LED 	23
Sound recording Adding sound to still pictures 	40
Recording sound with still pictures 	32
SOUND SETTINGS.....	44
SPARKLE EYE.....	37
SPOT (AF MODE).....	32
Spot metering 	32
STILL PICTURE (SLIDESHOW).....	37
Strap.....	2
Sunny day 	30
SUPER MACRO 	23

T

TAP CONTROL.....	49
TIME ().....	55
Top menu.....	5
Tungsten light 	30
Turn the camera on.....	14, 16
TYPE.....	37

U

USB cable.....	2, 51, 57
----------------	-----------

V

VIDEO OUT.....	47
VOLUME.....	43
VOLUME 	44

W

Warning sound 	44
White balance WB.....	30

X

xD-Picture Card.....	10, 66
----------------------	--------

Z

Zoom.....	22
ZOOM (SLIDESHOW).....	37



<http://www.olympus.com/>

OLYMPUS IMAGING CORP.

Shinjuku Monolith, 3-1 Nishi-Shinjuku 2-chome, Shinjuku-ku, Tokyo, Japan

OLYMPUS IMAGING AMERICA INC.

3500 Corporate Parkway, P.O. Box 610, Center Valley, PA 18034-0610, U.S.A. Tel. 484-896-5000

Technical Support (USA)

24/7 online automated help: <http://www.olympusamerica.com/support>

Phone customer support: Tel. 1-888-553-4448 (Toll-free)

Our phone customer support is available from 8am to 10pm

(Monday to Friday) and 9am to 5pm (Sunday) ET

<http://olympusamerica.com/contactus>

Olympus software updates can be obtained at: <http://www.olympusamerica.com/digital>

OLYMPUS IMAGING EUROPA GMBH

Premises: Wendenstrasse 14-18, 20097 Hamburg, Germany

Tel: +49 40-23 77 3-0 / Fax: +49 40-23 07 61

Goods delivery: Bredowstrasse 20, 22113 Hamburg, Germany

Letters: Postfach 10 49 08, 20034 Hamburg, Germany

European Technical Customer Support:

Please visit our homepage <http://www.olympus-europa.com>

or call our TOLL FREE NUMBER* : **00800 - 67 10 83 00**

for Austria, Belgium, Denmark, Finland, France, Germany, Italy, Luxemburg, Netherlands, Norway, Portugal, Spain, Sweden, Switzerland, United Kingdom

* Please note some (mobile) phone services providers do not permit access or request an additional prefix to +800 numbers.

For all European Countries not listed and in case that you can't get connected to the above mentioned number, please make use of the following

CHARGED NUMBERS: **+49 180 5 - 67 10 83** or **+49 40 - 237 73 4899**

Our Technical Customer Support is available from 9 am to 6 pm MET (Monday to Friday)