

OLYMPUS®

DIGITAL CAMERA

XZ-1

Instruction Manual

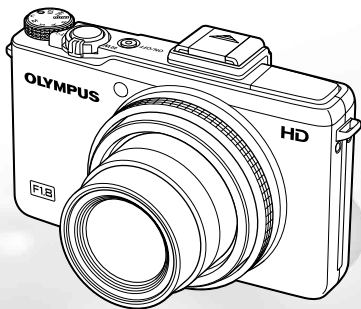

- Thank you for purchasing an Olympus digital camera. Before you start to use your new camera, please read these instructions carefully to enjoy optimum performance and a longer service life. Keep this manual in a safe place for future reference.
- We recommend that you take test shots to get accustomed to your camera before taking important photographs.
- In the interest of continually improving our products, Olympus reserves the right to update or modify information contained in this manual.
- The screen and camera illustrations shown in this manual were produced during the development stages and may differ from the actual product.

Step 1 Checking the contents of the box



Digital camera



Strap



Lens cap and
lens cap strap



LI-50B lithium
ion battery

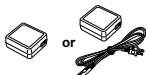

F-2AC
USB-AC adapter



USB cable



AV cable



OLYMPUS Setup CD-ROM

Other accessories not shown: warranty card
Contents may vary depending on purchase location.

Step 2 Preparing the Camera

"Preparing the Camera" (p. 13)

Step 3 Shooting and Playing Back Images

"Shooting, Viewing, and Erasing" (p. 20)

Step 4 How to Use the Camera

"Camera Settings" (p. 3)

Step 5 Printing

"Direct printing (PictBridge)" (p. 64)
"Print Reservations (DPOF)" (p. 68)

Contents

➤ Names of Parts.....	9	➤ Menus for Playback, Editing, and Printing Functions.....	52
➤ Preparing the Camera.....	13	➤ Menus for Other Camera Settings.....	57
➤ Shooting, Viewing, and Erasing.....	20	➤ Printing.....	64
➤ Using Shooting Modes.....	28	➤ Usage Tips.....	71
➤ Using Shooting Functions.....	36	➤ Appendix.....	76
➤ Menus for Shooting Functions.....	45		

Camera Settings

Using the Direct Buttons

Frequently used functions can be accessed using the direct buttons.



Zoom lever (p. 22, 26)



Shutter button (p. 21)

● button (record movies) (p. 21)



▶ button (switch between shooting and playback) (p. 21, 23)



MENU button (p. 6)



INFO button (change information display) (p. 23, 26, 36, 38, 40, 44)

Mode dial

Use the mode dial to select the shooting mode.

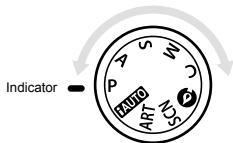

iAUTO iAUTO (p. 28)

P Program Auto (p. 20)

A Aperture Priority (p. 29)

S Shutter Priority (p. 29)

M Manual Shooting (p. 30)

C Custom Mode Setup (p. 30)

A Low Light (p. 30)

SCN Scene Mode (p. 31)

ART Art Filter (p. 34)

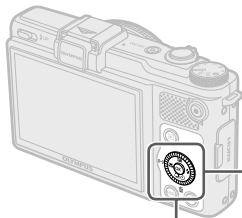

Ⓜ button
(p. 4, 5)

Wheel controller



△ (up) /
☒ (exposure compensation) button (p. 38)



▽ (down) /
⏻ (sequential shooting/Self-timer) button (p. 38) /
🗑️ button (erase) (p. 25)



◀ (left) /
🌸 (macro) button (p. 36) /
[•••] (AF target) button (p. 37)



▶ (right) /
⚡ (flash) button (p. 37)

Operation guide

The symbols △ ▽ ◀ ▶ displayed for image selections and settings indicate that the wheel controller (see above) is to be used.

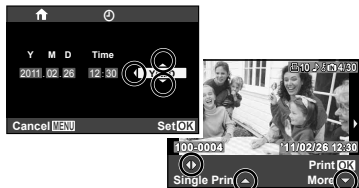

Operation guides displayed at the bottom of the screen indicate that the **MENU** button, **Ⓜ** button, or zoom lever should be used.

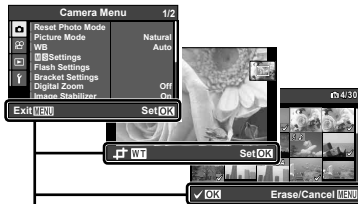

Operation guide

Using the Live Control

To display the live control, press \odot during shooting. The live control can be used to adjust shooting functions while previewing their effects in the monitor.

- ❗ The live control is not displayed in **AUTO** mode.
- ❗ See "Menus for Shooting Functions" (p. 7) for a list of the functions that can be adjusted.



Live control display

- 1 Press \odot to display the live control.
 - 2 Use Δ ∇ to select a function and \leftarrow \rightarrow to highlight options, then press \odot to choose the highlighted option.
 - The highlighted option takes effect when \odot is pressed or if no operations are performed for a short time.
- ❗ Some menu items may not be available at certain combinations of settings or in some shooting modes.

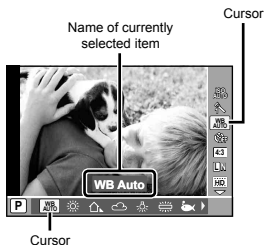

Using the Menus

The menu can be used to adjust a variety of settings.

Press the **MENU** button during shooting or playback to display the menus. The menu provide access to a variety of shooting and playback functions as well as to other camera settings, including display options and the time and date.

1 Press the MENU button.

- The menus are displayed.

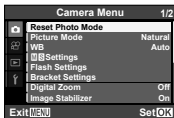

2 Press < to highlight the page tabs. Use Δ ∇ to select the desired page tab and press >.

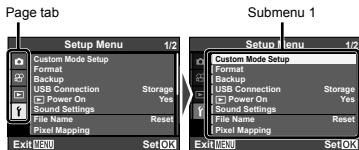

3 Use Δ ∇ to select the desired option in submenu 1 and then press OK.



4 Use Δ ∇ to select the desired option in submenu 2 and then press OK.

- Once a setting is selected, the display returns to the previous screen.
- ! There may be additional operations. "Menu Settings" (p. 45 to 63)



5 Press the MENU button to complete the setting.

Menu Index

Menus for Shooting Functions



Live control

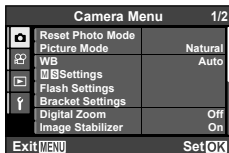

Camera menu



Movie menu

ISO	p. 39	Flash	p. 37
Picture mode	p. 39	Flash compensation	p. 43
White balance	p. 40	Metering	p. 43
Sequential shooting/ Self-timer	p. 38	ND filter	p. 44
Aspect ratio	p. 41	AF mode	p. 36
Image size (still images)	p. 41	Face priority	p. 44
Frame size (movies)	p. 42		

Reset Photo Mode	p. 45	⏏ (conversion lens)	p. 49
Picture Mode	p. 45	AF Illuminat.	p. 50
WB	p. 46	Rec View	p. 50
M S Settings	p. 47	Info Off	p. 50
Flash Settings	p. 48	Panorama	p. 51
Bracket Settings	p. 48		
Digital Zoom	p. 49		
Image Stabilizer	p. 49		

Movie Resolution	p. 51
🎤 (movies)	p. 51

Menus for Playback, Editing, and Printing Functions

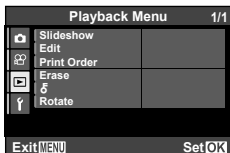

Playback menu

Slideshow	p. 52
Edit	p. 52, 54
Print Order	p. 55
Erase	p. 55
Ⓜ (Protect)	p. 56
Rotate	p. 56

Menus for Other Camera Settings

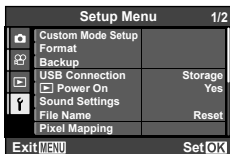

Setup menu

Custom Mode Setup	p. 57	Pixel Mapping	p. 59
Memory Format/Format	p. 57	Ⓜ (Monitor)	p. 59
Backup	p. 57	TV Out	p. 60
USB Connection	p. 58	Sleep	p. 62
Power On	p. 58	Ⓜ (Language)	p. 62
Sound Settings	p. 58	⌚ (Date/time)	p. 62
File Name	p. 59	World Time	p. 63

Names of Parts

Camera unit

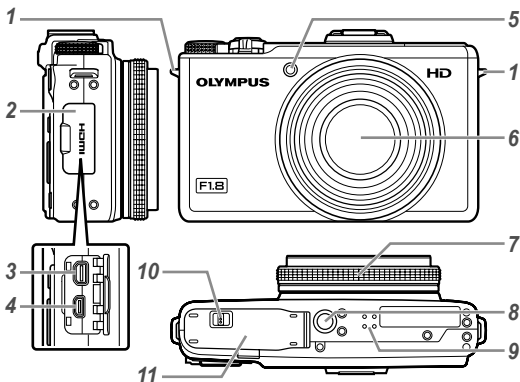

- 1 Strap eyelet..... p. 13
- 2 Connector cover p. 15, 17, 60, 61, 64
- 3 Multi-connector p. 15, 17, 60, 64
- 4 HDMI micro connector p. 61
- 5 Self-timer lamp..... p. 38
AF illuminator..... p. 50
- 6 Lens p. 76, 91
- 7 Control ring p. 27, 29, 30
- 8 Tripod socket
- 9 Speaker
- 10 Battery/card compartment lock p. 13
- 11 Battery/card compartment cover..... p. 13

The Control Ring

Rotate the control ring to adjust settings during shooting.



Shooting mode	Affected setting
P / A	ISO sensitivity
A / M	Aperture
S	Shutter speed
SCN	Scene mode
ART	Art filter mode
C	Same as original shooting mode

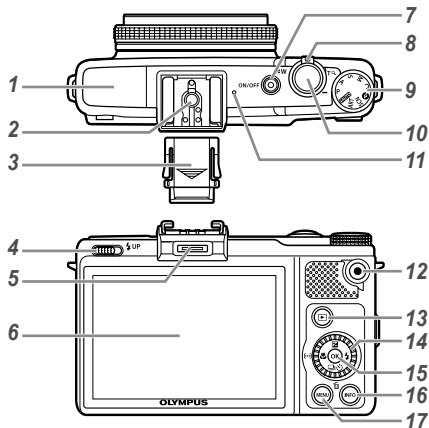

- | | | | |
|--|---------------|--|---------------------------|
| 1 Flash..... | p. 37, 43, 48 | 14 Wheel controller..... | p. 4 |
| 2 Hot shoe..... | p. 80 | ☒ (exposure compensation) button..... | p. 38 |
| 3 Hot shoe cover | | 📷⌚ (sequential shooting/Self-timer) | |
| 4 Flash switch..... | p. 37 | button..... | p. 38 |
| 5 Accessory port..... | p. 80, 81 | 🗑️ button (erase)..... | p. 25 |
| 6 Monitor..... | p. 20, 59, 71 | 🌸 (macro) button..... | p. 36 |
| 7 ON/OFF button..... | p. 18, 20 | [•••] (AF target) button..... | p. 37 |
| Indicator lamp..... | p. 14, 15, 17 | ⚡ (flash) button..... | p. 37 |
| 8 Indicator lamp..... | p. 22, 26 | 15 Ⓞ button (OK)..... | p. 4, 5 |
| 9 Mode dial..... | p. 3 | 16 INFO button (change information display) | |
| 10 Shutter button..... | p. 21 | | p. 23, 26, 36, 38, 40, 44 |
| 11 Microphone..... | p. 51, 54 | 17 MENU button..... | p. 6 |
| 12 📺 button (record movies)..... | p. 21 | | |
| 13 ▶️ button (switch between shooting and | | | |
| playback)..... | p. 21, 23 | | |

Shooting mode display



- | | | | |
|---|-----------|--|---------------|
| 1 Battery check..... | p. 18 | 17 Number of storable pictures (still images) | |
| 2 Writing data to card..... | p. 78 | | p. 20, 79 |
| 3 Image stabilization..... | p. 49 | 18 Current memory..... | p. 78 |
| 4 Flash (RC)..... | p. 80 | 19 Top: Flash compensation indicator..... | p. 43 |
| 5 Conversion lens..... | p. 49, 81 | Bottom: Exposure compensation indicator... p. 38 | |
| 6 World time..... | p. 63 | 20 Exposure compensation..... | p. 38 |
| 7 AF target mark..... | p. 21, 37 | 21 Aperture value..... | p. 21, 29, 30 |
| 8 Histogram..... | p. 23 | 22 Shutter speed..... | p. 21, 29, 30 |
| 9 ISO..... | p. 39 | 23 Shooting mode..... | p. 3, 28 |
| 10 Picture mode..... | p. 39 | 24 Face priority..... | p. 44 |
| 11 White balance..... | p. 40 | 25 AF mode..... | p. 36 |
| 12 Sequential shooting/Self-timer..... | p. 38 | 26 ND filter..... | p. 44 |
| BKT..... | p. 48 | 27 Metering..... | p. 43 |
| 13 Aspect ratio..... | p. 41 | 28 Flash compensation..... | p. 43 |
| 14 Image size (still images)..... | p. 41 | 29 Flash..... | p. 37 |
| 15 Frame size (movies)..... | p. 42 | Flash standby/flash charge..... | p. 71 |
| 16 Continuous recording length (movies)..... | p. 79 | | |

Playback mode display

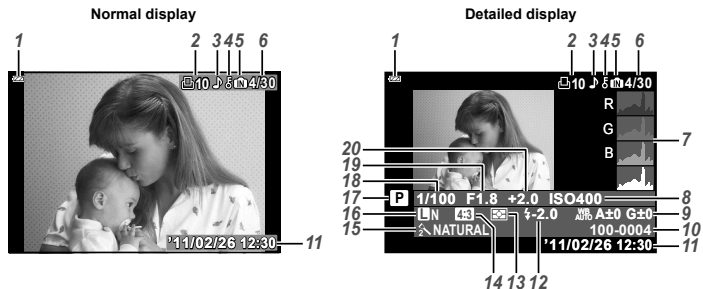

- | | |
|--|--|
| 1 Battery check..... p. 18 | 10 File number |
| 2 Print reservation/number of prints..... p. 68/p. 66 | 11 Date and time p. 18 |
| 3 Adding sound..... p. 51, 54 | 12 Flash compensation..... p. 43 |
| 4 Protect p. 56 | 13 Metering..... p. 43 |
| 5 Current memory..... p. 78 | 14 Aspect ratio..... p. 41 |
| 6 Frame number/total number of images (still images)..... p. 23 | 15 Picture mode..... p. 39 |
| Elapsed time/total recording time (movies)... p. 24 | 16 Image size (still images)..... p. 41 |
| 7 Histogram p. 23 | Frame size (movies)..... p. 42 |
| 8 ISO..... p. 39 | 17 Shooting mode..... p. 3 |
| 9 White balance p. 40 | 18 Shutter speed p. 21, 29, 30 |
| White balance compensation..... p. 47 | 19 Aperture value p. 21, 29, 30 |
| | 20 Exposure compensation p. 38 |

Preparing the Camera

Attaching the camera strap and lens cap

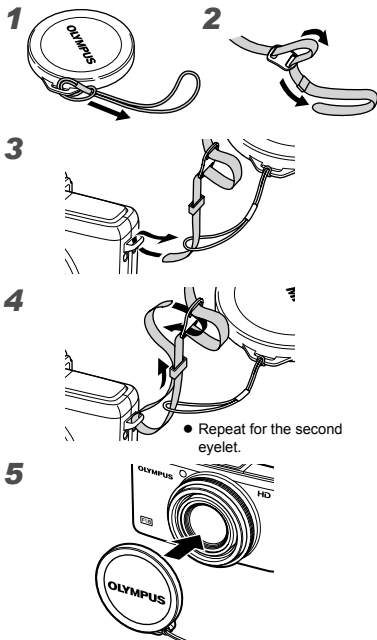

- ⚠ Pull the strap tight so that it does not come loose.

Inserting the battery and the SD/SDHC/SDXC memory card (sold separately)

- ⚠ Use only SD, SDHC, or SDXC memory cards with this camera. Do not insert any other types of memory card.

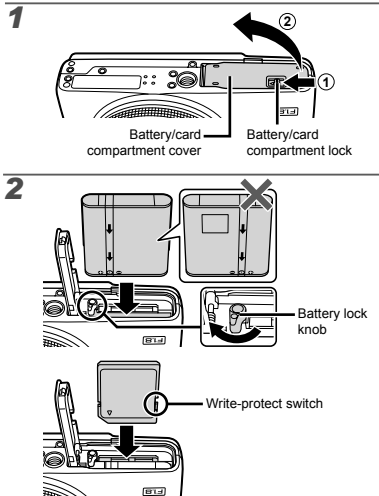

- ❗ Insert the battery as shown, with the \oplus terminal toward the battery lock knob. Damage to the battery exterior (scratches, etc.) may produce heat or an explosion.
- ❗ Insert the battery while sliding the battery lock knob in the direction of the arrow.
- ❗ Slide the battery lock knob in the direction of the arrow to unlock, and then remove the battery.
- ❗ Turn off the camera before opening the battery/card compartment cover.
- ❗ When using the camera, be sure to close the battery/card compartment cover.
- ❗ Insert the card straight until it clicks into place.
- ❗ Do not touch the card contact area directly.

3

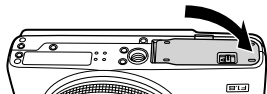

- ❗ This camera allows the user to take pictures using the internal memory even when no SD/SDHC/SDXC memory card (sold separately) is inserted. "Using an SD/SDHC/SDXC memory card" (p. 77)
- ❗ "Number of storable pictures (still images)/Continuous recording length (movies) in the internal memory and SD/SDHC/SDXC memory cards" (p. 79)

To remove the SD/SDHC/SDXC memory card

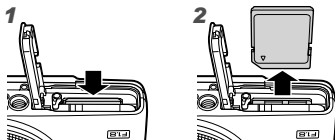

- ❗ Press the card in until it clicks and comes out slightly, then grab the card and pull it out.

Charging the battery and setting up using the supplied CD

Connect the camera to the computer to charge the battery and use the supplied CD for setup.

- ❗ User registration using the supplied CD and installation of [ib] computer software is available on Windows computers only.
- The camera battery can be charged while the camera is connected to a computer.
- The indicator lamp lights during charging and turns off when charging is complete.
- ❗ Charging takes up to 3 hours.
 - ❗ If the indicator lamp does not light, the camera is not correctly connected or the battery, camera, computer, or USB cable may not be functioning as expected.
 - ❗ We recommend that you use a computer equipped with Windows XP (Service Pack 2 or later), Windows Vista, or Windows 7. See "Charging the battery with the supplied USB-AC adapter" (p. 17) if you are using a different computer or wish to charge the battery without using a computer.

Windows

1 Insert the supplied CD in a CD-ROM drive.

Windows XP

- A "Setup" dialog will be displayed.

Windows Vista/Windows 7

- An Autorun dialog will be displayed. Click "OLYMPUS Setup" to display the "Setup" dialog.



- ! If the "Setup" dialog is not displayed, select "My Computer" (Windows XP) or "Computer" (Windows Vista/Windows 7) from the start menu. Double-click the CD-ROM (OLYMPUS Setup) icon to open the "OLYMPUS Setup" window and then double-click "Launcher.exe".
- ! If a "User Account Control" dialog is displayed, click "Yes" or "Continue".

2 Follow the on-screen instructions on your computer.

- ! If nothing is displayed on the camera screen even after connecting the camera to the computer, the battery may be exhausted. Leave the camera connected to the computer until the battery has charged, then disconnect and reconnect the camera.

Connecting the camera

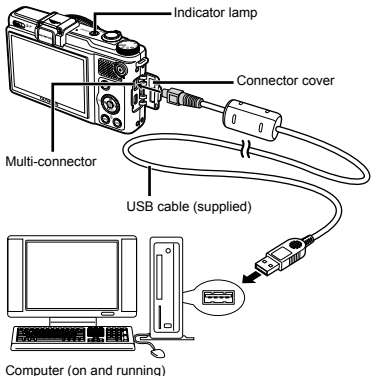

3 Register your Olympus product.

- Click the "Registration" button and follow the on-screen instructions.

4 Install OLYMPUS Viewer 2 and [ib] computer software.

- Check the system requirements before beginning installation.
- Click the "OLYMPUS Viewer 2" or "OLYMPUS ib" button and follow the on-screen instructions to install the software.

OLYMPUS Viewer 2

Operating System	Windows XP (Service Pack 2 or later)/ Windows Vista/Windows 7
Processor	Pentium 4 1.3 GHz or better
RAM	1 GB or more (2 GB or more recommended)
Free Hard Drive Space	1 GB or more
Monitor Settings	1024 × 768 pixels or more Minimum 65,536 colors (16,770,000 colors recommended)

[ib]

Operating System	Windows XP (Service Pack 2 or later)/ Windows Vista/Windows 7
Processor	Pentium 4 1.3 GHz or better (Pentium D 3.0 GHz or better required for movies)
RAM	512 MB or more (1 GB or more recommended) (1 GB or more required for movies—2 GB or more recommended)
Free Hard Drive Space	1 GB or more
Monitor Settings	1024 × 768 pixels or more Minimum 65,536 colors (16,770,000 colors recommended)
Graphics	A minimum of 64 MB video RAM with DirectX 9 or later.

* See online help for information on using the software.

5 Install the camera manual.

- Click the "Camera Instruction Manual" button and follow the on-screen instructions.

Macintosh

1 Insert the supplied CD in a CD-ROM drive.

- Double-click the CD (OLYMPUS Setup) icon on the desktop.
- Double-click the "Setup" icon to display the "Setup" dialog.



2 Install OLYMPUS Viewer 2.

- Check the system requirements before beginning installation.
- Click the "OLYMPUS Viewer 2" button and follow the on-screen instructions to install the software.

OLYMPUS Viewer 2

Operating System	Mac OS X v10.4.11-v10.6
Processor	Intel Core Solo/Duo 1.5 GHz or better
RAM	1 GB or more (2 GB or more recommended)
Free Hard Drive Space	1 GB or more
Monitor Settings	1024 × 768 pixels or more Minimum 32,000 colors (16,770,000 colors recommended)

* Other languages can be selected from the language combo box. For information on using the software, see online help.

3 Copy the camera manual.

- Click the "Camera Instruction Manual" button to open the folder containing the camera manuals. Copy the manual for your language to the computer.

Charging the battery with the supplied USB-AC adapter

- ! The included F-2AC USB-AC adapter (with an AC cable or plug-in type; hereafter referred to as USB-AC adapter) differs depending on the region where you purchased the camera. If you received a plug-in type USB-AC adapter, plug it directly into an AC outlet.
- ! The supplied USB-AC adapter is for charging and playback only. Do not take pictures while the USB-AC adapter is connected.

Example: USB-AC adapter with an AC cable

1

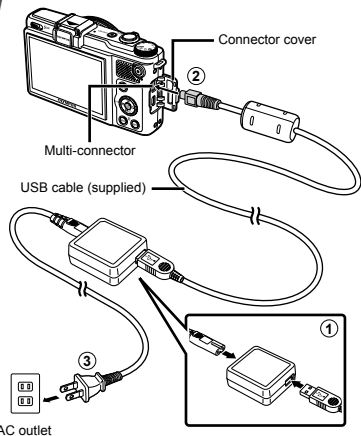

2

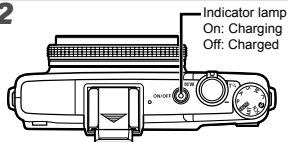

- ❗ The battery is not fully charged at the time of purchase. Before use, be sure to charge the battery until the indicator lamp turns off (up to 3 hours).
- ❗ If the indicator lamp does not light, the camera is not correctly connected or the battery, camera, or USB-AC adapter may not be functioning as expected.
- ❗ For details on the battery and the USB-AC adapter, see "The battery and USB-AC adapter" (p. 76).
- ❗ The battery can be charged while the camera is connected to the computer. Charging time varies depending on the performance of a computer. (There may be cases in which it takes approx. 10 hours.)

When to charge the batteries

Charge the battery when the error message shown below appears.

Flashes in red



Monitor top left



Error message

Date, time, time zone, and language

The date and time set here are saved to image file names, date prints, and other data. You can also choose the language for the menus and messages displayed in the monitor.

1 Press the ON/OFF button to turn on the camera.

- The date and time setting screen is displayed when the date and time are not set.

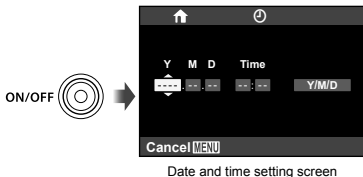

2 Use Δ / ∇ to select the year for [Y].

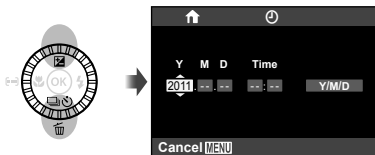

3 Press \triangleright to save the setting for [Y].

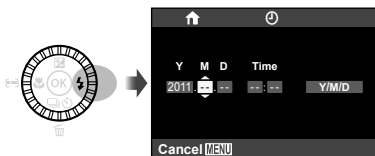

4 As in Steps 2 and 3, use $\triangle \nabla \langle \triangleright$ to set [M] (month), [D] (day), [Time] (hours and minutes), and [Y/M/D] (date order).

- ! For a more accurate setting, press \ominus when the time signal hits 00 seconds while setting the minutes.
- ! The menus can be used to change the selected date and time. [Ⓣ] (Date/time) (p. 62)

5 Use $\langle \triangleright$ to select your home time zone and press \ominus .

- Use $\triangle \nabla$ to turn daylight saving time ([Summer]) on or off.

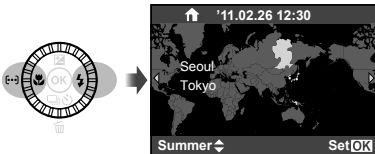

- ! The menus can be used to change the selected time zone. [World Time] (p. 63)

6 Use $\triangle \nabla \langle \triangleright$ to select your language and press \ominus .

- ! The language can be changed from the menus. [🗣️] (Language) (p. 62)

Shooting, Viewing, and Erasing

Shooting with the optimum aperture value and shutter speed [Program Auto]

In this mode, automatic shooting settings are activated while also allowing changes to a wide range of other shooting menu functions, such as exposure compensation, white balance, etc. as needed.

- 1 Remove the lens cap.
- 2 Rotate the mode dial to P and press the ON/OFF button to turn on the camera.

Number of storable still pictures (p. 79)



[Program Auto]
indicator



Monitor (standby mode screen)

- 1 Press the ON/OFF button again to turn off the camera.

- 3 Hold the camera and compose the shot.

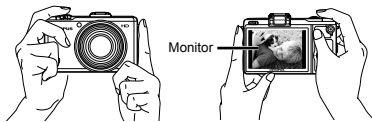

Horizontal grip

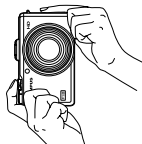

Vertical grip

- 1 When holding the camera, take care not to cover the flash with your fingers, etc.

4 Press the shutter button halfway down to focus on the subject.

- When the camera focuses on the subject, the exposure is locked (shutter speed and aperture value are displayed), and the AF target mark changes to green.
- The camera was unable to focus if the AF target mark flashes red. Try focusing again.

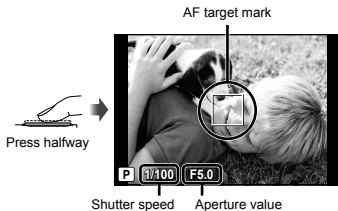



! "Focusing" (p. 73)

5 To take the picture, gently press the shutter button all the way down while being careful not to shake the camera.



To view images during shooting

Pressing the  button enables playback of images. To return to shooting, either press the  button or press the shutter button halfway down.

Shooting movies

1 Press the button to start recording.

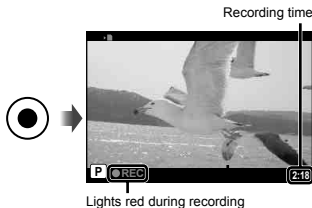

- The shooting mode selected for still photography applies to movies (some shooting modes have no effect).
- The camera may not correctly display the recording time in [Art Filter] mode (p. 34). Movies recorded in [AFS] (Diorama) mode play back at high speed; during recording, the recording time is adjusted to reflect the playback time and advances more slowly than usual.

2 Press the button again to end recording.

- Sound will also be recorded.

Using zoom

Use the zoom lever to frame the subject.

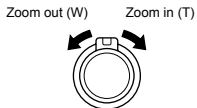



- Optical zoom: 4×
- Digital zoom: 4×

To take larger images [Digital Zoom]

- The type and amount of zoom can be identified from the appearance of the zoom bar. The display differs depending on the options selected for [Digital Zoom] (p. 49) and image size (p. 41).

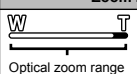
[Off] selected for [Digital Zoom]:

Image size	Zoom bar
3648×2736	
Other	

[On] selected for [Digital Zoom]:

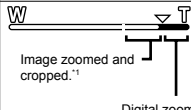
Image size	Zoom bar
3648×2736	
Other	

¹ If an image size is less than the full resolution after reaching the maximum optical zoom, the camera will automatically resize and crop the image to the selected image size and enter the digital zoom range if [Digital Zoom] is [On].

- Photographs taken with the zoom bar displayed in red may appear "grainy."

Changing the shooting information display

The display of the screen information can be changed to best match the situation, for example, the need for a clear view of the screen or for making a precise composition by using the grid display.

1 Press the INFO button.

- The displayed shooting information changes in the order shown below each time the button is pressed. "Shooting mode display" (p. 11)

Normal



No information



Detailed

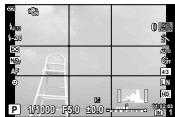

Reading a histogram

If the peak is too far toward this part of the frame, photos will be mostly too bright.

If the peak is too far toward this part of the frame, photos will be mostly too dark.

The green area shows the distribution of brightness at the center of the frame.

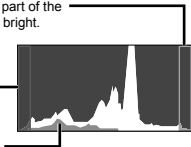

Viewing images

1 Press the button.

Number of frames/Total number of images



Playback image

2 Use the wheel controller to select an image.

- You can also use  .



- ! Keep rotating the wheel controller to scroll rapidly forward or backward through images. You can also keep  pressed.

- ! The display size of the images can be changed. "Index view and close-up view" (p. 26)

To play sound recordings

To play sound recorded with an image, select the image and press . A icon appears on images with which sound has been recorded.

(still images) (p. 54)



During audio playback

To play back movies

Select a movie and press .



Movie

Operations during movie playback

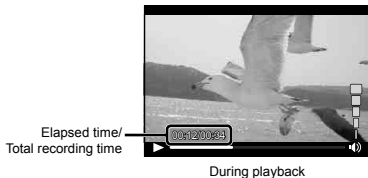

Pausing and resuming playback	Press to pause playback. To resume playback during pause, fast forward, or rewind, press .
Fast forward	Press to fast forward. Press again to increase the fast forward speed.
Rewind	Press to rewind. The rewinding speed increases each time is pressed.
Adjusting the volume	Use the wheel controller or to adjust the volume.

Operations during pausing playback



During pause

Cueing	Press Δ to display the first frame and press ∇ to display the last frame.
Advancing and rewinding one frame at a time	<ul style="list-style-type: none">• Using the wheel controller Rotate the wheel controller to advance or rewind a frame at a time. Keep turning the wheel controller for continuous advance or rewind.• Using \triangleleft \triangleright Press \triangleright or \triangleleft to advance or rewind one frame at a time. Keep \triangleright or \triangleleft pressed for continuous advance or rewind.
Resuming playback	Press \odot to resume playback.

To stop movie playback

Press the MENU button.

Erasing images during playback (Single image erase)

- 1 Display the image you want to erase and press ∇ (🗑).

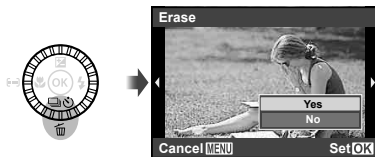

- 2 Use Δ ∇ to highlight [Yes] and press \odot .
⚠ [All Erase] (p. 55) and [Sel. Image] (p. 55) can be used to erase multiple images at the same time.

Index view and close-up view

Index view enables quick selection of a desired image. Close-up view (up to 10× magnification) allows checking of image details.

1 Rotate the zoom lever.



Zoom out (W) Zoom in (T)

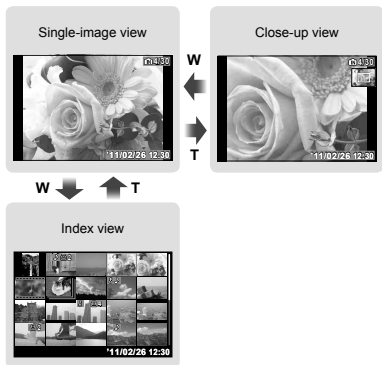

To select an image in index view

Use Δ ∇ \triangleleft \triangleright to select an image, and press \odot to display the selected image in single-image view.

To scroll an image in close-up view

Use Δ ∇ \triangleleft \triangleright to move the viewing area.

Changing the image information display

Shooting information settings displayed on the screen can be changed.

1 Press the INFO button.

- The displayed image information changes in the order shown below each time the button is pressed.

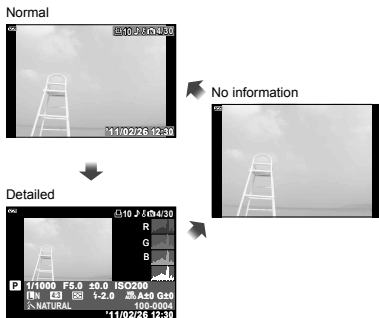

"Reading a histogram" (p. 23)

Viewing a series of images

Only the first image in each series shot with the following functions is displayed.

[Sequential], [High-Speed1], [High-Speed2]

1 Display the first image in the series.

! "Viewing images" (p. 23)



First image in series

Automatic playback

Press **OK** to start automatic playback of all the images in the current series.

Index view

Use the control ring to switch between index and normal views.

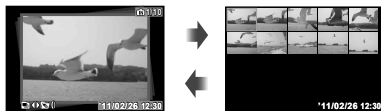

! Changes to [5 (Protect)] (p. 56), [Rotate] (p. 56), [Print Order] (p. 55) and [Erase] (p. 55) made when the first frame is displayed apply to all images in the series. Select index view to apply changes to individual frames.

Viewing panoramas

You can pan across panoramas created using [Auto] or [Manual].

! "Creating panoramic images ([Panorama])" (p. 32)

1 Display a panorama image during playback.

! "Viewing images" (p. 23)



2 Press **OK**.



Current viewing area

Controls for panorama playback

Zoom in/zoom out: Press **OK** to pause playback, then use the zoom lever to zoom in and out.

Pan direction: Press **Δ** **▽** **◀** **▶** to pause playback and pan the image in the selected direction.

Pause: Press **OK**.

Resume: Press **OK**.

End playback: Press the **MENU** button.

Using Shooting Modes

To change the shooting mode

- ❗ The shooting mode (FAUTO, P, A, S, M, C, Q, SCN, ART) can be selected using the mode dial. "Mode dial" (p. 3)
- ❗ The default settings of the function are highlighted in .

Shooting with automatic settings (FAUTO iAUTO)

According to the scene, the camera automatically selects the optimal shooting mode from [Portrait]/[Landscape]/[Night+Portrait]/[Sport]/[Macro]/[Low Light]. This is a fully automatic mode that allows the user to take pictures using the best mode for the shooting scene simply by pressing the shutter button.

1 Rotate the mode dial to FAUTO.



The icon changes depending on the scene that the camera automatically selects.

- ❗ In some cases, the camera may not select the desired shooting mode.
- ❗ When the camera cannot identify which is the optimal mode, [Program Auto] will be selected.
- ❗ There are some limitations on settings in FAUTO mode.

Using the live guide

The live guide can be used to change settings in FAUTO mode.

Guide items

- Change Color Saturation
- Change Color Image
- Change Brightness
- Blur Background
- Shooting Tips

- 1 Press OK to display the live guide.
- 2 Use Δ / ∇ to highlight an item and press OK.

Guide item



- 3 Use Δ / ∇ to choose a level and check the effect or description.
 - Press the shutter button halfway to select.

Level bar



- ④ Press the shutter button to take a picture.
 - To clear the live guide from the display, press the **MENU** button.
- ! **L/N+RAW** is automatically selected when a RAW option is chosen using the live guide.
- ! Live guide settings are not applied to RAW images.
- ! Pictures may appear grainy at some live guide setting levels.
- ! Changes to live guide setting levels may not be visible in the monitor.
- ! The flash can not be used with the live guide.
- ! Changes to live guide options cancel previous changes.
- ! Choosing live guide settings that exceed the limits of the camera exposure meters may result in pictures that are over- or under-exposed.

Choosing aperture (A Aperture Priority)

In mode **A**, you choose the aperture and let the camera automatically adjust shutter speed for optimal exposure.

- 1** Rotate the mode dial to **A**.
- 2** Use the control ring to choose the aperture.

Aperture value



- ! If the picture is over- or under-exposed, the aperture is displayed in red.

Choosing shutter speed (S Shutter Priority)

In mode **S**, you choose the shutter speed and let the camera automatically adjust aperture for optimal exposure.

- 1** Rotate the mode dial to **S**.
- 2** Use the control ring to choose the shutter speed.

Shutter speed



- ! If the picture is over- or under-exposed, the shutter speed is displayed in red.

Choosing aperture and shutter speed (M Manual Shooting)

In mode **M**, you choose both the aperture and the shutter speed. At a speed of **BULB**, the shutter remains open while the shutter button is pressed.

- 1 Rotate the mode dial to **M**.
- 2 Use the control ring to choose the aperture.

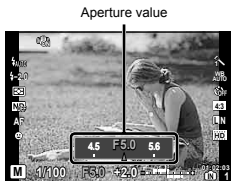

- 3 Press Δ and use the wheel controller to choose the shutter speed, and then press \odot .
 - The shutter speed can be set to 1/2000–60 sec. or [BULB].



Shutter speed

- ❗ Exposure compensation is not available in **M** mode.
- ❗ If the picture is over- or under-exposed, the aperture or shutter speed is displayed in red.

Recalling saved settings (C Custom Mode Setup)

Mode **C** is used to take pictures using custom settings saved using the [Custom Mode Setup] (p. 57) option in the setup menu.

- 1 Rotate the mode dial to **C**.
 - ❗ Exposure compensation is not available in **C** mode.

Taking pictures under low light (\odot Low Light)

Use \odot (low light) mode to take pictures under low light without a tripod.

- 1 Rotate the mode dial to \odot .

Using the best mode for the shooting scene (SCN Scene Mode)

1 Rotate the mode dial to SCN.



2 Use Δ ∇ to select the best shooting mode for the scene, and press \odot .



Icon indicating [Scene Mode] that is set

- ! In [Scene Mode], the optimum shooting settings are pre-programmed for specific shooting scenes. For this reason, some settings cannot be changed in some modes.

Option	Application
e-Portrait/Portrait/ Landscape/Night Scene/ Night+Portrait/Sport/ Indoor/Self Portrait/ Sunset*/Fireworks*/ Multi. Exposure/ Cuisine/ Documents/Beach & Snow/ Underwater Wide/ Underwater Macro/Pet/ Panorama	The camera takes a picture using the optimum settings for the scene conditions.

- * When the subject is dark, noise reduction is automatically activated. This approximately doubles the shooting time during which no other pictures can be taken.

- ! [e-Portrait] can not be applied to RAW images.
- ! When RAW or RAW+JPEG photos are taken using [e-Portrait], two images will be recorded: a RAW image and an M-quality (2560×1920) JPEG to which effects have been applied.
- ! When JPEG is set in [e-Portrait], two images are saved, one from before application of the effect (with set picture quality) and the other from after application of the effect (M (2560×1920)).

Taking a multiple exposure ([Multi. Exposure] mode)

- Use Δ ∇ to highlight [Multi. Exposure] and press \odot .
- Press the shutter button to take the first exposure.
 - The first exposure is displayed in the background.
- To retake the first exposure, press the **MENU** button and then press the shutter button again.
- Frame the next exposure against the background of the first and press the shutter button.
 - This creates the multiple exposure.

To take underwater photos

Select [🐟 Underwater Wide] or [🐟 Underwater Macro].

⚠ Use a waterproof case when shooting underwater.

To lock the focus distance for underwater shoots (AF lock)

When [🐟 Underwater Wide] or [🐟 Underwater Macro] is selected, press ▾.

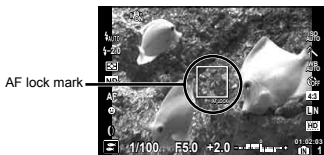

⚠ To cancel, press ▾ again to clear the AF lock mark.

To take pictures of a moving subject like a pet ([🐕 Pet])

- 1 Use Δ ▾ to select [🐕 Pet], and press \odot to set.
- 2 Frame a picture with the subject positioned in the AF target mark and press the shutter button halfway.
 - When the camera recognizes the subject, the AF target mark automatically tracks the subject movement to focus on it continuously. "Continuous focus on moving subjects [AF Tracking]" (p. 36)

Creating panoramic images

([🌄 Panorama])

- 1 See "Panorama options" (p. 51) for information on adjusting settings for panoramas.
- 2 Use Δ ▾ to highlight [🌄 Panorama] and press \odot .

Taking pictures using [Auto]

- 1 Press the shutter button to take the first shot.
- 2 Move the camera slightly in the direction of the second shot.

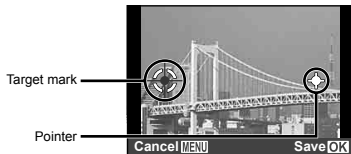

Screen when combining images from left to right

- 3 Move the camera slowly while keeping it straight, and stop the camera where the pointer and target mark overlap.
 - The camera releases the shutter automatically.



- 4 To combine only two shots, press \odot before taking a third shot.

- ④ Repeat Step ③ to take a third shot.
- After the third shot is taken, the camera automatically processes the shots and the combined panorama image is displayed.
- ! To exit without creating a panorama, press the **MENU** button.
- ! If the shutter does not automatically release, try [Manual] or [PC].

Taking pictures with [Manual]

- ① Use <D> to specify at which edge the next picture is to be connected.



- ② Press the shutter button to take the first shot.

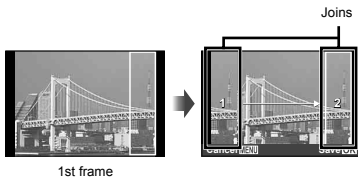

- ③ Compose the next shot so that join 1 overlaps join 2.



Framing the second shot

- ④ Press the shutter button to take the next shot.
- ! To combine only two shots, press **Ⓜ** before taking the third shot.
- ⑤ Repeat steps ③ and ④ to take a third shot.
- After the third shot is taken, the camera automatically processes the shots and the combined panorama image is displayed.
- ! To exit without creating a panorama, press the **MENU** button.

Taking pictures using [PC]

- 1 Use $\Delta \nabla \triangleleft \triangleright$ to select a pan direction.
- 2 Press the shutter button to take the first shot, and then compose the second shot.

Before first shot



After first shot



- After the first shot, the area shown in white reappears on the side of the display opposite the pan direction. Frame subsequent photographs so that they overlap with the image in the monitor.
- 3 Repeat Step 2 until the desired number of shots is taken, and then press the \odot or MENU button.
- ! Panoramas can include up to 10 shots.
 - ! See the on-line help for the computer application for information on creating panoramas.

Shooting with special effects (ART Art Filter)

Add an artistic effect to your photo by selecting the desired art filter.

- 1 Rotate the mode dial to ART.

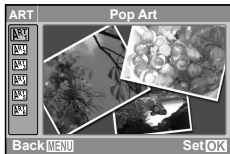

- 2 Use $\Delta \nabla$ to highlight the desired effect and press \odot .





Icon indicating [Art Filter] that is set

Shooting mode	Option
Art Filter	<ul style="list-style-type: none"> ❶ Pop Art ❷ Soft Focus ❸ Grainy Film ❹ Pin Hole ❺ Diorama ❻ Dramatic Tone

- ❗ In [Art Filter], the optimum shooting settings are pre-programmed for each scene effect. For this reason, some settings cannot be changed in some modes.
- ❗ If RAW is selected for the record mode when the camera enters art filter mode, the record mode will automatically be set to **L/N+RAW**.
- ❗ Art filter effects are not applied to RAW images.
- ❗ Some art filters may produce "grainy" images.



Using Shooting Functions

 The default settings of the function are highlighted in .

Choosing a focus mode/ shooting close-ups

Choose how the camera focuses. Choose a macro mode to focus at short ranges when shooting close-ups.

1 Press  () and then press the **INFO** button.

2 Use  to highlight an option and press  to select.

- To view the AF target display, press the **INFO** button.

Option	Description
AF	When the shutter button is pressed halfway, the camera focuses once and then locks focus. Once the camera has focused, a beep sounds and the AF confirmation mark and the AF target mark light.
Macro	This enables shooting as close as 10 cm/3.9 in. ¹⁾ (30 cm/11.8 in. ²⁾ to the subject.
Super Macro ³⁾	This enables shooting as close as 1 cm/2.5 in. to the subject.
AF Tracking	The camera focuses continuously to track moving objects.
MF	Focus manually at the desired distance.

¹⁾ When the zoom is at the widest (W) position.

²⁾ When the zoom is at the most telephoto (T) position.

³⁾ The zoom is automatically fixed.



 The flash (p. 37) and zoom (p. 22) cannot be set during super macro shooting.

Continuous focus on moving subjects [AF Tracking]

- ① Frame a picture with the subject positioned in the AF target mark and press the shutter button halfway.
- ② Once the camera has detected the subject, the AF target mark automatically tracks the subject and the camera continuously adjusts focus while the shutter button is pressed halfway.
- ③ To cancel AF tracking, release the shutter button.

 Depending on the subject or shooting conditions, the camera may be unable to lock focus or track subject movement.

Zooming in on the focus point [MF]

- ① Press the **INFO** button to zoom in on the center of the display.
- ② Use the wheel controller to focus manually.
 -   can be used in place of the wheel controller.
- ③ To cancel manual focus, press the **INFO** button.

Choosing a focus target

Position the AF target mark to focus on subjects that are not at the center of the frame.

- 1 Press \triangleleft ([L••]) to view the AF target display.
- 2 Use \triangle ∇ \triangleleft \triangleright to highlight an AF target and press \odot to select.
 - Moving the cursor outside the AF targets selects all targets.

If all targets are surrounded by a green frame

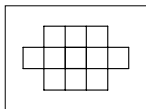

The camera automatically selects from the 11 focus targets.

If one target is surrounded by a green frame

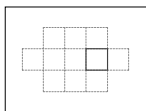

The camera will focus on the subject in the selected focus target.

Using the flash

The flash functions can be selected to best match the shooting conditions.

- 1 Slide the flash switch to raise the flash.
- 2 Press \triangleright (⚡) to display flash options.
- 3 Use \triangleleft \triangleright to highlight an option and press \odot to select.

Option	Description
Flash Auto	The flash fires automatically in low-light or backlight conditions.
Redeye	Pre-flashes are emitted to reduce the occurrence of red eye in your photos.
Fill In	The flash fires regardless of the available light.
Red-Eye + Fill-In	The flash emits pre-flashes to reduce red-eye before firing. The flash fires with every shot.
Flash Off	The flash does not fire.
Full	For users who prefer manual operation. Flash output is expressed as a fraction of full power: full, 1/4, 1/16, or 1/64.
1/4	
1/16	
1/64	



-  The flash may not be available at certain camera settings.

Sequential shooting/using the self timer

The camera takes photos while the shutter button is pressed all the way down. Alternatively, the self-timer can be used for self- or group-portraits or to reduce camera shake when the camera is mounted on a tripod or otherwise fixed in place.



1 Press ∇ () to display drive options.

2 Use $\triangleleft \triangleright$ to highlight an option and press \odot to select.

Option	Description
Single	One frame is shot each time the shutter button is pressed.
Sequential ^{*1}	Take sequential shots using the focus, brightness (exposure) and white balance for the first frame.
High-Speed1	The camera takes sequential shots at a faster speed than in [Sequential].
High-Speed2	The camera takes sequential shots at a faster speed than in [High-Speed1].
BKT ^{*2}	Sequential shooting that automatically varies settings for each frame (bracketing).
 12 sec	The self-timer lamp turns on for approx. 10 seconds, then blinks for approx. 2 seconds, and then the picture is taken.
 2 sec	The self-timer lamp blinks for approx. 2 seconds, and then the picture is taken.

^{*1} Frame rate varies with image size (p. 41).

^{*2} Bracketing is available when [AE-BKT] or [WB-BKT] is selected for [Bracket Settings] (p. 48).

-  Red-eye reduction (p. 37) is not available at a setting of [Sequential]. The flash turns off automatically when [High-Speed1] or [High-Speed2] is selected.
-  Image size is fixed at 2560 × 1920 and ISO sensitivity is fixed at [ISO Auto] when [High-Speed1] or [High-Speed2] is selected.
-  Self-timer shooting is automatically canceled after one shot.

To cancel the self-timer after it starts

Press the MENU button.

Adjusting the brightness (exposure compensation)

The standard brightness (appropriate exposure) set by the camera based on the shooting mode (except for **FAUTO**, **M**, **SCN**) can be adjusted brighter or darker to obtain a desired shot.

1 Press \triangle () to display exposure compensation options.

2 Use $\triangleleft \triangleright$ to choose the value and press \odot to select.

Brightening the monitor

To temporarily boost to monitor brightness, press and hold the INFO button. Brightness returns to normal if no operations are performed for 10 seconds.

Selecting the ISO sensitivity

- 1 Press **OK** to display the live control and use **Δ**/**∇** to highlight ISO sensitivity.



- 2 Use **◀**/**▶** to highlight an option and press **OK** to select.

Option	Description
ISO Auto	The camera automatically adjusts the sensitivity according to the shooting scene.
Value	The ISO sensitivity is fixed to the selected value.

- !** In the ISO setting, although smaller values result in less sensitivity, sharp images can be taken under fully lit conditions. Larger values result in higher sensitivity, and images can be taken at fast shutter speeds even under low light conditions. However, high sensitivity introduces noise into the resulting picture, which may give it a grainy appearance.

Processing options

Select a picture mode and make individual adjustments to contrast, sharpness, and other parameters. Changes to each picture mode are stored separately.

- 1 Press **OK** to display the live control and use **Δ**/**∇** to highlight picture mode.

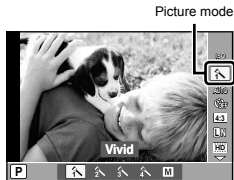

- 2 Use **◀**/**▶** to highlight an option and press **OK** to select.

Option	Description
Vivid	Produces vivid colors.
Natural	Produces natural colors.
Muted	Produces flat tones.
Portrait	Produces beautiful skin tones.
Monotone	Produces black and white tone.

Making separate adjustments to settings

Highlight an option in the shooting menu and press **▶** to display additional parameters. [Picture Mode] (p. 45).

Adjusting to a natural color scheme (white balance)

For more natural coloring, choose a white balance option suited to the scene.

- Press **[OK]** to display the live control and use **[△]**/**[▽]** to highlight white balance.



- Use **[<|>]** to highlight an option and press **[OK]** to select.

Option	Description
WB Auto	The camera automatically adjusts the white balance according to the shooting scene.
Sunny	For shooting outdoors under a clear sky.
Shadow	For photographing outdoor subjects in the shade on sunny days.
Cloudy	For shooting outdoors under a cloudy sky.
Incandescent	For shooting under tungsten lighting.
Fluorescent	For shooting under white fluorescent lighting (offices, etc.).
Underwater	For underwater photography.

Option	Description
One Touch	Choose when a white or gray subject can be used to measure white balance and the subject is under mixed lighting or lit by an unknown type of flash or other light source.

One-touch white balance

Measure white balance by framing a piece of paper or other white object under the lighting that will be used in the final photograph.

- After selecting [One Touch], press the **INFO** button.
- Frame a white object in the display.
 - Frame the object so that it fills the display and no shadows fall on it.
- Press the shutter button all the way down.
 - One-touch white balance options are displayed.
- Highlight [Yes] and press **[OK]**.
 - The value is saved as a preset white balance option.
 - The value is stored until a new value is measured and is not lost when the camera is turned off.

Making separate adjustments to settings

Highlight an option in the shooting menu and press **[>]** to display additional parameters. [WB] (p. 46)

Choosing the aspect ratio

Choose the aspect ratio (ratio of width to height) for new photographs. Choose from [4:3] (standard), [16:9], [3:2], or [6:6] according to your creative intent.

- 1 Press **OK** to display the live control and use **△**/**▽** to highlight the aspect ratio.

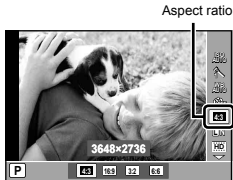

- 2 Use **△**/**▽** to highlight an option and press **OK** to select.

- ! JPEG images are cropped to the selected aspect ratio; RAW images, however, are not cropped but are instead saved with information on the selected aspect ratio.
- ! When RAW images are played back, the selected aspect ratio is shown by a frame.

Selecting the size of still images

- 1 Press **OK** to display the live control and use **△**/**▽** to highlight the image size.



- 2 Use **△**/**▽** to highlight an option and press **OK** to select.

Supported record modes

Choose from RAW and four JPEG modes. Choose a RAW+JPEG option to record both a RAW and a JPEG image with each shot.

Image size and recording options

JPEG modes combine image size (L, M, and S) and compression ratio (F and N).

Image size	Compression rate		Pixel count	Application
	F (Fine)	N (Normal)		
L (Large)	L ^F **	L ^N **	3648×2736	Choose according to the size at which the image will be printed.
M (Medium)	M ^F	M ^N **	3200×2400	
			2560×1920	
			1600×1200	
S (Small)	S ^F	S ^N **	1280×960	Choose for websites or images that will be printed at a small size.
			1024×768	
			640×480	

** Default.

- You can choose the dimensions and compression of M and S images. [M S Settings] (p. 47)

! "Number of storable pictures (still images)/Continuous recording length (movies) in the internal memory and SD/SDHC/SDXC memory cards" (p. 79)

Choosing a frame size for movies

- Press **OK** to display the live control and **△▽** to highlight the frame size.



- Use **<>** to highlight an option and press **OK** to select.

Option	Description
HD Quality	Record High Definition (HD) movies with a frame size of 1280 × 720.
SD Quality	Record standard definition movies with a frame size of 640 × 480.

Adjusting flash output

Flash output can be adjusted if you find that your subject to appears overexposed, or is underexposed even though the exposure in the rest of the frame is just right.

- 1 Press **OK** to display the live control and use **Δ**/**∇** to highlight flash compensation.



- 2 Use **Δ**/**∇** to choose the value and press **OK** to select.

- ! Flash compensation is not available with electronic flash units if MANUAL is selected as the flash control mode.
- ! The flash compensation value selected with the camera is added to the value currently with the electronic flash.



Choosing how the camera measures brightness (metering)

Choose how the camera meters subject brightness.

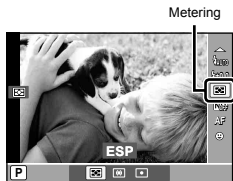
- 1 Press **OK** to display the live control and use **Δ**/**∇** to highlight metering.



- 2 Use **Δ**/**∇** to highlight an option and press **OK** to select.

Option	Description
 ESP	Choose for balanced exposure over the entire frame.
 Ctr-Weighted	Metering is averaged over the entire frame, with the greatest weight assigned to the area in the center.
 Spot	The camera meters the center of the frame.

- ! If [ESP] is selected when shooting against bright back lighting, the center of the frame may appear dark.

Using the neutral density (ND) filter

Use the camera's built-in neutral density filter to reduce the amount of light entering the camera for slower shutter speeds and wider apertures.

- 1 Press **OK** to display the live control and use **△▽** to highlight the ND filter.

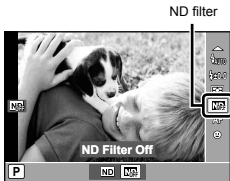

- 2 Use **◀▶** to highlight [ND Filter On] and press **OK** to select.

Using face priority



When face priority is on, the camera sets focus and exposure for the face shown by a frame.

- 1 Press **OK** to display the live control and use **△▽** to highlight face priority.





- 2 Use **◀▶** to highlight [Face Priority On] and press **OK** to select.
 - To view the AF target display, press the **INFO** button.
- 3 Point the camera at your subject.
 - If a face is detected, it will be indicated by a white border.
- 4 Press the shutter button halfway to focus.
 - When the camera focuses on the face in the white border, the border will turn green.
- 5 Press the shutter button the rest of the way down to shoot.
 - Face priority applies only to the first shot in each sequence taken during sequential shooting.
 - Depending on the subject, the camera may not be able to correctly detect the face.

Menus for Shooting Functions

 The default settings of the function are highlighted in .

Restoring the shooting functions to the default settings [Reset Photo Mode]

 (Camera menu) ► Reset Photo Mode

Submenu 2	Application
Yes	Restores the following menu functions to the default settings. <ul style="list-style-type: none"> • AF mode (p. 36) • Sequential shooting/Self-timer (p. 38) • Live control items (p. 39 to 44) • Menu functions in  (Camera menu)/ (Movie menu) (p. 45 to 51) • Flash (p. 37) • Exposure compensation (p. 38)
No	The current settings will not be changed.

Selecting the color tone of the image [Picture Mode]

 (Camera menu) ► Picture Mode

Submenu 2	Application
Vivid	Produces vivid colors.
Natural	Produces natural colors.
Muted	Produces flat tones.
Portrait	Produces beautiful skin tones.
Monotone	Produces black and white tones.

 This item can also be accessed from the live control. "Processing options" (p. 39)

Image processing options

Highlight an option in the shooting menu and press  to make adjustments to individual settings.

Submenu 3	Submenu 4	Application
Contrast	—	Adjust contrast.
Sharpness	—	Adjust sharpness.
Gradation	Auto/Normal/High Key/Low Key	Choose a tone range.
Saturation ¹	—	Adjust the vividness of colors.
B&W Filter ²	N:Neutral/Ye:Yellow/Or:Orange/ R:Red/G:Green	Take pictures in black and white. Colors in the original subject corresponding to the selected filter appear brighter in the black-and-white image, while complementary colors appear darker.
Pict. Tone ²	N:Neutral/S:Sepia/B:Blue/ P:Purple/G:Green	Choose a tint for monochrome images.



¹ [Monotone] not included.









² [Monotone] only.

 Changes to contrast have no effect at settings other than [Normal].

 These settings can not be adjusted using the live control.

Adjusting to a natural color scheme [WB]

 (Camera menu)  WB

Submenu 2	Application
 WB Auto	The camera automatically adjusts the white balance according to the shooting scene.
 Sunny	For shooting outdoors under a clear sky.
 Shadow	For photographing outdoor subjects in the shade on sunny days.
 Cloudy	For shooting outdoors under a cloudy sky.
 Incandescent	For shooting under tungsten lighting.
 Fluorescent	For shooting under white fluorescent lighting (offices, etc.).
 Underwater	For underwater photography.
 One Touch	Choose when a white or gray subject can be used to measure white balance and the subject is under mixed lighting or lit by an unknown type of flash or other light source.

 This item can also be accessed from the live control. "Adjusting to a natural color scheme (white balance)" (p. 40)

White balance compensation

White balance compensation can be used to fine-tune each of the preset white balance options.

- ① Highlight a white balance option and press \triangleright .
 - ② Use \triangleleft / \triangleright to highlight an axis and use \triangleup / \triangledown to choose a value.
 - **A (amber–blue):**
Choose positive values for warmer colors, negative values for colder colors.
 - **G (green–magenta):**
Choose positive values for greener hues, negative values for a magenta cast.
 - ③ Press \odot when settings are complete.
-  White balance compensation can not be adjusted using the live control.

Choosing an image size [M or S] and compression [M S Settings]







 (Camera menu) \triangleright **M S** Settings



Submenu 2	Submenu 3	Application
Pixel Count	M : 3200×2400/2560×1920/1600×1200	Choose the size of images in pixels.
	S : 1280×960/1024×768/640×480	
Compression	Fine	Choose for fine-quality images.
	Normal	Choose for normal-quality images.

-  “Selecting the size of still images” (p. 41)

Adjusting flash settings [Flash Settings]

 (Camera menu) ► Flash Settings

Submenu 2	Submenu 3	Application
 Slow	Off/On	Choose whether to use slow shutter speeds when using the flash.
 Sync	 Sync 1/  Sync 2	Control flash timing. (If  Sync 1] is selected, the flash will fire immediately after the shutter opens. If  Sync 2] is selected, the flash will fire just before the shutter closes so that moving light sources appear to be followed by streams of light.)
 RC Mode	Off/On	Choose whether to use a wireless flash unit.

 Note that when [On] for  RC Mode], pictures will only be taken if a wireless flash unit is available.

Choosing the bracketing increment and number of shots [Bracket Settings]

 (Camera menu) ► Bracket Settings

Submenu 2	Application	
AE BKT ^{*1}	Off/3f 0.3EV/3f 0.7EV/ 3f 1.0EV/3f 1.3EV/3f 1.7EV	Vary exposure over a sequence of three shots. (The camera takes three shots while the shutter button is pressed all the way down, the first at the metered exposure value, and the second under and the third over the metered value by the selected amount.)
WB BKT	A-B (Amber–Blue): Off/3f 2Step/3f 4Step/ 3f 6Step G-M (Green–Magenta): Off/3f 2Step/3f 4Step/ 3f 6Step	Each time a picture is taken, the camera creates three images, each with a different hue (white balance) to A-B, or G-M direction.

^{*1} Exposure is modified by varying shutter speed and aperture (mode **P**), shutter speed (mode **A**), or aperture (mode **S**).

 No pictures will be taken if there is insufficient space on the memory card for all the pictures in the bracketing sequence.

 The bracketing increment is added to the value selected for exposure or white balance compensation.

Shooting at higher magnifications than optical zoom [Digital Zoom]

 (Camera menu) ► Digital Zoom

Submenu 2	Application
Off	Disable digital zoom.
On	Enable digital zoom.

- ❗ [Digital Zoom] is not available when [Super Macro] (p. 36) is selected.
- ❗ The option selected for [Digital Zoom] affects the appearance of the zoom bar. "To take larger images" (p. 22)



Reducing the blur caused by the camera shake when shooting [Image Stabilizer]

 (Camera menu) ► Image Stabilizer

Submenu 2	Application
Off	The image stabilizer is deactivated. This is recommended when shooting with the camera fixed in place on a tripod or other stable surface.
On	The image stabilizer is activated.

- ❗ If [On] is selected for [Image Stabilizer], the camera may make noise when the shutter button is pressed.
- ❗ Image stabilization may have no effect if camera shake is too severe.
- ❗ When the shutter speed is extremely slow, such as when pictures are taken at night, [Image Stabilizer] (still images) may not be as effective.

Taking pictures with a conversion lens [D7]

 (Camera menu) ► 

Submenu 2	Application
Off	Select when taking pictures without a conversion lens.
TCON-17	Select when taking pictures with a designated optional conversion lens.

- ❗ When a conversion lens is attached, light from the built-in flash can cause vignetting where shadows from the conversion lens appear on the images.
- ❗ When a conversion lens is attached, the camera may take extra time to focus.
- ❗ Conversion lens adapter CLA-12 (available separately) is required to attach the conversion lens to the camera.

Using the AF illuminator to focus on poorly-lit subjects [AF Illuminat.]

 (Camera menu) ► AF Illuminat.

Submenu 2	Application
Off	The AF illuminator is not used.
On	When the shutter button is pressed halfway down, the AF illuminator turns on to aid focusing.

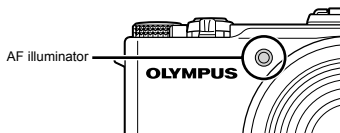

Viewing the image immediately after shooting [Rec View]

 (Camera menu) ► Rec View

Submenu 2	Application
Off	The image being recorded is not displayed. This allows the user to prepare for the next shot while following the subject in the monitor after shooting.
On	The image being recorded is displayed. This allows the user to make a brief check of the image that was just taken.

 Even when set to [On], you can resume shooting while the image is displayed.

Displaying indicators [Info Off]

 (Camera menu) ► Info Off





Submenu 2	Application
10 sec	Indicators automatically clear from the display if no operations are performed for 10 seconds.
Hold	Indicators are always displayed during shooting.

 Indicators that are always displayed may "burn in" to the monitor. "Monitor" (p. 84)

Panorama options [Panorama]

 (Camera menu) ► Panorama

Submenu 1	Application
Auto	Three frames are taken and combined by the camera. The user only composes the shots so that the target marks and pointers overlap, and the camera automatically releases the shutter.
Manual	Three frames are taken and combined by the camera. The user composes the shots using the guide frame and manually releases the shutter.
PC	The frames that were taken are combined into a panorama image using the PC software.

-  For details on installing the PC software, see “Charging the battery and setting up using the supplied CD” (p. 14).
-  Image size (p. 41) is fixed at 1600×1200 when [Auto] or [Manual] is selected.
-  The focus, exposure (p. 38), zoom position (p. 22), and white balance (p. 40) are locked at the first frame.
-  The flash (p. 37) is fixed to  (Flash Off) mode.



Shooting panoramas

“Creating panoramic images ( Panorama)” (p. 32)



Choosing movie frame size [Movie Resolution]

 (Movie menu) ► Movie Resolution

Submenu 2	Application
HD Quality	Shoot high definition movies with a frame size of 1280×720.
SD Quality	Shoot standard definition movies with a frame size of 640×480.

-  “Number of storable pictures (still images)/Continuous recording length (movies) in the internal memory and SD/SDHC/SDXC memory cards” (p. 79)
-  This item can also be accessed from the live control. “Choosing a frame size for movies” (p. 42)

Recording sound when shooting movies [U]

 (Movie menu) ► 



Submenu 2	Application
Off	No sound is recorded.
On	Sound is recorded.

Menus for Playback, Editing, and Printing Functions

Playing back pictures automatically [Slideshow]

 (Playback menu) ► Slideshow



Submenu 2	Submenu 3	Application
Start	—	Start the slideshow.
BGM	Off/ Cosmic/ Breeze/ Mellow/ Dreamy/ Urban	Select background music.
Slide	All/Still Picture/ Movie	Select the content to be included in the slideshow.
Slide Interval	2–10 seconds	Choose the interval before the next slide is displayed.
Movie Interval	Full/Short	Choose whether to display entire movies or only a portion of each movie.

 During a slideshow, press  to advance one frame,  to go back one frame.

Retouching photographs [RAW Data Edit]/[JPEG Edit]

 (Playback menu) ► Edit ►

RAW Data Edit/JPEG Edit

- ① Display the image to be edited and press .
 - [RAW Data Edit] is displayed if the picture is a RAW image, [JPEG Edit] if it is a JPEG image.
- ② Highlight [RAW Data Edit] or [JPEG Edit] and press .



[RAW Data Edit]

Create a JPEG copy of a RAW image.

-  The JPEG copy is processed using the settings currently stored in the camera. Adjust camera settings before choosing this option.

[JPEG Edit]

Choose from the following options:

Submenu 2	Application
Shadow Adj	Brighten dark backlit subjects.
Redeye Fix ¹	Reduce red-eye in pictures taken with the flash.
 ²	Crop images.
Aspect ²	Change the aspect ratio from 4:3 (standard) to [3:2], [16:9], or [6:6]. After selecting an aspect ratio, use $\Delta \nabla < \triangleright$ to position the crop.
Black & White	Convert images to black and white.
Sepia	Convert images to sepia.
Saturation	Adjust the vividness of colors.
 ³	Convert images to 1280 × 960, 640 × 480, or 320 × 240.
e-Portrait ¹	Make the skin of portrait subjects more smooth and translucent.

¹ Not available with some images.² Applies only to images with an aspect ratio of 4:3 (standard).³ Images with an aspect ratio other than 4:3 (standard) are converted to the closest available size. Sizes larger than the original size are not available.

 [JPEG Edit] is not available if there is insufficient space on the memory card or with RAW images, images that have been processed on a computer, or images recorded with another make of camera.

Retouching red-eye in pictures taken with the flash [Redeye Fix]① Select an image using $< \triangleright$ and press \odot .

- The edited copy is saved to a separate file.

 This option may have no effect with some images.

 The quality of the retouched copy may be lower than the original.

Cropping images []① Select an image using $< \triangleright$ and press \odot .

② Size the crop using the zoom lever and use $\Delta \nabla < \triangleright$ to position the crop.

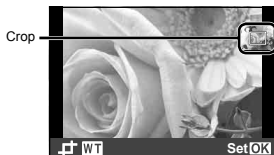
③ Press \odot once you have selected the crop.

- The edited copy is saved to a separate file.

Adjusting vividness [Saturation]

- 1 Select an image using \triangleleft and press \odot .
- 2 Use \triangle ∇ to choose the amount of saturation and press \odot . The effect can be previewed in the monitor.
- 3 Use \triangle ∇ to highlight [Yes] and press \odot .
 - The edited copy is saved to a separate file.

Resizing images []

Submenu 3	Application
1280×960	Copy a large image at a size suitable for printing at post-card sizes.
640×480	Copy a large image at a size suitable for e-mail or the web.
320×240	

- 1 Select an image using \triangleleft and press \odot .
- 2 Use \triangle ∇ to highlight a size and press \odot .
 - The edited copy is saved to a separate file.

Adding sound to still pictures []

[] (Playback menu) ▶ Edit ▶ []

Submenu 2	Application
No	No sound is recorded.
[] Start	Sound can be recorded for up to 30 seconds while a photograph is displayed, allowing you to record comments or impressions about the image.
Erase	Delete sound recorded with an image.

[] Start

- 1 Select an image using \triangleleft .
- 2 Point the microphone at the sound source.

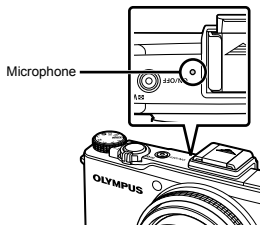

- 3 Use \triangle ∇ to highlight [] Start, and press \odot .
 - Recording starts.

[] Erase

- 1 Use \triangleleft to select an image marked with a [] icon.
- 2 Use \triangle ∇ to highlight [Erase], and press \odot .
 - The sound is deleted.

Saving print settings to the image data [Print Order]

(Playback menu) ► Print Order

- ❗ "Print Reservations (DPOF)" (p. 68)
- ❗ Print reservation can be set only for still images that are recorded to the card.

Erasing images [Erase]

(Playback menu) ► Erase

Submenu 1	Application
All Erase	All images in the internal memory or card will be erased.
Sel. Image	Images are individually selected and erased.
Erase	Deletes the image displayed.

- ❗ Images in internal memory can only be erased when no memory card is inserted.
- ❗ Images will only be erased from a memory card if it is currently inserted in the camera.
- ❗ Protected images cannot be erased.

To individually select and erase images [Sel. Image]

- ① Use Δ ∇ to highlight [Sel. Image], and press \odot .
- ② Use Δ ∇ \langle \triangleright to display the image to be erased and press \odot to add a \checkmark mark to the image.
 - Rotate the zoom lever to T to display a single frame display. Rotate the zoom lever to W to return to the index view.





- ③ Repeat Step ② to select the images to be erased, and then press the **MENU** button to erase the selected images.
- ④ Use Δ ∇ to highlight [Yes] and press \odot .
 - The images with a \checkmark mark are erased.

To erase all images [All Erase]

- ① Use Δ ∇ to highlight [All Erase] and press \odot .
- ② Use Δ ∇ to highlight [Yes] and press \odot .



Protecting images [5]

 (Playback menu) ► 5

- ! Protected images cannot be erased by [Erase] (p. 25, 55), [Sel. Image], or [All Erase] (p. 55), but all images are erased by [Memory Format]/[Format] (p. 57).
- ① Use  to select an image.
- ② Press .
 - Press  again to cancel the settings.
- ③ If necessary, repeat Steps ① and ② to protect other images, and press the **MENU** button.

Rotating images [Rotate]

 (Playback menu) ► Rotate

- ① Use  to select an image.
- ② Press  to rotate the image.
- ③ If necessary, repeat Steps ① and ② to make settings for other images, and press the **MENU** button.
- ! The new picture orientations will be saved even after the power is turned off.

Menus for Other Camera Settings

Saving custom settings *[Custom Mode Setup]*

⌵ (Setup menu) ▶ Custom Mode Setup

Submenu 2	Application
Set	Save current settings.
Reset ¹	Delete saved settings.

¹ Settings revert to mode P.

Erasing data completely *[Memory Format]/[Format]*

⌵ (Setup menu) ▶ Memory Format/Format

- ⓘ Before formatting, check that no important data is left in the internal memory or card.
- ⓘ Cards must be formatted with this camera before first use or after being used with other cameras or computers.

Submenu 2	Application
Yes	Completely erases the image data in the internal memory ¹ or card (including protected images).
No	Cancels formatting.

¹ Be sure to remove the card before formatting the internal memory.

Copying images in the internal memory to the card [Backup]

⌵ (Setup menu) ▶ Backup

Submenu 2	Application
Yes	Backs up image data in the internal memory to the card.
No	Cancels the backup.

- ⓘ It takes some time to back up data. Check that the battery has sufficient power before starting the backup.

Selecting a method for connecting the camera to other devices [USB Connection]

f (Setup menu) ▶ USB Connection

Submenu 2	Application
Auto	USB options are displayed when the camera is connected to another device.
Storage	The camera is treated as a Mass Storage device.
MTP	Select when transferring images to a computer running Windows Vista or Windows 7 without using the supplied software.
Print	Select when connecting to a PictBridge-compatible printer.

System requirements

Windows	Windows XP (Service Pack 1 or later)/ Windows Vista/Windows 7
Macintosh	Mac OS X v10.3 or later

- ! Even in the case of computers with USB ports, operation is not guaranteed if:
- The USB ports are not built-in but were added using an expansion board or card
 - The operating system is not factory installed or the computer is home built

Turning on the camera with the button [Power On]

f (Setup menu) ▶  Power On

Submenu 2	Application
Yes	The  button turns the camera on in playback mode.
No	The camera is not turned on. To turn on the camera, press the ON/OFF button.

Selecting the camera sound and its volume [Sound Settings]

f (Setup menu) ▶ Sound Settings

Submenu 2	Submenu 3	Application
Sound Type	1/2/3	Choose the sound made by camera controls (excluding the shutter button).
 Volume	OFF (No Sound) or 5 levels of volume	Adjusts the image playback volume.
Volume	OFF (No Sound) or 5 levels of volume	Choose the volume of the sound made by camera controls (excluding the shutter button).

Resetting file numbering [File Name]

⏏ (Setup menu) ▶ File Name

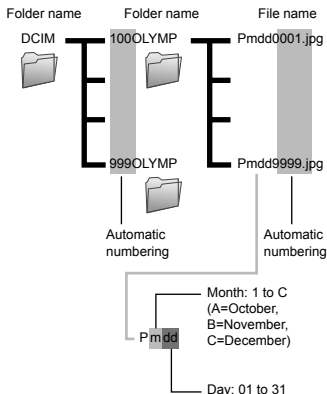

Submenu 2	Application
Reset	File numbering is reset when a new card is inserted ¹⁾ (choose when organizing images by card).
Auto	When a new card is inserted, file and folder numbering continue from the previous card (choose when organizing images by file and folder number).

¹⁾ Folder numbering is reset to 100, file numbering to 0001.

Adjusting the CCD and the image processing function [Pixel Mapping]

⏏ (Setup menu) ▶ Pixel Mapping

- ⚠ This function has already been adjusted at factory shipping, and no adjustment is needed right after purchase. Approximately once a year is recommended.
- ⚠ For best results, wait at least one minute after taking or viewing pictures before performing pixel mapping. If the camera is turned off during pixel mapping, be sure to perform it again.

To adjust the CCD and the image processing function

Press ⏏ when [Start] (Submenu 2) is displayed.

- The camera checks and adjusts the CCD and the image processing function at the same time.

Adjusting the brightness of the monitor [MON]

⏏ (Setup menu) ▶ MON

Adjusting monitor brightness

- ① Use Δ ∇ to adjust (the effect can be viewed in the monitor), and then press ⏏.



Viewing images on a TV [TV Out]

f (Setup menu) ► TV Out

- ! Different countries and regions use different video signal standards. Before connecting the camera, choose a video signal standard that matches that used by the TV.

Submenu 2	Submenu 3	Application
Video Out	NTSC	Choose when connecting the camera to TVs in countries or regions where NTSC is used (e.g., North America, Taiwan, Korea, and Japan).
	PAL	Choose when connecting the camera to TVs in countries or regions where PAL is used (e.g., Europe and China).
HDMI Out	480p/576p / 720p / 1080i	Choose an HDMI output format.
HDMI Control	Off	Playback operations are performed using camera controls.
	On	Playback operations are performed using the TV remote control.

- ! Camera factory defaults vary with the country or region of sale.

Viewing images on a TV

Using an AV cable

- 1 Match the camera video signal format ([NTSC]/[PAL]) to that used by the TV.
- 2 Connect the camera to the TV.

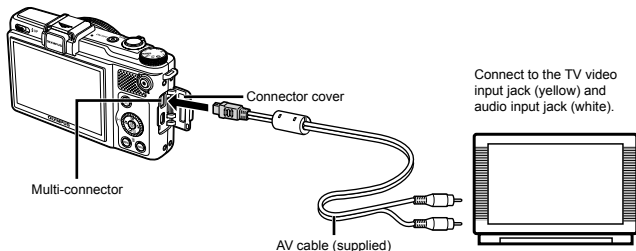

Using an HDMI cable

- 1 Match the camera digital signal format ([480p/576p]/[720p]/[1080i]) to that used by the TV.
 - 2 Connect the camera to the TV.
- ⚠ The [1080i] option gives priority to the 1080i HDMI output. If the TV is not set up for 1080i input, the camera changes the format first to 720p and if this is not supported then to 480p and finally to 576p. For information on changing TV HDMI input settings, see to the instruction manual provided with the TV.
- ⚠ Do not connect the HDMI cable when the camera is connected to a computer or other device using the USB cable.

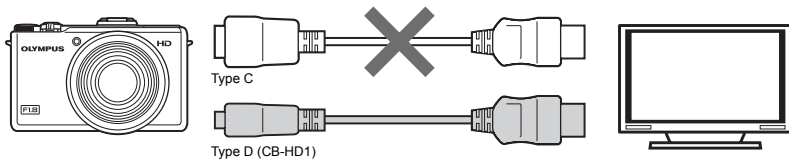
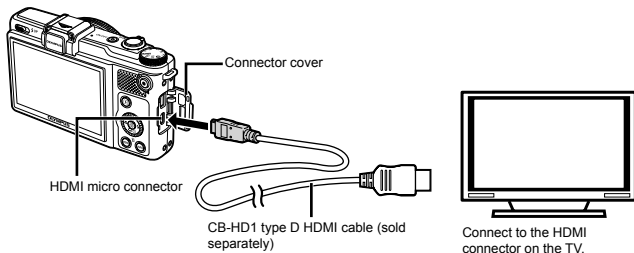

- 3 Turn the TV on and select the HDMI input to which the camera is connected.
 - 4 See the instruction manual provided with your TV for more information.
 - 4 Turn the camera on and use $\langle \triangleright \rangle$ to view images.
- ⚠ Use an HDMI cable that matches the HDMI micro connector on the camera and the HDMI connector on the TV.
- ⚠ When the camera and TV are connected by both an AV cable and an HDMI cable, the HDMI cable will take priority.
- ⚠ Images and other information may be cropped for display on the TV.

Using a remote control

- 1 Select [On] for [HDMI Control] and turn the camera off.
 - 2 Connect the camera to the TV using an HDMI cable.
"Using an HDMI cable" (p. 61)
 - 3 First turn on the TV, and then turn on the camera.
 - Follow the on-screen guide displayed by the TV to operate the camera.
- ! With some TVs, operations cannot be performed with the TV remote control even though the operation guide is displayed on the screen.
- ! If operations cannot be performed with the TV remote control, set [HDMI Control] to [Off] and use the controls on the camera.

Reducing power consumption between shots [Sleep]

f (Setup menu) ▶ Sleep

Submenu 2	Application
20sec/1min/3min/ 5min	The monitor turns off automatically to save battery power when no operations are performed (sleep mode). Choose the delay before the camera enters sleep mode.

- ! If no operations are performed for about 12 minutes after the camera enters sleep mode, the camera will turn off automatically.

Canceling sleep mode

Press the shutter button or an arrow key or rotate the mode dial.

Changing the display language [L]

f (Setup menu) ▶ L

Submenu 2	Application
Languages	The language for the menu and error messages displayed on the monitor is selected.

- 1 Use Δ ∇ \triangleleft \triangleright to select your language and press the \odot button.

Setting the date and time [D]

f (Setup menu) ▶ D

- ! "Date, time, time zone, and language" (p. 18)

To select the date display order

- 1 Press \triangleright after setting Minute, and use Δ ∇ to select the date display order.

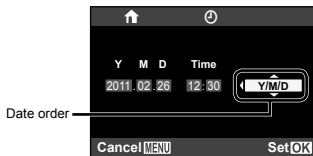

- 2 Press \odot when settings are complete.

Switching between home and travel destination time zones [World Time]

f (Setup menu) ► World Time

! You will not be able to select a time zone using [World Time] if the camera clock has not first been set using [O].

Submenu 2	Submenu 3	Application
Home/Alternate	🏠	The time in the home time zone (the time zone selected for 🏠 in submenu 2).
	➔	The time in the travel destination time zone (the time selected for ➔ in submenu 2).
🏠 ^{*1}	—	Select the home time zone (🏠).
➔ ^{*1, 2}	—	Select the travel destination time zone (➔).

^{*1} In areas where daylight saving time is in effect, use △ ▽ to turn daylight saving time ([Summer]) on.^{*2} When you select a time zone, the camera automatically calculates the time difference between the selected zone and the home time zone (🏠) to display the time in the travel destination time zone (➔).

Printing

Direct printing (PictBridge¹)

By connecting the camera to a PictBridge-compatible printer, you can print images directly without using a computer.

To find out if your printer supports PictBridge, refer to the printer's instruction manual.

¹ PictBridge is a standard for connecting digital cameras and printers of different makers and printing out pictures directly.

- ! The printing modes, paper sizes, and other parameters that can be set with the camera vary depending on the printer that is used. For details, refer to the printer's instruction manual.
- ! For details on the available paper types, loading paper, and installing ink cassettes, refer to the printer's instruction manual.

Printing images at the printer's standard settings [Easy Print]

- ! In the setup menu, set [USB Connection] (p.58) to [Print].

1 Display the image to be printed on the monitor.

- ! "Viewing images" (p. 23)

2 Turn on the printer, and then connect the printer and camera.

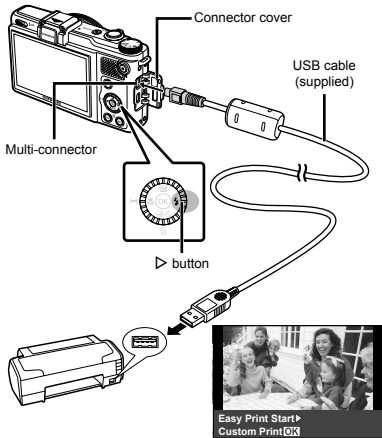

3 Press ▷ to start printing.

4 To print another image, use ◀▶ to select an image, and press .

To exit printing

After a selected image is displayed on the screen, disconnect the USB cable from the camera and printer.



Changing the printer's settings for printing [Custom Print]

1 Follow Steps 1 and 2 in [Easy Print] (p. 64), and press \odot .

2 Use Δ / ∇ to highlight the print mode, and press \odot .

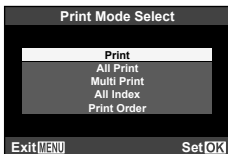

Submenu 2	Application
Print	This prints the image selected in Step 5.
All Print	This prints all images stored in the internal memory or card.
Multi Print	This prints one image in a multiple layout format.
All Index	This prints an index of all images stored in the internal memory or card.
Print Order ¹	This prints images based on the print reservation data on the card.

¹ [Print Order] is available only when print reservations have been made. "Print Reservations (DPOF)" (p. 68)

3 Use Δ / ∇ to highlight [Size] (Submenu 3), and press \triangleright .

! If the [Printpaper] screen is not displayed, the [Size], [Borderless], and [Pics/Sheet] are set to the printer's standard.

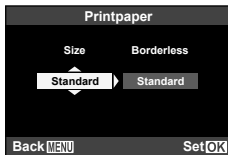

4 Use Δ ∇ to highlight the [Borderless] or [Pics/Sheet] settings, and press \odot .

Submenu 4	Application
Off/On ^{*1}	The image is printed with a border around it ([Off]). The image is printed to fill the entire paper ([On]).
(The number of images per sheet varies depending on the printer.)	The number of images per sheet ([Pics/Sheet]) is selectable only when [Multi Print] is selected in Step 2.

^{*1} The available settings for [Borderless] vary depending on the printer.

! If [Standard] is selected in Steps 3 and 4, the image is printed at the printer's standard settings.



5 Use \triangleleft \triangleright to select an image.

6 Press Δ to make a print reservation for the current image. Press ∇ to make the detailed printer settings for the current image.

To make the detailed printer settings

① Use Δ ∇ \triangleleft \triangleright to select the setting, and press \odot .

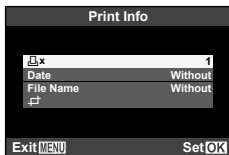

Submenu 5	Submenu 6	Application
\square x	0 to 10	This selects the number of prints.
Date	With/Without	Selecting [With] prints the images with the date. Selecting [Without] prints the images without the date.
File Name	With/Without	Selecting [With] prints the file name on the image. Selecting [Without] does not print any file name on the image.
\square	(Proceeds to the setting screen.)	This selects a portion of the image for printing.

7 To crop an image [⏏]

- 1 Use the zoom lever to select the size of the cropping frame, use $\Delta \nabla < \triangleright$ to move the frame, and then press \odot .



- 2 Use $\Delta \nabla$ to highlight [OK] and press \odot .



7 If necessary, repeat Steps 5 and 6 to select the image to be printed, make the detailed settings, and set [Single Print].

8 Press \odot .

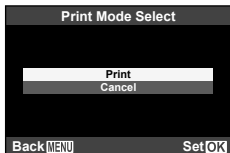

9 Use $\Delta \nabla$ to highlight [Print] and press \odot .

- Printing starts.
- When [Option Set] is selected in [All Print] mode, [Print Info] screen is displayed.
- When printing is finished, the [Print Mode Select] screen is displayed.

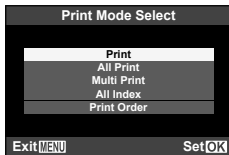

To cancel printing

- 1 When [Do Not Remove USB Cable] is displayed, press the MENU button, use $\Delta \nabla$ to select [Cancel], and then press \odot .

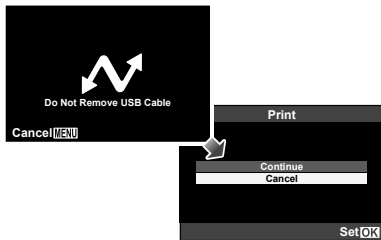

10 Press the MENU button.

11 When the message [Remove USB Cable] is displayed, disconnect the USB cable from the camera and printer.

Print Reservations (DPOF¹)

In print reservations, the number of prints and date imprint option are saved in the image on the card. This enables easy printing at a printer or print shop supporting DPOF by using only the print reservations on the card without a computer or a camera.

¹ DPOF is a standard for storing automatic printout information from digital cameras.

- Print reservations can be set only for the images stored on the card. Insert a card with recorded images before making print reservations.
- DPOF reservations set by another DPOF device cannot be changed by this camera. Make changes using the original device. Making new DPOF reservations with this camera will erase the reservations made by the other device.
- DPOF print reservations can be made for up to 999 images per card.

Single-frame print reservations []

1 Display the setup menu.

! "Using the Menus" (p. 6)

2 In the [] (playback) menu, highlight [Print Order] and then press [OK].

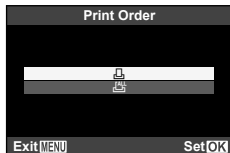

3 Use Δ ∇ to highlight [] and press [OK].



- 4** Use \triangleleft \triangleright to select the image for print reservation. Use \triangle ∇ to select the quantity. Press \odot .



- 5** Use \triangle ∇ to highlight a \odot (date print) screen option and press \odot .

Submenu 2	Application
No	This prints the image only.
Date	This prints the image with the shooting date.
Time	This prints the image with the shooting time.



- 6** Use \triangle ∇ to highlight [Set] and press \odot .

Reserving one print each of all images on the card $[ALL]$

- 1 Follow Steps 1 and 2 in $[L]$ (p. 68).
- 2 Use \triangle ∇ to highlight $[ALL]$ and press \odot .
- 3 Follow Steps 5 and 6 in $[L]$.

Resetting all print reservation data

- 1 Follow Steps 1 and 2 in $[L]$ (p. 68).
- 2 Use \triangle ∇ to highlight either $[L]$ or $[ALL]$, and press \odot .

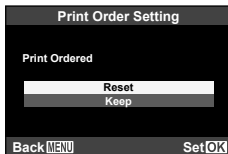

- 3 Use \triangle ∇ to highlight [Reset] and press \odot .

Resetting the print reservation data for selected images

- 1** Follow Steps 1 and 2 in [] (p. 68).
- 2** Use $\Delta \nabla$ to highlight [] and press OK .
- 3** Use $\Delta \nabla$ to highlight [Keep] and press OK .
- 4** Use $\langle \triangleright \rangle$ to select the image with the print reservation you want to cancel. Use $\Delta \nabla$ to set the print quantity to "0".
- 5** If necessary, repeat Step 4, and then press OK when finished.
- 6** Use $\Delta \nabla$ to highlight a [] (date print) screen option and press OK .
 - The settings are applied to the remaining images with the print reservation data.
- 7** Use $\Delta \nabla$ to highlight [Set] and press OK .

Usage Tips

If the camera does not work as intended, or if an error message is displayed on the screen, and you are unsure of what to do, refer to the information below to fix the problem(s).

Troubleshooting

Battery

“The camera does not work even when batteries are installed”.

- Insert recharged batteries in the correct direction. “Inserting the battery and the SD/SDHC/SDXC memory card (sold separately)” (p. 13), “Charging the battery and setting up using the supplied CD” (p. 14), “Charging the battery with the supplied USB-AC adapter” (p. 17)
- Battery performance may have been reduced temporarily due to low temperature. Take the batteries out of the camera, and warm them by putting them in your pocket for a while.



Card/Internal memory

“An error message is displayed”.

“Error message” (p. 72)

Shutter button

“No picture is taken when the shutter button is pressed”.

- Cancel sleep mode.
If no operations are performed for the specified time when the camera is on, the camera will enter sleep mode and the monitor will turn off automatically. While the camera is in sleep mode, pressing the shutter button will have no effect; to restore normal operation, operate the zoom lever or other camera controls. If no operations are performed for some time after the camera enters sleep mode, the camera will turn off automatically. Use the **ON/OFF** button to turn the camera on.
- Press the  button to switch to the shooting mode.
- Wait until  (flash charge) stops blinking before taking pictures.

Monitor

“Difficult to see”.

- Condensation¹ may have occurred. Turn off the power, and wait for the camera body to become acclimated to the surrounding temperature and dry out before taking pictures.
¹ Dew drops can form in the camera when it is suddenly taken from a cold location into a warm, humid room.

“Vertical lines appear on the screen”.

- This condition may occur when the camera is pointed at an extremely bright subject under a clear sky and so on. The lines do not appear, however, in the final image.

“Light is caught in the picture”.

- Shooting with flash in dark situations results in an image with many flash reflections on dust in the air.

Date and time function

"Date and time settings return to the default setting".

- If the batteries are removed and left out of the camera for about a day², the date and time settings return to the default setting, and must be reset.

² The time until the date and time settings return to the default setting varies depending on how long the batteries have been loaded.

"Date, time, time zone, and language" (p. 18)





Miscellaneous









"The camera makes a noise when taking pictures".

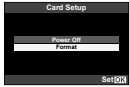
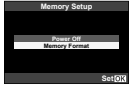

- The camera may activate the lens and make a noise even if no operation is performed. This is because the camera automatically performs actions of auto focus as far as it is ready to shoot.

Error message

- ! When one of the messages below is displayed on the monitor, check the corrective action.

Error message	Corrective action
 Card Error	Card problem Insert a new card.
 Write Protect	Card problem The card write-protect switch is set to the "LOCK" side. Release the switch.
 Memory Full	Internal memory problem <ul style="list-style-type: none">• Insert a card.• Erase unwanted images.¹
 Card Full	Card problem <ul style="list-style-type: none">• Replace the card.• Erase unwanted images.¹

Error message	Corrective action
 Card Setup	Card problem Use $\Delta \nabla$ to select [Format], and press \odot . Next, use $\Delta \nabla$ to select [Yes], and press \odot . ²
 Memory Setup	Internal memory problem Use $\Delta \nabla$ to select [Memory Format], and press \odot . Next, use $\Delta \nabla$ to select [Yes], and press \odot . ²
 No Picture	Internal memory/Card problem Take pictures before viewing them.
 Picture Error	Problem with selected image Use photo retouch software, etc. to view the image on a computer. If the image still cannot be viewed, the image file is corrupted.
 The Image Cannot Be Edited	Problem with selected image Use photo retouch software, etc. to edit the image on a computer.
 Battery Empty	Battery problem Charge the battery.
 No Connection	Connection problem Connect the camera and computer or printer correctly.
 No Paper	Printer problem Load paper into the printer.
 No Ink	Printer problem Refill the ink in the printer.

Error message	Corrective action
 Jammed	Printer problem Remove the jammed paper.
Settings Changed ¹³	Printer problem Return to the status where the printer can be used.
 Print Error	Printer problem Turn off the camera and printer, check the printer for any problems, and then turn the power on again.
 Cannot Print ¹⁴	Problem with selected image Use a computer to print.

¹¹ Before erasing important images, download them to a computer.

¹² All data will be erased.

¹³ This is displayed, for instance, when the printer's paper tray has been removed. Do not operate the printer while making the print settings on the camera.

¹⁴ This camera may be unable to print images taken by other cameras.

Shooting tips

When you are unsure of how to take a picture that you envision, refer to the information below.

Focusing



"Focusing on the subject"

- **Taking a picture of a subject not in the center of the screen**

After focusing on an object at the same distance as the subject, compose the shot, and take the picture.

Pressing the shutter button halfway (p. 21)

- **Using face priority (p. 44)**
- **Taking a picture in [AF Tracking] mode (p. 36)**

The camera tracks the subject movement automatically to focus on it continuously.

- **Positioning the focus point**

"Choosing a focus target" (p. 37)

- **Taking a picture of subjects where autofocus is difficult**

In the following cases, after focusing on an object (by pressing the shutter button halfway down) with high contrast at the same distance as the subject, compose the shot, and take the picture.

Subjects with low contrast



When extremely bright objects appear in the center of the screen



Object with no vertical lines^{*1}

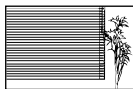

^{*1} It is also effective to compose the shot by holding the camera vertically to focus, and then returning to the horizontal position to take the picture.

When objects are at different distances



Fast-moving objects

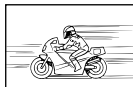

The subject is not in the center of the frame



Camera shake



“Taking pictures without camera shake”

- Taking pictures using [Image Stabilizer] (p. 49)
- Using the  (Sport) option in SCN mode (p. 31)

The  (Sport) mode uses a fast shutter speed and can reduce the blur incurred by a moving subject.

- Taking pictures at a high ISO sensitivity

If a high ISO sensitivity is selected, pictures can be taken at a high shutter speed even at locations where a flash cannot be used.

“Selecting the ISO sensitivity” (p. 39)

Exposure (brightness)



“Taking pictures with the right brightness”

- Taking pictures using [Fill In] (p. 37) flash

A subject against backlight is brightened.

- Taking pictures using exposure compensation (p. 38)

Adjust the brightness while viewing the screen for taking the picture. Normally, taking pictures of white subjects (such as snow) results in images that are darker than the actual subject. Use the exposure compensation to adjust in the positive (+) direction to express whites as they appear. When taking pictures of black subjects, on the other hand, it is effective to adjust in the negative (-) direction.

Color hue

WB

“Taking pictures with colors at the same shade as they appear”

- **Taking pictures by selecting white balance** (p. 40, 46)

Best results in most environments can normally be obtained with the [WB Auto] setting, but for some subjects, you should try experimenting with different settings. (This is especially true for sunshade under a clear sky, mixed natural and artificial light settings, and so on.)

Image quality



“Taking sharper pictures”

- **Taking pictures with the optical zoom**

Avoid using digital zoom (p. 22, 49) to take pictures.

- **Taking pictures at a low ISO sensitivity**

If the picture is taken with a high ISO sensitivity, noise (small colored spots and color unevenness that were not in the original image) can occur, and the image can appear grainy. The resulting image is grainier than with low ISO sensitivity as well.

“Selecting the ISO sensitivity” (p. 39)

Batteries



“Making batteries last longer”

- **Avoid any of the following operations when not actually taking pictures because they deplete the battery power**

- Repeatedly pressing the shutter button halfway
- Repeatedly using the zoom

- **Choosing the delay before the camera enters sleep mode**

[Sleep] (p. 62)

Playback/Editing tips

Playback



“Playing images in the internal memory and card”

- **Remove the card when playing pictures in the internal memory**

“To remove the SD/SDHC/SDXC memory card” (p. 14)

Appendix

Camera care

Exterior

- Wipe gently with a soft cloth. If the camera is very dirty, soak the cloth in mild soapy water and wring well. Wipe the camera with the damp cloth and then dry it with a dry cloth. If you have used the camera at the beach, use a cloth soaked in clean water and wrung well.

Monitor

- Wipe gently with a soft cloth.

Lens

- Blow dust off the lens with a commercial blower, then wipe gently with a lens cleaner.

Battery/USB-AC adapter

- Wipe gently with a soft, dry cloth.

- ! Do not use strong solvents such as benzene or alcohol, or chemically treated cloth.
- ! Mold may form on the lens surface if the lens is left dirty.

Storage

- When storing the camera for extended periods, remove the battery, USB-AC adapter and card, and keep in a cool, dry place that is well ventilated.
- Periodically insert the battery and test the camera functions.
- ! Avoid leaving the camera in places where chemical products are handled since this may result in corrosion.

The battery and USB-AC adapter

- This camera uses one Olympus lithium ion battery (LI-50B). No other type of batteries can be used.
- ! **Caution:**
There is a risk of explosion if the battery is replaced with the incorrect battery type.
Dispose of the used battery following the instructions. (p. 84)
- Power consumption by the camera varies depending on which functions are used.
- During the conditions described below, power is consumed continuously and the battery becomes exhausted quickly.
 - The zoom is used repeatedly.
 - The shutter button is pressed halfway repeatedly in shooting mode, activating the auto focus.
 - A picture is displayed on the monitor for an extended period of time.
 - The camera is connected to a computer or printer.
- Using an exhausted battery may cause the camera to turn off without displaying the battery level warning.
- The rechargeable battery is not fully charged at the time of purchase. Use the supplied F-2AC USB-AC adapter (hereafter referred to as USB-AC adapter) to charge the battery before use.
- When the included USB-AC adapter is used, charging usually takes approximately 3 hours (varies on usage).
- The supplied USB-AC adapter is for charging and playback only. Do not take pictures while the USB-AC adapter is connected to the camera.
- The included USB-AC adapter is designed to be used only with this camera. Other cameras cannot be charged with this USB-AC adapter.
Do not use with other devices.
- For plug-in type USB-AC adapter:
The included USB-AC adapter is intended to be correctly orientated in a vertical or floor mount position.

Connecting the camera to a computer

The battery can be charged by connecting the camera to a computer.

Using an optional USB-AC adapter

An F-3AC USB-AC adapter (available separately) is recommended if the camera will be used for extended periods.

Note that the power cable supplied with the USB-AC adapter is for use exclusively with the USB-AC adapter. Do not use with other devices.

Using your USB-AC adapter abroad

- The USB-AC adapter can be used in most home electrical sources within the range of 100 V to 240 V AC (50/60Hz) around the world. However, depending on the country or area you are in, the AC wall outlet may be shaped differently and the USB-AC adapter may require a plug adapter to match the wall outlet. For details, ask at your local electrical shop or travel agent.
- Do not use travel voltage converters as they could damage your USB-AC adapter.

Using an SD/SDHC/SDXC memory card

A card (and internal memory) also corresponds to the film that records images in a film camera. Otherwise, the recorded images (data) can be erased, and retouching is also available with the use of a computer. Cards can be removed from the camera and exchanged, but this is not possible with the internal memory. Use of larger capacity cards enables you to take more pictures.

SD/SDHC/SDXC card write-protect switch

The SD/SDHC/SDXC card body has a write-protect switch. If you set the switch to the "LOCK" side, you will not be able to write to the card, delete data or format. Release the switch to enable writing.

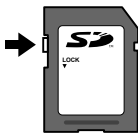

Cards compatible with this camera

SD/SDHC/SDXC memory cards (visit the Olympus website for information on memory cards that have been tested and approved for use)



Using a new card

Cards must be formatted with this camera before first use or after being used with other cameras or computers.
[Memory Format]/[Format] (p. 57)

Checking the image saving location

The memory indicator shows whether the internal memory or card is being used during shooting and playback.

Current memory indicator

 Internal memory is being used

 Card is being used

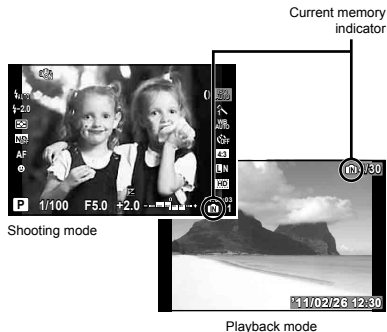

 Even if [Memory Format]/[Format], [Erase], [Sel. Image], or [All Erase] is performed, the data in the card is not completely erased. When disposing of the card, damage the card to prevent the disclosure of personal data.

Readout/recording process of the card

During shooting, the media access icon blinks red while the camera is recording data. Never open the battery/card compartment cover or unplug the USB cable. This can not only damage the image data but also render the internal memory or card unusable.

Blinks red



Number of storable pictures (still images)/Continuous recording length (movies) in the internal memory and SD/SDHC/SDXC memory cards

 The figures for the number of storable still pictures and continuous recording length are approximate. The actual capacity varies with shooting conditions and the card used.

Still images

Image size	Number of storable still pictures	
	Internal memory	SD/SDHC/SDXC memory card (1 GB)
RAW	4	70
L ^F	9	173
L ^N	17	305
M ^N	44	776
S ^N	162	2,753
L ^F +RAW	2	42
L ^N +RAW	2	47
M ^N +RAW	3	52
S ^N +RAW	3	54

Movies

Frame size	Continuous recording length			
	Internal memory		SD/SDHC/SDXC memory card (1 GB)	
	With sound	Without sound	With sound	Without sound
HD Quality 1280×720	11 sec.	12 sec.	3 min. 26 sec.	3 min. 34 sec.
SD Quality 640×480	22 sec.	24 sec.	6 min. 37 sec.	7 min. 7 sec.

 The maximum file size of a single movie is 2 GB, regardless of the capacity of the card.

Increasing the number of pictures that can be taken

Either erase unwanted images, or connect the camera to a computer or other device to save the images, and then erase the images in the internal memory or card.

[Erase] (p. 25, 55), [Sel. Image] (p. 55), [All Erase] (p. 55), [Memory Format]/[Format] (p. 57)

Using an electronic view finder (sold separately)

An electronic view finder (sold separately: VF-2) can be used as a shooting display. This is convenient when you are in a very bright location, such as under direct sunlight, where it is difficult to view the monitor, or are using the camera at a low angle. The electronic viewfinder attaches to the camera hot shoe and accessory port.

Using a dedicated flash unit (sold separately)

This camera supports optional external flash units, which can supply a variety of different types of flash lighting according to your needs. External flash units can communicate with the camera for a rich variety of flash control modes, including TTL-AUTO. Flash units designed exclusively for use with OLYMPUS cameras attach directly to the camera's hot shoe. Flash units can also be mounted on a flash bracket using a bracket cable (sold separately). Additional information is available in the manual provided with the flash unit.

Functions available with external flash units

Optional flash	FL-36R	FL-20	FL-14
Flash control mode	TTL-AUTO, MANUAL		
GN (Guide number) (ISO100)	GN36 (85mm ^{†1}) GN20 (24mm ^{†1})	GN20 (35mm ^{†1})	GN14 (28mm ^{†1})
RC mode	✓	–	–

^{†1} The focal length of the lens that can be used (35 mm film camera equivalent).

 The built-in flash can not be used when an external flash is connected.

Wireless remote control flash photography

External flash units that offer a remote control mode and are designated for use with this camera can be used for wireless flash photography. The built-in flash can control up to three groups of flash units independently. See the documentation provided with the external flash units for details.

Third-party flash units

Observe the following precautions when mounting an external flash unit not designated for use with this camera on the camera hot shoe:

- Using obsolete flash units that apply the voltages of 24V or over to the camera hot shoe X-contact will damage the camera.
- Connecting flash units with signal contacts that do not conform to Olympus specifications may damage the camera.
- Use only with the camera in shooting mode **M** and an option other than [ISO Auto] selected for ISO.

- Flash control can only be performed by manually setting the flash to the ISO sensitivity and aperture values selected with the camera. Flash brightness can be adjusted by adjusting either ISO sensitivity or aperture.
- Use a flash with an angle of illumination suited to the lens. Angle of illumination is usually expressed using 35-mm format equivalent focal lengths.

Conversion lens (sold separately)

Conversion lens	Conversion lens adapter
TCON-17	CLA-12

Microphone set (SEMA-1) (sold separately)

Produces higher-quality recordings than the camera's built-in microphone. The microphone can be placed at a distance from the camera to avoid recording ambient sounds or wind noise. Third-party commercial microphones can also be used depending on your creative intent (power supplied via ϕ 3.5 mm stereo mini-plug). The microphone set attaches to the camera hot shoe and accessory port.

- ! Microphones connected directly to the microphone adapter will cast shadows in photographs taken using the camera's built-in flash. This can be prevented by connecting the microphone using the supplied microphone cable.

Remote cable (RM-UC1) (sold separately)



Use when the slightest camera movement can result in blurred pictures, for example for macro or bulb photography. The remote cable attaches via the camera multi-connector.

Water-resistant protector (PT-050) (sold separately)

Use when taking photographs under water.

- ! "To take underwater photos" (p. 32), "To lock the focus distance for underwater shoots (AF lock)" (p. 32), [Underwater] (p. 40)

SAFETY PRECAUTIONS

	CAUTION RISK OF ELECTRIC SHOCK DO NOT OPEN	
CAUTION: TO REDUCE THE RISK OF ELECTRICAL SHOCK, DO NOT REMOVE COVER (OR BACK). NO USER-SERVICEABLE PARTS INSIDE. REFER SERVICING TO QUALIFIED OLYMPUS SERVICE PERSONNEL.		



An exclamation mark enclosed in a triangle alerts you to important operating and maintenance instructions in the documentation provided with the product.



DANGER

If the product is used without observing the information given under this symbol, serious injury or death may result.



WARNING

If the product is used without observing the information given under this symbol, injury or death may result.



CAUTION

If the product is used without observing the information given under this symbol, minor personal injury, damage to the equipment, or loss of valuable data may result.

WARNING!

TO AVOID THE RISK OF FIRE OR ELECTRICAL SHOCK, NEVER DISASSEMBLE, EXPOSE THIS PRODUCT TO WATER OR OPERATE IN A HIGH HUMIDITY ENVIRONMENT.

General Precautions

Read All Instructions — Before you use the product, read all operating instructions. Save all manuals and documentation for future reference.

Cleaning — Always unplug this product from the wall outlet before cleaning. Use only a damp cloth for cleaning. Never use any type of liquid or aerosol cleaner, or any type of organic solvent to clean this product.

Attachments — For your safety, and to avoid damaging the product, use only accessories recommended by Olympus.

Water and Moisture — For precautions on products with weatherproof designs, read the weatherproofing sections.

Location — To avoid damage to the product, mount the product securely on a stable tripod, stand, or bracket.

Power Source — Connect this product only to the power source described on the product label.

Lightning — If a lightning storm occurs while using a USB-AC adapter, remove it from the wall outlet immediately.

Foreign Objects — To avoid personal injury, never insert a metal object into the product.

Heat — Never use or store this product near any heat source such as a radiator, heat register, stove, or any type of equipment or appliance that generates heat, including stereo amplifiers.

Handling the Camera



WARNING

- **Do not use the camera near flammable or explosive gases.**
 - **Do not use the flash and LED (such as the AF illuminator) on people (infants, small children, etc.) at close range.**
 - You must be at least 1 m (3 ft.) away from the faces of your subjects. Firing the flash too close to the subject's eyes could cause a momentary loss of vision.
 - **Keep young children and infants away from the camera.**
 - Always use and store the camera out of the reach of young children and infants to prevent the following dangerous situations which could cause serious injury:
 - Becoming entangled in the camera strap, causing strangulation.
 - Accidentally swallowing the battery, cards or other small parts.
 - Accidentally firing the flash into their own eyes or those of another child.
 - Accidentally being injured by the moving parts of the camera.
 - **Do not look at the sun or strong lights with the camera.**
 - **Do not use or store the camera in dusty or humid places.**
 - **Do not cover the flash with a hand while firing.**
 - **Use SD/SDHC/SDXC memory cards only. Never use other types of cards.**
 - If you accidentally insert another type of card into the camera, contact an authorized distributor or service center. Do not try to remove the card by force.
-  **CAUTION**
- **Stop using the camera immediately if you notice any unusual odors, noise, or smoke around it.**
 - Never remove the batteries with bare hands, which may cause a fire or burn your hands.

- **Never hold or operate the camera with wet hands.**
- **Do not leave the camera in places where it may be subject to extremely high temperatures.**
 - Doing so may cause parts to deteriorate and, in some circumstances, cause the camera to catch fire.
 - Do not use the USB-AC adapter if it is covered (such as a blanket). This could cause overheating, resulting in fire.
- **Handle the camera with care to avoid getting a low-temperature burn.**
 - When the camera contains metal parts, overheating can result in a low-temperature burn. Pay attention to the following:
 - When used for a long period, the camera will get hot. If you hold on to the camera in this state, a low-temperature burn may be caused.
 - In places subject to extremely cold temperatures, the temperature of the camera's body may be lower than the environmental temperature. If possible, wear gloves when handling the camera in cold temperatures.
- **Be careful with the strap.**
 - Be careful with the strap when you carry the camera. It could easily catch on stray objects and cause serious damage.

Battery Handling Precautions

Follow these important guidelines to prevent batteries from leaking, overheating, burning, exploding, or causing electrical shocks or burns.

DANGER

- The camera uses a lithium ion battery specified by Olympus. Charge the battery with the specified USB-AC adapter. Do not use any other USB-AC adapters.
- Never heat or incinerate batteries.
- Take precautions when carrying or storing batteries to prevent them from coming into contact with any metal objects such as jewelry, pins, fasteners, etc.
- Never store batteries where they will be exposed to direct sunlight, or subjected to high temperatures in a hot vehicle, near a heat source, etc.
- To prevent causing battery leaks or damaging their terminals, carefully follow all instructions regarding the use of batteries. Never attempt to disassemble a battery or modify it in any way, solder, etc.
- If battery fluid gets into your eyes, flush your eyes immediately with clear, cold running water and seek medical attention immediately.

- Always store batteries out of the reach of small children. If a child accidentally swallows a battery, seek medical attention immediately.

WARNING

- Keep batteries dry at all times.
- To prevent batteries from leaking, overheating, or causing a fire or explosion, use only batteries recommended for use with this product.
- Insert the battery carefully as described in the operating instructions.
- If rechargeable batteries have not been recharged within the specified time, stop charging them and do not use them.
- Do not use a battery if it is cracked or broken.
- If a battery leaks, becomes discolored or deformed, or becomes abnormal in any other way during operation, stop using the camera.
- If a battery leaks fluid onto your clothing or skin, remove the clothing and flush the affected area with clean, running cold water immediately. If the fluid burns your skin, seek medical attention immediately.
- Never subject batteries to strong shocks or continuous vibration.

CAUTION

- Before loading, always inspect the battery carefully for leaks, discoloration, warping, or any other abnormality.
- The battery may become hot during prolonged use. To avoid minor burns, do not remove it immediately after using the camera.
- Always unload the battery from the camera before storing the camera for a long period.

Caution for Usage Environment

- To protect the high-precision technology contained in this product, never leave the camera in the places listed below, no matter if in use or storage:
 - Places where temperatures and/or humidity are high or go through extreme changes. Direct sunlight, beaches, locked cars, or near other heat sources (stove, radiator, etc.) or humidifiers.
 - In sandy or dusty environments.
 - Near flammable items or explosives.
 - In wet places, such as bathrooms or in the rain. When using products with weatherproof designs, read their manuals as well.
 - In places prone to strong vibrations.

- Never drop the camera or subject it to severe shocks or vibrations.
- When mounted on a tripod, adjust the position of the camera with the tripod head. Do not twist the camera.
- Do not touch electric contacts on cameras.
- Do not leave the camera pointed directly at the sun. This may cause lens or shutter curtain damage, color failure, ghosting on the CCD, or may possibly cause fires.
- Do not push or pull severely on the lens.
- Before storing the camera for a long period, remove the batteries. Select a cool, dry location for storage to prevent condensation or mold from forming inside the camera. After storage, test the camera by turning it on and pressing the shutter button to make sure that it is operating normally.
- The camera may malfunction if it is used in a location where it is subject to a magnetic/electromagnetic field, radio waves, or high voltage, such as near a TV set, microwave, video game, loud speakers, large monitor unit, TV/radio tower, or transmission towers. In such cases, turn the camera off and on again before further operation.
- Always observe the operating environment restrictions described in the camera's manual.

Battery Handling Precautions

- This camera uses a lithium ion battery specified by Olympus. Do not use any other type of battery.
- If the battery's terminals get wet or greasy, camera contact failure may result. Wipe the battery well with a dry cloth before use.
- Always charge a battery when using it for the first time, or if it has not been used for a long period.
- When operating the camera with battery power at low temperatures, try to keep the camera and spare battery as warm as possible. A battery that has run down at low temperatures may be restored after it is warmed at room temperature.
- The number of pictures you can take may vary depending on the shooting conditions or battery.
- Before going on a long trip, and especially before traveling abroad, purchase extra batteries. A recommended battery may be difficult to obtain while traveling.
- Please recycle batteries to help save our planet's resources. When you throw away dead batteries, be sure to cover their terminals and always observe local laws and regulations.

Monitor

- Do not twist the monitor forcibly; otherwise the image may become vague, resulting in a playback mode failure or damage to the monitor.

- Static images displayed on organic EL monitors for extended periods of time may "burn in", causing a drop in brightness or discoloration in some areas of the display, which may be permanent in some cases. This phenomenon has no effect on images recorded with the camera.
- A strip of light may appear on the top/bottom of the monitor, but this is not a malfunction.
- When a subject is viewed diagonally in the camera, the edges may appear zigzagged on the monitor. This is not a malfunction; it will be less noticeable in playback mode.
- Although the monitor is manufactured using high-precision technology, some pixels may always be lit or may never light, and color and brightness may vary with the viewing angle. This is normal for this type of monitor and does not indicate a malfunction; images recorded with the camera are unaffected.

Legal and Other Notices

- Olympus makes no representations or warranties regarding any damages, or benefit expected by using this unit lawfully, or any request from a third person, which are caused by the inappropriate use of this product.
- Olympus makes no representations or warranties regarding any damages or any benefit expected by using this unit lawfully which are caused by erasing picture data.

Disclaimer of Warranty

- Olympus makes no representations or warranties, either expressed or implied, by or concerning any content of these written materials or software, and in no event shall be liable for any implied warranty of merchantability or fitness for any particular purpose or for any consequential, incidental or indirect damages (including but not limited to damages for loss of business profits, business interruption and loss of business information) arising from the use or inability to use these written materials or software or equipment. Some countries do not allow the exclusion or limitation of liability for consequential or incidental damages or of the implied warranty, so the above limitations may not apply to you.
- Olympus reserves all rights to this manual.

Warning

Unauthorized photographing or use of copyrighted material may violate applicable copyright laws. Olympus assumes no responsibility for unauthorized photographing, use or other acts that infringe upon the rights of copyright owners.

Copyright Notice

All rights reserved. No part of these written materials or this software may be reproduced or used in any form or by any means, electronic or mechanical, including photocopying and recording or the use of any type of information storage and retrieval system, without the prior written permission of Olympus. No liability is assumed with respect to the use of the information contained in these written materials or software, or for damages resulting from the use of the information contained therein. Olympus reserves the right to alter the features and contents of this publication or software without obligation or advance notice.

FCC Notice

- Radio and Television Interference
- Changes or modifications not expressly approved by the manufacturer may void the user's authority to operate this equipment. This equipment has been tested and found to comply with the limits for a Class B digital device, pursuant to Part 15 of the FCC Rules. These limits are designed to provide reasonable protection against harmful interference in a residential installation.
- This equipment generates, uses, and can radiate radio frequency energy and, if not installed and used in accordance with the instructions, may cause harmful interference to radio communications.
- However, there is no guarantee that interference will not occur in a particular installation. If this equipment does cause harmful interference to radio or television reception, which can be determined by turning the equipment off and on, the user is encouraged to try to correct the interference by one or more of the following measures:
 - Adjust or relocate the receiving antenna.
 - Increase the distance between the camera and receiver.
 - Connect the equipment to an outlet on a circuit different from that to which the receiver is connected.
 - Consult your dealer or an experienced radio/TV technician for help. Only the OLYMPUS-supplied USB cable should be used to connect the camera to USB enabled personal computers (PC).

Any unauthorized changes or modifications to this equipment would void the user's authority to operate it.

Use Only Dedicated Rechargeable Battery and USB-AC adapter

We strongly recommend that you use only the genuine Olympus dedicated rechargeable battery and USB-AC adapter with this camera. Using a non-Olympus rechargeable battery and/or USB-AC adapter may result in fire or personal injury due to leakage, heating, ignition or damage to the battery. Olympus does not assume any liability for accidents or damage that may result from the use of a battery and/or USB-AC adapter that are not genuine Olympus accessories.

For customers in North and South America

For customers in USA

Declaration of Conformity

Model Number: XZ-1

Trade Name: OLYMPUS

Responsible Party:

OLYMPUS IMAGING AMERICA INC.

Address: 3500 Corporate Parkway, P.O. Box 610,
Center Valley, PA 18034-0610, U.S.A.

Telephone Number: 484-896-5000

Tested To Comply With FCC Standards
FOR HOME OR OFFICE USE

This device complies with Part 15 of the FCC rules. Operation is subject to the following two conditions:

- (1) This device may not cause harmful interference.
- (2) This device must accept any interference received, including interference that may cause undesired operation.

For customers in Canada

This Class B digital apparatus complies with Canadian ICES-003.

OLYMPUS WORLDWIDE LIMITED WARRANTY - IMAGING PRODUCTS

Olympus warrants that the enclosed Olympus® imaging product(s) and related Olympus® accessories (individually a "Product" and collectively the "Products") will be free from defects in materials and workmanship under normal use and service for a period of one (1) year from the date of purchase. If any Product proves to be defective within the one-year warranty period, the customer must return the defective Product to any of Olympus Service Centers, following the procedure set forth below (See "WHAT TO DO WHEN SERVICE IS NEEDED").

Olympus, at its sole discretion, will repair, replace, or adjust the defective Product, provided that Olympus investigation and factory inspection disclose that (a) such defect developed under normal and proper use and (b) the Product is covered under this limited warranty.

Repair, replacement, or adjustment of defective Products shall be Olympus's sole obligation and the customer's sole remedy hereunder.

The customer is liable and shall pay for shipment of the Products to the Olympus Service Center.

Olympus shall not be obligated to perform preventive maintenance, installation, deinstallation, or maintenance. Olympus reserves the right to (i) use reconditioned, refurbished, and/or serviceable used parts (that meet Olympus's quality assurance standards) for warranty or any other repairs and (ii) make any internal or external design and/or feature changes on or to its products without any liability to incorporate such changes on or to the Products.

WHAT IS NOT COVERED BY THIS LIMITED WARRANTY

Excluded from this limited warranty and not warranted by Olympus in any fashion, either express, implied, or by statute, are:

- (a) products and accessories not manufactured by Olympus and/or not bearing the "OLYMPUS" brand label (the warranty coverage for products and accessories of other manufacturers, which may be distributed by Olympus, is the responsibility of the manufacturers of such products and accessories in accordance with the terms and duration of such manufacturers' warranties);
- (b) any Product which has been disassembled, repaired, tampered with, altered, changed, or modified by persons other than Olympus's own authorized service personnel unless repair by others is made with the written consent of Olympus;
- (c) defects or damage to the Products resulting from wear, tear, misuse, abuse, negligence, sand, liquids, impact, improper storage, nonperformance of scheduled operator and maintenance items, battery leakage, use of non-"OLYMPUS" brand accessories, consumables, or supplies, or use of the Products in combination with non-compatible devices;
- (d) software programs;
- (e) supplies and consumables (including but not limited to lamps, ink, paper, film, prints, negatives, cables and batteries); and/or
- (f) Products which do not contain a validly placed and recorded Olympus serial number, unless they are a model on which Olympus does not place and record serial numbers.

EXCEPT FOR THE LIMITED WARRANTY SET FORTH ABOVE, OLYMPUS MAKES NO AND DISCLAIMS ALL OTHER REPRESENTATIONS, GUARANTIES, CONDITIONS, AND WARRANTIES CONCERNING THE PRODUCTS, WHETHER DIRECT OR INDIRECT, EXPRESS OR IMPLIED, OR ARISING UNDER ANY STATUTE, ORDINANCE, COMMERCIAL USAGE OR OTHERWISE, INCLUDING BUT NOT LIMITED TO ANY WARRANTY OR REPRESENTATION AS TO THE SUITABILITY, DURABILITY, DESIGN, OPERATION, OR CONDITION OF THE PRODUCTS (OR ANY PART THEREOF) OR THE MERCHANTABILITY OF THE PRODUCTS OR THEIR FITNESS FOR A PARTICULAR PURPOSE, OR RELATING TO THE INFRINGEMENT OF ANY PATENT, COPYRIGHT, OR OTHER PROPRIETARY RIGHT USED OR INCLUDED THEREIN. IF ANY IMPLIED WARRANTIES APPLY AS A MATTER OF LAW, THEY ARE LIMITED IN DURATION TO THE LENGTH OF THIS LIMITED WARRANTY.

SOME STATES MAY NOT RECOGNIZE A DISCLAIMER OR LIMITATION OF WARRANTIES AND/OR LIMITATION OF LIABILITY SO THE ABOVE DISCLAIMERS AND EXCLUSIONS MAY NOT APPLY.

THE CUSTOMER MAY ALSO HAVE DIFFERENT AND/OR ADDITIONAL RIGHTS AND REMEDIES THAT VARY FROM STATE TO STATE.

THE CUSTOMER ACKNOWLEDGES AND AGREES THAT OLYMPUS SHALL NOT BE RESPONSIBLE FOR ANY DAMAGES THAT THE CUSTOMER MAY INCUR FROM DELAYED SHIPMENT, PRODUCT FAILURE, PRODUCT DESIGN, SELECTION, OR PRODUCTION, IMAGE OR DATA LOSS OR IMPAIRMENT OR FROM ANY OTHER CAUSE. WHETHER LIABILITY IS ASSERTED IN CONTRACT, TORT (INCLUDING NEGLIGENCE AND STRICT PRODUCT LIABILITY) OR OTHERWISE. IN NO EVENT SHALL OLYMPUS BE LIABLE FOR ANY INDIRECT, INCIDENTAL, CONSEQUENTIAL OR SPECIAL DAMAGES OF ANY KIND (INCLUDING WITHOUT LIMITATION LOSS OF PROFITS OR LOSS OF USE), WHETHER OR NOT OLYMPUS SHALL BE OR SHOULD BE AWARE OF THE POSSIBILITY OF SUCH POTENTIAL LOSS OR DAMAGE.

Representations and warranties made by any person, including but not limited to dealers, representatives, salespersons, or agents of Olympus, which are inconsistent or in conflict with or in addition to the terms of this limited warranty, shall not be binding upon Olympus unless reduced to writing and approved by an expressly authorized officer of Olympus.

This limited warranty is the complete and exclusive statement of warranty which Olympus agrees to provide with respect to the Products and it shall supersede all prior and contemporaneous oral or written agreements, understandings, proposals, and communications pertaining to the subject matter hereof.

This limited warranty is exclusively for the benefit of the original customer and cannot be transferred or assigned.

WHAT TO DO WHEN SERVICE IS NEEDED

The customer must transfer any image or other data saved on a Product to another image or data storage medium and/or remove any film from the Product prior to sending the Product to Olympus for service.

IN NO EVENT SHALL OLYMPUS BE RESPONSIBLE FOR SAVING, KEEPING OR MAINTAINING ANY IMAGE OR DATA SAVED ON A PRODUCT RECEIVED BY IT FOR SERVICE, OR ON ANY FILM CONTAINED WITHIN A PRODUCT RECEIVED BY IT FOR SERVICE. NOR SHALL OLYMPUS BE RESPONSIBLE FOR ANY DAMAGES IN THE EVENT ANY IMAGE OR DATA IS LOST OR IMPAIRED WHILE SERVICE IS BEING PERFORMED (INCLUDING, WITHOUT LIMITATION, DIRECT, INDIRECT, INCIDENTAL, CONSEQUENTIAL OR SPECIAL DAMAGES, LOSS OF PROFITS OR LOSS OF USE), WHETHER OR NOT OLYMPUS SHALL BE OR SHOULD BE AWARE OF THE POSSIBILITY OF SUCH POTENTIAL LOSS OR IMPAIRMENT.

Package the Product carefully using ample padding material to prevent damage in transit and either deliver it to the Authorized Olympus Dealer that sold you the Product or ship it postage prepaid and insured to any of our Olympus Service Centers. When returning Products for service, your package should include the following:

- 1 Sales receipt showing date and place of purchase.
- 2 Copy of this limited warranty **bearing the Product serial number corresponding to the serial number on the Product** (unless it is a model on which Olympus does not place and record serial numbers).
- 3 A detailed description of the problem.
- 4 Sample prints, negatives, digital prints (or files on disk) if available and related to the problem.

When service is completed, the Product will be returned to you postage prepaid.

WHERE TO SEND PRODUCT FOR SERVICE

See "WORLDWIDE WARRANTY" for the nearest service center.

INTERNATIONAL WARRANTY SERVICE

International warranty service is available under this warranty.

For customers in Europe



"CE" mark indicates that this product complies with the European requirements for safety, health, environment and customer protection. "CE" mark cameras are intended for sales in Europe.



This symbol [crossed-out wheeled bin WEEE Annex IV] indicates separate collection of waste electrical and electronic equipment in the EU countries.

Please do not throw the equipment into the domestic refuse.

Please use the return and collection systems available in your country for the disposal of this product.



This symbol [crossed-out wheeled bin Directive 2006/66/EC Annex II] indicates separate collection of waste batteries in the EU countries.

Please do not throw the batteries into the domestic refuse. Please use the return and collection systems available in your country for the disposal of the waste batteries.

Provisions of warranty

- 1 If this product proves to be defective, although it has been used properly (in accordance with the written Handling Care and Operating instructions supplied with it), during the applicable national warranty period and has been purchased from an authorized Olympus distributor within the business area of Olympus Europa Holding GmbH as stipulated on the website: <http://www.olympus.com> this product will be repaired, or at Olympus's option replaced, free of charge. To claim under this warranty the customer must take the product before the end of the applicable national warranty period to the dealer where the product was purchased or any other Olympus service station within the business area of Olympus Europa Holding GmbH as stipulated on the website: <http://www.olympus.com>. During the one year period of the World Wide Guarantee the customer may turn the product in at any Olympus service station. Please notice that not in all countries such Olympus service station exists.
- 2 The customer shall transport the product to the dealer or Olympus authorized service station at his own risk and shall be responsible for any costs incurred in transporting the product.

Provisions of Guarantee

- 1 *OLYMPUS IMAGING CORP., Shinjuku Monolith, 2-3-1 Nishi-Shinjuku, Shinjuku-ku, Tokyo 163-0914, Japan grants a one year World Wide Guarantee. This worldwide Guarantee must be presented at an Olympus authorized repair service station before any repair can be made under conditions of this Guarantee. This Guarantee is valid only if the Guarantee Certificate and proof of purchase are presented at the Olympus repair service station. Please note that this Guarantee is in addition to and does not affect the customer's legal warranty rights under the applicable national legislation governing the sale of consumer goods mentioned above.
- 2 This Guarantee does not cover the following and the customer will be required to pay repair charge, even for defects occurring within the Guarantee period referred to above.
 - a. Any defect that occurs due to mishandling (such as an operation performed that is not mentioned in the Handling Care or other sections of the instructions, etc.)
 - b. Any defect that occurs due to repair, modification, cleaning, etc. performed by anyone other than Olympus or an Olympus authorized service station.
 - c. Any defect or damage that occurs due to transport, a fall, shock, etc. after purchase of the product.
 - d. Any defect or damage that occurs due to fire, earthquake, flood damage, thunderbolt, other natural disasters, environmental pollution and irregular voltage sources.
 - e. Any defect that occurs due to careless or improper storage (such as keeping the product under conditions of high temperature and humidity, near insect repellents such as naphthalene or harmful drugs, etc.), improper maintenance, etc.
 - f. Any defect that occurs due to exhausted batteries, etc.
 - g. Any defect that occurs due to sand, mud, etc. entering the inside of the product casing.
 - h. When the Guarantee Certificate is not returned with the product.
 - i. When any alterations whatsoever are made to the Guarantee Certificate regarding the year, month and date of purchase, the customer's name, the dealer's name, and the serial number.
 - j. When proof of purchase is not presented with this Guarantee Certificate.
- 3 This Guarantee applies to the product only; the Guarantee does not apply to any other accessory equipment, such as the case, strap, lens cap and batteries.

- 4 Olympus's sole liability under this Guarantee shall be limited to repairing or replacing the product. Any liability under the Guarantee for indirect or consequential loss or damage of any kind incurred or suffered by the customer due to a defect of the product, and in particular any loss or damage caused to any lenses, films, other equipment or accessories used with the product or for any loss resulting from a delay in repair or loss of data, is excluded. Compelling regulations by law remain unaffected by this.

Notes regarding Guarantee maintenance

- 1 This Guarantee will only be valid if the Guarantee Certificate is duly completed by Olympus or an authorized dealer or other documents contain sufficient proof. Therefore, please make sure that your name, the name of the dealer, the serial number and the year, month and date of purchase are all completed or the original invoice or the sales receipt (indicating the dealer's name, the date of purchase and product type) is attached to this Guarantee Certificate. Olympus reserves the right to refuse free-of-charge service if neither Guarantee Certificate is completed nor the above document is attached or if the information contained in it is incomplete or illegible.
 - 2 Since this Guarantee Certificate will not be re-issued, keep it in a safe place.
- * Please refer to the list on the web site: <http://www.olympus.com> for the authorized international Olympus service network.

For customers in Asia

Provisions of warranty

- 1 If this product proves to be defective, although it has been used properly (in accordance with the written Handling Care and Operating instructions supplied with it), during a period of up to one year from the date of purchase this product will be repaired, or at Olympus's option replaced, free of charge. To claim under warranty the customer must take the product and this Warranty certificate before the end of the one year warranty period to the dealer where the product was purchased or any Olympus authorized service station listed in the instructions and request the necessary repairs.
- 2 The customer shall transport the product to the dealer or Olympus authorized service station at his own risk and shall be responsible for any costs incurred in transporting the product.
- 3 This warranty does not cover the following and the customer will be required to pay repair charge, even for defects occurring within the one year period referred to above.

- a. Any defect that occurs due to mishandling (such as an operation performed that is not mentioned in the Handling Care or other sections of the instructions, etc.)
 - b. Any defect that occurs due to repair, modification, cleaning, etc. performed by anyone other than Olympus or an Olympus authorized service station.
 - c. Any defect or damage that occurs due to transport, a fall, shock, etc. after purchase of the product.
 - d. Any defect or damage that occurs due to fire, earthquake, flood damage, thunderbolt, other natural disasters, environmental pollution and irregular voltage sources.
 - e. Any defect that occurs due to careless or improper storage (such as keeping the product under conditions of high temperature and humidity, near insect repellents such as naphthalene or harmful drugs, etc.), improper maintenance, etc.
 - f. Any defect that occurs due to exhausted batteries, etc.
 - g. Any defect that occurs due to sand, mud, etc. entering the inside of the product casing.
 - h. When this Warranty Certificate is not returned with the product.
 - i. When any alterations whatsoever are made to the Warranty Certificate regarding the year, month and date of purchase, the customer's name, the dealer's name, and the serial number.
 - j. When proof of purchase is not presented with this Warranty Certificate.
- 4 This Warranty applies to the product only; the Warranty does not apply to any other accessory equipment, such as the case, strap, lens cap and batteries.
- 5 Olympus' sole liability under this warranty shall be limited to repairing or replacing the product and any liability for indirect or consequential loss or damage of any kind incurred or suffered by the customer due to a defect in the product, and in particular any loss or damage caused to any film or lenses or other equipment or accessories used with the product or for any loss resulting from delay in repair, is excluded.

Notes:

- 1 This Warranty is in addition to and does not affect the customer's statutory right.
- 2 If you have any queries regarding this Warranty, call any of the Olympus authorized service stations listed in the instructions.

Notes regarding warranty maintenance

- 1 This Warranty will only be valid if the Warranty Certificate is duly completed by Olympus or the dealer. Make sure that your name, the name of the dealer, the serial number and the year, month and date of purchase are all completed.
- 2 Since this Warranty Certificate will not be re-issued, keep it in a safe place.
- 3 Any request for repair by a customer in same country where the product was purchased shall be subject to the terms of the warranty issued by the Olympus distributor in that country. Where the local Olympus distributor does not issue a separate warranty or where the customer is not in the country where the product was purchased the terms of this worldwide warranty shall apply.
- 4 Where applicable, this Warranty is valid worldwide. The Olympus authorized service stations listed in this Warranty will gladly honor it.
 - * Please refer to the appended list for the authorized international Olympus service network.

Disclaimer of Warranty

Olympus makes no representations or warranties, either expressed or implied, by or concerning any content if these written materials or software, and in no event shall be liable for any implied warranty of merchantability or fitness for any particular purpose or for any consequential, incidental or indirect damages (including but not limited to damages for loss of business profits, business interruption and loss of business information) arising from the use of inability to use these written materials or software. Some states do not allow the exclusion or limitation of liability for consequential or incidental damages, so the above limitations may not apply to you.

Trademarks

- IBM is a registered trademark of International Business Machines Corporation.
- Microsoft and Windows are registered trademarks of Microsoft Corporation.
- Macintosh is a trademark of Apple Inc.
- SDHC/SDXC logo is a trademark.
- All other company and product names are registered trademarks and/or trademarks of their respective owners.
- The standards for camera file systems referred to in this manual are the "Design rule for Camera File system/DCF" standards stipulated by the Japan Electronics and Information Technology Industries Association (JEITA).

The software in this camera may include third party software. Any third party software is subject to the terms and conditions, imposed by the owners or licensors of that software, under which such software is provided to you. Those terms and other third party software notices, if any, may be found in the software notice PDF file stored within the accompanying CD-ROM or at <http://www.olympus.co.jp/en/support/msgs/digicamera/download/notice/notice.cfm>

SPECIFICATIONS

Camera

Product type	: Digital camera (for shooting and displaying)
Recording system	
Still pictures	: Digital recording, JPEG (in accordance with Design rule for Camera File system (DCF))
Applicable standards	: Exif 2.2, Digital Print Order Format (DPOF), PRINT Image Matching III, PictBridge
Sound with still pictures	: Wave format
Movie	: AVI Motion JPEG
Memory	: Internal memory SD/SDHC/SDXC memory cards
No. of effective pixels	: 10,000,000 pixels
Image pickup device	: 1/1.6" CCD (primary color filter)
Lens	: Olympus lens 6 to 24 mm, f1.8 to 2.5 (equivalent to 28 to 112 mm on a 35 mm camera)
ND filter	: 3EV equivalent
Photometric system	: Digital ESP, center-weighted, and spot metering using the camera image sensor
Shutter speed	: 60 to 1/2000 sec., Bulb shooting
Shooting range	: 0.6 m (2.0 ft.) to ∞ (W), 0.6 m (2.0 ft.) to ∞ (T) (normal) 0.1 m (0.3 ft.) to ∞ (W), 0.3 m (1.0 ft.) to ∞ (T) (macro mode) 0.01 m (0.03 ft.) to 0.6 m (2.0 ft.) (super macro mode)
Monitor	: 3.0" organic EL display, 610,000 dots
Connector	: USB/AV-out connector (multi-connector), HDMI micro connector (type D), accessory port
Automatic calendar system	: 2000 up to 2099
Operating environment	
Temperature	: 0 °C to 40 °C (32 °F to 104 °F) (operation)/ -20 °C to 60 °C (-4 °F to 140 °F) (storage)
Humidity	: 30 % to 90 % (operation)/10 % to 90 % (storage)
Power supply	: One Olympus lithium ion battery (LI-50B)
Dimensions	: 110.6 mm (W) × 64.8 mm (H) × 42.3 mm (D) (4.4 × 2.6 × 1.7 in.) (excluding protrusions)
Weight	: 275 g (9.7 oz) (including battery, card, and cap)

Lithium ion battery (LI-50B)

Product type	: Lithium ion rechargeable battery
Standard voltage	: DC 3.6 V
Standard capacity	: 925 mAh
Battery life	: Approx. 300 full charges (varies on usage)
Operating environment	
Temperature	: 0°C to 40°C (32°F to 104°F) (charging)/ -10°C to 60°C (14°F to 140°F) (operation)/ -20°C to 35°C (-4°F to 95°F) (storage)

USB-AC adapter (F-2AC)

Model No.	: F-2AC-1A/F-2AC-2A/F-2AC-1B/F-2AC-2B/F-2AC-1C/F-2AC-3C/F-2AC-4C/ F-2AC-5C
Power requirements	: AC 100 to 240 V (50/60 Hz)
Output	: F-2AC-1A/F-2AC-2A/F-2AC-1B/F-2AC-2B: DC 5 V, 500 mA F-2AC-1C/F-2AC-3C/F-2AC-4C/F-2AC-5C: DC 5 V, 550 mA
Operating environment	
Temperature	: 0 °C to 40 °C (32 °F to 104 °F) (operation)/ -20 °C to 60 °C (-4 °F to 140 °F) (storage)

Design and specifications subject to change without notice.

HDMI, the HDMI Logo and High-Definition Multimedia Interface are trademarks or registered trademarks of HDMI Licensing LLC.

HDMI™
HIGH-DEFINITION MULTIMEDIA INTERFACE

OLYMPUS KOREA CO., LTD.

10F, Olympus Tower A, 114-9, Samsung-dong, Gangnam-gu, Seoul, Korea. 135-090
<http://www.olympus.co.kr> Tel. 1544-3200

OLYMPUS (MALAYSIA) SDN. BHD.

10-6, Menara 1 MK, Kompleks '1 Mont Kiara', No.1, Jalan Kiara, Mont Kiara, 50480
Kuala Lumpur, Malaysia.
Tel:+603 6203 3882/ Fax:+603 6203 3885

BRANCHES:

PENANG OFFICE

Suite 3A-6, Level 3A, Wisma Great Eastern
No.25, Lebuhr Light, 10200 Penang
Tel:+604 262 2832/ Fax:+604 262 5832

KUCHING OFFICE

Level 6-5A, 6th Floor Menara MAA,
Lot 86, Section 53,
Jalan Central Timur,
93300 Kuching, Sarawak
Tel:+6082 253 885/ Fax:+6082 256 885

<http://www.olympus.com.my>

OLYMPUS

<http://www.olympus.com/>

OLYMPUS IMAGING CORP.

Shinjuku Monolith, 3-1 Nishi-Shinjuku 2-chome, Shinjuku-ku, Tokyo, Japan

OLYMPUS IMAGING AMERICA INC.

3500 Corporate Parkway, P.O. Box 610, Center Valley, PA 18034-0610, U.S.A. Tel. 484-896-5000

Technical Support (USA)

24/7 online automated help:

<http://www.olympusamerica.com/support>

Phone customer support: Tel. 1-888-553-4448 (Toll-free)

Our phone customer support is available from 9 am to 9 pm
(Monday to Friday) ET

<http://olympusamerica.com/contactus>

Olympus software updates can be obtained at:

<http://www.olympusamerica.com/digital>

OLYMPUS EUROPA HOLDING GMBH

Premises: Wendenstrasse 14-18, 20097 Hamburg, Germany
Tel: +49 40-23 77 3-0 / Fax: +49 40-23 07 61

Goods delivery: Bredowstrasse 20, 22113 Hamburg, Germany
Letters: Postfach 10 49 08, 20034 Hamburg, Germany

European Technical Customer Support:

Please visit our homepage <http://www.olympus-europa.com> or call our TOLL FREE NUMBER* : **00800 - 67 10 83 00**
for Austria, Belgium, Denmark, Finland, France, Germany, Italy, Luxembourg, Netherlands, Norway, Portugal, Spain, Sweden, Switzerland, United Kingdom
* Please note some (mobile) phone services providers do not permit access or request an additional prefix to +800 numbers.

For all European Countries not listed and in case that you can't get connected to the above mentioned number, please make use of the following
CHARGED NUMBERS: **+49 180 5 - 67 10 83** or **+49 40 - 237 73 4899**

Our Technical Customer Support is available from 9 am to 6 pm MET (Monday to Friday)

OLYMPUS IMAGING CHINA CO.,LTD.

Customer Support: 400-650-0303 Homepage: <http://www.olympus.com.cn>

Customer Service Center:

A8F, Ping An International Financial Center, No. 1-3,
Xinyuan South Road, Chaoyang District, Beijing
Tel: +86-10-58199199 Fax: +86-10-59761360 Zip: 100027

A,32F Shanghai Industrial Investment Building 18
Cao Xi Road(N), Xuhui District, Shanghai
Tel: +86-21-60823500 Fax: +86-21-60823100 Zip: 200030

Rm.1605-1608, Guangzhou International Electronic tower, No403,
Huan Shi East Road, Guang Zhou
Tel: +86-20-61227111 Fax: +86-20-61227120 Zip: 510095
16F Huamin Hanzun Internation Plaza, No.1, Fuxing Street,
Chengdu
Tel: +86-28-86703531 Fax: +86-28-86703532 Zip: 610016

OLYMPUS HONG KONG AND CHINA LIMITED

Digital Camera Repair Centre
L4207, Office Tower, Langham Place, 8 Argyle Street, Mongkok, Kowloon, Hong Kong
Customer Hotline: +852-2376-2150 Fax: +852-2375-0630
<http://www.olympus.com.hk>