

SAMSUNG

10.1 Megapixels of
Visual Brilliance



NV11 User Manual

Thank you for buying a Samsung camera.

This manual will guide you through using the camera, including capturing images, downloading images and using the application software.

Please read this manual carefully before using your new camera.

ENGLISH

• Instructions

- Use this camera in the following order.

Set up the camera driver

Before connecting the camera to a PC, via the USB cable, you will need to set up the camera driver. Install the camera driver that is contained in Application software CD-ROM. (p.73)

Take a picture

Take a picture. (p.18)

Insert the USB cable

Insert the supplied USB cable into the PC's USB port and the camera's USB connection terminal. (p.75)

Check the camera's power

Check the camera's power. If the power is turned off, press the camera button to turn it on.

Check [Removable Disk]

Open Windows EXPLORER and search for [Removable Disk]. (p.76)

- If you use a card reader to copy the images on the memory card to your PC, the images could be damaged. When transferring the images taken with the camera to your PC, be sure to use the supplied USB cable to connect the camera to your PC. Please note that the manufacturer accepts no responsibility for loss or damage of images on the memory card due to the use of a card reader.

• Getting to know your camera

Thank you for buying a Samsung Digital Camera.

- Prior to using this camera, please read the user manual thoroughly.
 - When you require After Sales service, please bring the camera and the cause of the camera malfunction (such as battery, Memory card etc.) to the A/S centre.
 - Please check that the camera is operating properly before you intend to use it (e.g. for a trip or an important event) to avoid disappointment. Samsung camera takes no responsibility for any loss or damages that may result from camera malfunction.
 - Keep this manual in a safe place.
 - If you use a card reader to copy the images on the memory card to your PC, the images could be damaged. When transferring the images taken with the camera to your PC, be sure to use the supplied USB cable to connect the camera to your PC. Please note that the manufacturer accepts no responsibility for loss or damage of images on the memory card due to the use of a card reader.
 - The contents and illustrations of this manual are subject to change without prior notice for upgrading the camera functions.
 - If your camera was purchased outside of the country where you wish to have, servicing fees are charged by the manufacturer's representatives in that country.
 - In some countries where this camera is not in market, servicings may not be available.
- * Microsoft, Windows and Windows logo are registered trademarks of Microsoft Corporation incorporated in the United States and/or other countries.
- * All brand and product names appearing in this manual are registered trademarks of their respective companies.

Danger

DANGER indicates an imminently hazardous situation which, if not avoided, will result in death or serious injury.

- Do not attempt to modify this camera in any way. To do so may result in fire, injury, electric shock or severe damage to you or your camera. Internal inspection, maintenance and repairs should only be carried out by your dealer or Samsung Camera Service centre.
- Please do not use this product in close proximity to flammable or explosive gases, as this could increase the risk of explosion.
- Should any form of liquid or a foreign object enter the camera, do not use it. Switch off the camera, and then disconnect the power source. You must contact your dealer or Samsung Camera Service centre. Do not continue to use the camera as this may cause a fire or electric shock.
- Do not insert or drop metallic or inflammable foreign objects into the camera through access points e.g. the memory card slot and battery chamber. This may cause a fire or electric shock.
- Do not operate this camera with wet hands. This could pose a risk of electric shock.

Warning

WARNING indicates a potentially hazardous situation which, if not avoided, could result in death or serious injury.

- Do not use the flash in close proximity to people or animals. Positioning the flash too close to your subject's eyes may cause eyesight damage.
- For safety reasons keep this product and accessories out of reach of children or animals to prevent accidents e.g.
 - Swallowing battery or small camera accessories. If an accident should occur, please consult a doctor immediately.
 - There is the possibility of injury from the camera's moving parts.
- Battery and camera may become hot during prolonged use and it may result in camera malfunction. Should this be the case, let the camera sit idle for a few minutes to allow it time to cool.
- Do not leave this camera in places subject to extremely high temperatures, such as a sealed vehicle, direct sunlight or other places of extreme variances in temperature. Exposure to extreme temperatures may adversely affect the camera's internal components and could cause a fire.
- When in use, do not cover the camera or Charger. This may cause heat to build up and distort the camera body or cause a fire. Always use the camera and its accessories in a well-ventilated area.

Caution

CAUTION indicates a potentially hazardous situation which, if not avoided, may result in a minor or moderate injury.

- Leaking, overheating, or damaged battery could result in fire or injury.
 - Use battery with the correct specification for the camera.
 - Do not short circuit, heat or dispose of battery in fire.
 - Do not insert the battery with the polarities reversed.
- Remove the battery when not planning to use the camera for a long period of time. Otherwise the battery may leak corrosive electrolyte and permanently damage the camera's components.
- Do not fire the flash while it is in contact with hands or objects. Do not touch the flash after using it continuously. It may cause burns.
- Do not move the camera while it is switched on when you are using the AC Charger. After use, always switch off the camera before unplugging the cable from the wall socket. Then make sure that any connector cords or cables to other devices are disconnected before moving the camera. Failure to do so may damage the cords or cables and cause a fire or electric shock.
- Take care not to touch the lens or lens cover to avoid taking an unclear image and possibly causing camera malfunction.
- Avoid obstructing the lens or the flash when you capture an image.
- Before inserting any cables or AC adapter, check the directions and do not insert by force. It may cause breakage of cable or camera.
- Credit cards may be demagnetized if left near a camera case. Avoid leaving magnetic strip cards near the case.

Contents

READY

- System chart5
- Identification of features6
 - Front & Top6
 - Back & Bottom7
 - Bottom8
 - Self-timer lamp8
 - Camera Status Lamp8
 - Mode dial9
 - Mode icon10
- Connecting to a Power Source ...10
- How to charge the rechargeable battery (SLB-1137D)12
- Inserting the memory card13
- Instructions on using the memory card...13

RECORDING

- When Using the Camera for the First Time : Smart button15
- When Using the Camera for the First Time : Setting up the Date / Time and Language16
- LCD monitor indicator17
- Starting the recording mode18

- How to use the AUTO mode18
- How to use the PROGRAM mode...18
- How to use the ASM mode.....18
- How to use the APERTURE PRIORITY mode19
- How to use the SHUTTER PRIORITY mode19
- How to use the MANUAL mode...19
- How to use the ASR (Advanced Shake Reduction) mode20
- How to use the SPECIAL EFFECT mode...20
- How to use the SCENE mode ...20
- How to use the MOVIE CLIP mode...21
- To record a movie clip without voice...21
- Pausing while recording a movie clip (Successive Recording).....21
- Using Successive Recording21
- Things to Watch Out for When Taking Pictures22
- Using the camera buttons to set the camera23
 - POWER button23
 - Shutter button23
 - ZOOM W / T button24
 - Face recognition(FR) button25

Contents

- Using the LCD monitor to set the camera26
 - Color tone27
 - Brightness28
 - Selecting focus type28
 - Flash30
 - Size31
 - Continuous shot32
 - Metering32
 - Sharpness33
 - Effect33
 - Quality / Frame rate34
 - Self-timer / Remote control34
 - Voice recording / Voice memo35
 - Exposure compensation36
 - ISO36
 - White balance37
 - Scene menu38
 - Special Effect : Photo Frame38
 - Special Effect : Motion GIF39
 - Special Effect : Composite shooting39
 - Shutter Speed40
 - Aperture Value41
 - Photo Gallery mode41

PLAY

- Starting play mode44
 - Playing back a still image44
 - Playing back a movie clip44
 - Movie clip capture function45
 - On camera movie trimming45
 - Playing back a recorded voice45
 - Playing back a recorded voice memo46
- LCD monitor indicator46
- Using the camera buttons to adjust the camera47
 - Play mode button47
 - BACK button47
 - Thumbnail / Enlargement button47
 - Starting the slide show48
 - Protecting images49
 - Deleting images50
 - DPOF50
 - DPOF : STANDARD51
 - DPOF : Print size51
 - DPOF : Index52
 - Rotating an image52
 - Resize53
 - Trimming54

- Effect54
- Motion GIF55
- Red eye fix55
- PictBridge56

SETUP

- Setup menu58
 - OSD set60
 - File name60
 - Language61
 - Setting up the Date / Time / Date type61
 - Imprinting the recording date61
 - LCD brightness61
 - Auto Focus lamp62
 - Auto power off62
 - Quick view62
 - Start up image62
 - Sound Volume63
 - Operation Sound63
 - Start up sound63
 - Shutter sound63
 - Formatting a memory63
 - Delete All64
 - Copy To Card64
 - Selecting Video out type65

- Initialisation65
- Important notes66
- Warning indicator67
- Before contacting a service centre68
- Specifications70

SOFTWARE

- Software Notes72
- System Requirements72
- About the software72
- Setting up the application software73
- Starting PC mode75
- Removing the removable disk77
- Setting up the USB Driver for MAC78
- Using the USB Driver for MAC78
- Removing the USB Driver for Windows 98SE78
- Digimax Master79
- Digimax Biz Reader81
- FAQ84

System chart

Please check that you have the correct contents before using this product. The contents can vary depending on the sales region. To buy the optional equipment, contact your nearest Samsung dealer or Samsung service centre.

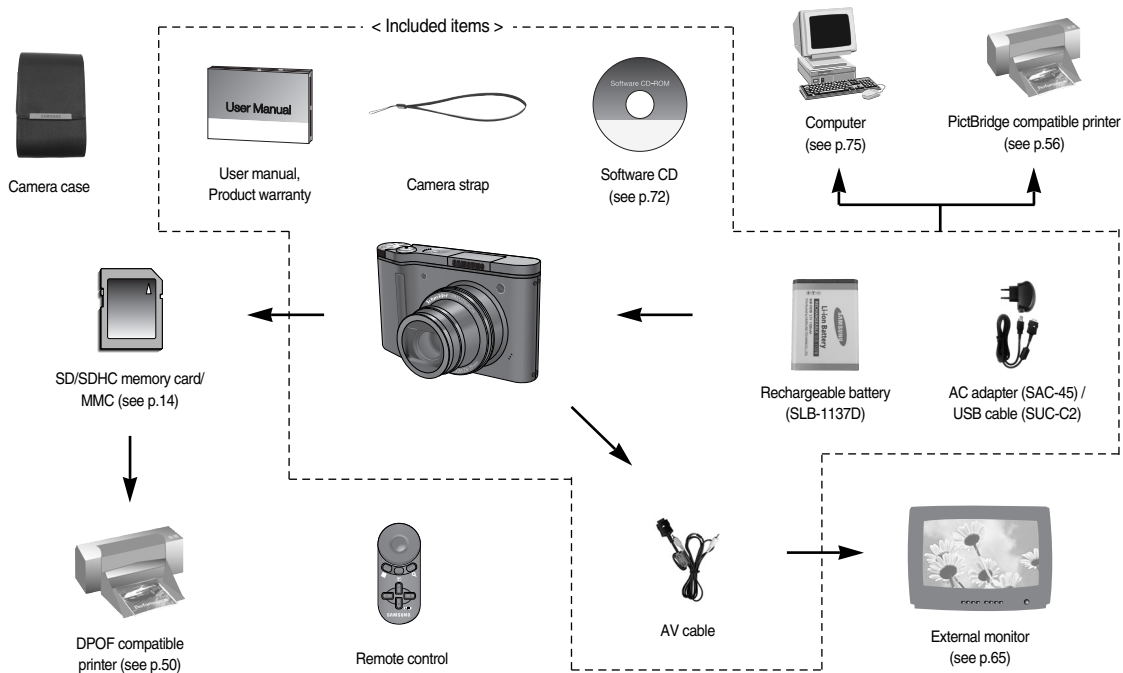

• Identification of features

Front & Top

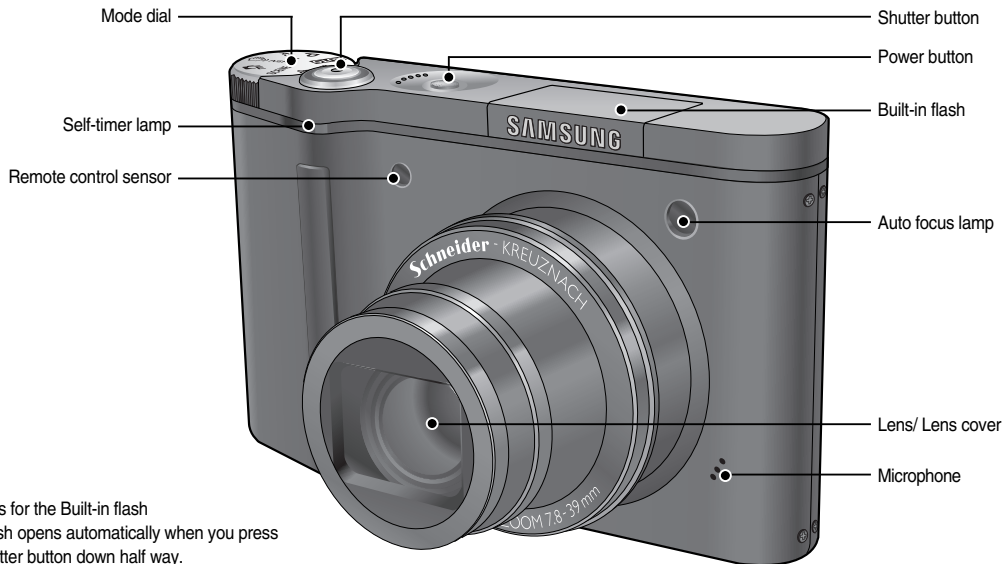

※ Instructions for the Built-in flash

- The flash opens automatically when you press the shutter button down half way.
- Do not open the flash by force.
It may break the camera.
- Close the flash when you are not using it to prevent breakage.

• Identification of features

Back & Bottom

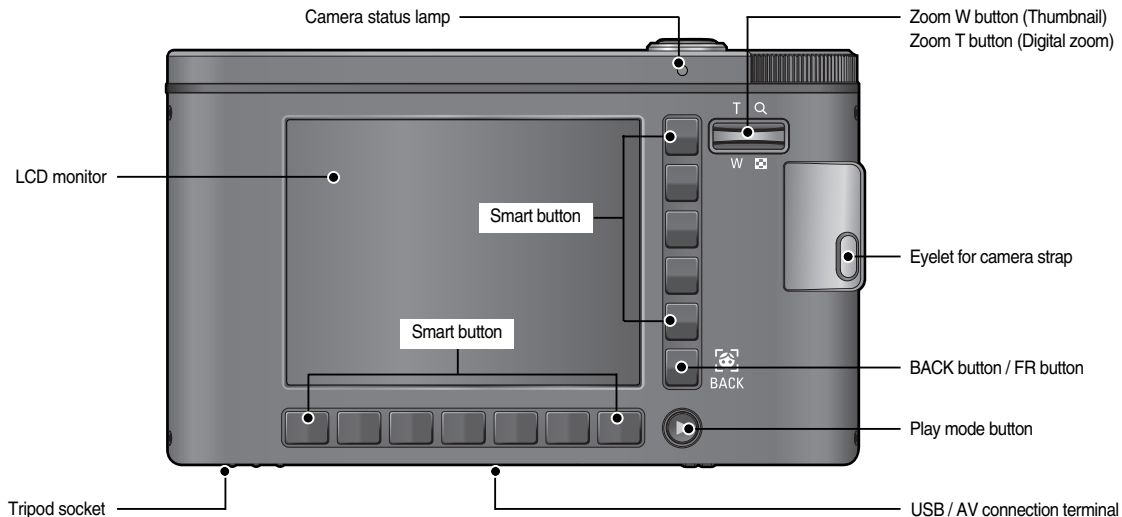

• Identification of features

Bottom

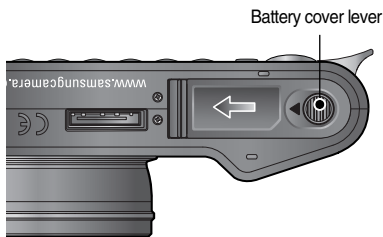
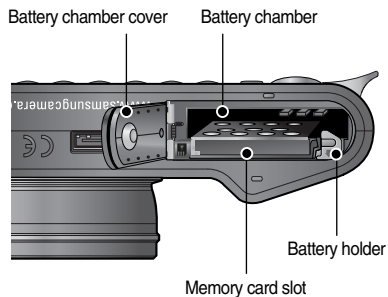

※ To open the battery chamber cover, slide it in the direction shown above.

■ Self-timer lamp

Icon	Status	Description
	Blinking	- For the first 7 seconds, the lamp blinks at 1 second intervals. - For the final 3 seconds, the lamp blinks quickly at 0.25-second intervals.
	Blinking	For 2 seconds, the lamp blinks quickly at 0.25-second intervals before taking a picture
	Blinking	A picture will be taken after about 10 seconds and 2 seconds later a second picture will be taken.
	Blinking	Pressing the remote control shutter button will allow an interval of 2 seconds before the image is taken.

■ Camera Status Lamp

Status	Description
After taking a picture	The lamp blinks while saving the image and then turns off when ready to take another picture
While voice memo recording	The lamp blinks
When the USB cable is inserted to a PC	The lamp lights up (LCD monitor turns off after initializing the device)
Transmitting Data with a PC	The lamp turns on (LCD monitor turns off)
When the USB cable is connected to a printer	The lamp is off
When the printer is printing	The lamp blinks
When the AF activates	The lamp lights (The subject is in focus)
	The lamp blinks (The subject is not in focus)

• Identification of features

■ Mode dial

You can select the desired working mode by using the mode dial located on the top of the camera.

● AUTO mode

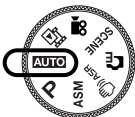

Select this mode for quick and easy picture taking with minimal user interaction.

● PROGRAM mode



Selecting the program mode will configure the camera with optimal settings. You can still manually configure all functions except the aperture value and shutter speed.

● ASM mode

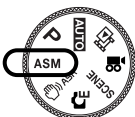

You can manually configure all functions including the aperture value and shutter speed.

● ASR mode

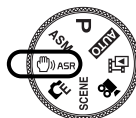

Advanced Shake Reduction (ASR) mode. This mode will reduce camera shake and help you get a clearer image.

● SPECIAL EFFECT mode



It is possible to add special effects to your images by using this mode.

● SCENE mode

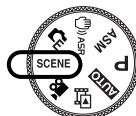

Use the menu to easily configure optimal settings for a variety of shooting situations.

Identification of features

MOVIE CLIP mode

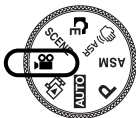

A movie clip can be recorded for as long as the available recording time of the memory capacity allows.

PHOTO GALLERY mode



The saved images can be reviewed with music or various effects in this mode.

Mode icon

MODE	AUTO	PROGRAM	A	S	M	
Icon						
MODE	ASR	SPECIAL EFFECT	MOVIE	PHOTO GALLERY	PLAY	
Icon						
MODE	SCENE					
	NIGHT	PORTRAIT	CHILDREN	LANDSCAPE	BIZ	CLOSE UP
Icon						
MODE	TEXT	SUNSET	DAWN	BACKLIGHT	FIREWORKS	BEACH&SNOW
Icon						

Connecting to a Power Source

- You should use the rechargeable battery (SLB-1137D) supplied with the camera. Be sure to charge the battery before using the camera.
- SLB-1137D rechargeable battery Specification

Model	SLB-1137D
Type	Lithium Ion
Capacity	1100mAh
Voltage	3.7V
Charging time (When the camera is turned off)	About 150 Min.

- Number of images and battery life : Using the SLB-1137D

Still image		Movie	
Battery life	Number of images	Recording time	
Approx. 110 MIN	Approx. 220	Approx. 100 MIN	
Based on the following shooting conditions	Using the fully charged battery, Auto mode, 10M image size, Fine image quality, Shot to shot interval : 30Sec.	Based on the following shooting conditions	Using the fully charged battery
	Changing the zoom position between the Wide and the Tele after every shot.		640X480 image size
	Using the flash on every second shot.		30fps frame rate
	Using the camera for 5 minutes and then Powering it off for 1 minute.		

※ These figures are measured under Samsung's standard conditions and shooting conditions and may vary depending on the user's methods.

• Connecting to a Power Source

INFORMATION

Important information about battery usage.

- When the camera is not used, turn off the camera power.
- Please remove the battery if the camera will not be used for long periods. Battery can lose power over time and are prone to leaking if kept inside the camera.
- Low temperatures (below 0°C) can affect the performance of the battery and you may experience reduced battery life.
- Battery will usually recover at normal temperatures.
- During extended use of the camera, the camera body may become warm. This is perfectly normal.

- You can charge the rechargeable battery (SLB-1137D) by using an SAC-45 KIT. The SAC-45 consists of the AC adapter (SAC-45) and the USB cable (SUC-C2). When the AC adapter and the USB cable are assembled, it can be used as an AC cable.

- Using the SAC-45 as an AC charger
: Insert the AC adapter into the USB connector.
When the AC adapter is inserted, it can be used as an AC charger.



- Using the SAC-45 as an USB cable
: Remove the AC adapter from the USB connector.
You can transmit data with a PC (p.75) or charge the battery.

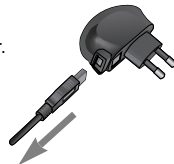

CAUTION

In the following cases, the battery may not be charged.

- When using the USB cable that was not supplied with this camera. Use the supplied USB cable.
- When using a USB hub. Connect the camera to the PC directly.
- When other USB devices are connected to the PC. Disconnect the other USB devices.
- When the USB is connected to the USB port located on the front of the computer. Use the USB located on the back of the computer.
- If the USB port of the PC doesn't meet the Power output standard (5V, 500mA), the camera may not be charged.

• Connecting to a Power Source

- How to charge the rechargeable battery (SLB-1137D)
 - Charging with the camera

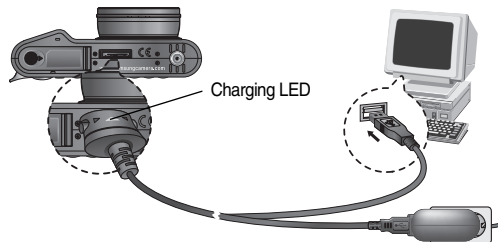

- Charging LED of the AC Adapter

	Charging LED
Being Charged	Red LED is on
Charging is complete	Green LED is on
Charging error	Red LED is off or blinking
Being discharged (Using the AC adapter)	Orange coloured LED is on

CAUTION



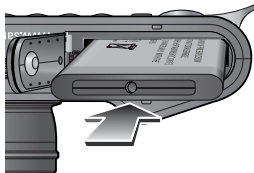

- Before inserting any cables or AC adapter, check the directions and do not insert by force. It may cause damage to the cable or camera.
- If the charging LED of the AC Charger does not turn on or blink after inserting the rechargeable battery, please check whether the battery is inserted correctly.
- If you charge the battery with the camera power on, the battery can't charge fully. Turn the camera off while charging the battery.
- If you insert the fully discharged battery to charge it, do not turn on the camera at the same time. The camera may not be turned on because of the low battery capacity. Charge the battery for more than 10 minutes before using the camera.
- Do not use the flash frequently or take a movie clip with a fully discharged battery that has only been charged for a short time.

Connecting to a Power Source

- Insert the battery as shown
 - If the camera does not turn on after you have inserted battery, please check whether the battery is inserted with the correct polarity (+ / -).
 - Do not use force to open the battery chamber. This may damage the battery chamber cover.



- There are 4 indicators for battery condition that are displayed on the LCD monitor.

Battery indicator				
Battery status	The battery is fully charged	Low battery capacity (Prepare to recharge or use spare battery)	Low battery capacity (Prepare to recharge or use spare battery)	Low battery capacity (Prepare to recharge or use spare battery)

Inserting the memory card

- Turn off the camera's power before inserting the memory card.
 - Insert the memory card as shown.
 - Have the front of the memory card facing toward the back of the camera (LCD monitor) and the card pins toward the front of the camera (Lens).
 - Do not insert the memory card the wrong way round. Doing so may damage the memory card slot.

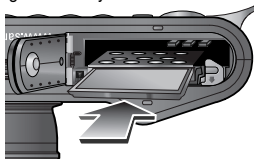

Instructions on using the memory card

- Be sure to format the memory card (see p.63) if you are using a newly purchased memory for the first time, if it contains data that the camera cannot recognise, or if it contains images captured with a different camera.
- Turn off the camera power whenever the memory card is being inserted or removed.
- Repeated use of the memory card will eventually reduce its performance. Should this be the case, you will need to purchase a new memory card. Wear and tear on the memory card is not covered by the Samsung warranty.
- The memory card is an electronic precision device. Do not bend, drop or subject it to any heavy impact.
- Do not store the memory card in an environment with strong electronic or magnetic fields, e.g. near loudspeakers or TV receivers.
- Please do not use or store in an environment where there are extremes in temperature.
- Do not allow the memory card to become dirty or to come into contact with any liquid. Should this happen, clean the memory card with a soft cloth.
- Please keep the memory card in its case when not in use.
- During and after periods of extended use, you may notice that the memory card is warm. This is perfectly normal.
- Do not use a memory card that is used in another digital camera. To use the memory card in this camera, format the memory card using this camera.
- Do not use a memory card formatted by another digital camera or memory card reader.

● Instructions on using the memory card

- If the memory card is subjected to any of the following, the recorded data may become corrupted :
 - When the memory card is used incorrectly.
 - If the power is switched off or the memory card is removed while recording, deleting (formatting) or reading.
- Samsung cannot be held responsible for lost data.
- It is advisable to copy important data onto other media as back-up e.g. floppy disks, hard disks, CD etc.
- If there is insufficient memory available : A [Memory Full!] message will appear and the camera will not operate.
To optimise the amount of memory in the camera, replace the memory card or delete unnecessary images stored on the memory card.

- The camera can use SD/SDHC Memory Cards and MMC (Multi Media Cards).
When using MMC cards, please consult the instructions supplied with the cards.

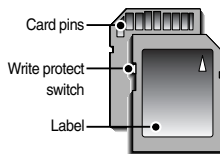

[SD (Secure Digital) memory card]

The SD/SDHC memory card has a write protect switch that prevents image files from being deleted or formatted. By sliding the switch towards the bottom of the SD/SDHC memory card, the data will be protected. By sliding the switch towards the top of the SD/SDHC memory card, the data protection will be cancelled. Slide the switch to the top of the SD/SDHC memory card before taking a picture.

- When using a 256MB MMC memory, the specified shooting capacity will be as follows. These figures are approximate as image capacities can be affected by variables such as subject matter and memory card type.

Recorded image size	Super Fine	Fine	Normal	30FPS	15FPS	
Still image	10M	49	94	136	-	-
	9M P	55	105	151	-	-
	7M	65	124	177	-	-
	7M W	64	122	174	-	-
	5M	87	163	228	-	-
	3M	122	221	303	-	-
* Movie	640	-	-	-	00:12:42	00:20:51
	320	-	-	-	00:30:34	00:57:49

- * The recording times can be affected by the zoom operation.
The zoom button doesn't operate while recording movies.

INFORMATION

- Don't remove the memory card when the camera status lamp is blinking as this may cause damage to data in the memory card.

• When Using the Camera for the First Time : Smart button

- This button is used for shifting the menu cursor to select or for confirming the selected menu.



[Selecting the main menu :
Touching the button]

[Confirming the main menu :
Pressing the button]

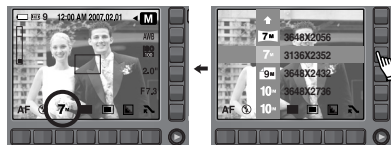

[Confirming the sub menu :
Pressing the button]

[Selecting the sub menu :
Touching the button]

- To select a sub menu, in some menus, touch the button and slide your finger to the left / right.

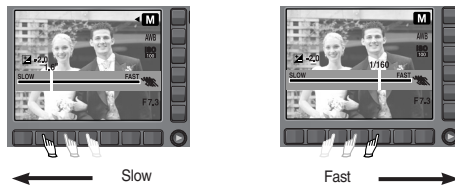

Slow

Fast

[e.g. : Selecting the shutter speed]

- Extending the menus : Press the extension menu button and more available menus will display.

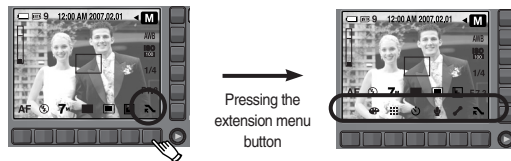

Pressing the
extension menu
button

- ※ The LCD monitor will be dark when some menus are selected. After selecting the menu, the LCD monitor returns to the brightness set as before.

• When Using the Camera for the First Time : Setting up the Date / Time and Language

- When the camera is turned on for the first time, a menu will be displayed in the LCD monitor to set date, time and language. This menu will not be displayed again after setting up the date, time and language. Set up the date, time and language before using this camera.

- Setting up the language

1. Press the [Language] menu button.
2. Select a desired language by pressing the vertical smart button.



- Setting up the date, time and date type

1. Press the [Date&Time] menu button.
2. Select a desired date type by pressing the vertical smart button.



3. To change the date, select the [2007/02/01] menu and press the vertical smart button.
4. To select Year / Month / Day and Hour : Minute, press the horizontal smart button. To change the numbers, press the vertical smart button.



INFORMATION

- You can select any one of 22 languages. These are listed below :
 - English, Korean, French, German, Spanish, Italian, S.Chinese, T.Chinese, Japanese, Russian, Portuguese, Dutch, Danish, Swedish, Finnish, Thai, BAHASA (MALAY / INDONESIAN), Arabic, Polish, Hungarian, Czech and Turkish.
- Even if the camera is restarted, the language setting will be maintained.

• LCD monitor indicator

- The LCD monitor displays information about the shooting functions and selections.

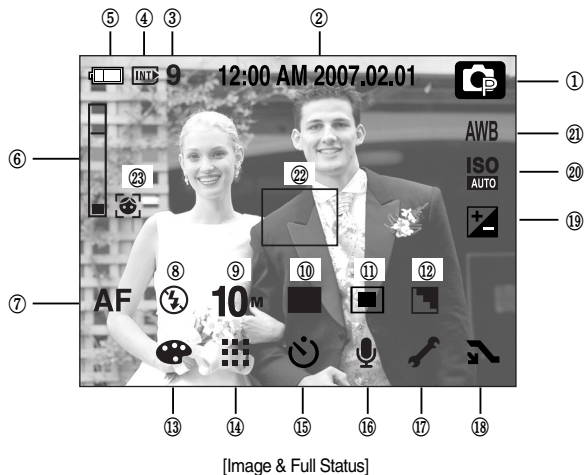

No.	Description	Icons	Page
1	Recording mode		p.9~10
2	Date / Time	12:00 AM 2007.02.01	p.61
3	Number of available shots remaining	9	p.14
	Remaining time (Movie clip/ Voice recording)	00:01:00/01:00:00	

No.	Description	Icons	Page
4	Card inserted indicator		p.13
5	Battery		p.13
6	Optical / Digital Zoom bar / Digital Zoom rate	x5.0	p.24~25
7	Focus mode	MF AF	p.28~29
8	Flash		p.30~31
9	Image size	10M 9M 7M 7M 5M 3M 1M	p.31
10	Shooting mode		p.32
11	Metering		p.32
12	Sharpness		p.33
13	Special Effect	NOR BW S B R G	p.33
14	Image quality / Frame rate		p.34
15	Self-timer	OFF	p.34~35
16	Voice Recording / Without Sound	OFF	p.35~36/p.21
17	Setup menu		p.58~59
18	Extension menu		p.15
19	Exposure compensation		p.36
20	ISO	ISO AUTO 80 100 200 400 800 1600	p.36
21	White Balance	AWB	p.37
22	Auto focus frame		-
23	Face Recognition		p.25~26

Starting the recording mode

■ How to use the AUTO mode (**AUTO**)

Please select this mode for quick and easy picture taking with minimal user interaction.

1. Insert the battery (p.13) taking note of the correct polarity (+ / -).
2. Insert the memory card (p.13). As this camera has a 20MB internal memory, it is not essential to insert the memory card. If the memory card is not inserted, an image will be stored in the internal memory. If the memory card is inserted, an image will be stored on the memory card.
3. Close the battery chamber cover.
4. Press the power button to turn on the camera.
(If the date / time that is displayed on the LCD monitor is incorrect, reset the date / time before taking a picture.)
5. Select the Auto mode by rotating the mode dial.
6. Point the camera towards the subject and compose the image by using the LCD monitor.
7. Press the shutter button to capture an image.



[AUTO mode]

■ How to use the PROGRAM mode (**P**)

Selecting the program mode will configure the camera with optimal settings. You can still manually configure all functions except the aperture value and shutter speed.

1. Select the Program mode by rotating the mode dial.
2. Press the horizontal smart button to configure advanced functions such as image size (p.31), quality (p.34), metering (p.32) and continuous shooting (p.32).

※ Refer to page 27-41 for more information about the menus.



[PROGRAM mode]

■ How to use the ASM mode (**ASM**)

● How to select the A, S or M mode

1. Select the ASM mode by rotating the mode dial.
2. Select the A, S or M mode by using the smart button.

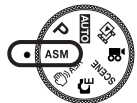

[A, S or M mode]

INFORMATION

- If the auto focus frame turns to red when you press the shutter button down half way, it means that the camera cannot focus on the subject. Should this be the case, the camera is unable to capture an image clearly.

Starting the recording mode

- How to use the APERTURE PRIORITY mode (**A**)

This mode will set the aperture value for automatic exposure depends on the brightness of the object by automatic shutter speed setting in the camera.

1. Select the ASM mode by rotating the mode dial.
2. Select the APERTURE PRIORITY mode (**A**) by using the smart button.
3. Set the desired aperture value by using the smart button. (p.41)
4. Point the camera towards the subject and compose the image by using the LCD monitor.
5. Press the shutter button to capture an image.

※ Smaller Aperture values make the object sharp but blur the background. Larger Aperture values make both the object and background sharp.

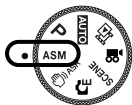

[APERTURE PRIORITY mode]

- How to use the SHUTTER PRIORITY mode (**S**)

This mode will set the shutter speed for automatic exposure depending on the brightness of the subject.

1. Select the ASM mode by rotating the mode dial.
2. Select the SHUTTER PRIORITY mode (**S**) by using the smart button.
3. Set the desired shutter speed by using the smart button. (p.40)
4. Point the camera towards the subject and compose the image by using the LCD monitor.
5. Press the shutter button to capture an image.

※ High Shutter speeds can 'freeze' a moving object as if it was not moving. Low Shutter speeds can capture a moving object with a blurred or 'active' effect.

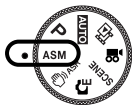

[SHUTTER PRIORITY mode]

- How to use the MANUAL mode (**M**)

The user can manually set both the aperture value and the shutter speed.

1. Select the ASM mode by rotating the mode dial.
2. Select the MANUAL mode (**M**) by using the smart button. (p.40-41)
3. Select the desired shutter speed and aperture value by using the smart button.
4. Point the camera towards the subject and compose the image by using the LCD monitor.
5. Press the shutter button to capture an image.

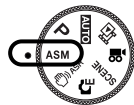

[MANUAL mode]

Starting the recording mode

- How to use the ASR (Advanced Shake Reduction) mode ( ASR)

This mode will reduce the effect of camera shake and help you get a well-exposed image in dim conditions.

- Things to watch out for using the ASR mode

1. The digital zoom will not operate in the ASR mode.
2. If the lighting conditions are brighter than fluorescent lighting condition, the ASR doesn't activate.
3. If the subject is moving the final image captured may be blurred.
4. Avoid moving the camera while the [Capturing!] message is displayed to achieve a better result.
5. As the ASR uses the camera's digital processor, images taken using the ASR may take a little longer for the camera to process.



- How to use the SPECIAL EFFECT mode ()
It is possible to add special effects to your images by using this mode. Select the Special Effect mode by rotating the mode dial.

※ Refer to page 38~40 for more information about the special effect menus.



- How to use the SCENE mode (**SCENE**)
Use the menu to easily configure optimal settings for a variety of shooting situations. Select the Scene mode by rotating the mode dial.

※ Refer to page 38 for more information about the menus.

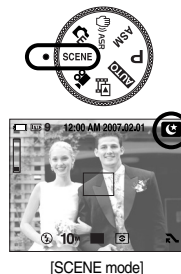

Starting the recording mode

How to use the MOVIE CLIP mode ()

A movie clip can be recorded for as long as the available recording time of the memory capacity allows.

1. Select the MOVIE CLIP mode by rotating the mode dial. (Available recording time will display on the LCD monitor)
2. Point the camera towards the subject and compose the image by using the LCD monitor. Press the shutter button and movie clips are recorded for as long as the available recording time allows. Movie clips will still be recorded if the shutter button is released.

If you wish to stop recording, press the shutter button again.

* Image size and type are listed below.

- Image size : 640X480, 320X240 (Selectable)
- File type : *.avi (MPEG-4)

- ※ The maximum file size of continuous movie clip is 4GB.
- ※ If the recording time is over 6 hours, though the file size is not 4GB, the movie is stopped and saved automatically.
- ※ Before the file size is 4GB or the recording time is 6 hours, the movie can be stopped and saved depending on the movie quality.

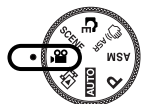

[MOVIE CLIP mode]

To record a movie clip without voice

1. Press the extension menu button.
2. Select the [VOICE] → [OFF] menu.
3. Press the shutter button and movie clip is recorded for as long as the available recording time without voice allows.



[MOVIE CLIP mode]

Pausing while recording a movie clip (Successive Recording)

This camera allows you to temporarily stop during unwanted scenes, while recording a movie clip. Using this function, you can record your favourite scenes into a movie clip without having to create multiple movie clips.

Using Successive Recording

1. Press the shutter button and movie clips are recorded for as long as the available recording time allows. Movie clips will still be recorded if the shutter button is released.
2. Press the II button to pause recording. Press the II button again to resume the recording.
3. If you wish to stop recording, press the shutter button again.



[Successive recording of a movie clip]

• Things to Watch Out for When Taking Pictures

- Pressing the shutter button down half way.
Lightly press the shutter button to confirm focus and flash battery charge.
Press the shutter button all way down to take the picture.

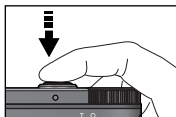

[Lightly press the shutter button]

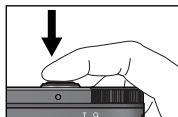

[Press the shutter button]

- The available recording time may vary depending on shooting conditions and camera settings.
- When either the Flash Off or Slow synchro mode is selected in a low lighting condition, the camera shake warning indicator () may appear on the LCD monitor. In this case, use a tripod, support the camera on a solid surface or change to flash shot mode.
- Shooting against the light :
Please do not take pictures into the sun. Taking a picture against the sun may make the picture dark. To take a picture against the light, please use the [Backlight] in the scene shooting mode (see page 38), fill-in flash (see page 30), spot metering (see page 32), or exposure compensation (see page 36).

- Avoid obstructing the lens or the flash when you capture an image.
- Compose the image by using the LCD monitor.
- In some of the following conditions the auto focus system may not perform as expected.
 - When photographing a subject that has little contrast.
 - If the subject is highly reflective or shiny.
 - If the subject is moving at high speed.
 - When there is strong reflected light, or when the background is very bright.
 - When the subject matter has only horizontal lines or the subject is very narrow (such as a stick or flagpole).
 - When the surroundings are dark.

Using the camera buttons to set the camera

- The recording mode function can be set up by using the camera buttons.

POWER button

- Used for turning the camera's power on / off.
- If there is no operation during the specified time, the camera's power will be turned off automatically to save battery life. Refer to page 62 for more information about the auto power off function.

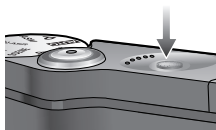

Shutter button

- Used for taking an image or recording voice in the RECORDING mode.
- In MOVIE CLIP mode : Pressing the shutter button down fully starts the process for recording a movie clip. Press the shutter button once and the movie clip is recorded for as long as the available recording time in the memory allows. If you wish to stop recording, press the shutter button again.
- In STILL IMAGE mode : Pressing the shutter button down halfway activates the autofocus and checks the condition of the flash. Pressing the shutter button down fully takes and stores the image. If you select voice memo recording, the recording will start after the camera has finished storing the image data.

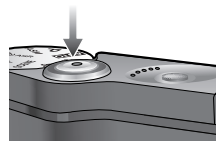

ZOOM W / T button

- If the menu is not displayed, this button works as the OPTICAL ZOOM or DIGITAL ZOOM button.



- This camera has a 5X optical zoom and a 5X digital zoom function. Using both will offer a total zoom ratio of 25X.

TELE Zoom

Optical zoom TELE : Pressing the ZOOM T button will zoom into the subject i.e. the subject will appear nearer.

Digital zoom TELE : When the maximum (5X) optical zoom is selected, pressing the ZOOM T button activates the digital zoom software. Releasing ZOOM T button stops the digital zooming at the required setting. Once the maximum digital zoom (5X) is achieved, pressing the ZOOM T button will have no effect.

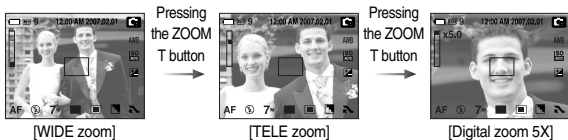
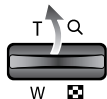

WIDE Zoom

Optical zoom WIDE : Pressing the ZOOM W button. This will zoom out from the subject i.e. the subject will appear farther away. Pressing the ZOOM W button continuously will set the camera to its minimum zoom setting i.e. the subject appears at its farthest from the camera.

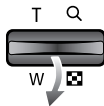

Digital zoom WIDE : When the digital zoom is in operation, pressing the ZOOM W button will reduce the digital zooming in steps. Releasing ZOOM W button stops digital zooming. Pressing the ZOOM W button will reduce the optical zoom and then it will continue to reduce the optical zoom until the minimum setting is reached.

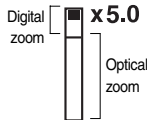

• ZOOM W / T button

INFORMATION

- Images taken using the digital zoom may take a little longer for the camera to process. Allow time for this to take place.
- If the Zoom buttons are being pressed during the Movie clip shots, the voice will not be recorded.
- You may notice a decrease in image quality when using the digital zoom.
- To view a clearer digital zoom image, press the shutter button halfway at the maximum optical zoom position and press the zoom T button again.
- The digital zoom can't be activated in the MOVIE CLIP, ASR, High Speed, Motion Capture mode, [Night], [Children], [Biz], [Close up], [Text] and [Fireworks] scene modes.
- Take care not to touch the lens to avoid taking an unclear image and possibly causing camera malfunction. If the image is dim, turn the camera power off and on again to modify the lens position.
- Take care not to press the lens as this may cause a camera malfunction.
- When the camera is turned on, take care not to touch the camera's moving lens parts as this may cause the resulting image to be dim and unclear.
- You can operate the Wide and Tele zoom by using the remote control.

• Face recognition(FR) button

■ Face recognition

This mode detects the face position of the subject automatically and then sets the focus and exposure. Select this mode for quick and easy face picture.

Selectable modes : Auto, Program, ASR, Effect(GIF), A/S/M, Scene(Portrait, Children, Beach & Snow)

1. Press the FR (Face Recognition) button () in the selectable modes.

The FR icon will be displayed on the screen left side.



2. The size and position of the auto focus frame is set at the face of the subject automatically.



3. Press the shutter button halfway. The focus frame turns to green when the focus is activated.

4. Press the shutter button fully to take a picture.

● Face recognition(FR) button

INFORMATION

- This function can detect up to 8 persons.
- When the camera recognises many people at the same time, it will focus on the nearest person.
- When the camera detect a target face, the white colour focus frame will display over the target face and the gray colour focus frame will display over the rest faces(up to 7). Press the shutter button halfway down to focus the face and the white focus frame turns green.(Total 8)
- Return to previous AF mode if face detection was failure.
- In some conditions this function cannot work properly.
 - When a person wears dark glasses or some part of the face is hidden.
 - When the person being taken does not look at the camera.
 - Camera doesn't detect a face as the brightness is too dark or too bright.
 - The distance between the camera and object are far.
- The maximum available Face Recognition range is 2.1m (Wide).
- The nearer the subject, the faster the camera can recognize the subject.

● Using the LCD monitor to set the camera

- You can use the menu on the LCD monitor to set up recording functions.
(O : Selectable, X : Not selectable, - : Partly selectable)

MENU			ASM			SCENE		page
COLOR	O	X	X	X	X	X	X	p.27
BRIGHT	O	X	X	X	X	X	X	p.28
FOCUS	MANUAL	X	O	O	X	X	X	p.28- 29
	NORMAL	O	O	O	O	O	-	
	AUTO MACRO	O	X	X	X	X	-	
	MACRO	X	O	O	O	O	-	
	SUPRE MACRO	O	O	O	X	O	X	
FLASH	OFF	O	O	O	O	O	-	p.30- 31
	AUTO	O	O	X	X	O	-	
	RED EYE	O	O	X	X	O	-	
	FILL IN	X	O	O	X	O	-	
	SLOW SYNC	X	O	X	X	O	-	
	RED EYE FIX	O	O	X	X	O	-	
SIZE	O	O	O	O	O	O	O	p.31
SHOOTING	SINGLE	O	O	O	O	O	O	p.32
	CONTINUOUS	X	O	O	X	X	X	
	HIGH SPEED	X	O	O	X	X	X	
	MOTION CAPTURE	X	O	O	X	X	X	
	AEB	X	O	X	X	X	X	
QUALITY	O	O	O	O	O	O	O	p.34
TIMER	OFF	O	O	O	O	O	O	p.34- 35
	10SEC	O	O	O	O	O	O	
	2SEC	O	O	O	O	O	O	
	Double	O	O	O	O	X	O	
	REMOTE	O	O	O	O	O	O	

Using the LCD monitor to set the camera

MENU			ASM			SCENE		page
VOICE	O	O	O	O	O	O	O	p.35-36
W/B	X	O	O	X	X	X	O	p.37
ISO	X	O	O	X	X	X	X	p.36
EV	X	O	*1O	X	X	X	O	p.36
METERING	MULTI	O	O	O	O	-	O	p.32
	SPOT	X	O	O	X	-	O	
	CENTER	X	O	O	X	-	O	
SHARPNESS	X	O	O	X	O	X	X	p.33
PHOTO FRAME	X	X	X	X	O	X	X	p.38
M.GIF	X	X	X	X	O	X	X	p.39
COMPOSITE	X	X	X	X	O	X	X	p.39-40
EFFECT	NORMAL	O	O	O	O	-	O	p.33
	B&W	X	O	O	X	-	O	
	SEPIA	X	O	O	X	-	O	
	B	X	O	O	X	-	O	
	R	X	O	O	X	-	O	
	G	X	O	O	X	-	O	
	NEGATIVE	X	O	O	X	-	O	
	CUSTOM	X	X	X	X	O	-	

- ※ Menus are subject to change without prior notice.
- ※ The selectable menus may vary in each scene modes.
- ※ *1 It is not selectable in the MANUAL mode.

Colour tone

- You can add colour tone on the captured image.
Warm menu will increase red colour of the image.
Cool menu will increase blue colour of the image.



- Selecting the colour tone
To select the colour tone, touch the button and slide your finger to the left or right.



[Emphasizing the Cool-colour]



[Emphasizing the Warm-colour]

Brightness

- You can change the brightness of the image.



- Changing the brightness

To select the brightness, touch the button and slide your finger to the left or right.



Selecting focus type

- You can select the focus type in accordance with the subject distance.
The distance ranges are show below.



[Manual]



[Auto]



[Auto Macro]



[Macro]



[Super Macro]

• Selecting focus type

- Types of focus modes and focus ranges (W : Wide, T : Tele)

Focus Type	Wide(W)	Tele(T)
Normal	80cm-Infinity	1.5m-Infinity
Macro	10cm-80cm	50cm-80cm
Auto Macro	10cm-Infinity	50cm-Infinity
Super Macro	1-10cm (Wide only)	
Manual Focus	1cm-Infinity	50-Infinity

INFORMATION

- When the macro mode is selected, it is possible that camera shake will occur. Take care not to shake the camera while taking a picture.
- When you take a picture within 30cm in the Macro mode, select the FLASH OFF mode.

- Manual Focus (MF)

Where the automatic focusing is not available, for example, in very dark conditions, use the manual focus. Please be careful when using the manual focus as the picture can be blurred easily.

You can use the manual focus in the program mode and ASM mode.

- How to set the manual focus

To set to manual focus, touch the button and slide your finger to the left or right.



[Farther focus]



[Closer focus]

- ※ Touching the ①,② button will move the cursor continuously when you change the manual focus.

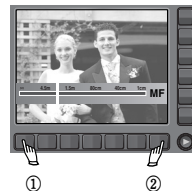

Flash

- You can select the flash type in accordance with the subject distance.
The distance ranges are show below.
- When using the ASR, Continuous shot, High Speed Continuous shot, Motion Capture, AEB, Movie clip mode and Still image mode (except the NIGHT, PORTRAIT, CHILDREN, BACKLIGHT and BEACH & SNOW mode), the flash will not operate.
- ※ When Super macro is selected, the flash is automatically switched off.
- ※ When [CONTINUOUS], [HIGH SPEED], [M. CAPTURE], [AEB] is selected, the flash is automatically switched off.



- Flash range (W : Wide, T : Tele) (Unit : m)









ISO	Normal	Macro	Auto macro
AUTO	W: 0.8 - 4.9	W: 0.3 - 0.8	W: 0.3 - 4.9
	T: 1.5 - 3.0	T: 0.5 - 1.5	T: 0.5 - 3.0

INFORMATION

- If you press the shutter button after selecting the Auto, Fill-in, Slow sychro flash, the first flash fires to check the shooting condition (Flash range and Power ratio of flash).
Do not move the camera until the second flash fires.
- Using the flash frequently will reduce the life of the battery.
- Under normal operating conditions the charging time for the flash is usually less than 5 seconds. If the battery is weak, the charging time will be longer.
- Take photographs within the flash range.
- The image quality is not guaranteed if the subject is too close or highly reflective.
- When taking an image in poorly lit conditions with the flash, there may be a white speck in the captured image. The speck is caused by the reflection of the flash light from the atmospheric dust. It is not camera malfunction.
- Do not open the Built-in flash by force. It may cause damage to the flash.









Flash

- Flash mode indicator

Menu tab	Flash mode	Description
	Flash off	The flash does not fire. Select this mode when capturing images in a place or situation where flash photography is prohibited. When you capture an image in a poorly lit condition, the camera shake warning indicator () will display on the LCD monitor.
	Auto flash	If the subject or background is dark, the camera flash will operate automatically.
	Auto & Red eye reduction	If a subject or background is dark, the camera flash will work automatically and will reduce the red-eye effect by using the red-eye reduction function.
	Fill in flash	The flash fires regardless of the available light. The intensity of the flash will be automatically controlled to suit the prevailing conditions.
	Slow synchro	The flash operates with a slow shutter speed to obtain a balanced correct exposure. In poor lighting conditions the camera shake warning indicator () will display on the LCD monitor.
	Red-eye fix	When a shot with "red eye" is detected, this mode will reduce the red-eye effect automatically.

Size

- You can select the image size appropriate for your application.

Mode	Still image mode						
Icon							
Size	3648X 2736	3648X 2432	3136X 2352	3648X 2056	2688X 2016	2240X 1680	1024X 768
Mode	Movie clip mode						
Icon							
Size	640X480		320X240				



[STILL IMAGE mode]



[MOVIE CLIP mode]

INFORMATION

- The higher the resolution, the lower the number of shots available because high resolution images require more memory.

Continuous shot

- You can select the type of shooting and the number of continuous shots.

- SINGLE : Take one picture only

- CONTINUOUS : Images will be taken continuously until the shutter button is released. The shooting capacity depends on the memory.

- HIGH SPEED : This takes 3 shots continuously (2.5 shots per second) when the shutter is pressed and held down.

- M. CAPTURE : This takes 7 shots per second, when the shutter is pressed and held down. After completing the continuous shooting, images are saved and the images play back on the Rear LCD. The maximum number of shots is 20 and the image size is fixed as 1024X768.

- AEB : Take three pictures in a series using different exposures : Short exposure (-1/2EV), standard exposure(0.0EV) and over exposure (+1/2EV).

Use this mode if it is hard to decide exposure of the object.

- ※ High resolution and picture quality increases file saving time, which increases stand-by time.
- ※ If the [CONTINUOUS], [HIGH SPEED], [M. CAPTURE] or [AEB] sub menu is selected, the flash is switched off automatically.
- ※ It is best to use a tripod for the AEB shooting as the time to save each image file is longer and blurring caused by camera shake may occur.
- ※ When the [M.CAPTURE] menu is selected, you only can select ISO AUTO, 400, 800, 1600



[Still image mode]

Metering

- If you cannot obtain suitable exposure conditions, you can change the metering method to take brighter pictures.

- MULTI : Exposure will be calculated based on an average of the available light in the image area. However, the calculation will be biased towards the centre of the image area. This is suitable for general use.

- SPOT : Only the rectangular area in the centre of the LCD monitor will be metered for light. This is suitable when you want the subject in the centre correctly exposed, regardless of the back lighting.

- CENTER : Exposure will be calculated based on an average of the available light in the image area. However, the calculation will be biased towards the centre of the image area. This is suitable for taking a picture of small object like a flower or insects.

- ※ If the subject is not the centre of the focus area, do not use the spot metering as this may result in an exposure error. In this circumstance, it is better to use exposure compensation.



[PROGRAM mode]

Sharpness

- You can adjust the sharpness of the picture you want to take. You cannot check the sharpness effect on the LCD monitor before you take a picture, because this function is applied only when the captured image is stored on the memory.



[PROGRAM mode]

Sub menu	Icon	Description
SOFT		The edges of the image are softened. This effect is suitable for editing images on your PC.
NORMAL		The edges of the image are sharp. This is suitable for printing.
VIVID		The edges of the image are emphasized. The edges will appear sharp, but noise may occur in the recorded image.

Effect

- By using the camera's digital processor, it is possible to add special effects to your images

- (**NOR**) : No effect is added to the image
- (**B&W**) : Captured images will be stored in black and white.
- (**S**) : Captured images will be stored in a sepia tone (a range of yellowish brown colours).
- (**B**) : Captured images will be stored in a blue tone.
- (**R**) : Captured images will be stored in a red tone.
- (**G**) : Captured images will be stored in a green tone.
- (**N**) : Save the image in negative mode.
- (**C**) : User can set the tone of the R (Red), G (Green) and B (Blue) value. These menus can be selected in the Special Effect mode only.



[Program mode]

Quality / Frame rate

- You can select the compression ratio appropriate for your application of the captured images. The higher the compression ratio, the lower the picture quality.

Mode	Still image mode			Movie clip mode	
	Icon				
Sub menu	Super Fine	Fine	Normal	30FPS	15FPS
File Type	jpeg	jpeg	jpeg	avi	avi



[STILL IMAGE mode]



[MOVIE CLIP mode]

INFORMATION

- This file format complies with the DCF (Design rule for Camera File system).
- JPEG (Joint Photographic Experts Group) : JPEG is the image compression standard developed by the Joint Photographic Experts Group. This type of compression is most commonly used for compressing photos and graphics because it can compress the files efficiently.

Self-timer / Remote control

- This function is used when the photographer would also like to be in the picture.
 - Selecting a self-timer :
When you press the Shutter button, the picture will be taken after the specified time has elapsed and the self-timer function will be cancelled.
 - Selecting a remote mode :
Pressing the shutter button of a separate remote control will allow an interval of 2 seconds before the image is taken. After taking a picture, the remote mode will be maintained. But, pressing the Power button will cancel the remote mode.



- Description of Self-timer / Remote mode

Icon	Mode	Description
	Off	You do not use the self-timer function.
	10s	Pressing the shutter button will allow an interval of 10 seconds before the image is taken.
	2s	Pressing the shutter button will allow an interval of 2 seconds before the image is taken.
	Double	A picture will be taken after about 10 seconds and 2 seconds later a second picture will be taken.
	Remote	You can take a picture by remote control instead of using the shutter button of the camera.

Self-timer / Remote control

Remote control range

When you take a picture by using the remote control, refer to the illustrations shown alongside about the remote control range.

[Shutter button on the remote control]

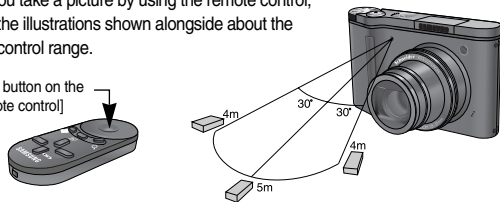

Replacing battery for the remote control

Make sure the + (positive) polarity is toward the top and the - (negative) polarity is toward the bottom while installing battery for the remote control. Replace battery for the remote control in the local service centre. Use the CR 2025 3V battery.

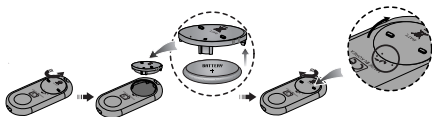

INFORMATION

- When taking a picture using the self-timer, the self-timer lamp works as follows :
 - 2 second self-timer setting : The self-timer lamp blinks at 0.25 second interval for 2 seconds.
 - 10 second self-timer setting : The self-timer lamp blinks at 1 second interval for the first 7 seconds. It blinks at 0.25 second interval for the remaining 3 seconds.
- If you operate the Back button during the self-timer operation, the self-timer function is canceled.
- Use a tripod to prevent camera shake.

Voice recording / Voice memo

- A voice can be recorded for as long as the available recording time(Max 10 hours) of the memory capacity allows. And you can add your voice-over to a stored still image.

Voice recording

- Select a recording mode with the exception of the Movie clip mode by rotating the mode dial.
- Select the Voice recording menu by using the smart button.
- Press the shutter button to record a voice.
 - Press the shutter button once and voice is recorded for as long as the available recording time allows(Max 10 hours) . The recording time will be displayed on the LCD monitor. Voice will still be recorded if the shutter button is released.
 - If you wish to stop recording, press the shutter button again.
 - File type : *.wav



Voice memo

- Select a recording mode with the exception of the Movie clip mode by rotating the mode dial.
- Select the Voice memo menu by using the smart button. If the voice memo indicator is displayed on the LCD monitor, the setting is completed.
- Press the shutter button and take a picture. The picture is stored on the memory card.
- Voice memo will be recorded for ten seconds from the moment the picture is stored. In the middle of the sound recording, pressing the shutter button will stop the voice memo.



• Voice recording / Voice memo

INFORMATION

- A distance of 40cm between you and the camera (microphone) is the best distance to record sound.

• Exposure compensation

- This camera automatically adjusts the exposure according to the ambient lighting conditions. You can also select the exposure value in the compensating exposure menu. Exposure compensation menu is available in the Program, ASM (Excluding M mode) and Movie clip mode.

- Compensating Exposure

1. Press the exposure compensation menu button and the exposure compensation menu bar will appear as shown.
2. Touch the button and slide your finger to select the exposure value.
3. Press the exposure compensation menu button again. The value you set will be saved and the Exposure Compensation setup mode will close.



- ※ A negative exposure compensation value reduces the exposure. Note that a positive exposure compensation value increases the exposure and the LCD monitor will appear white or you may not get good pictures.

• ISO

- You can select the ISO sensitivity when taking pictures. The speed or specific light-sensitivity of a camera is rated in ISO numbers. ISO menu is available in the Program and ASM mode.

- AUTO :

The camera's sensitivity is automatically changed by variables such as lighting value or subject brightness.

- 80, 100, 200, 400, 800, 1600 :

You can increase the shutter speed while the same amount of light is present, by increasing the ISO sensitivity. However, the image may be saturated in high luminance.

The higher the ISO value, the greater is the camera's sensitivity to light; therefore it has a greater capacity for taking pictures in darker conditions.

However, the noise level in the image will increase as the ISO value increases, making the image appear coarse.

- ※ When the [M.CAPTURE] menu is selected, you only can select ISO AUTO, 400, 800, 1600.



White balance

- The white balance control allows you to adjust the colours to appear more natural. When a menu except the AWB (Auto White Balance) is selected, you can only select the negative color effect. White Balance menu is available in the Program, ASM and Movie clip mode.

AUTO **AWB** : The camera automatically selects the appropriate white balance settings, depending on the prevailing lighting conditions.



DAYLIGHT ☀ : For taking images outside.

CLOUDY ☁ : For taking images under a cloudy and overcast sky.

Fluorescent H 💡 : For shooting under daylight fluorescent types of three way fluorescent lighting.

Fluorescent L 💡 : Shooting under white fluorescent lighting.

TUNGSTEN 💡 : For shooting under tungsten (standard light bulb) lighting.

CUSTOM ↕1 ↕2 : Allows the user to set the white balance according to the shooting condition.

Different lighting conditions may cause a colour cast on your images.

- Using the Custom White Balance

White balance settings may vary slightly depending on the shooting environment. You can select the most appropriate white balance setting for a given shooting environment by setting up the custom white balance.

1. Select the CUSTOM (↕1 ↕2) menu of the White Balance and place a sheet of white paper in front of the camera so that the LCD monitor shows only white.

2. OK menu button : selects pre-saved custom white balance.

BACK button : cancels the custom white balance.

Shutter button : stored the new custom white balance.

- The custom white balance value will be applied, starting with the next picture you take.

- The user configured white balance will be remain effective until it is overwritten.

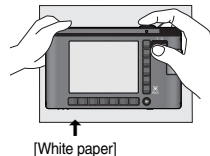

Scene menu

- Use the menu to easily configure optimal settings for a variety of shooting situations.

※ The scene modes are listed below.

[NIGHT]

- (🌙) : Use this for shooting still images at night or in other dark conditions.

[PORTRAIT]

- (👤) : To take a picture of a person.

[CHILDREN]

- (👶) : To take a picture of fast moving objects, for example, children.

[LANDSCAPE]

- (🏞️) : To take pictures of distant scenery.

[BIZ]

- (📄) : To take pictures of a visiting card

[CLOSE UP]

- (🔍) : Close-up shooting for small objects such as plants and insects.

[TEXT]

- (📄) : Use this mode to shoot a document.

[SUNSET]

- (🌅) : For taking pictures of sunsets.

[DAWN]

- (🌅) : Daybreak scenes.

[BACKLIGHT]

- (👤) : For portraits without shadows caused by backlighting.

[FIREWORK]

- (💣) : Firework scenes.

[BEACH&SNOW]

- (🏖️) : For ocean, lake, beach and snow scape scenes.



Special Effect : Photo Frame

- You can add any one of 9 types of frame-like borders to a still image you want to capture.
- Date & Time information will not be printed on the stored image taken with Photo Frame menu.

OFF : The photo frame is not inserted.



F1



F2

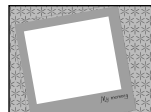

F3

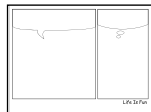

F4



F5



F6



F7



F8



F9

Special Effect : Motion GIF

- You can make Motion GIF with captured images.
Motion GIF : Taking images continuously and save them in a file. This file supports animation.
- How to make the Motion GIF
 - Select the Special Effect mode by rotating the mode dial.
 - Press the Motion GIF menu button.
 - Select the image size and FPS (Frame Per Second).
 - Press the Shutter button to take pictures.
(Max. 50 images)
 - Press the OK menu button to save the image.
The images will be saved as a motion GIF file.



[Selecting FPS]



[Selecting image size]

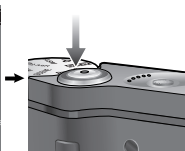

[Taking pictures]



[Pressing the OK menu button]

INFORMATION

- As the GIF file format has limitation of shades, image quality can be decreased.

Special Effect : Composite shooting

- You can combine 2, 3, or 4 different shots in a still image
 - OFF** : Cancels the composite shooting
 - 2** : 2 different shots are combined in a still image.
 - 3** : 3 different shots are combined in a still image.
 - 4** : 4 different shots are combined in a still image.
 - 2** : 2 different panorama shots are combined in a still image.



※ Selecting 2 composite shooting

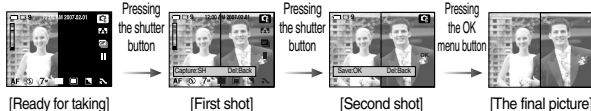

INFORMATION

- If you press the Play mode button or rotate the mode dial during the composite shots, each camera working mode is executed. The images captured before will be deleted.
- After taking the last composite shooting, press the OK button. And then the voice memo will start.

Special Effect : Composite shooting

- Changing a part of composite shot before taking the last shot
Before taking the last composite shot, you can change a part of composite shot.
 - During the composite shots, press the BACK button.
 - A previous image will be deleted and new frame will display. If there is an image taken before, press the BACK button again and a previous image will be deleted again.



[Before taking the 3rd shot]



Pressing the BACK button



[Moving backward to the 2nd shot]

3. Press the shutter button to capture a new image.

- Changing a part of composite shot after taking the last shot

- After taking the last shot, a menu will display as shown.
- Select an image to delete by using the Smart button.
- Press the BACK button and the selected image is deleted.
- Press the Shutter button to take an image again.
- Press the OK button and the image is saved.



Shutter Speed

- This mode will set the shutter speed for automatic exposure. High Shutter speeds can capture a moving object in a still image as if the object is not moving. Low Shutter speeds can capture a moving object with an 'active' effect.



[SHUTTER PRIORITY mode]



[MANUAL mode]

- Setting up the shutter speed
To select the shutter speed, touch the button and slide your finger to the left or right. You can set up the Shutter speed in the SHUTTER PRIORITY mode and in the MANUAL mode.



← Slow



Fast →

● Aperture Value

- This mode will set the aperture value for automatic exposure. Smaller Aperture values make the object sharp but blur the background. Larger Aperture values make both the object and background sharp.



[APERTURE PRIORITY mode]



[MANUAL mode]

● Setting up the Aperture value

To select the Aperture Value, touch the button and slide your finger to the left or right.

You can set up the Aperture value in the APERTURE PRIORITY mode and the MANUAL mode.



← Close



Open →

● Photo Gallery mode

- When the images play back, you can add play back effect and listen to a B.G.M. Only still images can be played back. Movie, Voice files are not played back.

■ Selecting a play back mode

1. Select the Photo Gallery mode by rotating the mode dial.



2. Press the Play mode button and menus as shown will display.

 : Play back by album

 : Play back by date

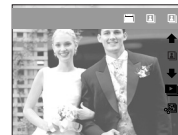

3. Press the Smart button to select a desired play back mode.

● Photo Gallery mode

- Album mode : Images play back by album.

If a memory card is not inserted, Personal / Family / Friend / Event albums can be selected. All of images saved in the internal memory play back.

- Selecting an album

You can select an album by using the smart button. Before selecting an album, insert images into albums.

 : All images save in the memory play back.

 : Images saved in the Personal album play back.

 : Images saved in the Family album play back.

 : Images saved in the Friends album play back.

 : Images saved in the Events album play back.



- Adding images in an album

Press the Album menu button and the menus shown below will display.



- Moving cursor / Selecting an image
: Smart button (Horizontal)

- Selecting images
: Pressing the smart button (Horizontal)
Images you want can be selected one at a time.

- Selecting / Cancelling an album
: Each album button

 : Adding images in the Personal album.

 : Adding images in the Family album.

 : Adding images in the Friends album.

 : Adding images in the Events album.

- Moving to previous menu : BACK button



Photo Gallery mode

- Playing back an album

Press the slide show menu button.



 : Starting the slide show

 : Selecting an effect of the slide show

 : Setting play interval

 : Selecting a B.G.M

A B.G.M can be played back with images.

Only a saved music can be selected.

You can't add any music on the B.G.M list.

 : Selecting play back time

[Play] : The slide show is closed after one cycle.

[Repeat Play] : The slide show is repeated until cancelled.



※ Refer to page 48–49 for more information about the slide show.

- Rotating an image

You can rotate an image to a direction you want.

Press the horizontal smart button.

Touch the smart button and the selected image is rotated.

Press the smart button and the rotated image information will be saved.



 : rotates the image clockwise.

 : rotates the image anticlockwise.

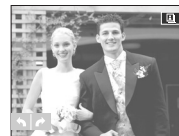

- Date mode : When an image is taken, date information is also recorded.

In date mode, images play back by the date.

- Selecting a date

You can select a date by using the smart button.

※ Usage of the menu of the date mode is same as album mode. Refer to p.42 for more information.



Starting play mode

- Turn the camera on and select Play mode by pressing the play mode button (). The camera can now play back the images stored in the memory.
- You can set up the PLAY mode function by using the camera buttons and LCD monitor.
- If the memory card is inserted in the camera, all the camera functions apply only to the memory card.
- If the memory card is not inserted in the camera, all the camera functions apply only to the internal memory.

● Playing back a still image

1. Select the PLAY mode by pressing the play mode button ().



2. The last image stored on the memory is displayed on the LCD monitor.



3. Touch the button and slide your finger to the left or right to select an image.

※ If you press the ① or ② button, the image will be play back continuously



INFORMATION

- Manner mode : To select the Manner mode, press the Playback mode button for more than 3 seconds. In the Manner mode, Shutter sound, Operating sound, Start-up sound and Effect sound will not be generated. To cancel the Manner mode, turn on the camera by pressing the Power button.

● Playing back a movie clip



1. Select the recorded movie clip that you want to play back by using the smart button.

2. Press the [Play] button and menus for movie will display.

3. Press the  button to play back a movie clip file.

- To pause a movie file while playing it back, press the  button again.

- Pressing the  button again will cause the movie clip file to restart.

- To rewind the movie clip while it is playing, press the  button. To fast forward the movie clip, press the  button. Whenever the  button is pressed, the search speed will be increased to 2X, 4X, 8X or 16X.

- To stop playback of the movie clip, press the  button.

4. Press the BACK button and the menu move to Play mode.



Starting play mode

- Movie clip capture function : capture still images from the movie clip.

1. Press the II menu button while playing back a movie file.
2. Press the Capture menu button. The captured image is saved under a new file name.



- On camera movie trimming : You can extract desired frames of movie clip during the movie clip play back.

1. Press the extract menu button at the point of the movie clip that you want to start extracting.
2. Press the extract menu button at the point of the movie clip that you want to stop extracting.
3. A confirmation window will display.
4. Press the smart button to select a desired sub menu.

[Yes] : The extracted frames are saved as a new file name.

[No] : The movie trimming will cancel.



- Playing back a recorded voice

1. Select the recorded voice that you want to play back by using the smart button.
2. Press the [Play] button; menus for voice will display.
3. Press the ► button to play back a voice clip file.
 - To pause a voice file while playing it back, press the II button again.
 - Pressing the ► button again will cause the voice file to restart.
 - To rewind the voice while it is playing, press the ◀◀ button. To fast forward the voice, press the ▶▶ button.
 - To stop playback of the voice, press the ■ button.



※ If the running time is under 4 seconds, the movie clip can't be trimmed.

Starting play mode

● Playing back a recorded voice memo

1. Select the still image that includes the voice memo by using the smart button.
2. Press the [Edit] button and menus will display.
3. Press the (🎤) icon to play back a voice memo.
 - To pause a voice file while playing it back, press the || button.
 - Pressing the ▶ button again will cause the voice file to restart.
 - To stop playback of the voice, press the ■ button.



LCD monitor indicator

- The LCD monitor displays shooting information about the displayed image.

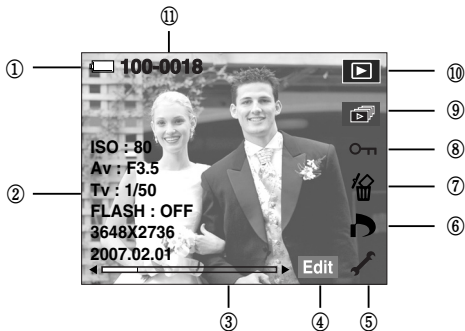

No.	Description	Icon	Page
1	Battery		p.13
2	Recording Information		-
3	Slide Bar		-
4	Fn menu : Press the smart button		-
5	Setup menu		p.58~59
6	DPOF menu		p.50
7	Delete menu		p.50
8	Protect menu		p.49
9	Slide show menu		p.48~49
10	Play back mode icon		-
11	Folder name and Stored image number	100-0001	p.60

Using the camera buttons to adjust the camera

- In Play mode, you can use the buttons on the camera to conveniently set up the Play mode functions.

Play mode button

- If you have turned on the camera by pressing the POWER button, you can press the PLAY MODE button once to switch to Play mode and press it again to switch to Recording mode.
- You can turn the power on with the play mode button. The camera is turned on in play mode. Press the play mode button again to turn off the camera.

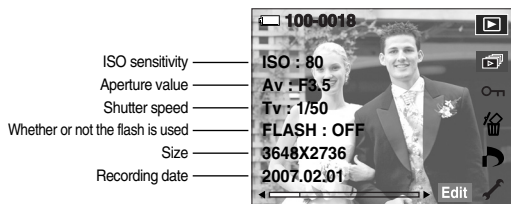

BACK button

- When the menus are displayed the BACK button allows you to return to the previous screen, and will eventually bring you out of the menu system.



Thumbnail ([]) / Enlargement ([]) button

- You can view multiple pictures, enlarge a selected picture, and crop and save a selected area of an image.
- Thumbnail display
 - While an image is displayed on full screen, press the thumbnail button.
 - The thumbnail display will highlight the image that had been showing at the time the thumbnail mode was selected.
 - Use the smart button to move to a desired image.
 - To view an image separately, press the enlargement button.

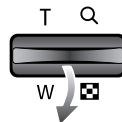

[Normal display mode]

Pressing the thumbnail button ([])

← →

Pressing the enlargement button ([])



[Thumbnail display mode]

• Thumbnail () / Enlargement () button

• Image enlargement

1. Select an image that you want to enlarge and press the enlargement button.
2. Different parts of the image can be viewed by using the smart button.
3. Pressing the thumbnail button will zoom back to the original full sized image.

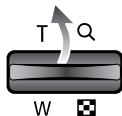

- You can tell whether the image displayed is an enlarged view by checking the image enlargement indicator shown at the top left of the LCD monitor. (If the image is not an enlarged view, the indicator will not be displayed.) You can also check the area of enlargement.

- Movie clips and WAV files can't be enlarged.
- If an image is enlarged, a loss of quality may occur.

• The maximum enlargement rate in proportion to the image size.



Image size	10M	9MP	7M	7MW	5M	3M	1M
Maximum enlargement rate	X11.40	X8.14	X9.80	X8.14	X8.39	X7.00	X3.20

• Starting the slide show

- Images can be displayed continuously at pre-set intervals. You can view the slide show by connecting the camera to an external monitor. To start the slide show, press the Start menu button. Movie file, Voice file and GIF file won't be displayed.



- Configure slide show effects : Unique screen effects can be used in the slide show.

- MIX** : The image slides regularly (from Effect 1 to Effect 3).
-  : Image moves from the top left.
-  : Image is displayed slowly from the center outwards.
-  : The next image overspreads the previous image.



Starting the slide show

- Setting play interval : Set the slide show play interval to the number of seconds preferred.

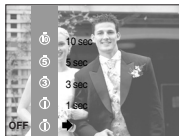

- Repeat Option : Selecting the repeat option for the slide show.

[ONE PLAY] : The slide show is closed after one cycle.

[REPEAT PLAY] : The slide show is repeated until cancelled.



Protecting images

- This is used to protect (Lock) specific shots from being accidentally erased. It also unprotects (Unlocks) images that have been previously protected.

ONE : Protect / release displayed image.

ALL : Protect / release all saved images

- If you protect an image, the protect icon will be displayed on the LCD monitor. (An unprotected image has no indicator)

- An image in LOCK mode will be protected from the delete function, but will NOT be protected from the format function.

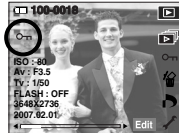
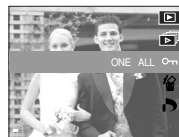

• Deleting images

- This is used to delete the displayed image.

YES : deletes displayed or checked (✓) image.

NO : cancels deleting displayed image or checked (✓) image.

- The protected images can't be deleted.
- If you wish to delete multi-image, check to delete the image by using the (✓) button and the smart button (horizontal) and then press the [Yes] menu.
- The number of images will display right bottom of the LCD monitor.



• DPOF

- DPOF (Digital Print Order Format) allows you to embed printing information on your memory card's MISC folder. Select the pictures to be printed and how many prints to make.
- The DPOF indicator will display on the LCD monitor when an image that has DPOF information plays back. Images can then be printed on DPOF printers, or at an increasing number of photo labs.
- This function is not available for Movie clips and Voice recording files.
- If a memory card is not inserted, the menus are still displayed in the LCD, but are not selectable.

DPOF : STANDARD

- This function allows you to embed print quantity information on a stored image.

1. Select the DPOF menu by pressing the smart button.
2. Select a desired sub menu by pressing the smart button.

[ONE PIC] : Select a number of prints of displayed image.

[ALL PICS] : Configure number of prints for all pictures except movie and voice files.

[CANCEL] : Cancel the print setup.

3. Press the OK button to confirm the setting. If an image carries DPOF instructions, the DPOF indicator () will show.



DPOF : Print size

- You can specify the print size when printing images stored on the memory card. The [SIZE] menu is available only for DPOF 1.1 compatible printers.

- Setting the Print Size

1. Select the [SIZE] menu by pressing the smart button.
2. Select a desired sub menu by pressing the smart button.

[ONE PIC] : Select a print size of displayed image.

[ALL PICS] : Change print size of all saved images.

[CANCEL] : Cancel all of the print size settings.

3. Press the OK button to confirm the setting. If an image carries DPOF instructions, the DPOF indicator will show.



※ DPOF [SIZE] secondary menu : Cancel, 3X5, 4X6, 5X7, 8X10

※ Depending on the manufacturer and printer model, cancelling the printing may take a little longer for the printer to process.

• DPOF : Index

- Images (except for movie clips and voice file) are printed as index type.

1. Select the [INDEX] menu by pressing the smart button.
2. Select a desired sub menu by pressing the smart button.

If [NO] is selected : Cancel the index print setting.
If [YES] is selected: The image will be printed in index format.

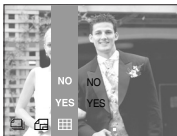

• Rotating an image

- You can rotate the stored images by various degrees. Once the playback of the rotated picture is finished, it will be saved in its rotated state.
1. Press the [Edit] button.
 2. Press the [ROTATE] menu button.
 3. Select a desired sub menu by pressing the smart button.

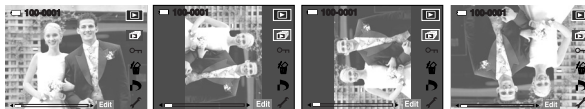
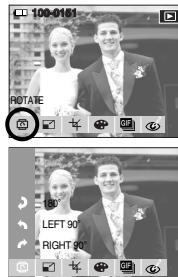

[Before rotating the image]

[Right 90°]

[Left 90°]

[180°]

4. If you display the rotated image on the LCD monitor, empty spaces may appear to the left and right of the image.

● Resize

- Change the resolution (size) of pictures taken. Select [User image] to save an image to be the start-up image. The resized image will have a new file name.

- Press the smart button (horizontal).
- Press the [RESIZE] menu button.
- Select a desired sub menu by pressing the smart button.

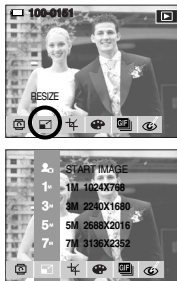

● Image Resize Types

Size	3136X2352	2688X2016	2240X1680	1024X768	START IMAGE
10M	O	O	O	O	O
7M	X	O	O	O	O
5M	X	X	O	O	O
3M	X	X	X	O	O
1M	X	X	X	X	O

Size	3264X2176	2752X1832	2176X1456	1280X856
9M(3:2)	O	O	O	O

Size	2688X1512	1920X1080	1344X760
7M(16:9)	O	O	O

INFORMATION

- You can change the resolution of only those files compressed in the JPEG 4:2:2 format.
- The resized image will have a new file name. The [START IMAGE] image is stored not on the memory card but on the internal memory.
- Only one [START IMAGE] image can be saved. If you save a new [START IMAGE], the existing startup image will be deleted.
- If the memory capacity is insufficient to store the resized image, a [Memory Full!] message will display on the LCD monitor and the resized image will not be stored.

Trimming

- You can extract part of the image that you want and save it separately.

1. Select an image that you want to enlarge.
2. Press the [Edit] button.
3. Press the [Trim] menu button.
4. Enlarge the image by using the Zoom button.
To move the image, use the Smart button.
5. Press the smart button to display a confirmation window.
6. Press the [Yes] button. The trimmed image will save as a new file name, and display on the LCD monitor.

※ If there is not enough memory space to save the trimmed image, the image can't be trimmed.



Effect

- By using the camera's digital processor, it is possible to add special effects to your images.

1. Press the [Edit] button.
2. Press the [EFFECT] menu button.
3. Select a desired sub menu by using the smart button.

- W** : Captured images will be stored in black and white.
- S** : Captured images will be stored in a sepia tone (a range of yellowish brown colours).
- B** : Captured images will be stored in a blue tone.
- R** : Captured images will be stored in a red tone.
- G** : Captured images will be stored in a green tone.
- I** : Save the image in negative mode.



Motion GIF

- You can make Motion GIF with captured images.
Motion GIF : Taking images continuously and save them in a file. This file supports animation.
- How to make the Motion GIF
 1. Press the [Edit] button.
 2. Press the Motion GIF menu button.



3. Select the image size and FPS (Frame Per Second).
4. Select desired images by using the smart button.



5. Press the OK button and a Motion GIF file is saved.

- How to play back the Motion GIF file

1. Select a Motion GIF file by using the smart button.
2. Press the [Play] button and menus display.
3. Press the start menu button.



Red eye fix

- When a shot with "red eye" is played back, pressing this button can remove the red eye from the subject.
 1. Select a picture that has red eye.
 2. Press the [Edit] button.
 3. Press the [Red Eye Fix] menu button.
To remove the red-eye effect automatically.
 4. When you press the OK button the red-eye fixed image will save as a new file name.



PictBridge

- You can use the USB cable to connect this camera to a printer that supports PictBridge (sold separately) and print the stored images directly. Movie clips and voice files cannot be printed.
- Setting up the camera for connection to a printer
 1. Connect the camera to a printer's USB port with the supplied USB cable.
 2. Select the [Printer] menu by using the smart button.

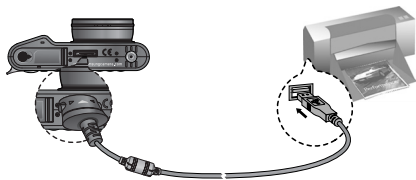
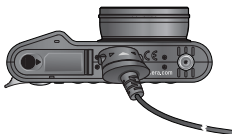
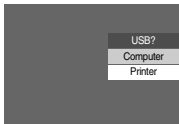

- ※ If you selected [Computer], when you connected the camera to your printer, the [Connecting Computer] message will display and the connection will not be established. Select [Printer] menu, when you connect the camera to your printer. But, the camera may not connect to the printer, depending on the manufacturer and model of the printer

- Easy printing : When you connect the camera to printer in the Play back mode, you can print a picture easily with the default print settings.

1. In the play back mode, connect the camera and the printer. The menu icons will display as shown.



2. Press the  button.

3. Select the [Yes] menu and the image will print.



- Print mode : You can select the Easy printing mode or Custom printing mode.

 : Custom Printing mode

 : Easy Printing mode

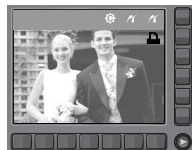

PictBridge

- Custom Set : You can select the Paper Size, Print Format, Paper Type, Print Quality, Date Print, and File Name Print menus for printed pictures.



No.	Icon	Description	Menu
1		Selecting images for printing	One Pic, All Pics
2		Setting the size of the printing paper	Auto, PostCard, Card, 4x6, L, 2L, Letter, A4, A3
3		Setting the number of pictures to be printed on a sheet of paper	Auto, Full, 1, 2, 4, 8, 9, 16, Index
4		Setting the quality of the printing paper	Auto, Plain, Photo, FastPhoto
5		Setting the quality of the picture to be printed	Auto, Draft, Normal, Fine
6		Setting whether to print the date	Auto, Off, On
7		Setting whether to print the file name	Auto, Off, On

- ※ Some menu options are not supported on all printers. If not supported, the menus are not displayed in the LCD.
- ※ If the setting values are not changed in the automatic / manual setting, the setting values are automatically kept.

- Printing images (Custom mode) : Images will be printed with changed printer setting.

1. In custom printing mode, press the Print menu button.

- ※ You can use Print menu button after select picture.



2. Select the [Yes] menu.



3. The screen shown on the right will appear and the picture will be printed. If no picture is selected, the [No Image!] message will be displayed. Press the BACK button while printing to cancel the printing.

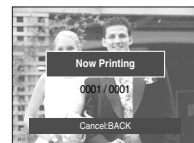









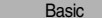

• PictBridge

- **Reset** : Initialises user-changed configurations.
- In custom printing mode, press the Reset menu button.

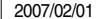

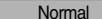

• Setup menu

- In this mode, you can set up basic settings. You can use the setup menu in all camera modes, except Voice Recording mode. The items indicated by  are default settings.



Menu tab	Main menu	Sub menu		Secondary menu	Page
	OSD set (Recording mode)	 Full		Basic	p.60
		Hide		LCD Save	
	OSD set (Playback mode)	Full		 Basic	p.60
		Hide		-	
	File	 Series		Reset	p.60
	Language	ENGLISH	한국어	FRANÇAIS	p.61
		DEUTSCH	ESPAÑOL	ITALIANO	
		简体中文	繁體中文	日本語	
		РУССКИЙ	PORTUGUÊS	DUTCH	
		DANSK	SVENSKA	SUOMI	
ไทย		BAHASA	عربي		
POLSKI		Magyar	Čeština		
Türkçe	-	-			
Date&Time	2007/02/01	 yy/mm/dd	mm/dd/yy	p.61	
	dd/mm/yy	Off	-		
	Imprint	 Off		Date	p.61
		Date & Time		-	
	LCD	Dark		 Normal	p.61
		Bright		-	
	AF Lamp	Off		 On	p.62
	Power Off	1,  3, 5, 10 min		-	p.62
Quick View	Off		 0.5, 1, 3 sec	p.62	

Setup menu

Menu tab	Main menu	Sub menu	Secondary menu	Page
	Start Image	Off	LOGO	p.62
		User image	-	
	Sound Volume	Off	Low	p.63
		Medium	High	
	Beep Sound	Off	Sound1	p.63
		Sound2	Sound3	
	Start Sound	Off	Sound1	p.63
		Sound2	Sound3	
Shutter Sound	Off	Sound1	p.63	
	Sound2	Sound3		
	Format	No	Yes	p.63
	Delete All	No	Yes	p.64
	Copy to Card	No	Yes	p.64
	Video Out	NTSC	PAL	p.65
	Reset	No	Yes	p.65

※ Menus are subject to change without prior notice.

■ How to select the setup menu

1. In any mode with the exception of Photo Gallery mode, press the extension menu button () and press the setup menu button ().



2. Each buttons have different setup menus.
Press the F1-4 (   ) menu button.

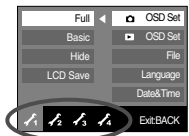

Setup menu

[OSD set]

- You can check shooting (Recording mode) and displayed image (Play back mode) information.



[Recording mode menu]



[Play back mode menu]

- [Full] : When the smart button is touched, the icons will be enlarged and OSD will be displayed.
- [Basic] : When the smart button is touched, the icons will be enlarged and OSD will not be enlarged.
- [Hide] : If the camera doesn't operate for about 3 seconds, all OSD will disappear. When the shutter is pressed down or half way down, the shutter speed and auto focus frame will display. OSD may display by using the camera buttons except for the shutter button.
- [LCD save] : If the camera is not used for about 30 seconds, the power and camera status lamps blink and the LCD monitor turns off. (LCD save is only applied to the Recording mode menu.)

[File name]

- This function allows the user to select the file naming format.

[Series] : New files are named using numbers that follow the previous sequence, even when a new memory card is used, or after formatting, or after deleting all pictures.

[Reset] : After using the reset function, the next file name will be set from 0001 even after formatting, deleting all or inserting a new memory card.



- The first stored folder name is 100SSCAM, and the first file name is SNV10001.
- File names are assigned sequentially from SNV10001 → SNV10002 → ~ → SNV19999.
- The folder number is assigned sequentially from 100 to 999 as follows: 100SSCAM → 101SSCAM → ~ → 999SSCAM.
- The files used with the memory card conform to the DCF (Design rule for Camera File systems) format.
- File names assigned in the Biz mode, will be set SB1ZXXXX

• Setup menu

[Language]

- There is a choice of languages that can be displayed on the LCD monitor. Even if the battery and AC charger are removed and inserted again, the language setting will be preserved.

LANGUAGE sub menu :

English, Korean, French, German, Spanish, Italian, S.Chinese, T.Chinese, Japanese, Russian, Portuguese, Dutch, Danish, Swedish, Finnish, Thai, BAHASA (MALAY / INDONESIAN), Arabic, Polish, Hungarian, Czech and Turkish.



[Setting up the Date / Time / Date type]

- You can change the date and time that will be displayed on the captured images and set up the date type.

- Date type : [yy/mm/dd], [mm/dd/yy], [dd/mm/yy], [Off]



[Imprinting the recording date]

- There is an option to include DATE / TIME on still images.

● Sub menus

[Off] : The DATE & TIME will not be imprinted on the image file.

[Date] : Only the DATE will be imprinted on the image file.

[Date&Time]: The DATE & TIME will be imprinted on the image file.



- ※ The Date & Time are imprinted at the bottom right side of the still image.
- ※ The imprint function is applied only to still images except for the images taken in the [Text] scene mode and photo frame effect mode.
- ※ Depending on the manufacturer and print mode, the date printed on an image may not be printed correctly.

[LCD brightness]

- You can adjust the LCD brightness.

● [LCD] sub menu : Dark, Normal, Bright



Setup menu

[Auto Focus lamp]

- You can turn the Auto Focus lamp on and off.

- Sub menus

[Off] : The AF lamp will not light up in a low light condition.

[On] : The AF lamp will light up in a low light condition.



[Auto power off]

- This function switches the camera off after a set amount of time in order to prevent unnecessary battery drainage.

- Sub menus

[1, 3, 5, 10 min]: The power will turn off automatically if not used for the period of time specified.

- After replacing the battery, the power off setting will be preserved.

- Note that the automatic power off function will not operate if the camera is in PC connect print, slide show, playing back a voice recording, playing back a movie file, playing back a GIF file, recording a movie clip or taking a composite shot.



[Quick view]

- If you enable Quick View before capturing an image, you can view the image you just captured on the LCD monitor for the duration set in the [Quick View] setup. Quick view is possible only with still images.

- Sub menus

[Off] : The quick view function can't be activated.

[0.5, 1, 3 sec] : The captured image is briefly displayed during the selected time.



[Start up image]

- You can select the image that is first displayed on the LCD monitor whenever the camera is turned on.

- Start up image : [Off], [LOGO], [User Image]

- Use a saved image for the start-up image with the [START IMAGE] in the [RESIZE] menu in the play mode.
- The start-up image will not be deleted by [DELETE] or [Format] menu.
- The User images will be deleted by [Reset] menu.

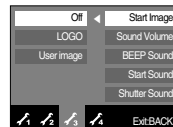

Setup menu

[Sound Volume]

- You can select the sound volume levels of start sound, operation sound and shutter sound.
- [Sound Volume] sub menus : [Off], [Low], [Medium], [High]

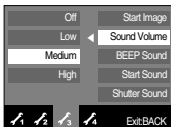

[Operation Sound]

- If you set sound to ON, various sounds will be activated for camera startup, when buttons are pressed, so that you can be aware of the camera operation status.
- [Sound] sub menus : [Off], [Sound 1], [Sound 2], [Sound 3]
- If you set sound to [Off], various sounds will not be activated.

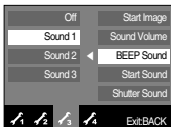

[Start up sound]

- You can select the sound that is activated whenever the camera is turned on.
- Start up sound : [Off], [Sound 1], [Sound 2], [Sound 3]

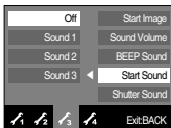

[Shutter sound]

- You can select the shutter sound.
- Shutter sound : [Off], [Sound 1], [Sound 2], [Sound 3]



[Formatting a memory]

- This is used for formatting the memory. If you run [Format] on the memory, all images, including the protected images, will be deleted. Be sure to download important images to your PC before formatting the memory.
- Sub menus
[No] : The memory will not be formatted.
[Yes] : A confirmation window will display. Select the [Yes] menu by pressing the smart button. A [Processing!] message appears and the memory will be formatted. If you run FORMAT in Play mode, a [No Image!] message will appear.

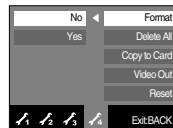

Be sure to run [Format] on the following types of memory card.

- A new memory card, or an unformatted memory card
- A memory card that has a file this camera can't recognise or one that has been taken from another camera.

INFORMATION

- Always format the memory card using this camera. If you insert a memory card that has been formatted using other cameras, memory card readers, or PCs, you will get a [Card Error!] message.

Setup menu

[Delete All]

- Of all the files stored in the memory card, the unprotected files in the DCIM subfolder will be deleted.

[No] : Cancel the "Delete All".

[Yes] : A confirmation window will display. Select the [Yes] menu by pressing the smart button. A [Processing!] message appears and the unprotected files in the DCIM subfolder will be deleted.

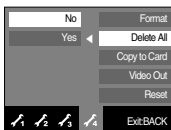

[Copy To Card]

- This enables you to copy image files, movie clips and voice recording files to the memory card.

[No] : Cancels "Copy to Card".

[Yes] : All images, movie clips and voice recording files saved in the internal memory are copied to the memory card after the [Processing!] message is displayed.

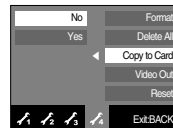

INFORMATION

- The protected images can't be deleted.
- If there aren't any protected images, all images are deleted and a [No Image!] message will display in the Play mode.

INFORMATION

- When this menu is selected without inserting a memory card, you can select the [Copy To Card] menu but the menu can't be run.
- If there is not enough space available in the memory card to copy saved images in the internal memory (20MB), the [Copy To Card] command will copy only some of the images and display [Memory Full!] message. Then the system will return to the playback mode. Please be sure to delete any unnecessary files in the internal memory to free up space before inserting the memory card into the camera.
- When you move the images that are stored in the internal memory to the memory card, the next number of file names will be created in the card to avoid duplication of the file name.
 - When the [Reset] of the [File] setup menu is set : The copied file names start from after the last stored file name.
 - When the [Series] of the [File] setup menu is set : The copied file names start from after the last captured file name. After completing [Copy To Card], the last stored image of the last copied folder is displayed on the LCD monitor.

Setup menu

[Selecting Video out type]

- The Movie output signal from the camera can be NTSC or PAL.
Your choice of output will be governed by the type of device (monitor or TV, etc.) to which the camera is connected. PAL mode can support only BDGHI.
- Connecting to an external monitor
In RECORDING/ PLAY mode, you can view the stored still images or movie clips by connecting the camera to an external monitor via the AV cable. When the camera is connected to an external monitor, the LCD monitor will be turned off automatically.

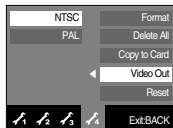

- When using a TV as an external monitor, you will need to select the external or AV channel of the TV.
- There will be a digital noise on the external monitor, but it is not a malfunction.
- If the image is not in the centre of the screen, use the TV controls to centre it.
- When the camera is connected to an external monitor, some parts of the image may not display.
- When the camera is connected to an external monitor, the menu will be visible on the external monitor and the menu functions are the same as those indicated on the LCD monitor.
- When the camera is connected to an external monitor, the button sound may not sound.

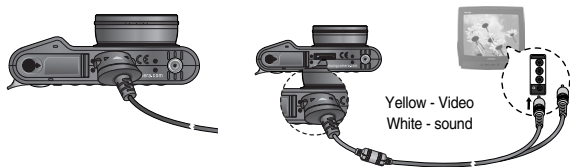

- NTSC : U.S.A, Canada, Japan, South Korea, Taiwan, Mexico.
- PAL : Australia, Austria, Belgium, China, Denmark, Finland, Germany, U.K., Holland, Italy, Kuwait, Malaysia, New Zealand, Singapore, Spain, Sweden, Switzerland, Thailand, Norway.

[Initialisation]

- All camera menu and function settings will be restored to their default values. However, values for DATE / TIME, LANGUAGE, and VIDEO OUT will not be changed.
- Sub menus
[No] : Settings will not be restored to their defaults.
[Yes] : A confirmation window will display. Select the [Yes] menu by pressing the smart button. All settings will be restored to their defaults.

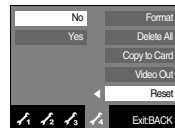

• Important notes

Be sure to observe the following precautions!

- This unit contains precision electronic components. Do not use or store this unit in the following locations.
 - Areas exposed to severe changes in temperature and humidity.
 - Areas exposed to dust and dirt.
 - Areas exposed to direct sunlight or the inside of a vehicle in hot weather.
 - Environments where there is high magnetism or excessive vibration.
 - Areas with high explosives or highly flammable materials.
- Do not leave this camera in places subject to dust, chemicals (like naphthalene and mothball), high temperatures or high humidity. Keep this camera with silica gel in a hermetically sealed box when planning to use the camera for a long period of time.
- Sand can be particularly troublesome to cameras.
 - Do not let sand get inside the camera when using it on beaches, coastal dunes, or other areas where there is lots of sand.
 - Doing so may result in failure or may render the camera permanently unusable.
- Handling the camera
 - Never drop the camera or subject it to severe shocks or vibrations.
 - Protect the large size LCD monitor from an impact. When this camera is not used, keep it in the camera case.
 - Avoid obstructing the lens or the flash when you capture an image.
 - This camera is not waterproof.
To avoid dangerous electrical shocks, never hold or operate the camera with wet hands.
 - If you use this camera in wet places, such as beach or pool, do not let water or sand get inside the camera. Doing so may result in failure or may permanently damage the unit.
- Extremes in temperature may cause problems.
 - If the camera is transferred from a cold to a warm and humid environment, condensation can form on the delicate electronic circuitry. If this seems likely, wait for at least 1 hour until all moisture is dispersed before attempting to use the camera.
Moisture built up can also occur on the memory card. If this happens, turn off the camera and remove the memory card. Wait until the moisture has dispersed.
- Caution on Using the Lens
 - If the lens is subjected to direct sunlight, it could result in the discoloration and deterioration of the image sensor.
 - Avoid getting fingerprints or foreign substances on the surface of the lens.
- If the digital camera is not used for a long period, an electric discharge can occur.
It is a good idea to remove the battery and the memory card if you do not intend using the camera for an extended period of time.
- If the camera is exposed to an electronic interference, it will turn itself off to protect the memory card.

Important notes

■ Camera Maintenance

- Use a soft brush (available from photo stores) to gently clean the lens and LCD assemblies. If this does not work, lens-cleaning paper with lens cleaning fluid can be used.

Clean the camera body with a soft cloth. Do not allow this camera to come into contact with solvent materials such as benzol, insecticide, thinners etc. This may damage the body shell of the camera and also affect its performance. Rough handling can damage the LCD monitor. Take care to avoid damage and keep the camera in a protective carrying case when not in use.

- Do not attempt to disassemble or modify the camera.
- Under certain conditions, static electricity can cause the flash unit to fire. This is not harmful to the camera and is not a malfunction.
- When images are uploaded or downloaded, the data transfer may be affected by static electricity.
In this case, disconnect and re-connect the USB cable before trying the transfer again.
- Always check the condition of the camera before an important event or going on a trip.
 - Take a picture to check that the camera is working correctly and ensure you have a fully charged spare battery.
 - Samsung cannot be held responsible for camera malfunctions.

Warning indicator

- There are several warnings that may appear on the LCD display

Memory Error!

- Memory card error
 - Turn off the camera power and turn it on again
 - Insert the memory card again
 - Insert and format the memory card (p.63)

Card Locked!

- The memory card is locked
 - SD/SDHC/MMC memory card : Slide the write protect switch towards the top of the memory card

No Card!

- A memory card is not inserted
 - Turn off the camera power and insert the memory card again
 - Turn off the camera power and turn it on again

No Image!

- There are no images stored on the memory
 - Take images
 - Insert a memory card that is holding some images

File Error!

- File error
 - Delete the erroneous files.
- Memory card error
 - Contact a camera service centre

• Warning indicator

Low Battery!

- There is low battery capacity
→ Insert a fully charged battery.

Low Light!

- When taking pictures in dark places
→ Take pictures in Flash Photography mode.

DCF Full Error

- Violation of DCF format
→ Copy the images to a PC and format the memory.

• Before contacting a service centre

- Please check the following

The camera doesn't switch on

- There is low battery capacity
→ Insert a fully charged battery. (p.13)
- Battery is inserted incorrectly with the polarities reversed.
→ Insert the battery according to the polarity marks (+, -)
- The rechargeable battery is not inserted
→ Insert the battery and turn on the camera

The camera power ceases while in use

- The battery is exhausted
→ Insert a fully charged battery.
- The Camera is turned off automatically
→ Turn on the camera power again.

Battery power quickly drains

- The Camera is being used in low temperatures
→ Keep the camera in warm conditions (i.e. inside a coat or jacket) and only remove it in order to take images

Camera does not take images when pressing the Shutter button

- There is insufficient memory capacity
→ Delete unnecessary image files
- The memory card has not been formatted
→ Format the memory card (p.63)
- The memory card is exhausted
→ Insert a new memory card
- The memory card is locked
→ Refer to [Card Locked!] error message (p.67)
- The camera's power is off
→ Turn the camera power on
- The battery is exhausted
→ Insert a fully charged battery. (p.13)
- Battery is inserted incorrectly with the polarities reversed.
→ Insert the battery according to the polarity marks (+, -)

The camera suddenly stops working while in use

- The camera stopped due to a malfunction
→ Remove /re-insert battery and switch the camera on

• Before contacting a service centre

The images are unclear

- A picture was taken the subject without setting an appropriate macro mode
→ Select an appropriate macro mode to take a clear image.
- Taking a picture beyond the flash range
→ Take a picture within the flash range
- The lens is smudged or dirty
→ Clean the lens

The flash does not fire

- Flash off mode has been selected
→ Dis-engage flash off mode
- The camera mode can't use flash
→ Refer to the FLASH instruction (p.30)

Incorrect date and time is displayed

- The date and time have been set incorrectly or the camera has adopted the default settings
→ Reset the date and time correctly

The camera buttons do not operate

- Camera malfunction
→ Remove/re-insert battery and switch the camera on

A card error has occurred while the memory card is in the camera.

- Incorrect memory card format
→ Re-format the memory card

The images don't play back

- Incorrect file name (Violation of DCF format)
→ Do not change the image file name

Colour of image is different to the original scene

- White balance or effect setting is incorrect
→ Select appropriate White balance and effect

Images are too bright

- Exposure is excessive
→ Reset exposure compensation

No image on external monitor

- The external monitor has not been connected properly with the camera
→ Check the connection cables
- There are incorrect files in the memory card
→ Insert a memory card that has correct files

When using the PC's explorer, the [Removable Disk] file does not show

- Cable connection is incorrect
→ Check the connection
- The camera is off
→ Turn the camera on
- The operating system is not Windows 98SE, 2000, ME, XP, Vista/ Mac OS
Mac OS 9.0 ~ 10.4. Alternatively the PC does not support USB
→ Install Windows 98SE, 2000, ME, XP, Vista/ Mac OS 9.0 ~ 10.4 to PC that supports USB
- The camera driver is not installed
→ Install a [USB Storage Driver]

Specifications

- Image Sensor
 - Type : 1/1.8" CCD
 - Effective Pixel : Approx. 10.1 Mega-pixel
 - Total Pixel : Approx. 10.3 Mega-pixel
- Lens
 - Focal Length : Schneider Lens f = 7.8 ~ 39mm
(35mm film equivalent : 38~190mm)
 - F No. : F2.8 - F4.4
 - Digital Zoom : · Still Image mode : 1.0X ~ 5.0X
· Play mode : 1.0X ~ 11.4X (depends on image size)
- LCD Monitor : 2.7" color TFT LCD (230,000 pixel)
- Focusing
 - Type : TTL auto focus, Manual Focus
 - Range

Focus Type	Wide(W)	Tele(T)
Normal	80cm-Infinity	1.5m-Infinity
Macro	10cm~80cm	50cm~80cm
Auto Macro	10cm-Infinity	50cm-Infinity
Super Macro	1~10cm (Wide only)	
Manual Focus	1cm-Infinity	50cm-Infinity

- Shutter
 - Speed : Auto : 1 ~ 1/2,000 sec.
Manual, S Mode : 15 ~ 1/2,000 sec.
Night : 15 ~ 1/2,000 sec.
Fireworks : 4 sec.

- Exposure
 - Control : Program AE, Shutter Priority AE, Aperture Priority AE or Manual Exposure
 - Metering : Multi, Center weighted, Spot
 - Compensation : $\pm 2EV$ (1/3EV steps)
 - ISO Equivalent : Auto, 80, 100, 200, 400, 800, 1600
- Flash
 - Modes : Auto, Auto & Red-eye reduction, Fill-in flash, Slow sync, Flash off, Red-eye Fix
 - Range : 0.3~4.9m (Wide), 0.5~3.0m (Tele)
 - Recharging Time : Approx. 5 sec.
- Sharpness : Soft, Normal, Vivid
- Effect : Normal, B&W, Sepia, Red, Green, Blue, Negative, Custom RGB
- White Balance : Auto, Daylight, Cloudy, Fluorescent_H, Fluorescent_L, Tungsten, Custom 1,2
- Voice Recording : Voice Recording (Max 10 hour)
Voice Memo in Still Image (Max. 10 sec.)
- Date Imprinting : Date&Time, Date, Off (user selectable)
- Shooting
 - Still Image : · Modes : Auto, Program, A/S/M, Scene, ASR, Effect
· Scene : Night, Portrait, Children, Landscape, Biz, Close-up, Text, Sunset, Dawn, Backlight, Fireworks, Beach & Snow
 - Continuous : Single, Continuous, High Speed, AEB
Motion Capture : 7fps up to 20 shots
 - Self-timer : 2 sec., Double, 10 sec., Remocon (optional)

Specifications

- Movie Clip :
 - With Audio (recording time : memory capacity dependent, Max. 4GB)
 - Size : 640x480, 320x240
 - Frame rate : 30 fps, 15 fps
 - 5X Optical Zoom and Mute in Zooming

■ Storage

- Media :
 - Internal Memory : About 20MB
 - External Memory (Optional) : SD, MMC(Plus)(2GB guaranteed)/SDHC Card (up to 4GB guaranteed)
- * Internal Memory capacity is subject to change without prior notice.
- File Format :
 - Still Image : JPEG (DCF), EXIF 2.2, DPOF 1.1, PictBridge 1.0
 - Movie : AVI (MPEG-4)
 - Audio : WAV

- Image Size

10M	9M P	7M	7M W	5M	3M	1M
3648X 2736	3648X 2432	3136X 2352	3648X 2056	2688X 2016	2240X 1680	1024X 768

- Capacity (256MB MMC)

	10M	9M P	7M	7M W	5M	3M	1M
Super Fine	49	55	65	64	87	122	419
Fine	94	105	124	122	163	221	617
Normal	136	151	177	174	228	303	733

* These figures are measured under Samsung's standard conditions and may vary depending on shooting conditions and camera settings.

■ Image Play

- Type : Single image, Thumbnails, Slide show, Movie Clip
- Editing : Trimming, Resizing, Rotate, Color Effect, GIF Animation, Red-eye Fix

■ Interface

- Digital output connector : USB 2.0
- Audio : Mono
- Video output : NTSC, PAL (user selectable)
- DC power input connector : 24pin Connector

■ Power Source

- Rechargeable battery : 3.7V Li-ion battery (SLB-1137D)
- Adaptor : SAC-45
- * Included battery may depending on sales region.

■ Dimensions (WxHxD) : 106.6x64.2x21.9mm

■ Weight : 195.3g (without batteries and card)

■ Operating Temperature : 0 ~ 40° C

■ Operating Humidity : 5 ~ 85%

■ Software

- Application : Digimax Master, Digimax Biz Reader
Adobe Reader

※ Specifications are subject to change without prior notice.

※ All trademarks are the property of their respective owners.

Software Notes

Please ensure that you read this instruction manual carefully before use.

- The attached software is a camera driver and image editing software tool for Windows.
- Under no circumstances should all or part of either the software or the user manual be reproduced.
- Copyrights for software are licensed only for use with a camera.
- In the unlikely event of a manufacturing fault, we will repair or exchange your camera.
- We cannot, however, be held responsible in any way for damage caused by inappropriate use.
- Using a Hand-made (self assembled) PC or a PC and OS that has not been guaranteed by the manufacturer is not covered by the Samsung warranty.
- Before using this manual, you should have a basic knowledge of computers and O/S (Operating Systems).

System Requirements

For Windows	For Macintosh
PC with processor better than Pentium 450MHz (Pentium 800MHz recommended)	Power Mac G3 or later
Windows 98SE/2000/ME/XP/Vista	Mac OS 9.0~10.4
Minimum 128MB RAM (512MB recommended) 200MB of available hard disk space (1GB recommended)	Minimum 64MB RAM (256MB recommended)
USB port	USB port
CD-ROM drive	CD-ROM drive
1024x768 pixels, 16-bit color display compatible monitor (24-bit color display recommended), Microsoft DirectX 9.0	

About the software

After inserting the CD-ROM provided with this camera into the CD-ROM drive, the following window should automatically run.



Before connecting the camera to the PC, you should first install the camera driver.

※ Screen Captures illustrated on this manual is based on English Edition of Windows.

■ Camera driver : This enables images to transfer between the camera and PC.

This camera uses the USB Storage Driver as the camera driver. You can use the camera as a USB card reader. After installing the driver and connecting this camera to the PC, you can find [Removable Disk] in [Windows Explorer] or [My Computer]. A USB Storage Driver is provided only for Windows. A USB Driver for MAC is not included with the Application CD. You can use the camera with Mac OS 9.0 ~ 10.4.

■ XviD codec : This allows movie clips (MPEG-4) recorded with this camera to be played back on a PC.

To play back a movie clip recorded with this camera, you must install the XviD codec. If a movie clip recorded with this camera does not play well, install this codec. This software is only compatible with Windows.

■ Digimax Master : This is the all-in-one multi media software solution.

You can download, view, edit and save your digital images and movie files with this software. This software is only compatible with Windows.

About the software

- **Digimax Biz Reader : This is the Visiting Card Recognition software solution.**

You can recognize visiting card and edit namecards database easily with this software. This software is only compatible with Windows.

INFORMATION

- Be sure to check the system requirements before installing the driver.
- To play back the movie taken with this camera on the computer, DirectX 9.0 must be installed.
- You should allow 5 - 10 seconds for running the automatic setup program according to the capability of your computer. If the frame does not show, run the [Windows Explorer] and select [Installer.exe] in the CD-ROM Drive.
- PDF documents of user manual are included in the Software CD-ROM supplied with this camera. Search the PDF files with Window's explorer. Before opening the PDF files, you must install the Adobe Reader included in the Software CD-ROM.
- To install the Adobe Reader 6.0.1 correctly, Internet Explorer 5.01 or later had to be installed. Visit "www.microsoft.com" and upgrade the Internet Explorer.

Setting up the application software

- To use this camera with a PC, install the application software first. After this has been done, the stored images in the camera can be moved to the PC and can be edited by an image editing program.
- You can visit the Samsung web-site through the internet.

<http://www.samsungcamera.com> : English

<http://www.samsungcamera.co.kr> : Korean

1. The auto run frame will display.
Click the [Install] menu in the Auto run frame.



2. Install the camera driver and DirectX by selecting a button shown on the monitor. If a latest version of DirectX was installed on your computer, DirectX may not be installed.



• Setting up the application software

3. To play back a movie clip recorded with this camera on the computer, install the XviD codec.



※ The XviD codec is distributed according to and under the terms and conditions of the GNU General Public License and anyone can copy, modify and distribute this codec freely, but **WITHOUT ANY WARRANTY, IMPLIED OR EXPRESSED, OF MERCHANTABILITY OR FITNESS FOR A PARTICULAR PURPOSE**; provided, however, that you have to follow the GNU General Public License whenever you are distributing this codec or modification thereof. For more information see the GNU General Public License documents (<http://www.gnu.org/copyleft/gpl.html>).

4. Install the Digimax Master in the order shown.

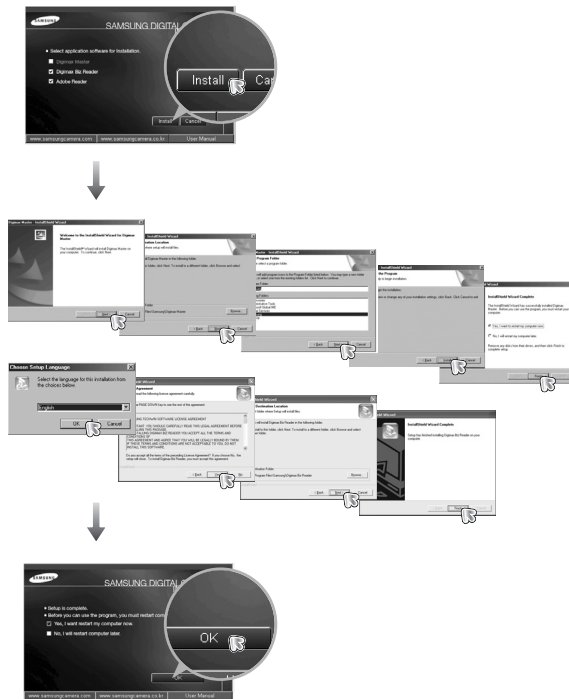

• Setting up the application software

5. After restarting the computer, connect the PC to the camera with the USB cable.

6. Turn on the camera power.

The [Found New Hardware Wizard] will open and the computer will recognise the camera.

- ※ If your OS is Windows XP, an image viewer program will open.
If the download window of Digimax Master opens after starting Digimax Master, the camera driver was set up successfully.

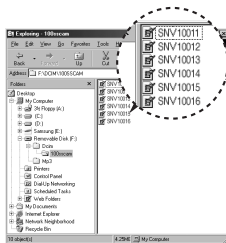

• Starting PC mode

- In this mode, you can download stored images to your PC through the USB cable.
- The LCD monitor is always turned off in PC mode.

■ Connecting the camera to a PC

1. Connect the PC to the camera with the USB cable.
2. Select the [USB]-[Computer] menu by using the smart button.

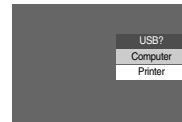

INFORMATION

- If you have installed the camera driver, The [Found New Hardware Wizard] may not open.
- On a Windows 98SE system, the Found New Hardware Wizard dialog box opens and a window asking you to select a driver file may appear. In this case, specify "USB Driver" in the CD supplied.

Starting PC mode

- Connecting the camera to a PC

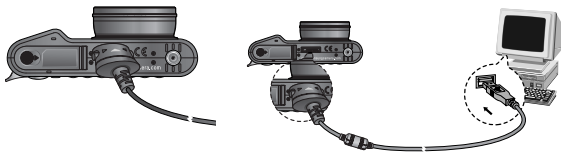

※ If you selected [Printer] in Step 2, when you connect the camera to your printer, the [Connecting Printer] message will display and the connection will not be established.

In this case, disconnect the USB cable, and then follow the procedure from Step 1 and onward.

- Disconnecting the camera and PC : Refer to page 77
(Removing the removable disk).

INFORMATION

- Before inserting any cables or AC adapter, check the directions and do not insert by force. It may damage the cable or camera.

- Downloading stored images

You can download the still images stored on the camera to your PC's hard disk and print them or use a photo editing software to edit them.

1. Connect the camera to your PC with the USB cable.

2. On your computer's desktop display, select [My computer] and double click [Removable Disk → DCIM → 100SSCAM].
The image files will then be displayed.

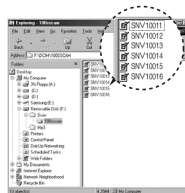

3. Select an image and press the right mouse button.

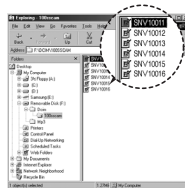

4. A pop-up menu will open.

Click the [Cut] or [Copy] menu.

- [Cut] : cuts selected files.
- [Copy] : copies selected files.

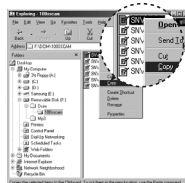

5. Click a folder where you want to paste the file.

Starting PC mode

6. Press the right mouse button and a pop-up menu will open. Click [Paste].

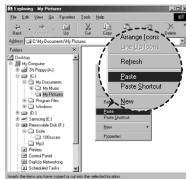

7. An image file is transferred from the camera to your PC.







- By using [Digimax Master], you can see the stored images in the memory directly on the PC monitor and you can copy or move the image files.

CAUTION

- We recommend that you should copy the images to the PC to view them. Opening images directly from the removable disk may be subject to unexpected disconnection.
- When you upload a file that is not taken by this camera to the Removable Disk, the [File Error!] message will be displayed on the LCD monitor in the PLAY mode, and nothing is displayed in THUMBNAIL mode.

Removing the removable disk

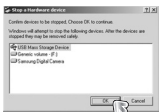
- Windows 98SE
 1. Check whether the camera and PC are transferring a file.
If the camera status lamp blinks, please wait until the lamp has finished blinking and is constantly on.
 2. Unplug the USB cable.
- Windows 2000/ME/XP/Vista
(The illustrations may differ from those shown depending on the Windows O/S.)
 1. Check whether the camera and PC are transferring a file.
If the camera status lamp blinks, please wait until the lamp has finished blinking and is constantly on.
 2. Double-click the [Unplug or Eject Hardware] icon on the task bar.

[Double-click!]
 3. The [Unplug or Eject Hardware] window will open. Select the [USB Mass Storage Device] and click the [Stop] button.
 4. The [Stop a Hardware device] window will open. Select the [USB Mass Storage Device] and click the [OK] button.
 5. A [Safe to Remove Hardware] window will open. Click the [OK] button.

● Removing the removable disk

6. A [Unplug or Eject Hardware] window will open. Click the [Close] button and the removable disk may be safely removed.



7. Unplug the USB cable.

● Setting up the USB Driver for MAC

1. A USB Driver for MAC is not included with the software CD as MAC OS supports the camera driver.
2. Check the MAC OS version during start-up.
This camera is compatible with MAC OS 9.0 ~ 10.4.
3. Connect the camera to the Macintosh and turn the camera power on.
4. A new icon will be displayed on the desktop after connecting the camera to the MAC.

● Using the USB Driver for MAC

1. Double click a new icon on the desktop and the folder in the memory will be displayed.
2. Select an image file and copy or move it to MAC.

CAUTION

- For Mac OS 10.0 or later : First complete uploading from computer to camera and then remove the removable disk with the Extract command.

● Removing the USB Driver for Windows 98SE

- To remove the USB driver, refer to the process shown below.
 1. Connect the camera to your PC and turn them on.
 2. Check whether the Removable Disk is on the [My Computer].
 3. Remove the [Samsung Digital Camera] on the Device manager.



4. Disconnect the USB cable.
5. Remove the [Samsung USB Driver] on the Add / Remove Programs Properties.

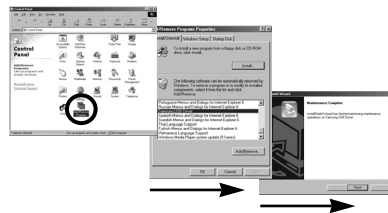

6. Uninstallation is complete.

● Digimax Master

- You can download, view, edit and save your images and movies with this software. This software is only compatible with Windows.
- To start the program, click [Start → Programs → Samsung → Digimax Master → Digimax Master].

● Downloading images

1. Connect the camera to your PC.

2. A window for downloading images will display after connecting the camera to your PC.

- To download the captured images, select the [Select All] button.
- Select desired folder in the window and click the [Select All] button. You can save captured images and selected folders.
- If you click the [Cancel] button, downloading will be cancelled.



3. Click [Next >] button.



4. Select a destination and make a folder to save downloaded images and folders.
- Folder names can be made in order of date and images will be downloaded.
 - Folder name will be made as you want and images will be downloaded.
 - After selecting a folder that was made before, images will be downloaded.



5. Click [Next >] button.

6. A window will open as shown alongside. The destination of the selected folder will be displayed on the upper side of the window. Click the [Start] button to download the images.



7. Downloaded images will be displayed.



• Digimax Master

- Image viewer : You can view the stored images.

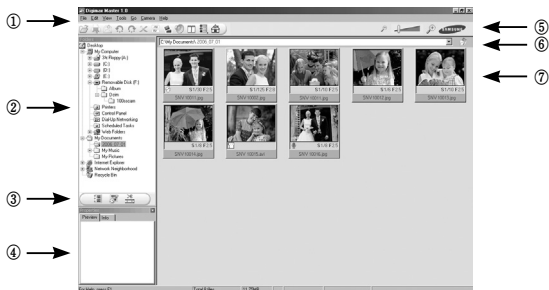

- Image viewer functions are listed below.

- ① Menu bar : You can select menus.
File, Edit, View, Tools, Change functions, Auto download, help, etc.
- ② Image selection window : You can select the desired images in this window.
- ③ Media type selection menu : You can select image viewer, image edit and movie edit functions in this menu.
- ④ Preview window : You can preview an image or a movie clip and check the multi media information.
- ⑤ Zoom bar : You can change preview size.
- ⑥ Folder display window : You can see the folder location of the selected image.
- ⑦ Image display window : Images in the selected folder are displayed.

※ Refer to the [Help] menu in Digimax Master for further information.

- Image edit : You can edit the still image.

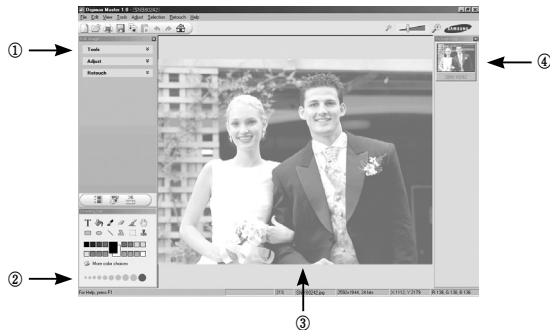

- Image edit functions are listed below.

- ① Edit menu : You can select the following menus.
[Tools] : You can resize or crop the selected image. See the [Help] menu.
[Adjust] : You can modify image quality. See the [Help] menu.
[Retouch] : You can change image or insert effects on the image. See the [Help] menu.
- ② Drawing tools : Tools for editing an image.
- ③ Image display window : A selected image displays in this window.
- ④ Preview window : You can preview the changed image.

- ※ A still image edited with Digimax Master can't be played back on the camera.
- ※ Refer to the [Help] menu in Digimax Master for further information.

• Digimax Master

- **Movie edit** : You can get the still image, movie clip, narration, music files together in a movie clip.



- Movie clip edit functions are listed below.

- ① **Edit menu** : You can select the following menus.

[Add Media] : You can add other media elements to a movie.

[Edit Clip] : You can change the brightness, contrast, colour and saturation.

[Effects] : You can insert an effect.

[Set Text] : You can insert texts.

[Narrate] : You can insert a narration.

[Produce] : You can save the edited multi media as a new file name.
You can select AVI, Windows media (wmv) and Windows media (asf) file types.

- ② **Frame display window** : You can insert multi media in this window.

- ※ Some movie clips that were compressed with a codec that is not compatible with the Digimax Master can't play back in the Digimax Master.
- ※ Refer to the [Help] menu in Digimax Master for further information.

• Digimax Biz Reader

- Digimax Biz Reader is digital business card management software which recognize the information on business card like name, company, telephone number, e-mail and so on. It offers the more effective business information management solution with digital camera.

This software is only compatible with Windows

Digimax Biz Reader recognizes English and Korean business namecard only.

- **Auto recognizing when camera connected with computer (BizChecker)**
After installing <Biz Reader>, if you connect the SAMSUNG digital camera with your computer, namecard images are recognized automatically.

<BizChecker> is auto-installing program when <BizReader> installing.

1. Check the <BizChecker> program is running at Windows tray.

If it is not exist, run the <BizReader> program on background or Windows start menu, and <BizChecker> will run at the same time.



2. Connect the camera to your PC with the USB cable.

3. After a few moment, if new namecard image exist, next dialog box will be appeared. (Camera auto-detection function will be worked when <BizReader> is running.) If you check <Delete Original Image>, the namecard image in digital camera will be deleted.

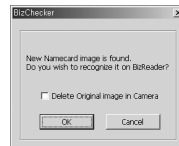

4. If you click <OK> button, new namecard images are recognized automatically.

● Digimax Biz Reader

■ Recognizing the namecard image file

● Downloading camera's namecard images to computer

1. Connect the camera to your PC with the USB cable.
2. On your computer's desktop display, select [My computer] and double click [Removable Disk → DCIM → 100SSCAM]. The image files will then be displayed.

* File names assigned in the Biz mode, will be set SB1ZXXXX

3. Downloading camera's namecard images : Refer to page 76 (Downloading stored images).

2. Click the [Open] button.



3. Select the namecard image files and click the [Open] button.

(To select several image files, use <Shift> key or <Ctrl> key with your mouse.)

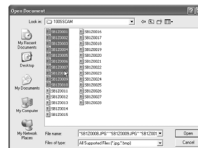

4. Namecard images are recognized automatically.

● Recognizing namecard image file

1. Run the Digimax Biz Reader by double click on the icon.

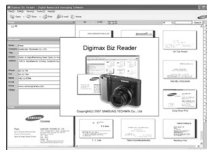

• Digimax Biz Reader

- Partial recognizing : Partial recognition function can be used when mis-recognition.
 1. Select the namecard to partial editing.
 2. Drag the area to partial editing in namecard image window, choose the proper field in pop-up window, and then the recognized result is entered to the field automatically.

※ Drag only the character area without margin.
※ Refer to the [Help] menu in Digimax Biz Reader for further information.

CAUTION

- When you picturing the namecard in Biz mode, avoid the place where too bright or too dark.
- Take a namecard image with full size shot in guide line without any margin.
- Adjust the focus by half-pressing camera shutter before taking a picture.
- If you use the tripod, it is easier to take clear shot.

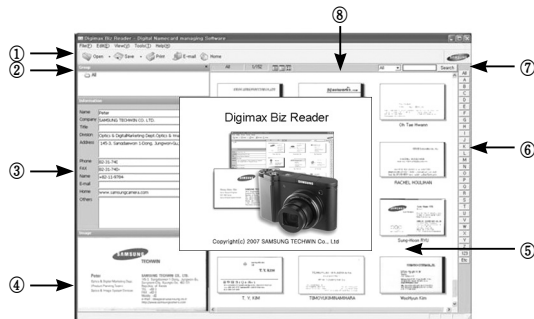

- Digimax Biz Reader functions are listed below.

- ① Menu and Buttons : You can select menus.
(Open, Save, Print, E-mail, Home)
- ② View mode : List View, Thumbnail+List View, Thumbnail View.
- ③ Group window : You can manage the group.
- ④ Image window : Name card Images in the selected folder are displayed.
- ⑤ List Window : You can preview an image and a contents.
- ⑥ Index : You can Search index.
- ⑦ Search : You can Search by keyword input quickly.
- ⑧ Array Button : You can array the following menus in List View,
Thumbnail+List View mode.
(Name, Title, Company, Mobile, Phone, Address, Homepage)

※ Refer to the [Help] menu in Digimax Biz Reader for further information.

FAQ

- Please check the following if the USB connection malfunctions.

Case 1 USB cable is not connected or it is not the supplied USB cable.
→ Connect the supplied USB cable.

Case 2 The camera is not recognised by your PC.
Sometimes, the camera may appear under [Unknown Devices] in Device Manager.
→ Install the camera driver correctly.
Turn off the camera, remove the USB cable, plug in the USB cable again, and then turn on the camera.

Case 3 There is an unexpected error during file transfer.
→ Turn the camera power off and on again. Transfer the file again.

Case 4 When using a USB hub.
→ There may be a problem in connecting the camera to the PC through a USB hub if the PC and the hub are not compatible.
Wherever possible, connect the camera directly to the PC.

Case 5 Are other USB cables connected to the PC?
→ The camera may malfunction when it is connected to the PC at the same time as another USB cable. In this case, disconnect the other USB cable, and only connect the camera USB cable to the PC.

Case 6 When I open the Device Manager (by clicking Start → (Settings) → Control Panel → (Performance and Maintenance) → System → (Hardware) → Device Manager), there are Unknown Devices or Other Devices entries with a yellow question mark (?) beside them or devices with an exclamation mark (!) beside them.
→ Right-click on the entry with the question (?) or exclamation (!) mark and select "Remove". Restart the PC and connect the camera again. For Windows 98SE PC, remove the camera driver, restart the PC, and then reinstall the camera driver.

Case 7 In some security programs (Norton Anti Virus, V3, etc.), the computer may not recognise the camera as a removable disk.
→ Stop the security programs and connect the camera to the computer. Refer to the security program instructions about how to temporarily disable the program.

Case 8 The camera is connected to the USB port located on the front of the computer.
→ When the camera is connected to the USB port located on the front of the computer, the computer may not recognise the camera. Connect the camera to the USB port located on the back of the computer.

- When the movie clip doesn't play back on the PC
- ※ When the movie clip recorded by the camera doesn't play back on the PC, the causes are most likely due to the codec installed on the PC.

FAQ

- When a codec for playing back the movie clip isn't installed, or isn't compatible
→ Install the codec as listed below.

[Installing codec for Windows]

1) Insert the CD provided with the camera.

2) Run the Windows Explorer and select [CD-ROM drive:\XviD] folder and click the XviD-1.1.0-30122005.exe file.

※ The XviD codec is distributed according to the GNU General Public License and anyone can copy, distribute and change this codec. This License applies to any program or other work which contains a notice placed by the copyright holder saying it may be distributed under the terms of this General Public License.

For more information, see the License documents
(<http://www.gnu.org/copyleft/gpl.html>).

- When the DirectX 9.0 or later is not installed

→ Install the DirectX 9.0 or later

1) Insert the CD provided with the camera

2) Run the windows explorer and select the [CD-ROM drive:\ USB Driver\ DirectX 9.0] folder and click the DXSETUP.exe file.

The DirectX will be installed. Visit the following site for downloading the DirectX. <http://www.microsoft.com/directx>

- If a PC (Windows 98SE) repeatedly stops responding while the camera and PC are connected
→ If a PC (Windows 98SE) is turned on for a long time and the camera has to be repeatedly re-connected, the PC may not recognise the camera. In this case, restart the PC.
- If a PC connected with the camera stops responding while Windows is starting.
→ In this case, disconnect the PC and the camera and Windows will start.
If the problem happens repeatedly, set the Legacy USB Support to disable and re-start the PC. The Legacy USB Support is in the BIOS setup menu. (The BIOS setup menu differs from the PC manufacturers and some BIOS menus don't have Legacy USB Support) If you can't change the menu by yourself, contact to the PC manufacturer or BIOS manufacturer.
- If the movie clip can't be deleted, or if a removable disk can't be extracted or if an error message displays during the file transfer.
→ If you install only the Digimax Master, the problems mentioned above occasionally happen.
 - Close the Digimax Master program by clicking the Digimax Master icon on the Taskbar.
 - Install all the application programs included in the software CD.

Correct Disposal of This Product



Correct Disposal of This Product (Waste Electrical & Electronic Equipment)

(Applicable in the European Union and other European countries with separate collection systems) This marking shown on the product or its literature, indicates that it should not be disposed with other household

wastes at the end of its working life.

To prevent possible harm to the environment or human health from uncontrolled waste disposal, please separate this from other types of wastes and recycle it responsibly to promote the sustainable reuse of material resources. Household users should contact either the retailer where they purchased this product, or their local government office, for details of where and how they can take this item for environmentally safe recycling. Business users should contact their supplier and check the terms and conditions of the purchase contract.

This product should not be mixed with other commercial wastes for disposal.



Samsung Techwin cares for the environment at all product manufacturing stages to preserve the environment, and is taking a number of steps to provide customers with more environment-friendly products. The Eco mark represents Samsung Techwin's will to create environment-friendly products, and indicates that the product satisfies the EU RoHS Directive.

FCC notice

NOTE :

This equipment has been tested and found to comply with the limits for a Class B digital device, pursuant to part 15 of the FCC Rules. These limits are designed to provide reasonable protection against harmful interference in a residential installation.

This equipment generates, uses and can radiate radio frequency energy and, if not installed and used in accordance with the instructions, may cause harmful interference to radio communications. However, there is no guarantee that interference will not occur in a particular installation. If this equipment does cause harmful interference to radio or television reception, which can be determined by turning the equipment off and on, the user is encouraged to try to correct the interference by one or more of the following measures:

- Reorientate, or relocate, the receiving antenna.
- Increase the separation between the equipment and receiver.
- Connect the equipment into an outlet on a circuit different from that to which the receiver is connected.
- Consult the dealer or an experienced radio / TV technician for help.

CAUTION :

Changes or modifications not expressly approved by the manufacturer responsible for compliance could void the user's authority to operate the equipment.

Declaration of Conformity

Trade Name : SAMSUNG TECHWIN
Model No. : Samsung NV11
Responsible Party : Samsung Opto-Electronics America, INC.
Address : 40 Seaview Dr. Secaucus, NJ 07094
Telephone No. : 201-902-0347

This device complies with Part 15 of the FCC Rules. Operation is subject to the following two conditions: (1) This device may not cause harmful interference, and (2) this device must accept any interference received, including interference that may cause undesired operation.

• MEMO

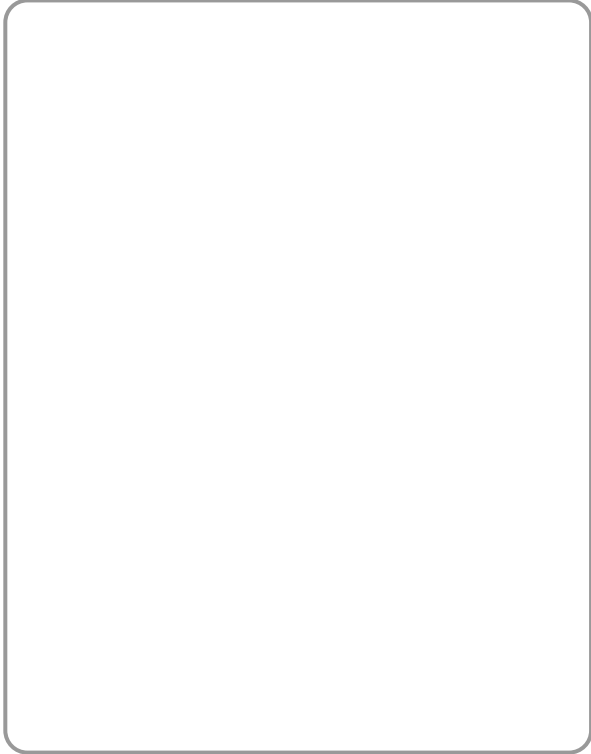

• MEMO

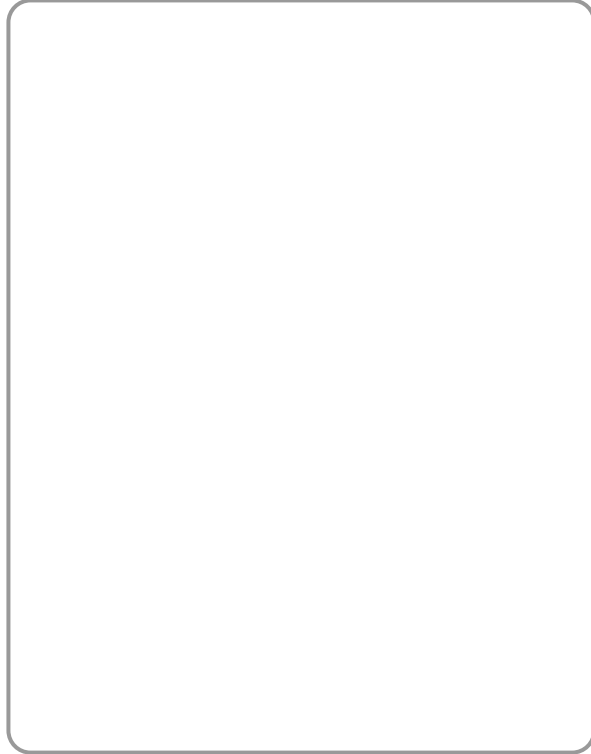

• **MEMO**

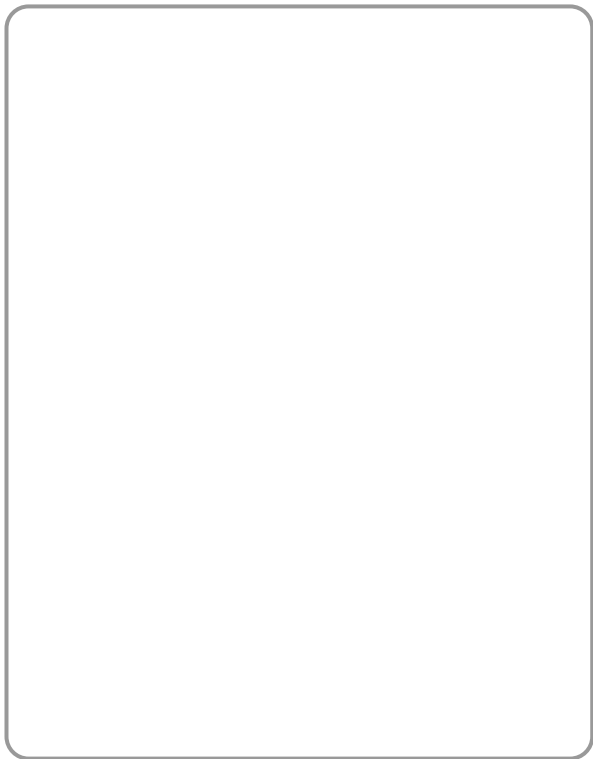

• **MEMO**

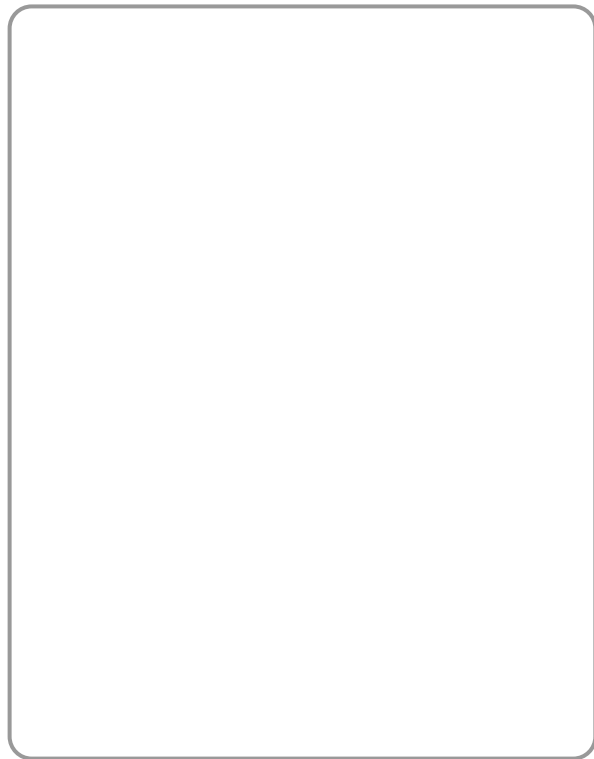

The Samsung logo, consisting of the word "SAMSUNG" in a bold, sans-serif font, is centered within a dark, horizontally-oriented oval.

SAMSUNG TECHWIN CO., LTD.

OPTICS & DIGITAL IMAGING DIVISION

145-3, SANGDAEWON 1-DONG, JUNGWONGU,
SUNGNAM-CITY, KYUNGKI-DO, KOREA
462-121

TEL : (82) 31-740-8086, 8088, 8090, 8092, 8099

FAX : (82) 31-740-8398

www.samsungcamera.com

SAMSUNG FRANCE S.A.S.

BP 51 TOUR MAINE MONTPARNASSE 33,
AV. DU MAINE 75755, PARIS CEDEX 15, FRANCE
HOTLINE PHOTO NUMÉRIQUE :

00 800 22 26 37 27 (Numéro Vert-Appel Gratuit)

TEL : (33) 1-4279-2200

FAX : (33) 1-4320-4510

www.samsungphoto.fr

SAMSUNG OPTO-ELECTRONICS UK LIMITED

SAMSUNG HOUSE 1000 HILLSWOOD DRIVE
HILLSWOOD BUSINESS PARK
CHERTSEY KT16 OPS U.K.

TEL : 00800 12263727

(free for calls from UK only)

UK Service Hotline : 01932455320

www.samsungcamera.co.uk

SAMSUNG OPTO-ELECTRONICS AMERICA, INC.

HEADQUARTERS

40 SEAVIEW DRIVE, SECAUCUS,
NJ07094, U.S.A.

TEL : (1) 201-902-0347

FAX : (1) 201-902-9342

WESTERN REGIONAL OFFICE

18600 BROADWICK ST.,
RANCHO DOMINGUEZ, CA 90220, U.S.A.

TEL : (1) 310-900-5284/5285

FAX : (1) 310-537-1566

www.samsungcamerausa.com

SAMSUNG OPTO-ELECTRONICS GMBH

AM KRONBERGER HANG 6
D-65824 SCHWALBACH/TS., GERMANY

TEL : 49 (0) 6196 66 53 03

FAX : 49 (0) 6196 66 53 66

www.samsungcamera.de

TIANJIN SAMSUNG OPTO-ELECTRONICS CO., LTD

No.9 zhangheng Street. Micro-Electronic
Industrial Park Jingang Road Tianjin China.

POST CODE : 300385

TEL : (86) 22-2761-4599

FAX : (86) 22-2769-7558

www.samsungcamera.com.cn

RUSSIA INFORMATION CENTER

SAMSUNG ELECTRONICS

117545 ST. DOROZHNYAYA BUILDING 3,
KORPUS 6, ENTRANCE 2, MOSCOW, RUSSIA
TEL : (7) 495-363-1700

CALL FREE : (8) 800 200 0 400 (from Russia only)

www.samsungcamera.ru

Internet address - <http://www.samsungcamera.com>



The CE Mark is a Directive conformity
mark of the European Community (EC)

6806-3755