

The Samsung logo is located in the top left corner, consisting of the word "SAMSUNG" in a bold, sans-serif font, enclosed within a white, horizontally-oriented oval shape. The background of the entire page is a dark grey gradient with abstract, light-colored wavy lines that create a sense of depth and movement.

SAMSUNG

User Manual

GX-20

Thank you for buying a Samsung Camera.
This manual will guide you through using the camera, including capturing images, downloading images and using the application software.
Please read this manual carefully before using your new camera.

Important Safety Information

Thank you for buying a Samsung Digital Camera.

- **Prior to using this camera, please read this user manual thoroughly.**
- **When you require After Sales service, please bring the camera and the cause of the camera malfunction (such as battery, Memory card etc.) to the After Sales centre.**
- **To avoid disappointment please ensure that your camera is operating properly well before you intend to use it (e.g. for a trip or an important event). Samsung Cameras take no responsibility for any loss or damages that may result from camera malfunction.**
 - Microsoft, Windows and Windows logo are registered trademarks of Microsoft Corporation incorporated in the United States and/or other countries.
 - All brand and product names appearing in this manual are registered trademarks of their respective companies.
 - Specifications are subject to change without prior notice.
 - Pictures used in this user guide are to help users understand products and the results may be different depending on the types of lenses or the shooting environment.

 **DANGER** DANGER indicates an imminently hazardous situation which, if not avoided, will result in death or serious injury.

- **Do not attempt to modify this camera in any way. This may result in fire, injury, electric shock or severe damage to you or your camera.**

Internal inspection, maintenance and repairs should be carried out by your dealer or Samsung Camera Service centre.
- **Please do not use this product in close proximity to flammable or explosive gases, as this could increase the risk of explosion.**

This may cause an ignition or explosion.
- **Should any form of liquid or a foreign object enter the camera, do not use it. Switch off the camera, and then disconnect the power source (batteries or AC Power Adapter). You must contact your dealer or Samsung Camera Service centre.**

Do not continue to use the camera as this may cause a fire or electric shock.
- **Do not insert or drop metallic or inflammable foreign objects into the camera through access points e.g. the memory card slot and battery chamber.**

This may cause a fire or electric shock.
- **Do not operate this camera with wet hands.**

This could pose a risk of electric shock.

 **WARNING** WARNING indicates a potentially hazardous situation, which, if not avoided, could result in death or serious injury.

- **Do not use the flash in close proximity to people or infants.**

Positioning the flash too close to your subject's eyes, may cause eyesight damage.
- **When taking photographs, never point the lens of the camera directly into very strong light.**

This may result in permanent damage to your eyesight
- **For safety reasons keep this product and accessories out of reach of children or infants to prevent accidents e.g.:**
 - Swallowing batteries or small camera accessories. If an accident should occur, please consult a doctor immediately.
 - There is the possibility of injury from the camera's moving parts.
- **Batteries and camera may become hot during prolonged use which may result in camera malfunction. Should this be the case, allow the camera to sit idle for a few minutes to allow it time to cool.**
- **Do not leave this camera in places subject to extremely high temperatures, such as a sealed vehicle, direct sunlight or other places of extreme variations in temperature.**

Exposure to extreme temperatures may adversely affect the camera's internal components and could cause a fire.
- **When in use, do not cover the camera or AC Power Adapter. This may cause heat to build up and distort the camera body or cause a fire.**

Always use the camera and its accessories in a well-ventilated area.

Important Safety Information

 **CAUTION** CAUTION indicates a potentially hazardous situation, which, if not avoided, could result in death or serious injury.

- **Please use the batteries in appropriate ways referring to the following:**
 - Leaking, overheating, or burst batteries could result in fire or injury.
 - Use batteries with the correct specification for the camera.
 - Do not short circuit, heat or dispose of battery in fire.
 - Do not insert the batteries with polarities reversed.
- **Do not fire the flash while it is in contact with hands or objects.**
Do not touch the flash after using it continuously. It may cause burns.
- **If you are using the AC power adaptor be careful when moving the camera.**
After use, always switch off the camera before unplugging the adaptor from the wall socket. Then make sure that any connector cords or cables to other devices are disconnected before moving the camera.
Failure to do so may damage the cords or cables and cause a fire or electric shock.
- **Only use the appropriate type of lenses recommended by your local SAMSUNG dealer.**

Precautions for Battery Usage

- **Only use specified batteries (SLB-1674) with this camera.**
Use of other batteries can cause overheating or explosion.
- **Do not allow metallic or inflammable foreign objects to come into contact with the battery.**
- **Remove the battery when not planning to use the camera for a long period of time.**
Otherwise the battery may leak corrosive electrolyte and permanently damage the camera's components.
- **If there is overheating in, or smoke from, the battery chamber, remove the battery from the camera as soon as possible.**
When doing so, take care to avoid burns. Contact your dealer or Samsung Camera Service Centre.
- **Do not disassemble the battery.**
It may cause leakage or breakage.

- **If liquid from the battery enters the eyes, wash it away immediately with fresh water and consult a doctor.**
It may cause loss of eyesight.
- **If any of the battery leakage should come in contact with skin or clothes, wash the affected areas thoroughly with water.**
- **If there is overheating in, or smoke from, the battery chamber, remove the battery from the camera as soon as possible.**
When doing so, take care to avoid burns. And then contact your dealer or Samsung Camera Service Centre.
- **The battery is expendable and its life is shortened through use. If the battery capacity is reduced by half, purchase new one.**
- **After removing the batteries for about 30 days, the camera may be reset.**

Precautions for Charger Usage

- **Only use the specified charger with this camera.**
The charger, SBC-L6 is specified for this product.
- **Other chargers can cause fire or electric shock. Observe the power specification. (100-240V only)**
- **Only charge the specified rechargeable battery (SLB-1674).**
Failure to follow this instruction may cause fire, electric shock or malfunction.
- **Do not disassemble the charger.**
It may cause fire, electric shock or malfunction.
- **If the charger smokes or overheats, stop using it immediately and contact your dealer or Samsung Camera Service Centre as soon as possible.**
This may cause a fire or electric shock.
- **If water gets inside the camera, stop using the camera and contact your dealer or Samsung Camera Service Centre.**
This may cause a fire or electric shock.
- **If the lightning flashes or thunder fills the air, disconnect the power plug.**
It may cause breakage, fire or electric shock.
- **If there is dirt on the plug, clear the dirt.**
This may cause a fire.

Contents

053 Using the Menu

053	Using the MENU button
054	Using the CAPTURE MENU
054	Picture Wizard
055	File Format
055	JPEG Size
055	JPEG Quality
056	Colour Space
056	Set RAW Button
056	Liveview
057	User Registration
057	Interval Shooting
057	Extended Bracket
058	Multi Exposure
059	Memory of Settings
059	OIS (Optical Image Stabilization)
060	Using the CUSTOM1 MENU
060	Link AF Point & AE
060	Superimpose AF Area
060	AF in remote control
061	AF Button Function
061	AF by Press Halfway
061	Catch in Focus
062	EV Steps
062	Metering Time
062	AE-L with AF Locked
062	Program Line
063	Auto EVC
063	Fine Tune when AWB
063	WB when using flash
063	WB Adjustable Range
064	Colour Temp. Unit
064	Noise Reduction
064	High Noise
064	ISO Display
065	ISO Steps
065	Set Max ISO Range
065	Reset Custom1

066	Using the CUSTOM2 MENU
066	E-Dial in Program / Sv / Tv / Av / TAv / M / X / B
066	Green Button in TAv&M
066	Use Aperture Ring
067	One-touch Bracketing
067	Bracketing Order
067	Remaining Count
067	Release in Charging
068	Preview Method
068	Initial Zoom
068	Auto Rotation
068	Saving Rotation Info.
069	Select Battery
069	Light of Top LCD
069	Flash in Wireless Mode
069	Reset Custom2
070	Using the SETUP MENU
070	Format
070	Beep
071	Date/Time
071	Language/言語
071	Guide Display
072	LCD Brightness
072	LCD colour adjustment
072	Video Out
073	USB (Selecting an external device)
073	Auto Power Off
073	Folder Name
074	Change File Name
074	Sensor Cleaning
075	Dust Removal
075	Dust Alert
076	Pixel Mapping
076	AF fine adjustment
076	Reset
077	Using the PLAYBACK MENU
077	Exposure Warning
077	Quick View
078	Digital Preview
078	Digital Filter

Contents

Using Advanced Shooting Modes

- 080 Using the best programmed exposure, P (Program) mode**
 - 080 P (Automatic Program Exposure) Mode
- 082 Shooting in the different exposure rates**
 - 082 Sv (Sensitivity Priority) Mode
- 083 Taking a picture of a fast-moving subject**
 - 083 Tv (Shutter Priority) Mode
- 084 Expressing the background out of focus**
 - 084 Av (Aperture Priority) Mode
- 085 Using the automatic ISO setting mode**
 - 085 TA_v (Shutter & Aperture Priority) Mode
- 086 Using the manual mode to choose your own camera settings**
 - 086 M (Manual) Mode
 - 086 EV Bar
- 087 Shooting with long time shutter speed**
 - 087 B (Bulb) Mode
- 088 Using the external flash**
 - 088 X (Flash X-Sync) Mode
- 089 Saving your own exposure setting and using the stored set value**
 - 089 User Mode
- 090 Changing the Exposure and Shooting (Auto Bracket)**
- 092 Setting the Colour Temperature**
 - 092 Setting the White Balance
 - 093 Adjusting the White Balance Manually
 - 094 Fine-Tuning the White Balance
- 096 Adjusting the sensitivity of the image sensor**
 - 096 Setting the Sensitivity
 - 096 Setting the Range of Automatic Correction in AUTO

Using the Flash

- 098 Using the Built-in Flash**
 - 098 Selecting Flash Mode
 - 099 Using Auto Discharge
 - 100 Using Fill-in Flash
 - 100 Using Red-eye Reduction Flash
 - 101 Front curtain sync, Rear curtain sync
 - 101 Daylight-Sync Shooting
 - 102 Compensating Flash Output
 - 102 Flash Characteristics in Each Exposure Mode
 - 103 Using Slow-Speed-Sync
 - 104 Distance and Aperture when Using the Built-in Flash
 - 104 Calculating Aperture Value from Shooting Distance
 - 104 Calculating Shooting Distance from Aperture Value
- 105 Using an External Flash (Sold Separately)**
 - 105 About the LCD Panel Display for SEF-36PZ_F
 - 106 Using P-TTL Auto Mode
 - 106 Using High-Speed Flash Sync Mode
 - 107 Using in Wireless Mode
 - 107 Red-Eye Reduction
 - 108 Using the external flash sync terminal

How to Playback the Images

- 110 Playing Back Still Pictures**
 - 110 Rotating Images
 - 111 Displaying Multiple Images
 - 111 Selecting the Number of Images to Display
 - 111 Displaying a Folder
 - 112 Slideshow
 - 113 Digital Filters
 - 115 Converting RAW files to JPEG format

Contents

Using the Software

- 116 Deleting Images**
 - 116 Deleting a Single Image
 - 116 Deleting All Images
 - 117 Deleting Selected Images (from Nine-Image Display)
 - 117 Deleting Folders
 - 118 Deleting images taken with the RAW+ button
- 119 Protecting Images from Deletion**
 - 119 Protecting a Single Image
 - 119 Protecting All Images
- 120 Connecting the Camera to AV Equipment**
- 122 Software Notes**
 - 122 System Requirements
- 124 Setting up the application software**
 - 125 Starting PC mode
- 126 Removable Disk**
 - 126 Downloading stored images
- 127 Removing the removable disk**
 - 127 Windows 2000/ME/XP/Vista
 - 127 Setting up the USB Driver for MAC
 - 127 Using the USB Driver for MAC
- 128 Samsung Master**
 - 128 Downloading images
 - 130 Image viewer
 - 131 Image edit
 - 132 Movie edit
- 133 Using the Samsung RAW Converter 2.0**
 - 133 Developing the RAW files
 - 134 Correcting the exposure
 - 135 Handling the JPEG/TIFF files as you edit RAW files
 - 135 Saving the RAW files into JPEG or TIFF format

How to Make a Photo Print

- 138 Setting the Printing Service (DPOF)**
 - 138 Printing Single Images
 - 139 Settings for All Images
- 140 Printing Using PictBridge**
 - 140 Connecting the Camera to the Printer
 - 141 Printing Single Images
 - 143 Printing All Images
 - 144 Printing Images Using the DPOF Settings
 - 144 Disconnecting the Cable from the Printer

Appendix

- 146 Optional Accessories**
 - 146 External Flash (SEF-54PZF / SEF-36PZF)
 - 146 Camera Case
 - 146 Others
- 147 Troubleshooting**
- 152 Main Specifications**
- 154 Glossary**
- 156 Index**
- 158 Correct Disposal of This Product**
- 158 FCC notice**

Feature

- The 14.60 effective Megapixel of SAMSUNG digital camera sensor. (High dynamic range.)
- Built-in Optical Image Stabilization (OIS) minimizes or prevents digital images from becoming blurred due to camera shake.
- Features an **Auto-Focus** sensor with 11 focusing points. The central 9 are wide cross area sensors.
- Improved manual focusing using a viewfinder similar to a conventional 35 mm SLR camera, with 0.95x magnification. Also features a superimpose function in which the focus points on the viewfinder illuminate red.
- Features a large 2.7-inch LCD monitor with 230,000 pixels and a **Brightness Adjusting** function for high-precision viewing performance.
- **The Large, High-Resolution LCD Monitor** and clear menus make the camera **Easy to Operate**.
- The **SP Coated Sensor** minimises dust. Any **Remaining dust** can be removed with sensor clear function.
- You can select **JPEG** or **RAW** image format. Or you can select JPEG and RAW at the same time.
- This is a **Dustproof** and **Damp Proof** camera for safe outdoor shooting.
- Features a **Digital Preview** function for checking the image to ensure that the desired result is achieved.
- The comfort and flexibility of the continuous **Liveview** function directly on the LCD is available to users.
- The **Picture Wizard** function enables you to adjust image before shooting. You can create the image you desire by adjusting the colour tone, saturation, and contrast and so on.



The captured area (view angle) will differ between the GX-20 and 35mm SLR cameras even if the same lens is used because the format size for 35mm film and the sensor are different.

Sizes for 35mm film and Size of Sensor

35mm film: 36mm x 24mm

GX-20 sensor: 23.4mm X 15.5mm

Angles of view being equal, the focal length of a lens used with a 35mm camera must be approximately 1.5 times longer than that of GX-20.

To get the equivalent angle of view for a full-frame 35mm camera, divide the focal length of the 35 mm camera by 1.5. (When you use the GX-20 for shooting.)

Example) To get the equivalent angle of view of a 150 mm lens on a full-frame 35mm camera, you will get "100," dividing 150 by 1.5.

Use a 100mm lens with the GX-20.

The equivalent focal length on a full-frame 35 mm camera is calculated in a opposite way of calculation as follows:

Example) If 300mm lens is used with GX-20
300x1.5=450

Focal length is equivalent to 450mm lens on a 35mm camera.

*** Calculation method used above is to help users understand products and the results may be different depending on the types of lenses or the shooting environment. Calculated focal length value is based on the difference between the 35 mm film format and camera sensor in size. (GX-20 was used as standard to compare.)**

Understanding illustrated icons used in this user guide

Please read this basic information thoroughly before you start using the product.

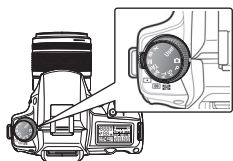

 This icon indicates the program mode dial.

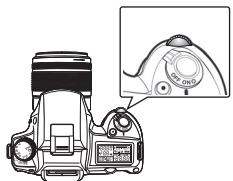



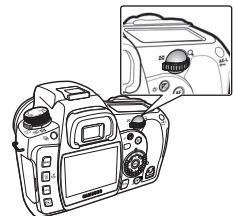

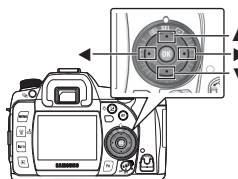

 This icon indicates the front dial.



 This icon indicates the rear dial.



() , () , and () icons indicate the direction buttons.
() , () , () or () icons indicates the each direction button.



This "Note" symbol indicates information that supplements important points of the main text.



This "Warning" symbol advises users that failure to take or avoid a specific action could result in physical harm to the user or the hardware.

Contents of the Operating Manual

This operating manual contains the following chapters.

1. Before Starting to Take a Picture

Explains camera characteristics, accessories and the names of various parts.

2. Starting Basic Shooting (Auto mode)

This chapter gives a quick guidelines for the first time users to take a picture using the basic shooting mode. (Auto mode.)

3. Getting a Better Picture by Using More Functions

This chapter helps users achieve a better picture by learning how to get a camera's angle of view, exposure, focusing the object, and so on.

4. Using Advanced Shooting Modes

This chapter explains how to use the advanced shooting mode such as Tv (Shutter-Priority AE) mode, Av (Aperture-Priority AE) mode, and so on.

5. Using the Flash

This chapter explains how to take a picture in a dark place using the flash.

6. How to Playback the Images

Explains how to view or delete the picture images including how to view images in thumbnail view on the LCD monitor.

7. Using the Software

Explains the editing software provided for your SAMSUNG digital camera.

8. How to Make a Photo Print

Explains how to make a photo print.

9. Appendix

Explains troubleshooting and introduces the special terms used in this user guide.

Memo

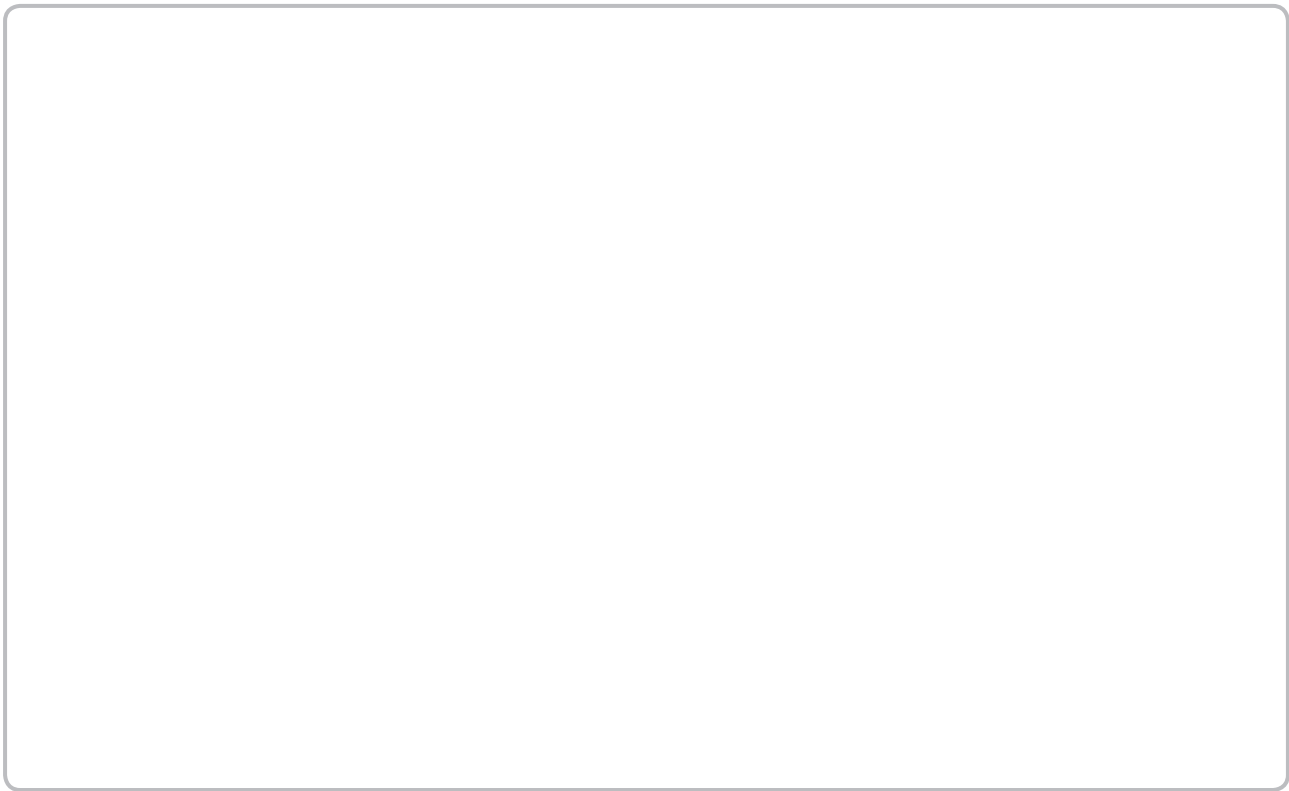
A large, empty rectangular box with rounded corners, intended for writing the memo content. The box is outlined in a thin gray border and occupies the majority of the page below the header.

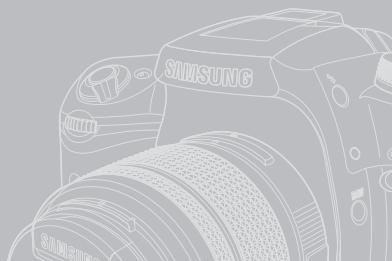

GX20

Before Starting to Take a Picture

Explains camera characteristics, accessories and the names of various parts.

012 Checking the Contents of the Package

012 What are included in the package

013 Names of Working Parts

013 Front & Top

014 Rear

015 Quick reference guide

016 Charging and Inserting the Battery

016 Charging the Battery

017 Inserting the Battery

018 Battery Level Indicator

018 Approximate Playback Time (Fully charged battery)

019 Inserting the Memory Card

020 Precautions When Using the Memory Card

021 Turning the Camera On and Off

021 Using the Vertical Battery Grip (SBG-D1V) (Sold Separately)

022 Setting the Language and Date Information

Checking the Contents of the Package

Please check that you have the correct contents before using this product. The contents can vary depending on the sales region. To buy the optional equipment, contact your nearest Samsung dealer or Samsung service centre.

What are included in the package



Hot shoe cover
(Installed on camera)



Eyecup
(Installed on camera)



Viewfinder cap



Body mount cover
(Installed on camera)



USB cable

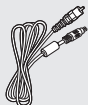

Video cable



Software (CD-ROM)
(AD46-00159A)



Strap



Rechargeable battery
(SLB-1674)

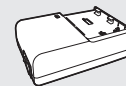

Charger (SBC-L6)



AC cord



User's Manual (AD68-01904A)
Quick Guide (AD68-02661A)

Names of Working Parts

Front & Top

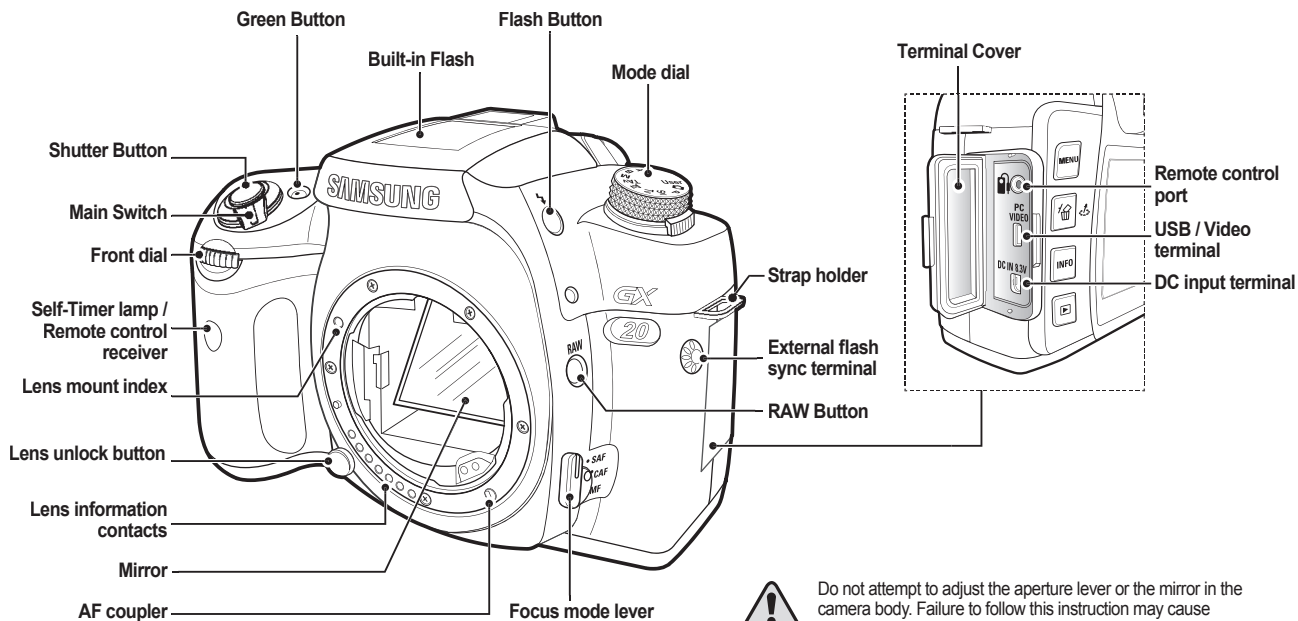

Names of Working Parts

Rear

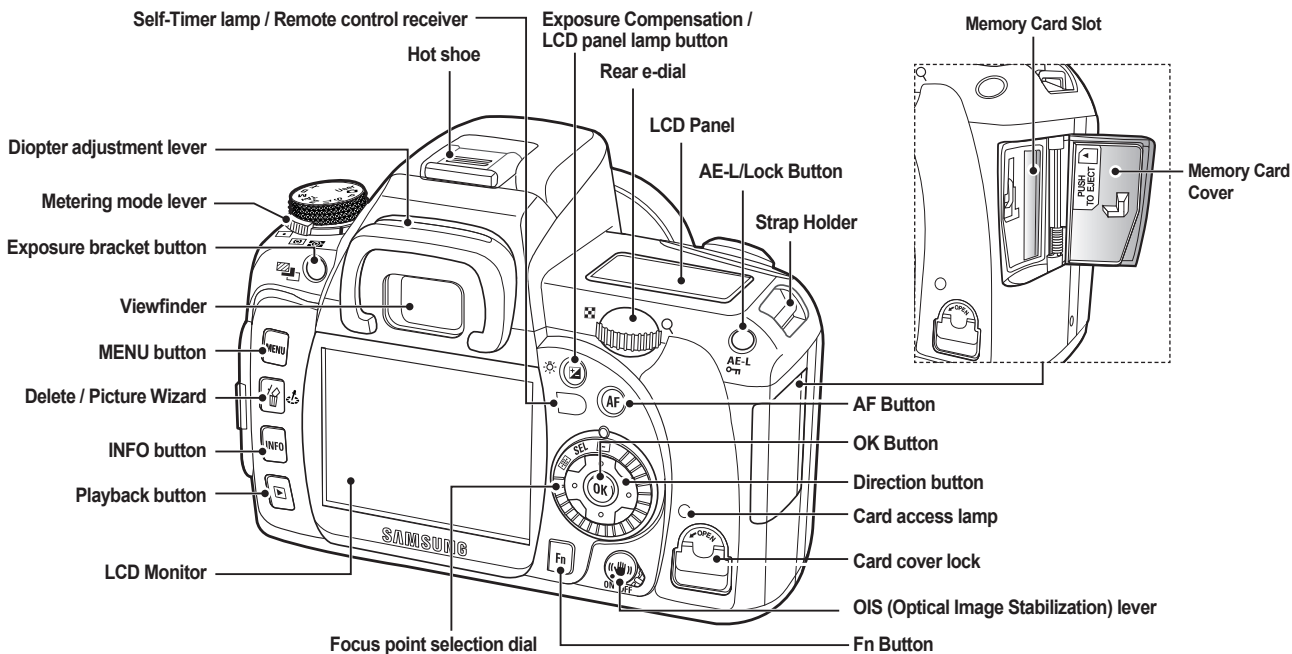

Names of Working Parts

Quick reference guide

Front

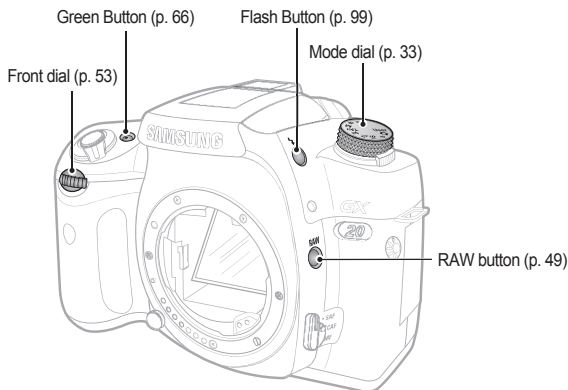

Mode dial

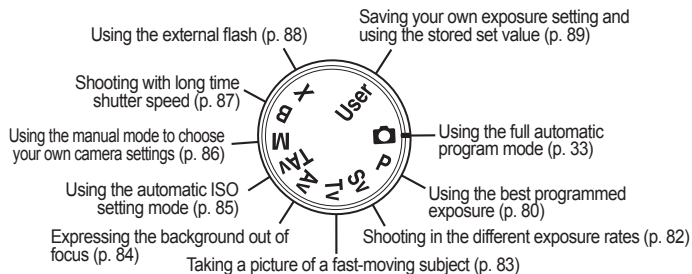

Rear

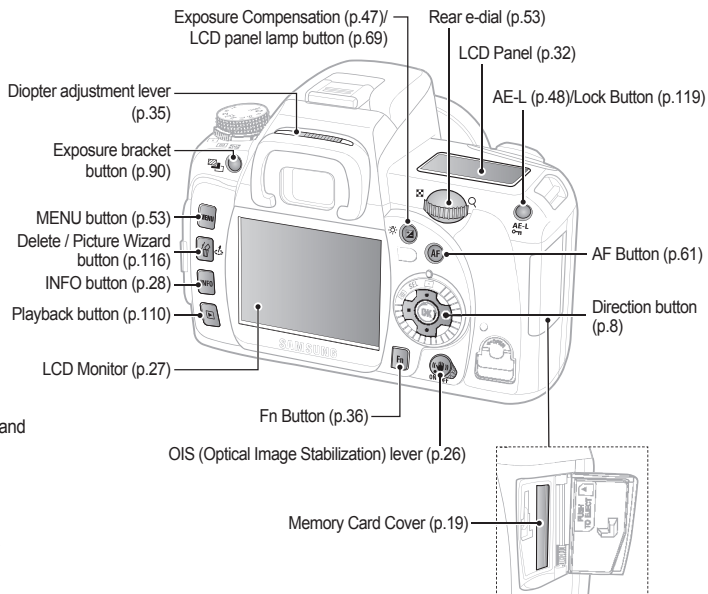

Charging and Inserting the Battery

Charging the Battery

1. Insert the supplied AC cord to the power outlet and DC input port of the charger.

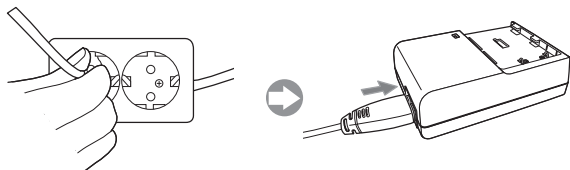

2. Put the battery on the charger as shown.

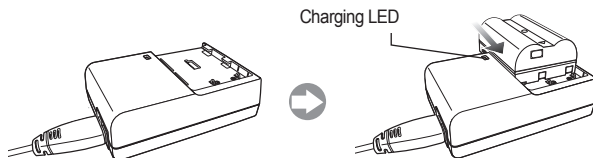

- If the charging LED of the AC Charger does not turn on or blink after inserting the rechargeable battery, please check whether the battery is inserted correctly.
- You must check the battery charging status with the Charging LED.

Charging LED	Status
Being Charged	Red LED is on
Charging is complete	The LED is off
Charging error	Red LED is blinking

- Proper operating temperatures of the Charger are 0°C ~ 40°C. The battery may not be charged under or over the operating temperature (Red LED is blinking). This is not the camera malfunction.
- The period of quality guarantee of charger is 1 year and Lithium ion rechargeable battery is 6 months.

Charger (SBC-L6)

Rated input	AC100~240V (50Hz~60Hz)
Rated output	DC 8.4 V / 700 mA
Dimensions	60 X 90 X 30.2 mm
Weight	86 g

- A Lithium ion battery is expendable. If the working duration of a fully charged battery decreases sharply, purchase a new one.

Charging and Inserting the Battery

Inserting the Battery

1. Rotate the Battery cover unlock lever as shown in the illustration and open the cover.

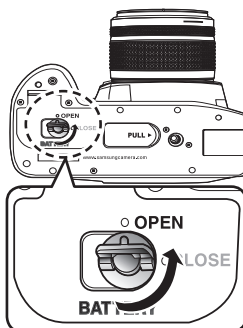

2. Insert the battery as shown on the picture.

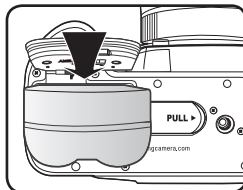

Battery lock lever

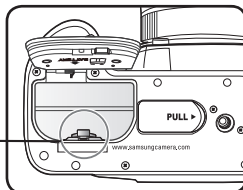

3. Close the Battery cover and rotate the battery cover lock lever as shown.

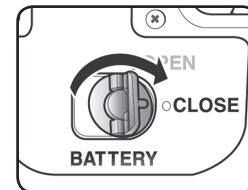





- Use the specified battery. Problems caused by using the other battery are not covered by the Samsung warranty.
- Do not open the battery cover or remove the batteries while the power is on.
- Remove the batteries when you will not use the camera for a long while. The batteries may leak.
- If the date and time settings have been reset when you insert new batteries after a long while, set date and time information by using the [Date/Time] menu in the [SETUP MENU].
- Insert batteries correctly. Batteries inserted incorrectly may cause a camera breakdown. Wipe the electrodes of the batteries before inserting.
- When the battery is removed, turn off the camera first or the stored data may be deleted.

Charging and Inserting the Battery

Battery Level Indicator

You can confirm remaining battery level by checking the  displayed on the LCD panel.

			
lit	lit	lit	blink
Battery is full.	Battery is running low.	Battery is almost empty.	The camera turns off after displaying a message.



- Battery performance temporarily decreases while being used in cold conditions. When using the camera in cold climates, have extra batteries on hand and keep them warm in your pocket. Battery performance will return to normal when returned to room temperature.
- Have extra batteries ready when travelling overseas, taking pictures in cold climates, or when you will be taking a lot of pictures.
- An AC Power Adapter (SAC-82, sold separately) is available to use while you use the LCD monitor for a long time or connect your camera to a PC.
- The life time of the battery may differ depending on the focal length of the lens mounted in the camera body.

Lifetime of the battery (Fully charged battery)

Battery	Operating Temperature	Normal recording	Flash photography	
			50% use	100% use
SLB-1674	23°C	Approx. 500 Min./1,000	Approx. 430 Min./860	Approx. 400 Min./800

These figures are measured under Samsung's standard conditions and shooting conditions and may vary depending on the user's methods.

Inserting the Memory Card

- SD / SDHC memory card and Multi Media Card can be used with this camera.
- Captured images are recorded on the Memory Card. Make sure the camera is turned off before inserting or removing the Memory Card.

1. Lift up the Card Cover Lock as shown (①) and rotate it to the **OPEN** position (②) (Card cover opens (③)).

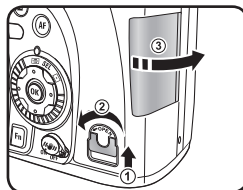

2. Have the front of the memory card facing toward the LCD monitor and insert the memory card.
- Press the memory card one more time to remove it out of the memory card slot.

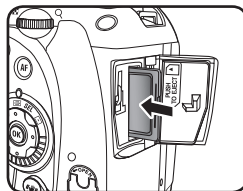

3. Close the Card cover.

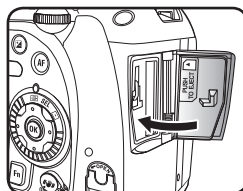

- Do not remove the Memory Card while card access lamp is lit.
- Always format new Memory Cards before use. Also format Memory Cards used with other cameras.
- If the memory card cover is left open, the power will not turn on.
- Make sure the memory card is correctly positioned before inserting it into the camera.

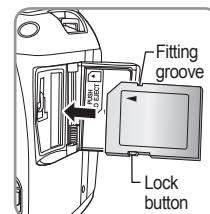

Inserting the Memory Card

Precautions When Using the Memory Card

- The Memory Card (SD/SDHC CARD) is equipped with a write-protect switch. Setting the switch to **LOCK** protects the existing data by preventing the recording of new data, deletion of existing data or formatting of the card.
- Care should be taken when removing the Memory Card immediately after using the camera because the card may be hot.
- Do not remove the Memory Card or turn the camera off while data is being saved to the card, images are being played back, or the camera is connected to a computer with the USB cable. This may cause the data to be lost or the card to be damaged.
- Do not bend the Memory Card or subject it to violent impact. Keep it away from water and store away from high temperatures.
- Do not remove the Memory Card during formatting. The card may be damaged beyond use.
- Data on the Memory Card may be deleted in the following circumstances. Samsung Camera does not accept any liability for data that is deleted if
 - (1) The Memory Card is mishandled by the user.
 - (2) The Memory Card is exposed to static electricity or electrical interference.
 - (3) The card has not been used for a long time.
 - (4) The card is ejected or the battery is removed while the data on the card is being recorded or accessed.
- The Memory Card has a limited service life. If it is not used for a long time, the data on the card may become unreadable. Be sure to regularly make a backup of important data on a computer.

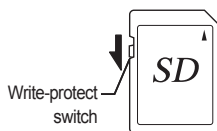

- Avoid using or storing the card where it may be exposed to static electricity or electrical interference.
- Avoid using or storing the card in direct sunlight or where it may be exposed to rapid changes in temperature or to condensation.
- For information on compatible Memory Cards, visit the Samsung Camera website or contact your nearest Samsung Camera customer service centre.
- Always format new Memory Cards. Also format Memory Cards used with other cameras.
- When you format the memory card, the capacity of the memory card may appear less than it is written in the product label.

Turning the Camera On and Off

1. Move the main switch to the **ON** position.

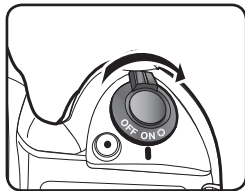

2. The LCD panel and the monitor are turned on. Now you can take a picture using the camera.



- Always turn the camera off when not in use.
- The power will automatically turn off when you do not perform any operations within a set period of time. (Default setting is 1 minute) You can change the setting on the [Auto Power Off] menu of the [SETUP MENU] menu. To turn on the camera again, rotate the main switch or refer to the followings.
 - Press the shutter button halfway down.
 - Press the playback button (▶).
 - Press the **INFO** button.

Using the Vertical Battery Grip (SBG-D1V) (Sold Separately)

Using the battery grip gives you a more comfortable position while shooting with a vertical angle of view.

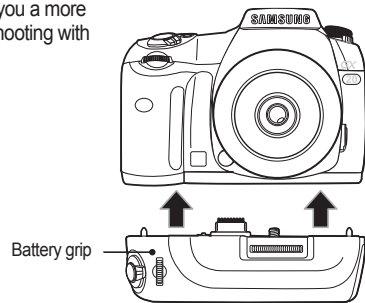

▲ Installing the battery grip

Battery grip supports the green button (⊙) function while you can still adjust the exposure using the battery grip.



▲ Vertical position when using the battery grip



For more detailed information about the battery grip, please refer to the battery grip owner's manual.

Setting the Language and Date Information

The first time the camera is turned on after purchasing, the [INITIAL SETTINGS] screen appears on the LCD monitor. Follow the procedure below to set the language displayed on the LCD monitor and the current date and time. Once setting is done, these will not need to be set again when turning your camera on.

1. The following screen appears when you turn on the camera for the first time.

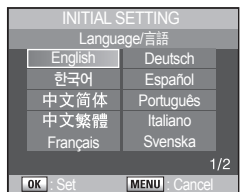

2. Select the language you want to use using the direction buttons (◀▶) on your camera, and then press the **OK** button
 - English, Korean, Chinese (traditional / simplified), French, German, Spanish, Portuguese, Italian, Swedish, Dutch, Danish, and Russian.

3. The current date and time can be set on the following screen.

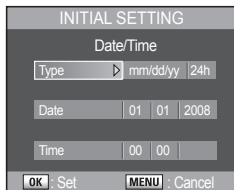

4. Select [Type], [Date], and [Time] for the display by pressing the direction buttons (◀▶).

5. Press the **OK** button to save.



If the date and time information is already set and you want to make a change, set date and time information by using the [Date/Time] menu in the [SETUP MENU].

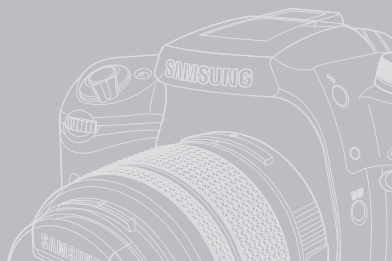

GX20

Starting Basic Shooting (Auto mode)

This chapter gives a quick guide lines for the first time users to take a picture using the basic shooting mode. (Auto mode.)

- 024** Attaching and removing the lens
- 025** Correct methods of holding the camera
- 026** OIS (Optical Image Stabilization)
 - 026 Turning On the OIS Function
 - 026 Optical Image Stabilization
- 027** LCD Monitor Indications
 - 027 While Power is On or Operating Mode Dial
 - 028 Capture Mode
 - 029 Playback Mode
 - 030 Histogram Display
- 031** Viewfinder Indications
 - 031 Capture Mode
- 032** LCD Panel Indications
- 033** Using the full automatic program mode
 - 034 Operating the shutter release button
 - 034 Hard-to-Autofocus Subjects
 - 035 Adjusting the Viewfinder to Your Eyesight
 - 035 Using the Zoom ring
 - 036 Using the Drive Mode

Attaching and removing the lens

For additional use of lenses, please check lenses available to be used at Customer Service. Some functions are restricted when lenses are not set to Aperture A (Auto). To allow shutter release, set **[Use Aperture Ring]** in **[CUSTOM2 MENU]** menu.



Turn the camera off before attaching or removing the lens to prevent unexpected lens problems.

1. Check that the camera is off.
2. Remove the body mount cover (①) and lens mount cover (②). Be sure to put the lens down with the lens mount side facing upward to avoid damage.

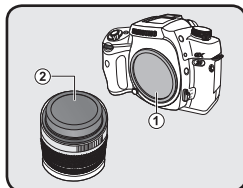

3. Align the red dots on the camera and the lens, and secure by turning the lens clockwise until it clicks. After attaching, check that the red dots of the lens are on top and the attached portion does not move sideways.

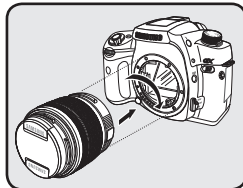
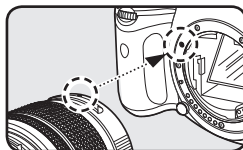

4. Remove the front lens cap by pushing the indicated portions inward.

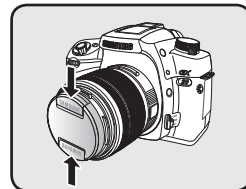

5. To detach the lens, hold down the lens unlock button (③) and turn the lens counterclockwise.

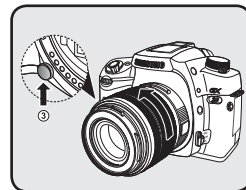

- The body mount cover (①) is a cover to prevent damage during shipping.
- We assume no responsibility nor liability for accidents, damages and malfunctions resulting from the use of lenses made by other manufacturers.
- The camera body and lens mount incorporate lens information contacts and an AF coupler. Dirt, dust, or corrosion may damage the electrical system. Clean the contacts with a soft dry cloth.



Attaching and removing the lens must be done in a clean place. Please avoid contact with liquid water. If the camera's body or the lens gets wet or dirty, camera malfunction may occur.

Correct methods of holding the camera

How you hold the camera is important when taking pictures.

- Use your both hands while taking a picture to prevent from the camera shake. Try to avoid any slight movement while shooting.



▲ Horizontal position



▲ Vertical position



- To reduce camera shake, support your body or the camera on a solid object such as a table, tree, or wall.
- Although there are individual differences among photographers, the slowest recommended shutter speed for a handheld camera is generally $1/(\text{focal length} \times 1.5)$. For example, it is $1/75$ of a second for a focal length of 50mm and $1/150$ of a second for 100mm. A tripod or OIS (👉) function should be used for shutter speeds slower than this.
- When using the tripod, do not use the OIS (👉) function as the image may be blurred due to the oscillation of the OIS sensor.
- To reduce the camera shake while using a telephoto lens, use the tripod that is heavier than the total weight of the camera and the lens.

OIS (Optical Image Stabilization)

Turning On the OIS Function

Turn on the **OIS** switch. When the shutter release button is pressed halfway, (👉) appears in the viewfinder and the OIS function turns on.

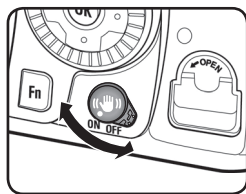

Optical Image Stabilization

The OIS function reduces camera shake that occurs when the shutter release button is pressed. This is useful for taking pictures in situations where camera shake is likely to occur. The OIS function allows you to take pictures at approximately 2 to 3.5 steps slower shutter speed without the risk of the camera shake. The OIS function is ideal when taking pictures in the following situations.

- When taking pictures in dimly lit locations, such as indoors, at night, on cloudy days and in the shade
- When taking telephoto pictures

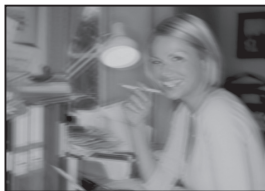

▲ Blurred picture



▲ Picture taken with the OIS function



- The OIS function does not compensate for blurring caused by movement of the subject. To take pictures of a moving subject, increase the shutter speed.
- The OIS function may not fully reduce camera shake when taking close-up shots. In this case, it is recommended that the OIS function be turned off and the camera be used with a tripod.
- The OIS function will not fully work when shooting with a slower shutter speed, for example when shooting a moving subject or night scenes. In this case, it is recommended that the OIS function be turned off and the camera be used with a tripod.
- Turn the OIS switch off if you will not be using the OIS function.
- The OIS function will not fully work (for about 2 seconds) right after turning on the camera or restoring from Auto Power Off. Wait for the OIS function to become stable before gently pressing the shutter release button to take a picture. Press the shutter release button halfway. The camera is ready to take pictures when icon appears in the viewfinder.
- Be sure to turn off the OIS switch when using the camera with a tripod.
- The OIS function automatically turns off in the following situations. When using self-timer, remote control shooting, bulb shooting, or wireless mode with an external flash.
- For more information about OIS(Optical Image Stabilization), see page 59.

LCD Monitor Indications

The following indicators appear on the LCD monitor depending on the status of the camera.

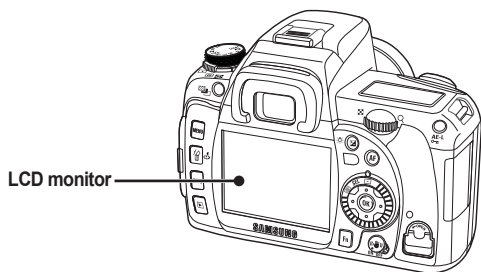

While Power is On or Operating Mode Dial

Guides appear on the LCD monitor for 3 seconds when powered on or setting dial mode (🕒).



You can set the specific time the guides will appear on the LCD monitor for. Select the desired time from [SETUP MENU] > [Guide Display].

Detailed Information

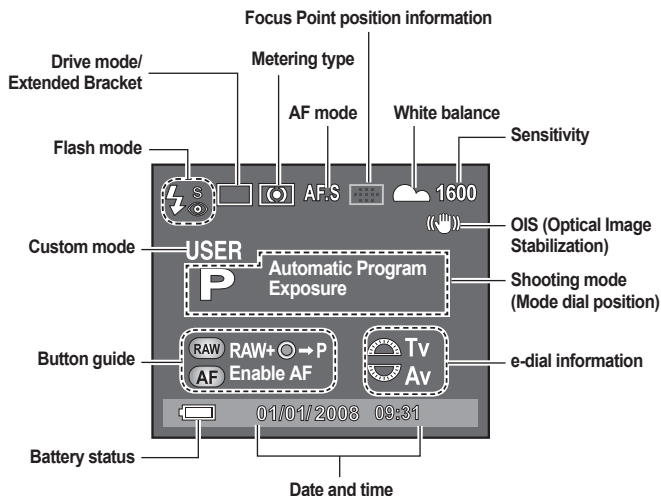

Indicators [Metering type], [Focus Point Information], [White balance], and [Sensitivity] only appear when a setting other than the default setting is selected.

LCD Monitor Indications

Capture Mode

Press the **INFO** button in capture mode to display the capture function settings on the LCD monitor.

Detailed Information

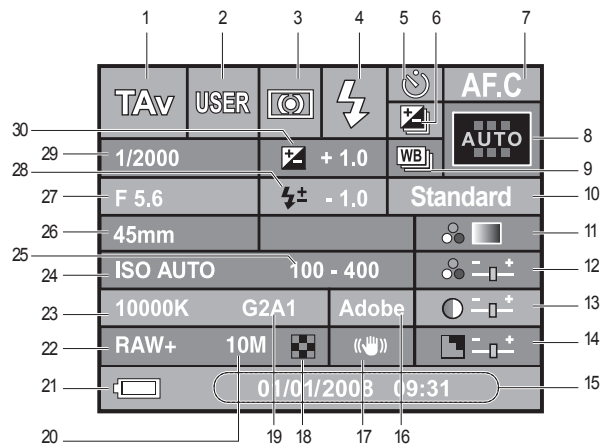

1. Shooting mode
2. Custom mode
3. Metering mode
4. Flash mode
5. Drive mode
6. Exposure Bracket / Multi Exposure
7. AF mode
8. Focus point location
9. Extended Bracket
10. Picture Wizard mode
11. Colour Tone
12. Saturation
13. Contrast
14. Sharpness
15. Date and time
16. Colour space
17. OIS (Optical Image Stabilization)
18. Quality level
19. BA compensation value (GM) / BA compensation value (BA)
20. Recorded pixels
21. Battery Status
22. File type
23. White balance
24. ISO sensitivity
25. ISO range (Auto)
26. Lens focal length
27. Aperture Value
28. Flash Exposure Value
29. Shutter Speed
30. Exposure Compensation Value

LCD Monitor Indications

Playback Mode

Press the **INFO** button in playback mode to display the image information on the LCD monitor. Whenever pressing the **INFO** button, Basic information, Histogram, Detail information and no information will display in that order.

Detailed Information

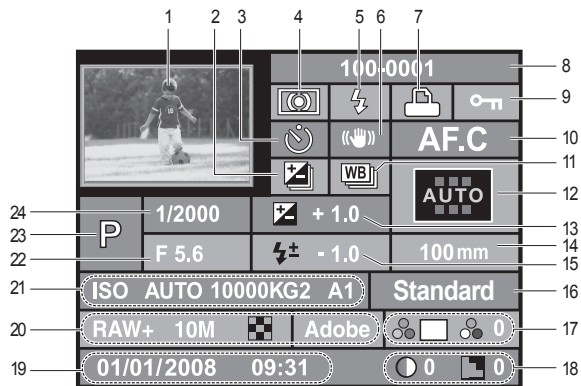

1. Captured images
2. Exposure Bracket / Multi Exposure
3. Drive mode
4. Metering mode
5. Flash mode
6. OIS (Optical Image Stabilization)
7. DPOF settings
8. Folder name and Stored image number
9. Protect icon
10. AF mode
11. Extended Bracket
12. Focus point information
13. Exposure Compensation Value
14. Lens focal length
15. Flash Compensation Value
16. Picture Wizard mode
17. Colour Tone/Saturation
18. Contrast/Sharpness
19. Date & Time
20. File type / Image size / Quality / Colour Space
21. Sensitivity / White Balance / WB compensation (GM) / WB compensation (BA)
22. Aperture Value
23. Shooting mode
24. Shutter Speed



Indicators **5** (Flash mode) and **15** (Flash compensation Value) only appear when the image was taken with flash.



You can change the information initially displayed by pressing the playback button (▶).

LCD Monitor Indications

Histogram Display

Brightness Histogram that distributes brightness of the image and RGB Histogram that distributes colour of the image are selectable by pressing the direction buttons (▲▼).

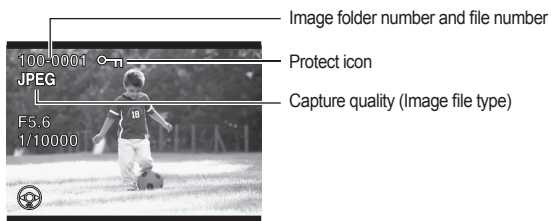

▲ Playback

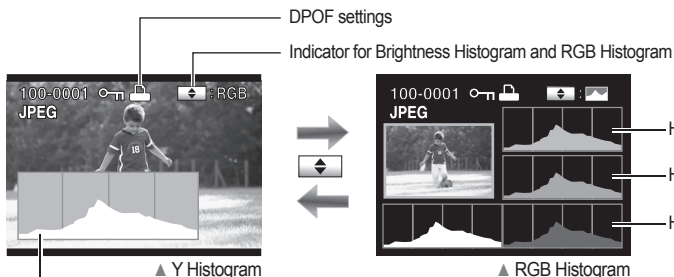

Histogram (Brightness)

▲ RGB Histogram



- DPOF icon (📄) will display only when an DPOF set image is played back.
- Image-protect icon (🔒) appears only when the image is protected from deletion.
- If [Exposure Warning] is set to [On] in the [PLAYBACK MENU], the over exposed area in the playback image blinks in red while the under exposed area blinks in yellow.
- Histogram shows you the distribution of brightness in recorded images. If the bars in the histogram are higher towards the right, the image may be too bright. If the bars are higher on the left, the image may be too dark. If the lighting conditions are too bright to check the subject by using the LCD, checking the histogram will enable more precise exposure control for the shots.

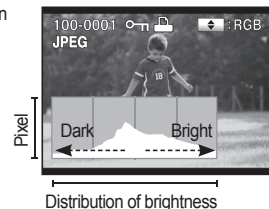

Viewfinder Indications

Capture Mode

When the power is turned on, the current setting values appears in the viewfinder as soon as you press the shutter button halfway.

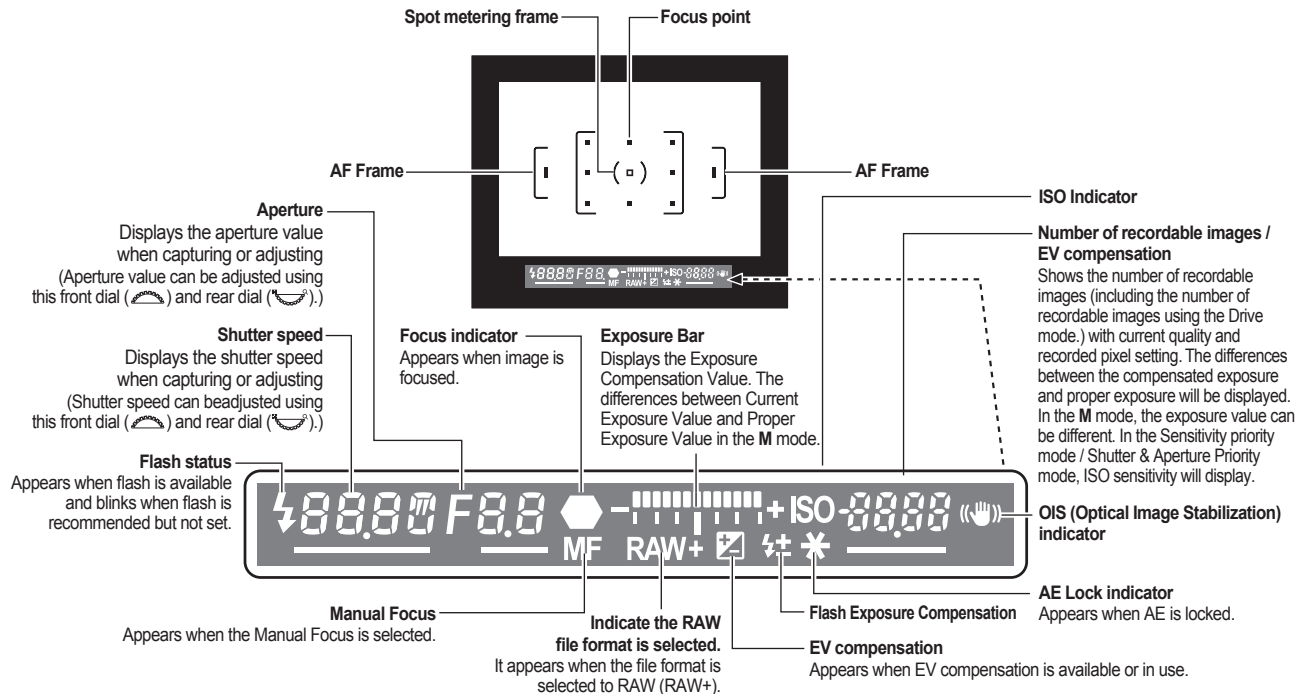

LCD Panel Indications

The following information appears in the LCD panel on top of the camera.

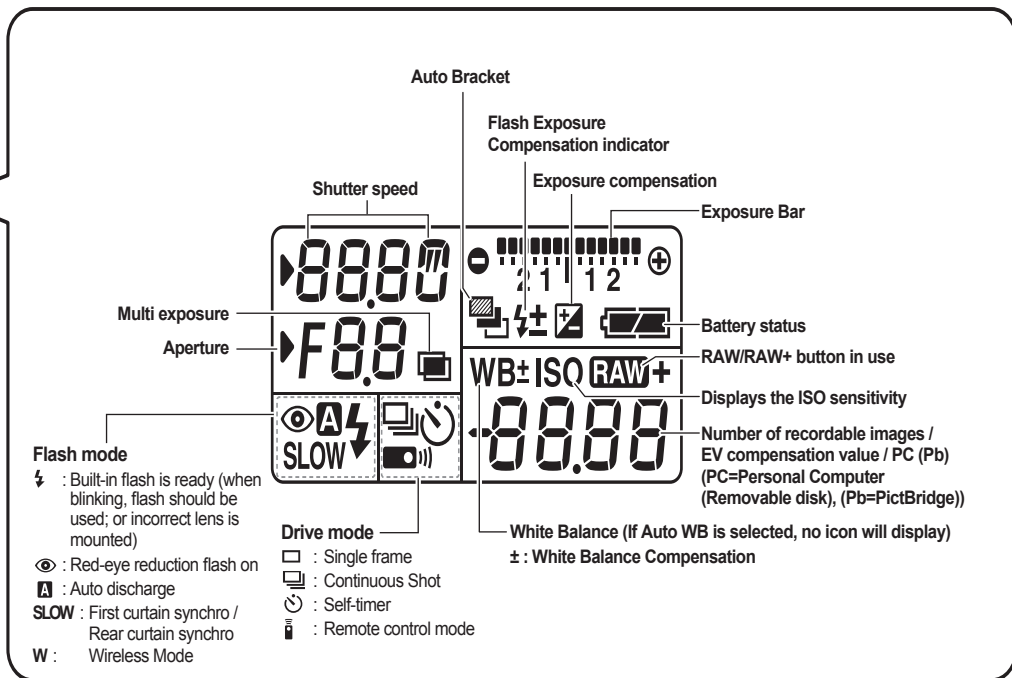
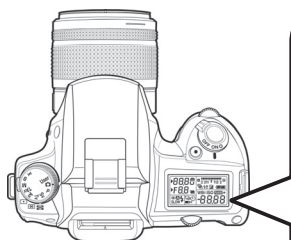

Using the full automatic program mode

Auto mode helps users take a picture in very easy steps with correct exposure and auto focusing. Auto mode is designed for those who are using a DSLR (Digital Single Lens reflex) camera for the first time.

1. Set the mode dial (📷) to Auto mode (📷).

- The camera will select the optimal capturing mode for the subject.

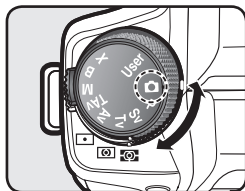

2. Set the focus mode lever to **SAF**.

- In the SAF mode, the shutter can be released only when the image is focused.

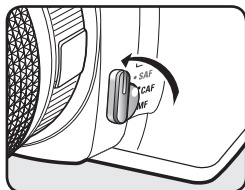

3. Look through the viewfinder to view the subject. A zoom lens can be used to change the size of the subject in the viewfinder.

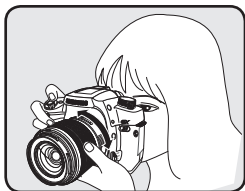

4. Position the subject inside the autofocus frame and press the shutter release button halfway.
- The autofocus system operates. The focus indicator (●) appears in the viewfinder with the beep sound as soon as the subject is in the focus.

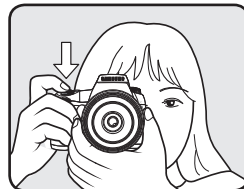

AF(Auto Focusing) Frame

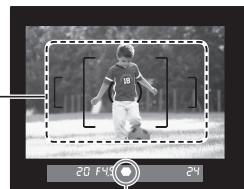

Focus indicator



- When you find that auto focusing is not available, set the focus mode lever to **MF** and then you can adjust the focus manually.
- The flash doesn't pop up. To pop up the flash manually, press the flash pop up flash button (📷).

5. Press the shutter release button fully.
- The picture is taken.

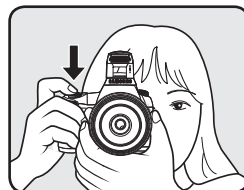

Using the full automatic program mode

6. Review captured images on the LCD monitor.
- Image appears for 1 second on the LCD monitor after capturing (Instant Review.) You can delete the image during Instant Review by pressing the delete button (🗑️). If you press the playback button (▶️), captured images appear again on the LCD monitor.



Hard-to-Autofocus Subjects

The autofocus mechanism is not always precisely accurate. Focusing may be difficult when taking pictures under the following conditions (① to ⑥ below). These also apply to manual focusing using the focus indicator (●) in the viewfinder. If the subject cannot be focused automatically, set the focus mode lever to MF and use the manual focus mode to focus on the subject with the aid of the matte field in the viewfinder.

- ① Extremely low-contrast subjects such as a white wall in the focus points range.
- ② Subjects which do not reflect much light within the focus points range.
- ③ Fast moving objects.
- ④ Strongly reflected light or strong backlighting (bright background).
- ⑤ If vertical or horizontal line patterns appear within the focus points range.
- ⑥ Multiple subjects in the foreground and background within the focus points range.



Subject may not be focused even when focus indicator (●) is displayed when ⑥ above applies.

Operating the shutter release button

The shutter release button has two positions.

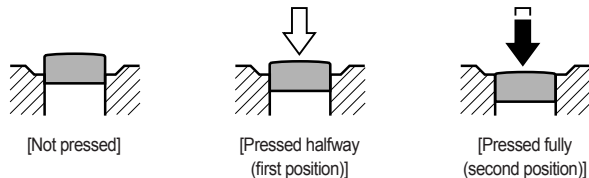

Pressing the shutter release button down halfway (first position) turns on the viewfinder and LCD panel indicators and the autofocus system operates. Pressing it down fully (second position) takes the picture.



- Squeeze the shutter release button gently when taking a picture to prevent camera shake.
- Practice pressing the shutter release button halfway to learn where the first position is.
- The viewfinder indicators stay on while shutter release button is pressed. The indications stay on for about 10 seconds (default setting) after the button is released.

Using the full automatic program mode

Adjusting the Viewfinder to Your Eyesight

Adjust the viewfinder to suit your eyesight. If it is difficult to see the viewfinder image clearly, slide the diopter adjustment lever sideways. You can slide the diopter from -2.5 m-1 to +1.5 m-1.

1. Aim the AF point over the subject, and then press the shutter button halfway.
2. Adjust the diopter adjustment lever to suit your eyesight.
- Viewfinder is adjusted to your eyesight.

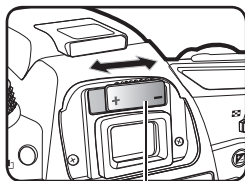

Diopter adjustment lever



AF Frame



The eyecup is attached to the viewfinder portion when camera leaves the factory. Diopter adjustment is available with the eyecup attached. However, adjustment is easier with the eyecup removed as shown above. To remove the eyecup, pull upward and remove as shown on the right.

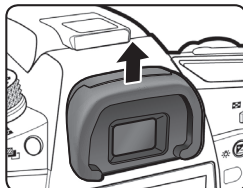

Using the Zoom ring

Using the zoom ring, you can enlarge (telephoto angle) or reduce (wide angle) the size of an image by changing the focal length value of the camera lens. Adjust it to the desired size and take the picture.

1. Position the subject in focus.
2. Turn the zoom ring to the right or left.
- Turn the zoom ring clockwise for telephoto and counterclockwise for wide angle.

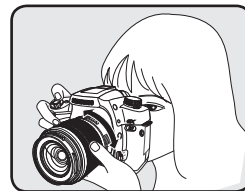

- Look through the viewfinder to compose your picture at the focal length that looks right for your purpose. Turn the zoom ring right or left until you see the composition you want.
- A fixed focal length lens do not includes the zoom ring.



▲ Wide Angle



▲ Telephoto

Using the full automatic program mode

Using the Drive Mode

You can select the continuous shooting or self-timer function using the DRIVE mode. This chapter explains the **[Continuous Shooting (Hi)]** mode for example.

1. Press the **Fn** button on your camera and then press the direction button (**▲**).
 - The Drive Mode options screen appears.
 - If the AF mode is not set to **SEL**, you can directly press the direction buttons (**▲**) to use the drive mode.

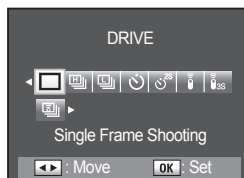

2. Select the **[Continuous Shooting (Hi)]** using the direction buttons (**◀▶**) and then press the **OK** button.
 - The camera is ready to take pictures.

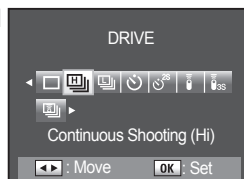

3. Continuous shooting starts as soon as you press and hold the shutter button.



- If you set **[Remaining Count]** to **[Continuous]** from the **[Custom2 MENU]**, the maximum continuous-shootable images appears in the view finder on half shutter.
- The focus is adjusted each time the shutter is released while exposure metering timer is set (shutter release button is pressed halfway) if the focus mode is set to **SAF** (Single mode).
- Focusing is continuously active when the focus mode is set to **CAF** (Continuous mode).
- Note that in **CAF** (Continuous mode) / **MF** (Manual mode), the shutter will release when the shutter release button is pressed fully even if focusing is not complete.
- The shutter cannot be released until charging is complete when using the built-in flash.
- To take a picture while charging the built-in flash, set **[Release in Charging]** to **[On]** in the **[CUSTOM2 MENU]**.

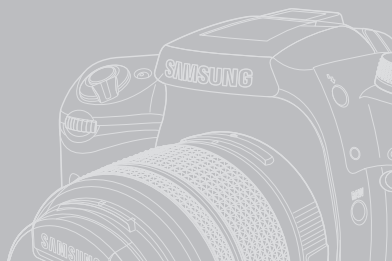

GX20

Getting a Better Picture by Using More Functions

This chapter helps users archive a better picture by learning how to get a camera's angle of view, exposure, focusing the object, and so on.

038 Checking the Composition, Exposure, and Focus Before Shooting

- 038 Displaying the Digital Preview
- 038 Using the Liveview function
- 039 Manual White Balance (Manual W.B.)

040 Checking the focus

- 040 Using Autofocus
- 041 Selecting the Focusing Area (AF Point)
- 041 Setting the Focus Position in the Viewfinder
- 042 Fixing the Focus
- 043 Adjusting the Focus Manually (Manual Focus)
- 043 Using the Focus Indicator
- 044 Using the Viewfinder Matte Field

045 Setting the Exposure

- 045 Effect of Shutter Speed and Effect of Aperture
- 046 How to Check Depth of Field
- 047 Selecting the Metering Method
- 047 Exposure Compensation
- 048 AE-L with AF Locked

049 Using the RAW button

050 Using the Mirror Lock Up Function

051 Self-Timer Shooting

052 Remote Control Shooting (Sold Separately)

053 Using the Menu





- 053 Using the MENU button
- 054 Using the CAPTURE MENU
- 060 Using the CUSTOM1 MENU
- 066 Using the CUSTOM2 MENU
- 070 Using the SETUP MENU
- 077 Using the PLAYBACK MENU

Checking the Composition, Exposure, and Focus Before Shooting

Displaying the Digital Preview

Using the main switch on your camera, you can check the composition, exposure in the LCD monitor, and focus before you actually take a picture.

To use the digital preview function, select **[Custom2 MENU] > [Preview Method] > [Digital]**.

1. Focus on the subject, then compose the picture in the viewfinder and move the main switch to .
2. The icon  appears in the LCD monitor during preview and you can check the composition, exposure and focus. Press the shutter release button halfway to end Digital Preview and start focusing. To save images, press the **Fn** button and then select **[Save as]**.
3. In the digital preview mode, the image can be enlarged by using the rear dial . You can check the composition, exposure and focus with the direction buttons  on the LCD monitor.

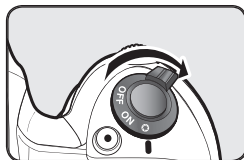

- You can display the Bright/Dark area warning or histogram in Digital Preview. Set in **[Digital Preview]** in the **[PLAYBACK MENU]** menu.
- For more information about the depth of field, see page 46, "Depth of field".

Using the Liveview function

You can actually see the composition of your subject and the focus through the LCD monitor in real time.

To use the Liveview function, select **[Custom2 MENU] > [Preview Method] > [Liveview]**.

1. Focus on the subject, then compose the picture in the viewfinder and move the main switch to .
2. The LCD monitor displays the composition of your subject and the focus in real time. The LCD monitor displays the shooting information of the camera when using the Liveview function.
3. Press and hold the **AF** button until the subject is in focus.
 - If the focus mode lever is set to **SAF**, you can see the subject in focus on the LCD monitor.
 - If the focus mode lever is set to **CAF**, the LCD monitor does not display the subject while you are pressing and holding the **AF** button. After you stop pressing and holding the **AF** button, you can see the subject in focus by using the LCD monitor.
 - If the focus mode lever is set to **MF**, you can manually adjust the focus by watching through the LCD monitor.
4. Now you can take a picture.

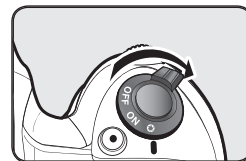

- **[Display Time]** in the **[Quick View]** menu is fixed to **[1 sec]** while the Liveview function is used.
- You can not delete the images while using the quick view function in the Liveview menu.

Checking the Composition, Exposure, and Focus Before Shooting



- Selected image in the live view screen is enlarged if you turn the rear dial (☺) to the right.
- You can choose the [Grid Display] and [AF Frame Display] options by setting the [Liveview] menu in the [CAPTURE MENU].
- While using the Liveview function, adjusting the focus is available for some lenses when auto focusing mode is set to MF.
- The preview image in the [Liveview] function disappears in about 3 minutes.
- Use a tripod to prevent camera shake while using the Liveview function.
- You can not adjust the aperture stops while using the Liveview.
- You may find the actual image is different after taking a picture.



When using the Liveview function, do not aim the camera toward the sun. Direct sun light may damage the shutter curtain.

Manual White Balance (Manual W.B.)

Using the Manual White Balance, you can easily adjust the white balance before shooting. The white balance preview is very helpful when you are taking pictures under various environmental lighting conditions.

To use the white balance preview function, select [Custom2 MENU] > [Preview Method] > [Manual White Balance].

1. Focus on the subject, then compose the picture in the viewfinder and move the main switch to ☺.

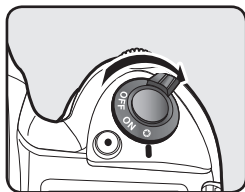

2. Turn the rear dial (☺) to switch the screen in the LCD monitor. The following screen appears.



3. Select the white balance point using the direction buttons (☞☛) on your camera.
- Set the white balance point to the white area in the LCD monitor.

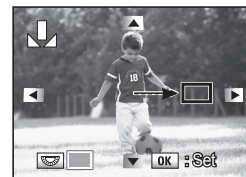

4. Press the OK button.
- The following screen appears to adjust the white balance.

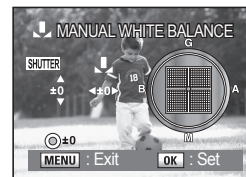

5. Set the white balance value using the direction buttons (☞☛) and then press the OK button.
- Now you can take a picture with the white balance value saved on your camera.

Checking the focus

You can focus with the following methods.

- **AF** (Auto Focus) : The camera is focused when the shutter release button is pressed halfway.
- **MF** (Manual Focus) : Manually adjust the focus.

Using Autofocus

You can choose the autofocus mode from **SAF** (Single mode) where the shutter release button is pressed halfway to focus on the subject and the focus is locked at that position, and **CAF** (Continuous mode) where the subject is kept in focus by continuous adjustment while the shutter release button is pressed halfway.

1. Set the focus mode lever to **SAF** or **CAF**.

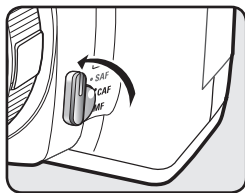

2. Look through the viewfinder and press the shutter release button halfway.

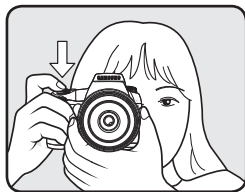

The focus indicator (●) appears in the viewfinder when focused (if focus indicator (●) is blinking, the subject is not in focus).



Focus indicator





- The camera can be focused by pressing the **AF** button.
- In **SAF** (Single mode), the focus is locked (focus lock) while focus indicator (●) is lit. To focus on another subject, take your finger off the shutter release button first.
- In **CAF** (Continuous mode), focus is adjusted continuously, tracking the moving object as long as the shutter release button is kept pressed halfway.
- The shutter cannot be released until the subject is in focus in **SAF** (Single mode). If the subject is too close to the camera, move back and take the picture. Adjust the focus manually if the subject is difficult to focus.
- If you try to focus on your subject in a too dark place, multiple flash fires simultaneously on half shutter. (You need to pop up the built-in flash and set the auto focusing mode to **SAF** (Single mode) before shooting.)
- Use the matte field in the viewfinder when the subject is difficult to focus and the focus indicator will not stay lit.

Checking the focus

Selecting the Focusing Area (AF Point)

Choose the part of the viewfinder to set focus to.
The selected AF point appears red in the viewfinder. (Superimpose AF Area).

 Auto	The camera selects the optimum AF point even if the subject is not centered.
SEL Select	Sets the AF point to one of the eleven points in the AF area.
 Centre	Sets the AF point to the centre of the viewfinder.

1. Set the desired program mode using the Focus point selection dial.

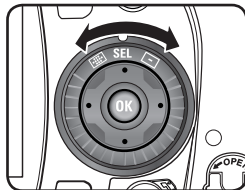

AF point is not displayed in the viewfinder when **[Off]** is selected for **[Superimpose AF Area]** in the **[CUSTOM1 MENU]** menu.

Setting the Focus Position in the Viewfinder

1. Select **SEL** with the Focus point selection dial.
- Auto focusing mode must be set to **SEL**, to move the AF point where you want to focus.

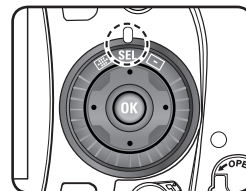

2. Look through the viewfinder and check the position of the subject.



3. Place the AF (Auto Focusing) point where you want to focus using the direction buttons () on your camera.
- The AF point appears red in the viewfinder (Superimpose AF Area) and you can check where you set the AF point.



AF point appears in the centre as soon as you press the **AF** button while the AF point mode is set to Centre ()

Checking the focus

Fixing the Focus

If your subject is outside the Focusing Area (AF Point), first focus the subject in the Focusing Area (AF Point) and then make a change to the composition.

1. Frame the desired composition for your picture in the viewfinder.



2. Centre the subject to focus in the viewfinder and press the shutter release button halfway. The focus indicator (●) appears and you will hear a beep when the subject comes into focus (if it (●) is blinking, the subject is not in focus).



The focus indicator is blinking.

3. Keep pressing the shutter button halfway.
- Focus will be fixed unless you release the shutter button.

4. Re-compose the picture while keeping the shutter release button pressed halfway.



5. Press the shutter button fully. The picture is taken.



- The focus is locked while the focus indicator (●) is lit.
- Turning the zooming ring in focus lock mode may cause the subject to be out of focus.
- You can disable the beep sound through the **[Beep]** menu in the **[SETUP MENU]**.
- To fix the exposure on your subject, press and hold the shutter button at halfway to focus and then press the **AE-L** button (●). (The exposure is fixed until you fire the shutter button.)

Checking the focus

Adjusting the Focus Manually (Manual Focus)

When you adjust the focus manually, you can either check with the focus indicator in the viewfinder or use the viewfinder matte field to adjust focus.

Using the Focus Indicator

You can manually adjust the focus using the focus indicator (●).

1. Set the focus mode lever to **MF**.

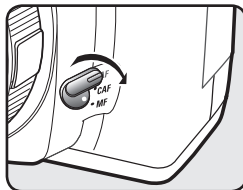

2. Look through the viewfinder, press the shutter release button halfway and turn the focusing ring.

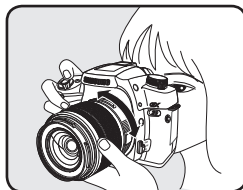

The focus indicator (●) appears and you will hear a beep when the subject comes into focus.

- You can disable the beep sound through the [Beep] menu in the [SETUP MENU].



The focus indicator

Checking the focus

Using the Viewfinder Matte Field

You can manually adjust the focus using the viewfinder matte field.

1. Set the focus mode lever to **MF**.

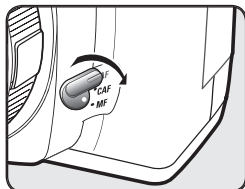

2. Look through the viewfinder and turn the focusing ring until the subject looks sharp on the screen.

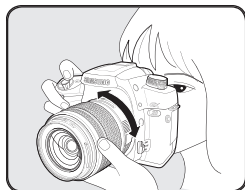

Setting the Exposure

Effect of Shutter Speed and Effect of Aperture

Aperture and shutter speed determine the exposure to light. You can create many interesting effects once you understand these aspects.

Effect of Shutter Speed

Shutter speed is the length of time the shutter is open. You can enjoy many interesting effects by adjusting the shutter speed.

Using slower shutter speed

A low shutter speed blurs motion on the image. You can feel the speed in the picture on the right.



▲ Aperture: $f = 8$,
Shutter Speed: $1/15\text{sec}$

Using faster shutter speed

A fast shutter speed is essential for capturing the movement. A faster shutter speed froze the same shot as shown on the right.



▲ Aperture: $f = 8$,
Shutter Speed: $1/125\text{sec}$

Effect of the Aperture

The aperture stop of a lens can be adjusted to control the amount of light reaching the image sensor. This is similar to the way the pupil of the human eyes reacts to bright light. The next image shows how the aperture is adjusted to a different size according to the corresponding aperture stop described in the lens. (The image may be different from the actual product and does not represent a specific lens model.)

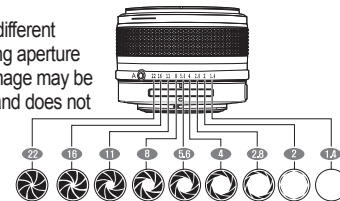

Opening the aperture (reduce the aperture value)

Objects closer and further away than the focused subject will be out of focus. You will see that the background is out of focus when you focus on the subject.



▲ Aperture: $f = 2.8$,
Shutter Speed: $1/500\text{sec}$

Closing the aperture (increase the aperture value)

The range in focus expands forward and backward. You will see that both the subject and the background are all in focus if you use a high aperture stop.



▲ Aperture: $f = 11$,
Shutter Speed: $1/500\text{sec}$

Setting the Exposure

How to Check Depth of Field

1. Focus on the subject.

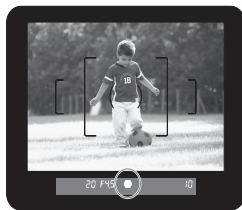

2. Turn the main switch while looking through the viewfinder.
- Checking the depth of field is only available if [Preview Method] is set to [Optical] in [CUSTOM2 MENU].

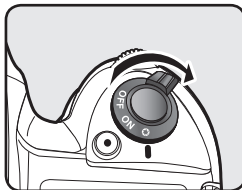

3. Now you can check the depth of field in the viewfinder.



- No shooting information is displayed in the viewfinder, and the shutter cannot be released while the main switch is in the preview position (Ⓢ).
- You can check the depth of field in all exposure modes.

Depth of Field?

When you focus on a specific subject, there is a range in which objects closer and further away will also be in focus. This focused range is called the depth of field.

- The wider the wide-angle lens, and the further away the subject, the greater the depth of field. For example, the aperture stop, f 11 is higher than f 2.8.

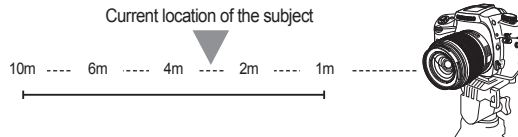

- ▲ The range of the area in focus with a large depth of field

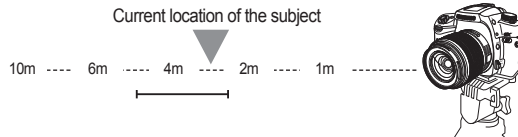



- ▲ The range of the area in focus with a small depth of field

Pictures used in this user guide are to help users understand depth of field and the results may differ depending on the types of lenses and the shooting environment.

Setting the Exposure

Selecting the Metering Method

Choose the part of the screen to use for measuring brightness and determining exposure.

 Multi-segment metering	Segment the screen in 16 parts, meter each portion and determine the appropriate exposure.
 Centre-weighted metering	Measure the entire screen with an emphasis on the centre and determine the exposure.
 Spot metering	Measure only the centre of the screen and determine exposure.

- Set with the metering mode lever.

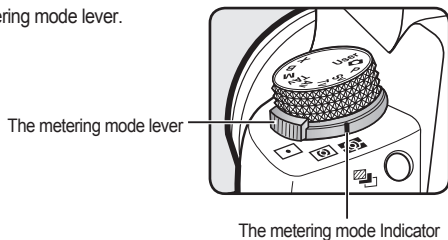

Exposure Compensation

This allows you to deliberately over expose (brighten) or under expose (darken) your picture. You can adjust the EV Compensation from -3 to +3 (EV) in increments of 1/2 EV or 1/3 EV. For information about under or over exposed samples, see page 90, "Changing the Exposure and Shooting (Auto Bracket)."

1. Set the compensation with the front dial () while the  button is pressed.

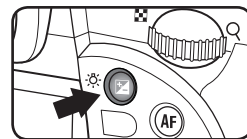

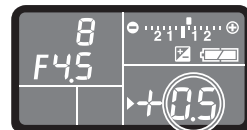

2. Confirm the compensation value in the viewfinder.
" +" or "-" appears during compensation.



Compensation value



- Exposure compensation is not available when the exposure mode is set to  (Auto mode), **M** (Manual), **B** (Bulb), and **X** (Flash synchro) mode.
- The exposure compensation is not cancelled by turning the camera off if you select the **[EV Compensation]** in the **[Memory of Settings]** of **[CAPTURE MENU]**.
- The is set to **0** when  button and green button () are pressed at the same time.

Setting the Exposure

AE-L with AF Locked

AE Lock is a function that memorizes the exposure prior to taking the picture. Use this when the subject is too small or backlit and a proper exposure setting cannot be obtained.

1. Look through the viewfinder and press the shutter button halfway.
The current exposure setting appears on the LCD panel and the viewfinder.
2. Press the **AE-L** (☉) button .
- The camera memorizes the exposure (brightness) at that instant. Press it again to unlock.

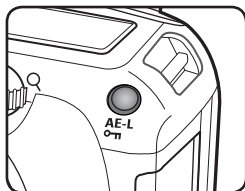

3. Press the shutter button fully to take a picture. The picture is taken with the memorized exposure value from Step 2 above.



- * is displayed in the viewfinder while the AE lock is engaged.
- After releasing the **AE-L** button (☉), the exposure remains in memory as long as the viewfinder is turned on. The exposure remains locked as long as the **AE-L** button (☉) is kept pressed or the shutter release button is kept pressed halfway.
- You will hear a beep when the **AE-L** button (☉) is pressed. You can disable the beep sound through the [Beep] menu in the [SETUP MENU].
- AE lock is not available when the exposure mode is **A** (Auto mode), **B** (Bulb) or **X** (Flash synchro) mode.
- The combination of shutter speed and aperture value changes depending on the zooming position even while the AE lock is engaged when using a zoom lens for which maximum aperture varies depending on the focal length. However, the exposure value does not change and the picture is taken at the brightness level set by the AE lock.
- Exposure can be fixed when focus is locked. Set in [AE-L with AF Locked] in the [CUSTOM1 MENU] menu.

Using the RAW button

When you press the **RAW** button, the images are taken as RAW and JPEG file types. For more information about using the **RAW** button, see page 56, "Set RAW button."

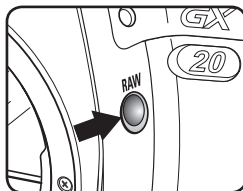

- When you press the **RAW** button, **RAW** or **RAW+** will display on the LCD panel.
- Press the Shutter button to take a picture.



- To cancel the RAW button function, turn the mode dial (🔘) or press the **RAW** button once again.
- When the picture is taken using the **RAW** button, it may take a time to save the image as the images are saved as RAW and JPEG file type.
- When the picture is taken using the **RAW** button, is displayed on the LCD monitor, only a JPEG image is displayed. To view the RAW image, use the supplied Software.

Using the Mirror Lock Up Function

The mirror lock up function minimizes camera shake. When the shutter button is pressed, the mirror pops up first to reduce camera shake while shooting.

1. Press the **Fn** button on your camera and then press the direction button (**▲**).
- The Drive Mode options screen appears.
- If the AF mode is not set to **SEL**, you can directly press the direction buttons (**▲**) to use the drive mode.

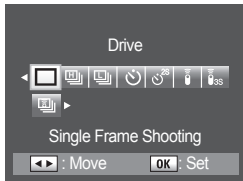

2. Press the direction buttons (**◀▶**) to select **[Self-Timer (2 secs)]**.

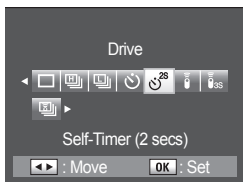

3. Focus on the subject.

4. Press the shutter release button fully. The mirror pops up and the picture is taken 2 seconds later. The AE lock is enabled with the exposure value set immediately before the mirror goes up.







- You cannot see the subject through the viewfinder for the next two seconds after you press the shutter button.
- Using the tripod minimize camera shake while you keep the same angle of view.



When using the mirror lock-up function, do not aim the camera toward the sun. Direct sun light may damage the shutter curtain.





Self-Timer Shooting

When the self-timer is enabled, there is a delay between the pressing of the shutter release and the shutter firing. You can use this function when you want to take a shot of many people including yourself. Select  or .

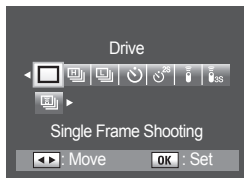
-  : Shutter will be released after about 12 seconds. Use this mode to include the photographer in the picture.
-  : After pressing the shutter button the mirror will pop up directly. The shutter is released after about 2 seconds. Use this mode to avoid camera shake when the shutter release button is pressed.

1. Press the **Fn** button on your camera and then press the direction button () .
- The drive mode screen appears.



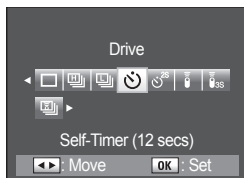

2. Press the direction buttons ( ) to select  or .





3. Press the **OK** button
- The camera is ready to take pictures.

4. Confirm in the viewfinder that the subject you wish to shoot is in the display and press the shutter release button halfway. The focus indicator () appears when the subject is in focus.

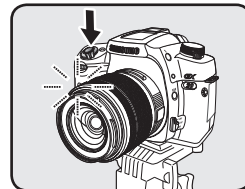

5. Press the shutter release button fully.
 -  : The self-timer lamp starts blinking slowly at first and then blinks rapidly for 2 seconds before the shutter is released. The beep is heard and the rate increases. The shutter will be released about 12 seconds after the shutter release button is pressed fully.
 -  : The shutter will be released about 2 seconds after the shutter release button is pressed fully.



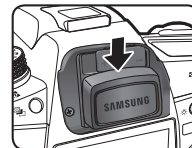
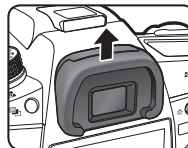

- You can cancel the self-timer by pressing the **MENU** button or rotating the Mode dial () while the self-timer is operating.
- The beep can be turned off. You can disable the beep sound through the [**Beep**] menu in the [**SETUP MENU**].
- Exposure may be affected if light enters the viewfinder. Attach the provided viewfinder cap or use the AE lock function. (Ignore the light entering the viewfinder when the exposure mode is set to the **M** (Manual) mode.
- Remove the Eyecup by pulling one side out and toward you when using accessories such as the viewfinder cap.







Remote Control Shooting (Sold Separately)

You can set the remote control function in the drive mode menu.
(sold separately)

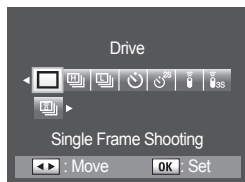
-  **[Remote Control]** : The shutter will be released immediately the shutter release button on the remote control unit is pressed.
-  **[Remote Control (3s delay)]** : The shutter will be released 3 seconds after the shutter release button on the remote control unit is pressed.
-  **[Remote Control (continuous)]** : The continuous shooting starts as soon as you press the remote control unit. Press the remote control unit one more time to finish shooting.

1. Press the **Fn** button on your camera and then press the direction button (**▲**).
- The drive mode screen appears.



2. Press the direction buttons (**◀▶**) to select , , or .



3. Press the **OK** button.
- The camera is ready to take pictures.

4. Press the shutter release button halfway.
- The autofocus system operates. The focus indicator (●) appears in the viewfinder when the subject is in focus.

5. Point the remote control unit towards the front of the camera and press the shutter release button on the remote control.
The picture is taken.

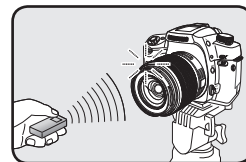

- You cannot focus with the remote control unit in default settings. Focus on the subject first before operating with the remote control. You can set **[AF in Remote Control]** to **[On]** in the **[CUSTOM1 MENU]** menu.
- Turn the power off to stop the remote control operation after it has been activated.
- The remote control may not operate in backlit conditions.
- To take a picture while charging the built-in flash, set **[Release in Charging]** to **[On]** in the **[CUSTOM2 MENU]**.
- When using the built-in flash, raise the flash into position first.

Using the Menu

This section explains the operation methods for [CAPTURE MENU (📷)], [CUSTOM1 MENU (👤1)], [CUSTOM2 MENU (👤2)], [SETUP MENU (🔧)], and [PLAYBACK MENU (▶)].

Once the menu options are set, the memorized set value appears again after you turn on the camera.

Using the MENU button

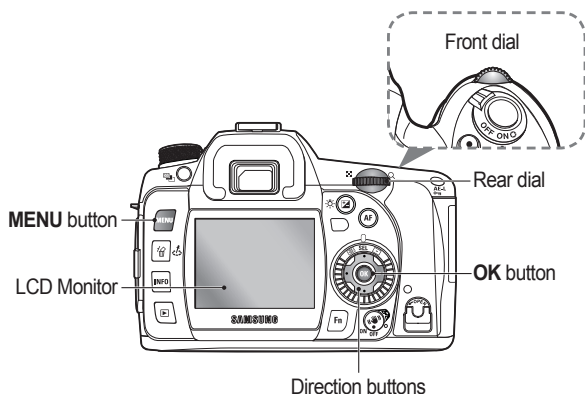

1. Press the **MENU** button.
-The [CAPTURE MENU] menu appears on the LCD monitor.

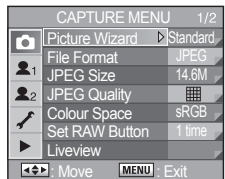

2. [CAPTURE MENU (📷)], [CUSTOM1 MENU (👤1)], [CUSTOM2 MENU (👤2)], [SETUP MENU (🔧)], and [PLAYBACK MENU (▶)] menu appear in order each time the direction buttons (◀▶) is pressed.



- Press the **MENU** button to return to your previous screen.
- Use the front dial (🌀) to move forward to the next screen in the current menu and use the rear dial (🌀) to jump to the next menu.
- If the power is not turned off properly, the set value will be lost next time you turn on the camera.

Using the Menu

Using the CAPTURE MENU (📷)

This section explains the methods for [CAPTURE MENU].

Picture Wizard

The Picture Wizard function enables you to adjust the image before shooting. You can create the image you desire by adjusting the [Colour tone], [Saturation], [Contrast], and [Sharpness].

The following images show how the contrast is changed using the Picture Wizard function.

▼ With a high-set (+) value on the contrast



▼ With a low-set (-) value on the contrast



1. Press the **Picture Wizard** (🔍) button on your camera.
- The following screen appears.

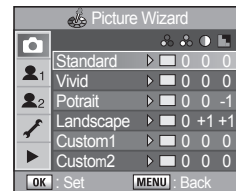

2. Select the desired menu option using the direction buttons (▲▼) and then press the direction buttons (◀▶).
- Make a change to the set value for [Colour tone], [Saturation], [Contrast], and [Sharpness]. You can create the image you desire by adjusting the [Colour tone], [Saturation], [Contrast], and [Sharpness].
- Pressing the green button (⊙) on the camera initializes the set value.



3. Press the **OK** button to save and then take a picture.

Using the Menu

File Format

You can set the format of image files.

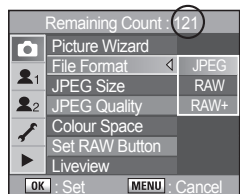

- **JPEG** : Captures images in JPEG format. You can change the number of recorded pixels from [JPEG Size] in the [CAPTURE MENU] menu, and the image quality level from [JPEG Size] and [JPEG Quality] in the [CAPTURE MENU] menu. The file size varies according to the settings.
- **RAW** : RAW data is CCD output data saved without processing. Effects such as White Balance, Contrast, Saturation and Sharpness are not applied to the image but such information is saved. Use Raw Display or transfer to a PC, apply effects with the enclosed software (Samsung RAW Converter 2.0) and create JPEG and TIFF images.
- **RAW+** : Images are captured in both RAW and JPEG formats.

JPEG Size

You can set the size of the JPEG recorded pixels.

- **14.6M / 10M / 6M / 2M**

When the number of recorded pixels is changed, the number of recordable images appears at the top right of the screen.

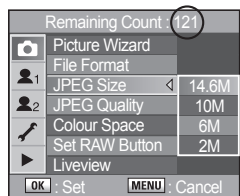



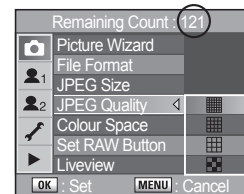

JPEG Quality

You can set the image quality level.

When the quality level is changed, the number of recordable images at that quality level appears at the top right of the screen.



 Super fine (1)	Lowest compression rate, suited for printing large pictures such as A4 size.
 Super fine (2)	Low compression rate, suited for printing large pictures such as A4 size.
 Fine	Standard compression rate, suited for viewing as photographs or on your computer screen.
 Good	Highest compression rate, suitable for attaching to e-mail or posting on websites.

Using the Menu

Colour Space

You can set the colour space to use.

- sRGB : Sets to sRGB colour space.
- AdobeRGB : Sets to AdobeRGB colour space.

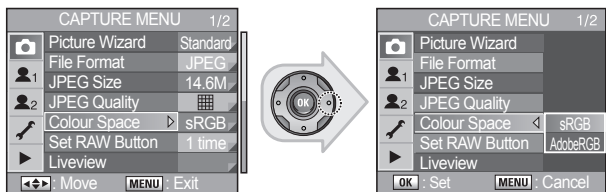

Colour Space?

Colour ranges for various input/output devices, such as digital cameras, monitors, and printers, differ. This colour range is called the colour space. To recreate different colour spaces in different devices, standard colour spaces have been proposed. This camera supports sRGB and AdobeRGB. sRGB is mainly used for devices such as a PC. AdobeRGB covers a wider area than sRGB and is used for occupational uses such as industrial printing. An image created in AdobeRGB may appear lighter than an image created in sRGB when output from a sRGB compatible device.



- File names differ depending on the colour space setting as shown below.
 - For sRGB : SG20 XXXX.JPG
 - For AdobeRGB : _G20 XXXX.JPG[XXXX] is the file number and numbering continues from the last stored file number.
- You can change the file name as you want to change. For more information about changing the file name, see page 74, "Change File Name."

Set RAW Button

You can set how to capture RAW+JPEG images whenever the RAW button is pressed. If [Cancel setup] is selected in the [Set RAW Button] menu, RAW button function is available for one time use.

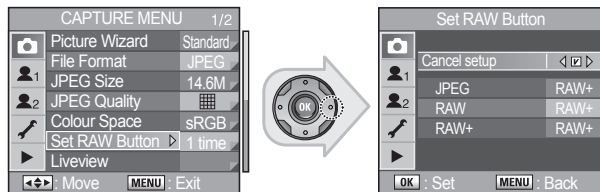

Liveview

You can set the grid and Focusing Area (AF Point), AF frame display options in the Liveview mode. The Focusing Area (AF Point), AF frame display is not available if AF mode is set to MF.

- **Grid Display** : Shows the grid on the LCD monitor when using the Liveview function.
- **AF Frame Display** : Shows the Focusing Area (AF Point) / AF frame on the LCD monitor while using the Liveview function.

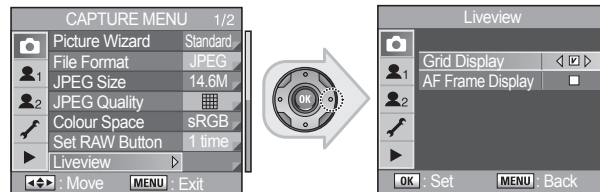

If you want to cancel the use of the grid display and the AF frame display options while using the Liveview function, clear the check boxes in the [Grid Display] and the [AF Frame Display] from the [Liveview] menu.

Using the Menu

User Registration

You can save the current set value to User program mode.

The following settings can be stored:

Exposure mode / EV Compensation / White Balance / Flash mode / Drive mode / File Format / Extended Bracketing Steps & Type / JPEG Size / Flash Exposure Compensation / JPEG Quality / Exposure Bracketing Steps & No. of Frames / Sensitivity / Auto Sensitivity Adjustment Range

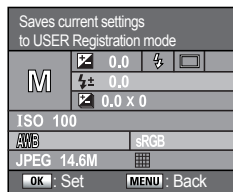
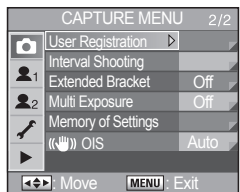

Interval Shooting

In this mode, a set number of pictures can be taken automatically at a set interval from a set time.

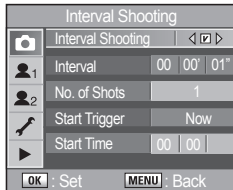
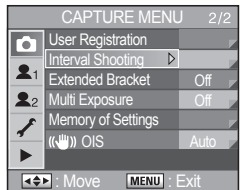

- Interval shooting can not be used while the [Extended Bracket] or [Multi Exposure] functions are used. B (Bulb exposure) program mode does not support the interval shooting.
- If [Start Trigger] is set to [Set Time] in the interval shooting mode, the current time is displayed on the top right corner in the screen.

Extended Bracket

You can save pictures with three different white balance, saturation, sharpness and contrast levels. Three pictures are saved with each shot. The following settings are available in the [Extended Bracket] menu.

- White Balance** : MG±3 / MG±2 / MG±1 / AB±3 / AB±2 / AB±1 (M=Masenta / G=Green / A=Amber / B=Blue)
- Saturation** : ±4 / ±3 / ±2 / ±1
- Contrast** : ±4 / ±3 / ±2 / ±1
- Sharpness** : ±4 / ±3 / ±2 / ±1

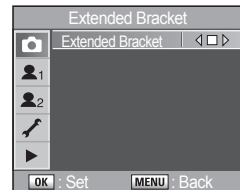
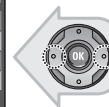
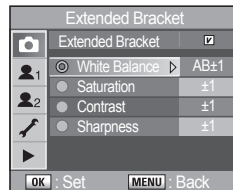
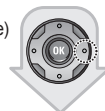
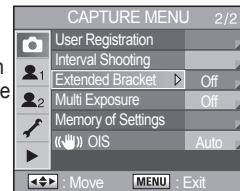

The following images show how the [Contrast] is changed using the [Extended Bracket] menu.



▲ Low contrast



▲ Normal contrast



▲ High contrast

Using the Menu

Multi Exposure

You can set the number of shots to be taken in the [Multi Exposure] function. You can take multiple frames while creating a single picture. The image shown on the right has two separate frames in a single picture.

- **Number of Shots** : 2 - 9 images
- **Auto EV Adjust** : The exposure is adjusted automatically according to the number of shots.

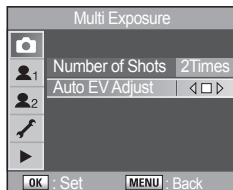
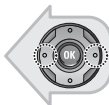
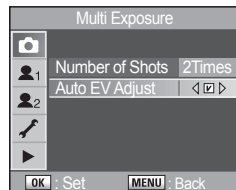
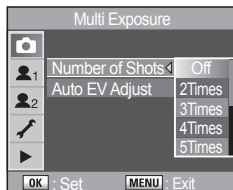
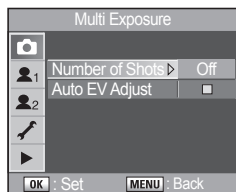

- If the **RAW** button or **MENU** button is pressed, or the (Extended) Auto Bracket is set during Multi-exposure shooting, the pictures that have already been taken are saved and Multi-exposure is exited.
- **[Extended Bracket]** and **[Multi Exposure]** are not used at the same time. The last mode selected is set.
- Press the delete button (🗑️) during Instant Review to discard pictures created to that point and create again from the first picture.
- After completing the Multi Exposure shooting, the settings for Multi Exposure will be canceled.

Using the Menu

Memory of Settings

You can select which settings to save when the camera is turned off.

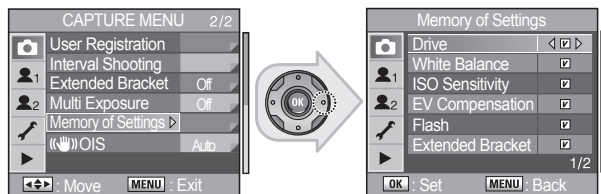

	<input checked="" type="checkbox"/>	<input type="checkbox"/>
Drive White Balance ISO Sensitivity EV Compensation Flash Extended Bracket Playback Display Flash power	The settings are maintained when the camera is turned off.	The settings are reset when the camera is turned off.
File No.	New files are named using numbers that follow the previous sequence, even when a new memory card is used, or after formatting, or after deleting all pictures.	After using the reset function, the next file name will be set from 0001 even after formatting, deleting all or inserting a new memory card.

((())) OIS (Optical Image Stabilization)

OIS (Optical Image Stabilization) helps the user capture sharp images by reducing camera shake/vibration. Optical Image Stabilization is especially useful when using a low shutter speed which may cause camera shake.

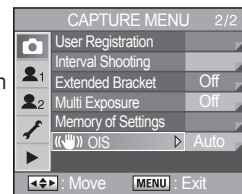

If you use the lens that does not support the automatic information about the focal length, you can manually select the available focal length to enable the OIS function.

1. Select **((())) OIS** menu in the **[CAPTURE MENU]**.
2. Press the direction buttons (**◀▶**) on your camera to set the **[Focal Length]**. Select from the following focal length values.

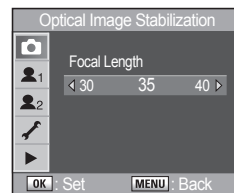

	8	10	12	15	18	20	24	28	30	35
Focal Length	40	45	50	55	65	70	75	85	100	120
	135	150	180	200	250	300	350	400	450	500
	550	600	700	800	-	-	-	-	-	-



- If the focal length for your lens is not listed above, select the value closest to the actual focal length.
- When using a zoom lens, select the actual focal length at the zoom setting in the same manner.

Using the Menu

Using the CUSTOM1 MENU (👤)

Link AF Point & AE

Sets whether to adjust AE and Focusing Area in multi-segment metering based on the AF point. You can link the exposure and AF point in the focusing area during multi-segment metering.

- **Off** : Exposure is set separately from AF point.
- **On** : Exposure is set in accordance with AF point.

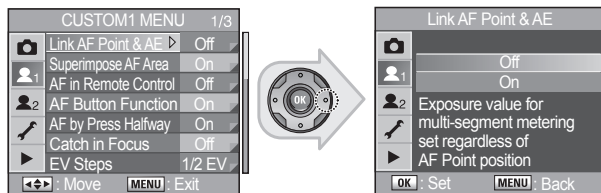

Superimpose AF Area

You can set whether to display the selected AF point in red when the subject is in focus.

- **On** : The exposure sets according to the AF point.
- **Off** : The exposure sets regardless of the AF point.

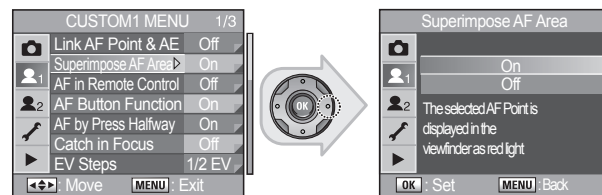

AF in remote control

Sets whether to use Autofocus when shooting with remote control. Auto focusing (AF) is only available if the AF mode is set to **SAF**.

- **Off** : AF does not activate at shutter release from remote control when [Off].
- **On** : AF activates if shutter is released from remote control when [On].

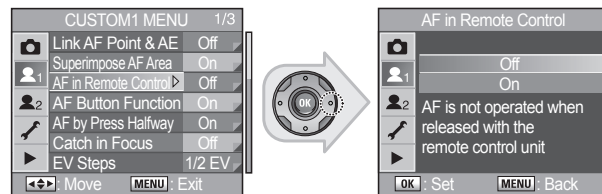

Using the Menu

AF Button Function

Set whether to perform AF while the **AF** button is pressed or not perform AF while the AF button is pressed.

- **Enable AF** : Performs Autofocus when pressing the **AF** button.
- **Cancel AF** : Does not perform Autofocus when pressing the **AF** button.
- **Centre of AF Point** : When the AF (Auto focusing) mode dial is set to **SEL**, AF Point is set to Centre.

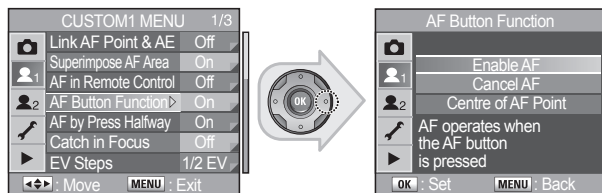

AF by Press Halfway

Sets whether to perform AF when the shutter release button is pressed halfway.

- **On** : Performs AF when the shutter release button is pressed halfway.
- **Off** : Does not perform AF when the shutter release button is pressed halfway.

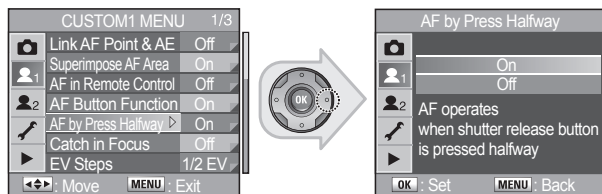

Catch in Focus

The catch in focus function disables the shutter button if the subject is out of focus while using the MF focusing mode.

For the following cases, the shutter button operates differently depending on the **[Catch in focus]** option:

- When the manual focusing lens is used.(with the focus mode lever set to **SAF**).

- The current lens has an **AF / MF** lever and it is set to **MF**.

• **Off** : Shutter fires whether the subject is in focus or not.

• **On** : Shutter fires only when the subject is in focus.

Although the subject is in focus on half shutter, you cannot take a picture if the subject is out of focus on full shutter release.

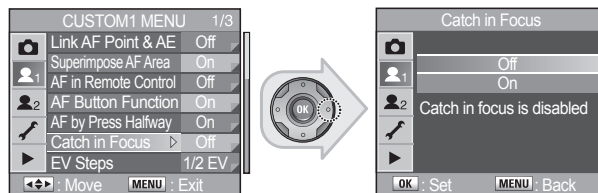

Using the Menu

EV Steps

Sets the adjustment steps for exposure.

- **1/2 EV** : Sets the EV step to 1/2 EV.
- **1/3 EV** : Sets the EV step to 1/3 EV.

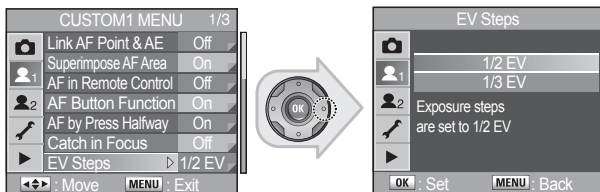

AE-L with AF Locked

Locks the exposure value when the focus is locked.

- **Off** : Does not lock the exposure when focus is locked.
- **On** : Locks the exposure when the focus is locked.

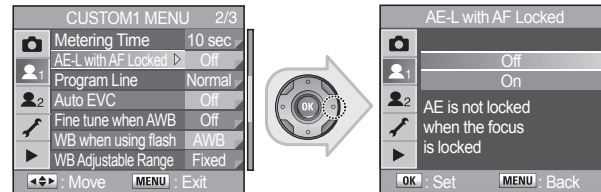

Metering Time

Sets the exposure metering time.

- **10 sec** : Sets the exposure metering time to 10 seconds.
- **3 sec** : Sets the exposure metering time to 3 seconds.
- **30 sec** : Sets the exposure metering time to 30 seconds.

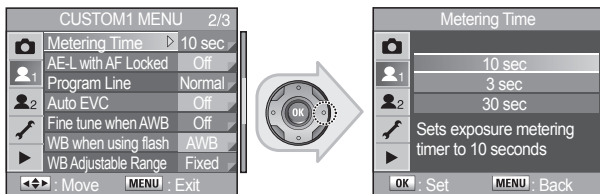

Program Line

In Auto mode and Program mode, exposure is regulated according to the set Program line.

- **Normal** : Normal program is the basic Automatic Exposure Program.
- **H.Speed** : Hi-speed priority program is an Automatic Exposure Program that selects higher shutter speeds.
- **Depth** : Depth-of-field priority program is an Automatic Exposure Program that selects smaller aperture settings to maximise depth-of-field.
- **MTF** : MTF priority program is an Automatic Exposure Program that selects the best aperture settings for the attached lens.

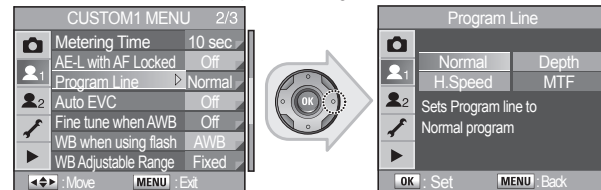

Using the Menu

Auto EVC

Sets whether to compensate automatically when proper exposure cannot be determined.

- **Off** : The exposure does not compensate when the exposure cannot be accurately calculated automatically.
- **On** : The exposure compensates automatically when the automatic exposure function is unable to set the exposure accurately.

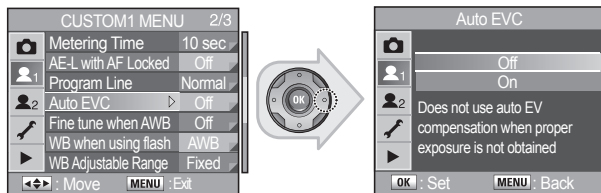

Fine Tune when AWB

Sets whether fine tune is available when white balance is set to Auto.

- **Off** : The AWB fine tuning is not available.
- **On** : The AWB fine tuning is available.

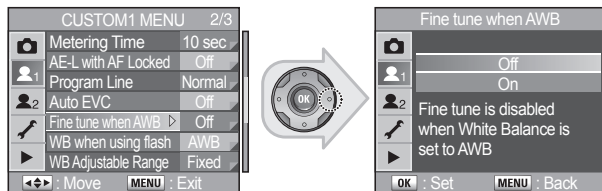

WB when using flash

Sets whether to fix white balance when flash is discharged.

- **AWB** : White Balance is set to Auto when using flash.
- **Unchanged** : White Balance setting is not changed by flash use.
- **Flash** : White Balance setting is set to Flash when using flash.

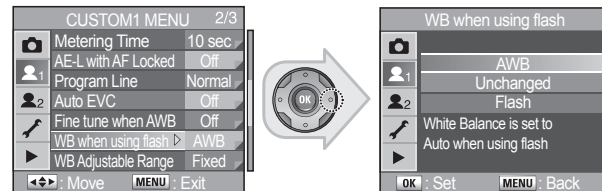

WB Adjustable Range

Automatically adjusts white balance depending on the different light conditions even though the light source is specified by setting [WHITE BALANCE] in the Fn menu.

- If the [WB Adjustable Range] is set to [Auto Adjustment], the white balance value is automatically adjusted within the adjustable range.

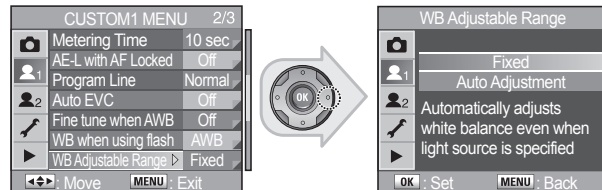

[WB Adjustable Range] function is not available for the [AUTO], [Manual], and the [Colour Temp.1] to [Colour Temp.3] mode in the [WHITE BALANCE] menu.

Using the Menu

Colour Temp. Unit

Use figures to set the colour temperature.

- **Kelvin** : Sets the colour temperature by 100K.
- **Mired** : Sets the colour temperature by 20 Mired. The figures are converted to Kelvin and displayed.

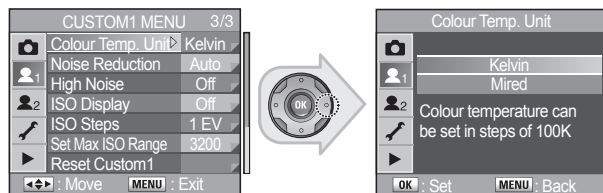

High Noise

Enables the **[High Noise]** function when ISO sensitivity is high. **[High Noise]** function is activated at an ISO of 800 or higher.

- If set to **[Off]**, **[High Noise]** is not activated.

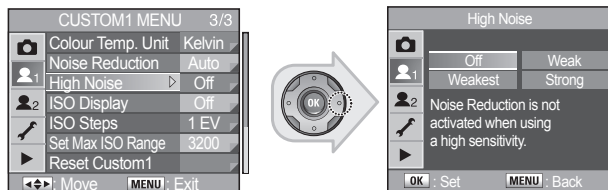

Noise Reduction

Sets whether to use Noise Reduction in slow speed shooting.

- **Auto**: Noise Reduction will be automatically activated according to the conditions.
- **On** : Sets whether to use Noise Reduction in slow speed shooting, slower than the shutter speed of "0.3."

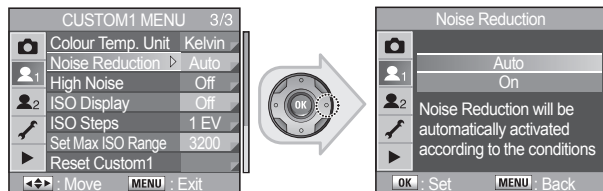

ISO Display

Displays sensitivity in the viewfinder and LCD panel.

- If set to **[Off]**, displays the number of recordable images in the viewfinder and LCD panel.

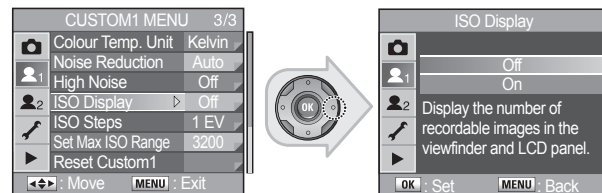

Using the Menu

ISO Steps

Set the sensitivity step.

- **1 EV Step** : Set the sensitivity step to 1 EV.
- **As EV Steps** : Set the sensitivity according to the EV setting.

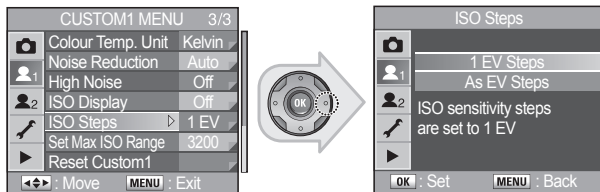

Reset Custom1

Resets all the settings in the [CUSTOM1 MENU] menu to the defaults.

- **Reset** : Resets the settings.
- **Cancel** : Does not reset the settings.

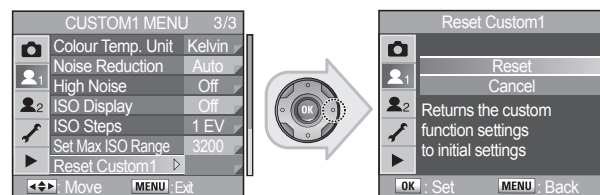

Set Max ISO Range

You can set the maximum ISO sensitivity range. If [Set Max ISO Range] is set to [6400], ISO sensitivity can be set to 6400.

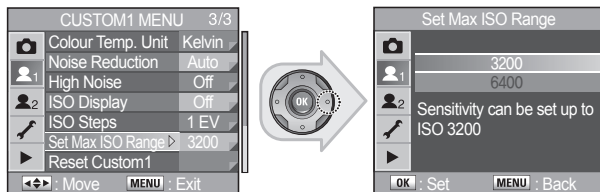

It is possible to see more noise in the images when setting the ISO sensitivity to "6400."

Using the Menu

Using the CUSTOM2 MENU (2)

E-Dial in Program / Sv / Tv / Av / TAv / M / X / B

Sets the front dial (☺) and rear dial (☹) in Program / Sv / Tv / Av / TAv / M / X / B mode.

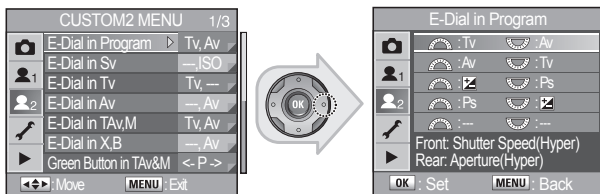

Example: E-Dial in Program

Green Button in TAv&M

Selects the exposure adjustment method when the green button (☺) is pressed in **TAv** & **M** (Manual) mode.

- **Program Line** : The aperture value and shutter speed are adjusted automatically.
- **Tv Shift** : The aperture value is locked and the shutter speed is adjusted automatically.
- **Av Shift** : The shutter speed is locked and the aperture value is adjusted automatically.

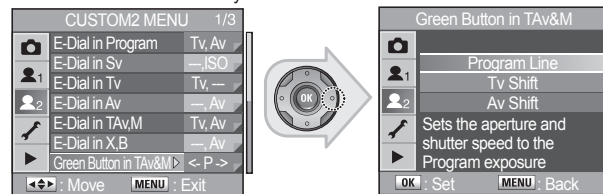

Use Aperture Ring

Sets the shutter so it can be released even if the aperture ring is not set to the **A** (Auto) position. This function is only available for the lenses with an aperture ring.

- **Off** : Shutter fires only when the aperture ring is set to **A**.
- **On** : The shutter can be released even if the aperture ring is not set to the **A** (Auto) position.

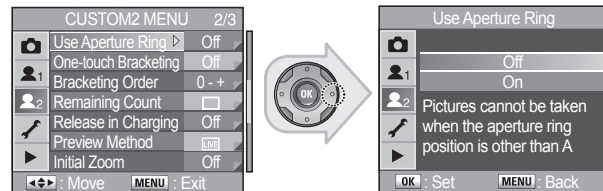

Using the Menu

One-touch Bracketing

When the shutter button is pressed, a number of set images are shot.

- **Off** : Takes one shot with one shutter release.
- **On** : Takes a specified number of shots in bracket shooting with one shutter release.

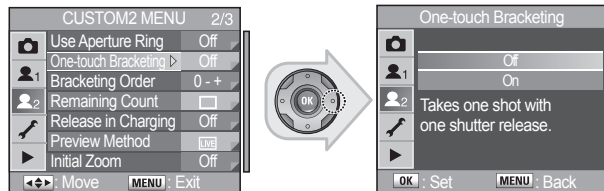

Bracketing Order

Sets the order for bracket shooting.

If Bracketing Order is set to "0 - +", with an aperture stop of 8.0, you will get three different shots with the aperture stops of 8.0, 6.7, and 9.5. For more information about auto bracketing, see page 90 "Changing the Exposure and Shooting (Auto Bracket)."

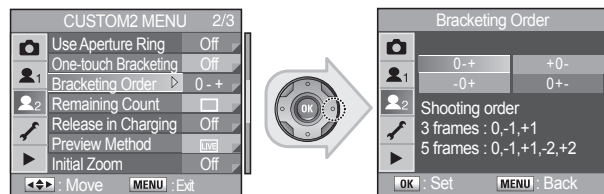

Remaining Count

Sets to switch number of recordable images in the LCD panel and viewfinder.

- **Normal** : Displays the number of recordable images in the LCD panel and viewfinder.
- **Continuous** : The number of continuous recordable images is displayed when the shutter release button is pressed halfway.

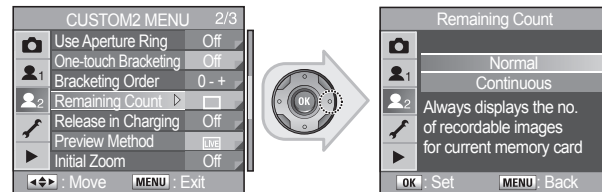

Release in Charging

You can set to allow shooting while the flash is re-charging.

- **Off** : Pictures cannot be taken while the flash is re-charging.
 - **On** : Pictures can be taken while the flash is re-charging.
- Flash may not fire even though you set [Release in Charging] to [On] in the [CUSTOM2 MENU].

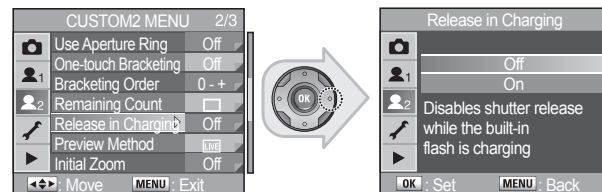

Using the Menu

Preview Method

Choose the preview method to use when the main switch is turned to the preview position (🔍). Set values in the **[Preview Method]** are activated when the main switch is turned to the preview position (🔍).

- **Optical** : You can check the depth of field in the viewfinder.
- **Digital** : You can check the composition, exposure and focus on the LCD.
- **Liveview** : You can actually see the composition of your subject and the focus through the LCD monitor in real time.
- **Manual W.B.** : You can adjust the white balance manually.

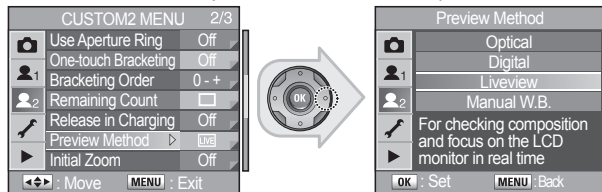

Initial Zoom

Sets the initial magnification of the zoom playback.

- **Initial Zoom** : **[Off], [2 times], [4 times], [8 times], [16 times], [32 times]**

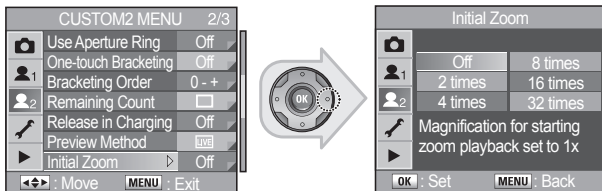

Auto Rotation

Sets to automatically rotate images taken vertically when playing back. If the **[Saving Rotation Info.]** is not set to **[Off]**, the image will not be rotated automatically.

- **On** : The images taken vertically rotate automatically.
- **Off** : The images taken vertically do not rotate automatically.

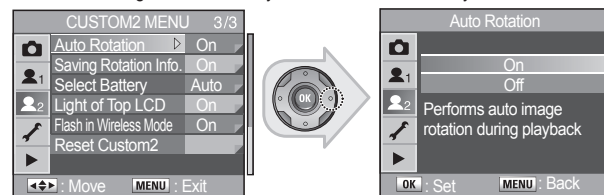

Saving Rotation Info.

If **[Saving Rotation Info.]** is set to **[On]**, a shot taken using a vertical position is displayed in the vertical angle of view.

- **On** : Saves the rotation information when shooting.
- **Off** : Does not save the rotation information when shooting.

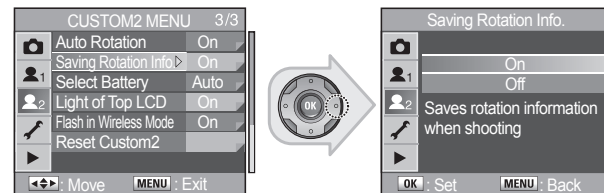

Using the Menu

Select Battery

Controls the consumption priority of the batteries power between the camera body and vertical grip.

- **Auto** : Set the battery consumption priority to the battery that has more power.
- **Body First** : Set the battery consumption priority to the battery in the camera body.
- **Grip First** : Set the battery consumption priority to the battery in the vertical grip.

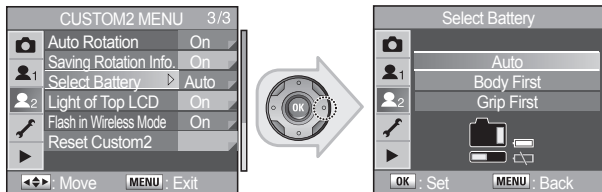

Light of Top LCD

Sets whether or not to illuminate the LCD panel.

- **On** : The LCD panel will illuminate when pressing the LCD panel lamp button.
- **Off** : The LCD panel will not illuminate when pressing the LCD panel lamp button.

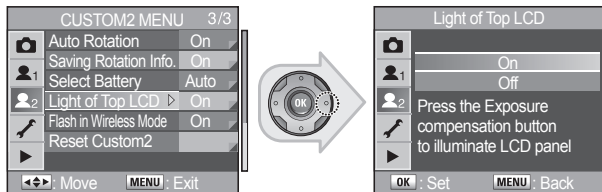

Flash in Wireless Mode

Fires built-in flash as master in wireless mode.

- Fires built-in flash as controller in wireless mode.

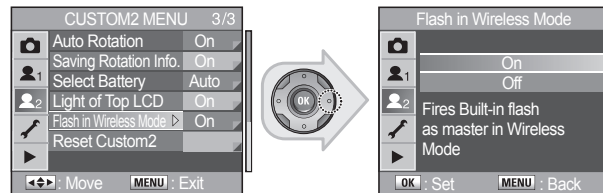

Reset Custom2

Resets all the settings in the [CUSTOM2 MENU] menu to the defaults.

- **Reset** : The settings will reset.
- **Cancel** : The settings will not reset.

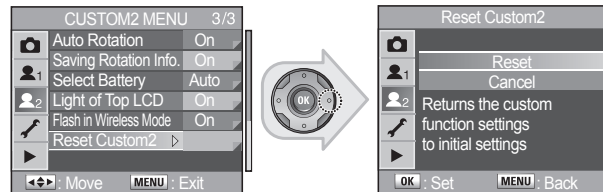

Using the Menu

Using the SETUP MENU (🔧)

Perform various settings related to the camera in the [SETUP MENU] menu.

Format

Formats the Memory Card. Be sure to format new Memory Card with the camera before using the card. Formatting will delete all the data on the Memory Card.

- **Format** : The memory will be formatted.
- **Cancel** : The memory will not be formatted.

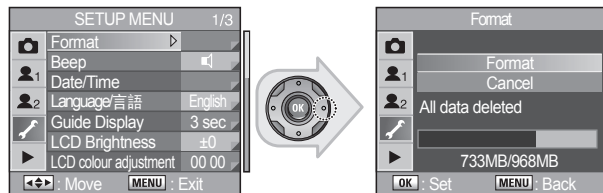

When formatting is completed, camera mode is changed to the Capture or Playing back mode.



- Do not open the card cover while formatting Memory Card. The card may be damaged beyond use.
- Formatting will delete protected data. Be aware.

Beep

You can turn the camera operation beep on or off.

- : You can turn the camera operation beep on or off.
- [AF Sound], [AE Lock], [RAW], [Self-Timer], [Remote Control]
- : No beep sound

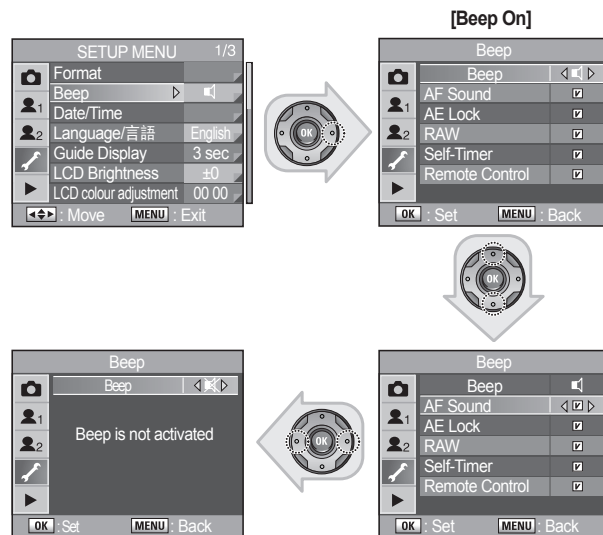

Using the Menu

Date/Time

You can change the initial date and time settings. You can also set the display style.

- **Date Display Style** : [mm/dd/yy], [dd/mm/yy], [yy/mm/dd]
- **Time Display Style** : [12h] (12 hour), [24h] (24 hour)

Setting the Type

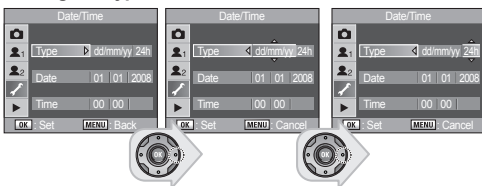

Date Setting

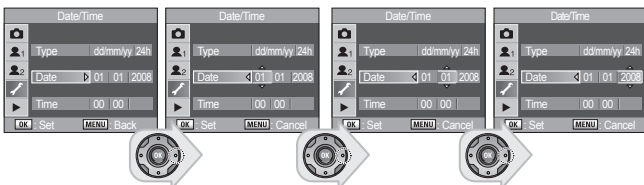

Time Setting

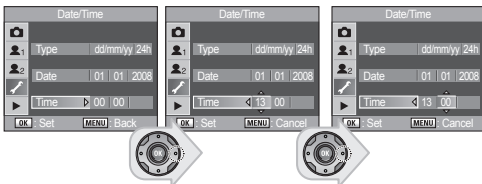

Language/言語

You can change the language in which the menus, error messages, etc. are displayed.

- **Language/言語** : English, Korean, Chinese (Traditional / Simplified), French, German, Spanish, Portuguese, Italian, Swedish, Dutch, Danish and Russian

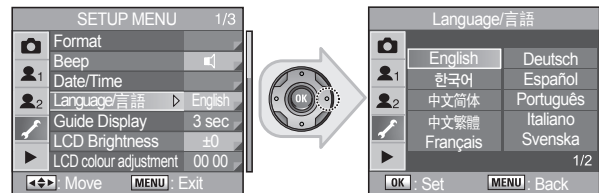

Guide Display

Set to display time of guides on the LCD monitor when main switch is on or the mode dial is changed.

- **Guide Display Time** : [Off], [3 Sec], [10 Sec], [30 Sec]

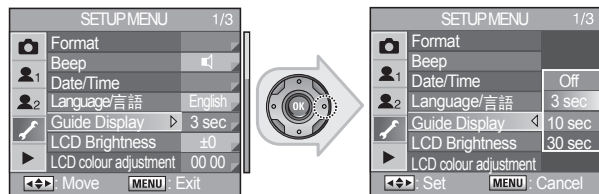

Using the Menu

LCD Brightness

You can adjust the brightness of the LCD monitor. Adjust settings when the LCD monitor is hard to see.

- You can select -7 ~ 0 ~ +7 steps of LCD brightness.

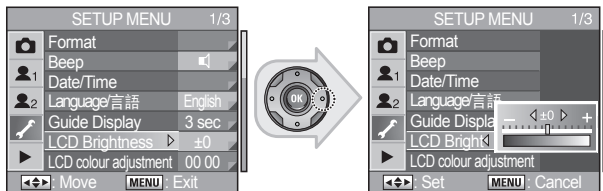

LCD colour adjustment

You can adjust the colour of the LCD monitor.

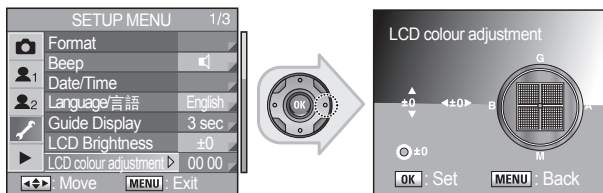

Video Out

When you connect the camera to AV equipment such as a TV, choose the appropriate video output format (NTSC or PAL) for playing back images.

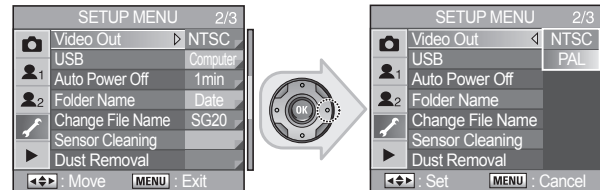

- Once you select the language, the appropriate video output format for that country is selected.
- When using a TV as an external monitor, you will need to select the external or AV channel of the TV.
- There will be a digital noise on the external monitor, but it is not a malfunction.
- If the image is not in the centre of the screen, use the TV controls to centre it.
- When the camera is connected to an external monitor, the menu will be visible on the external monitor and the menu functions are the same as those indicated on the LCD monitor.

Using the Menu

USB (Selecting an external device)

This menu sets the USB cable connection (PC or printer).

- **Computer** : Select this menu when connecting to a computer.
- **Printer** : Select this menu when connecting to a printer.

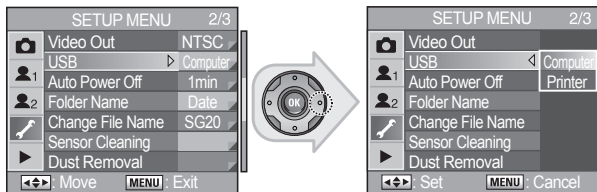

Auto Power Off

You can set the camera to turn off automatically if unused after a certain length of time.

- **Auto Power Off** : [1min], [3min], [5min], [10min], [30min], [Off]

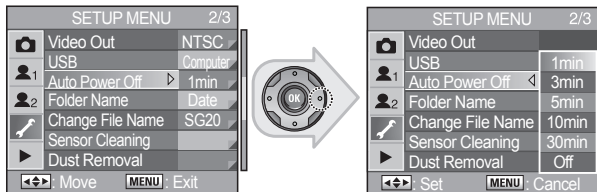

[Auto Power Off] is not activated when using the USB connection, remote control, Liveview, Fn menu, or slide show.

Folder Name

You can select the method for assigning the folder names for storing images.

- **Standard** : The folder names are assigned as “100SSCAM → 101SSCAM → ... → 999SSCAM” in order.
- **Date** : The two digits of the [month] and [day] on which the picture was taken are assigned as the folder name in the form of [100_0101].
(Example) 101_0101 : for folders with pictures taken on January 1st.

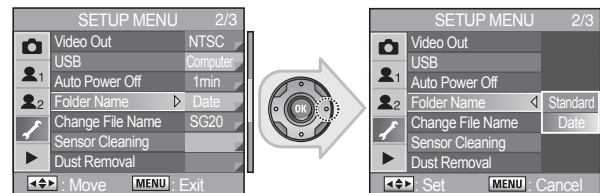

Using the Menu

Change File Name

You can change the file name depending on the color space.
For example, you can change the file name of "SG20" if the **[Colour Space]** is set to **[sRGB]**.

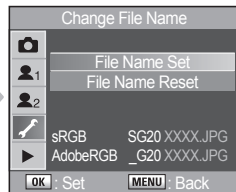
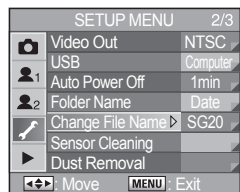

Press the **OK** button.



Use the rear dial (Fn) and Fn button to select desired file name.

Sensor Cleaning

Shadows may appear in the image for white backgrounds and other shooting conditions if the Sensor becomes dirty or dusty. This indicates that the Sensor must be cleaned. Please contact Samsung Camera service centre for professional cleaning because the Sensor is a precision part.

1. Turn the camera off and remove the lens.
2. Turn the camera on.
3. Select **[Sensor Cleaning]** on the **[SETUP MENU]** menu.
4. Press the direction button (▶) on your camera.
 - The Sensor Cleaning screen appears.
5. Use the direction buttons (▲▼) to select **[Mirror Up]**.
 - Capture image appears first to show dust in the sensor if you have previously activated **[Dust Alert]**.
6. Press the **OK** button.
 - The mirror is locked in the up position.
7. Clean the Sensor.
 - Use a brush-less blower to remove dirt and dust from the Sensor. Using a blower with a brush may scratch the Sensor. Do not wipe the Sensor with a cloth.
8. Turn the camera off.
9. Attach the lens after the mirror returns to its original position.

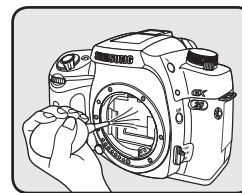
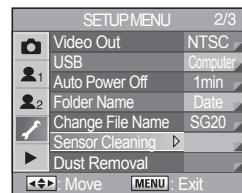

Using the Menu



- Do not use a spray type blower.
- Do not clean the Sensor when the exposure mode is set to **B** (Bulb) mode.
- Always cap the lens mount area to prevent dirt and dust from accumulating on the Sensor when no lens is on the camera.
- It is recommended to use the AC Power Adapter (SAC-82, sold separately) when cleaning the Sensor.
- When the battery level is low, a warning message **[Not enough battery remaining to clean sensor]** is displayed on the LCD monitor.
- If you are not using the AC Power Adapter, please use batteries with ample capacity remaining. A warning beep will sound if the battery capacity becomes low during cleaning. Please stop cleaning immediately.
- Do not put the tip of the blower inside the lens mount area. If the power is turned off, this could cause damage to the shutter or the Sensor.
- The Self-timer lamp blinks and **[Cln]** appears on the LCD panel while cleaning the Sensor.

Dust Removal

The dust can be removed by shaking the Sensor.

- **Start-up Action** : Removes dust in the sensor by selecting the check box (☑) in the **[Start-up Action]** using the direction buttons (◀▶).

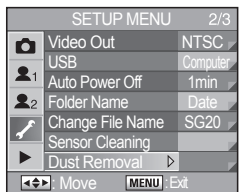

Dust Alert

Checks dust in the sensor.



Press the Shutter button.

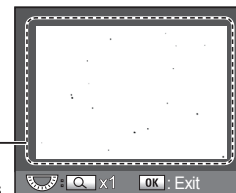

Marked area shows dust in the sensor.



- Due to the different shooting conditions, the actual image can be different from the result of the **[Dust Alert]** function. For the best result, it is recommended to place a white paper on the front of the lens and make sure all the area in the viewfinder is displayed in white.
- The result image from **[Dust Alert]** is based on the same angle of view in a way that you place the camera body in front of you and remove the lens to check the sensor.

Using the Menu

Pixel Mapping

If noise is found in the image, you can eliminate the bad pixels by using [Pixel Mapping].

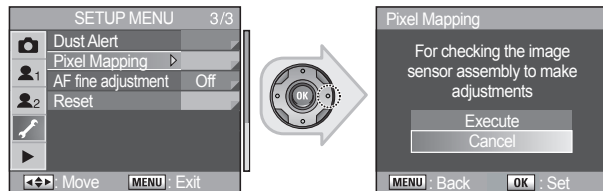

AF fine adjustment

If there is a slight difference in focusing point among lenses, users can finely adjust it by setting the AF fine adjustment function. Lenses that are registered as [All Types] and [One Type] can be adjusted. AF fine-tuning is available for up to 20 registered lenses. Lens ID is required for [AF fine adjustment].

- If add stops on (+), the current depth of field will move to the closer range of (unclear) your camera.
- If add stops on (-), the current depth of field will move to the far range of (unclear) your camera.

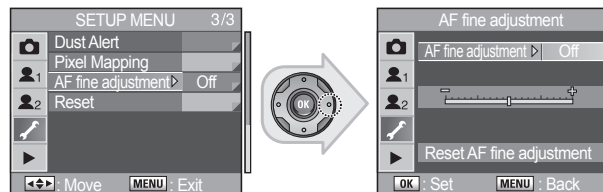

- It is recommended that you use a tripod for a more accurate set value.
- You can use the [AF fine adjustment] function as in the following images for example. Both pictures are taken while focusing on the centre area (the ball located in the centre) in the viewfinder.

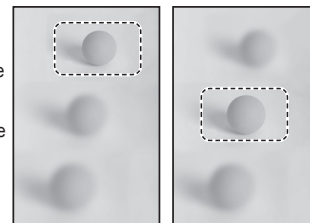

▲ AF range is far from the target you focused on.

▲ Adding stops on the plus (+), the current depth of field has moved to the target point.

Reset

Resets all settings other than [Date/Time], [Language/言語], [Video Out], [CUSTOM1 MENU], and [CUSTOM2 MENU].

- **Reset** : Resets all settings.
- **Cancel** : Does not reset camera settings.

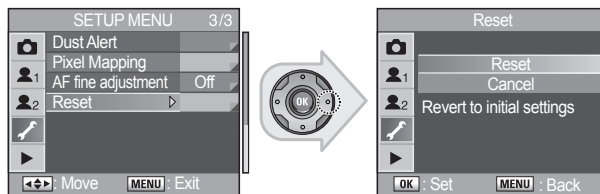

Using the Menu

Using the PLAYBACK MENU (▶)

Perform settings related to playback and editing images in the [PLAYBACK MENU] menu.

Exposure Warning

[Exposure Warning] function lets you know which area is over or under exposed while playing back images.

- **Off** : Exposed area does not blink.
- **On** : An over-exposed area during Instant Review or Playback blinks in red while an under-exposed area blinks in yellow.

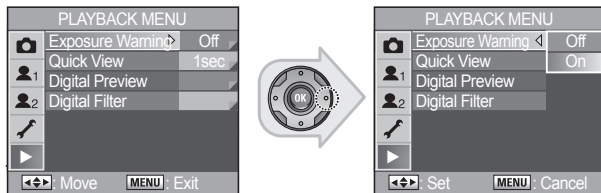

Quick View

Sets Display time, Exposure warning and Histogram.

If direction buttons (◀▶) are pressed in the [Quick View] function mode, the display changes to the Playback mode.

Display Time : [1sec], [3sec], [5sec], [Off], [Hold]

- **Histogram/Exposure Warning** : Select check boxes using the direction buttons (◀▶).

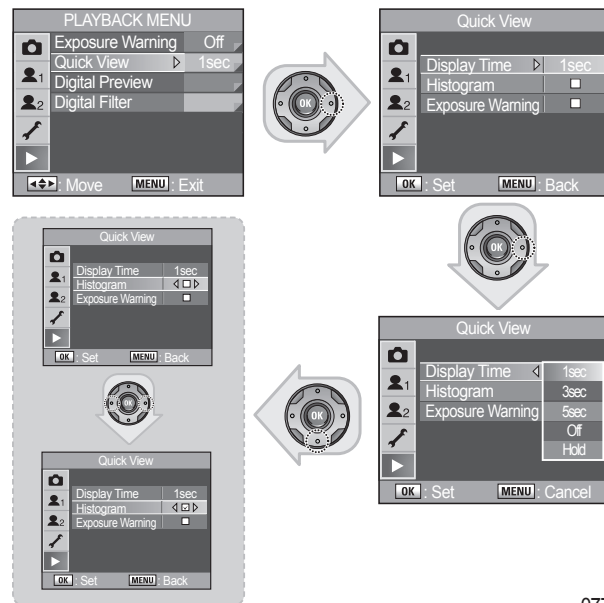

Using the Menu

Digital Preview

You can set whether or not to display the histogram and Bright/Dark area warning during Digital Preview.

- **Histogram/Exposure Warning** : Set check boxes using the direction buttons (◀▶).

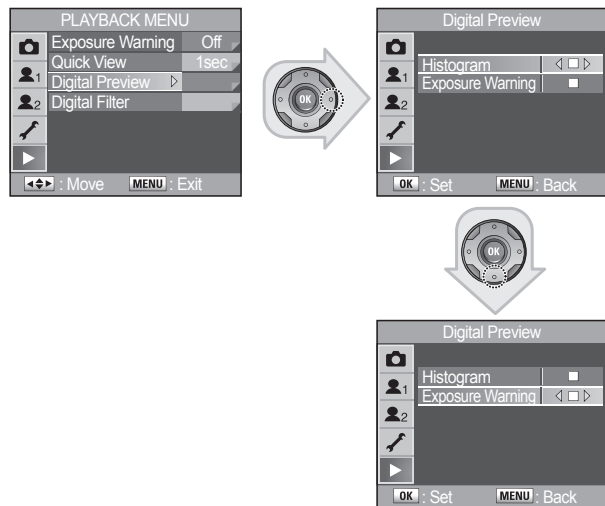

For more information about how to set **[Preview Method]**, see page 68, "Preview Method."

Digital Filter

Once you have taken a picture, you can apply black and white mode, brightness, sepia tone, and so on.

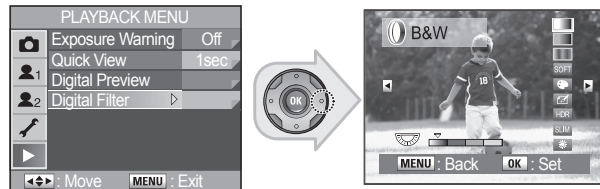

For more information about **[Digital filter]**, refer to the page 113, "Digital Filter."

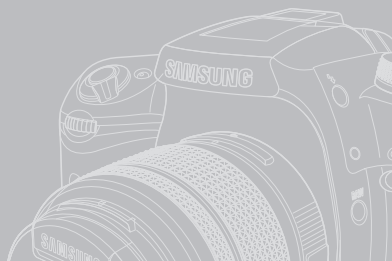

GX20

Using Advanced Shooting Modes

This chapter explains how to use the advanced shooting mode such as Tv (Shutter-Priority AE) mode, Av (Aperture-Priority AE) mode, and so on.

- 080 Using the best programmed exposure, P (Program) mode**
 - 080 P (Automatic Program Exposure) Mode
- 082 Shooting in the different exposure rates**
 - 082 Sv (Sensitivity Priority) Mode
- 083 Taking a picture of a fast-moving subject**
 - 083 Tv (Shutter Priority) Mode
- 084 Expressing the background out of focus**
 - 084 Av (Aperture Priority) Mode
- 085 Using the automatic ISO setting mode**
 - 085 TAv (Shutter & Aperture Priority) Mode
- 086 Using the manual mode to choose your own camera settings**
 - 086 M (Manual) Mode
- 087 Shooting with long time shutter speed**
 - 087 B (Bulb) Mode
- 088 Using the external flash**
 - 088 X (Flash X-Sync) Mode
- 089 Saving your own exposure setting and using the stored set value**
 - 089 User Mode
- 090 Changing the Exposure and Shooting (Auto Bracket)**
- 092 Setting the Colour Temperature**
 - 092 Setting the White Balance
 - 093 Adjusting the White Balance Manually
 - 094 Fine-Tuning the White Balance
- 096 Adjusting the sensitivity of the image sensor**
 - 096 Setting the Sensitivity
 - 096 Setting the Range of Automatic Correction in AUTO

Using the best programmed exposure, P (Program) mode

Automatically sets shutter speed and aperture to the proper exposure according to the Program line when taking pictures. This **P** (Program) mode supports both **Tv** (Shutter Priority) and **Av** (Aperture Priority) modes.

P (Program) mode is useful for taking pictures in a casual place (for families and such).



▲ **P** Mode, Aperture: $f = 8$, Shutter Speed: $1/125\text{sec}$

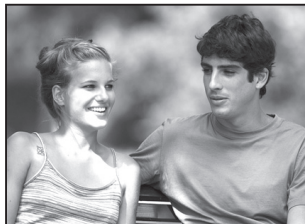

▲ **P** Mode, Aperture: $f = 2.8$, Shutter Speed: $1/1000\text{sec}$



Pictures used in this user guide are to help users understand products and the results may differ depending on the types of lenses or the shooting environment.

P (Automatic Program Exposure) Mode

1. Rotate the Mode dial (🔘) to select **P**.

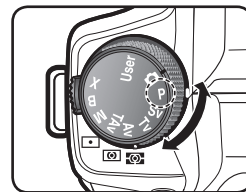

2. Check the Shutter speed and Aperture value on the viewfinder and LCD panel.

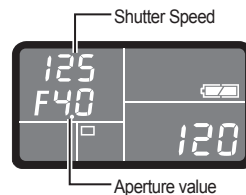

3. Now, you are ready to take a picture.



- To change the exposure, turn the front dial (🔘) while you press and hold the **Q** button.
- Set the aperture to the **A** position while holding down the autolock button when using a lens with an aperture ring.

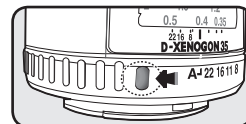

Using the best programmed exposure, P (Program) mode

P (Program) mode supports both Tv (Shutter Priority) and Av (Aperture Priority) modes.

■ To change the shutter speed

You can switch to Shutter Priority automatic exposure by turning the front dial () in P (Hyperprogram) mode.

- You can only set the shutter speed to a value that is in relation to aperture.
- If the brightness changes and the aperture value is outside the relative range, the aperture will blink in the viewfinder and on the LCD panel.





■ To change the aperture

You can switch to Aperture Priority automatic exposure by turning the rear dial () in P (Hyperprogram) mode.

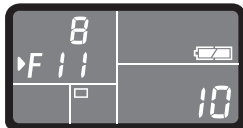
- You can only set the aperture to a value that is in relation to shutter speed.
- If the brightness changes and the shutter speed is outside the relative range, the shutter speed will blink in the viewfinder and on the LCD panel.
- Press the Green button () to return to Hyperprogram automatic exposure.



- All the program modes have different uses of the front dial () and rear dial () depending on the set values.
- When using the P (Program) mode, you can change the ISO sensitivity by using the front dial () while pressing and hold the OK button.

Shooting in the different exposure rates

Sv (Sensitivity priority) mode helps you take pictures in the different environmental lightnings that have many various brightness levels. You can set the sensitivity first and then the shutter speed and aperture are automatically set according to the selected sensitivity to obtain the appropriate exposure.

Sv (Sensitivity priority) mode is useful in low light conditions.



▲ **Sv** Mode, Aperture: $f = 5.6$,
Shutter Speed: 1/125 sec, ISO = 800



▲ **Sv** Mode, Aperture: $f = 4$,
Shutter Speed: 1/30 sec, ISO = 800

Sv (Sensitivity Priority) Mode

1. Rotate the Mode dial (📷) to select **Sv**.

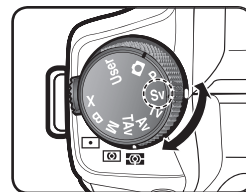

2. Turn the rear dial (🔘) and adjust the sensitivity.
- The shutter speed, aperture value and sensitivity are displayed in the viewfinder and on the LCD panel.



3. Now, you are ready to take a picture.



- Set the sensitivity in increments of 1/2 EV or 1/3 EV. Set in **[EV Steps]** in the **[CUSTOM1 MENU]** menu.
- You can not make a change to **[ISO Sensitivity]** in the Fn menu while the Sv mode is in use.

Taking a picture of a fast-moving subject

In the **Tv** (Shutter priority) mode, you can stop the moving subject or blur it as it passes across the viewfinder by using different shutter speeds. The aperture value is automatically set to give the appropriate exposure depending on the shutter speed.

The following images show that the fast shutter speed (1/250 sec) captures a stop motion of moving subject, and the slow shutter speed (1/15 sec) captures a blurred image as the subject keeps moving until the shutter closes.



▲ Tv Mode, Aperture: $f = 4$, Shutter Speed: 1/250sec



▲ Tv Mode, Aperture: $f = 16$, Shutter Speed: 1/15sec

Tv (Shutter Priority) Mode

1. Rotate the Mode dial (🔘) to select Tv.

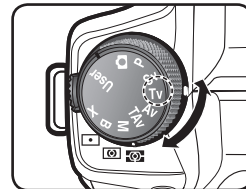

2. Turn the front dial (🔘) and adjust the shutter speed.
- The shutter speed and aperture value are displayed in the viewfinder and on the LCD panel.



3. Now, you are ready to take some pictures.

Exposure Warning

If the subject is too bright or too dark, the aperture value will blink in the viewfinder and on the LCD panel.

If the subject is too bright, choose a faster shutter speed. If it is too dark, choose a slower shutter speed.

When the aperture value indication stops blinking, you can take the picture with proper exposure. Use an ND (Neutral Density) filter if the subject is too bright. Use a flash if it is too dark.



Expressing the background out of focus

Using the **Av** (Aperture priority) mode, you can express the subject in the background out of focus. Shutter speed is automatically set to an appropriate exposure depending on the aperture value.



▲ **Av** Mode, Aperture: $f = 11$,
Shutter Speed: 1/125 sec, ISO = 200

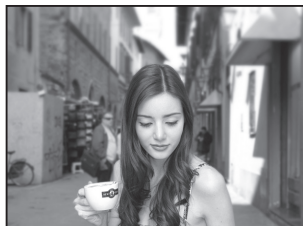

▲ **Av** Mode, Aperture: $f = 4$,
Shutter Speed: 1/1000 sec, ISO = 200

Av (Aperture Priority) Mode

1. Rotate the Mode dial (🔘) to select **Av**.

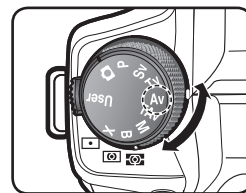

2. Turn the rear dial (🔘) and adjust the aperture value.
- The shutter speed and aperture value are displayed in the viewfinder and on the LCD panel.



3. Now, you are ready to take some pictures.

Using the automatic ISO setting mode

You can keep using the same shutter speed and aperture stop even if the brightness of the subject changes. You can set both the desired shutter speed and aperture to take the picture. Automatically sets the sensitivity so that shutter speed and aperture will give the proper exposure according to the brightness of the subject.

The next image was taken in low light conditions using a fast shutter speed of "1/125." ISO has automatically changed to "1600" without changing the shutter speed or aperture stop.



▲ **TAv** Mode, Aperture: $f = 4$,
Shutter Speed: 1/125 sec, ISO = 1600



▲ **TAv** Mode, Aperture: $f = 4$,
Shutter Speed: 1/125 sec, ISO = 3200

TAv (Shutter & Aperture Priority) Mode

1. Rotate the Mode dial (📷) to select **TAv**.

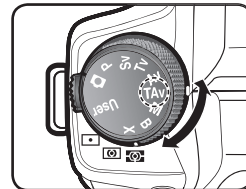

2. Turn the front dial (📷) and adjust the shutter speed.



3. Turn the rear dial (📷) and adjust the aperture value.
- The shutter speed, aperture value and sensitivity are displayed in the viewfinder and on the LCD panel.
4. You can set the automatic ISO sensitivity range while using the TAv shooting mode.
- Press the **Fn** button on the rear body of the camera, and then use the rear dial (📷) to adjust the automatic ISO sensitivity range.
5. Now, you are ready to take some pictures.

Using the manual mode to choose your own camera settings

You can select your own exposure settings for the shutter speed, aperture stop, and ISO set value.

Pressing the green button (⊙) on your camera automatically sets the exposure for the appropriate brightness while using the **M** (Manual) mode.



▲ Before setting the exposure using the green button (⊙).



▲ After setting the exposure using the green button (⊙).

M (Manual) Mode

1. Rotate the Mode dial (⊙) to select **M**.
2. Set your own exposure value for the shutter speed and aperture using the front dial (⊙) and rear (⊙) dials.

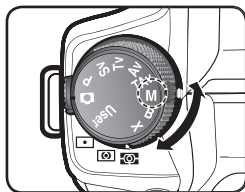

3. Set your own ISO sensitivity value using the **Fn** > direction button (▶).

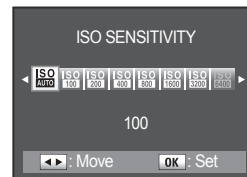

4. Now, you are ready to take some pictures.

EV Bar

The EV bar appears in the LCD panel and viewfinder in **M** (Manual) mode. The appropriate exposure is set when **V** is in the middle of the EV bar. If it is towards **-**, it is underexposed. If it is towards **+**, it is overexposed. If the value exceeds the range of the EV bar, the **+** or **-** blinks.



▲ EV Bar

AE-L in M mode

Press the **AE-L** button (⊙) to record the exposure value in **M** (Manual) mode. If the shutter speed or aperture is then changed, the combination of shutter speed and aperture changes while exposure is retained.

Example) If the shutter speed is 1/125 sec and aperture is F5.6 and is recorded with the **AE-L** button (⊙), and the shutter speed is changed to 1/30 sec with the front dial (⊙), the aperture automatically changes to F11.

Shooting with long time shutter speed

You can use long time shutter speed using the **B** (Bulb) mode.

B (Bulb) mode is useful for the pictures of fireworks and other night time shots. The next images are taken while using the **B** (Bulb) mode with a long shutter speed.



▲ **B** Mode, Aperture: f = 11,
Shutter Speed: 2.5 sec, ISO = 100



▲ **B** Mode, Aperture: f = 11,
Shutter Speed: 10 sec, ISO = 100

B (Bulb) Mode

1. Rotate the Mode dial (🔘) to select **B**.

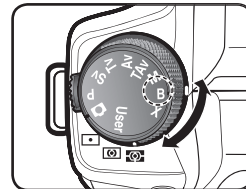

2. Turn the rear dial (🔘) and adjust the aperture value.
3. The shutter will remain open for as long as you keep the shutter button pressed down. Do not release the shutter button until it reaches the exposure time.
4. As soon as you release the shutter button, shooting is complete.



- Use a sturdy tripod and the cable switch (sold separately) to prevent camera shake when using **B** (Bulb) mode. Connect the cable switch to the cable switch terminal.
- Bulb shooting is available when using the remote control shooting mode. The shutter remains open as long as the shutter release button of the optional remote control is held down.
- Noise reduction is a process to reduce noise (image roughness or unevenness) caused by low shutter speed. Set [**Noise Reduction**] in the [**CUSTOM1 MENU**] menu.
- A shutter speed longer than 10 minutes may cause noise to images. (Caused by the long time exposure)
- When using the long time shutter, it may take longer to save images after the shooting. You do not have to change the battery since this is not a problem of the product.

Using the external flash

X (Flash X-Sync) Mode

The shutter speed is locked at 1/180 second. Use this when using an External flash that does not automatically change the shutter speed.

1. Rotate the Mode dial (🕒) to select X.

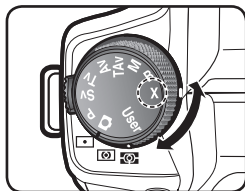

2. Connect the external flash to your camera.
- For more information about using the external flash, refer to the user guide on external flash.
3. Now, the flash fires as soon as you press the shutter button.



- Turn the rear dial (🔘) to adjust the aperture value.
- Press the green button (🟢) to retain the shutter speed at 1/180 sec and automatically adjust the aperture.
- When the sensitivity is set to 📷 (Auto mode) and exposure mode is set to X (Flash X-Sync) mode, the sensitivity is set to the minimum value set on the "Setting the Range of Automatic Correction in AUTO".

Saving your own exposure setting and using the stored set value

User Mode

Uses the exposure value you saved in the [CAPTURE MENU] > [User Registration]. For more information about the [User Registration] function, see page 57, "User Registration".

1. Rotate the Mode dial (🕒) to select **User**.
- The exposure value you saved in the [User Registration] appears on the LCD monitor.

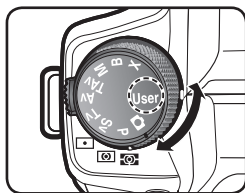

2. Now, you are ready to take some pictures.

Changing the Exposure and Shooting (Auto Bracket)

You can take continuous pictures with different exposure when the shutter release button is pressed. The first frame is exposed with no compensation, the second frame is under-exposed (negative compensation) and the third is over-exposed (positive compensation).





▲ Normal exposure



▲ Under exposure

▲ Over exposure

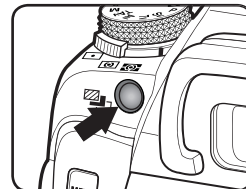

You can set **[Bracketing Order]** in the **[CUSTOM2 MENU]** menu.

1. Set the number of frames.
 - Turn the front dial () while pressing the exposure bracket button (). Select 3 or 5.

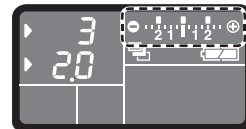
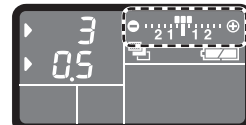

2. Set the step interval. Turn the rear dial () while pressing the exposure bracket button (). You can change the available bracketing amounts by setting the **[EV Steps]** in the **[CUSTOM1 MENU]**.



3. Press the shutter release button halfway.
 - Focus indicator () appears in the viewfinder when focused.
4. Press the shutter release button fully.
 - If you set **[No. of Shots]** to "3," the first frame is exposed with no compensation, the second frame is under-exposed (negative compensation) and the third is over-exposed (positive compensation).
5. If you want to cancel the auto bracket function, set the number of shots to **OFF** using the front dial. Press and hold the exposure bracket button () while using the front dial ().

Changing the Exposure and Shooting (Auto Bracket)



- When the focus mode is set to **SAF** (Single mode), the focus is locked in the first frame position and used for subsequent consecutive frames.
- The auto bracketing exposure setting will remain effective for twice as long as the exposure metering timer (default setting is 20 seconds) when you release your finger from the shutter release button during auto bracketing, and you can take the next picture at the next compensation value. In this case, auto focusing works for each frame. After about twice as much time as the exposure metering timer (default setting is 20 seconds), the camera returns to settings for taking the first picture.
- You can combine Auto Bracket with the built-in flash or external flash (P-TTL auto only) to change only the flash output continuously. However, when using an external flash, holding the shutter release button down to take three continuous frames may cause the second and third frame to be taken before the flash is fully recharged. Always take one frame at a time after confirming that charging is complete.
- Auto Bracket is not available when the exposure mode is set to  (Auto mode) and **B**(Bulb) mode.







Taking Only Over Exposed or Under Exposed Pictures are Possible by Using the Auto Bracket Function.

With the previously compensated set of the exposure value, you can have the under exposure or over exposure shots only.

Setting the Colour Temperature

Setting the White Balance

The colour of the subject changes with the light source. For example, the same white object will be a different shade of white in daylight than under a light bulb. In cameras using film, this is adjusted by changing the film or using filters. In digital cameras, the whiteness is adjusted using white balance.

AWB	Auto	Automatically adjusts the white balance. (About 4000 to 8000K)
	Daylight	For use when taking pictures in sunlight. (About 5200K)
	Shade	For use when taking pictures in the shade. It reduces the bluish colour tones in a picture. (About 8000K)
	Cloudy	For use when taking pictures on cloudy days. (About 6000K)
	Fluorescent Light	For use when taking pictures under fluorescent lighting. Select the type of fluorescent light, from W (white) (About 4200K), N (neutral white) (About 5000K), and D (daylight) (About 6500K).
	Tungsten Light	For use when taking pictures under light bulb or other tungsten light. It reduces the reddish colour tones in a picture. (About 2850K)
	Flash Light	For use when taking pictures using the built-in flash. (About 5400K)
	Manual	Use this to manually adjust the white balance according to the lighting so that white objects appear as a natural white.
K	Colour Temp. 1, 2, 3	Use this to set the colour temperature in figures. You can save three settings.



- The Colour Temperature (K) is an estimate. This does not indicate precise colours.
- The colour temperature step can be set in the [Colour Temp. Unit] of the [CUSTOM1 MENU].

Colour Temperature

The colour of light shifts towards blue as the colour temperature rises, and towards red as the colour temperature falls. Colour temperature describes this change in light colour in terms of absolute temperature (K: Kelvin). This camera is capable of setting the white balance to enable taking pictures with natural colouring under a variety of lighting conditions.

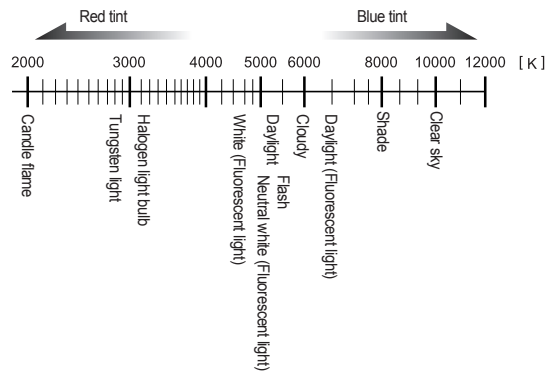

1. Press the **Fn** button.
- The Fn menu appears.

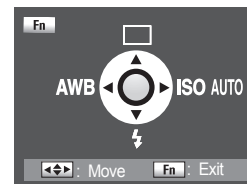

Setting the Colour Temperature

- Press the direction button (◀) on your camera.
- The White Balance screen appears.

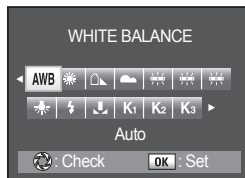

- Press the direction buttons (↔) to select a desired white balance.
- After selecting a desired White Balance rotate the main switch to Ⓞ. You can check the previous White Balance.

- Press the direction buttons (↔) to select Ⓞ (Manual).

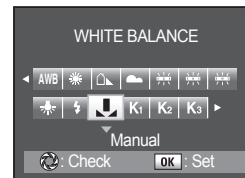

- Press the direction button (▼).
- The Fine-Tuning screen appears.



- Fully display a white or gray sheet of paper in the viewfinder under the light to adjust white balance.

- Press the shutter release button fully.
-The menu as shown will display.
-Slide the focus mode lever to **MF** if the shutter cannot be released.



Adjusting the White Balance Manually

You can adjust the white balance depending on the light source when taking pictures. With Manual White Balance, the camera can store delicate shades that cannot be precisely adjusted with the white balance preset values provided in the camera. This provides the optimum white balance for your surroundings.

- Press the **Fn** button.
- The Fn menu appears.
- Press the direction button (◀) on your camera.
- The White Balance screen appears.

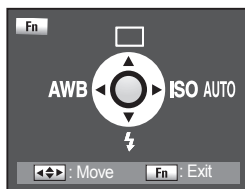

The position of Custom white balance can be changed by the rear dial (⌘). You can select a desired white balance by using the direction buttons (↔).

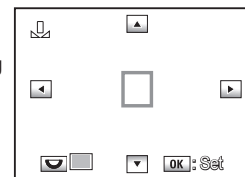

Setting the Colour Temperature

- Press the **OK** button
 - The White Balance adjustment menu will display.
 - Press the **OK** button again to save the setting.



- Images are not saved if you fire (unclear) the shutter button.
- Press the **Fn** button when adjustment is unsuccessful to set again.
- If picture is extremely overexposed or underexposed, white balance may not be adjusted. In this case, set an appropriate exposure and re-adjust the white balance.

Fine-Tuning the White Balance

- Press the **Fn** button.
 - The Fn menu appears.

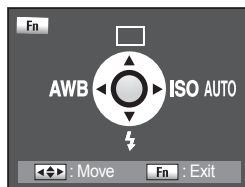

- Press the direction button (**←**) on your camera.
 - The White Balance screen appears.

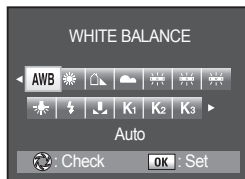

- Press the direction buttons (**←**) to select a desired white balance.
 - (Example : **Daylight**)

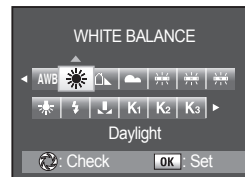

- After selecting a desired White Balance rotate the main switch to **☉**. You can check the previous White Balance.



- Press the direction button (**▲**).
 - The White Balance fine tune screen appears.

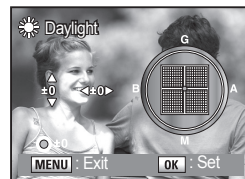

Setting the Colour Temperature

5. Press the direction buttons (↑↓) to fine tune the White Balance. Seven levels and 196 patterns are available on the **G-M** and **B-A** axes.

- **G** : Green
- **M** : Magenta
- **B** : Blue
- **A** : Amber



- If the green button (G) is pressed during the White Balance setting, the White Balance value is set to default (±0).
- When the COLOR TEMP. UNIT (K1, K2, K3) is change after selecting the colour temperature, the following menu will display. Change the menu with the front dial (↶↷) and rear dial (↵).
- Set [Fine tune when AWB] in [CUSTOM1 MENU] to [On] when fine-tuning in AWB.



GM compensation	▲▼	Adjust the color values between the green and magenta.
BA compensation	◀▶	Adjusts the tone of the colours between blue and amber.

6. Press the **OK** button.
-The White Balance fine tune screen appears.

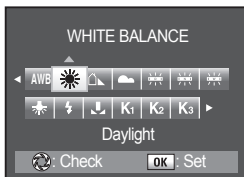

7. Press the **OK** button twice.
-The camera is ready to take a picture with the set White Balance.

Adjusting the sensitivity of the image sensor

Setting the Sensitivity

You can set the sensitivity to suit the brightness of the surroundings. The sensitivity can be set to [AUTO 100-400] or within a sensitivity range equivalent to ISO [100] to [6400].

1. Press the **Fn** button.
- The Fn menu appears.

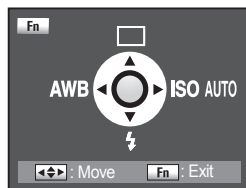

2. Press the direction button (▶) on your camera.
- The ISO sensitivity menu appears.

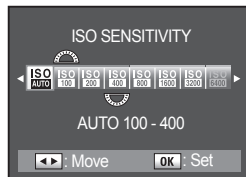

3. Press the direction buttons (◀▶) to select a desired sensitivity.

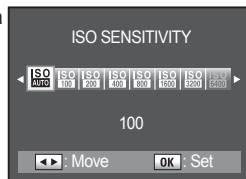

- Captured images can show more noise if higher Sensitivity is set.
- Set this menu in [CUSTOM1 MENU] > [ISO Steps].
- If [Set Max ISO Range] is set to [6400] in the [CUSTOM1 MENU], ISO sensitivity can be set to 6400.
- It is possible to see more noise in the images when setting the ISO sensitivity to "6400."

Setting the Range of Automatic Correction in AUTO

Set range to automatically correct sensitivity when Sensitivity is set to [AUTO]. The sensitivity is automatically corrected in the range of [AUTO 100-400] by default. You can set the changeable ISO range for automatic correction using the Fn menu.

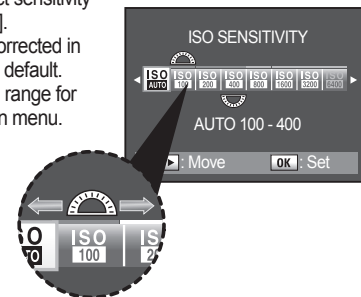

Front dial		Sets the lower sensitivity limit.
Rear dial		Sets the upper sensitivity limit.



- When the camera is set to the following conditions, the sensitivity cannot be set to auto.
- The exposure mode is set to **Sv** (Sensitivity Priority), **M** (Manual), **B** (Bulb) or **X** (flash synchro) mode.

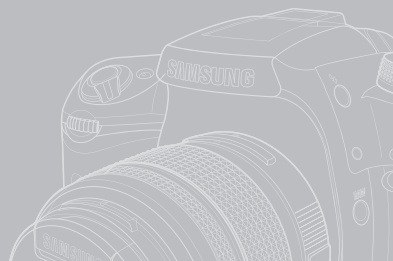

GX20

Using the Flash

This chapter explains how to take a picture in a dark place using the flash.

- 098 Using the Built-in Flash**
- 098 Selecting Flash Mode
- 099 Using Auto Discharge
- 100 Using Fill-in Flash
- 100 Using Red-eye Reduction Flash
- 101 Front curtain sync, Rear curtain sync
- 101 Daylight-Sync Shooting
- 102 Compensating Flash Output
- 102 Flash Characteristics in Each Exposure Mode
- 103 Using Slow-Speed-Sync
- 104 Distance and Aperture when Using the Built-in Flash
- 104 Calculating Aperture Value from Shooting Distance
- 104 Calculating Shooting Distance from Aperture Value
- 105 Using an External Flash (Sold Separately)**
- 105 About the LCD Panel Display for SEF-36PZF
- 106 Using P-TTL Auto Mode
- 106 Using High-Speed Flash Sync Mode
- 107 Using in Wireless Mode
- 107 Red-Eye Reduction
- 108 Using the external flash sync terminal

Using the Built-in Flash

If you wish to discharge the flash in a dark or backlit location, press the flash button (⚡) to pop up the flash. Select a **[Flash]** mode to suit your purpose from the Flash options screen in the Fn menu. You can adjust the flash output with the rear dial (🌀) in any Exposure mode other than Auto mode. The built-in flash is optimum from about 0.7 m to 4 m from the subject. Exposure will not be properly controlled and vignetting may occur when used at a distance closer than 0.7 m. This distance varies slightly depending on the lens being used and set sensitivity).

Compatibility of built-in flash and lens

Vignetting (darkening of the corners of the image due to a lack of light) may occur depending on the lens being used and the capture conditions. We recommend taking a test shot to confirm this.



- When using the built-in flash, remove the lens hood before shooting.
- The built-in flash fully discharges for lenses without a function to set aperture lens ring to **A** (Auto).

⚡ ^A	Auto	Discharges the flash automatically in dark or backlit locations.
⚡	Fill-In	The built-in flash discharges manually. When the pop-up flash is closed, the flash doesn't discharge. When the flash is opened, the flash will discharge.
⚡ ^A 🌀	Auto +Red-eye	Lights a red-eye reduction light before automatic flash.
⚡🌀	Fill-In + Red-eye	The built-in flash discharges manually. Lights a red-eye reduction light before manual flash.
⚡ ^S	1st Curtain Sync.	Sets the shutter speed to capture the background clearly.
⚡ ^S 🌀	1st Curtain + Red-eye	The lights a red-eye reduction light before automatic flash.
⚡ ^S 🌀 ^{IR}	2nd Curtain Sync.	Discharges flash immediately before closing the shutter curtain.
⚡ ^W	Wireless Mode	Controls external flash(SEF-54PZF or SEF-36PZF) through wireless connection and fires the built-in flash as master. (or the controller.)





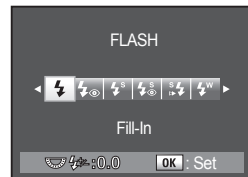
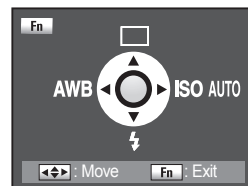



Selecting Flash Mode

1. Press the **Fn** button.
 - The Fn menu appears.
2. Press the direction button (▼) on your camera.
 - The flash options screen appears.
3. Press the direction buttons (◀▶) to select **[FLASH]** mode.
 - Pressing the green button (⊙) resets the exposure value if you have made the exposure compensation to the flash.
4. Press the **OK** button twice.
 - The camera returns to a capture mode.



Using the Built-in Flash



Available flash mode, by recording mode (O: Selectable, X: Not selectable)

	Auto	P	Sv	Tv	Av	TAv	M	B	X	User
 Auto	O	X	X	X	X	X	X	X	X	X
 Fill-In	X	O	O	O	O	O	O	O	O	O
 Auto +Red-eye	O	X	X	X	X	X	X	X	X	X
 Fill-In + Red-eye	X	O	O	O	O	O	O	O	O	O
 1st Curtain Sync.	X	O	O	X	O	X	X	X	X	O
 1st Curtain + Red-eye	X	O	O	X	O	X	X	X	X	O
 2nd Curtain Sync.	X	O	O	O	O	O	O	O	X	O
 Wireless Mode	X	O	O	O	O	O	O	O	O	O



In the **User** mode, the available flash may be changed by the exposure mode.

Using Auto Discharge

Using the auto discharge function, the flash fires under low light conditions in auto mode.

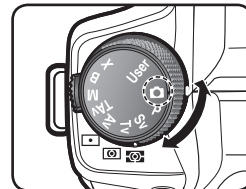
1. Rotate the Mode dial () to select  (Auto mode).



2. Press the flash () button.
 - The built-in flash pops up if necessary and begins charging. When the flash is fully charged,  appears in the LCD panel and viewfinder.

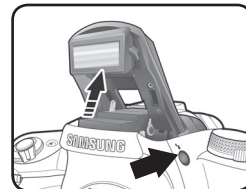

3. Press the shutter release button halfway.
 - The focus indicator () appears in the viewfinder when focused.

4. Press the shutter release button fully.
 - The picture is taken.

5. Push down on the portion indicated in the illustration to retract the flash.

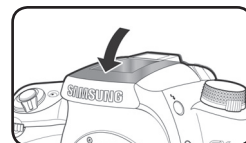



Using the Built-in Flash

Using Fill-in Flash

Using the **[Fill-In]** flash mode, the flash fires regardless the environmental light conditions. You can effectively use this flash mode when photographing against the light.

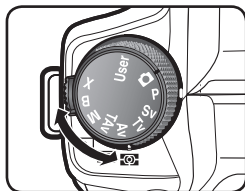
1. Rotate the Mode dial () to any recording mode except for the  (Auto mode).



2. Press the flash () button.
- The built-in flash pops up if necessary and begins charging. Regardless of the Flash mode, the Fill-in flash will be selected. When the flash is fully charged,  appears in the LCD panel and viewfinder.

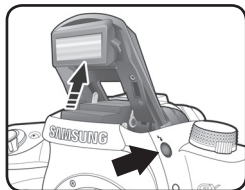

3. Press the shutter release button halfway.
- The focus indicator () appears in the viewfinder when focused.

4. Press the shutter release button fully.
- The picture is taken.



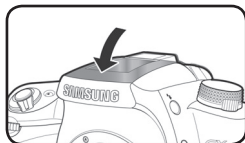

5. Push down on the portion indicated in the illustration to retract the flash.



Using Red-eye Reduction Flash

"Red-eye" is the phenomenon where eyes look reddish in photographs taken in dark environments with a flash. This is caused by the reflection of the electronic flash from the retina of the eye. Red-eye occurs because pupils are dilated in dark environments. This phenomenon cannot be averted but the following measures can be used to combat it.

- Brighten the surroundings when shooting.
- If using a zoom lens, set it to wide-angle and move in closer to your subject.
- Use a flash that supports red-eye reduction.
- Avoiding the direct use of external flash may reduce the "red-eye" in pictures.

The red-eye reduction function on this camera reduces red-eye by discharging the flash twice. With the red-eye reduction function, the pre-flash is discharged just before the shutter is released. This reduces pupil dilation. The main flash is then discharged while the pupils are smaller, reducing the red-eye effect. To use the red-eye reduction function, set **[Auto+Red-eye()]** in Auto mode () and **[Fill-In+Red-eye()]** or **[1st Curtain Sync.+Red-eye()]** in other modes.

Using the Built-in Flash

Front curtain sync, Rear curtain sync

The next example shows the difference between front curtain sync and rear curtain sync. Rear curtain sync is used to freeze motion at the end of the exposure in a sharp image.

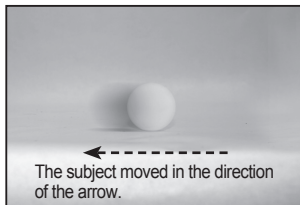

▲ 1st Curtain Sync., Tv Mode,
Aperture: f = 8, Shutter Speed: 1/15sec

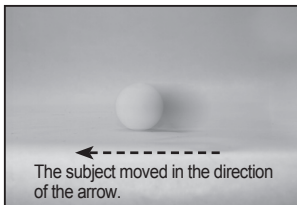

▲ 2nd Curtain Sync., Tv Mode,
Aperture: f = 8, Shutter Speed: 1/15sec

Daylight-Sync Shooting

Because of the different directions of the lights, you may find some unexpected shadow even in the daylight condition. You can reduce the shadow on the subject by using the built-in flash. Use of the flash in this way is called Daylight-Sync Shooting. Flash is discharged manually when shooting with Daylight-Sync Shooting.

1. Confirm that the flash has popped up and the [FLASH] mode is set to [Fill-In] Flash.
2. Confirm that the flash is fully charged.
3. Take the picture.



The picture may be over-exposed if the background is too bright.



▲ Without Daylight-Sync



▲ With Daylight-Sync

Using the Built-in Flash

Compensating Flash Output

You can change the flash output in a range of -2.0 to +1.0. The Flash Compensation values are as follows for 1/2 EV and 1/3 EV.



Step interval	Flash Compensation
1/2 EV	-2.0, -1.5, -1.0, -0.5, 0.0, +0.5, +1.0
1/3 EV	-2.0, -1.7, -1.3, -1.0, -0.7, -0.3, 0.0, +0.3, +0.7, +1.0

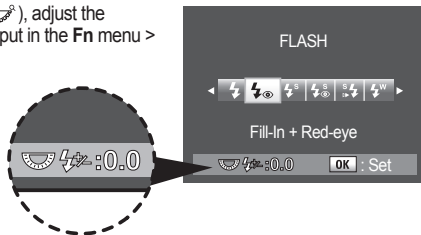

Set interval of steps in [EV Steps] in the [CUSTOM1 MENU] menu.

- ▶ Using the rear dial (), adjust the compensating flash output in the Fn menu > [FLASH].



-  blinks in the viewfinder when the flash pops up during Flash Compensation.
- Compensating flash output is not available while using the  (Auto mode).
- If the maximum flash output is exceeded when corrected to the plus (+) side, no compensation will be effective.
- Compensating to the minus (-) side may not effect the image if the subject is too close, aperture is low or sensitivity is high.

Flash Characteristics in Each Exposure Mode

- Using the Flash in Tv (Shutter Priority) Mode
 - When taking a moving subject, you can use the flash to change the blur effect.
 - Within the shutter speed limit of “1/180” sec or slower, you can use the built-in flash for shooting.
 - The aperture value automatically changes according to the ambient brightness.
- Using the Flash in Av (Aperture Priority) Mode
 - You can set the desired aperture to take a flash photograph when you want to change the depth of field or shoot a subject farther away.
 - The shutter speed automatically changes with the ambient brightness.
 - The shutter speed shifts automatically anywhere from 1/180 sec. to a slow shutter speed that reduces camera shake. The slowest shutter speed depends on the focal length of the lens in use.

Using the Built-in Flash

Using Slow-Speed-Sync

When you take a picture in low light condition to the background, you may find the difference in the exposure between the subject and the background. You can have the bright background as same as the subject using the slow shutter speed when firing the flash.



- Slow-speed-sync slows the shutter speed. Use a tripod or OIS to avoid camera shake. The picture will also blur if the subject moves.
- Slow-speed-sync shooting can also be performed with an external flash.

You can see that the background is as bright as the subject in the example shown. (slow speed sync was used in low light conditions.)



▲ Tv Mode, Aperture: $f = 8$, Shutter Speed: $1/15\text{sec}$

■ Using Tv (Shutter Priority) Mode

1. Rotate the Mode dial (📷) to select **Tv**.
 - **Tv** (Shutter Priority) mode is set.
2. Rotate the front dial (📷) to set the desired shutter speed.
 - The background is not properly corrected if aperture value is flashing when shutter speed is set. Set the shutter speed so that aperture does not flash.
3. Press the flash (📷) button.
 - The flash pops up.
4. Take the picture.

■ Using M (Manual) Mode

1. Rotate the Mode dial (📷) to select **M**.
 - **M** (Manual) mode is set.
2. Set the shutter speed (under $1/180\text{sec}$) and aperture value to obtain correct exposure.
3. Press the flash (📷) button.
 - The flash pops up.
4. Take the picture.

Using the Built-in Flash

Distance and Aperture when Using the Built-in Flash

- A set criteria is necessary between the guide number, aperture and distance when shooting with the flash. Calculate and adjust the shooting conditions if flash is not sufficient.
- Built-in flash guide number

Sensitivity	Built-in flash guide number
ISO 100	13
ISO 200	18.4
ISO 400	26
ISO 800	36.7
ISO 1600	52

Calculating Aperture Value from Shooting Distance

The following equation calculates the aperture value for shooting distances.

Aperture Value Used $F = \text{Guide number} \div \text{Shooting distance}$

Example)

When sensitivity is [ISO 200] and shooting distance is 6.1 m, aperture value is:
 $F = 18.4 \div 6.1 = 3$

If the resulting number (3, in the above example) is not available as a lens aperture, the smaller number that is closest (2.8, in the above example) is generally used.

Calculating Shooting Distance from Aperture Value

- The following equation calculates the distance of the flash for aperture values.

Maximum flash distance $L1 = \text{Guide number} \div \text{Selected aperture}$

Minimum flash distance $L2 = \text{Maximum flash distance } L1 \div 5^*$

* The value 5 used in the formula above is a fixed value which applies only when using the built-in flash alone.

Example)

When sensitivity is [ISO 200] and aperture value is F4

$L1 = 18.4 \div 4 = \text{approx. } 4.6 \text{ (m)}$

$L2 = 4.6 \div 5 = \text{approx. } 0.9 \text{ (m)}$

Therefore, the flash can be used in a range of about 0.9 m to 4.6 m. The flash cannot be used when the distance is less than 0.8 m. When the flash is used at closer than 0.8 m, it causes vignetting in the picture corners, light is distributed unevenly and the picture may be over-exposed.

Using an External Flash (Sold Separately)

Using the optional external flash (SEF-54PZF, SEF-36PZF) enables a variety of flash modes, such as P-TTL auto flash mode, high-speed flash sync mode, and wireless mode. See the chart below for details.

(O: Available, X: Not available)

- See the external flash operating manual for details.



The following information is about using the external flash (SEF-54PZF or SEF-36PZF).

Camera Function	Flash	Built-in Flash	SEF-36PZF/ SEF-54PZF
Red-eye reduction flash		O	O
Automatic flash discharge		O	O
After the flash is charged, the camera automatically switches to the flash sync speed.		O	O
Aperture is automatically set in P (Program) mode and Tv (Shutter Priority) mode.		O	O
P-TTL auto flash (appropriate sensitivity: 200 to 3200)		O	O
Slow-speed sync		O	O
Flash exposure compensation		O	O
AF illuminator		O	O
Rear curtain sync flash*1		O	O
Contrast-control-sync flash mode*2		O	O
Slave flash		X	O
Multi Flash		X	X
High-speed flash sync		X	O
Wireless flash*3		O	O

*1 : Shutter speed of 1/90 sec. or slower.

*2 : Available for wireless mode.

*3 : One or more SEF-54PZF or SEF-36PZF units are required.

About the LCD Panel Display for SEF-36PZF

The SEF-36PZF will automatically convert the field angle differential between 35 mm format and the GX-20 depending on the focal length of the lens you are using.

Lens focal length	77mm or longer	50mm	35mm	28mm	24mm	20mm	18mm
SEF-36PZF LCD panel	58mm	48mm	34mm	24mm	19mm	16mm	





Using an External Flash (Sold Separately)

Using P-TTL Auto Mode

Use this flash mode with the SEF-36PZF or SEF-54PZF flash unit. When flash mode is set to [P-TTL auto], the flash pre-fires right before taking pictures using 16-segment metering and allows more precise control. P-TTL auto mode is available with SEF-54PZF and SEF-36PZF models while using a wireless connection.



1. Remove the cover of the hot shoe and attach the external flash (SEF-36PZF or SEF-54PZF).
2. Turn on the external flash.
3. Using the external flash, P-TTL mode is automatically set to use.
4. Confirm that the external flash is fully charged and then take the picture.



- P-TTL auto is only available with the SEF-36PZF or SEF-54PZF flash unit.
- The  will light in the viewfinder when the flash is ready (fully charged).
- For details such as operation method and effective distance, please read the external flash manual.
- The flash does not discharge when the subject is bright enough when Flash Mode is [Auto ()] or [Auto+Red-eye ()]. Therefore, it may not suitable for daylight-sync shooting.
- Never press the flash pop up button() when any external flash unit is attached to the camera. The built-in flash will hit the external flash.
- See the SEF-36PZF or SEF-54PZF operating manual for details.

Using High-Speed Flash Sync Mode

With the SEF-36PZF or SEF-54PZF, you can discharge the flash to take a picture at a shutter speed faster than 1/180 second. More than two external flashes are required for a wireless connection.

- Attaching and Using the SEF-36PZF or SEF-54PZF on the Camera
 1. Remove the hot shoe cover and attach the external flash (SEF-36PZF or SEF-54PZF).
 2. Rotate the Mode dial () to select **Tv** or **M**.
 3. Turn on the Camera and external flash.
 4. Set the external flash sync mode to HS  (high-speed flash sync.).
 5. Confirm that the external flash is fully charged and then take the picture.



- The  will light in the viewfinder when the flash is ready (fully charged).
- High-speed flash sync is only available when the shutter speed is faster than 1/180sec.
- High-speed flash sync is not available when the exposure mode is set to **B** (Bulb).
- See the SEF-36PZF or SEF-54PZF operating manual for details.

Using an External Flash (Sold Separately)

Using in Wireless Mode

Wireless flash mode is available for the SEF-54PZF or SEF-36PZF models. You do not have to connect the camera with a flash sync cord.



- Be sure to set the two SEF-36PZF / SEF-54PZF units to the same channel.
- See the SEF-36PZF or SEF-54PZF operating manual for details.

■ In Wireless Mode

1. Place the SEF-36PZF / SEF-54PZF in the desired location. Set the flash mode to **SLAVE1** and then select **CH**.
* See the external flash operating manual for details.
2. Place the external flash where you want it to be. (The external flash must be set to **SLAVE1** in the wireless mode.)
3. Rotate the Mode dial (🕒) to select exposure mode (P, Sv, Tv, Av, TAv, M).
4. Set your camera to [**Wireless Mode**].
5. The flash fires as you press the shutter button.



- To use the external flash as master, set [**Flash in Wireless Mode**] to [**On**] in the [**CUSTOM1 MENU**]. If set to [**Off**], the external flash is used as controller.
- Using wireless connection, built-in flash fires whether you connect the external flash to your camera if the built-in flash is set to master.
- Built-in flash is only used as controller in wireless mode if set as controller.

Wireless Flash Control (P-TTL Flash Mode)

Using the wireless flash sync, the following information is exchanged between the two SEF-36PZF / SEF-54PZF flash units until the flash fires.

Press the shutter release button fully.

1. The camera's flash discharges a pre-flash (the camera's flash mode is transmitted).
2. The external flash unit discharges a pre-flash (the subject's lighting condition is checked).
3. The camera's flash unit discharges a pre-flash (the required flash output is transmitted to the external flash).
4. The external flash discharges the main flash.

Red-Eye Reduction

As with the built-in flash, red-eye reduction is available with an external flash.



- The red-eye reduction feature works even when only an external flash is used.
- The red-eye reduction function is not available while **SLAVE1** is set in the wireless mode. Please do not use the red-eye reduction function in the **SLAVE2** mode.
- For information about setting **SLAVE2** in wireless flash sync, see the SEF-36PZF / SEF-54PZF operating manual.

Using an External Flash (Sold Separately)

Using the external flash sync terminal

You can contact an external flash to the camera by using the External flash-sync terminal.

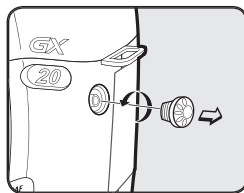

- The use of high-voltage or high-current external flashes may cause a camera breakdown.
- When using the external flash-sync terminal, the shooting information of the camera is not shared with the connected device.
- It is recommended to take a test shot to prevent from darkening of the corners of the image due to a lack of light.
- If not used, please attach the External flash-sync terminal tab to prevent from dust.

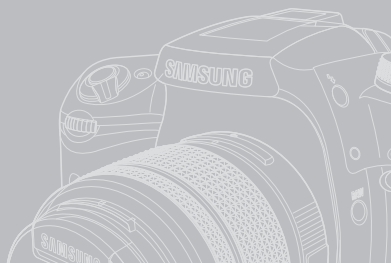

GX20

How to Playback the Images

Explains how to view or delete the picture images including how to view images in thumbnail view on LCD monitor.

110 Playing Back Still Pictures

- 110 Rotating Images
- 111 Displaying Multiple Images
- 111 Selecting the Number of Images to Display
- 111 Displaying a Folder
- 112 Slideshow
- 113 Digital Filters
- 115 Converting RAW files to JPEG format

116 Deleting Images

- 116 Deleting a Single Image
- 116 Deleting All Images
- 117 Deleting Selected Images (from Nine-Image Display)
- 117 Deleting Folders
- 118 Deleting images taken with the RAW+ button
- 119 Protecting a Single Image
- 119 Protecting All Images

120 Connecting the Camera to AV Equipment

Playing Back Still Pictures

This chapter explains how to playback still pictures.

1. Press the playback button (▶).
- The most recently captured image (image with the largest file number) is displayed on the LCD monitor.



2. Once images disappear on the LCD monitor, you can playback the images or rotate them on your LCD monitor.

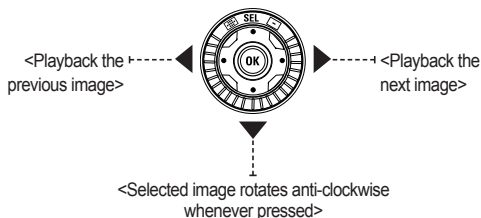

Rotating Images

1. Press the playback button (▶).
- The most recently captured image (image with the largest file number) is displayed on the LCD monitor.



2. While playing back images, you can enlarge or move the viewing area by using the following buttons:
 - Rear dial (◀) : Enlarges, or reduces the enlarged image.
 - Front dial (▶) : Plays back the next image keeping the enlarged size.
 - Direction buttons (⬅➡) : Moves the viewing area.
 - **OK** button : Resets the size to normal.



- When an image is played back, press the **INFO** button. The recording information will be changed as follows.
- If you press the **OK** button once you rotate the playback image and the rotation information is saved.

Playing Back Still Pictures

Displaying Multiple Images

You can display 4, 9 or 16 images on the LCD monitor at the same time.

1. Press the playback button (⏮).
 - The most recently captured image (image with the largest file number) is displayed on the LCD monitor.



2. Turn the rear dial (☺) to the left (⏮).
 - The multi-image display screen appears. Up to 16 thumbnail images will be displayed at once. Press the direction buttons (⬅️➡️) on your camera to select an image. A scroll bar appears at the right of the screen. [?] appears for an image that cannot be displayed.



3. Turn the rear dial (☺) to the right (⏭) or press the OK button.
 - A full screen display of the selected image appears.



Selecting the Number of Images to Display

1. In the multi-image display screen, press the Fn button.
 - The multi-image options screen appears.
2. Press the direction buttons (⬅️➡️) on your camera to select the number of images to display at once.
 - 4, 9, 16 images
3. The selected number of images display at once.

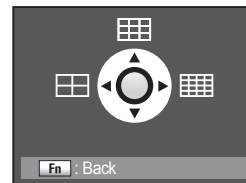

Displaying a Folder

You can display the contents of folders in the multi-image display screen.

1. Turn the rear dial (☺) to the left in the multi-image display screen.
2. Select the folder you want to display and press the OK button.
 - Images in the selected folder are shown in the thumbnail view.



Folder name

Playing Back Still Pictures

Slideshow

You can play back all images recorded on your Memory Card successively.

- Press the playback button (▶).
- The most recently captured image (image with the largest file number) is displayed on the LCD monitor.
- Press the direction buttons (◀▶) on your camera. to select an image to be displayed first.
- Press the **Fn** button.
- The Fn menu appears.
- Press the direction button (▶).
- **[Show]**, **[Interval]**, and **[Effect]** setting screen appears.
- Press the direction buttons (◀▶) to select the playback method, time interval, and the effect and then press the **OK** button.
- Start screen is displayed and slideshow begins.



- Operations available during a slideshow
 - OK** button : Playback/Pause
 - Direction button (◀) : Shows previous image
 - Direction button (▶) : Shows next image
 - Direction button (▼) : Stop

Effect of the Slideshow

Effect of the slide show	Function
Show	Play, Repeat
Interval	3, 5, 10, 20, 30 (sec)
Effect	Off
	Effect 1 : Shows the fading effects between slide images.
	Effect 2 : Shows images in the left to right direction.
	Effect 3 : Shows images in the diagonal direction.
Effect 4 : Shows images in the vertical direction.	



- Slideshow ends when one of the following is performed during playback or when paused.
 - Press the direction button (▼) on your camera.
 - Shutter release button is pressed halfway or fully.
 - Press the **AF** button.
 - Press the playback button (▶).
 - Main switch is turned to the position.
 - Rotate the mode dial (⊙).
 - Press the **MENU** button.
- ①, ⑦ After slideshow ends, the camera switches to playback mode.
- ②, ③, ④, ⑤, ⑥ After slideshow ends, the camera switches to Capture mode.
- ⑦ After slideshow ends, the Playback menu appears.
- You can set the slideshow function using the **Fn** menu.

Playing Back Still Pictures

Digital Filters

You can edit shot images using digital filters. Processed images are saved under a different name.

1. Press the **Fn** button.
- The Fn menu appears.



2. Press the direction button (◀) on your camera.
- The screen for selecting the filter appears.



3. Press the direction buttons (◀▶) to select an image.

4. Press the direction buttons (▲▼) to select a filter.
- Select a filter and preview the effects on the image.

5. Set a desired filter by using the front dial (◐) and rear dial (◑).



▲ Colour Filter

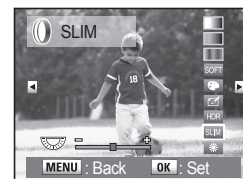

▲ Slim Filter

6. Press the **OK** button.
- The save confirmation screen appears.

7. Press the direction button (▲) to select **[Save as]**.



8. Press the **OK** button.
- The filtered image is saved under a different name.

Playing Back Still Pictures

■ Digital Filter

Filter	Function	Front dial	Rear dial
B&W	Converts to a black and white image. Changes the contrast to appear as if a B&W colour filter was used.	-	B&W/R/G/B
SEPIA	Adds a vintage touch to photos by converting them to sepia colour.	-	Density (3 levels)
COLOUR	Adds a colour filter to the image. Selects from 18 filters (6 colours x 3 tones).	Colour	Density of each colour (3 levels)
SOFT	Creates a soft image.	-	Softness (3 levels)
Extract Colour	Extract the selected colour from of image.	Colour	
Illustration	Adds an illustration effect to the image.		
HDR	Compensate the contrast value in the images that have high contrast caused by bright backlight to the camera.		HDR (3 levels)
SLIM	Changes the horizontal and vertical ratio of images. Adjusts height or width up to two times the original size.	-	Left : Wide Right : Slim
BRIGHTNESS	Changes the brightness of images. Adjusts in a range of ± 8 levels.	-	Left : Dark Right : Light



- RAW images cannot be processed using the digital filter.
- You can also access to the [Digital Filter] in the [PLAYBACK MENU].

- When another image is selected with the direction buttons (◀▶) on your camera, the image appears in the set filter.

Playing Back Still Pictures

Converting RAW files to JPEG format

You can convert captured RAW files into JPEG files.

1. Select a RAW file in Playback mode.



2. Press the Fn button.
- The Fn menu appears.



3. Press the direction button (▼) on your camera.

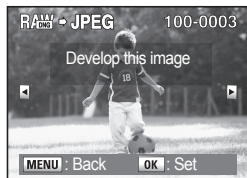

4. Press the **OK** button.
- The parameters recorded in the image file appear.
- If you do not want to change the current parameters, press the **OK** button again.
5. Press the direction buttons (◀▶) to change the parameter.



JPEG Size	14.6M : 4672 X 3104 / 10M : 3872 X 2592 / 6M : 3008 X 2000 / 2M : 1824 X 1216
JPEG Quality	🗍 (Super fine (1)) / 🗍 (Super fine (2)) / 🗍 (Fine) / 🗍 (Normal), TIFF
White Balance	AWB (Auto) / ☀ (Daylight) / ☁ (Shade) / ☁ (Cloudy) / 🌈 (Fluorescent (Daylight Colours)) / 🌈 (Fluorescent (Daylight White)) / 🌈 (Fluorescent (White Lighte)) / 🌈 (Tungsten Light) / ⚡ (Flash) / 📵 (Manual) / K (Colour Temperature)
Sensitivity	-2.0 ~ +2.0
Picture Wizard	Standard / Vivid / Portrait / Landscape / Custom 1 / Custom 2
Colour Tone	Natural / Red / Magenta / Blue/ Cyan / Green / Yellow / Warm / Cool
Sharpness	-4.0 ~ +4.0
Saturation	-4.0 ~ +4.0
Contrast	-4.0 ~ +4.0

6. After changing the parameter, press the **OK** button.
- The save confirmation screen appears.
7. Press the direction button (▲) to select **[Save as]**, then press the **OK** button.
- The edited image is saved under a different name.



- To choose **[Cancel]**, use the direction buttons (▲▼) to select **[Cancel]** and then press the **OK** button.

Deleting Images

Deleting a Single Image

You can delete one image at a time.

1. Press the playback button (▶) and press the direction buttons (◀▶) on your camera to select an image to delete.



2. Press the delete button (🗑️).
- The Delete screen appears.

3. Press the direction buttons (▲▼) to select [Delete].

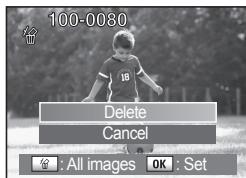

4. Press the **OK** button.
- The image is deleted.



- Deleted images cannot be restored.
- Protected images cannot be deleted.

Deleting All Images

You can delete all saved images at once.

1. Press the playback button (▶).

2. Press the delete button (🗑️) twice.
- The Delete All screen appears.

3. Press the direction button (▲) to select [Delete All].

4. Press the **OK** button.
- All images are deleted.



- Deleted images cannot be restored.
- Protected images cannot be deleted.
- If you try to delete all images, a [Delete all images on memory card?] message appears.

Deleting Images

Deleting Selected Images (from Nine-Image Display)

You can delete multiple images from the nine-image display at once.



- Deleted images cannot be restored.
- Protected images cannot be deleted.
- Only files in the same folder can be selected at once.

1. Press the playback button (▶).
 - The most recently captured image (image with the largest file number) is displayed on the LCD monitor.



2. Turn the rear dial (⤵) to the left (⏪).
 - Nine thumbnail images appear.

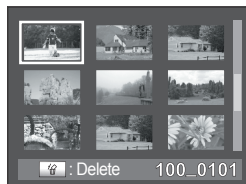

3. Press the delete button (🗑️).
 - □ appears above the images.

4. Press the direction buttons (⬅️➡️) to move to the images to delete and press the OK button.
 - Image is selected and appears.

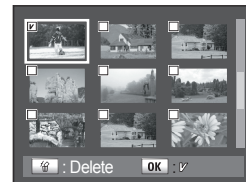

5. Press the delete button (🗑️).
 - The Delete confirmation screen appears.
6. Press the direction button (▲▼) to select [Select&Delete].
7. Press the OK button.
 - The selected images are deleted.

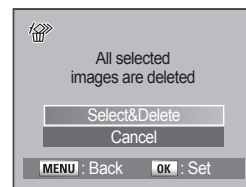

Deleting Folders

You can select a folder to delete.

1. Turn the rear dial (⤵) to your left in the thumbnail view mode.
2. Select the folder you want to delete using the direction buttons (⬅️➡️).
3. Press the delete button (🗑️) and then select the [Delete All]. The selected folder is deleted as soon as you press the OK button.



Folder name



If any protected images are in the selected folder, a message appears and asks if you want to delete them all.

Deleting Images

Deleting images taken with the RAW+ button

You can save both the RAW and JPEG images at one time shutter release using the **[Set RAW Button]** function. Both the RAW and JPEG images can be deleted at once if you press the delete button (🗑️) while playing back the "RAW+" image.



- Deleted images cannot be restored.
- Protected images cannot be deleted.

1. Press the playback (▶️) button and select the "RAW+" image by using the direction buttons (⬅️➡️).



2. Press the delete button (🗑️).
 - The Delete screen appears.

3. Press the direction buttons (▲▼) to select deletion type.

- [Delete JPEG]

Only JPEG format images among the selected images are deleted.

- [Delete RAW]

Only RAW format images among the selected images are deleted.

- [Delete RAW+JPEG]

RAW and JPEG format images among the selected images are deleted.

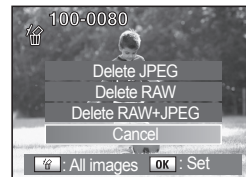

Only the **[Delete]** or **[Cancel]** appears on the screen if you press the delete button (🗑️) while playing back the RAW images.

Protecting Images from Deletion

Protecting a Single Image

You can protect images from being accidentally deleted.



Protected images are also deleted if you format the memory card.

1. Press the playback button (▶).
- The most recently captured image (image with the largest file number) is displayed on the LCD monitor.



2. Press the AE-L button (⊖).
- The Protect screen appears.

3. Press the direction buttons (▲▼) to select [Protect].

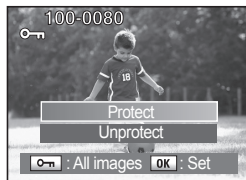

4. Press the OK button.
- The selected image is protected.



- Select [Unprotect] in Step 3 to cancel the Protect setting.
- The ⊖ symbol is displayed when playing back protected images.

Protecting All Images

1. Press the playback button (▶).
- The most recently captured image (image with the largest file number) is displayed on the LCD monitor.



2. Press the AE-L button (⊖) twice.
- The Protect all images screen appears.

3. Press the direction buttons (▲▼) to select [Protect].



4. Press the OK button.
- All images saved in the SD Memory Card are protected.



Select [Unprotect] in Step 3 to cancel the Protect setting on all of the images.

Connecting the Camera to AV Equipment

By using the video cable, you can play back images using a TV or other device with a video IN jack as your monitor. Make sure that both the TV and the camera are turned off before connecting the cable.

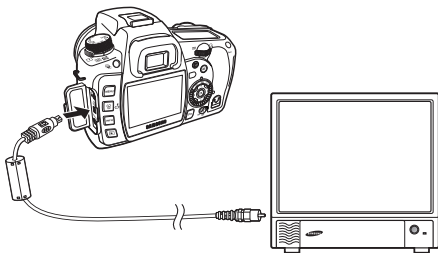

1. Open the terminal cover and connect the video cable to the PC / Video terminal on your camera.
2. Connect the other end of the video cable to the video IN jack on the AV device.
3. Turn on the AV device and the camera.



- If you intend to use the camera continuously for a long period, use of the AC Power Adapter (SAC-82, sold separately) is recommended.
- For AV equipment with multiple video IN jacks (such as TVs), check the operating manual of the AV device, and select the video IN jack to which the camera is connected.
- Ensure that the video output format setting is the correct one for your country or region.
- The camera LCD monitor turns off while the camera is connected to the AV device.

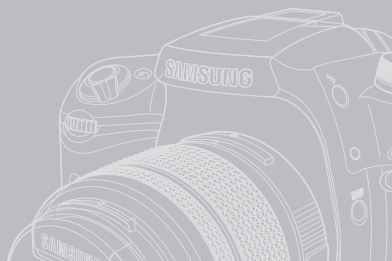

GX20

Using the Software

Explains camera characteristics, accessories and the names of various parts.

- 122 Software Notes**
 - 122 System Requirements
- 124 Setting up the application software**
 - 125 Starting PC mode
- 126 Removable Disk**
 - 126 Downloading stored images
- 127 Removing the removable disk**
 - 127 Windows 2000/ME/XP/Vista
 - 127 Setting up the USB Driver for MAC
 - 127 Using the USB Driver for MAC
- 128 Samsung Master**
 - 128 Downloading images
 - 130 Image viewer
 - 131 Image edit
 - 132 Movie edit
- 133 Using the Samsung RAW Converter 2.0**
 - 133 Developing the RAW files
 - 134 Correcting the exposure
 - 135 Handling the JPEG/TIFF files as you edit RAW files
 - 135 Saving the RAW files into JPEG or TIFF format

Software Notes

Please ensure that you read this section of the instruction manual carefully before use.

- The included software is a camera driver and image editing software tool for Windows.
- Under no circumstances should all or part of either the software or the user manual be reproduced.
- Copyrights for software are licensed only for use with a camera.
- In the unlikely event of a manufacturing fault, we will repair or exchange your camera. We cannot, however, be held responsible in any way for damage caused by inappropriate use.
- Using a Hand-made PC or a PC and OS that has not been guaranteed by the manufacturer is not covered by the Samsung warranty.
- Before reading this manual, you should have a basic knowledge of computers and O/S (Operating Systems).



Screen Captures illustrated on this manual is based on English Edition of Windows.

System Requirements

For Windows	PC with processor better than Pentium III 450MHz (Pentium 800MHz recommended) Windows 2000/ME/XP/Vista Minimum 256MB RAM (512MB recommended) 250MB of available hard disk space (1GB recommended) USB port CD-ROM drive 1024x768 pixels, 16-bit color display compatible monitor (24-bit color display recommended)
For Macintosh *	Power Mac G4 or later Mac OS 10.2 or later Minimum 256MB RAM 250MB of available hard-disk space USB port CD-ROM drive

* The included software is not compatible with Macintosh computers.

Software Notes

- Samsung Master : This is the all-in-one multi media software solution

You can download, view, edit and save your digital images with this software.

You can also edit and save the still images.

This software is only compatible with Windows.

- Using Samsung RAW Converter 2.0, you can convert a RAW (*.dng) file into a JPEG or TIFF file format.



- You should allow 5~10 seconds for running the automatic setup program according to the capability of your computer. If the frame is not shown, run the [Windows Explorer] and select [setup.exe] in the CD-ROM Drive root directory.
- PDF documents of the user manual are included in the Software CD-ROM supplied with this camera. Search the PDF files with Windows explorer. Before opening the PDF files, you must install the Adobe Reader included in the Software CD-ROM.
- To install the Adobe Reader 6.0.1, the Internet Explorer 5.01 must be installed. To upgrade the Internet Explorer, visit www.microsoft.com.

Setting up the application software

- To use this camera with a PC, install the application software first. After this has been done, the stored images in the camera can be moved to the PC and can be edited by an image editing program.
- You can visit the Samsung web-site through the internet.
<http://www.samsungcamera.com> : English
<http://www.samsungcamera.co.kr> : Korean

1. Install the Samsung Master/Samsung RAW Converter by following the instructions shown on your PC monitor.

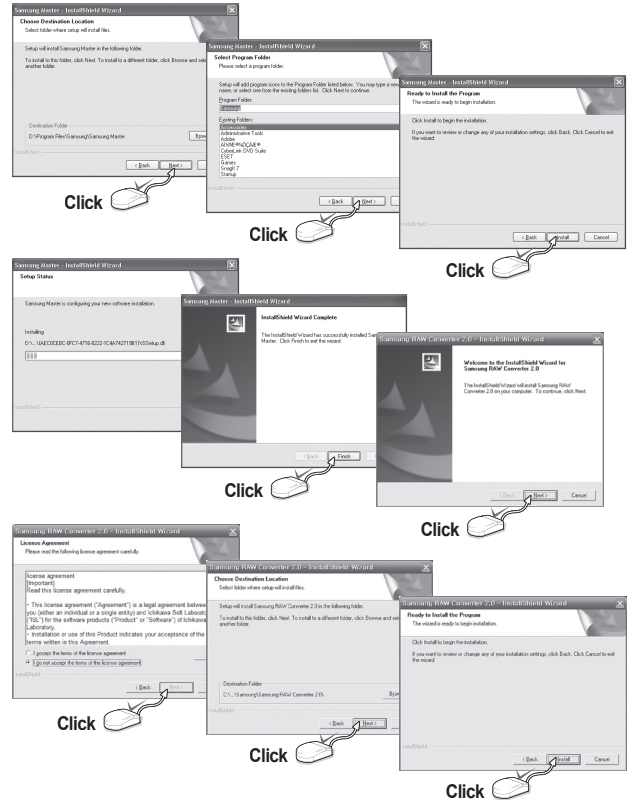

Setting up the application software

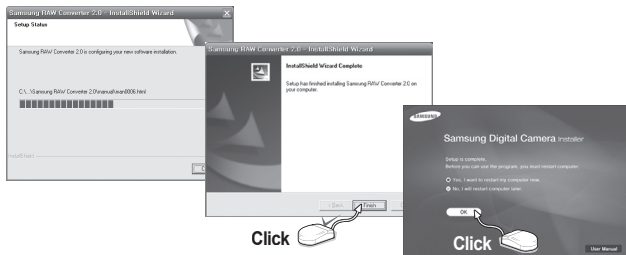

2. After restarting the computer, connect the PC to the camera with the USB cable.
3. Turn the camera power on. The [Found New Hardware Wizard] will open and the computer will recognize the camera.

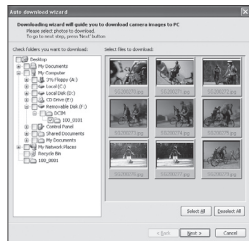

- If your OS is Windows XP/ Vista, an image viewer program will open.
- If the download window of Digimax Master opens after starting Samsung Master, the camera driver was setup successfully.

Starting PC mode

In this mode, you can download stored images to your PC through the USB cable. The LCD monitor is always turned off in PC mode.

Connecting the camera to a PC

1. Press the **MENU** button and select the **[SETUP MENU]** menu.
2. Set **[USB]** on camera to **[Computer]**.
3. Connect the PC to the camera with the USB cable.

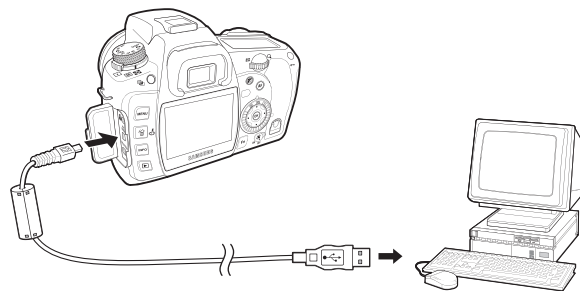
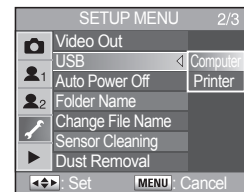

Removable Disk

Downloading stored images

You can download the still images stored on the camera to your PC's hard disk and print them or use photo editing software to edit them.

1. Connect the camera to your PC with the USB cable.
2. In your Windows Explorer display, select **[My Computer]** and double click **[Removable Disk -> DCIM -> 100_0001]**.
-The image files will then be displayed.

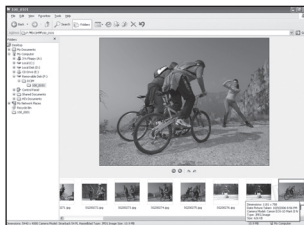

3. Select an image to download.

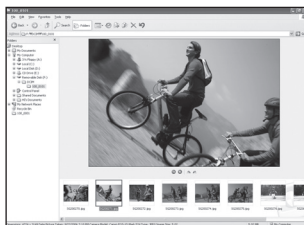

4. Select **[Copy]** from the **[Edit]** menu.

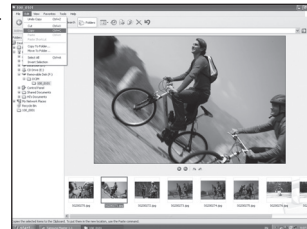

5. Select the destination folder and click **[Paste]** from the **[Edit]** menu.

6. You will find the downloaded files on your computer.



- We recommend that you should copy the images to the PC to view them. Opening images directly from the removable disk may cause an unexpected disconnection.
- When you upload a file that is not taken by this camera to the Removable Disk, the **[Camera cannot display this image]** message will be displayed on the LCD monitor in the Playback mode, and **[?]** message is displayed in THUMBNAIL mode.

Removing the removable disk

Windows 2000/ME/XP/Vista

The illustrations may be different from the real display depending on the Windows O/S.

1. Check whether the camera and PC is transferring a file. If the Card in use lamp blinks, you have to wait until the lamp goes out.



2. Right-click [**Safely remove the hardware**] icon.



3. The [**Safely Remove Hardware**] window will open. Select the [**USB Mass Storage Device**] and click the [**Stop**] button.

4. The [**Stop a Hardware device**] window will open. Select the [**SAMSUNG DIGITAL_CAMERA USB Device**] and click the [**OK**] button.



5. A [**Unplug or Eject Hardware**] window will open. Click the [**Close**] button and the removable disk may then be removed safely.
6. Now you can safely remove the USB cable. Unplug the USB cable.

Setting up the USB Driver for MAC

Digital camera is automatically recognized by the Macintosh when connected.

1. Check the version of Mac OS.
 - This camera is compatible with Mac OS 10.2 or later.
2. Connect the camera to the Macintosh and turn the camera power on.
 - A new icon will be displayed on the desktop after connecting the camera to the MAC.

Using the USB Driver for MAC

Digital camera is automatically recognized by the Macintosh when connected.

1. Double click a new icon on the desktop,
 - The folder in the memory will be displayed.
2. Select an image file and copy or move it to MAC.



For Mac OS 10.2 or later : First complete uploading from computer to camera and then remove the removable disk with the Extract command.

Samsung Master

You can download, view, edit and save your digital images and movies with this software. This software is only compatible with Windows.

To start the program, click [Start → Programs → Samsung → Samsung Master → Samsung Master].

Downloading images

1. Connect the camera to your PC.
2. A window for downloading images will display after connecting the camera and your PC.
 - To download the captured images, select the **[Select All]** button.
 - Select desired folder in the window and click the **[Select All]** button. You can save captured images and selected folder.
 - If you click the **[Cancel]** button, downloading will be cancelled.

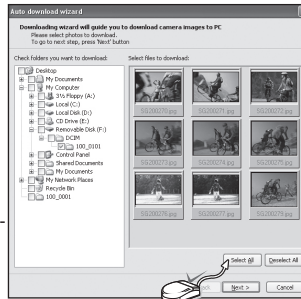

Click

3. Click **[Next>]** button.

4. Select a destination and make a new folder in which to save downloaded images and folders.

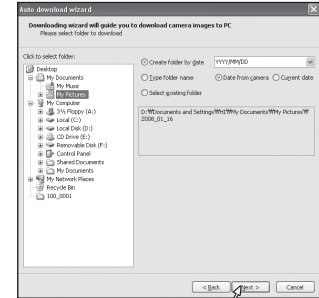

Click

5. Click **[Next>]** button.

Samsung Master

- A window will open as shown. The destination of the selected folder will be displayed along the top of the window. Click the **[Start]** button to download the images.



Click

- Downloaded images will be displayed.

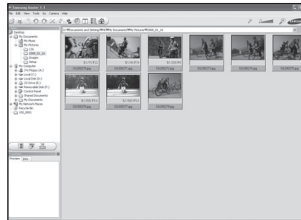

Samsung Master

Image viewer

You can view the stored images.

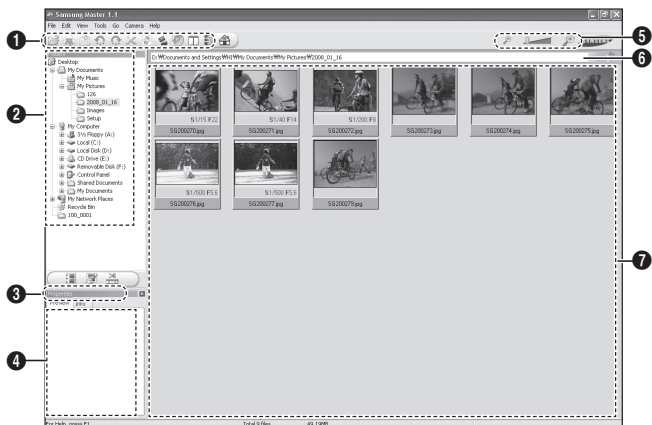

- 1 Menu bar**
You can select menus.
File, Edit, View, Tools, Change functions, Auto download, help, etc.
- 2 Image in Folder selection window**
You can select the desired images in this window.
- 3 Media type selection menu**
You can select image viewer, image edit, movie edit functions in this menu.
- 4 Preview window**
You can preview a image or a movie clip and check the multi media information.
- 5 Zoom bar**
You can change preview size.
- 6 Folder display window**
You can see the folder location of the selected image.
- 7 Image display window**
Images of the selected folder are displayed.



Refer to the [Help] menu in Samsung Master for further information.

Samsung Master

Image edit

You can edit the still image.

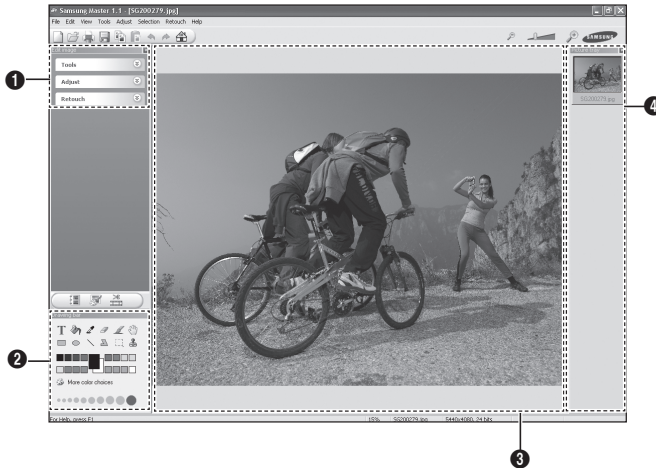

1 Edit menu

You can select the following menus.

[Tools] You can resize or crop the selected image.

[Adjust] You can modify image quality.

[Retouch] You can change image or insert effects on the image.

2 Drawing tools

Tools for editing an image.

3 Image display window

A selected image displays in this window.

4 Preview window

You can preview the changed image.



- Refer to the [Help] menu in Samsung Master for further information.
- A still image edited with Samsung Master can't be played back on the camera.

Samsung Master

Movie edit

You can have still images, movies, narration and music all in one movie file.

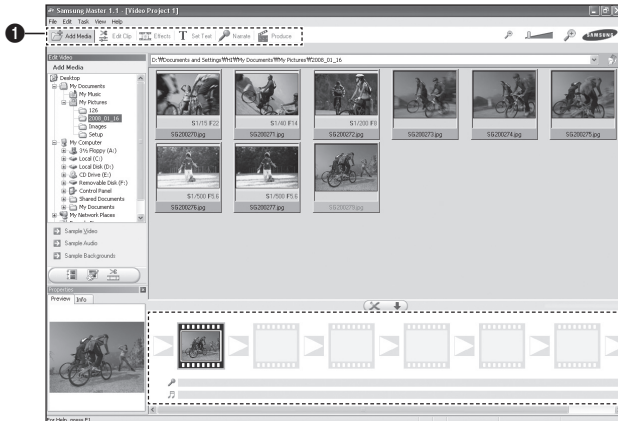

1 Edit menu

You can select the following menus.

[Add Media] You can add other media elements to a movie.

[Edit Clip] You can change the brightness, contrast, colour and saturation.

[Effects] You can insert an effect.

[Set Text] You can insert texts.

[Narrate] You can insert a narration.

[Produce] You can save the edited multi media as a new file name.

2 Frame display window

You can insert multi media in this window.



Refer to the [Help] menu in Samsung Master for further information.

Using the Samsung RAW Converter 2.0

Using the Samsung RAW Converter 2.0, you can develop RAW files after editing them as you like. You can also edit JPEG or TIFF files in the same way you edit the RAW files. This software is only compatible with Windows OS. This software is only compatible with Windows XP and Vista. You can use this software using the Windows 98SE, ME, 2000. However, the complete operation can not be warranted for use.

To start the program, click [Start -> All Programs -> Samsung RAW Converter 2.0 -> Samsung RAW Converter 2.0]

Developing the RAW files

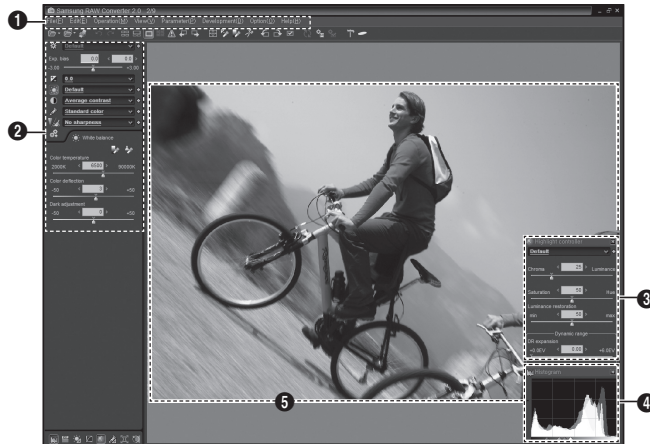

1 Menu bar

2 Image editing tools

[Exposure bias] Compensates the exposure value.

[White balance] Adjusts the white balance value.

[Tone] Adjusts the contrast.

[Colour] Changes the colour.

[Sharpness] Adjusts the sharpness.

[Development] Previewing is available for the final output.

3 Highlight controller

Adjusts the saturation and highlights of the selected image.

4 Histogram

Displays the colour layers of the selected image.

5 Preview window

Displays the selected image.



Refer to the [Help] menu in Samsung RAW Converter 2.0 for further information.

Using the Samsung RAW Converter 2.0

Correcting the exposure

The main feature of the Samsung RAW Converter 2.0 is that you can keep the best quality of the images as you make changes to the RAW files while editing. After making changes to the brightness or contrast, you can still obtain the same result whichever you change first. The following images show how you can change the exposure to the image using the Samsung RAW Converter 2.0

You can adjust the exposure by using the menu option as shown in the picture.

Menu option for adjusting the exposure.

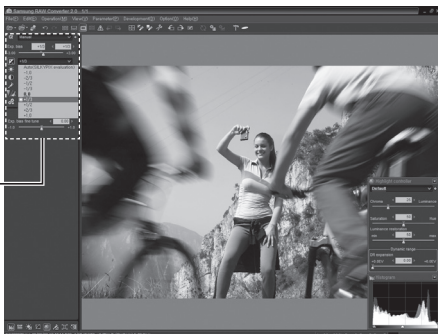

You can see the changed results in the histogram windows as shown images:

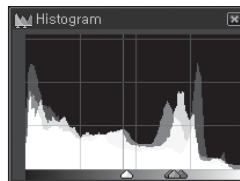

▲ Original image

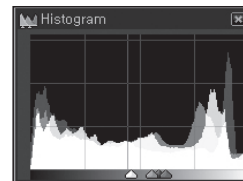

▲ Changed image after correcting the exposure.



▲ Original image

P Mode, Aperture: f = 22,
Shutter Speed: 1/15sec, ISO = 50



▲ Changed image after correcting the exposure.

Using the Samsung RAW Converter 2.0

Handling the JPEG/TIFF files as you edit RAW files

Using the Samsung RAW Converter 2.0, you can handle the JPEG/TIFF files as you edit RAW files. You can adjust the white balance, sharpness, and reducing the noise is also available. The following images show how the contrast was changed on the TIFF image using the Samsung RAW Converter 2.0.

You can adjust the contrast by using the menu option as shown in the picture.

Menu option for adjusting the contrast.

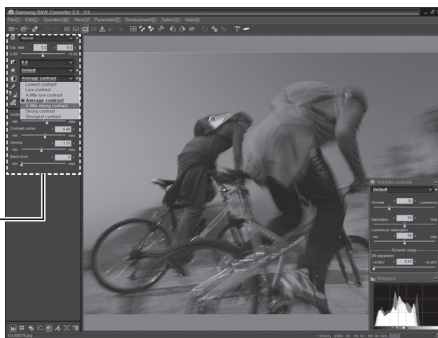

▲ Original image
P Mode, Aperture: f = 22,
Shutter Speed: 1/15sec, ISO = 50



▲ Changed image after adjusting the contrast.

Saving the RAW files into JPEG or TIFF format

You can save the RAW files into JPEG or TIFF format using the Samsung RAW Converter 2.0.

1. Choose the image you want to edit and then select **[Development(D)]** → **[Development(S)...]**.

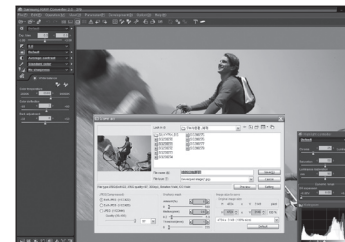

2. Select the type of file as **JPEG or TIFF** and then click **[Save(S)]**.
-The selected file is saved as JPEG or TIFF format.

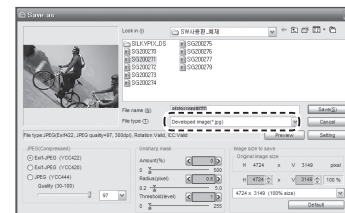

MEMO

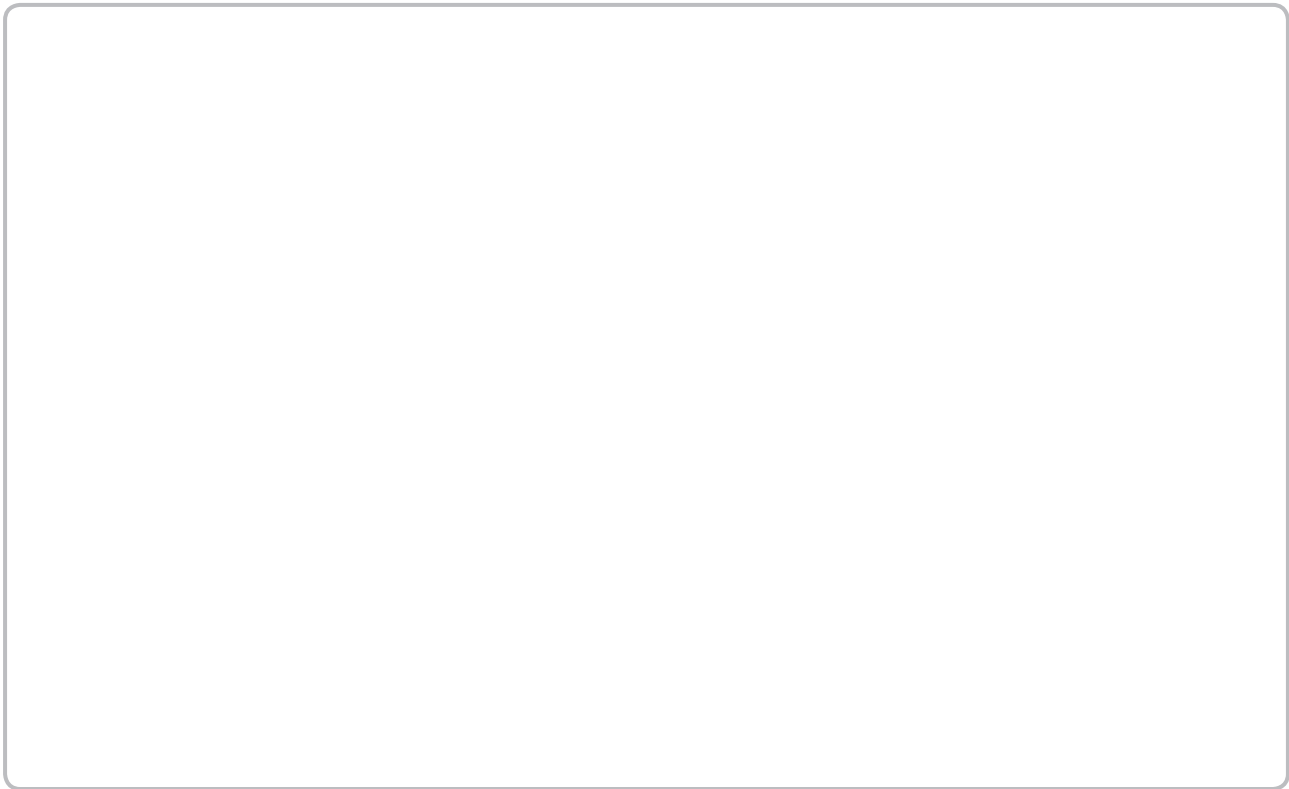
A large, empty rectangular box with rounded corners, intended for writing a memo. The box is outlined in a thin gray border and occupies the majority of the page below the 'MEMO' header.

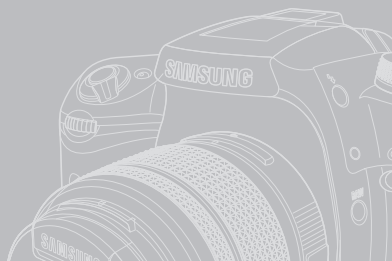

GX20

How to Make a Photo Print

Explains how to make a photo print.

- 138 Setting the Printing Service (DPOF)**
- 138 Printing Single Images
- 139 Settings for All Images
- 140 Printing Using PictBridge**
- 140 Connecting the Camera to the Printer
- 141 Printing Single Images
- 143 Printing All Images
- 144 Printing Images Using the DPOF Settings
- 144 Disconnecting the Cable from the Printer

Setting the Printing Service (DPOF)

You can order conventional photograph prints by taking the Memory Card with recorded images to any store offering this printing service. DPOF (Digital Print Order Format) settings allow you to specify the number of copies or to imprint the date.



DPOF settings cannot be applied to RAW images.

Printing Single Images

Set the following items for each image.

- **Copies** : Selects the number of copies. You can print up to 99 copies.
- **Date** : Specifies whether you want the date inserted on the print or not.

1. Press the playback button (▶).
- The most recently captured image (image with the largest file number) is displayed on the LCD monitor.
2. Press the direction buttons (◀▶) on your camera to select a desired image.



3. Press the **Fn** button.
- The Fn menu appears.

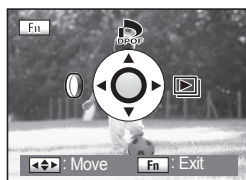

4. Press the direction button (▲).
- The DPOF screen appears. If DPOF settings have already been made for an image, the previous number of prints and date setting ((on) or (off)) will be displayed.



5. Press the direction buttons (◀▶) to select the number of copies and press the direction buttons (▼).
- The frame moves to [Date].

6. Press the direction buttons (◀▶) to select whether to insert the date or not.
- (): The date will be imprinted.
- (): The date will not be imprinted.

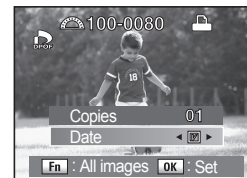

7. Press the **OK** button.
- The DPOF settings are saved and the camera returns to Playback status.



- Depending on the printer or printing equipment at the photo processing lab, the date may not be imprinted on the pictures even if the DPOF setting was made.
- To cancel DPOF settings, set the number of copies to [00] in Step 5 and press the **OK** button.

Setting the Printing Service (DPOF)

Settings for All Images

In the thumbnail view, you can set the DPOF (Digital print Order Format) for many images at once.

1. Press the **Fn** button in Playback mode.
- The Fn menu appears.



2. Press the direction button (**▲**) on your camera.
- The DPOF screen appears.

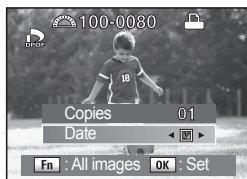

3. Press the **Fn** button.
- The screen for making DPOF settings for all images appears.

4. Press the direction buttons (**◀▶**) to select the number of copies and whether to insert the date or not.
- (): The date will be imprinted.
- (): The date will not be imprinted.

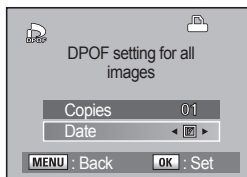

Refer to Steps 5 and 6 in "Printing Single Images" for details of how to make the settings.

5. Press the **OK** button.
- The DPOF settings for all the images are saved and the camera returns to Playback status.



- The number of copies specified in settings for all images applies to all the images. Before printing, check that the number is correct.
- Settings for single images are cancelled when settings are made for all images.

Printing Using PictBridge

This function lets you print images directly from the camera without using a PC (direct printing).

Connect the camera and PictBridge compatible printer with the included USB cable to print directly. After connecting the camera to the printer, select the images you want to print, the number of copies and whether to insert the date or not. Direct printing is performed in the following steps.

1. Set the **[USB]** on the **[SETUP MENU]** to **[Print]**.
2. Connect the camera to the printer.
3. Set the printing options.
 - Print single images
 - Print all images
 - Print with DPOF settings

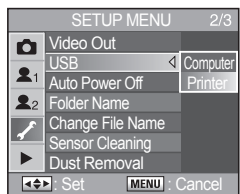

- Use of the AC Power Adapter (SAC-82, sold separately) is recommended when connecting the camera to a printer. If the AC Power Adapter is not used, the printer may not work properly or the image data may be lost if the batteries run out of power while the camera is connected to the printer.
- Do not disconnect the USB cable during data transfer.
- Depending on the type of printer, not all the settings made on the camera (such as print settings and DPOF settings) may be valid.
- If the number of copies is set to more than "500" in the printer option, a failure may occur when you attempt to print.
- You cannot use the camera to select multiple images for printing on a single sheet. Make the settings on the printer. For details, refer to the operating manual for your printer.
- RAW images cannot be printed directly. Use a PC to print RAW images.
- See the software instructions when connecting to a PC.

Connecting the Camera to the Printer

1. Turn the camera off.
2. Connect the camera and a PictBridge compatible printer using the USB cable supplied with the camera.

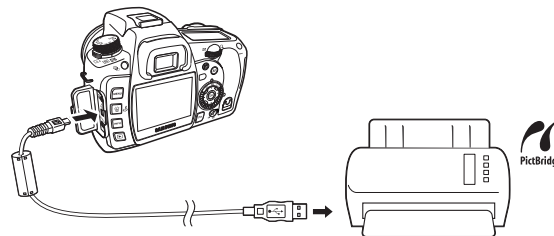

3. Turn the printer on.
4. After printer start-up is complete, turn the camera on.
 - The PictBridge menu appears.

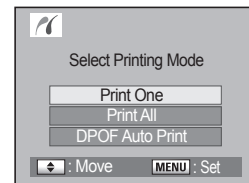

- PictBridge menu is not displayed if **[USB]** is set to **[Computer]**.
- **[DPOF Auto Print]** can be selected only with printers that support **[DPOF Auto Print]** function.

Printing Using PictBridge

Printing Single Images

1. Press the direction buttons (▲▼) on your camera to select [Print One].

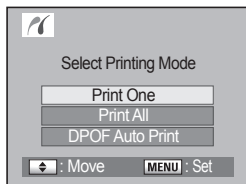

2. Press the **OK** button.
- The Print one screen appears.

3. Press the direction buttons (◀▶) to select an image to print.



4. Press the direction buttons (▲▼) to select the number of copies.
- You can print up to 99 copies.

5. Press the **Fn** button to select whether to insert the Date or not.
- : The date will be printed.
- : The date will not be printed.

6. Press the **OK** button.
- The print settings confirmation screen appears. Proceed to **Step 12** to print the images by default. To change the print settings, go to **Step 7**.

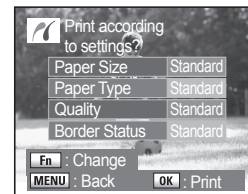

7. Press the **Fn** button.
- The screen for changing print settings appears.

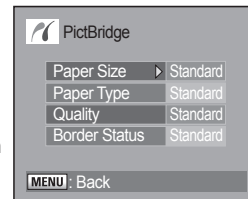





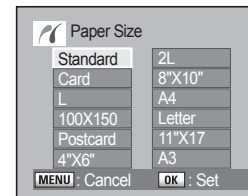

8. Select [**Paper Size**] and press the direction button (▶).
- The Paper Size screen appears.

9. Press the direction buttons (◀▶) to select the paper size.
- You can only choose a size that is supported by your printer. When the Paper Size is set to [**Standard**], images are printed according to the printer settings.



Printing Using PictBridge

10. Press the **OK** button.

11. Repeat Steps 8 to 10 to set **[Paper Type]**, **[Quality]** and **[Border Status]**.
 - The print settings change screen appears after each item has been set. When the Paper Size is set to [Standard], images are printed according to the printer settings.
 - **[Paper Type]** : Standard,  (Best),  (Good),  (Normal)
 - **[Quality]** : Standard,  (Super fine),  (Fine),  (Normal)
 - **[Border Status]** : Standard, With, Without

12. Press the **OK** button twice.
 - The image is printed according to the settings. Press the **MENU** button to cancel printing.

Printing Using PictBridge

Printing All Images

1. Press the direction buttons(▲▼) on your camera to select [Print All].

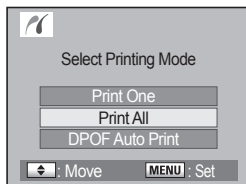

2. Press the **OK** button.
 - The Print all images screen appears.

3. Select the number of copies and whether to imprint the date or not.
 - The number of copies and the date setting that you choose apply to all of the images. Refer to Steps 4 and 5 of "Printing Single Images" for details on how to change the settings.



4. Press the **OK** button.
 - The print settings confirmation screen appears. Refer to Steps 7 and 8 of "Printing Single Images" for details on how to change the settings.

5. Press the **OK** button on the print settings confirmation screen.
 - All the images are printed according to the settings. Press the **MENU** button to cancel printing.



Printing Using PictBridge

Printing Images Using the DPOF Settings

1. Press the direction buttons (▲▼) on your camera to select [DPOF Auto Print].

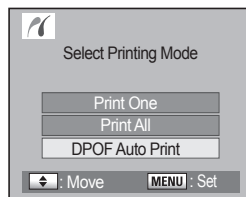

2. Press the **OK** button.
 - The Print with DPOF settings screen appears. Press the direction buttons (◀▶) to check the number of copies for each image, whether the date is imprinted or not, and total number of copies. Print settings are set with the Print Service.

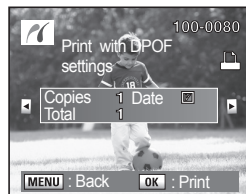

3. Press the **OK** button.
 - The print settings confirmation screen appears. Refer to Steps 7 and 8 of "Printing Single Images" for details on how to change the settings.
4. Press the **OK** button on the print settings confirmation screen.
 - The images are printed according to the settings. Press the **MENU** button to cancel printing.

Disconnecting the Cable from the Printer

When you have finished printing, turn off the camera.

1. Turn off the camera.
2. Disconnect the USB cable from the camera and printer.

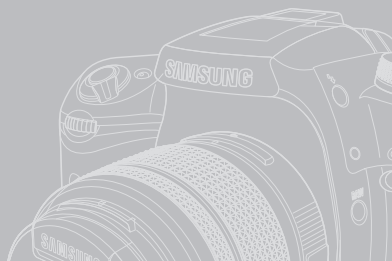

GX20

Appendix

Explains troubleshooting and introduces the special terms used in this user guide.

146	Optional Accessories
146	External Flash (SEF-54PZF / SEF-36PZF)
146	Camera Case
146	Others
147	Troubleshooting
152	Main Specifications
154	Glossary
156	Index
158	Correct Disposal of This Product
158	FCC notice

Optional Accessories

Dedicated accessories are available for this camera. Please contact a service centre for details regarding accessories.

External Flash (SEF-54PZF / SEF-36PZF)

This is an auto flash unit with a maximum guide number of 54 (ISO 100/m) / 36 (ISO 100/m).

Its features include slave-sync flash, contrast-control-sync flash, AF spot beam, high-speed sync, wireless flash and front/rear curtain-sync.

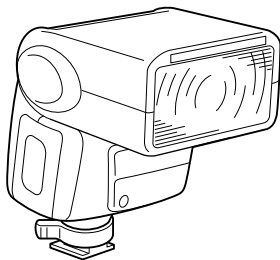

Camera Case

- Camera Case SCP-D2

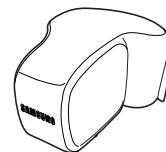

Others

The accessories below are the same as the accessories that are packaged with the camera.

- Viewfinder cap



- Eyecup



- Strap

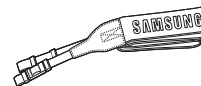

Troubleshooting

Error Messages	Description
Memory card full	The Memory Card is full and no more images can be saved. Insert a new Memory Card or delete unwanted images. You may be able to save new images by changing the quality level or recorded pixels.
No image	There are no images for playback on the Memory Card.
Camera cannot display this image	You are trying to play back an image in a format not supported by this camera. You may be able to play it back on another brand of camera or your computer.
No card in camera	The Memory Card is not inserted in the camera.
Memory card error	The Memory Card has a problem, and image capture and playback are impossible. It may be viewable on a PC but not the camera.
Card not formatted	The Memory Card you have inserted is unformatted or has been formatted on a computer or other device and is not compatible with this camera. Use after formatting with the camera.
Card locked	
Card is locked Rotation information cannot be saved	A locked Memory Card is inserted in the camera. Unlock the Memory Card.

Error Messages	Description
This image is protected Rotation information cannot be saved	The selected rotated image is protected. Remove protection from the image.
Cannot use this card	The inserted card cannot be used on a camera. Insert a usable card.
Battery depleted	The batteries are exhausted. Recharge the current battery or replace with a new one.
Not enough battery remaining to clean sensor	Appears during Sensor cleaning if battery set level is insufficient. Replace the battery set with a new one or use an AC adaptor.
Image folder could not be created	The maximum folder number (999) and file number (9999) are being used, and no more images can be saved. Insert a new Memory Card or format the card.
The image is not stored	The image could not be saved because of an Memory Card error.
Settings not stored	The DPOF settings file could not be saved because Memory Card is full. Delete unwanted images and set DPOF again.
RAW images cannot be set	DPOF cannot be applied to the RAW images.

Troubleshooting

Error Messages	Description
RAW images are not supported	RAW images cannot be processed using the digital filter.
This image can not be filtered.	When digital filter is started from [PLAYBACK MENU] menu, this message appears if all saved images are RAW files or images captured with other cameras.
No DPOF files	No file set with DPOF. Set DPOF and print.
Printer error	There is an error with the printer and the file cannot be printed. Fix error and print.
No paper in a printer	Printer has run out of paper. Put paper in printer and print.
No ink in a printer	Printer has run out of ink. Replace ink and print.
Paper stuck in a printer	Paper is jammed in printer. Remove paper and print.
Data error	A data error has occurred during printing.

Troubleshooting

We recommend checking the following items before contacting a service centre.

Problem	Cause	Remedy
Camera does not turn on.	Batteries are not installed.	Check if batteries are installed. If not, install batteries.
	Battery power is low.	Replace with a charged battery set or use the AC Power Adapter.
The shutter does not release.	The Aperture Ring is not in the A position.	Set the Aperture Ring to the A position or set the [Use Aperture Ring] on the [CUSTOM2 MENU] to [On] .
	Flash is charging.	Wait until charging is finished. Flash may not fire even though you set [Release in Charging] to [On] in the [CUSTOM2 MENU] .
	No available space on Memory Card.	Insert Memory Card with available space or delete unwanted images.
	Recording.	Wait until recording is finished.
The Autofocus does not work.	Subject is difficult to focus on.	Autofocus cannot focus well on subjects that have low contrast (the sky, white walls), dark colours, intricate designs, are moving quickly or scenery shot through a window or a net-like pattern. Lock focus on another object located at same distance (press shutter release button halfway), then aim at target and press shutter release button fully. Alternatively, use manual focus.

Problem	Cause	Remedy
The Autofocus does not work.	Subject is not in focusing area.	Position subject in focus frame in middle of viewfinder. If the subject is outside the focusing area aim the camera at the subject and lock the focus (press shutter release button halfway), then compose picture and press the shutter release button fully.
	Subject is too close.	Move away from the subject and take a picture.
	The focus mode is set to MF .	Set the focus mode lever to SAF / CAF .
The autofocus does not work.	The focus mode is set to CAF (Continuous mode).	Set the focus mode to SAF (Single mode).
	AE lock function does not operate.	AE lock is not available when set to A (Auto mode), B (Bulb) mode or X (Flash X-synchro) mode. Use AE lock with any setting other than A (Auto mode), B (Bulb) mode or X (Flash X-synchro) mode.
USB connection with computer does not work properly*.	The transfer mode is set from the [USB] to [Printer] .	Set transfer mode to [Computer] .
USB connection with printer does not work properly.	The transfer mode is set from the [USB] to [Computer] .	Set transfer mode to [Printer] .

Troubleshooting

Problem	Cause	Remedy
Shake Reduction does not work.	Shake Reduction function is turned off.	Turn on the Shake Reduction switch.
	Shake Reduction function is not set Properly.	If a lens for which focal length information cannot be acquired is used, set the [Focal Length] on the [(👤) OIS] menu.
	Shutter speed is too low for Shake Reduction function to be effective when panning or shooting night scenes, etc..	Turn off the Shake Reduction function and use a tripod.
	Optical image stabilization (OIS) may not work if shots are taken at a very short distance.	Move away from the subject, or turn off the Shake Reduction function and use a tripod.

- * In rare cases, the camera may not operate correctly due to static electricity. This can be remedied by taking the batteries out and putting them back in again. When the mirror remains in the up position, take the batteries out and put them back in again. Then, turn the power on. The mirror will retract. If this procedure is successful and the camera operates correctly, no repairs will be required.
- * Refer to the software instructions for details on connecting the camera to a PC.

Troubleshooting

Please check the following if the USB connection malfunctions.

Case 1	<p>The USB cable is not connected or you are using a cable with an incorrect specification.</p> <p>→ Use a USB cable with the correct specification.</p>	Case 6	<p>When I open the Device Manager (by clicking Start → (Settings) → Control Panel → (Performance and Maintenance) → System → (Hardware) → Device Manager), there are [Unknown Devices] or [Other Devices] entries with a yellow question mark (?) beside them or devices with an exclamation mark (!) beside them.</p> <p>→ Right-click on the entry with the question (?) or exclamation (!) mark and select "Remove". Restart the PC and connect the camera the again. For Windows 98 PC, remove the camera driver also, restart the PC, and then reinstall the camera driver.</p>
Case 2	<p>The camera is not recognized by your PC. Sometimes, the camera may appear under [Unknown Devices] in Device Manager.</p> <p>→ Turn off the camera, remove the USB cable, plug in the USB cable again, and then turn on the camera.</p>	Case 7	<p>In some security programs (Norton Anti Virus, V3, etc.), the computer may not recognise the camera as a removable disk.</p> <p>→ Stop the security programs and connect the camera to the computer. Refer to the security program instructions about how to stop the program.</p>
Case 3	<p>There is an unexpected error during file transfer.</p> <p>→ Turn the camera power off and on again. Transfer the file again.</p>	Case 8	<p>If a PC connected with the camera stops responding while Windows is starting.</p> <p>→ In this case, disconnect the PC and the camera and Windows will start. If the problem happens continuously, set the Legacy USB Support to disable and restart the PC. The Legacy USB Support is in the BIOS setup menu (The BIOS setup menu differs from the PC manufacturers and some BIOS menus don't have Legacy USB Support). If you can't change the menu by yourself, contact the PC manufacturer or BIOS manufacturer.</p>
Case 4	<p>When using the USB hub?</p> <p>→ There may be a problem in connecting the camera to the PC through the USB hub if the PC and the hub are not compatible. Wherever possible, connect the camera to the PC directly.</p>	Case 9	<p>The camera is connected to the USB port located on the front of the computer.</p> <p>→ When the camera is connected to the USB port located on the front of the computer, the computer may not recognise the camera. Connect the camera to the USB port located on the back of the computer.</p>
Case 5	<p>If used with any other USB devices?</p> <p>→ The camera may malfunction when it is connected to the PC at the same time as another USB cable. In this case, disconnect the other USB cable, and connect only one USB cable to the PC.</p>		

Main Specifications

Image Sensor	Type	23.4×15.5mm, CMOS
	Effective Pixel	Approx. 14.6 Mega-pixel
	Total Pixel	Approx. 15.1 Mega-pixel
Lens	Mount	PENTAX bayonet KAF2 mount
	Usable Lens	Schneider D-XENON, D-XENOGON, SAMSUNG lens * PENTAX DSLR lenses are available * KAF2, KAF, KA mount lenses
Viewfinder	Type	Pentaprism, Natural-Bright-Matte II Focusing Screen
	Field of View	About 95%
	Magnification	About 0.95X (50mm F1.4 lens [∞])
	Diopter Adjustment	About -2.5 ~ +1.5m ⁻¹
LCD Monitor		Low-temperature polysilicon TFT color LCD Monitor, 2.7" (approximately 230K pixels), Brightness & Color control, Wide angle view
Preview	Type	Live View(up to 3 minutes.), Optical Preview, Digital Preview
Focusing	Type	TTL phase-matching 11-point AF
	Modes	AF Single, Continuous AF, Manual focus
Shutter	Type	Electronically controlled vertical-run focal plane shutter
	Speed	Auto : 1/4000sec. ~ 30sec. (No step) Manual : 1/4000sec. ~ 30sec. (1/3EV or 1/2EV step) Bulb
Exposure Control	Metering System	TTL open-aperture 16-segment
		Metering : Multi, Center-weighted, Spot Metering range : EV0 ~ 21 (ISO100-50mm F1.4)
	Modes	Auto, Program, Shutter Priority AE, Aperture Priority AE, Sensitivity Priority AE, Shutter & Aperture Priority, Manual, Bulb, Flash X-sync, User Mode
	Compensation	±3 EV (1/2 EV step), ±2EV (1/3 EV step)

Exposure Control	AE Lock	AEL
	ISO	Auto, 100, 200, 400, 800, 1600, 3200 (1/3EV or 1/2EV step), 6400 (User setting) When expanded Bulb mode: 1600 (Maximum)
Flash	Type	Built-in retractable P-TTL manual pop-up flash
	Modes	Auto, Fill-in, Auto & Red eye, Fill-in & Red eye, Front curtain synchro, Front curtain synchro & Red eye, Rear curtain synchro, Wireless
	Guide Number	13 (at ISO 100)
	Angle of View Coverage	28 mm wide-angle (Equivalent to 35mm)
	Sync. Speed	1/180sec., Red-eye reduction (Control Range : -2 ~ +1 EV)
	Recharging Time	3.6 Sec (when flash fired at maximum)
External Flash	External Flash	SEF-36PZF, SEF-54PZF (optional)
	Syncro	Hot Shoe, X Syncro socket (Sync. Speed : 1/180sec.) High Speed Syncro, Wireless Syncro (External Flash)
White Balance	Modes	Auto, Daylight, Shade, Cloudy, Tungsten, Fluorescent (W, D, N), Flash, Manual, Color Temperature (1, 2, 3)
	Modes	Auto, Program, Sensitivity Priority, Shutter Priority, Aperture Priority, Shutter & Aperture Priority, Manual, Bulb, Flash X-sync., User mode
Shooting	Live View	Field of View : Approx. 97% Magnification(4X, 8X), Grid display, AF Frame
	Drive Modes	Single, Continuous (Hi, Lo), Self-timer (12sec., 2sec.), Remote Control, Auto Bracket, Expand Bracket, Multi Exposure
	Picture Wizard	Standard, Vivid, Portrait, Landscape, Custom 1, Custom 2 * Parameter : ±4 (9-step)
	Continuous	JPEG
RAW		3fps (Hi Continuous : up to 16 shots) 2.3fps (Lo Continuous : up to 16 shots)

Main Specifications

Shake Reduction	Type	Image Sensor Shift
	Effective Range	Max. 4EV (depends on lens and shooting conditions)
Dust Reduction		Yes
Self-timer		2sec., 12sec., Remote control, Remote control 3sec. Remote control Continuous (Compatible with Pentax Remote Control, Optional)
Storage	Media	SD (up to 4GB guaranteed), MMC (up to 2GB guaranteed), SDHC (up to 8GB guaranteed)
	File Format	RAW (DNG), JPEG (DCF), EXIF 2.21, DPOF 1.1, PictBridge 1.0
	Image Size	JPEG : 14.6M (4672×3104), 10M (3872×2592), 6M (3008×2000), 2M (1824×1216)
		RAW : 14.6M (4672×3104 pixel)
	Capacity (512MB)	14.6M : RAW 21 14.6M : Super Fine (1)35, Super Fine(2)61, Fine 109, Normal 213 10M : Super Fine (1)52, Super Fine (2)87, Fine 153, Normal 319 6M : Super Fine (1)91, Super Fine (2)147, Fine 254, Normal 474 2M : Super Fine (1)239, Super Fine (2)381, Fine 639, Normal 1060
↪ These figures are measured under Samsung's standard conditions and may vary depending on shooting conditions and camera settings.		
Image Play	Type	Single image, Thumbnail, Rotate, Slide Show (4-type Transition Effect), Histogram, Magnification (up to 32X)
	Edit	Rotate, Digital Filter
	Digital Filter	B&W (4 types), Sepia (3 types), Color Selection (18 types), Color (6 types), Soft (3 steps), Illustration, HDR (3 steps), Slim (±8 steps), Brightness (±8 steps)

Interface		Digital Output : USB 2.0 (HI-SPEED)
		Video Output : NTSC, PAL (user selectable)
		DC Power Input Connector : DC 8.3V, 2A (100 ~ 240V)
		External Release Socket
		X Synchro Socket for External Flash
Power Source	Dedicated battery	Lithium ion battery : SLB-1674, Charger : SBC-L6,
	Battery life	Approx. 500 min./1,000 shots (without flash on), Approx. 430 min./860 shots (with flash 50% on), Approx. 400 min./800 shots (with flash 100% on)
Dimensions(WxHxD)		142mm×101mm×71.5mm (excluding the projecting parts of the camera)
Weight		727g (Body only) , 806g (Memory card & Battery included)
Operating Temperature		0 ~ 40°C
Operating Humidity		5 ~ 85%
Software	Application	Samsung Master, Samsung RAW Converter 2.0, Adobe Reader

- Specifications are subject to change without prior notice.
- All trademarks are the property of their respective owners.

Glossary

AdobeRGB

Colour space recommended by Adobe Systems, Inc. for commercial printing. Wider range of colour reproduction than sRGB. Covers most of the colour range so colours only available when printed are not lost when editing images from a computer. When image is opened by non-compatible software, the colours look lighter.

AE Metering

Brightness of subject is measured to determine exposure. In this camera, select from [Multi-segment Metering], [Centre-weighted Metering] and [Spot Metering].

Aperture

The aperture controls the amount of light that reaches the camera sensor.

Auto Bracket

For automatically changing the shooting conditions. When the shutter button is pressed, three images are shot. The first one has no compensation, the second is under-exposed and the third is overexposed.

Camera Shake (Blur)

When the camera moves while the shutter is open, the entire image appears blurred. This occurs more often when shutter speed is low. Prevent camera shake by raising the sensitivity, using the flash, or by using a faster shutter speed. Alternatively, use a tripod to stabilize the camera. Because camera motion causes camera shake, use the self-timer, the remote control unit, and the cable switch to prevent this.

CMOS (Complementary Metal Oxide semi-conductor)

Refers to Complementary metal-oxide-semiconductor (CMOS). It is used in most Digital Single Lens Reflex (DSLR) cameras to "convert" light into the camera sensor. The CMOS sensor is an important feature that determines the quality of digital photos.

Colour space

A defined range of colours from the spectrum which are used. In digital cameras, [sRGB] is defined as the standard Colour Space by Exif. In this camera, [AdobeRGB] is also used because of its richer colour expression over sRGB.

Colour Temperature

This numerically expresses the colour of the light source illuminating the subject. This is indicated in absolute temperature, using Kelvin (K) units. The colour of light shifts to a bluish colour as the colour temperature rises, and to a reddish colour as the colour temperature falls.

DCF (Design rule for Camera File system)

The Design rule for Camera File System was created by the Japan Electronics and Information Technology Industries Association (JEITA).

DPOF (Digital Print Order Format)

Rules for writing information onto a card with recorded images regarding the specific images and number of copies to be printed. Prints can easily be made by taking images to a DPOF photo printing store.

Depth of Field

Area of focus. This depends on the aperture, lens focal length, and distance to the subject. For example, select a smaller aperture to increase the depth of field or use a larger aperture to decrease the depth of field.

DNG RAW file

DNG (Digital Negative) is a general-purpose RAW file format designed by Adobe Systems.

Exposure

Total amount of light allowed to fall on the photographic medium. Exposure is determined by the combination of the aperture value and the shutter speed.

EV (Exposure Value)

EV steps are numbers which refer to certain combinations of lens aperture and shutter speed. There is one EV step difference between the aperture stop 4 and 5.6 for example.

EV Compensation

Process of adjusting the image brightness by changing the shutter speed and aperture value.

Glossary

Exif (Exchangable Image File Format)

A standard digital camera file format established by the Japan Electronics and Information Technology Industries Association (JEITA).

Gradation

The total contrast range of an image. Also the range of light and dark tones in a scene that a camera sensor is capable of registering.

Histogram

A graph that shows the darkest and brightest points in an image. The horizontal axis represents the brightness and the vertical axis represents the number of pixels. This is useful when you wish to refer to the exposure status of an image.

Image Resolution

The term image resolution refers to the number of pixels in a digital photo. You can get a large picture in good condition with high-resolution.





Image Quality

Image quality is affected by the compression rate of the digital image. A high-quality photo has a low compression rate.

ISO Sensitivity

The sensitivity of the camera to light; the equivalent of film speed in a camera using film. With a high sensitivity, images can be shot with a high shutter speed even in dimly lit places, reducing camera shake. However, images with high sensitivity are more susceptible to noise.

JPEG (Joint Photographic Experts Group)

An image compression method. The image is recorded in JPEG format when the quality level is set to  (Super fine (1)),  (Super fine (2)),  (Fine), or  (Good). Images recorded in JPEG format are suitable for viewing on your PC or for attaching to e-mail.

ND (Neutral Density) Filter

A filter which reduces the amount of light entering the camera lens by a measured amount, without affecting the picture itself.

Noise Reduction

Process to reduce noise (image roughness or unevenness) caused by slow shutter speed.

NTSC/PAL

These are video output formats. NTSC is mainly used in Japan, North America, and South Korea. PAL is mainly used in Europe and in China.

RAW data

Unedited image data output from the CCD. RAW data is data before being internally processed by the camera. Settings like White balance, contrast, saturation and sharpness can be manipulated individually on each file. In addition, RAW data is 12-bit data that contains 16 times the information of 8-bit JPEG and TIFF data. Rich gradations are possible. Transfer RAW data to your computer and use the provided software to create image data with different settings, such as JPEG or TIFF.

sRGB (Standard RGB)

International standard of colour space established by the IEC (International Electrotechnical Commission). This is defined from colour space for PC monitors and is also used as the standard colour space for Exif.

Shutter Speed

The total exposure is proportional to the shutter speed. A fast shutter speed can capture a stopped motion of a moving subject.

Vignetting









Vignetting occurs when corners of pictures are darkened because the subject was blocked by the hood or filter or the flash was blocked.

White Balance

While shooting, colour temperature is adjusted to match the light source so that the subject appears to have the correct colour.

Index

Symbol

 Auto mode 033
P Automatic program exposure mode 080
Sv Aperture priority mode 082
Tv Shutter priority mode 083
Av Aperture priority mode 084
TAv Shutter & Aperture priority mode .. 085
M Manual mode 086
B Bulb mode 087
X Flash X-sync mode 088
User User Mode 089
 OIS (Optical Image Stabilization) 026
 Flash button 099, 100
 Auto Bracket 090
MENU Menu button 053
 Delete button 116~118
INFO INFO button 028~029
Fn Fn button 036
 Playback button 110
AF Auto Focus button 061
 Exposure compensation (button) .047
 LCD panel lamp button 069
 Lock button 119
AE-L AE-L button 048

A

AE Lock 048
AF by Press Halfway 061
Auto Power Off 073
Auto focus 040
Auto Rotation 068
Aperture 045
Auto Discharge 099
Auto mode 033
Auto EVC 063
Auto bracket 090
AdobeRGB 056
Aperture priority mode 084
AE-L 048
AF 040
AF Button Function 061

B

Built-in Flash 098
Battery grip 021
Bulb mode 087
Beep 070

C

Card access lamp 014
Contrast 054
Catch in Focus 061
Colour Tone 054
Colour temperature 092
Colour Temp. Unit 064
Colour Space 056

CUSTOM1 MENU 060
CUSTOM2 MENU 066
Continuous Shooting 036
Change File Name 074
Center-weighted metering 047
Compensating Flash Output 102
CAF 040

D

Dust Alert 075
Daylight-sync shooting 101
Drive mode 036
Digital Preview 038, 078
Digital Filter 078
Deleting images 116
Depth of Field 046
DPOF 138

E

Eyecup 146
Exposure 047
Exposure Warning 077
Exposure compensation 047
External Flash 105
Extended Bracket 057

F

Fill-in flash 100
Focus mode lever 040
Focusing Area 041
Focus indicator 043

Front dial 047
Format 070
File Format 055
Flash 098~107
Folder Name 073
Fixing the focus 042
Flash X-sync speed 088
Flash in Wireless Mode 069
Fn 036
Fine Tune when AWB 063

G

Green button 066

H

High-speed flash sync mode 106
High Noise 064
Histogram 030

I

Initial Zoom 068
ISO Sensitivity 096
ISO Steps 065
ISO Display 064
Interval shooting 057

J

JPEG Quality 055
JPEG Size 055

Correct Disposal of This Product



Correct Disposal of This Product (Waste Electrical & Electronic Equipment)

(Applicable in the European Union and other European countries with separate collection systems) This marking shown on the product or its literature, indicates that it should not be disposed of with other household wastes at the end of its working life.

To prevent possible harm to the environment or human health from uncontrolled waste disposal, please separate this from other types of wastes and recycle it responsibly to promote the sustainable reuse of material resources. Household users should contact either the retailer where they purchased this product, or their local government office, for details of where and how they can take this item for environmentally safe recycling. Business users should contact their supplier and check the terms and conditions of the purchase contract. This product should not be mixed with other commercial wastes for disposal.



Samsung Techwin cares for the environment at all product manufacturing stages to preserve the environment, and is taking a number of steps to provide customers with more environment-friendly products. The Eco mark represents Samsung Techwin's will to create environment-friendly products, and indicates that the product satisfies the EU RoHS Directive.

Correct disposal of batteries in this product



(Applicable in the European Union and other European countries with separate battery return systems.)

This marking on the battery, manual or packaging indicates that the batteries in this product should not be disposed of with other household waste at the end of their working life. Where marked, the chemical symbols Hg, Cd or Pb indicate that the battery contains mercury, cadmium or lead above the reference levels in EC Directive 2006/66. If batteries are not properly disposed of, these substances can cause harm to human health or the environment.

To protect natural resources and to promote material reuse, please separate batteries from other types of waste and recycle them through your local, free battery return system.

The rechargeable battery incorporated in this product is not user replaceable. For information on its replacement, please contact your service provider.

FCC notice

■ NOTE:

This equipment has been tested and found to comply with the limits for a Class B digital device, pursuant to part 15 of the FCC Rules. These limits are designed to provide reasonable protection against harmful interference in a residential installation. This equipment generates, uses and can radiate radio frequency energy and, if not installed and used in accordance with the instructions, may cause harmful interference to radio communications. However, there is no guarantee that interference will not occur in a particular installation. If this equipment does cause harmful interference to radio or television reception, which can be determined by turning the equipment off and on, the user is encouraged to try to correct the interference by one or more of the following measures:

- Reorient or relocate the receiving antenna.
- Increase the distance between the equipment and receiver.
- Connect the equipment into an outlet on a circuit different from that to which the receiver is connected.
- Consult the dealer or an experienced radio / TV technician for help.

■ CAUTION:

Changes or modifications not expressly approved by the manufacturer responsible for compliance could void the user's authority to operate the equipment.

■ Declaration of Conformity

Trade Name: SAMSUNG TECHWIN

Model No: Samsung GX-20

Responsible Party: SAMSUNG ELECTRONICS AMERICA INC.

Address: 105 Challenger Road (2nd Fl.) Ridgefield Park NJ

Telephone No: 1-800-SAMSUNG(726-7864)

This device complies with Part 15 of the FCC Rules. Operation is subject to the following two conditions: (1) This device may not cause harmful interference, and (2) this device must accept any interference received, including interference that may cause undesired operation.

MEMO

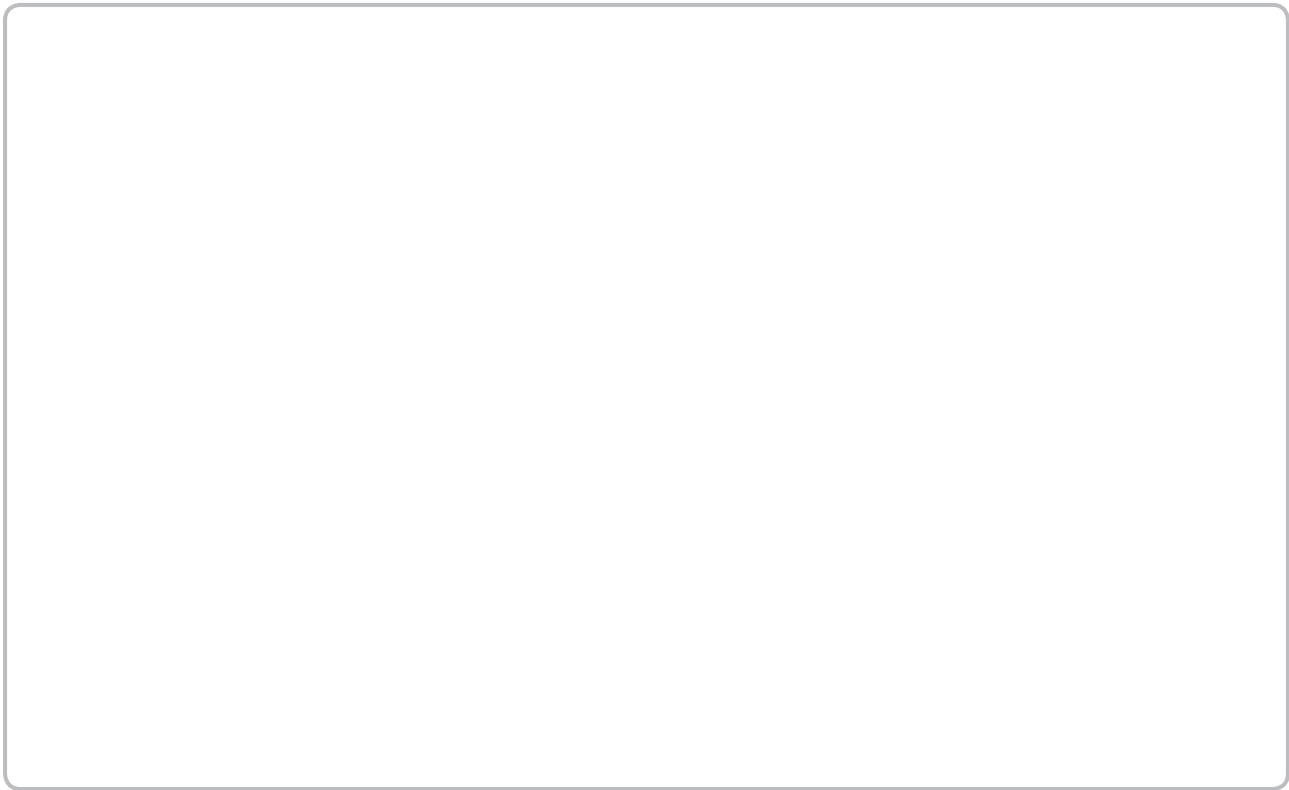
A large, empty rectangular box with rounded corners, intended for writing a memo. The box is outlined in a thin gray border and occupies the majority of the page below the 'MEMO' header.

MEMO

A large, empty rectangular box with rounded corners, intended for writing a memo. The box is outlined in a thin gray border and occupies most of the page below the header.



Please refer to the warranty that came with the product you purchased,
or go to our website <http://www.samsungcamera.com/> for after-sales service or inquiries.

Internet address - <http://www.samsungcamera.com>



The CE Mark is a Directive conformity
mark of the European Community (EC)