

The Samsung logo is located in the top left corner, consisting of the word "SAMSUNG" in a bold, white, sans-serif font, enclosed within a white, horizontally-oriented oval shape. The background of the entire page is a dark grey gradient with abstract, wavy, light grey patterns that resemble a fingerprint or a complex mesh structure.

**SAMSUNG**

# User Manual

i8

---

Thank you for buying a Samsung Camera.

This manual will guide you through using the camera, including capturing images, downloading images and using the application software. Please read this manual carefully before using your new camera.

ENGLISH

# Instructions

Use this camera in the following order.

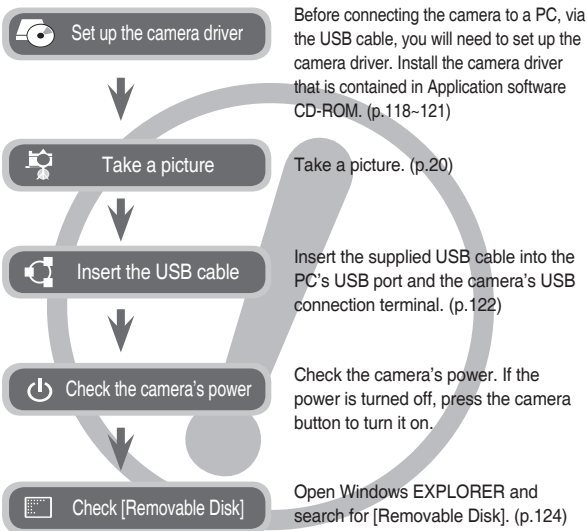

# Getting to know your camera

Thank you for buying a Samsung Digital Camera.

- Prior to using this camera, please read this user manual thoroughly.
- If you require After Sales service, please bring the camera and the cause of the camera malfunction (such as battery, Memory card etc.) to the A/S centre.
- Please check that the camera is operating properly prior to when you intend to use it (e.g. for a trip or an important event) to avoid disappointment. Samsung camera takes no responsibility for any loss or damages that may result from camera malfunction.
- Keep this manual in a safe place.
- The contents and illustrations of this manual are subject to change without prior notice for upgrading the camera functions.
- If you use a card reader to copy the images on the memory card to your PC, the images could be damaged. When transferring the images taken with the camera to your PC, be sure to use the supplied USB cable to connect the camera to your PC. Please note that the manufacturer accepts no responsibility for loss or damage of images on the memory card due to the use of a card reader.
- × Microsoft, Windows and Windows logo are registered trademarks of Microsoft Corporation incorporated in the United States and/or other countries.
- ×  is a trademark of SRS Labs, Inc. WOW HD technology is incorporated under license from SRS Labs, Inc.
- × All brand and product names appearing in this manual are registered trademarks of their respective companies.

## DANGER

---

DANGER indicates an imminently hazardous situation which, if not avoided, will result in death or serious injury.

- Do not attempt to modify this camera in any way. This may result in fire, injury, electric shock or severe damage to you or your camera. Internal inspection, maintenance and repairs should be carried out by your dealer or Samsung Camera Service centre.
- Please do not use this product in close proximity to flammable or explosive gases, as this could increase the risk of explosion.
- Should any form of liquid or a foreign object enter the camera, do not use it. Switch off the camera, and then disconnect the power source. You must contact your dealer or Samsung Camera Service centre. Do not continue to use the camera as this may cause a fire or electric shock.
- Do not insert or drop metallic or inflammable foreign objects into the camera through access points e.g. the memory card slot and battery chamber. This may cause a fire or electric shock.
- Do not operate this camera with wet hands. This could pose a risk of electric shock.

## WARNING

---

WARNING indicates a potentially hazardous situation which, if not avoided, could result in death or serious injury.

- Do not use the flash in close proximity to people or animals. Positioning the flash too close to your subject's eyes may cause eyesight damage.
- For safety reasons keep this product and accessories out of reach of children or animals to prevent accidents e.g.:
  - Swallowing battery or small camera accessories. If an accident should occur, please consult a doctor immediately.
  - There is the possibility of injury from the camera's moving parts.
- Battery and camera may become hot during prolonged use which might result in camera malfunction. Should this be the case, allow the camera to sit idle for a few minutes to allow it time to cool.
- Do not leave this camera in places subject to extremely high temperatures, such as a sealed vehicle, direct sunlight or other places of extreme variances in temperature. Exposure to extreme temperatures may adversely affect the camera's internal components and could cause a fire.
- When in use, do not cover the camera or Charger. This may cause heat to build up and distort the camera body or cause a fire. Always use the camera and its accessories in a well-ventilated area.

# CAUTION

---

CAUTION indicates a potentially hazardous situation which, if not avoided, may result in a minor or moderate injury.

- Leaking, overheating, or burst battery could result in fire or injury.
  - Use battery with the correct specification for the camera.
  - Do not short circuit, heat or dispose of battery in fire.
  - Do not insert the battery with the polarities reversed.
- Remove the battery when not planning to use the camera for a long period of time. Battery may leak corrosive electrolyte and permanently damage the camera's components.
- Do not fire the flash while it is in contact with hands or objects. Do not touch the flash after using it continuously. It may cause burns.
- Do not move the camera while it is switched on when you are using the AC Charger. After use, always switch off the camera before unplugging the cable from the wall socket. Then make sure that any connector cords or cables to other devices are disconnected before moving the camera. Failure to do so may damage the cords or cables and cause a fire or electric shock.
- Take care not to touch the lens or lens cover to avoid taking an unclear image and possibly causing camera malfunction.
- Avoid obstructing the lens or the flash when you capture an image.
- When using this camera in low temperatures, the following cases may be found. These are not camera malfunctions and usually recover at normal temperature.
  - It takes more time to turn on the LCD monitor and the colour may differ from the subject.
  - When changing the composition, there may be an after image on the LCD monitor.
- Credit cards may be demagnetized if left near case. Avoid leaving magnetic strip cards near the case.
- It is highly likely to result in computer malfunctions when the 20 pin connector is connected to the USB port of a PC. Never connect the 20 pin connector to USB port of a PC.

# Contents

---

## READY

- 007 System chart**
  - 007 Package Contents
  - 007 Sold Separately
- 008 Identification of features**
  - 008 Front & Top
  - 009 Back
  - 010 Bottom
  - 010 5 Function button
- 012 Connecting to a power source**
- 015 Inserting the battery**
- 015 Inserting the memory card**
- 016 Instructions on how to use the memory card**
- 018 When using the camera for the first time**

## RECORDING

- 019 LCD monitor indicator**
- 020 Starting the Recording mode**
  - 020 Selecting modes
  - 020 How to use the Auto mode
  - 021 How to use the Program mode
  - 021 How to use the DIS(Digital Image Stabilization) mode
  - 021 How to use the FUN mode
  - 022 Using the Photo Help guide mode
  - 023 How to use the Movie clip mode
  - 023 Recording the movie clip without sound
  - 023 Pausing while recording a movie clip (Successive Recording)



# Contents

---

- 024 How to use the Scene modes
- 025 Things to watch out for when taking pictures**
- 026 Focus lock**
- 026 Using the camera buttons to set the camera**
  - 026 POWER button
  - 027 Shutter button
  - 027 FD (Face Detection) button
  - 029 ZOOM W / T button
  - 030 Function Description / Info / Up button
  - 031 Macro / Down button
  - 032 Flash / Left button
  - 034 Self-timer / Right button
  - 036 MENU / OK button
  - 037 Fn button
    - 037 How to use the Fn menu
  - 038 Fn button: Size
  - 038 Fn button: Quality / Frame rate
  - 039 Fn button: Metering
  - 039 Fn button: Drive mode
  - 040 Fn button: ISO
  - 040 Fn button: White balance
  - 041 Fn button: Exposure compensation
  - 042 Fn button: Long time shutter
  - 043 E (Effect) button
  - 043 E (Effect) button: Photo Style Selector
  - 044 E (Effect) button: Image editing
    - 044 Colour
    - 045 Saturation
    - 045 Contrast

- 045 Sharpness
- 046 E (Effect) button: Cartoon
- 048 E (Effect) button: Pre-set focus frame
- 049 E (Effect) button: Composite shooting
- 051 E (Effect) button: Photo Frame
- 052 E (Effect) button: Colour Mask

## **053 Using the LCD monitor to adjust the camera settings**

- 053 Focus Area
- 054 ACB
- 054 Voice Memo
- 055 Voice recording
- 056 Recording the movie clip without voice

## **PLAY**

### **056 Starting play mode**

- 056 Playing back a still image
- 057 Playing back a movie clip
- 057 Movie clip capture function
- 058 On camera movie trimming
- 058 Playing back a recorded voice
- 059 Playing back a voice memo

### **059 LCD monitor Indicator**

### **060 Using the camera buttons to set the camera**

- 060 Play mode button
- 060 Thumbnail / Enlargement button
- 062 Info / Up button
- 062 Play & Pause / Down button
- 063 Left / Right / Menu / OK button
- 063 Print button

# Contents

---

	063	Delete button		080	DPOF
	064	E (Effect) button: Resize		082	Copy To Card
	065	E (Effect) button: Rotating an image		<b>083</b>	<b>Setup menu</b>
	065	E (Effect) button: Colour		<b>084</b>	<b>Sound</b>
	066	E (Effect) button: Image editing		084	Volume
	066	ACB		084	Start up sound
	066	Red eye removal		084	Shutter sound
	067	Brightness control		084	Beep Sound
	067	Contrast control		084	AF sound
	067	Saturation control		084	Self Portrait
	067	Noise effect		<b>085</b>	<b>Setup menu</b>
	068	E (Effect) button: FUN		<b>086</b>	<b>SETUP1</b>
	068	Cartoon		086	Language
	069	Photo Frame		086	Setting up the Date / Time / Date type
	070	Preset focus frames		087	Start up image
	071	Composite image		087	LCD brightness
	073	Sticker		087	Quick view
	073	Colour Filter		087	LCD save
	074	Colour mask		<b>088</b>	<b>SETUP2</b>
<b>SETUP</b>	<b>075</b>	<b>Setting up the play back function using the LCD monitor</b>		088	Formatting a memory
	076	Starting the slide show		088	Initialisation
	076	Start the slide show		089	File name
	077	Selecting Images		090	Imprinting the recording date
	077	Configure slide show effects		090	Auto power off
	078	Setting play interval		091	Selecting video out type
	078	Setting Background Music		092	Auto focus lamp
	079	Playback			
	079	Voice memo	<b>PRINT</b>	092	PictBridge
	079	Protecting images		093	PictBridge: Picture Selection
	079	Deleting images		094	PictBridge: Print Setting
				094	PictBridge: Reset

# Contents

---

## MULTIMEDIA

- 095 MP3 / PMP / TEXT VIEWER mode**
  - 095 Downloading files
- 096 Starting the MP3 / PMP / TEXT VIEWER mode**
- 098 LCD monitor indicator for MP3 / PMP / TEXT VIEWER mode**
- 099 Using the camera buttons to adjust the camera**
  - 099 Volume button
  - 099 Play & Pause / Seeking button
  - 099 Delete button
  - 100 Hold / Equalizer button
  - 100 Playlist button
- 101 Setting up the playback function using the LCD monitor**
  - 102 Resume
  - 102 Play mode
  - 102 Skin of MP3 player
  - 103 Playing back the slide show
  - 103 Setting slide show interval
  - 103 Delete all
  - 103 Frame search
  - 104 Display setting
  - 104 Information of DRM file
  - 104 Setting up the recording function in the MP3 mode
  - 104 Auto Scroll
  - 105 MP3 BGM Setting
  - 105 Language setting
- 105 World tour guide**

- 105 Download the tour guide information
- 106 World Tour Guide mode
- 108 Important notes**
- 110 Warning indicator**
- 111 Before contacting a service centre**
- 113 Specifications**

## SOFTWARE

- 116 Software notes**
- 117 System requirements**
- 117 About the software**
- 118 Setting up the application software**
- 122 Starting PC mode**
- 124 Removing the removable disk**
- 125 Setting up the USB Driver for MAC**
- 125 Using the USB Driver for MAC**
- 126 Removing the USB Driver for Windows 98SE**
- 126 Samsung Converter**
- 128 Samsung Master**
- 131 FAQ**

# System chart

---

Please check that you have the correct contents before using this product. The contents can vary depending on the sales region. To buy the optional equipment, contact your nearest Samsung dealer or Samsung service centre.

## Package Contents

---



Camera



User manual,  
Product warranty



Camera strap



AV cable



Rechargeable battery  
(SLB-0937)



AC adapter ( SAC-47)/  
USB cable (SUC-C3)



Software CD  
(see p.117~118)



Earphones



20 Pin Gender

## Sold Separately

---

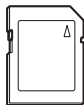

SD/SDHC memory card/  
MMC(see p.17)

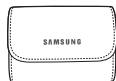

Camera case

# Identification of features

---

## Front & Top

---

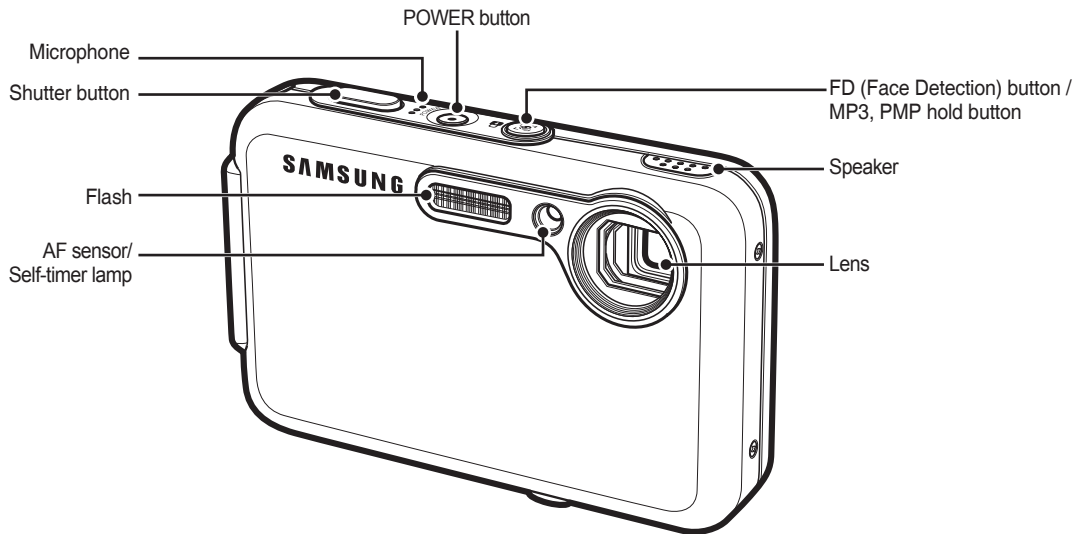

# Identification of features

## Back

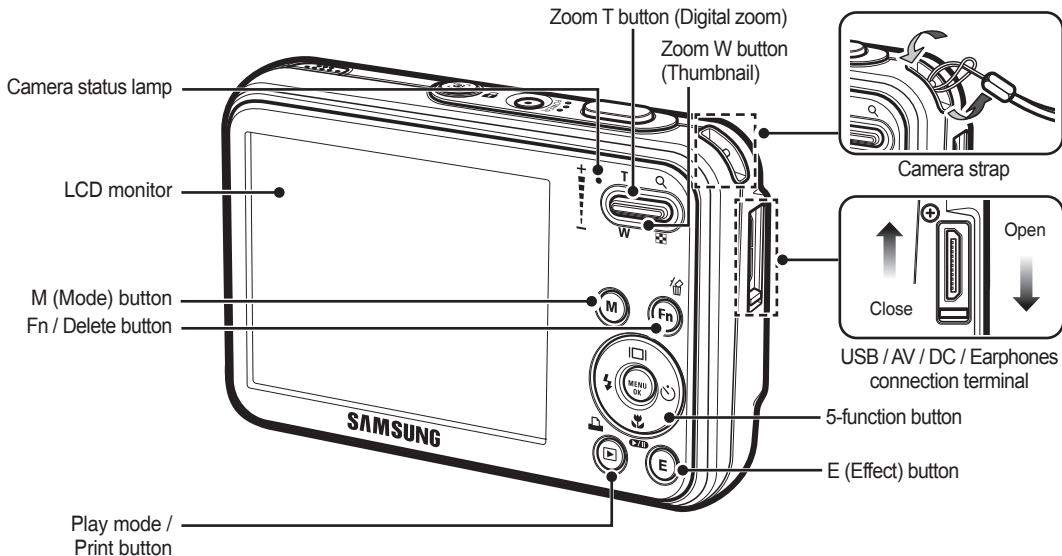

# Identification of features

## Bottom

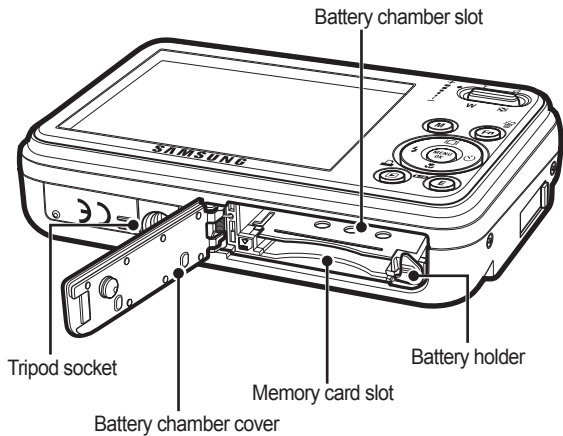

## 5 Function button

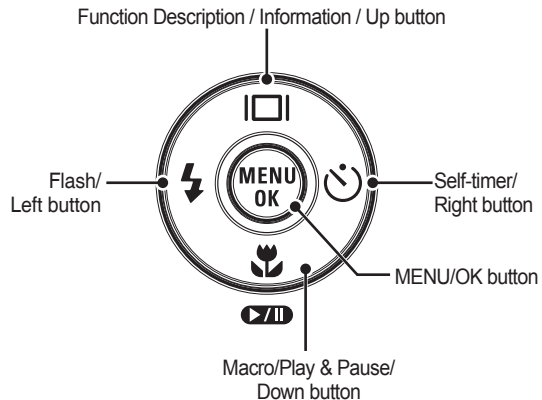

# Identification of features

## ■ Self-timer lamp

Icon	Status	Description
	Blinking	<ul style="list-style-type: none"> <li>For the first 8 seconds, the lamp blinks at 1 second intervals.</li> <li>For the final 2 seconds, the lamp blinks quickly at 0.25-second intervals.</li> </ul>
	Blinking	For the 2 seconds, the lamp blinks quickly at 0.25-second intervals.
	Blinking	A picture will be taken after about 10 seconds and 2 seconds later a second picture will be taken.
	Blinking	After pressing the <b>Shutter</b> button, the image is taken in accordance with the subject's movement.

## ■ Camera Status Lamp

Status	Description
<b>Power on</b>	The lamp turns on, and off when the camera is ready to take a picture.
<b>After taking a picture</b>	The lamp blinks while saving the image data and turns off when the camera is ready to take another picture.
<b>When the USB cable is inserted to a PC</b>	The lamp lights up. (LCD monitor turns off after initializing the device)
<b>Transmitting Data with a PC</b>	The lamp blinks. (LCD monitor turns off)

<b>When the USB cable is inserted to a printer</b>	The lamp blinks and turns off when the printer is ready to print a picture.
<b>When the printer is printing</b>	The lamp is off.
<b>When the AF activates</b>	The lamp turns on. (The camera is focused on the subject)
	The lamp blinks. (The camera doesn't focus on the subject)

- **Mode icon:** Refer to page 20 for more information about the camera mode setting.

	MODE						
<b>SHOOTING</b>	Auto	Program	DIS	FUN	Photo Help Guide	Movie	
<b>SCENE</b>	Nightscape	Portrait	Children	Landscape	Text	Close-up	Sunset
	Dawn	Back light	Fire works	Beach & Snow	Selfshot	Food	Cafe
<b>MULTI-MEDIA</b>	MP3	PMP	TEXT VIEWER	Travel Guide			



# Connecting to a power source

You should use the rechargeable battery SLB-0937 supplied with the camera. Be sure to charge the battery before using the camera.

## ■ SLB-0937 rechargeable battery Specification

<b>Model</b>	SLB-0937
<b>Type</b>	Lithium Ion
<b>Capacity</b>	900mAh
<b>Voltage</b>	3.7V
<b>Charging time (When the camera is turned off)</b>	Approx. 150 MIN

## ■ Number of images and battery life: Using the SLB-0937

	<b>Battery life /Number of images</b>	<b>Conditions</b>
<b>Still image</b>	Approx. 120 MIN/ Approx. 240 shots	Using the fully charged battery, Auto mode, 8M image size, Fine image quality, Shot to shot interval: 30Sec. Changing the zoom position between the Wide and the Tele after every shot. Using the flash on every second shot. Using the camera for 5 minutes and then Powering it off for 1 minute.
<b>Movie</b>	Approx. 120 MIN	Using the fully charged battery 640x480 image size 30fps frame rate

		<b>Battery life /Number of images</b>	<b>Conditions</b>
<b>Multimedia</b>	MP3	Approx. 300 MIN	Using the fully charged battery LCD Off.
	PMP	Approx. 220 MIN	Using the fully charged battery

\* These figures are measured under Samsung's standard conditions and shooting conditions and may vary depending on the user's methods.



Important information about battery usage.

- When the camera is not used, turn off the camera power.
- Please remove the battery if the camera will not be used for long periods. Batteries can lose power over time and are prone to leaking if kept inside the camera.
- Low temperatures (below 0°C) can affect the performance of the battery and you may experience reduced battery life.
- Batteries will usually recover at normal temperatures.
- During extended use of the camera, the camera body may become warm. This is perfectly normal.
- When you use earphones, do not remove the battery while the camera is turning on. It may generate a loud noise.

# Connecting to a power source

You can charge the rechargeable battery (SLB-0937) by using the SAC-47 KIT which consists of the AC adapter (SAC-47) and the USB cable (SUC-C3).

When the SAC-47 and SUC-C3 are combined, they can be used as an AC cable.

- Using an AC cable:  
Connect the AC adapter to the USB cable.  
It can be used as a power cable.

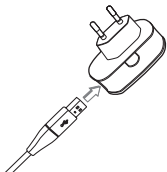

- Using a USB cable:  
Remove the AC adapter (SAC-47).  
You can download stored images to your PC (p.123) or supply the power to your camera through the USB cable.

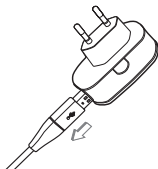

Important information about USB cable usage.

- Use a USB cable (SUC-C3) with the correct specification.
- If the camera is connected to the PC through a USB hub: connect the camera directly to the PC.
- If the camera and other devices are connected to the PC at the same time: remove other device.
- If the USB cable is connected to a port located on the front of the PC: remove the cable and connect it to a port located on the back of the PC.
- If the USB port of the PC doesn't meet the Power output standard (4.2V, 400mA), the camera may not be charged.

# Connecting to a power source

## ■ How to charge the rechargeable battery (SLB-0937)

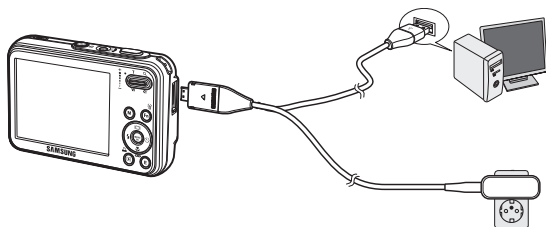

- Before inserting any cables or AC adapter, check the directions and do not insert by force. It may cause breakage of cable or camera.
- If the charging LED of the AC Charger does not turn on or blink after inserting the rechargeable battery, please check whether the battery is inserted correctly.
- If you charge the battery with the camera power on, the battery can't charge fully. Turn the camera off while charging the battery.

## ■ Charging LED of the AC Adapter

	Charging LED
Being Charged	Red LED is on
Charging is complete	Green LED is on
Charging error	Red LED is off or blinking
Being discharged (Using the AC adapter)	Orange coloured LED is on

- If you insert the fully discharged battery to charge it, do not turn on the camera at the same time. This is because of the low battery capacity. Charge the battery for more than 10 minutes before using the camera.
- Do not use the flash frequently or take a movie clip with the fully discharged battery charged for a short time. Even if the charger is inserted, the camera power may be turned off because the rechargeable battery is discharged again.



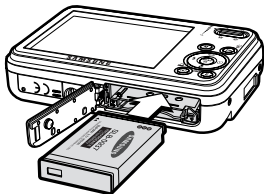

## Inserting the battery

Insert the battery as shown.

- If the camera does not turn on after you have inserted battery, please check whether the battery is inserted with the correct polarity (+/-).
- When opening the battery chamber cover, do not force it. This may cause damage to the battery chamber cover.



- There are 4 indicators for battery condition that are displayed on the LCD monitor.

Battery indicator				
Battery status	The battery is fully charged	Low battery capacity (Prepare to recharge or use spare battery)	Low battery capacity (Prepare to recharge or use spare battery)	Battery empty. Recharge or use spare battery.

## Inserting the memory card

Insert the memory card as shown.

- Turn off the camera's power before inserting the memory card.
- Have the front of the memory card facing toward the back of the camera (LCD monitor) and the card pins toward the front of the camera (Lens).
- Do not insert the memory card the wrong way round. Doing so may damage the memory card slot.

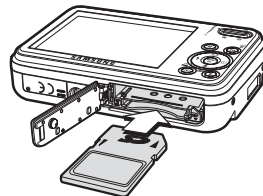

# Instructions on how to use the memory card

---

- Be sure to format the memory card (see p.88) if you are using a newly purchased memory for the first time, or if it contains data that the camera cannot recognise, or if it contains images captured with a different camera.
- Turn off the camera power whenever the memory card is being inserted or removed.
- Repeated use of the memory card will eventually reduce the memory card's performance. Should this be the case, you will need to purchase a new memory card. Wear and tear on the memory card is not covered by the Samsung warranty.
- The memory card is an electronic precision device. Do not bend, drop or subject the memory card to any heavy impact.
- Do not store the memory card in an environment with strong electronic or magnetic fields, e.g. near loud speakers or TV receivers.
- Please do not use or store in an environment where there are extremes in temperature.
- Do not allow the memory card to become dirty or to come into contact with any liquid. Should this happen, clean the memory card with a soft cloth.
- Please keep the memory card in its case when not in use.
- During and after periods of extended use, you may notice that the memory card is warm. This is perfectly normal.
- Do not use a memory card that is used in another digital camera. To use the memory card in this camera, format the memory card using this camera.
- Do not use a memory card formatted by another digital camera or memory card reader.
- If the memory card is subjected to any of the following, the recorded data may become corrupted:
  - When the memory card is used incorrectly.
  - If the power is switched off or the memory card is removed while recording, deleting (formatting) or reading.
- Samsung cannot be held responsible for lost data.
- It is advisable to copy important data onto other media as back-up e.g. floppy disks, hard disks, CD etc.
- If there is insufficient memory available:  
A [Memory Full!] message will appear and the camera will not operate. To optimise the amount of memory in the camera, replace the memory card or delete unnecessary images stored on the memory card.



- Don't remove the memory card when the camera status lamp is blinking as this may cause damage to data in the memory card.

# Instructions on how to use the memory card

The camera can use SD/ SDHC Memory Cards and MMC (Multi Media Cards).

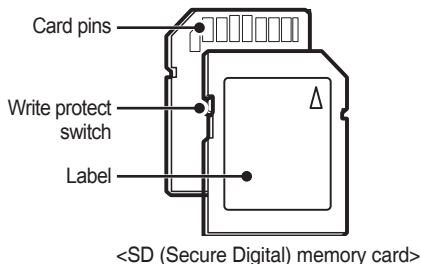

The SD/ SDHC memory card has a write protect switch that prevents image files from being deleted or formatted. By sliding the switch to the bottom of the SD memory card, the data will be protected. By sliding the switch to the top of the SD memory card, the data protection will be cancelled. Slide the switch to the top of the SD memory card before taking a picture.

When using a 256MB MMC memory, the specified shooting capacity will be as follows. These figures are approximate as image capacities can be affected by variables such as subject matter and memory card type.

	Recorded image size	Super Fine	Fine	Normal	30FPS	20FPS	15FPS
Still image	8M	53	94	135	-	-	-
	7M	60	107	171	-	-	-
	6M	71	133	202	-	-	-
	5M	86	161	220	-	-	-
	3M	134	226	306	-	-	-
* Movie clip	1M	434	520	600	-	-	-
	800	-	-	-	-	About 8'31"	-
	640	-	-	-	About 8'58"	-	About 16'59"
	320	-	-	-	About 28'56"	-	About 53'31"

\* The recording times can be changed by the zoom operation. The zoom button doesn't function during the movie recording.

# When using the camera for the first time

- Charge the rechargeable battery fully before using the camera for the first time.
- When the camera is turned on for the first time, a menu will be displayed to set date/time, language and battery type in the LCD monitor. This menu will not be displayed after setting up. Set up the date/time, language and battery type before using this camera.

## ■ Setting up the language

1. Select the [Language] menu by pressing the **Up/Down** button and press the **Right** button.
2. Select the desired sub menu by pressing the **Up/Down** button and press the **OK** button.

– You can select one of 22 languages.

These are listed below:

English, Korean, French, German, Spanish, Italian, S.Chinese, T.Chinese, Japanese, Russian, Portuguese, Dutch, Danish, Swedish, Finnish, Thai, Bahasa (Malay / Indonesian), Arabic, Czech, Polish, Hungarian and Turkish.



## ■ Setting up the date, time and date type

1. Select the [Date&Time] menu by pressing the **Up/Down** button and press the **Right** button.
2. Select the desired sub menu by pressing the **Up/Down/Left/Right** button and press the **OK** button.

**Right** button:

Selects world time/year/ month/day/hour/minute/date type

**Left** button:

Moves the cursor to the [Date&Time] main menu if the cursor is at the first item of the date and time setup. In all other instances, the cursor will be shifted to the left of its current position.

**Up/Down** button:

Changes the value of each item.

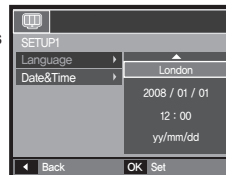

× For more information about the World Time, refer to the page 86.

# LCD monitor indicator

The LCD monitor displays information about the shooting functions and selections.

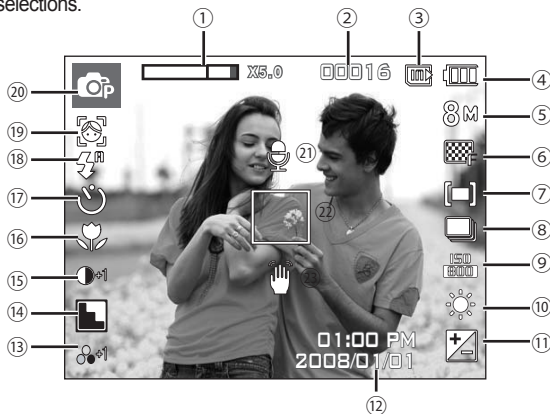

## <Image & Full Status>

No.	Description	Icons	Page
1	Optical/Digital Zoom bar/ Digital Zoom rate	x 5.0	p.29
2	Number of available shots remaining/Remaining time	00016/00:00:00	p.17
3	Memory card icon/ Internal memory icon indicator	/	-
4	Battery		p.15

No.	Description	Icons	Page
5	Image Size	8M [72] [64] 5M 3M 1M 800 640 320	p.38
6	Image Quality/Frame Rate		p.38
7	Metering	[M] [·] [ε]	p.39
8	Drive mode		p.39
9	ISO		p.40
10	White Balance		p.40
11	Exposure compensation /LongTime Shutter	/ LT	p.41/42
12	Date/Time	2008/01/01 01:00 PM	p.86
13	Saturation		p.45
14	Sharpness/Mic. off		p.45/23
15	Contrast		p.45
16	Macro		p.31~32
17	Self-timer		p.35~36
18	Flash		p.32~34
19	Face Detection · Self Portrait/Photo Style Selector/Colour		p.27~28/ p.43/p.44
20	Recording mode		p.11
21	Voice Memo		p.54
22	Auto Focus Frame		p.53
23	Camera shake Warning		p.21



# Starting the Recording mode

## Selecting modes

You can select the desired working mode using the **M (Mode)** button located on the back of the camera.

### ■ How to use the **M (Mode)** button

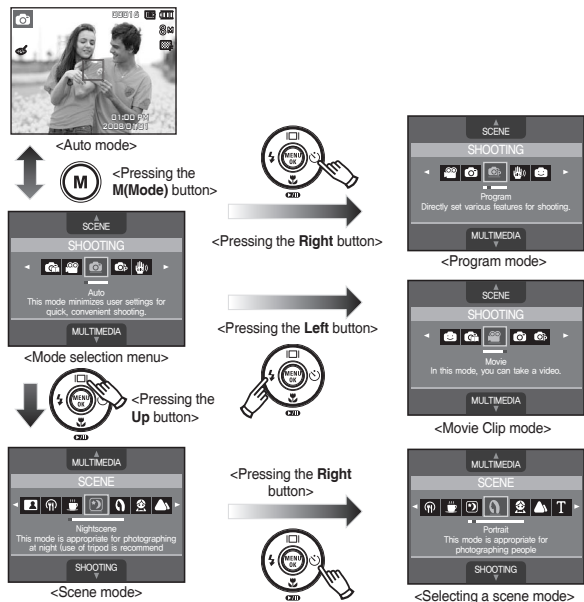

## How to use the Auto mode

Select this mode for quick and easy picture taking with minimal user interaction.

1. Insert the battery (p.15) taking note of the correct polarity (+/-).
2. Insert the memory card (p.15). As this camera has a 190MB internal memory, it is not essential to insert the memory card. If the memory card is not inserted, an image will be stored in the internal memory. If the memory card is inserted, an image will be stored on the memory card.
3. Close the battery chamber cover.
4. Press the **POWER** button to turn on the camera. (If the date/time that is displayed on the LCD monitor is incorrect, reset the date/time before taking a picture.)
5. Select the Auto mode by pressing the **M (Mode)** button.
6. Point the camera towards the subject and compose the image.
7. Press the **Shutter** button to capture an image.



- If the auto focus frame turns to red when you press the **Shutter** button down half way, it means that the camera cannot focus on the subject. Should this be the case, the camera is less likely to capture an image clearly.
- Avoid obstructing the lens or the flash when you capture an image.

# Starting the Recording mode

## How to use the Program mode

Selecting the automatic mode will configure the camera with optimal settings and you can manually configure various functions.

1. Select the Program mode by pressing the **M (Mode)** button (p.20).
2. Point the camera towards the subject and compose the image by using the LCD monitor.
3. Press the **Shutter** button to capture an image.

\* Refer to page 37-42 for more information about the Program mode menus.



- Things to watch out for using the DIS mode
  - The digital zoom will not operate in the DIS mode.
  - If the lighting conditions are brighter than fluorescent lighting conditions, the DIS will not activate.
  - If the lighting conditions are darker than in fluorescent lighting conditions, camera shake warning indicator (📵) will be displayed. For best results only take pictures in situations where the camera shake warning indicator (📵) is not displayed.
  - If the subject is moving, the captured image may be blurred.
  - Avoid moving the camera while the [Capturing!] message is displayed to achieve a better result.
  - As the DIS uses the camera's digital signal processor, it may take a little longer for the camera to process and save the images.
  - If the image size is (7M) or (6M), the DIS mode can't be selected.

## How to use the DIS(Digital Image Stabilization) mode

This mode will reduce the effect of camera shake and help you get a well exposed image in dim conditions.

1. Select the DIS mode by pressing the **M (Mode)** button. (p.20)
2. Point the camera towards the subject and compose the image by using the LCD monitor.
3. Press the **Shutter** button to capture an image.



## How to use the FUN mode

In this mode, you can take pictures with various effects easily and simply.

Select the FUN mode by pressing the **M (Mode)** button.

\* Refer to page 46-52 for more information.



# Starting the Recording mode

## Using the Photo Help guide mode

Helps the user learn the correct picture taking method and includes solutions for potential problems that may occur. This also enables the user to practice the best way to take the pictures.

- Function that can be used when focusing is difficult

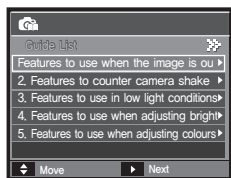

Pressing the  
Left/Right button.

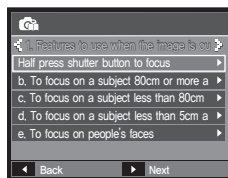

Pressing the  
Left/Right button.

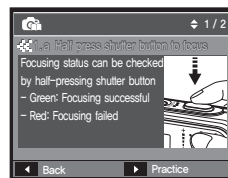

Pressing the MENU button.

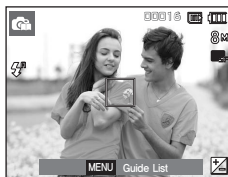

Pressing the  
Shutter button.

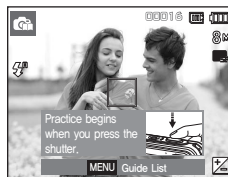

Pressing the  
Right button.

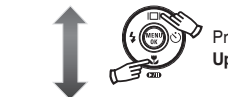

Pressing the  
Up/Down button.

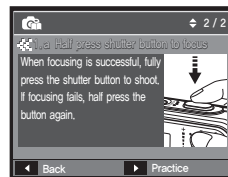

Available functions of the photo help guide

- Function that can be used when focusing is difficult
- Functions that can be used when the image is blurred
- Function that can be used when filming in the dark
- Function that can be used when adjusting the picture brightness
- Function that can be used when adjusting the picture colour

# Starting the Recording mode

## How to use the Movie clip mode

A movie clip can be recorded for up to 2hours.

1. Select the Movie clip mode by pressing the **M (Mode)** button. (p.20)
2. Point the camera towards the subject and compose the image by using the LCD monitor.
3. Press the **Shutter** button once and movie clips are recorded for up to 2hours. Movie clips will still be recorded if the **Shutter** button is released.

If you wish to stop recording, press the **Shutter** button again.

- \* Image size and type are listed below.
  - Image size: 800x592, 640x480, 320x240
  - Movie clip file type: AVI (MPEG-4)
  - Frame Rate: 30FPS, 20FPS, 15FPS
  - The frame rate can be selected when the following image size is selected.
    - 800x592: 20FPS selectable
    - 640x480, 320x240: 30FPS, 15FPS selectable



6. Press the **Down** button to select the [Voice Mute] menu and press the **Right** button.
7. Select the [On] menu by pressing the **Up/Down** button.
8. Press the **OK** button. You can record a movie without sound.

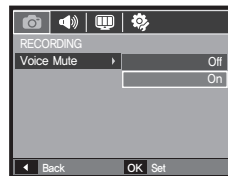

## Pausing while recording a movie clip (Successive Recording)

This camera allows you to temporarily stop during unwanted scenes, while recording a movie clip. Using this function, you can record your favourite scenes into a movie clip without having to create multiple movie clips.

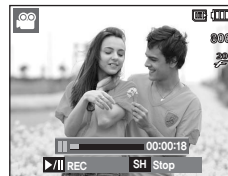

### ■ Using Successive Recording

Steps from 1-2 are the same as those for Movie clip mode.

3. Point the camera towards the subject and compose the image by using the LCD monitor. Press the **Shutter** button and movie clips are recorded for as long as the available recording time. Movie clips will still be recorded if the **Shutter** button is released.
4. Press the **Play & Pause (⏮)** button to pause recording.
5. Press the **Play & Pause (⏮)** button again to resume the recording.
6. If you wish to stop recording, press the **Shutter** button again.

## Recording the movie clip without sound

You can record the movie clip without sound.

Steps from 1-3 are the same as those for Movie clip mode.

4. Press the **MENU** button.
5. Select the [RECORDING] menu by pressing the **Left/Right** button.



# Starting the Recording mode

## How to use the Scene modes

Use the menu to easily configure optimal settings for a variety of shooting situations.

1. Select the Scene mode by pressing the **M (Mode)** button (p.20).
2. Point the camera towards the subject and compose the image by using the LCD monitor.
3. Press the **Shutter** button to capture an image.



- The scene modes are listed below.

Icons	Scene modes	Description
	[Nightscape]	Use this for shooting still images at night or in other dark conditions.
	[Portrait]	To take a picture of a person.
	[Children]	To take a picture of fast moving objects, for example, children.
	[Landscape]	To take pictures of distant scenery.
	[Text]	Use this mode to shoot a document.
	[Close up]	Close-up shooting for small objects such as plants and insects.
	[Sunset]	For taking pictures of sunsets.
	[Dawn]	Daybreak scenes.
	[Backlight]	Portrait without shadows caused by backlight.
	[Firework]	Firework scenes.
	[Beach&Snow]	For ocean, lake, beach and snowscape scenes.
	[Self Shot]	Use when the photographer would also like to appear in the image.
	[Food]	For taking delicious looking food.
	[Café]	For taking pictures in cafes and restaurants.

# Things to watch out for when taking pictures

- Pressing the **Shutter** button down half way.  
Lightly press the **Shutter** button to confirm focus and flash battery charge.  
Press the **Shutter** button all way down to take the picture.

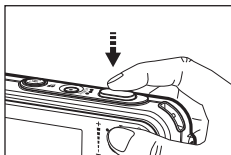

<Lightly press the **Shutter** button>

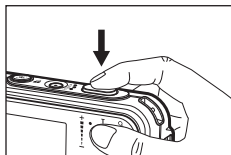

<Press the **Shutter** button down all the way>

- The available memory capacity may vary depending on shooting conditions and camera settings.
- When the Flash Off or Slow synchro mode is selected in a low lighting condition, the camera shake warning indicator ( ) may appear on the LCD monitor. In this case, use a tripod, support the camera on a solid surface or change to flash shot mode.
- Shooting against the light: Please do not take pictures against the sun. Doing so may make the picture dark. To take a picture against the light, please use the [Backlight] in the scene shooting mode (see page 24), fill-in flash (see page 33), spot metering (see page 39), or exposure compensation (see page 41).
- Avoid obstructing the lens or the flash when you capture an image.
- Compose the image by using the LCD monitor.
- Under certain conditions the auto focus system may not perform as expected.
  - When photographing a subject that has little contrast.
  - If the subject is highly reflective or shiny.
  - If the subject is moving at high speed.
  - When there is strong reflected light, or when the background is very bright.
  - When the subject matter has only horizontal lines or the subject is very narrow (such as a stick or flagpole).
  - When the surroundings are dark.

## Focus lock

To focus on a subject not positioned in the centre of the picture, use the focus lock function.

### ■ Using the Focus Lock

1. Ensure the subject is in the centre of the autofocus frame.
2. Press the **Shutter** button halfway. When the green auto focus frame lights up, it means the camera is focused on the subject. Be careful not to press the **Shutter** button all the way down to avoid taking an unwanted picture.
3. With the **Shutter** button still pressed down only halfway, move the camera to recompose your picture as desired, and then press the **Shutter** button completely to take the picture. If you release your finger from the **Shutter** button, the focus lock function will be cancelled.



1. The image to be captured.



2. Press the **Shutter** button halfway and focus on the subject.



3. Recompose the picture and fully depress the **Shutter** button.

## Using the camera buttons to set the camera

The recording mode function can be set up by using the camera buttons.

## POWER button

Used for turning the camera's power on/off. If there is no operation during the specified time, the camera's power will be turned off automatically to save battery life. Refer to page 90 for more information about the auto power off function.

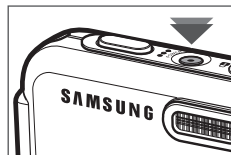

## Shutter button

Used for taking an image or recording voice in the Recording mode.

- In Movie clip mode  
Pressing the **Shutter** button down fully starts the process for recording a movie clip. Press the **Shutter** button once and the movie clip is recorded for as long as the available recording time in the memory allows. If you wish to stop recording, press the **Shutter** button again.
- In Still image mode  
Pressing the **Shutter** button down halfway activates the autofocus and checks the condition of the flash. Pressing the **Shutter** button down fully takes and stores the image. If you select voice memo recording, the recording will start after the camera has finished storing the image data.

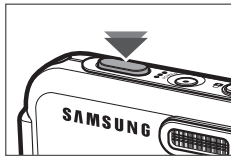

## FD (Face Detection) button

This mode detects the face position of the subject automatically and then sets the focus and exposure. Select this mode for quick and easy face picture. In MP3 and PMP mode, this button will lock the camera buttons.

- × Selectable modes: [Auto], [Program], [DIS], [FUN], [Photo Help Guide], Scene modes ([Portrait], [Children], [Beach & Snow], [Self-shot], [Café])

1. Press the **FD** (Face Detection) button (FD icon) in the selectable modes. The FD icon will be displayed on the left side of the screen.

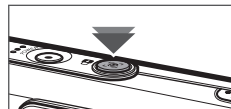

2. The size and position of the auto focus frame is set at the face of the subject automatically.
3. Press the **Shutter** button halfway. The focus frame turns to green when the focus is activated.
4. Press the **Shutter** button fully to take a picture.





# FD (Face Detection) button



- This function can detect up to 9 people.
- When the camera recognises many people at the same time, it will focus on the nearest person.
- The Digital zoom is not activated in this mode.
- The effects functions are not activated in this mode.
- When the camera detects a target face, the white colour focus frame will be displayed over the target face and the gray colour focus will appear over the remaining faces(up to 8). Press the **Shutter** button halfway down to focus on the face and the white focus frame turns green.(Total 9)
- Return to previous AF mode if face detection was failure.
- In some conditions this function cannot work properly.
  - When a person wears dark glasses or some part of the face is hidden.
  - When the person being taken does not look at the camera.
  - When the camera doesn't detect a face because of too much or too little light.
  - There is too great a distance between the camera and the subject.
- The maximum available Face Detection range is 3m (Wide).
- The nearer the subject, the faster the camera can recognize the subject.

## ■ Self Portrait

When taking pictures of yourself, the area of your face is automatically detected so that you can take self pictures more easily and quickly.

× Selectable modes: [Auto], [Program], [DIS], [FUN], [Photo Help Guide], Scene modes ([Portrait], [Children], [Beach & Snow], [Self-shot], [Café])

1. When pressing the Face Detection button again on the face location screen, the Self Portrait icon () appears.

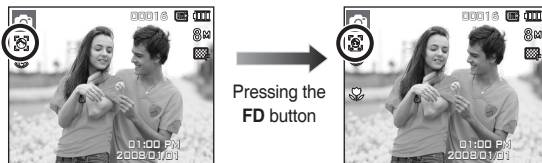

2. For self-filming, set the camera lens towards the face of the object. It automatically detects the face of the object, and emits a guiding sound.
3. Start filming by pressing the **Shutter** button.



- When locating the face in the center of the screen, it repeatedly emits a faster sound unlike the sounds that are emitted when the face is not in the center.
- The guiding sound can be set using the sound setting menu. (p.83)
- If [Self Portrait] is set, it is fixed to Macro focus.
- If [Self Portrait] is set, Motion Timer cannot be selected.

# ZOOM W / T button

If the menu is not displayed, this button works as the OPTICAL ZOOM or DIGITAL ZOOM button. This camera has a 3X optical zoom and a 5X digital zoom function. Using both will offer a total zoom ratio of 15X.

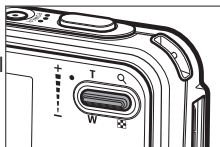

## TELE Zoom

**Optical zoom TELE:** Pressing the **Zoom T** button. This will zoom into the subject i.e. the subject will appear nearer.

**Digital zoom TELE:** When the maximum (3X) optical zoom is selected, pressing the **Zoom T** button activates the digital zoom software. Releasing **Zoom T** button stops the digital zooming at the required setting. Once the maximum digital zoom (5X) is achieved, pressing the **Zoom T** button will have no effect.



## WIDE Zoom

**Optical zoom WIDE:** Pressing the **Zoom W** button. This will zoom out from the subject i.e. the subject will appear further away. Pressing the **Zoom W** button continuously will set the camera to its minimum zoom setting i.e. the subject appears at its furthest from the camera.



**Digital zoom WIDE:** When the digital zoom is in operation, pressing the **Zoom W** button will reduce the digital zooming in steps. Releasing **Zoom W** button stops digital zooming. Pressing the **Zoom W** button will reduce the digital zoom and then it will continue to reduce the optical zoom until the minimum setting is reached.

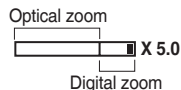

## ZOOM W / T button



- Images taken using the digital zoom may take a little longer for the camera to process. Allow time for this to take place.
- The digital zoom cannot be used in movie clip shots.
- You may notice a decrease in image quality when using the digital zoom.
- To view a clearer digital zoom image, press the **Shutter** button halfway at the maximum optical zoom position and press the **Zoom T** button again.
- The digital zoom can't be activated in some Scene modes (Nightscene, Children, Text, Close-up, Fireworks, Food), Face Detection mode, DIS mode, the Movie Clip mode and FUN recording mode.
- Take care not to press the lens as this may cause a camera malfunction.
- It is possible that beep and button sounds of the camera can be recorded while shooting the movie clips.

## Function Description / Info (Info) / Up button

While the menu is showing, the **Up** button operates as a direction button. If the menu screen does not appear, information or function descriptions of the current filming image (filming mode) can be accessed through the liquid crystal monitor by pressing the Function description/ Information (Info) button.



- **Function description:** When pressing the Function description button on the information screen mode, detailed descriptions of the functions can be viewed. The function description can be cancelled by pressing the Function description button again.



<Examples of Function descriptions>

# Macro (🌷) / Down button

While the menu is showing, press the **Down** button to move from the main menu to a sub menu, or to move down the sub menu. When the menu is not showing, you can use the **Macro/Down** button to take macro pictures. The distance ranges are shown below. Press the **Macro** button until the desired macro mode indicator appears on the LCD monitor.



<Auto Focus>



<Macro (🌷)>



<Auto Macro (🌷)>



<Super Macro (🔍)>

- Types of focus mode and focus range (W: Wide, T: Tele) (Unit: cm)

Mode	Auto (📷)		
Focus Type	Super macro (🔍)	Auto macro (🌷)	Normal
Focus range	—	W: 5 ~ Infinity T: 40 ~ Infinity	W: 80 ~ Infinity T: 80 ~ Infinity
Mode	Program (📷)		
Focus Type	Super macro (🔍)	Macro (🌷)	Normal
Focus range	W: 1 ~ 5 (Wide only)	W: 5 ~ 80 T: 40 ~ 80	W: 80 ~ Infinity T: 80 ~ Infinity
Mode	DIS mode (👤)		
Focus Type	Super macro (🔍)	Auto macro (🌷)	Normal
Focus range	—	W: 5 ~ Infinity T: 40 ~ Infinity	W: 80 ~ Infinity T: 80 ~ Infinity
Mode	FUN mode (😊)		
Focus Type	Super macro (🔍)	Macro (🌷)	Normal
Focus range	—	W: 5~80 T: 40~80	W: 80 ~ Infinity T: 80 ~ Infinity



- When the macro mode is selected, be particularly careful to avoid camera shake.
- When you take a picture within 30cm (Wide zoom) or 50cm (Tele zoom) in the Macro mode, select the FLASH OFF mode.
- When you take a picture within the 5cm Super macro range, the autofocus on the camera will take longer to set the correct focus distance.

## Macro (🌸) / Down button

- Available focusing method, by Recording mode

(●: Selectable, ∞: Infinity focus range)

Mode	Auto macro	Super macro	Macro	Normal
	●			●
		●	●	●
	●			●
		●	●	●
		●	●	●
			●	●
Mode	SCENE			
	Auto macro	Super macro	Macro	Normal
				●
				●
				●
				●
	●			
			●	
				●
				●
				●
				∞
				●
			●	
			●	
				●

## Flash (⚡) / Left button

When the menu is displayed on the LCD monitor, pressing the **Left** button makes the cursor shift to the left tab.

When the menu is not displayed on the LCD monitor, the **Left** button operates as the **Flash**(⚡) button.

- Selecting the flash mode

- Press the **Mode** button to select a Recording mode with the exception of the Movie clip mode or the DIS mode. (p.20)
- Press the **Flash** button until the desired flash mode indicator is displayed on the LCD monitor.
- A flash mode indicator will be displayed on the LCD monitor. Use the correct flash to suit the environment.

- Flash range (Unit: m)

ISO	Normal		Macro		Auto macro	
	WIDE	TELE	WIDE	TELE	WIDE	TELE
AUTO	0.8 ~ 3.3	0.8 ~ 2.4	0.3 ~ 0.8	0.5 ~ 0.8	0.3 ~ 3.3	0.5 ~ 2.4

- × When the Super Macro is selected, flash is fixed as the Flash Off mode.

## Flash (⚡) / Left button



- If you press the **Shutter** button after selecting the Auto, Fill-in, Slow synchro flash, the first flash fires to check the shooting condition (Flash range and Power ratio of flash). Do not move the camera until the second flash fires.
- Using the flash frequently will reduce the life of the battery.
- Under normal operating conditions the re-charging time for the flash is usually within 4 seconds. If the battery is weak, the charging time will be longer.
- In the DIS mode, [Landscape], [Close up], [Text], [Sunset], [Dawn], [Firework], [Self Shot], [Food], [Café] scene modes and the Movie clip mode, the flash function will not operate.
- Take photographs within the flash range.
- The image quality is not guaranteed if the subject is too close or highly reflective.
- When taking an image in poorly lit conditions with the flash, there may be a white speck in the captured image. The speck is caused by the the flash light reflecting off atmospheric dust.

### ■ Flash mode indicator

Icon	Flash mode	Description
	Auto flash	If the subject or background is dark, the camera flash will operate automatically.
	Auto & Red eye education	If a subject or background is dark, the camera flash will work automatically and will reduce the red-eye effect by using the red-eye reduction function.
	Fill in flash	The flash fires regardless of the available light. The intensity of the flash will be automatically controlled to suit the prevailing conditions.
	Slow synchro	The flash operates with a slow shutter speed to obtain a balanced correct exposure. In poor lighting conditions the camera shake warning indicator (⚠) will display on the LCD monitor.
	Flash off	The flash does not fire. Select this mode when capturing images in a place or situation where flash photography is prohibited. When you capture an image in a poorly lit condition, the camera shake warning indicator (⚠) will appear on the LCD monitor.
	Red-eye reduction	When a shot with "red eye" is detected, this mode will reduce the red-eye effect automatically.



## Self-timer (☺) / Right button

### ■ Selecting the self-timer

1. Select a Recording mode with the exception of Voice recording mode. (p.20)
2. Press the **Self-timer** (☺) button until the desired mode indicator displays on the LCD monitor.
3. When you press the **Shutter** button, the picture will be taken after the specified time has elapsed.



<Selecting the 10 SEC self-timer>

Icon	Self-timer Mode	Description
☺	10SEC self-timer	Pressing the <b>Shutter</b> button will allow an interval of 10 seconds before the image is taken.
☺ <sup>25</sup>	2SEC self-timer	Pressing the <b>Shutter</b> button will allow an interval of 2 seconds before the image is taken.
☺☺	Double self-timer	A picture will be taken after about 10 seconds and 2 seconds later a second picture will be taken.
☺☺☺	Motion Timer	The camera detects the subject's movement 6 seconds after pressing the <b>Shutter</b> button, and the picture is taken when the movement is stopped.

### ■ Motion Timer

Motion	Icon & Self-timer lamp
Pressing the Shutter button after setting the Motion Timer	Blink (1 second interval)
Detecting the subject's movement	Blink (0.25 second interval)
No movement is detected	Turn on and the image is taken after 2 seconds.

### ■ The Motion Timer flows are as followings.(Movie Clip mode excluded)

Selecting the Motion Timer → Pressing the Shutter button → Confirming the composition (Within 6 sec.)<sup>\*1</sup> → Starting the detection (Swing your hands fully)<sup>\*2</sup> → Stopping the detection (Do not move) → Taking an image (after 2 sec.)

\*1: The camera detects the subject's movement 6 seconds after pressing the Shutter button, so confirm the composition within 6 seconds.

\*2: Move your body or hands fully.



## Self-timer (☺) / Right button



In the following cases, the Motion Timer may not operate.

- The focus distance is over 3m.
- The exposure is too bright or dark
- In backlight conditions.
- The movement is insignificant
- The movement is detected out of the center part (50%) of the sensor where the movement is recognized.
- If the camera doesn't sense any movement for 30 seconds, or the camera doesn't sense stillness after sensing movement



<The detection range of Motion Timer>

## MENU / OK button

### ■ MENU button

- When you press the **MENU** button, a menu related to each camera mode will be displayed on the LCD monitor. Pressing it again will return the LCD to the initial display.
- A menu option can be displayed when the following are selected: Movie clip and Still image mode. There is no menu available when the Voice recording or Photo Help Guide mode is selected.



<Menu off>

Pressing the **MENU** button



<Menu on>

### ■ OK button

- When the menu is displayed on the LCD monitor, this button is used for shifting the cursor to the sub menu or for confirming data.

# Fn button

You can use the **Fn** button to set the following menus.

(●: Selectable)

					SCENE		Page
[SIZE]	●	●	●	●	●	●	p.38
[QUALITY/ FRAME RATE]	●	●	●	●	●	●	p.38
[METERING]		●	●	●		●	p.39
[DRIVE]		●					p.39
[ISO]		●					p.40
[WHITE BALANCE]		●	●			●	p.40
[EXPOSURE VALUE]		●	●			●	p.41
[LONG TIME SHUTTER]					*1 ●		p.42

\*1 This menu is only available in the Night scene mode ().

## How to use the Fn menu

1. Press the **Fn** button in an available mode
2. Select a desired menu by pressing the **Up/Down** button. And then a sub menu will be displayed on the left side of the LCD monitor.

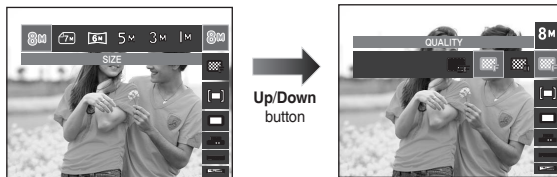

3. Select a desired menu by pressing the **Left/Right** button and then press the **OK** button.

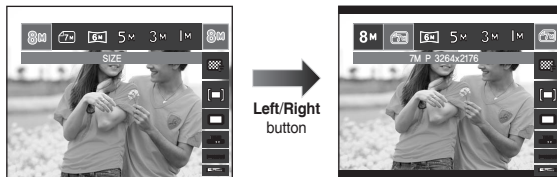

## Fn button: Size

You can select the image size appropriate for your application.

Still image Mode	Icon	8M	7M	6M	5M	3M	1M
	Size	3264x2448	3264x2176	3264x1836	2592x1944	2048x1536	1024x768
Movie clip Mode	Icon	800	640	320			
	Size	800x592	640x480	320x240			



< Still image mode >

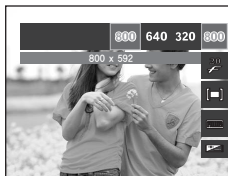

< Movie clip mode >



- The higher the resolution, the lower the number of shots available because high resolution images use more memory.

## Fn button: Quality / Frame rate

You can select the compression ratio appropriate for your application of the captured images. The higher the compression ratio, the lower the picture quality.

Mode	Still image Mode			Movie clip mode		
Icon						
Sub menu	Super Fine	Fine	Normal	30FPS	20FPS	15FPS
File Format	jpeg	jpeg	jpeg	avi	avi	avi

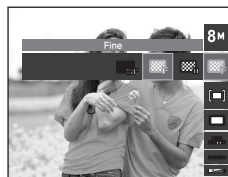

< Still image mode >



< Movie clip mode >





- This file format complies with the DCF (Design rule for Camera File system).
- JPEG (Joint Photographic Experts Group): JPEG is the image compression standard developed by the Joint Photographic Experts Group. This type of compression is most commonly used for compressing photos and graphics because it can compress the files efficiently.

## Fn button: Metering

If you cannot obtain suitable exposure conditions, you can change the metering method to take brighter pictures.







Icon	Metering Mode	Description
	[Multi]	Exposure will be calculated based on an average of light in each image area divided into multiple regions. However, the calculation will be biased towards the centre of the image area. This is suitable for general use.
	[Spot]	Only the rectangular area in the centre of the LCD monitor will be metered for light. This is suitable when the subject in the centre is exposed correctly, regardless of the back lighting.
	[Center]	Exposure will be calculated based on an average of the available light in the image area. However, the calculation will be biased towards the centre of the image area. This is suitable for taking a picture of small objects like flowers or insects.

× If the subject is not the centre of the focus area, do not use the spot metering as this may result in an exposure error. In this circumstance, it is better to use exposure compensation.

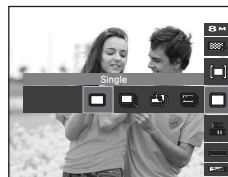
## Fn button: Drive mode

You can select continuous shot, and AEB (Auto Exposure Bracketing).



Icon	Drive Mode	Description
	[Single]	Take one picture only.
	[Continuous]	Images will be taken continuously until the <b>Shutter</b> button is released.
	[Motion Capture]	This takes 6 shots per second for up to 5 seconds, when the shutter is pressed and held down. After completing the continuous shooting, images are saved automatically. The maximum number of shots is 30 and the image size is fixed as VGA.
	[AEB]	Take three pictures in a series in different exposures: standard exposure (0.0EV), short exposure (-1/3EV) and over exposure (+1/3EV).

## Fn button: ISO

You can select the ISO sensitivity when taking pictures.  
The speed or specific light-sensitivity of a camera is rated by ISO numbers.



Icon	ISO Mode	Description
	[Auto]	The camera's sensitivity is automatically changed by variables such as lighting value or subject brightness.
	[ISO 80]	You use a faster (shorter) shutter speed while the same amount of light is present, by increasing the ISO sensitivity. However, the image may be saturated in high luminance. The higher the ISO value, the higher the camera's sensitivity to light and therefore the greater its capacity to take pictures in darker conditions. However, the noise level in the image will increase as the ISO value increases, making the image appear coarse.
	[ISO 100]	
	[ISO 200]	
	[ISO 400]	
	[ISO 800]	
	[ISO 1600]	
	[ISO 3200]	

× When the ISO 3200 menu is selected, the image size is fixed as 3M.

## Fn button: White balance

The white balance control allows you to adjust the colours to appear more natural.



Icon	White balance Mode	Description
	[Auto WB]	The camera automatically selects the appropriate white balance settings, depending on the prevailing lighting conditions.
	[Daylight]	For taking images outside.
	[Cloudy]	For taking images under a cloudy or overcast sky.
	[Fluorescent_H]	For shooting under daylight fluorescent types of threeway fluorescent lighting.
	[Fluorescent_L]	For shooting under white fluorescent lighting.
	[Tungsten]	For shooting under tungsten (standard light bulb) lighting.
	[Custom Set]	Allows the user to set the white balance according to the shooting conditions.

× Different lighting conditions may cause a colour cast on your images.

## Fn button: White balance

### ■ Using the Custom White Balance

White balance settings may vary slightly depending on the shooting environment. You can select the most appropriate white balance setting for a given shooting environment by setting up the custom white balance.

1. Select the CUSTOM (  ) menu of the White Balance and place a sheet of white paper in front of the camera so that the LCD monitor shows only white.

2. **MENU/OK** button: Selects previous custom white balance.

**Shutter** button: saves new custom white balance.

- The custom white balance value will be applied, starting with the next picture you take.
- The user configured white balance will remain effective until it is overwritten.

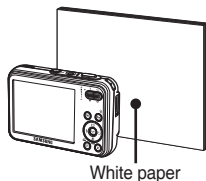

## Fn button: Exposure compensation

This camera automatically adjusts the exposure according to the ambient lighting conditions.

You can also select the exposure value by using the **Fn** button.

### ■ Compensating Exposure

1. Press the **Fn** button, and then use the **Up/Down** button to select the exposure compensation (  ) icon. The exposure compensation menu bar will appear as shown.

2. Use the **Left/Right** button to set the desired exposure compensation factor.

3. Press the **Fn** button again. The value you set will be saved and the Exposure Compensation setup mode will close. If you change the exposure value, the exposure indicator (  ) will be displayed on the bottom of the LCD monitor.

- × A negative exposure compensation value reduces the exposure. Note that a positive exposure compensation value increases the exposure and the LCD monitor should appear white or you may not get good pictures.



## Fn button: Long time shutter

This camera automatically adjusts the shutter speed and aperture values to the shooting environment. However, in Night scene mode, you can set the shutter speed and aperture values to your preference.

- Changing the Shutter speed and Aperture value
  1. Select the [Nightscene] mode. (p.24)
  2. Press the **Fn** button and Long Time shutter menu will be displayed.
  3. Configure the Long Time shutter value with the 5 function button.
  4. Press the **Fn** button again. The value you set will be saved and the mode will switch to Night scene mode.



Aperture Value

Wide: Auto, F3.5 ~ 6.2  
Tele: Auto, F4.5 ~ 8.0

Shutter Speed

Auto, 1 ~ 16S

## E (Effect) button

It is possible to add special effects to your images by using this button.

- Available Effects, by recording mode (●: Selectable)

Mode	E button	Mode	E button
	●		
	●		●
	●		
	●		
	●		
	●		
	●		
	●		●
	●		●
	●		●



- This button will not operate in DIS, Voice recording mode and some scene modes ([Nightscene], [Text], [Sunset], [Dawn], [Backlight], [Firework], [Beach&Snow]).
- Even if the camera is turned off, the effect setting will be preserved.
- If the image size is (L7M) or (L6M), the FUN menu can't be selected.

## E (Effect) button: Photo Style Selector

You can add various effects to the image without using image editing software. Press the **E** button in an available mode.



- Select the desired Photo style selector by pressing the **Left/Right** button and press the **OK** button.
- Press the **Shutter** button to take an image.

Icon	Style mode	Description
<b>NOR</b>	[Normal]	No style effect is added to the image.
	[Soft]	The image will be applied with the soft colours.
	[Vivid]	The image will be applied with the vivid colours.
	[Forest]	The image will be applied with the clear natural colours.
	[Retro]	The image will be applied with the sepia tone.
	[Cool]	The image will be applied with the cool colours.
	[Calm]	The image will be applied with the calm colours.
	[Classic]	The image will be applied with the classic colours.



# E (Effect) button: Image editing

Press the **E** button in the [Program], [Movie], [Portrait], [Children], [Close up], [Self Shot], [Food] and [Café] scene modes.

## Colour

1. Select the Colour(  ) menu by pressing the **Up/Down** button.
2. Select the desired sub menu by pressing the **Left/Right** button and press the **OK** button.
3. Press the **Shutter** button to take an image.









- Custom colour: You can change the R (Red), G (Green) and B (Blue) values of the image.



- **OK** button: Selects / setups the Custom Colour
- **Up/Down** button: Selects R, G, B
- **Left/Right** button: Changes the values



Icon	COLOUR	Description
<b>NOR</b>	[Normal]	No colour effect is added to the image.
	[B/W]	Captured images will be stored in black and white.
	[Sepia]	Captured images will be stored in a sepia tone (a gradient of yellowish brown colours).
	[Red]	Captured images will be stored in a red tone.
	[Green]	Captured images will be stored in a green tone.
	[Blue]	Captured images will be stored in a blue tone.
	[Negative]	Save the image in negative mode.
	[Custom Color]	Captured image will be saved in set RGB tone.

# E (Effect) button: Image editing

Press the E button in the [Program] mode.

## Saturation

1. Select the Saturation(  ) menu by pressing the **Up/Down** button and a bar for selecting the saturation will be displayed.
2. Change the saturation by pressing the **Left/Right** button.
3. Press the **Shutter** button to take an image.

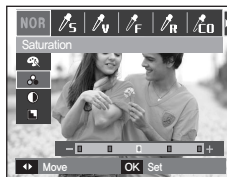

## Sharpness

1. Select the Sharpness(  ) menu by pressing the **Up/Down** button and a bar for selecting the sharpness will be displayed.
2. Change the sharpness by pressing the **Left/Right** button.
3. Press the **Shutter** button to take an image.



## Contrast

1. Select the Contrast(  ) menu by pressing the **Up/Down** button and a bar for selecting the contrast will be displayed.
2. Change the contrast by pressing the **Left/Right** button.
3. Press the **Shutter** button to take an image.



## E (Effect) button: Cartoon

You can add a text box to the image to make the image cartoon like.

The size of Cartoon image is fixed to 1M.

- Press the **E** button in the FUN recording mode.

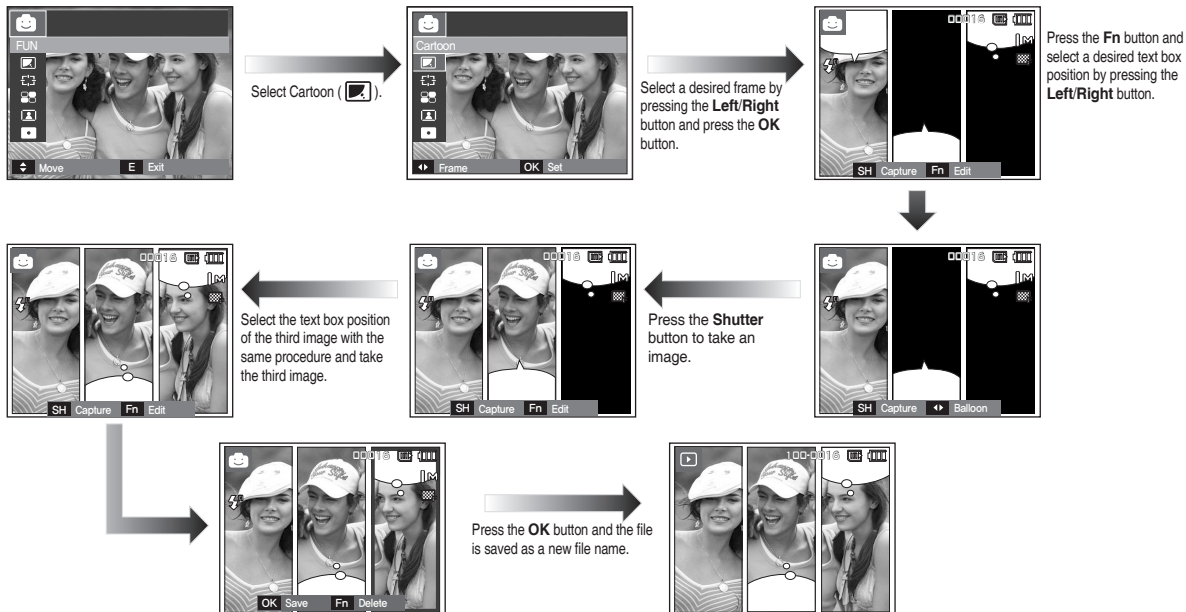

## E (Effect) button: Cartoon

- Changing the cartoon image before taking the last shot

Before saving the cartoon image, you can take images again.

1. Select an image to delete by using the **Left/Right** button.
2. Press the **Fn** button and the image deletes.

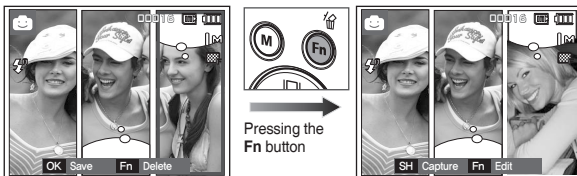

3. To take a new image, press the **Shutter** button.



- You can select the menu by pressing the **MENU** button when the cartoon image is taken but not saved in the memory. If the [Yes] is selected, menu will be displayed on the LCD monitor and the cartoon image which is not saved will be deleted.

## E (Effect) button: Pre-set focus frame

You can make the subject stand out from its surroundings. The subject will be sharp and in focus while making the rest out of focus. The size of High Light image is fixed to under 5M.

- Press the **E** button in the FUN recording mode.

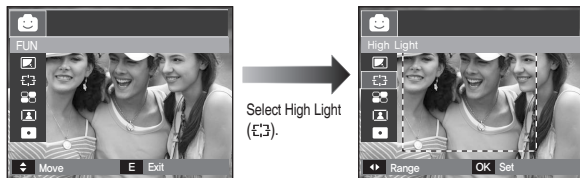

- Select a proper menu by pressing the **Left/Right** button and press the **OK** button.

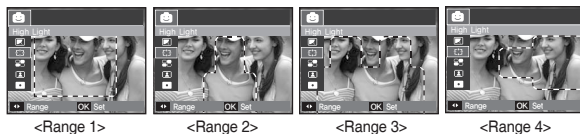

- The preset focus frame will appear. Press the **Shutter** button to capture an image.



- Moving and changing the focus frame  
You can change the focus frame after selecting a Range menu.

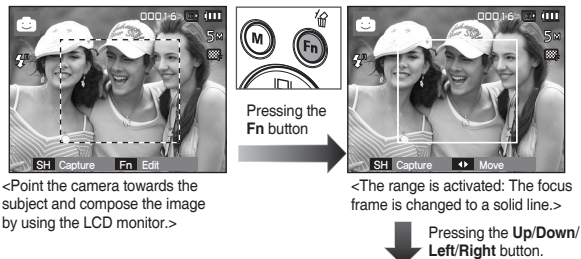

<Point the camera towards the subject and compose the image by using the LCD monitor.>

<The range is activated: The focus frame is changed to a solid line.>

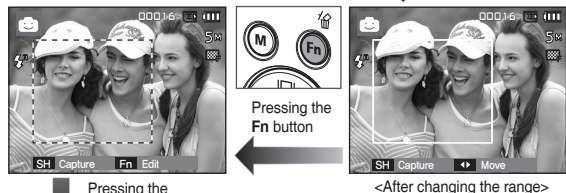

<After changing the range>

<Final image>

# E (Effect) button: Composite shooting

You can combine 2 - 4 different shots in a still image.  
The size of Composite image is fixed to under 5M.

- Press the **E** button in the FUN recording mode.

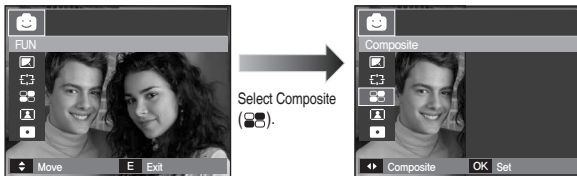

- Select a desired menu by pressing **Left/Right** button and press the **OK** button. (You can select 2-4 composite images)

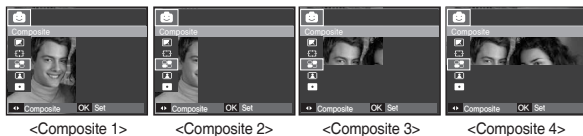

- After selecting a desired menu, press the **Shutter** button to take a picture.

※ Selecting 2 composite shots

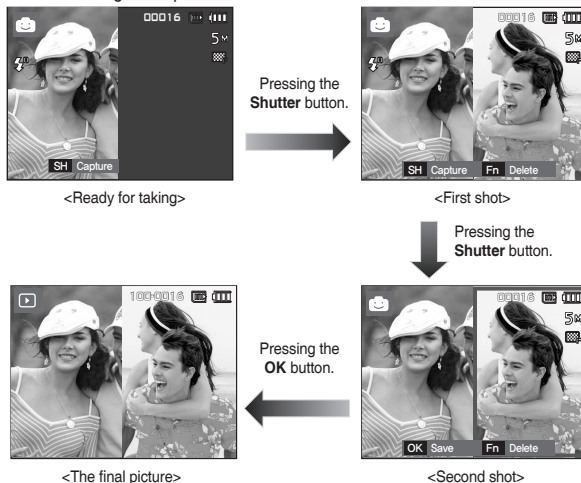

After taking the last image, press the **OK** button to save the image.



- You can use the **Flash**, **Self-timer**, **Macro Focus** and the **Zoom W/T** button during the composite shooting.
- If you press the **Play mode**, **MENU**, **E** button or **M (Mode)** button during the composite shots, each camera working mode is executed. The previously captured images will be deleted.

# E (Effect) button: Composite shooting

- Changing a part of composite shot before taking the last shot  
Before taking the last composite shot, you can change a part of composite shot.

1. During the composite shots, press the **Fn** button.
2. A previous image will be deleted and new frame will be displayed. To delete a previously taken image, press the **Fn** button again.

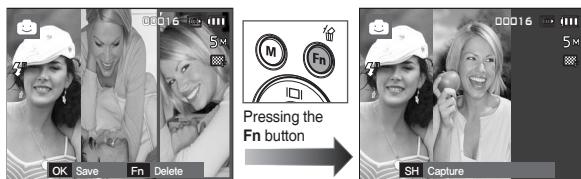

<Before taking the 3rd shot>

<Moving backward to the 2nd shot>

3. Press the **Shutter** button to capture a new image.

- Changing a part of composite shot after taking the last shot  
After taking the last shot, you can change a part of the composite shot.

1. After taking the last shot, a cursor to select a frame will appear. Press the **Up/Down/Left/Right** button to select the frame.
2. Press the **Fn** button and an image will be deleted. The composite frame will be activated.
3. Press the **Shutter** button. You can take other images again by using the **Press the Up/Down/Left/Right** button and **Fn** button.
4. Press the **OK** button again to save the captured image.

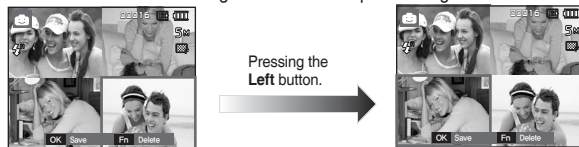

<After taking 4th shot>

<Moving backward to the 3rd shot>

Pressing the **Shutter** button.



<Deleting 3rd shot>

Pressing the **Fn** button.

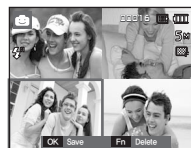

<Taking 3rd shot again>

Pressing the **OK** button.

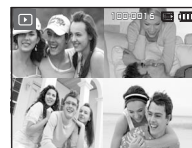

<Final Image>

# E (Effect) button: Photo Frame

You can add 9 types of frame-like borders to a still image you want to capture. Date & Time information will not be printed on the stored image taken with Photo Frame menu.

The size of Photo Frame image is fixed to under 5M.

- Press the **E** button in the FUN recording mode.

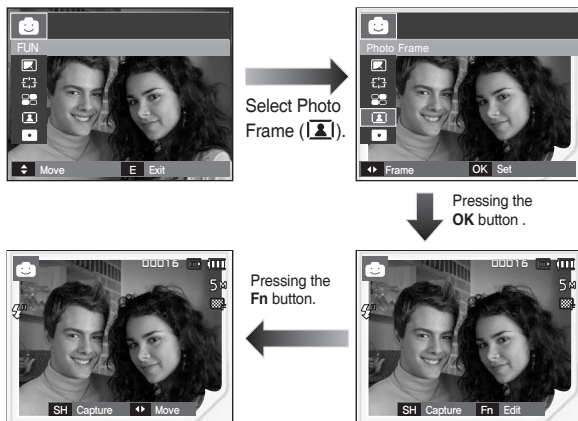

1. The selected photo frame will be displayed by pressing **Left/Right** button.

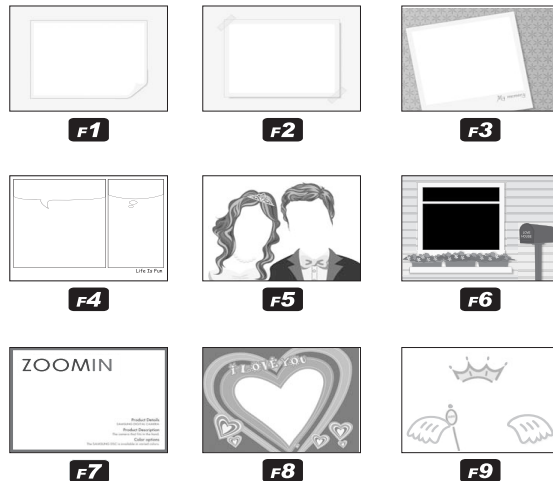

2. Press the **Shutter** button to take a picture.



# E (Effect) button: Colour Mask

With this menu, you can select a part you want to highlight. The rest of the image will be black and white.

- Press the **E** button in the FUN recording mode.

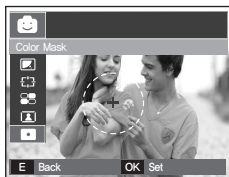

Select Color Mask ( ) by pressing the **OK** button and the Mask mark will be displayed on the LCD monitor.

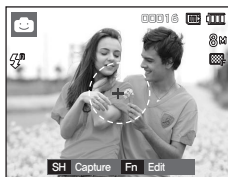

Press the **Fn** button. You can change the size and location of the mask.

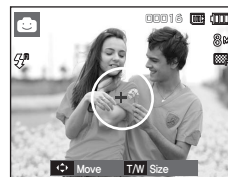

**Zoom W/T** button:  
Changing the Mask size

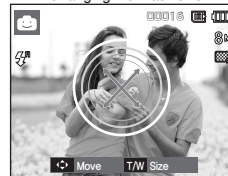

**Up/Down/Left/Right** button:  
Moving the mask

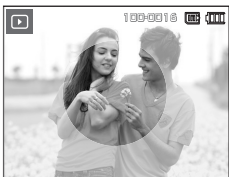
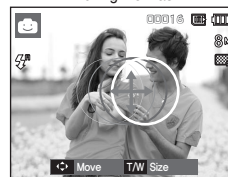

<Final image>

Press the **Shutter** button and the mask added image is taken.

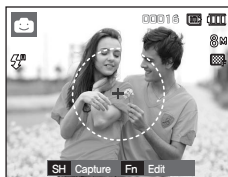





<Mask added image>

# Using the LCD monitor to adjust the camera settings

You can use the menu on the LCD monitor to set up recording functions.

- The items indicated by  are default settings.

Menu	Sub menu		Available mode	Page
[Focus Area]	Center AF	Multi AF		p.53
[ACB]	Off	On		p.54
[Voice Memo]	Off	On		p.54
[Voice Record]	-			p.55
[Voice Mute]	Off	On		p.56

× Menus are subject to change without prior notice.

## Focus Area

You can select your preferred Focus Area according to the shooting conditions.



Focus Area	Description
[Center AF]	The rectangular area in the center of the LCD monitor will be focused.
[Multi AF]	This camera selects all available AF points of the LCD monitor.

- × When the camera focuses on the subject, the auto focus frame turns to green. When the camera doesn't focus on the subject, the auto focus frame turns to red.

# ACB

This function is to adjust the contrast automatically when taking photos in an environment with big exposure difference i.e. backlight or contrast. This function adjusts the brightness automatically and allows the subject to be photographed clearly.

- [ACB] Sub menus: [Off], [On].



- × When using the [Auto], [Program] mode and [Portrait] scene mode, the ACB function will operate.
- × ACB function always operates in the [Auto] recording and [Portrait] scene mode.
- × When using the [Continuous], [Motion Capture] or [AEB] menu, the ACB function will not operate.
- × When the ACB function is selected, you cannot select a high ISO 400 or higher.



# Voice Memo

You can add your voice-over to a stored still image. (Max. 10 sec.)

- If the voice memo indicator is displayed on the LCD monitor, the setting is completed.
- Press the **Shutter** button and take a picture. The picture is stored on the memory card.
- Voice memo will be recorded for ten seconds from the moment the picture is stored. In the middle of the sound recording, pressing the **Shutter** button will stop the voice memo.



# Voice recording

A voice can be recorded for as long as the available recording time (Max. 10 hour) allows.

Press the **Shutter** button to record a voice.

- Press the **Shutter** button once and voice is recorded for as long as the available recording time (max:10 hour) allows. The recording time will be displayed on the LCD monitor. Voice will still be recorded if the **Shutter** button is released.
- If you wish to stop recording, press the **Shutter** button again.
- File type: \*.wav



<Voice recording mode>

## ■ Pausing while recording a voice

Using this function, you can record your favourite voice clips into a voice recording file without having to create multiple voice recording files.

1. Press the **Play & Pause** (▶||) button to pause recording.
2. Press the **Play & Pause** (▶||) button again to resume the recording.
3. If you wish to stop recording, press the **Shutter** button again.



<Pausing the voice recording>



- A distance of 40cm between you and the camera (microphone) is the best distance to record sound.
- If the camera power is turned off while the voice recording is paused, the voice recording is cancelled.

## Recording the movie clip without voice

You can record the movie without voice.

Select [Voice Mute] menu in the Movie clip mode. (p.23)

(M) icon will appear on the LCD monitor. Press the **Shutter** button and a movie will record for as long as the memory capacity allows without voice.

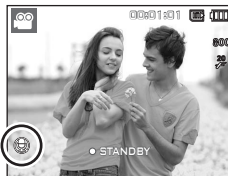
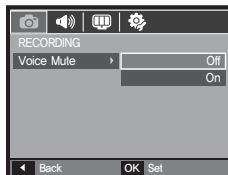

## Starting play mode

Turn the camera on and select Play mode by pressing the **Play mode** (▶) button. The camera can now play back the images stored in the memory. If the memory card is inserted in the camera, all the camera functions apply only to the memory card. If the memory card is not inserted in the camera, all the camera functions apply only to the internal memory.

### Playing back a still image

1. Select the Play mode by pressing the **Play mode** (▶) button.
2. The last image stored on the memory is displayed on the LCD monitor.
3. Select an image that you want to view by pressing the **Left/Right** button.
  - × Press and hold the **Left** or **Right** button to play back the images quickly.

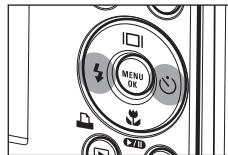
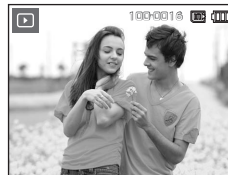

# Starting play mode

## Playing back a movie clip

1. Select the recorded movie clip that you want to play back by using the **Left/Right** button.
2. Press the **Play & Pause (C/D)** button to playback a movie clip file.
  - To pause a movie clip file while playing it back, press the **Play & Pause (C/D)** button again.
  - Pressing the **Play & Pause (C/D)** button again will cause the movie clip file to restart.
  - To rewind the movie clip while it is playing, press the **Left** button. To fast forward the movie clip, press the **Right** button.
  - To stop playback of the movie clip, press the **Play & Pause (C/D)** button, and then press the **Left** or **Right** button.

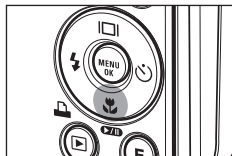

## Movie clip capture function

You can capture still images from the movie clip.

### ■ How to capture the movie clip

1. Press the **Play & Pause (C/D)** button while playing the movie clip. Then press the **E** button.
2. The paused movie clip is saved in a new file name.
  - × The captured movie clip file is the same size as the original movie clip (800x592, 640x480, 320x240).
  - × When you press the **E** button at the beginning of the movie clip, the first frame of the movie clip will be saved as a still image.

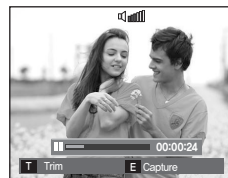

<Paused>

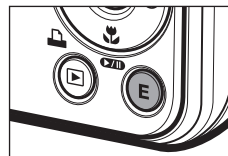

<Press the E button>

# Starting play mode

## On camera movie trimming

You can extract desired frames of movie clip during the movie clip play back. If the running time is under 10 seconds, the movie clip can't be trimmed.

1. Press the **Play & Pause (⏮/⏭)** button at the point of the movie clip where you want to start extracting.
2. Press the **T** button.
3. Press the **Play & Pause (⏮/⏭)** button and the extracted range will be displayed on the status bar.
4. Press the **Play & Pause (⏮/⏭)** button once more at the point where you wish the extracted file to stop.
5. Press the **T** button and a confirmation window will be displayed.
6. Select a desired sub menu by pressing the **Up/Down** button and press the **OK** button.

[No]: The movie trimming will be cancelled.

[Yes]: The extracted frames are saved as a new file name.



- If you don't specify the ending point of the movie clip, the trimming confirmation window will be displayed at the point of the last frame.

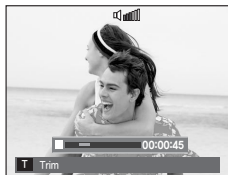





## Playing back a recorded voice

1. Select the recorded voice that you want to play back by using the **Left/Right** button.
2. Press the **Play & Pause (⏮/⏭)** button to play back a recorded voice file.
  - To pause a recorded voice file, while playing it back, press the **Play & Pause (⏮/⏭)** button again.
  - To resume playback of the voice file, press the **Play & Pause (⏮/⏭)** button
  - To rewind the voice file while it is playing, press the **Left** button. To fast forward the voice file, press the **Right** button.
  - To stop playback of the voice memo, press the **Play & Pause (⏮/⏭)** button and then press the **MENU/OK** button.



# Starting play mode

## Playing back a voice memo







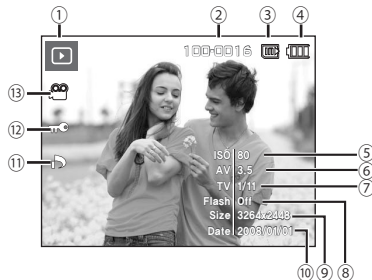

1. Select a still image that has the voice memo.
2. Press the **Play & Pause** (  ) button to play back the voice memo.
  - To pause the voice memo, while playing it back, press the **Play & Pause** (  ) button again.
  - To resume playback of the voice memo, press the **Play & Pause** (  ) button.
  - To stop playback of the voice memo, press the **Play & Pause** (  ) button and then press the MENU/OK button.



# LCD monitor Indicator

The LCD monitor displays shooting information about the displayed image.



No.	Description	Icon	Page
1	Playback mode		p.56
2	Folder name & File name	100-0010	p.89
3	Internal memory icon/ Memory card icon indicator	 / 	-
4	Battery		p.15
5	ISO	80 ~ 3200	p.40
6	Aperture value	F3.5 ~ F8.0	p.42
7	Shutter speed	16 ~ 1/2000	p.42
8	Flash	On/Off	p.32
9	Image size	3264x2448 ~ 320x240	p.38
10	Recording date	2008/01/01	p.86
11	DPOF		p.80~82
12	Protect		p.79
13	Movie Clip/Voice Memo	 / 	p.23/54



# Using the camera buttons to set the camera

In Play mode, you can use the buttons on the camera to conveniently set up the Play mode functions.

## Play mode button

- If you have turned on the camera by pressing the **POWER** button, you can press the **Play mode** button once to switch to Play mode and press it again to switch to Recording mode.
- You can turn the power on with the **Play mode** button. The camera is turned on in play mode. Press the **Play mode** button again to turn off the camera.
- Manner mode: To select the Manner mode, press the **Play mode** button for more than 3 seconds. In the Manner mode, Operating sound, Effect sound, Start-up sound and Shutter sound will not be generated. To cancel the Manner mode, turn on the camera by pressing the **POWER** button.
- In the PMP, MP3, Text viewer mode, pressing the **Play mode** button will display the play list of each mode.

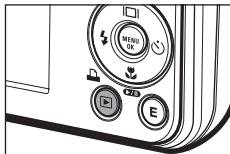

## Thumbnail(☒) / Enlargement(Q) button

- You can view multiple pictures, enlarge a selected picture, and crop and save a selected area of an image.
- In the MP3, PMP, Text Viewer, Movie mode, slide show and when playing back the recorded voice, you can control the volume of multimedia files.
- Thumbnail display

1. While an image is displayed on full screen, press the **Thumbnail** button.
2. The thumbnail display will highlight the image that had been showing at the time the thumbnail mode was selected.
3. Press the 5 function button to move to a desired image.
4. To view an image separately, press the **Enlargement** button.



<Normal display mode>

Pressing the **Thumbnail** (☒) button

Pressing the **Enlargement** (Q) button

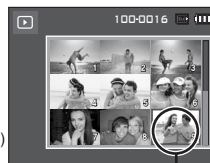

<Thumbnail display mode>

Highlighted image

# Using the camera buttons to set the camera

## ■ Image enlargement

1. Select an image that you want to enlarge and press the **Enlargement** button.

2. Different parts of the image can be viewed by pressing the 5 function button.

3. Pressing the **Thumbnail** button will zoom back to the original full sized image.

– You can tell whether the image displayed is an enlarged view by checking the image enlargement indicator shown at the top left of the LCD monitor. (If the image is not an enlarged view, the indicator will not be displayed.) You can also check the area of enlargement.

– Movie clips and WAV files can't be enlarged.

– If an image is enlarged, a loss of quality may occur.

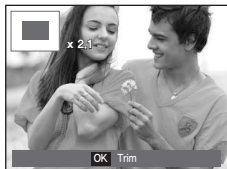

## ■ The maximum enlargement rate in proportion to the image size

Image size	8M	7M	6M	5M	3M	1M
Maximum enlargement rate	X10.2	X9.1	X8.5	X8.1	X6.4	X3.2

## ■ Trimming: You can extract part of the image that you want and save it separately.

1. Select an image that you want to enlarge and press the enlargement button. Press the **MENU/OK** button and a message will be displayed.

2. Select a desired sub menu by pressing the **Up/Down** button and press the **OK** button.

– [No]: The trimming menu will disappear.

– [Yes]: The trimmed image will be saved as a new file name, and appear on the LCD monitor.

× If there is not enough memory space to save the trimmed image, the image can't be trimmed.

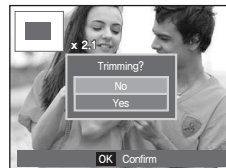

## Info ( ) / Up button

When the menu is displayed on the LCD monitor, the **UP** button operates as a direction button. When the menu is not displayed on the LCD monitor, pressing the **Info**() button will display image information on the LCD monitor.

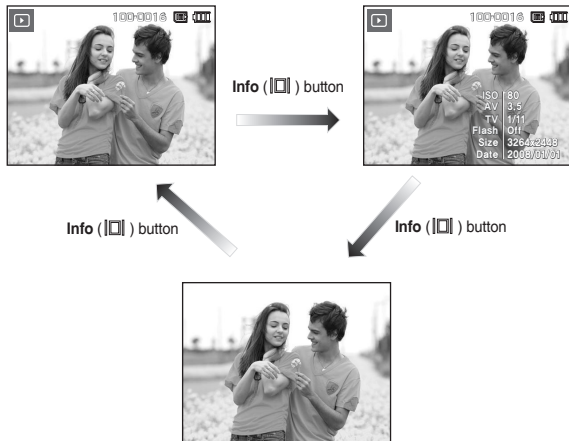

## Play & Pause ( ) / Down button

In Play mode, the **Play & Pause** () / **Down** button works as follows:

- If the menu is displayed  
Press the **Down** button to move from the main menu to a sub menu, or to move down the sub menu cursor.
- If a still image with a voice memo, a voice file, or a movie clip is playing
  - In Stop mode: Plays a still image with a voice memo, a voice file, or a movie clip.
  - During playback: Temporarily stops playback.
  - In Pause mode: Resumes playback



## Left / Right / Menu / OK button

Left/Right/MENU/OK button activates the following.

- **Left** button: While the menu is showing, the **Left** button operates as a direction button. While the menu is not showing, press the **Left** button to select the previous image.
- **Right** button: While the menu is showing, the **Right** button operates as a direction button. While the menu is not showing, press the **Right** button to select the next image.
- **MENU** button: When you press the **MENU** button, the play mode menu will be displayed on the LCD monitor. Pressing it again will return the LCD to the initial display.
- **OK** button: When the menu is displayed on the LCD monitor, the **OK** button is used for confirming data that is changed by using the 5 function button.

## Print (🖨️) button

When the camera is connected to a PictBridge printer, you can print images by pressing the **Print** button.

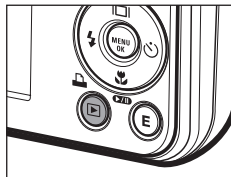
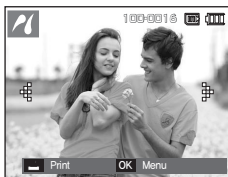

## Delete (🗑️) button

This deletes images stored on the memory card.

1. Select an image that you want to delete by pressing the **Left/Right** button and press the **Delete** (🗑️) button.

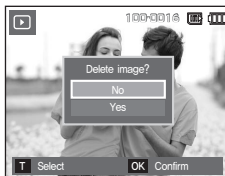

<Single Image>

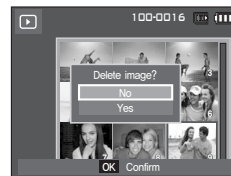

<Thumbnail Image>

2. To add images to delete, press the **T** button.
  - **Left/Right** button: Selects images
  - **T** button: Checks for deletion
  - **OK** button: Deletes the selection

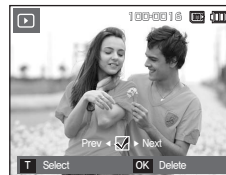

3. Select the submenu values by pressing the **Up/Down** button and then press the **OK** button.
  - If [No] is selected: Cancels "Delete Image".
  - If [Yes] is selected: Deletes the selected images.

## E (Effect) button: Resize

Change the resolution (size) of pictures taken. Select [Start image] to save an image to be the start-up image.

1. Press the **Play mode** button and press the **E** button.
2. Press the **Left/Right** button and select the [RESIZE] (📏) menu tab.
3. Select a desired sub menu by pressing the **Up/Down** button and press the **OK** button.

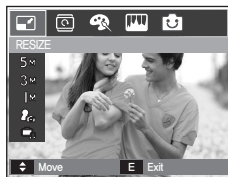

### ■ Image Resize Types

(●: Selectable)

	5M	3M	1M	👤	📷
8M	●	●	●	●	●
5M		●	●	●	●
3M			●	●	●
1M				●	●
	5MP	3MP	1MP	👤	📷
7MP	●	●	●		
		2MW	1MW	👤	📷
6MW		●	●		

- A large sized image can be resized to a smaller sized image, but not vice versa.
- Only JPEG images can be resized. Movie clip (AVI), Voice recording (WAV) files can't be resized.
- You can change the resolution of only those files compressed in the JPEG 4:2:2 format.
- The resized image will have a new file name. The [Start Image] image is stored not on the memory card but on the internal memory.
- If a new user image is saved, one of the two user images will be deleted in order.
- If the memory capacity is insufficient to store the resized image, a [Memory Full!] message will appear on the LCD monitor and the resized image can't be stored.

## E (Effect) button: Rotating an image

You can rotate the stored images by various degrees.  
Once the playback of the rotated picture is finished, it will switch back to the original state.

1. Press the **Play mode** button and press the **E** button.
2. Press the **Left/Right** button and select the [ROTATE] (🔄) menu tab.
3. Select a desired sub menu by pressing the **Up/Down** button.

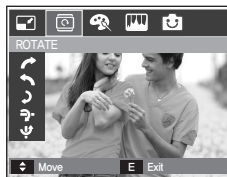

<🔄>: Right 90>:

Rotate picture in a clockwise direction



<🔄>: Left 90>:

Rotate picture in a counterclockwise direction



<🔄>: 180>:

Rotate picture 180 degrees



<🔄>: Horizontal>:

Rotate picture horizontally



<🔄>: Vertical>:

Rotate picture vertically

- × If you display the rotated image on the LCD monitor, empty spaces may appear to the left and right of the image.

## E (Effect) button: Colour

It is possible to add colour effects to your images by using this button.

1. Press the **Play mode** button and press the **E** button.
2. Select (🎨) menu tab by pressing the **Left/Right** button.
3. Select a desired sub menu by pressing the **Up/Down** button and press the **OK** button.

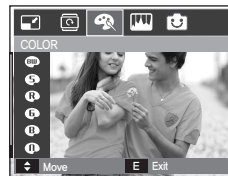

Icon	Effect Mode	Description
🖼️	[B/W]	Captured images will be stored in black and white.
🎨	[Sepia]	Captured images will be stored in a sepia tone (a gradient of yellowish brown colours).
🔴	[Red]	Captured images will be stored in a red tone.
🟢	[Green]	Captured images will be stored in a green tone.
🟡	[Blue]	Captured images will be stored in a blue tone.
⬛	[Negative]	Save the image in negative mode.
🎨	[Custom Color]	Captured images will be stored in set RGB tone.

4. The changed image is saved as a new file name.

## E (Effect) button: Colour

### ■ Custom colour

You can change the R(Red), G(Green) and B(Blue) values of the image.



– **OK** button: Selects / setups the Custom Colour.

– **Up/Down** button: Selects R, G, B.

– **Left/Right** button: Changes the values.

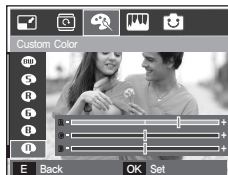

## E (Effect) button: Image editing

1. Press the **Play** button and press the **E** button.
2. Select (🎨) menu tab by pressing the **Left/Right** button.

### ACB

You can automatically adjust the brightness of the region with big exposure difference from the captured image.

1. Select (🎨) by pressing the **Up/Down** button and press the **OK** button.
2. The [Processing!] message displays and the image is saved as a new file name.



### Red eye removal

Red eye effect can be removed from the captured image.

1. Select (👁) by pressing the **Up/Down** button and press the **OK** button.
2. The [Processing!] message displays and the image is saved as a new file name.

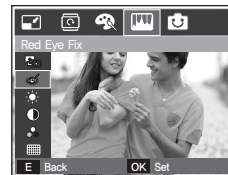

# E (Effect) button: Image editing

## Brightness control

You can change the brightness of the image.

1. Select (☀️) by pressing the **Up/Down** button and a bar for selecting the brightness will be displayed.
2. Change the brightness by pressing the **Left/Right** button.
3. Press the **OK** button and the image will be saved as a new file name.



## Contrast control

You can change the contrast of the image.

1. Select (☯️) by pressing the **Up/Down** button and a bar for selecting the contrast will be displayed.
2. Change the contrast by pressing the **Left/Right** button.
3. Press the **OK** button and the image will be saved as a new file name.



## Saturation control

You can change the saturation of the image.

1. Select (🌈) by pressing the **Up/Down** button and a bar for selecting the saturation will be displayed.
2. Change the saturation by pressing the **Left/Right** button.
3. Press the **OK** button and the image will be saved as a new file name.



## Noise effect

You can add noise to an image to add a more classic feel to your photo.

1. Select (🔲) by pressing the **Up/Down** button and press the **OK** button.
2. The [Processing!] message appears and the image is saved as a new file name.

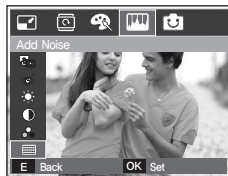



# E (Effect) button: FUN

If the image size is (7M) or (6M), the FUN menu cannot be selected.

## Cartoon

You can add a text box to the image to make the image cartoon like.

× The cartoon image is saved as 1M image size.

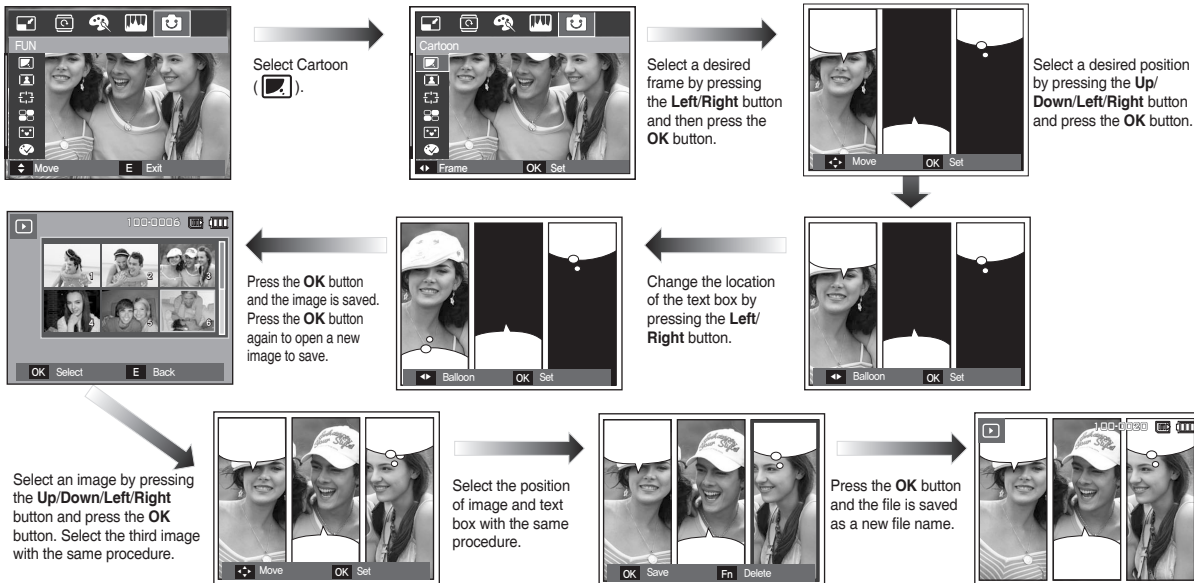

## E (Effect) button: FUN

- Changing the cartoon image before taking the last shot  
Before saving the cartoon image, you can change the selected image.

- Pressing the **Fn** button deletes the images in order.
- Press the **OK** button and you can select images.

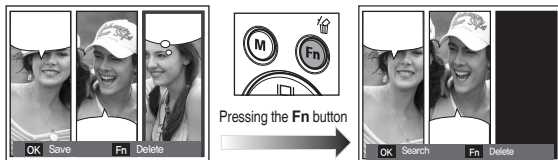

- After selecting desired images, press the **OK** button to save the image as a new file name.

## Photo Frame

You can add 9 types of frame-like borders to a still image you want to capture. Date & Time information will not be printed on the stored image taken with Photo Frame menu.

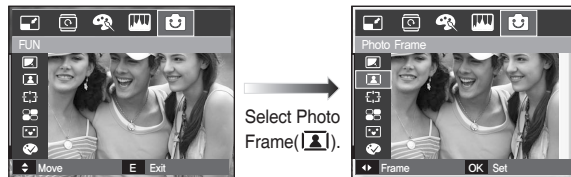

- Select (Frame icon) by pressing the **Up/Down** button and press the **OK** button.

# E (Effect) button: FUN



F1



F2



F3

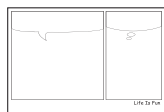

F4



F5



F6

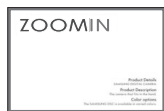

F7



F8



F9

2. Select a desired photo frame by pressing the **Left/Right** button and press the **OK** button to save the image.



## Preset focus frames

You can make the subject stand out from its surroundings. The subject will be sharp and in focus while making the rest out of focus. The High Light image is saved as under 5M image size.



Select High Light (F3).

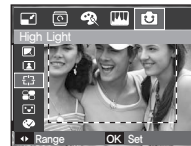

Select a desired frame by pressing the **Left/Right** button and press the **OK** button.



<Range 1>



<Range 2>

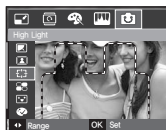

<Range 3>

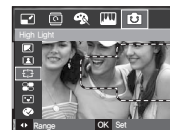

<Range 4>

# E (Effect) button: FUN

## ■ Moving and changing the focus frame

You can change the focus frame after selecting a Range menu.

1. Select a focus frame by pressing the **Left/Right** button and press the **OK** button.
2. Move the location of the frame by pressing the **Up/Down/Left/Right** button.
3. Press the **OK** button and the file is saved as a new file name.

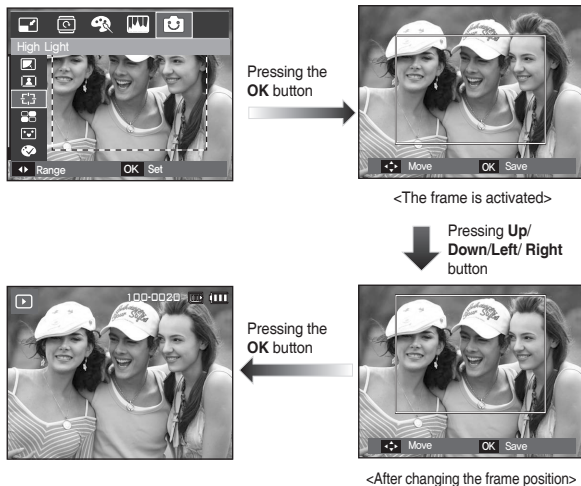

## Composite image

You can combine 2 - 4 different shots in a still image.

The composite image is saved as under 5M image size.

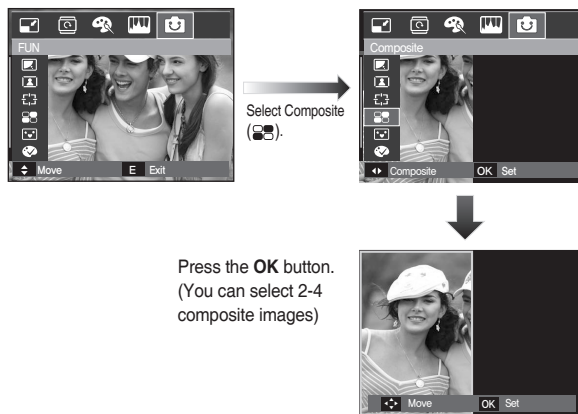

- If you press the **Shutter** and **Play mode** button, a capture mode is executed.
- The composite image is saved according to the minimum image size among the original images.

# E (Effect) button: FUN

× Selecting 2 composite shots



<Changing the position>  
Pressing the **OK** button.



<Selecting the second image>

Select an image by pressing the 5 function button and press the **OK** button.



■ Before selecting the last composite image, you can change a part of composite image.

1. During the composite image editing, press the **Fn** button.
2. A previous image will be deleted. Press the **OK** button and you can select a new image. After selecting an image, press the **Fn** button again and the image will be deleted again.

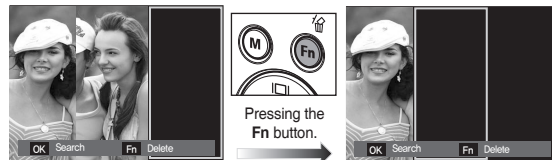

3. Press the **OK** button and you can select an image again.

■ Before selecting the last composite image, you can change a part of composite image.

1. Select the image you want to delete, and press the **Fn** button.
2. The selected composite image will be deleted. Press the **OK** button and you can select a new image.

# E (Effect) button: FUN

## Sticker

You can add various stickers to the image.  
The Sticker image is saved as 1M image size.

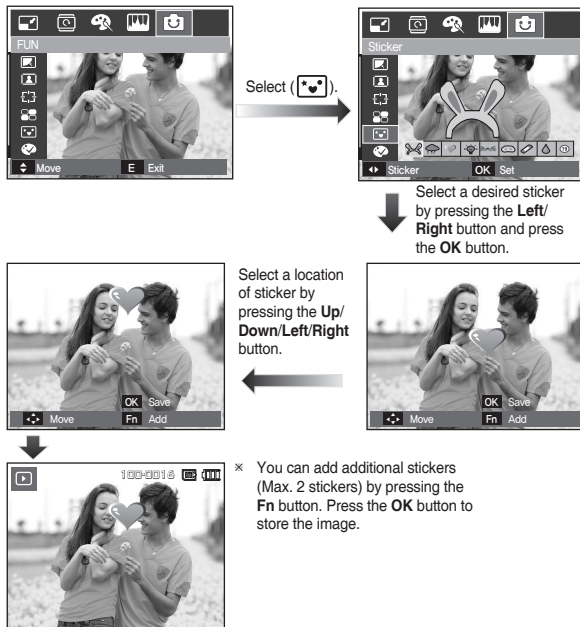

## Colour Filter

With this menu, you can change the colour information of the image (excluding Red, Blue, Green and Yellow) to Black and White.

1. Select (✔️) by pressing the **Up/Down** button.

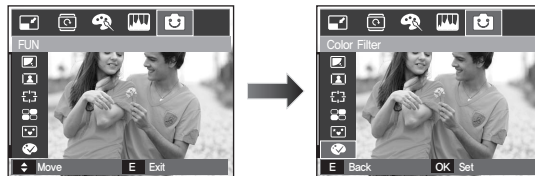

2. Press the **OK** button and the image is saved as a new file name.

# E (Effect) button: FUN

## Colour mask

With this menu, you can select a part you want to highlight. The rest of the image will be in black and white.



Select (▶) and a mark for selecting part will display.

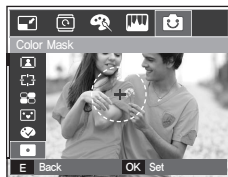

Press the **OK** button and you can set the size and location of the part.

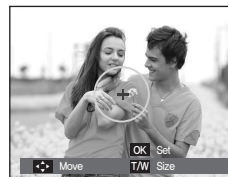

**W/T** button: Changing size of part

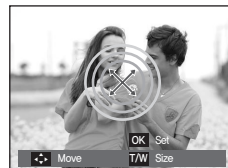

**Up/Down/Left/Right** button:  
Changing the location

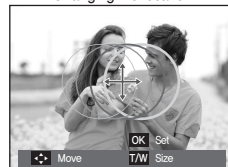

Pressing the **OK** button.

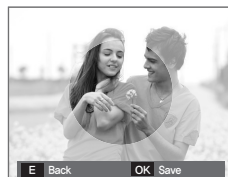

Pressing the **OK** button and the colour mask image will be saved as a new file name. You set the size and location of the part by pressing the **E** button.

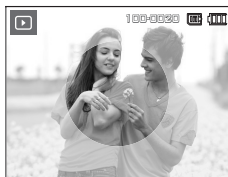



<Final image>

# Setting up the play back function using the LCD monitor

Play mode functions can be changed by using the LCD monitor.

In the Play mode, pressing the **MENU** button displays the menu on the LCD monitor. The menus you can set up in Play mode are as follows.

To capture an image after setting up the play menu, press the **Play mode** button or **Shutter** button.

Menu Tab	Main Menu	Sub Menu	Sub Menu	Page	
SLIDE SHOW 	Show Start	Play / Repeat Play	–	p.76	
	Images	All	–	p.77	
		Date			
		Select			
	Effect	Off	Basic	Classic	p.77
		Memories	Rhythmic	Delight	
Interval	1, 3, 5, 10 sec	–	p.78		
Music	Off / Panorama/First smile/Remembrance/My Music	–	p.78		
PLAY BACK 	Voice Memo	Off	–	p.79	
		On	–		
	Protect	Select	Unlock / Lock	p.79	
		All			
	Delete	Select	–	p.79	
		All	No / Yes		
	DPOF	Standard	Select / All / Cancel	p.80–82	
		Index	No / Yes		
Size		Select / All / Cancel			
Copy To Card	No	–	p.82		
	Yes	–			

This menu is available while the camera is connected to a PictBridge supporting printer (direct connection to the camera, sold separately) with a USB cable.

Menu Tab	Main Menu	Sub Menu	Sub Menu	Page
	Images	One Pic	–	p.93
		All Pics	–	
	Size	Auto	–	p.94
		PostCard	–	
		Card	–	
		4X6	–	
		L	–	
		2L	–	
		Letter	–	
		A4	–	
		A3	–	
		Auto	–	
	Layout	Full	–	
		1	–	
		2	–	
		4	–	
		8	–	
		9	–	
		16	–	
		Index	–	



## Setting up the play back function using the LCD monitor

Menu Tab	Main Menu	Sub Menu	Sub Menu	Page
	Type	Auto	-	p.94
		Plain	-	
		Photo	-	
		FastPhoto	-	
	Quality	Auto	-	
		Draft	-	
		Normal	-	
		Fine	-	
	Date	Auto	-	
		Off	-	
		On	-	
	File Name	Auto	-	
		Off	-	
		On	-	
	Reset	No	-	
		Yes	-	

× Menus are subject to change without prior notice.



## Starting the slide show ( )

Images can be displayed continuously at pre-set intervals. You can view the slide show by connecting the camera to an external monitor.

1. Press the **Play mode** button and press the **MENU** button.
2. Press the **Left/Right** button and select the [SLIDE SHOW] menu tab.

### Start the slide show

The slide show can start only in the [Show Start] menu.

1. Use the **Up/Down** button to select the [Show Start] menu and press the **Right** button.
2. Select a desired sub menu by pressing the **Up/Down** button.  
[Play]: The slide show is closed after one cycle.  
[Repeat Play]: The slide show is repeated until cancelled.
3. Press the **OK** button and the slideshow will be started.
  - To pause the slide shown while playing it back, press the **Play & Pause (  )** button again.
  - Pressing the **Play & Pause (  )** button again will cause the slide show restart.
  - To stop playback of the slide show, press the **Play & Pause (  )** button, and then press the **OK/MENU** button.



# Starting the slide show (🎬)

## Selecting Images

You can select image to view.

- 1 Use the **Up/Down** button to select the [Image] menu and press the **Right** button.
2. Select a desired sub menu by pressing the **Up/Down** button.

[All]: All images saved in the Memory are played back.

[Date]: Images taken on a specified date are played back.

[Select]: Play only the selected images.

If you press the **Right** button, you can select the desired images to play back.

The selected image can be saved as [Select 1], [Select 2] and [Select 3]. If you save the selected image with the [New Select] command, it will be saved as [Select 1]. But when a new image is saved again using [New Select], the former image which had been saved as [Select 1] will be saved as [Select 2] automatically. You can change and cancel the images which were saved as [Select 1], [Select 2] and [Select 3].

3. Press the **OK** button and the settings are saved.



## Configure slide show effects

Unique screen effects can be used for the slide show.

1. Select the [Effect] sub menu by pressing the **Up/Down** button and press the **Right** button.
2. Use the **Up/Down** button to select the type of effect.
3. Press the **OK** button to confirm the setting.



- When the effect is selected, the background music is changed according to the default setting of the effect.

Effect	Description
[Off], [Basic]	No background music.
[Classic]	Background music is set to [Remembrance].
[Memories]	Background music is set to [Remembrance].
[Rhythmic]	Background music is set to [First Smile].
[Delight]	Background music is set to [Panorama].



- You can change the desired music for each effect.

# Starting the slide show (🎬)

## Setting play interval

Set the slide show play interval.

1. Select the [Interval] sub menu by pressing the **Up/Down** button and press the **Right** button.
2. Use the **Up/Down** button to select the desired interval.
3. Press the **OK** button to save the configuration.

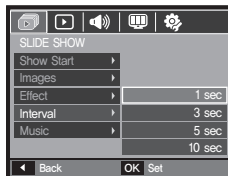

- The loading time depends on the image size and quality.
- While the slide show is playing, only the first frame of a movie file is displayed.
- While the slide show is playing, the voice recording file will not display.
- [Interval] is available when the effect is set to [Off], [Basic], [Classic] in the slide show. It is unavailable when the effect is set to [Memories], [Rhythmic], [Delight] in the slide show.

## Setting Background Music

Set the slide show music.

1. Select the [Music] sub menu by pressing the **Up/Down** button and press the **Right** button.
2. Use the **Up/Down** button to select the desired Music.
3. Press the **OK** button to save the configuration.

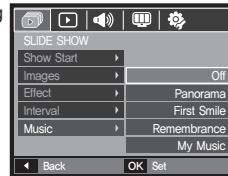

[Off]: Background music is not played back.

[Panorama], [First smile], [Remembrance], [My Music]:  
Selected music is played back.

# Playback (▶)

## Voice memo

You can add your voice to a stored still image.



<Voice memo menu>

<Ready for recording>

<Voice is recording>

- Press the **Shutter** button to take a picture. The images are saved on the memory. After saving the image, the voice is recorded for 10 seconds.
- To stop the recording, press the **Shutter** button.

## Protecting images

(Lock) This is used to protect specific shots from being accidentally erased.

(Unlock) This unprotects images that have previously been protected .

1. Press the **Up/Down** button and select the [Protect] menu tab. And then press the **Right** button.
2. Select a desired sub menu by pressing the **Up/Down** button and press the **OK** button.

[Select]: Selection window for an image to be protected / released is displayed.



- **Up/Down/Left/Right** button: Select an image.
- **Zoom W/T** button: Protect / release the image.
- **OK** button: Your changes will be saved and the menu will disappear.

[All]: Protect / release all saved images.

- If you protect an image, the protect icon will be displayed on the LCD monitor. (An unprotected image has no indicator)
- An image in Lock mode will be protected from the delete function or [Delete] functions, but will NOT be protected from the [Format] function.

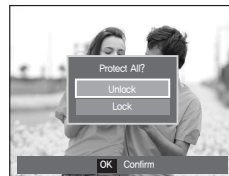
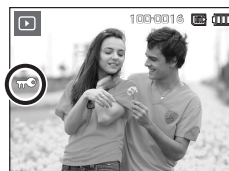

## Deleting images

This deletes images stored on the memory card.

1. Press the **Up/Down** button and select the [Delete] menu tab. And then press the **Right** button.
2. Select a desired sub menu by pressing the **Up/Down** button and press the **OK** button.

[Select]: Selection window for an image to delete is displayed.

- **Up/Down/Left/Right** button: Select an image.
- **Zoom T** button: Select the image for deletion. (V mark)



## Playback (▶)

- **OK** button: Press the **OK** button to display the confirmation message. Select the [Yes] menu and press the **OK** button to delete marked images.

[All]: Displays confirmation window. Select the [Yes] menu and press the **OK** button to delete all unprotected images. If there are no protected images, all the images are deleted and a [No Image!] message will display.

3. After deletion, the screen will be changed to the play mode screen.

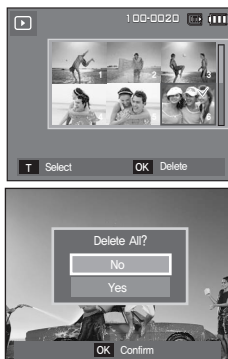

- Of all the files stored in the memory card, the unprotected files in the DCIM subfolder will be deleted. Remember that this will permanently delete unprotected images. Important shots should be stored on a computer before deletion takes place. The startup image is stored in the camera's internal memory (i.e., not on the memory card) and it will not be deleted even if you delete all files on the memory card.

## DPOF

- DPOF(Digital Print Order Format) allows you to embed printing information on your memory card's MISC folder. Select the pictures to be printed and how many prints to make.
- The DPOF indicator will display on the LCD monitor when an image that has DPOF information plays back. Images can then be printed on DPOF printers, or at an increasing number of photo labs.
- This function is not available for movie clips and voice recording files.
- When the wide angle image is printed as a wide angle print, 8% of the left and right side of the image may not be printed. Check that your printer can support the wide angle image when you print the image. When you print the image at a photo lab, request that the image is printed as a wide angle image. (Some photo labs may not support the wide angle size print.)

# Playback (▶)

## ■ Standard

This function allows you to embed printing quantity information on a stored image.

1. Press the **Up/Down** button and select the [DPOF] menu tab. And then press the **Right** button.
2. Press the **Right** button again and [Standard] sub menu will display.
3. Select a desired sub menu by pressing the **Up/Down** button and press the **OK** button.  
[Select]: Selection window for an image to print is displayed.
  - **Up/Down/Left/Right** button: Select an image to print.
  - **Zoom W/T** button: Select the number of prints.  
[All]: Configure number of prints for all pictures except movie and voice files.
  - **Zoom W/T** button: Select a number of prints.  
[Cancel]: Cancel the print setup.

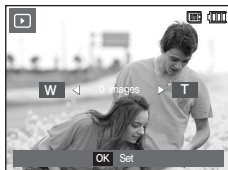
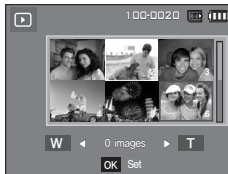
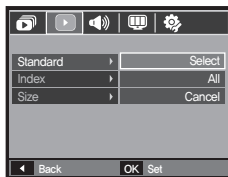

4. Press the **OK** button to confirm the setting. If an image carries DPOF instructions, the DPOF (▶) indicator will show.

## ■ Index

Images (except for movie clips and voice file) are printed as index type.

1. Press the **Up/Down** button and select the [DPOF] menu tab. And then press the **Right** button.
2. Press the **Right** button again and [Index] sub menu will be displayed.
3. Select a desired sub menu by pressing the **Up/Down** button.  
If [No] is selected: Cancel the index print setting.  
If [Yes] is selected: The image will be printed in index format.
4. Press the **OK** button to confirm the setting.



# Playback (▶)

## ■ Print size

You can specify the print size when printing images stored on the memory card. The [Size] menu is available only for DPOF 1.1 compatible printers.

1. Press the **Up/Down** button and select the [DPOF] menu tab. And then press the **Right** button.
2. Press the **Right** button again and select the [Size] sub menu will be displayed.
3. Select a desired sub menu by pressing the **Up/Down** button and press the **OK** button.

[Select]: Selection window for an image to be changed printed size is displayed.

- **Up/Down/Left/Right** button: Select an image.
- **Zoom W/T** button: Change the print size.

– **OK** button: Your changes will be saved and the menu will disappear.

[All]: Change print size of all saved images.

- **Zoom W/T** button: Select a print size.
- **OK** button: Confirm the changed setting.

[Cancel]: Cancel all of the print size settings.

\* DPOF [Size] secondary menu: Cancel, 3X5, 4X6, 5X7, 8X10

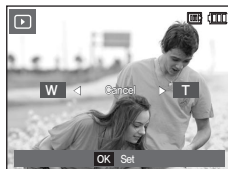
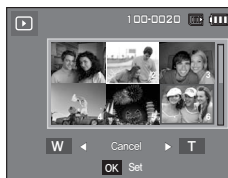

- Depending on the manufacturer and print model, cancelling the printing may take a little longer for the printer to process.

## Copy To Card

This enables you to copy image files, movie clips and voice recording files to the memory card.

1. Select the [Copy To Card] menu tab by pressing the **Up/Down** button. And then press the **Right** button.
2. Select a desired sub menu by pressing the **Up/Down** button and press the **OK** button.

– [No]: Cancels [Copy to Card].

– [Yes]: All images, movie clips and voice recording files saved in the internal memory are copied to the memory card after the [Processing!] message is displayed. After copying has been completed, the screen will return to play mode.



## Playback (▶)









- When this menu is selected without inserting a memory card, the [No Card!] message will be displayed.
- If there is not enough space available in the memory card to copy saved images in the internal memory (190MB), the [Copy To Card] command will copy only some of the images and display [Memory Full!] message. Then the system will return to the Playback mode. Please be sure to delete any unnecessary files to free up space before inserting the memory card into the camera.
- When you move the images that are stored in the internal memory by doing [Copy To Card] to the card, the next number of file names will be created in the card to avoid duplication of the file name.
  - When the [Reset] of the [File] setup menu is set: The copied file names start from after the last stored file name.
  - When the [Series] of the [File] setup menu is set: The copied file names start from after the last captured file name. After completing [Copy To Card], the last stored image of the last copied folder is displayed on the LCD monitor.

## Sound menu

In this mode, you can set up sound settings. You can use the setup menu in all camera modes, except Voice recording mode.

- The items indicated by  are default settings.

Mode	Menu	Sub Menu	Available Mode	Page
 (SOUND)	Volume	Off		p.84
		Low		
		Medium		
		High		
	Start Sound	Off		
		Sound 1		
		Sound 2		
	Shutter Sound	Off		
		Sound 1		
		Sound 2		
	Beep Sound	Off		
		Sound 1		
		Sound 2		
	AF Sound	Off		
		On		
Self Portrait	Off			
	On			



# Sound

## Volume

You can set select a volume of start up sound, shutter sound, beep sound and AF sound.

- [Volume] sub menu: [Off], [Low], [Medium], [High]

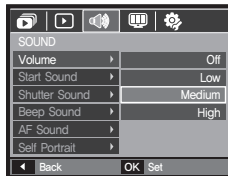

## Start up sound

You can select the sound that is activated whenever the camera is turned on.

- Start Sound: [Off], [Sound 1], [Sound 2], [Sound 3]
- If the start up image is set to [Off], the start up sound will not activate, even though you may have set these to on.

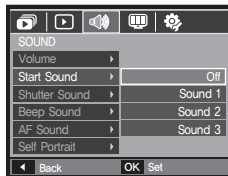

## Shutter sound

You can select the shutter sound.

- Shutter Sound: [Off], [Sound 1], [Sound 2], [Sound 3]

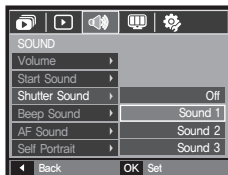

## Beep Sound

If you set sound to on, various sounds will be activated for camera startup, when **MENU/OK** button is pressed, so that you can be aware of the camera operation status.

- [Beep Sound] sub menu: [Off], [Sound 1, 2, 3]



## AF sound

If you set AF sound to on, AF sound will be activated when the **Shutter** button is pressed down half way so that you can be aware of the camera operation status.

- [AF Sound] sub menu: [Off], [On]

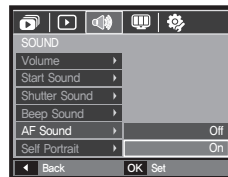

## Self Portrait

This feature automatically detects the location of the face and optimises the camera settings to ensure a great self portrait.

- This feature can be set by using the [Off] and [On] buttons.

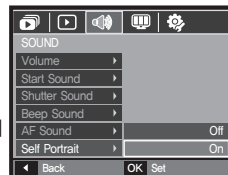

# Setup menu

In this mode, you can set up basic settings. You can use the setup menu in all camera modes, except Voice recording mode.

- The items indicated by  are default settings.

Menu tab	Main menu	Sub menu		Page	
	Language	ENGLISH	한국어	FRANÇAIS	p.86
		DEUTSCH	ESPAÑOL	ITALIANO	
		简体中文	繁體中文	日本語	
		РУССКИЙ	PORTUGUÊS	DUTCH	
		DANSK	SVENSKA	SUOMI	
		ไทย	BAHASA	عربي	
		Čeština	POLSKI	Magyar	
		Türkçe	–	–	
SETUP1	Date&Time	yy/mm/dd	Off		p.86
		dd/mm/yy	mm/dd/yy		
	World Time	London	Rome, Paris, Berlin		
		Athens, Helsinki	Moscow		
		Teheran	Abu Dhabi		
		Kabul	Tashkent		
		Mumbai, New Delhi	Kathmandu		
		Almaty	Yangon		
		Bankok, Jakarta	Beijing, Hong Kong		
		Seoul, Tokyo	Darwin, Adelaide		

Menu tab	Main menu	Sub menu		Page	
SETUP1	Date&Time	World Time	Guam, Sydney	Okhotsk	p.86
			Wellington, Auckland	Samoa, Midway	
			Honolulu, Hawaii	Alaska	
			LA, San Francisco	Denver, Phoenix	
			Chicago, Dallas	New York, Miami	
			Caracas, La Paz	Newfoundland	
			Buenos Aires	Mid-Atlantic	
			Cape Verde	–	
	Start Image	Off		Logo	p.87
		User Image		–	
LCD	Auto		Dark		
	Normal		Bright		
Quick View	Off	0.5, 1, 3sec			
LCD Save	Off	On			
SETUP2	Format	No	Yes	p.88	
	Reset	No	Yes	p.88	
	File	Reset	Series	p.89	
	Imprint	Off		Date	p.90
		Date&Time		–	
	Power Off	1, 3, 5, 10min	–		p.90
	Video Out	NTSC	PAL		p.91
	AF Lamp	Off	On		p.92

× Menus are subject to change without prior notice.

# SETUP1 (🔊)

## Language

There is a choice of languages that can be displayed on the LCD monitor. Even if the battery is removed and inserted again, the language setting will be preserved.

- Language sub menu:  
English, Korean, French, German, Spanish, Italian, S.Chinese, T.Chinese, Japanese, Russian, Portuguese, Dutch, Danish, Swedish, Finnish, Thai, Bahasa (Malay/Indonesian), Arabic, Czech, Polish, Hungarian and Turkish



## Setting up the Date / Time / Date type

You can change the date and time that will be displayed on the captured images and set up the date type.

- Date type:[yy/mm/dd], [Off],  
[dd/mm/yy], [mm/dd/yy].



- World time  
Available cities:  
London, Cape Verde, Mid-Atlantic, Buenos Aires, Newfoundland, Caracas, La Paz, New York, Miami, Chicago, Dallas, Denver, Phoenix, LA, San Francisco, Alaska, Honolulu, Hawaii, Samoa, Midway, Wellington, Auckland, Okhotsk, Guam, Sydney, Darwin, Adelaide, Seoul, Tokyo, Beijing, Hong Kong, Bangkok, Jakarta, Yangon, Almaty, Kathmandu, Mumbai, New Delhi, Tashkent, Kabul, Abu Dhabi, Teheran, Moscow, Athens, Helsinki, Rome, Paris, Berlin
- [DST] (Daylight Saving Time): Press the **Up** button to set up [DST].  
(🔊) icon will appear in front of the city name.



# SETUP1 (🔊)

## Start up image

You can select the image that is first displayed on the LCD monitor whenever the camera is turned on.

- Sub menus: [Off], [LOGO], [User Image]
- Use a saved image for the start-up image with the [Start Image] in the [RESIZE] menu in the play mode.
- The start-up image will not be deleted by [Delete] or [Format] menu.
- The User images will be deleted by [Reset] menu.

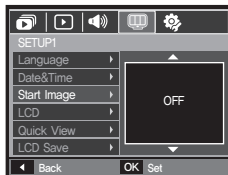

## Quick view

If you enable Quick View before capturing an image, you can view the image you just captured on the LCD monitor for the duration set in the [Quick View] setup. Quick view is possible only with still images.

- Sub menus  
[Off]: The quick view function can't be activated.  
[0.5, 1, 3 sec]: The captured image is briefly displayed during the selected time.

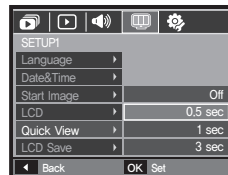

## LCD brightness

You can adjust the LCD brightness.

- Sub menus: [Auto], [Dark], [Normal], [Bright]

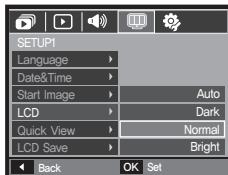

## LCD save

If you set the [LCD save] to On and the camera isn't operated during the specified time, the LCD monitor will be turned off automatically.

- Sub menus  
[Off]: The LCD monitor will not be turned off.  
[On]: If the camera isn't operated during the specified time (about 30 SEC.), the camera power will be idle (Camera status lamp:Blinking) automatically.

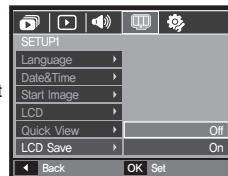

# SETUP2 (⚙️)

## Formatting a memory

If you run [Format] on the memory, all files which are image, video clip, multimedia, world tour guide and even protected images will be deleted. So be sure to download important files to your PC before formatting the memory.

- Sub menus

[No]: The memory will not be formatted.

[Yes]: A window for confirming the selection displays.

If you select the [Yes] menu, another window for confirming the selection will be displayed.

[Keep Folder]: Folders are remained even though the memory is formatted.

[Delete Folder]: All folders as well as all files are deleted.

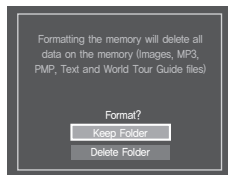
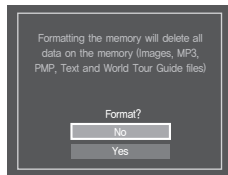
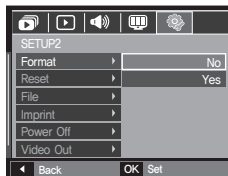

- A [Processing!] message appears and the memory will be formatted. If you run FORMAT in Play mode, a [No Image!] message will appear.

- Be sure to run [Format] on the following types of memory card.

- A new memory card, or an unformatted memory card
- A memory card that has a file this camera can't recognise or one that has been taken from another camera.
- Always format the memory card using this camera. If you insert a memory card that has been formatted using other cameras, memory card readers, or PCs, you will get a [Card Error!] message.

## Initialisation

All camera menu and function settings will be restored to their default values. However, values for Date/Time, Language, and Video will not be changed.

- Sub menus

[No]: Settings will not be restored to their defaults.

[Yes]: A window for confirm the selection displays. Select the [Yes] menu and all settings will be restored to their defaults.

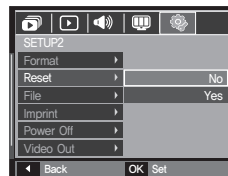

## SETUP2 (⚙️)

### File name

This function allows the user to select the file naming format.

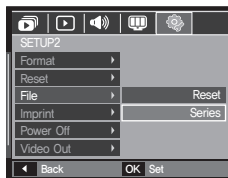

- The first stored folder name is 100SSCAM, and the first file name is SDC10001.
- File names are assigned sequentially from SDC10001 → SDC10002 → ~ → SDC19999.
- The folder number is assigned sequentially from 100 to 999 as follows: 100SSCAM → 101SSCAM → ~ → 999SSCAM.
- Maximum numbers of files in a folder are 9999.
- The files used with the memory card conform to the DCF (Design rule for Camera File systems) format. If you change the image file name, the image may not play back.

File name	Description
[Reset]	After using the reset function, the next file name will be set from 0001 even after formatting, deleting all or inserting a new memory card.
[Series]	New files are named using numbers that follow the previous sequence, even when a new memory card is used, or after formatting, or after deleting all pictures.

## SETUP2 (⚙️)

### Imprinting the recording date

There is an option to include DATE/TIME on still images.

- Sub menus

[Off]: The DATE & TIME will not be imprinted on the image file.

[Date]: Only the DATE will be imprinted on the image file.

[Date&Time]: The DATE & TIME will be imprinted on the image file.

- × The Date & Time are imprinted at the bottom right side of the still image.
- × The imprint function is applied only to still images except for the images taken in [Photo Frame] effect mode.
- × Depending on the manufacturer and print mode, the date printed on an image may not be printed correctly.

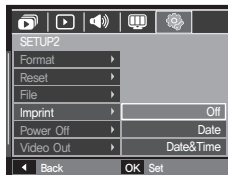

### Auto power off

This function switches the camera off after a set amount of time in order to prevent unnecessary battery drainage.

- Sub menus

[1, 3, 5, 10 min]: The power will turn off automatically if not used for the period of time specified.

- After replacing the battery, the [Power Off] setting will be preserved.

- Note that the automatic [Power Off] function will not operate if the camera is in the PC/Printer mode, slide show, playing back a voice recording and playing back a movie clip.

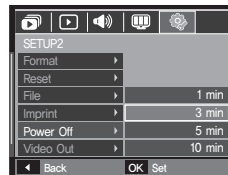

# SETUP2 (⚙️)

## Selecting video out type

The Movie output signal from the camera can be NTSC or PAL. Your choice of output will be governed by the type of device (monitor or TV, etc.) to which the camera is connected. PAL mode can support only BDGHI.

### ■ Connecting to an external monitor

When the camera is connected to an external monitor, the image and menus on the LCD monitor will be visible on the external monitor and the LCD monitor of the camera.

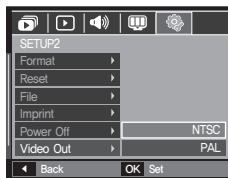

Selecting Video out type	Description
NTSC	U.S.A, Canada, Japan, South Korea, Taiwan, Mexico.
PAL	Australia, Austria, Belgium, China, Denmark, Finland, Germany, U.K., Holland, Italy, Kuwait, Malaysia, New Zealand, Singapore, Spain, Sweden, Switzerland, Thailand, Norway.

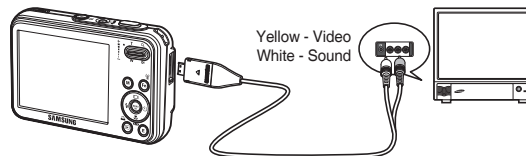

- When using a TV as an external monitor, you will need to select the external or AV channel of the TV.
- There will be a digital noise on the external monitor, but it is not a malfunction.
- If the image is not in the centre of the screen, use the TV controls to centre it.
- When the camera is connected to an external monitor, some parts of the image may not be displayed.
- When the camera is connected to an external monitor, the menu will be visible on the external monitor and the menu functions are the same as those indicated on the LCD monitor.
- When the camera is connected to an external monitor, the button sound may not function.



## SETUP2 (⚙️)

### Auto focus lamp

You can turn on and off the Auto Focus lamp.

- Sub menus

[Off]: The AF lamp will not light up in low light conditions.

[On]: The AF lamp will light up in low light conditions.

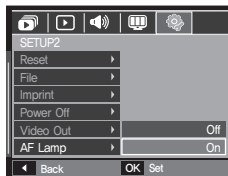

## PictBridge

You can use the USB cable to connect this camera to a printer that supports PictBridge (sold separately) and print the stored images directly. Movie clips and voice files cannot be printed.

■ Setting up the camera for connection to the printer

1. Connect the camera and printer with USB cable.
2. Select the [Printer] menu by pressing **Up/Down** button and press the **OK** button.



■ Connecting the Camera to a Printer

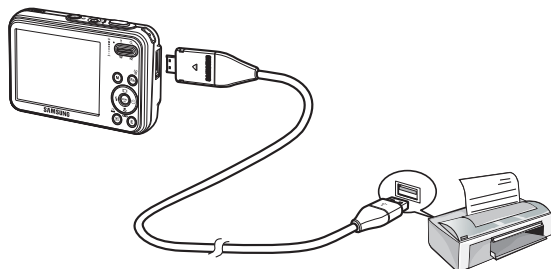

# PictBridge

- × If the [USB] menu is set to the [Computer], you cannot connect a PictBridge compatible printer to the camera through USB cable with [Connecting Computer] message. In this case, remove the cable and do the step 1 and 2 again.

## ■ Easy printing

When you connect the camera to printer in the Play back mode, you can print a picture easily.

- Pressing the **Left/Right** button:  
Selects a previous / next image.
- Pressing the **Print** (  ) button:  
Currently displayed image will be printed with the printer's default setting.

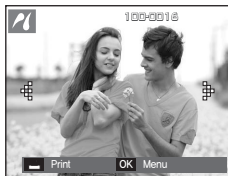

# PictBridge: Picture Selection

You can select images you want to print.

## ■ Setting the Number of Copies to Print

1. Press the **MENU** button and the PictBridge menu will be displayed.
2. Use the **Up/Down** button to select the [Images] menu and press the **Right** button.
3. Use the **Up/Down** button to select a desired sub menu and press the **OK** button.

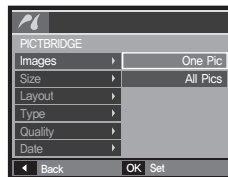

- Select [One Pic] or [All Pics]. A screen where you can set the number of copies to print will appear as shown below.

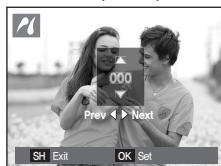

<When [One Pic] is selected>

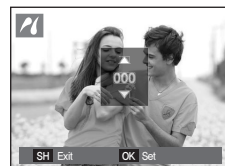

<When [All Pics] is selected>

- Press the **Up/Down** button to select the number of prints.
  - When [One Pic] is selected: Use the **Left/Right** button to select another picture. After selecting another picture, select the number of prints for another picture.
  - After setting the number of prints, press the **OK** button to save.
  - Press the **Shutter** button to return to the menu without setting the number of prints.
4. Press the **Print** (  ) button and images will be printed.

## PictBridge: Print Setting

You can select the Paper Size, Print Format, Paper Type, Print Quality, Date Print, and File Name Print menus for printed pictures.

1. Press the **MENU** button and the PictBridge menu will be displayed.
2. Use the **Up/Down** button to select the desired menu, and then press the **Right** button.
3. Use the **Up/Down** button to select the desired sub menu value, and then press the **OK** button.

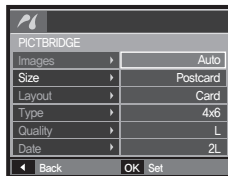

Menu	Function	Sub menu
[Size]	Set the size of the printing paper.	Auto, PostCard, Card, 4X6, L, 2L, Letter, A4, A3
[Layout]	Set the number of pictures to be printed on a sheet of paper.	Auto, Full, 1, 2, 4, 8, 9, 16, Index
[Type]	Set the quality of the printing paper.	Auto, Plain, Photo, FastPhoto
[Quality]	Set the quality of the picture to be printed.	Auto, Draft, Normal, Fine
[Date]	Set whether to print the date.	Auto, Off, On
[File Name]	Set whether to print the file name.	Auto, Off, On

- × Some menu options are not supported on all printers. If not supported, the menus are still displayed in the LCD, but are not selectable.

## PictBridge: Reset

Initialises user-changed configurations.

1. Use the **Up/Down** button to select the [Reset] menu tab. And then press the **Right** button.
2. Use the **Up/Down** button to select the desired sub menu value, and then press the **OK** button.

If [Yes] is selected: All print and image settings will be reset.

If [No] is selected: Settings will not be reset.

- × Default print setting varies depending on the printer manufacturer. For your printer's default setting, refer to the user's guide that came with your printer.

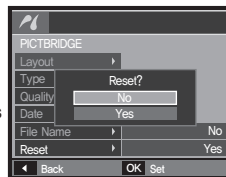

# MP3 / PMP / TEXT VIEWER mode

- This camera has an embedded MP3, TEXT VIEWER & Portable Media Player program. You can take a picture, listen to the MP3 files and watch the movie clip (Movie and Video clip) whenever you want. To use the PMP mode, you must convert the multimedia file with the Samsung Converter. In the TEXT VIEWER mode you can see the text on the LCD monitor with listening MP3 music.
- If the file or folder name is over 120 (Including 1 Byte/2 Byte language, Korean, Chinese, etc.) characters, the file or folder name doesn't appear on the play list.

## Downloading files

To use MP3, PMP and TEXT VIEWER functions, MP3, PMP (multimedia files) and TEXT files must be saved in the internal memory or memory card of this camera.

1. Save the desired files on your PC.
2. Connect the camera to your PC with the USB cable and turn on the camera.
3. Open Window's EXPLORER and search for Removable Disk.
4. Make a folder under the Removable Disk.

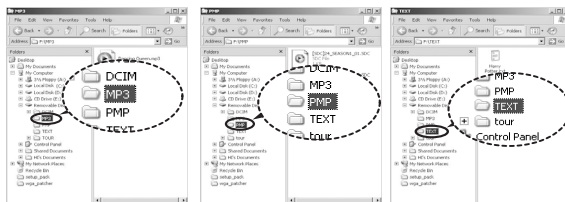

MP3 Mode: [MP3]

PMP Mode: [PMP]

TEXT VIEWER mode: [TEXT]

5. Select files that you want to save and copy them to the desired folder.

# Starting the MP3 / PMP / TEXT VIEWER mode



- Take care of the illegal duplication of MP3 & multimedia files. It violates various copyright laws.
- Without permission of Samsung, you cannot copy, modify and/or distribute any part or all of MP3, PMP file provided in the internal memory.
- This camera can only play back MP3 files in the MP3 mode and SDC files (modified XviD MPEG4 video / MPEG Layer2 audio type) in the PMP mode.
- If a file can not be played back on this camera, convert it into the supported file format by using the Samsung Converter. (p.126~127)
- Up to 200 files and 100 sub folders can be saved in a folder. It is limited to save the files and sub folders up to 200 in total at the same time.
- New folders can be created within the MP3, PMP and TEXT folders. Otherwise any files in other folders that you create cannot be played back.

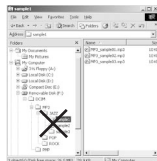

Insert the memory card that holds MP3, PMP and TEXT files. As this camera has a 190MB internal memory, you can save the files on the internal memory too.

1. Select a desired Multi media mode. (p.97)

2. A menu will display as shown.

[Resume]: Memorizes the latest stopped frame.

MP3 mode: Plays back from the beginning of the file.

PMP mode: Plays back from the latest stopped frame.

TEXT VIEWER mode: Plays back from the latest stopped frame.

[Open]: The browsing menu will be displayed to select a desired file.

3. Select a desired file and press the **OK** button. And then the file will play back.

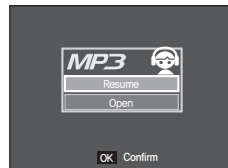
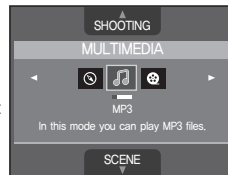

# Starting the MP3 / PMP / TEXT VIEWER mode

## <MP3 mode>

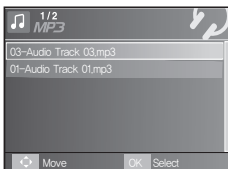

- When the [Resume] menu (p.102) of each mode are set as [Off], the browsing menu doesn't open. If the last played file was deleted, the browsing menu opens though the setting is the same as above.
- The order of play lists on the browsing menu and the order of files saved in the memory are the same.
- A title coded with unsupported language is displayed as "-----".
- The automatic power off function will not operate if a file is playing back.
- If there are over 100 files or a lot of large files in the sub folder, it takes a little longer for the camera to process to the MP3 / PMP mode.
- If there is no operation during the specified time (About 30 sec.) in the MP3 / TEXT VIEWER mode (B.G.M: Off, Auto scroll: Off), the LCD monitor is turned off automatically and the camera status lamp blinks. To use the camera, press any of the camera buttons except the **POWER** button.
- Playing back a VBR (Variable Bit Rate) file. A VBR file varies the amount of output data in each time segment based on the complexity of the input the data in that segment. When the VBR encoded files are played back, the LCD will appear as shown.
  - The VBR icon will be displayed instead of the Bit rate icon.
  - Playing time will display but the whole running time doesn't display.
- For about 2 seconds of the start and end frames of the PMP file, no camera button except the **POWER** button can be operated.
- When an MP3 file doesn't play back correctly, download a free MP3 conversion program and convert it before using the MP3 file on the camera.
- Depending on the file type, the movie may be paused during playing back in the PMP mode. The movie restarts automatically and it is not a camera malfunction.

## <PMP mode>

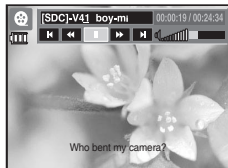
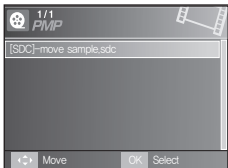

## <TEXT VIEWER mode>

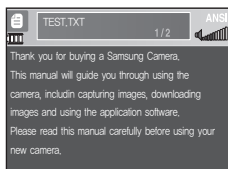

# LCD monitor indicator for MP3 / PMP / TEXT VIEWER mode

The LCD monitor displays information about the MP3, multimedia and Text file.

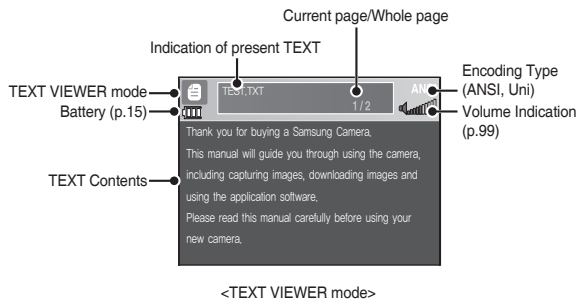
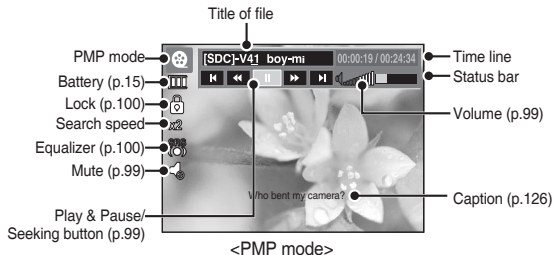
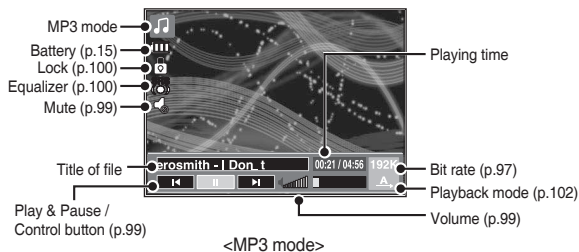

- × Encoding Type: ANSI (American National Standards Institute) Type, Uni (Unicode) Type
  - When the ANSI encoding type is displayed:  
You should set the Language of the TEXT VIEWER menu to view the text. Set the Language menu as one that is the same as the Operating System language that the text was created.
  - When the UNI encoding type is displayed:  
The text file will be displayed with any language menu.
- × If the text file size is over 10MB, it may take a long time or even be impossible to view the text file. In this case, please divide the text file.

# Using the camera buttons to adjust the camera

## Volume button

You can control the volume with this button. There are 0 ~ 30 steps.

- Mute (): You can mute the MP3 sound with the **Up** button.

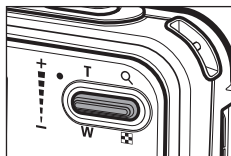

## Play & Pause / Seeking button

- When a file is playing back, press the **Down** button to pause the file. Pressing it again will resume playback.
- MP3 mode  
You can search the MP3 files by pressing the **Left/Right** button.
- PMP mode  
You can search the Multimedia files by pressing the **Left/Right** button. You can search a desired frame of the file during play back by pressing the **Left/Right** button. (2X-32X)
- TEXT VIEWER mode  
When the text list menu is displayed: select a text file by pressing the **Up/Down** button.  
When the text is displayed: press the **Up/Down** button and previous / next page of the file will be displayed. Press and hold the **Up/Down** button and it will skip 10 pages at a time.

## Delete button

This deletes files stored on the memory.

1. Select a desired file to delete on the browsing menu and press the **Delete** button.
2. A message will appear as shown  
[No]: Cancels "Delete files" and the browsing menu will display.  
[Yes]: Deletes the selected file.

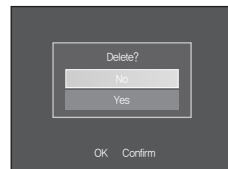

- Before deleting files from the camera, take care to download files you want to keep to your computer.



# Using the camera buttons to adjust the camera

## Hold / Equalizer button

- If you press the Hold button for more than 1 second, the camera buttons are locked.
  - If the camera buttons are locked, the buttons can't be operated while playing back. But Power off, Video out, USB connection and LCD on functions can be operated.

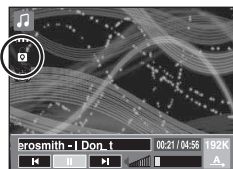
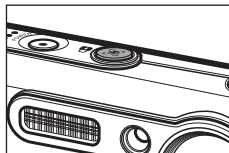



- If you press the **Lock** button again or turn off the camera, the camera is unlocked.
- The user can select appropriate sound with this setting.
  - Press the **E** button and select either <SRS>, <Normal>, <Live>, <Classic>, <Jazz>, <Rock> or <Dance>.



## Playlist button

While a multimedia file is playing back, you can select a desired file by using the browsing menu.

1. While a multimedia file is playing back, press the **Playlist** () button.
2. A playlist that is currently playing will be highlighted.
3. Move the cursor to a desired list by pressing the Control button. Pressing the **OK** button: the selected file is played back. Pressing the **Playlist** () button: the selection will be cancelled.



<MP3 Mode>



<PMP Mode>



<TEXT VIEWER Mode>

# Setting up the playback function using the LCD monitor

MP3 / PMP / Text Viewer mode functions can be changed by using the LCD monitor. Press the **MENU** button and the menu will be displayed on the LCD monitor.

	Menu tab	Main menu	Sub menu		Page
MP3		Resume	On	Off	p.102
		Play Mode	Play All	Repeat One	p.102
	MODE		Repeat All	Shuffle	
		MP3 Skin	Default 1	Default 2	p.102
			User Skin 1	User Skin 2	
		Slide Show	Show Play	Play/Repeat Play	p.103
			Show Interval	2, 3, 5 sec	
	Delete All	No	Yes	p.103	
	Information of DRM file	-	-	p.104	
PMP		Resume	On	Off	p.102
		Seeking	Normal	30 sec	p.103
			1 min	3 min	
			5 min	10 min	
		Player Display	5sec	On	p.104
Off			-		
	Delete All	No	Yes	p.103	

	Menu tab	Main menu	Sub menu			Page
TEXT VIEWER		Resume	On	Off		p.102
		Auto Scroll	Off	0.8 sec		p.104
			1.1 sec	1.4 sec		
			1.7 sec	2.0 sec	2.3 sec	
		MP3 BGM	Off	On		p.105
		Language	ENGLISH	한국어	FRANÇAIS	p.105
			DEUTSCH	ESPAÑOL	ITALIANO	
			简体中文	繁體中文	日本語	
			РУССКИЙ	PORTUGUÊS	DUTCH	
			DANSK	SVENSKA	SUOMI	
BAHASA			Čeština	POLSKI		
	Magyar	Türkçe	-			
	Delete All	No	Yes		p.103	

\* Menus are subject to change without prior notice.

# Setting up the playback function using the LCD monitor

## Resume

You can set the playback type.

1. Press the **MENU** button in each mode.
2. Select a desired playing type in the [Resume] menu by pressing the **Up/Down** button and pressing the **OK** button.

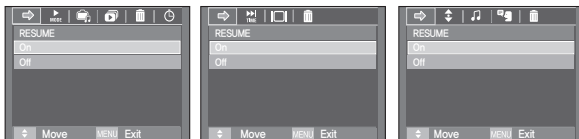

<MP3 mode>

<PMP mode>

<TEXT VIEWER mode>

- [Off]: The browsing menu will be displayed to select a desired file.  
[On]: When the camera is turned on / off or camera mode is changed, this camera will memorize the latest stopped frame.  
MP3 mode: plays back from the beginning of the file.  
PMP mode: plays back from the latest stopped frame.  
TEXT VIEWER mode: plays back from the last stopped frame.

## Play mode

You can set various repeat and shuffle options. This function is adopted only in the selected folder.

[Play All]: Plays a single track once.

[Repeat One]: Plays a single track repeatedly.

[Repeat All]: Plays all tracks in the folder repeatedly.

[Shuffle]: Randomly plays all tracks in the folder repeatedly.

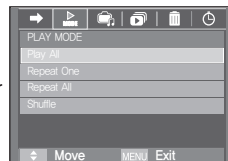

## Skin of MP3 player

You can set the skin of MP3 player.

[Default 1, 2]: Default skin will be set.

[User Skin 1, 2]: An image created by the [MP3 Skin] menu (p.64) will be set.

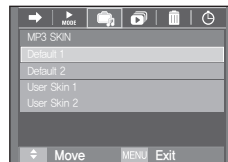

# Setting up the playback function using the LCD monitor

## Playing back the slide show

While the MP3 file is playing back, captured images are displayed on the LCD monitor continuously.

[Play]: Display the images once.

[Repeat Play]: Display the images continuously.

- × When the playing back is complete, the slide show will stop.
- × To stop the slide show, press the **E** button.

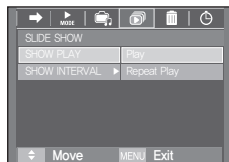

## Setting slide show interval

You can set the slide show play interval of MP3 mode.

- Select an interval from 2, 3 or 5 seconds.

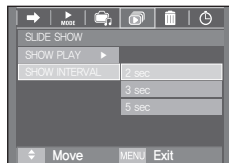

## Delete all

All files stored on the memory card will be deleted. In the MP3 mode, only MP3 files are deleted. In the PMP mode, only multimedia files are deleted. In the TEXT VIEWER mode, TEXT files are deleted.

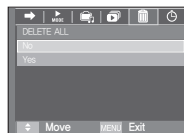

<MP3 mode>

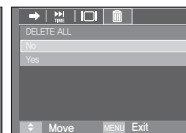

<PMP mode>

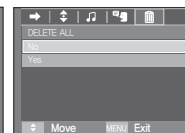

<TEXT VIEWER mode>

[No]: Cancels "Delete files"

[Yes]: A confirmation window will display. Select [Yes] and press the **OK** button. All files will be deleted.

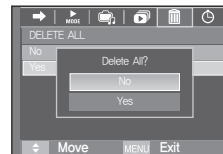

## Frame search

You can set the time of skip range when you search the movie by pressing the **Left/Right** button. You can search a frame you want easily.

[Normal, 30 sec, 1, 3, 5, 10 min]:

This will skip a set frame whenever you press the **Left/Right** button.

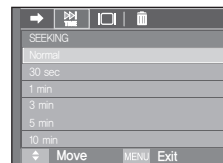

# Setting up the playback function using the LCD monitor

## Display setting

You can set the play back function display on the LCD.

[5 sec]: If there is no operation during 5 seconds, Menu bar will disappear.

[On]: Menu bar will appear on the LCD monitor.

[Off]: Menu bar will not appear on the LCD monitor.

- × To see the caption, insert the caption file (.smi) by using the Samsung Converter. (p.126)
- × If a multimedia file has a caption, the caption will appear regardless of display setting.

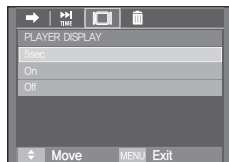

## Information of DRM file

The information of the MP3 file with DRM displays.

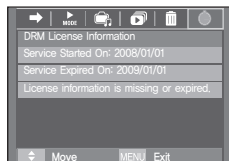

<MP3 mode>

- × Only 'Netsync DRM' files downloaded from SMS(Samsung media studio) Korean online shop can be played back.

## Setting up the recording function in the MP3 mode

You can take a picture and listen to the MP3 files at the same time.

1. Press the **Shutter** button and the MP3 stand-by icon will appear.
2. Press the **Shutter** button and an image will be captured.



- The camera settings are fixed to default setting of Auto mode (3M, 30FPS, 4.0, 100). The settings can't be changed.
- If the memory card is not inserted, this function will not operate. Occasionally the next file will be played back when you press the **Shutter** button, even though a memory card is inserted.
- To cancel the recording mode of the MP3 mode, press the **E** button or do not operate any buttons for about 10 seconds.
- The equalizer setting is fixed to <Normal>.
- The MP3 sound may be a little louder in this mode.

## Auto Scroll

The playing text is scrolled automatically and displays on the LCD monitor.

[Off]: The text will not be scrolled automatically.

- × Press the **Up/Down** button and you can use the Auto Scroll function.

[0.8, 1.1, 1.4, 1.7, 2.0, 2.3 sec]:

The text will be scrolled automatically.

The interval is marked on each menu icon.

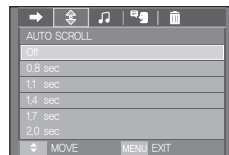

# Setting up the playback function using the LCD monitor

## MP3 BGM Setting

You can play MP3 files when you are playing the text.

- [Off]: You cannot play the MP3 files.
- [On]: When you are playing the text, you can play the MP3 files.

× The last played MP3 files will be executed.

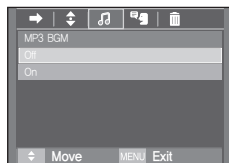

## Language setting

You can setup the language of OS (Operating System) in which the text file was made.

- If the characters of the text file aren't displayed correctly, open the file on Windows 2000 or later and save it again. We recommend using 'Notepad' and it has to be saved as ANSI encoding type.
- Some unique characters may not be displayed correctly on the camera.
- Encode the text files as the standard type or some characters may not be displayed correctly.

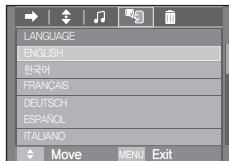

# World tour guide

You can get around the world useful travel information. The travel information supports Korean, English, Chinese, German, French and Russian and the language can vary depending on sales region. You can download the tour guide information from Samsung Camera website.

## Download the tour guide information

In order for you to use the World Tour Guide function, the tour information file should be stored on the memory. If there is a tour information file that you want, visit our website and download the desired file.

1. Visit <http://www.samsungcamera.com> then select the tour guide information you want.
2. Download the file to the computer and extract the file.
3. Connect and turn on the camera and computer.
4. Run the Window Explorer. Find the Removeable disk.
5. Make [TOUR] folder on the Removeable disk.

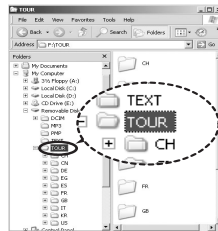

6. Select a file you want and copy it to the removable disk.

# World tour guide

## World Tour Guide mode

Select the World Tour Guide mode



Starting the world tour guide



Select the location by pressing the **Up/Down/Left/Right** button and press the **OK** button.



Select the country by pressing the **Up/Down/Left/Right** button and press the **OK** button.



Select the state by pressing the **Up/Down/Left/Right** button and press the **OK** button.



Select the desired tour site by pressing the **Up/Down/Left/Right** button and press the **OK** button.



Select the tour place by pressing the **Left/Right/Up/Down** button.

You can find the detail information and pictures.

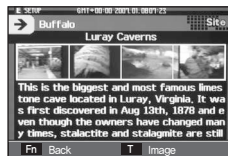

Check the images by pressing the **T** button.

Check the information of the site by pressing the **W** button.



Check other tour places by pressing **Left/Right** button.



Select the picture by pressing the **Up/Down** button and press the **OK** button. You can see the picture of the desired tour site on the screen.

# World tour guide

You can select desired function.

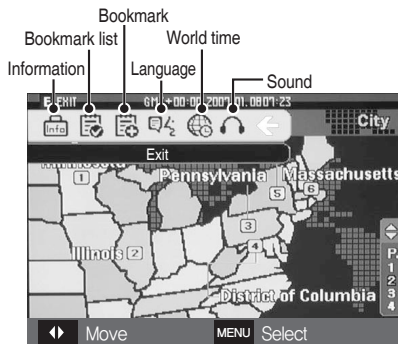

## ■ Adding the [Bookmark]

- 1 Select desired area and press **E** button to display a menu bar.



- 2 Select the [Bookmark].

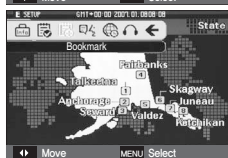

- 3 Select [Yes] to add bookmark. You can confirm the added bookmark in the Bookmark list.



## ■ Bookmark list

[Bookmark list]: Select the [Bookmark list] on the menu bar and the bookmark list will appear.

- Press the **MENU** button to display the tour guide information.
- Press the **Fn** button to delete the selected area in the bookmark list.



## ■ Language

[Language]: Select the [Language] on the menu bar and the language list will appear.



## ■ SOUND

[SOUND]: Select the [SOUND] on the menu bar and the sound list will appear.





## World tour guide

---



- Saving the information of some sites may take long time. Save each information of sites in order.
- If the downloaded files are changed by any non-official methods, the files don't playback on the camera.
- Formatting the camera deletes all data on the memory (including protected images, Movies, Multi media files and Tour Information). Copy the files to a computer before formatting the memory.
- If there is no related site information file on the memory, the site menu can be displayed but can't be selected.

## Important notes

---

Be sure to observe the following precautions!

- **This unit contains precision electronic components. Do not use or store this unit in the following locations.**
  - Areas exposed to severe changes in temperature and humidity.
  - Areas exposed to dust and dirt.
  - Areas exposed to direct sunlight or the inside of a vehicle in hot weather.
  - Environments where there is high magnetism or excessive vibration.
  - Areas with high explosives or highly flammable materials.
- **Do not leave this camera in places subject to dust, chemicals (like naphthalene and mothballs), high temperature and high humidity. Keep this camera with silica gel in a hermetically sealed box when not planning to use the camera for a long period of time**
- **Sand can be particularly troublesome to cameras.**
  - Do not let sand get inside the camera when using it on beaches, coastal dunes, or other areas where there is lots of sand.
  - Doing so may result in failure or may permanently render the camera unusable.
- **Handling the camera**
  - Never drop the camera or subject it to severe shocks or vibrations.
  - Protect the large size LCD monitor from an impact. When this camera is not used, keep it in the camera case.
  - Avoid obstructing the lens or the flash when you capture an image.

# Important notes

---

- This camera is not waterproof. To avoid dangerous electrical shocks, never hold or operate the camera with wet hands.
- If you use this camera in wet places, such as beach or pool, do not let water or sand get inside the camera. Doing so may result in failure or may permanently damage the unit.
- **Extremes in temperature may cause problems.**
  - If the camera is transferred from a cold to a warm and humid environment, condensation can form on the delicate electronic circuitry. If this occurs, turn the camera off and wait for at least 1 hour until all moisture is dispersed. Moisture built up can also occur on the memory card. If this happens, turn off the camera and remove the memory card. Wait until the moisture has dispersed before replacing the card in the camera.
- **Caution on Using the Lens**
  - If the lens is subjected to direct sunlight, it could result in the discoloration and deterioration of the image sensor.
  - Take care not to get fingerprints or foreign substances on the surface of the lens.
- **If the digital camera is not used for a long period, an electric discharge can occur. It is a good idea to remove the battery and the memory card if you do not intend using the camera for an extended period of time.**
- **If the camera is exposed to electronic interference, it will turn itself off to protect the memory card.**
- **Camera Maintenance**
  - Use a soft brush (available from photo stores) to gently clean the lens and LCD assemblies. If this does not work, lens-cleaning paper with lens cleaning fluid can be used. Clean the camera body with a soft cloth. Do not allow this camera to come into contact with solvent materials such as benzol, insecticide, thinners etc. This may damage the body shell of the camera and also affect its performance. Rough handling can damage the LCD monitor. Take care to avoid damage and keep the camera in its protective carry case at all times when not in use.
- **Do not attempt to disassemble or modify the camera.**
- **Under certain conditions, static electricity can cause the flash unit to fire. This is not harmful to the camera and is not a malfunction.**
- **When images are uploaded or downloaded, the data transfer may be affected by static electricity. In this case, disconnect and re-connect the USB cable before trying the transfer again.**
- **Before an important event or going on a trip, you should check the camera condition.**
  - Take a picture for testing the camera condition and prepare an extra battery.
  - Samsung cannot be held responsible for camera malfunctions.
- **Do not use headphones/earphones while driving, cycling, or operating any motorized vehicle. It may create a traffic hazard and can be illegal in some areas.**
- **Avoid using headphones/earphones at high volume. Hearing experts advise against continuously loud and extended play. If you experience a ringing in your ears, reduce volume or discontinue use.**

# Warning indicator

---

There are several warnings that may appear on the LCD display.

## [ Card Error ! ]

- Memory card error.
  - Turn off the camera power and turn it on again.
  - Insert the memory card again.
  - Insert and format the memory card. (p.88)

## [ Card Locked! ]

- The memory card is locked.
  - SD/SDHC memory card: Slide the write protect switch to the top of the memory card.

## [ No Card! ]

- A memory card is not inserted.
  - Insert the memory card.
  - Turn off the camera power and turn it on again.

## [ No Image! ]

- There are no images stored on the memory.
  - Take images.
  - Insert a memory card that is holding some images.

## [ File Error! ]

- File error.
  - Delete the file.
- Memory card error.
  - Contact a camera service centre.

## [ Low Battery! ]

- There is low battery capacity.
  - Insert fresh batteries.

## [ Low Light! ]

- When taking pictures in dark places.
  - Take pictures in Flash Photography mode.

## [Out of Number]

- When selecting too many printing pages in the PictBridge menu.
  - Select printing page within the limitation.

## [DCF Full Error]

- Violation of DCF format.
  - Copy the images to a PC and format the memory.

# Before contacting a service centre

Please check the following.

## The camera doesn't switch on.

- There is low battery capacity.
  - Insert fresh batteries. (p.15)
- Battery is inserted incorrectly with the polarities reversed.
  - Insert the battery according to the polarity marks (+, -).

## The camera power ceases while in use.

- The battery is exhausted.
  - Insert fresh batteries.
- The Camera is turned off automatically.
  - Turn on the camera power again.

## Battery power quickly drains.

- The Camera is being used in low temperatures.
  - Keep the camera in warm conditions (i.e. inside a coat or jacket) and only remove it in order to take images.

## Camera does not take images when pressing the Shutter button.

- There is insufficient memory capacity.
  - Delete unnecessary image files.
- The memory card has not been formatted.
  - Format the memory card (p.88).
- The memory card is exhausted.
  - Insert a new memory card.
- The memory card is locked.
  - Refer to [Card Locked!] error message.
- The camera's power is off.
  - Turn the camera power on.
- The battery is exhausted.
  - Insert fresh batteries. (p.15)
- Battery is inserted incorrectly with the polarities reversed.
  - Insert the battery according to the polarity marks (+, -).

## The camera suddenly stops working while in use.

- The camera stopped due to a malfunction.
  - Remove /re-insert battery and switch the camera on.

## The camera buttons do not operate.

- Camera malfunction.
  - Remove/re-insert battery and switch the camera on.

# Before contacting a service centre

## The images are unclear.

- A picture was taken of a subject without setting an appropriate macro mode.
  - Select an appropriate macro mode to take a clear image.
- Taking a picture beyond the flash range.
  - Take a picture within the flash range.
- The lens is smudged or dirty.
  - Clean the lens.

## The flash does not fire.

- Flash off mode has been selected.
  - Dis-engage flash off mode.
- The camera mode can't use the flash.
  - Refer to the FLASH instruction. (p.32-34)

## Incorrect date and time is displayed

- The date and time have been set incorrectly or the camera has adopted the default settings.
  - Reset the date and time correctly.

## A card error has occurred while the memory card is in the camera.

- Incorrect memory card format.
  - Re-format the memory card.

## The images don't play back.

- Incorrect file name. (Violation of DCF format)
  - Do not change the image file name.

## Colour of image is different to the original scene.

- White balance or effect setting is incorrect.
  - Select appropriate White balance and effect.

## Images are too bright.

- Exposure is excessive.
  - Reset exposure compensation.

## No image on external monitor.

- The external monitor has not been connected properly with the camera.
  - Check the connection cables.
- There are incorrect files in the memory card.
  - Insert a memory card that has correct files.

## When using the PC's explorer, the [Removable Disk] file does not show.

- Cable connection is incorrect.
  - Check the connection.
- The camera is off.
  - Turn the camera on.
- The operating system is not Windows 98SE, 2000, ME, XP, Vista / Mac OS 10.1 ~ 10.4. Alternatively the PC does not support USB.
  - Install Windows 98SE, 2000, ME, XP, Vista / Mac OS 10.1 - 10.4 to PC that supports USB.
- The camera driver is not installed.
  - Install a [USB Storage Driver].

# Specifications

Image Sensor	<ul style="list-style-type: none"> <li>- Type: 1/2.5" CCD</li> <li>- Effective Pixel: Approx. 8.2 Mega-pixel</li> <li>- Total Pixel: Approx. 8.3 Mega-pixel</li> </ul>														
Lens	<ul style="list-style-type: none"> <li>- Focal Length: Samsung Lens f = 6.3 ~ 18.9mm (35mm film equivalent: 38 ~ 114mm)</li> <li>- F No.: F3.5(W) ~ F4.5(T)</li> <li>- Digital Zoom:               <ul style="list-style-type: none"> <li>Still Image mode: 1.0X ~ 5.0X</li> <li>Play mode: 1.0X ~ 10.2X (depends on image size)</li> </ul> </li> </ul>														
LCD Monitor	<ul style="list-style-type: none"> <li>- 2.7" colour TFT LCD (230,000 pixel)</li> </ul>														
Focusing	<ul style="list-style-type: none"> <li>- Type: TTL auto focus, Multi AF, Center AF, Face Detection AF</li> <li>- Range</li> </ul>														
	<table border="1"> <thead> <tr> <th></th> <th>Normal</th> <th>Macro</th> <th>Super Macro</th> <th>Auto Macro</th> </tr> </thead> <tbody> <tr> <td>Wide</td> <td rowspan="2">80cm ~ Infinity</td> <td>5cm ~ 80cm</td> <td>1cm ~ 5cm</td> <td>5cm ~ Infinity</td> </tr> <tr> <td>Tele</td> <td>40cm ~ 80cm</td> <td>-</td> <td>40cm ~ Infinity</td> </tr> </tbody> </table>		Normal	Macro	Super Macro	Auto Macro	Wide	80cm ~ Infinity	5cm ~ 80cm	1cm ~ 5cm	5cm ~ Infinity	Tele	40cm ~ 80cm	-	40cm ~ Infinity
	Normal	Macro	Super Macro	Auto Macro											
Wide	80cm ~ Infinity	5cm ~ 80cm	1cm ~ 5cm	5cm ~ Infinity											
Tele		40cm ~ 80cm	-	40cm ~ Infinity											
Shutter	<ul style="list-style-type: none"> <li>- Speed 1 ~ 1/2,000 sec. (Night: 16 ~ 1/2,000 sec.)</li> </ul>														
Exposure	<ul style="list-style-type: none"> <li>- Control: Program AE</li> <li>- Metering: Multi, Spot, Center Weighted, Face Detection</li> <li>- Compensation: <math>\pm 2</math>EV (1/3EV steps)</li> <li>- ISO: Auto, 80, 100, 200, 400, 800, 1600, 3200(3M)</li> </ul>														

Flash	<ul style="list-style-type: none"> <li>- Modes: Auto, Auto &amp; Red-eye reduction, Fill-in flash, Slow sync, Flash off, Red-eye Fix</li> <li>- Range: Wide: 3.3m, Tele: 2.4m (ISO Auto)</li> <li>- Recharging Time: Approx. under 4 seconds (new battery)</li> </ul>
Sharpness	<ul style="list-style-type: none"> <li>- Soft+, Soft, Normal, Vivid, Vivid+</li> </ul>
White Balance	<ul style="list-style-type: none"> <li>- Auto, Daylight, Cloudy, Fluorescent_H, Fluorescent_L, Tungsten, Custom</li> </ul>
Voice Recording	<ul style="list-style-type: none"> <li>- Voice Recording (max 10 hours)</li> <li>- Voice Memo in Still Image (max. 10 sec.)</li> </ul>
Date Imprinting	<ul style="list-style-type: none"> <li>- Date, Date &amp; Time, Off (user selectable)</li> </ul>
Shooting	<ul style="list-style-type: none"> <li>- Still Image           <ul style="list-style-type: none"> <li>• Modes: Auto, Program, DIS, Fun, Photo Help Guide, Movie, Multimedia (MP3,PMP,TextViewer)</li> <li>× Scene: Night, Portrait, Children, Landscape, Text, Close-up, Sunset, Dawn, Backlight, Fireworks, Beach &amp; Snow, Cafe, Food, Self Shot (Total 14 modes)</li> <li>• Shooting: Single, Continuous, AEB(0.3 step unto 3cut), Motion Capture</li> <li>• Self-timer: 2 sec., 10 sec., Double(10 sec, 2 sec), Motion Timer</li> </ul> </li> </ul>

# Specifications

- Movie Clip
  - With Audio or without Audio (user selectable, recording time : memory capacity dependent, max 2hours)
  - Size: 800x592, 640x480, 320x240
  - Optical Zoom with sound recording
  - Frame rate: 30 fps, 20 fps, 15 fps (20 fps for 800x592)
  - Optical Zoom up to 3.0X
  - Movie Editing (Embedded): Pause during recording, Still Image Capture Time Trimming

## Storage

- Media
  - Internal memory: 256MB (User Memory: 190MB)
  - External Memory (Optional)  
MMC Plus (Up to 2GB, guaranteed)  
SD/SDHC Card (up to 4GB guaranteed)
  - \* Internal memory capacity is subject to change without prior notice.
- File Format
  - Still Image: JPEG (DCF), EXIF 2.2, DPOF 1.1, PictBridge 1.0
  - Movie Clip: AVI (MPEG-4)
  - Audio: WAV

## - Image Size and Capacity (256 MB Size)

	8M	7M	6M	5M	3M	1M
	3264x2448	3264x2176	3264x1836	2592x1944	2048x1536	1024x768
<b>Super Fine</b>	53	60	71	86	134	434
<b>Fine</b>	94	107	133	161	226	520
<b>Normal</b>	135	171	202	220	306	600

\* These figures are measured under Samsung standard conditions and may vary depending on shooting conditions and camera settings.

## Special "E" Button

- Recording Effect:
  - Photo Style Selector: Normal, Vivid, Soft, Forest, Retro, Cool, Calm, Classic
  - Color Effect: Normal, B&W, Sepia, Red, Blue, Green, Negative, Custom Color
  - Image Adjust: Saturation, Contrast, Sharpness
  - Fun: Cartoon, Photo Frame, High Light, Composite, Color Mask
- Playback Effect:
  - Image Edit: Resize, Rotate
  - Color: Normal, B&W, Sepia, Red, Blue, Green, Negative, Custom Color
  - Image Adjust: ACB, Red Eye Fix, Brightness, Contrast, Saturation, Add Noise
  - Fun: Cartoon, Photo Frame, High Light, Composite, Sticker, Color Filter, Color Mask

## Image Play

- Single image, Thumbnails, Slide show

# Specifications

---

Multi function	– MP3, PMP, World Tour Guide, Text Viewer, Portable Memory, Voice Recorder
Interface	– Digital output connector: USB 2.0 High Speed – Audio: Mono – Video output: NTSC, PAL (user selectable) – DC Adapter: 4.2V, 20 pin connector
Power Source	– Rechargeable battery: SLB-0937, 3.7V (900mAh) – Adaptor: SAC-47(DC 4.2V, 400mA) × Included battery may vary depending on sales region.
Dimensions (WxHxD)	– 90.7 X 58 X 19.9mm (excluding protrusions)
Weight	– 116g (without batteries and card)
Operating Temperature	– 0 ~ 40°C
Operating Humidity	– 5 ~ 85%
Software	– Application: Samsung Master, Samsung Converter, Adobe Reader

## × MP3 Specification

Audio	– Frequency: 20Hz ~ 20KHz – Earphone Port: 20Pin Port (Stereo Type) – Output: Maximum Volume Left 40mW + Right 40mW (16Ω) – Noise Ratio: 88 dB with 20 KHz LPF
-------	---

---

File	– File Format: MP3 (MPEG-1/2/2.5 Layer 3) – Bit Rate: 48 ~ 320kbps (Including VBR)
Sound Effect	– SRS, Normal, Classic, Dance, Jazz, Live, Rock
Play Mode	– All, Repeat One, Repeat All, Random, Random Repeat – Skipping in Play, Auto Skipping – Slide Show On/Off (User Selectable) – MP3&Capturing (Capturing Mode is Auto Default, 3M) – Auto reload function (Remember both the last played file and frame) – Background skin of MP3 playback using user images

---

## × PMP Specification

PMP Decoder	– Movie: Modified Xvid MPEG4 (Other video files have to use Samsung Converter S/W) – Audio: MPEG Layer 2 (Samsung Convert S/W)
Play Mode	– Fast Forward/Rewind(Max 32x) – Seeking in Play, Skipping in Play (Normal, 30sec, 1min, 3min, 5min, 10min) – Auto skipping after one file played – Auto reload function (Remember last played frame) – Support Full Screen in Converting S/W
Subtitle	– Support SMI file (Using Samsung Converter S/W)

---



# Specifications

---

## × Text Specification

File	– TXT extension name, up to 99999 pages
File format	– Window: ANSI (Windows 98 or later), Unicode / Unicode (Big-Endian) / UTF-8 (Windows 2000/XP) – Mac: ANSI, Unicode (UTF-16)
Function	– Auto Scroll (0.8 sec ~ 2.3 sec) – Skipping by 1 page / 10 pages – Auto reload function (Remember last page) – Support MP3 BGM during displaying text file
Language	– English, Korean, French, German, Spanish, Italian, Chinese, Taiwanese, Japanese, Russian, Portuguese, Dutch, Danish, Swedish, Finnish, Bahasa, Polish, Hungarian, Czech, Turkish. * Supportable language is subject to change without prior notice.

---

× Specifications are subject to change without prior notice.

× All trademarks are the property of their respective owners.

# Software notes

---

Please ensure that you read the instruction manual carefully before use.

- The attached software is a camera driver and image editing software tool for Windows.
- Under no circumstances should all or part of either the software or the user manual be reproduced.
- Copyrights for software are licensed only for use with a camera.
- In the unlikely event of a manufacturing fault, we will repair or exchange your camera. We cannot, however, be held responsible in any way for damage caused by inappropriate use.
- Using a Hand-made PC or a PC and OS that has not been guaranteed by the manufacturer is not covered by the Samsung warranty.
- Before reading this manual, you should have a basic knowledge of computers and O/S (Operating Systems).

# System requirements

For Windows	For Macintosh
PC with processor better than Pentium 450MHz (Pentium 800MHz recommended) * Samsung Converter PC with processor better than Pentium 500MHz (Pentium IV recommended)	Power Mac G3 or later, or Intel Processor
Windows 98SE / 2000 / ME / XP/Vista * Samsung Converter Windows 2000 or later recommended	Mac OS 10.1 ~ 10.4
Minimum 128MB RAM (Over 512MB recommended)	Minimum 256MB RAM 110MB of available hard-disk space
USB port	USB port
CD-ROM drive	CD-ROM drive
1024x768 pixels, 16-bit colour display compatible monitor (24-bit colour display recommended) Microsoft DirectX 9.0 or later	MPlayer (For movie clip)

# About the software

After inserting the CD-ROM provided with this camera into the CD-ROM drive, the following window should automatically display.

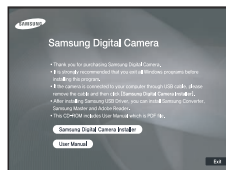

Before connecting the camera to the PC, you should first install the camera driver.

- Camera driver:** This enables images to transfer between the camera and PC.  
  
 This camera uses the USB Storage Driver as the camera driver. You can use the camera as a USB card reader. After installing the driver and connecting this camera to the PC, you can find [Removable Disk] in [Windows Explorer] or [My computer]. A USB Storage Driver is provided only for Windows. A USB Driver for MAC is not included with the Application CD. You can use the camera with Mac OS 10.1~10.4.
- XviD codec:** This makes movie clips (MPEG-4) recorded with this camera play back on a PC.  
  
 To play back a movie clip recorded with this camera, you must install the XviD codec. If a movie clip recorded with this camera does not play well, install this codec. This software is only compatible with Windows.

## About the software

### ■ Samsung Converter: Multimedia converting program

Multimedia (Movie, Video clip, etc) files can be converted into movie clips that can be played back on this camera. This software is only compatible with Windows.

### ■ Samsung Master: This is the all-in-one multi media software solution.

You can download, view, edit and save your digital images and movie clips with this software. This software is only compatible with Windows.



- Be sure to check the system requirements before installing the driver.
- You should allow 5 ~ 10 seconds for running the automatic setup program according to the capability of your computer. If the frame does not appear, run the [Windows Explorer] and select [Installer.exe] in the CD-ROM Drive root directory.

## Setting up the application software

To use this camera with a PC, install the application software first.

After this has been done, the stored images in the camera can be moved to the PC and can be edited by an image editing program.

### ■ You can visit the Saung web-site through the internet.

<http://www.samsungcamera.com>: English

<http://www.samsungcamera.co.kr>: Korean

#### 1. The auto run frame will display.

Click the [Samsung Digital Camera Installer] menu in the Auto run frame.

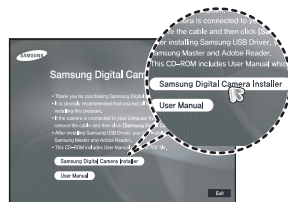

#### 2. Install the camera driver, DirectX, XviD, Samsung Converter, Samsung Master and Adobe Reader by selecting a button shown on the monitor.

If a latest version of DirectX was installed on your computer, DirectX may not be installed.

# Setting up the application software

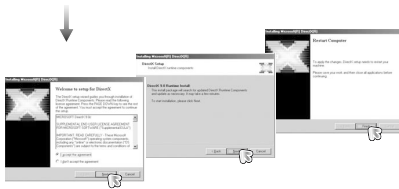

3. To play back the movie clip recorded with this camera on the computer, install the XviD codec.



- × The XviD codec is distributed according to the GNU General Public License and everyone can copy, distribute and change this codec. This License applies to any program or other work which contains a notice placed by the copyright holder saying it may be distributed under the terms of this General Public License. For more information, see the License documents (<http://www.gnu.org/copyleft/gpl.html>).



# Setting up the application software

- After restarting the computer, connect the PC to the camera with the USB cable.
- Turn the camera power on. The [Found New Hardware Wizard] will open and the computer will recognise the camera.
  - × If your OS is Windows XP/ Vista, an image viewer program will open. If the download window of Samsung Master opens after starting Samsung Master, the camera driver was set up successfully.

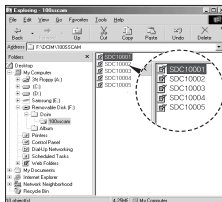

- If you have installed the camera driver, the [Found New Hardware Wizard] may not open.
- On a Windows 98SE system, the Found New Hardware Wizard dialog box opens and a window asking you to select a driver file may appear. In this case, specify "USB Driver" in the CD supplied.
- PDF documents of the user manual are included in the Software CD-ROM supplied with this camera. Search the PDF files with Windows explorer. Before opening the PDF files, you must install the Adobe Reader included in the Software CD-ROM.
- To install the Adobe Reader 6.0.1 correctly, Internet Explorer 5.01 or later has to be installed. Visit "[www.microsoft.com](http://www.microsoft.com)" and upgrade the Internet Explorer.

# Starting PC mode

If you connect the USB cable to a USB port on your PC and then turn on the power, the camera will automatically switch to “computer connection mode”. In this mode, you can download stored images to your PC through the USB cable.

## ■ Camera settings for connection

1. Turn on the camera
2. Connect the camera and computer with the supplied USB cable.
3. Turn on the computer. The camera and computer are connected.
4. External device selection menu will display on the LCD monitor.
5. Select the [Computer] by pressing the **Up/Down** button and press the **OK** button.



## ■ Connecting the camera to a PC

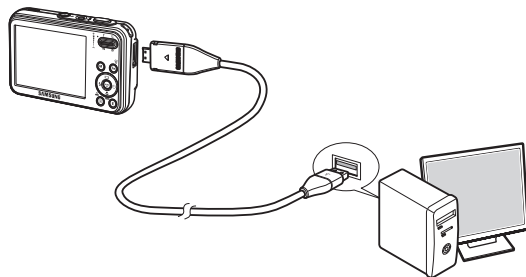

- × If you selected [Printer] in Step 5, when you connect the camera to your computer, the [Connecting Printer] message will be displayed and the connection will not be established. In this case, disconnect the USB cable, and then follow the procedure from Step 2 and onward.

## ■ Disconnecting the camera and PC

Refer to page 124-125 (Removing the removable disk).





## Starting PC mode

- By using [Samsung Master], you can see the stored images in the memory directly on the PC monitor and you can copy or move the image files.



- We recommend that you should copy the images to the PC to view them. Opening images directly from the removable disk may be subject to unexpected disconnection.
- When you upload a file that is not taken by this camera to the Removable Disk, the [File Error!] message will be displayed on the LCD monitor in the Play mode, and nothing is displayed in THUMBNAIL mode.

## Removing the removable disk

### ■ Windows 98SE

1. Check whether the camera and PC are transferring a file. If the camera status lamp blinks, please wait until the lamp has finished blinking and is constantly on.
2. Unplug the USB cable.

### ■ Windows 2000/ME/XP/Vista

(The illustrations may differ from those shown depending on the Windows O/S.)

1. Check whether the camera and PC are transferring a file. If the camera status lamp blinks, please wait until the lamp has finished blinking and is constantly on.
2. Double-click the [Unplug or Eject Hardware] icon on the task bar.



Double-click!

3. The [Unplug or Eject Hardware] window will open. Select the [USB Mass Storage Device] and click the [Stop] button.

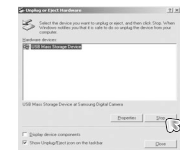

4. The [Stop a Hardware device] window will open. Select the [USB Mass Storage Device] and click the [OK] button.



## Removing the removable disk

---

5. A [Safe to Remove Hardware] window will open. Click the [OK] button.
6. An [Unplug or Eject Hardware] window will open. Click the [Close] button and the removable disk will be removed safely.
7. Unplug the USB cable.



## Setting up the USB Driver for MAC

---

1. A USB Driver for MAC is not included with the software CD as MAC OS supports the camera driver.
2. Check the MAC OS version during start-up. This camera is compatible with MAC OS 10.1 ~ 10.4.
3. Connect the camera to the Macintosh and turn the camera power on.
4. A new icon will be displayed on the desktop after connecting the camera to the MAC.

## Using the USB Driver for MAC

---

1. Double click a new icon on the desktop and the folder in the memory will be displayed.
2. Select an image file and copy or move it to MAC.



- For Mac OS 10.1 or later: First complete uploading from computer to camera and then remove the removable disk with the Extract command.

# Removing the USB Driver for Windows 98SE

To remove the USB driver, refer to the process shown below.

1. Connect the camera to your PC and turn them both on.
2. Check whether the Removable Disk is on the [My Computer].
3. Remove the [Samsung Digital Camera] on the Device manager.

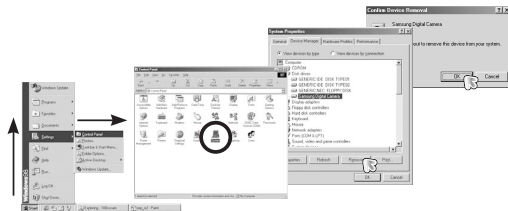

4. Disconnect the USB cable.
5. Remove the [Samsung USB Driver] on the Add/Remove Programs Properties.



6. Uninstallation is complete.

# Samsung Converter

Multimedia (Movie, Video clip, etc) files can be converted into movie clips that can be played back on this camera. This software is only compatible with Windows.

## ■ How to use the Samsung Converter

1. Double click the Samsung Converter icon on the desktop.
2. Click the Add icon and select a file that you want to add.
3. If you want to add a caption, check [Use subtitles from file (\*.smi)].
4. Select settings that you want and click the [Convert] button.
  - [Output format]: You can set the output format.
  - [Frame size]: You can set the width and height of output movie clip.
  - [Frame rate]: You can set fps (Frame Per Second).
  - [Screen size]: You can set type of display.
  - [Split by size]: You can set the file size of output movie clip.
5. Connect the camera to the computer with the supplied USB cable.
6. Copy the converted movie clip in the destination folder and paste the file in the [PMP] folder.

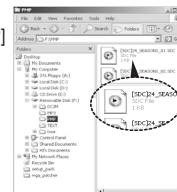
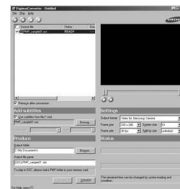

# Samsung Converter

7. You can play back the converted movie clip in the Play mode of the camera.
  - ✗ Refer to the [Help] menu in Samsung Converter for further information.



- Before converting a multimedia file, check whether it plays back correctly on the Windows Media Player.
- The converted files are saved as \*.sdc file type that can be played back on the Windows Media Player.
- The Samsung Converter doesn't cover every kind of codec. If a multimedia file can't play back on the Windows Media Player, install a multicodec (We recommend Full version of latest K-Lite Codec). Install the Samsung Converter again after installing the multi-codec.
- You can select a destination folder for each converted file. When the folder is not selected, the converted files are saved on a folder where the source file is.
- If you convert several files at the same time, the computer may be running slow because of the CPU capacity. In this case, add the files in the program one by one.



- Computer specification, installed code and programs are the main causes of converting error. When a converting error happens, please check the following.
  - Any codecs compatible with the files were not installed or installed incorrectly. In this case, find a compatible codec and install it. If you do not find any compatible codecs, install a multi-codec.
  - If you installed various multi-codecs on your computer, it may cause converting problems. In this case, remove all codecs and install a proper multi-codec.
  - Install a latest Windows Media Player.
  - Visit device (PC, Graphic card, Sound card) manufacturer web-site and upgrade them with the latest version.
- Some kinds of multimedia files are not converted. If the converted media files are damaged, they may not play back on the camera. Unusual type of files may not be converted. The sound and scenes may not synchronise.
- The expected file sizes after converting a media file may vary. It depends on the computer system you use.
- If there is no font that is compatible with the script file on your PC, the script is shown as '□□□'.
- Transferring the converted file to a removable disk is time consuming. It may take a long time. The duration depends on the file size.
- Do not use the PMP mode while driving. It may create a traffic hazard.
- A file that does not support fast search on the Windows Media Player can't select converting range and divide file size.

# Samsung Master

You can download, view, edit and save your images and movies with this software. This software is only compatible with Windows. To run the Samsung Master, double click the Samsung Master icon on the desktop.

## ■ Downloading images

1. Connect the camera to your PC.

2. A window for downloading images will display after connecting the camera to your PC.

- To download the captured images, select the [Select All] button.
- Select desired folder in the window and click the [Select All] button. You can save captured images and selected folder.
- If you click the [Cancel] button, downloading will be cancelled.

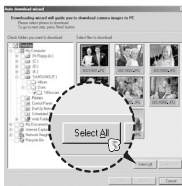

3. Click [Next >] button.

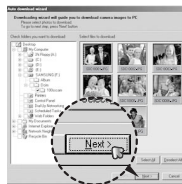

4. Select a destination and make a new folder in which to save downloaded images and folders.

- Folder names can be made in order of date and images will be downloaded.
- Folder name will be made as you want and images will be downloaded.
- After selecting a folder that was made before, images will be downloaded.

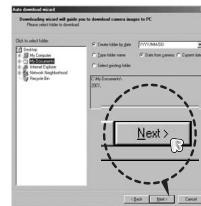

5. Click [Next >] button.

6. A window will open as shown alongside. The destination of the selected folder will be displayed on the upper side of the window. Click the [Start] button to download the images.

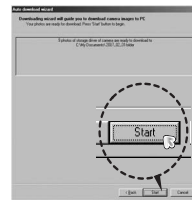

7. Downloaded images will be displayed.



# Samsung Master

- Image viewer: You can view the stored images.

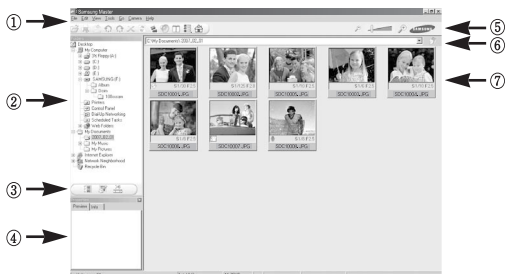

- Image viewer functions are listed below.

- ① Menu bar: You can select menus. File, Edit, View, Tools, Change functions, Auto download, help, etc.
  - ② Image selection window: You can select the desired images in this window.
  - ③ Media type selection menu: You can select image viewer, image edit and movie edit functions in this menu.
  - ④ Preview window: You can preview an image or a movie clip and check the multi media information.
  - ⑤ Zoom bar: You can change preview size.
  - ⑥ Folder display window: You can see the folder location of the selected image.
  - ⑦ Image display window: Images of the selected folder are displayed.
- × Refer to the [Help] menu in Samsung Master for further information.

- Image edit: You can edit the still image.

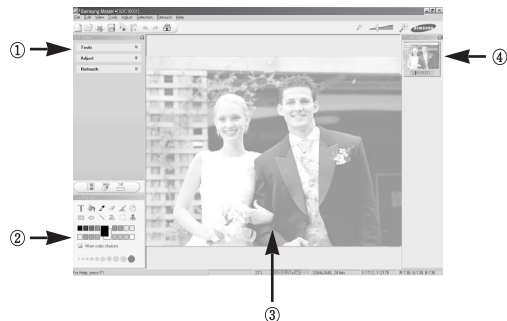

- Image edit functions are listed below.

- ① Edit menu: You can select the following menus.
    - [Tools]: You can resize or crop the selected image. See the [Help] menu.
    - [Adjust]: You can modify image quality. See the [Help] menu.
    - [Retouch]: You can change image or insert effects on the image. See the [Help] menu.
  - ② Drawing tools: Tools for editing an image.
  - ③ Image display window: A selected image is displayed in this window.
  - ④ Preview window: You can preview the changed image.
- × A still image edited with Samsung Master can't be played back on the camera.
- × Refer to the [Help] menu in Samsung Master for further information.

# Samsung Master

- **Movie edit:** You can get the still image, movie clip, narration, music files together in a movie clip.



- ② **Frame display window:** You can insert multi media in this window.
- × Some movie clips that were compressed with a codec that is not compatible with the Samsung Master can't play back in the Samsung Master.
- × Refer to the [Help] menu in Samsung Master for further information.

– Movie clip edit functions are listed below.

- ① **Edit menu:** You can select the following menus.
  - [Add Media]: You can add other media elements to a movie.
  - [Edit Clip]: You can change the brightness, contrast, colour and saturation.
  - [Effects]: You can insert an effect.
  - [Set Text]: You can insert texts.
  - [Narrate]: You can insert a narration.
  - [Produce]: You can save the edited multi media as a new file name.
    - You can select AVI, Windows media (wmv) and Windows media (asf) file types.

# FAQ

---

Please check the following if the USB connection malfunctions.

## Case 1

USB cable is not connected or it is not the supplied USB cable.

- Connect the supplied USB cable.

## Case 2

The camera is not recognised by your PC.

Sometimes, the camera may appear under [Unknown Devices] in Device Manager.

- Install the camera driver correctly. Turn off the camera, remove the USB cable, plug in the USB cable again, and then turn on the camera.

## Case 3

There is an unexpected error during file transfer.

- Turn the camera power off and on again. Transfer the file again.

## Case 4

When using the USB hub.

- There may be a problem in connecting the camera to the PC through the USB hub if the PC and the hub are not compatible. Wherever possible, connect the camera to the PC directly.

## Case 5

Are other USB cables connected to the PC?

- The camera may malfunction when it is connected to the PC at the same time as another USB cable. In this case, disconnect the other USB cable, and connect only one USB cable to the camera.

## Case 6

When I open the Device Manager (by clicking Start → (Settings) → Control Panel → (Performance and Maintenance) → System → (Hardware) → Device Manager), there are Unknown Devices or Other Devices entries with a yellow question mark(?) beside them or devices with an exclamation mark(!) beside them.

- Right-click on the entry with the question (?) or exclamation (!) mark and select "Remove". Restart the PC and connect the camera again. For Windows 98SE PC, remove the camera driver also, restart the PC, and then reinstall the camera driver.

## Case 7

In some security programs (Norton Anti Virus, V3, etc.), the computer may not recognise the camera as a removable disk.

- Stop the security programs and connect the camera to the computer. Refer to the security program instructions about how to temporarily disable the program.

## Case 8

The camera is connected to the USB port located on the front of the computer.

- When the camera is connected to the USB port located on the front of the computer, the computer may not recognise the camera. Connect the camera to the USB port located on the back of the computer.



# FAQ

---

## When the movie clip doesn't play back on the PC

- × When the movie clip recorded by the camera doesn't play back on the PC, the causes are mostly due to the codec installed on the PC.

## ■ When codec for play back the movie clip isn't installed

→ Install the codec as listed below.

### [Installing codec for Windows]

→ Installing the XviD codec

- 1) Insert the CD provided with the camera.
  - 2) Run the windows explorer and select [CD-ROM drive:\XviD] folder and click the XviD-1.1.2-01112006.exe file.
- × The XviD codec is distributed according to the GNU General Public License and everyone can copy, distribute and change this codec. This License applies to any program or other work which contains a notice placed by the copyright holder saying it may be distributed under the terms of this General Public License. For more information, see the License documents (<http://www.gnu.org/copyleft/gpl.html>).

### [Installing codec for Mac OS]

- 1) Visit the following site for downloading the codec. (<http://www.divx.com/divx/mac>)
  - 2) Click the [Free Download] menu on the top right side of the window then download windows appears.
  - 3) Check the version of Mac OS and click the [Download] button to download the file and save it to a desired folder.
  - 4) Run the downloaded file and the codec for playing back the movie clip will be installed.
- × If the movie file is not played back on the Macintosh OS, use a media player that supports Xvid codec (e.g: Mplayer).

## ■ When the DirectX 9.0 or later is not installed

→ Install the DirectX 9.0 or later

- 1) Insert the CD provided with the camera
- 2) Run the windows explorer and select the [CD-ROM drive:\ USB Driver\DirectX 9.0] folder and click the DXSETUP.exe file. The DirectX will be installed. Visit the following site for downloading the DirectX.<http://www.microsoft.com/directx>

## ■ If a PC (Windows 98SE) stops responding while the camera and PC are connected repeatedly

→ If a PC (Windows 98SE) is turned on for a long time and the camera is connected repeatedly, the PC may not recognise the camera. In this case, re-start the PC.

## FAQ

---

- If a PC connected with the camera stops responding while Windows is starting.
  - In this case, disconnect the PC and the camera and Windows will start. If the problem happens continuously, set the Legacy USB Support to disable and re-start the PC. The Legacy USB Support is in the BIOS setup menu. (The BIOS setup menu differs from the PC manufacturers and some BIOS menus don't have Legacy USB Support) If you can't change the menu by yourself, contact to the PC manufacturer or BIOS manufacturer.
- If the movie clip can't be deleted, or the removable disk can't be extracted or an error message displays during the file transfer.
  - If you install only the Samsung Master, the problems mentioned above occasionally happen.
    - Close the Samsung Master program by clicking the [Samsung Master] icon on the Taskbar.
    - Install all the application programs included in the software CD.

## Correct Disposal of This Product

---



### Correct Disposal of This Product (Waste Electrical & Electronic Equipment)

(Applicable in the European Union and other European countries with separate collection systems) This marking shown on the product or its literature, indicates that it should not be disposed of with other household wastes at the end of its working life.

To prevent possible harm to the environment or human health from uncontrolled waste disposal, please separate this from other types of wastes and recycle it responsibly to promote the sustainable reuse of material resources. Household users should contact either the retailer where they purchased this product, or their local government office, for details of where and how they can take this item for environmentally safe recycling. Business users should contact their supplier and check the terms and conditions of the purchase contract. This product should not be mixed with other commercial wastes for disposal.



Samsung Techwin cares for the environment at all product manufacturing stages to preserve the environment, and is taking a number of steps to provide customers with more environment-friendly products. The Eco mark represents Samsung Techwin's will to create environment-friendly products, and indicates that the product satisfies the EU RoHS Directive.

# FCC notice

---

## ■ NOTE:

This equipment has been tested and found to comply with the limits for a Class B digital device, pursuant to part 15 of the FCC Rules. These limits are designed to provide reasonable protection against harmful interference in a residential installation.

This equipment generates, uses and can radiate radio frequency energy and, if not installed and used in accordance with the instructions, may cause harmful interference to radio communications. However, there is no guarantee that interference will not occur in a particular installation. If this equipment does cause harmful interference to radio or television reception, which can be determined by turning the equipment off and on, the user is encouraged to try to correct the interference by one or more of the following measures:

- Reorient or relocate the receiving antenna.
- Increase the distance between the equipment and receiver.
- Connect the equipment into an outlet on a circuit different from that to which the receiver is connected.
- Consult the dealer or an experienced radio / TV technician for help.

## ■ CAUTION:

Changes or modifications not expressly approved by the manufacturer responsible for compliance could void the user's authority to operate the equipment.

## ■ Declaration of Conformity

Trade Name: SAMSUNG TECHWIN

Model No.: Samsung i8

Responsible Party: Samsung Opto-Electronics America, INC.

Address: 40 Seaview Dr. Secaucus, NJ 07094

Telephone No.: 201-902-0347

This device complies with Part 15 of the FCC Rules. Operation is subject to the following two conditions: (1) This device may not cause harmful interference, and (2) this device must accept any interference received, including interference that may cause undesired operation.



Please refer to the warranty that came with the product you purchased,  
or go to our website <http://www.samsungcamera.com/> for after-sales service or inquiries.

Internet address - <http://www.samsungcamera.com>



The CE Mark is a Directive conformity  
mark of the European Community (EC)