

The Samsung logo is located in the top left corner, consisting of the word "SAMSUNG" in a bold, sans-serif font inside a white oval shape.

SAMSUNG

User Manual

NV24HD

Thank you for buying a Samsung Camera.
This manual will guide you through using the camera, including capturing images, downloading images and using the application software.
Please read this manual carefully before using your new camera.



ENGLISH

Instructions

Use this camera in the following order.

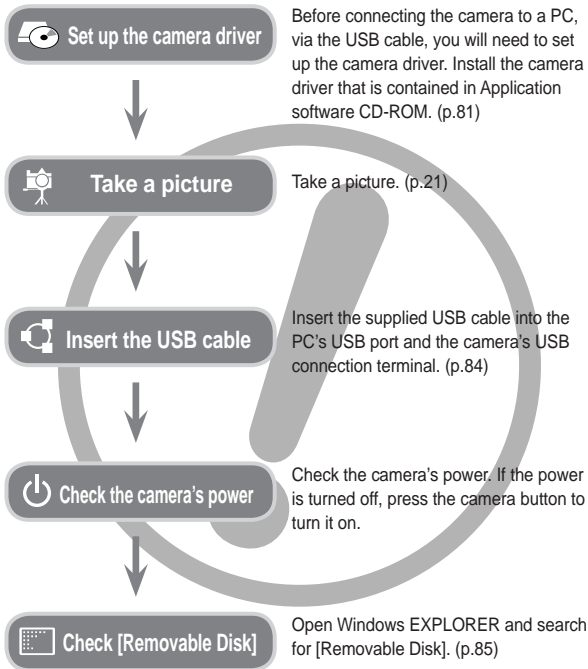

Getting to Know your camera

Thank you for buying a Samsung Digital Camera.

- Prior to using this camera, please read the user manual thoroughly.
- When you require After Sales service, please bring the camera and the cause of the camera malfunction (such as battery, Memory card etc.) to the A/S centre.
- Please check that the camera is operating properly before you intend to use it (e.g. for a trip or an important event) to avoid disappointment. Samsung takes no responsibility for any loss or damage that may result from camera malfunction.
- Keep this manual in a safe place.
- If you use a card reader to copy the images on the memory card to your PC, the images could be damaged. When transferring the images taken with the camera to your PC, be sure to use the supplied USB cable to connect the camera to your PC. Please note that the manufacturer accepts no responsibility for loss or damage of images on the memory card due to the use of a card reader.
- The contents and illustrations of this manual are subject to change without prior notice for upgrading the camera functions.

* Microsoft, Windows and Windows logo are registered trademarks of Microsoft Corporation incorporated in the United States and/or other countries.

* HDMI, HDMI logo, and High-Definition Multimedia Interface are registered trademarks of HDMI Licensing LLC.

* Apple, Mac and QuickTime logo are registered trademarks of Apple computer.

* All brand and product names appearing in this manual are registered trademarks of their respective companies.

Danger

DANGER indicates an imminently hazardous situation which, if not avoided, will result in death or serious injury.

- Do not attempt to modify this camera in any way. To do so may result in fire, injury, electric shock or severe damage to you or your camera. Internal inspection, maintenance and repairs should only be carried out by your dealer or Samsung Camera Service centre.
- Please do not use this product in close proximity to flammable or explosive gases, as this could increase the risk of explosion.
- Should any form of liquid or a foreign object enter the camera, do not use it. Switch off the camera, and then disconnect the power source. You must contact your dealer or Samsung Camera Service centre. Do not continue to use the camera as this may cause a fire or electric shock.
- Do not insert or drop metallic or inflammable foreign objects into the camera through access points e.g. the memory card slot and battery chamber. This may cause a fire or electric shock.
- Do not operate this camera with wet hands. This could pose a risk of electric shock.

Warning

WARNING indicates a potentially hazardous situation which, if not avoided, could result in death or serious injury.

- Do not use the flash in close proximity to people or animals. Positioning the flash too close to your subject's eyes may cause eyesight damage.
- For safety reasons keep this product and accessories out of reach of children or animals to prevent accidents e.g.:
 - Swallowing battery or small camera accessories. If an accident should occur, please consult a doctor immediately.
 - There is the possibility of injury from the camera's moving parts.
- Battery and camera may become hot during prolonged use and it may result in camera malfunction. Should this be the case, let the camera sit idle for a few minutes to allow it time to cool.
- Do not leave this camera in places subject to extremely high temperatures, such as a sealed vehicle, direct sunlight or other places of extreme variances in temperature. Exposure to extreme temperatures may adversely affect the camera's internal components and could cause a fire.
- When in use, do not cover the camera or Charger. This may cause heat to build up and distort the camera body or cause a fire. Always use the camera and its accessories in a well-ventilated area.

Caution

CAUTION indicates a potentially hazardous situation which, if not avoided, may result in a minor or moderate injury.

- Leaking, overheating, or damaged battery could result in fire or injury.
 - Use battery with the correct specification for the camera.
 - Do not short circuit, heat or dispose of battery in fire.
 - Do not insert the battery with the polarities reversed.
- Remove the battery when not planning to use the camera for a long period of time. Otherwise the battery may leak corrosive electrolyte and permanently damage the camera's components.
- Do not fire the flash while it is in contact with hands or objects. Do not touch the flash after using it continuously. It may cause burns.
- Do not move the camera while it is switched on when you are using the AC Charger. After use, always switch off the camera before unplugging the cable from the wall socket. Then make sure that any connector cords or cables to other devices are disconnected before moving the camera. Failure to do so may damage the cords or cables and cause a fire or electric shock.
- Take care not to touch the lens or lens cover to avoid taking an unclear image and possibly causing camera malfunction.
- Avoid obstructing the lens or the flash when you capture an image.
- Before inserting any cables or AC adapter, check the directions and do not insert by force. It may cause breakage of cable or camera.
- Credit cards may be demagnetized if left near a camera case. Avoid leaving magnetic strip cards near the case.
- It is highly likely to result in computer malfunctions when the 30 pin connector is connected to the USB port of a PC. Never connect the 30 pin connector to USB port of a PC.

Contents

READY

- 07 System chart**
 - 07 Included items
 - 07 Optional items
- 08 Identification of features**
 - 08 Front & Top
 - 09 Rear
 - 10 Bottom
 - 10 Cradle (Optional)
- 12 Connecting to a Power Source**
- 15 Inserting the Battery**
- 15 Inserting the memory card**
- 16 Instructions on using the memory card**

RECORDING

- 18 When Using the Camera for the First Time : Smart button**
- 19 When Using the Camera for the First Time : Setting up the Date / Time and Language**
- 20 AMOLED monitor indicator**
- 21 Starting the recording mode**
 - 21 How to use the AUTO mode
 - 21 How to use the PROGRAM mode
 - 22 How to use the MANUAL mode
 - 22 How to use the DUAL IS (Dual Image Stabilization) mode
 - 23 Night, Portrait scene mode
 - 23 How to use the SCENE mode





Contents

- 24 How to use the MOVIE mode
- 24 Recording the HD (High Definition) movie clips
- 25 Recording the movie clip without sound
- 25 Pausing while recording a movie clip (Successive Recording)
- 25 Using Photo Style Selector Mode
- 26 Things to Watch Out for When Taking Pictures**
- 27 Using the camera buttons to set the camera**
 - 27 POWER button
 - 27 SHUTTER button
 - 27 OIS (Optical Image Stabilization) button
 - 28 ZOOM W / T button
- 30 Using the AMOLED monitor to set the camera**
- 31 Selecting focus type**
- 32 Flash**
- 33 Size**
- 34 Focus Area**
- 36 Continuous shot**
- 36 Metering**
- 37 Image Adjust**
 - 37 Sharpness
 - 37 Saturation control
 - 37 Contrast
- 38 Effect**
- 38 Quality / Frame rate**
- 39 Self-timer / Remote control**
- 40 Voice recording / Voice memo**
- 41 White balance**
- 42 ISO**
- 42 Exposure compensation**
- 43 ACB (Auto Contrast Balance)**
- 43 Shutter Speed**
- 43 Aperture Value**
- 44 Scene menu**
- PLAY**
- 45 Starting play mode**
 - 45 Playing back a still image
 - 45 Playing back a movie clip
 - 46 Movie clip capture function
 - 46 On camera movie trimming
 - 46 Playing back a recorded voice
 - 46 Playing back a recorded voice memo
- 47 AMOLED monitor indicator**
- 48 Using the camera buttons to adjust the camera**
 - 48 Play mode button
 - 48 BACK button
- 48 Using the remote control in play mode**

Contents

- 49** Thumbnail/Enlargement button
- 50 Playing Images
- 51** Starting the slide show
- 52** Protecting images
- 52** Deleting images
- 53** DPOF
- 53** DPOF : IMAGES
- 54** DPOF : Print size
- 54** DPOF : Index
- 55** Rotating an image
- 55** Resize
- 56** Effect
- 57** Special Colour
- 57 Colour Filter
- 57 Shaded
- 57 Elegant
- 57 Noise effect
- 58** Image Adjust
- 58 Red eye removal
- 58 ACB
- 58 Brightness control
- 58 Contrast control
- 59 Saturation control
- 59** Anynet+(CEC)
- 60** PictBridge

SETUP

- 62** Setup menu
- 64** Setup menu ()
- 64 OSD set
- 64 Display Bright
- 64 HDMI Size
- 65 Start up image
- 65** Setup menu ()
- 65 Sound Volume
- 65 Operation Sound
- 66 Shutter sound
- 66 Start up sound
- 66 AF sound
- 66** Setup menu ()
- 66 File name
- 67 Self Portrait
- 67 Auto Focus lamp
- 67 Quick view
- 68 Imprinting the recording date
- 68** Setup menu ()
- 68 Copy To Card
- 69 Delete All
- 69 Formatting a memory
- 70** Setup menu ()
- 70 Language
- 70 Setting up the Date / Time / Date type
- 71 Initialisation
- 71 Selecting Video out type
- 72 Auto power off
- 73** Important notes

Contents

- 74 **Warning indicator**
- 75 **Before contacting a service centre**
- 77 **Specifications**

SOFTWARE

- 80 **Software Notes**
 - 80 System Requirements
 - 80 QuickTime Player 7.4 : H.264(MPEG4.AVC)
playback Requirements
- 81 **About the software**
- 82 **Setting up the application software**
- 84 **Starting PC mode**
- 85 **Using Removable Disk**
- 86 **Removing the removable disk**
- 87 **Setting up the USB Driver for MAC**
- 87 **Using the USB Driver for MAC**
- 87 **Removing the USB Driver for
Windows 98SE**
- 88 **Samsung Master**
- 91 **FAQ**
- 93 **Correct Disposal of This Product**
- 93 **FCC notice**

System chart

Please check that you have the correct contents before using this product. The contents can vary depending on the sales region. To buy the optional equipment, contact your nearest Samsung dealer or Samsung service centre.

Included items



Camera



User manual,
Product warranty



Software CD



Rechargeable battery
(SLB-1137D)



Camera strap



AC adapter (SAC-47) /
USB cable (SUC-C4)



AV cable

Optional items

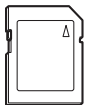

SD/SDHC/MMC
memory card

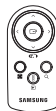

Remote control

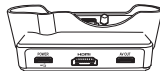

Cradle (SCC-NV4HD)

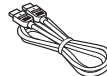

HDMI cable

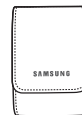

Camera case

Identification of features

Front & Top

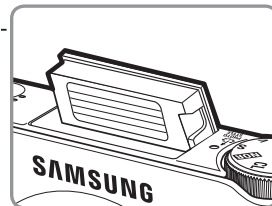
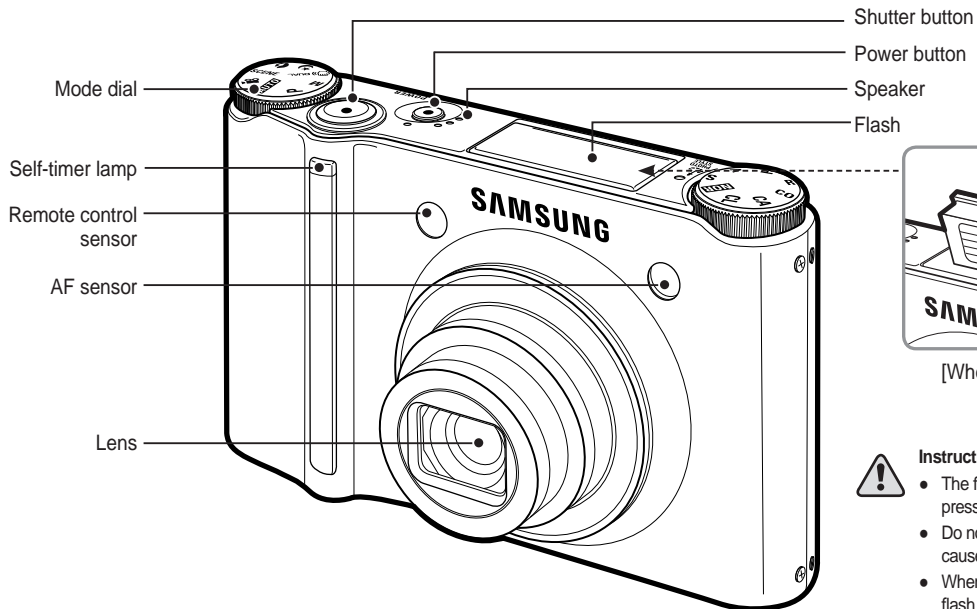

[When Using the flash]



Instructions for the Built-in flash

- The flash opens automatically when you press the shutter button down half way.
- Do not open the flash by force. It may cause breakage of camera.
- When you don't use the flash, close the flash to prevent breakage.

Identification of features

Rear

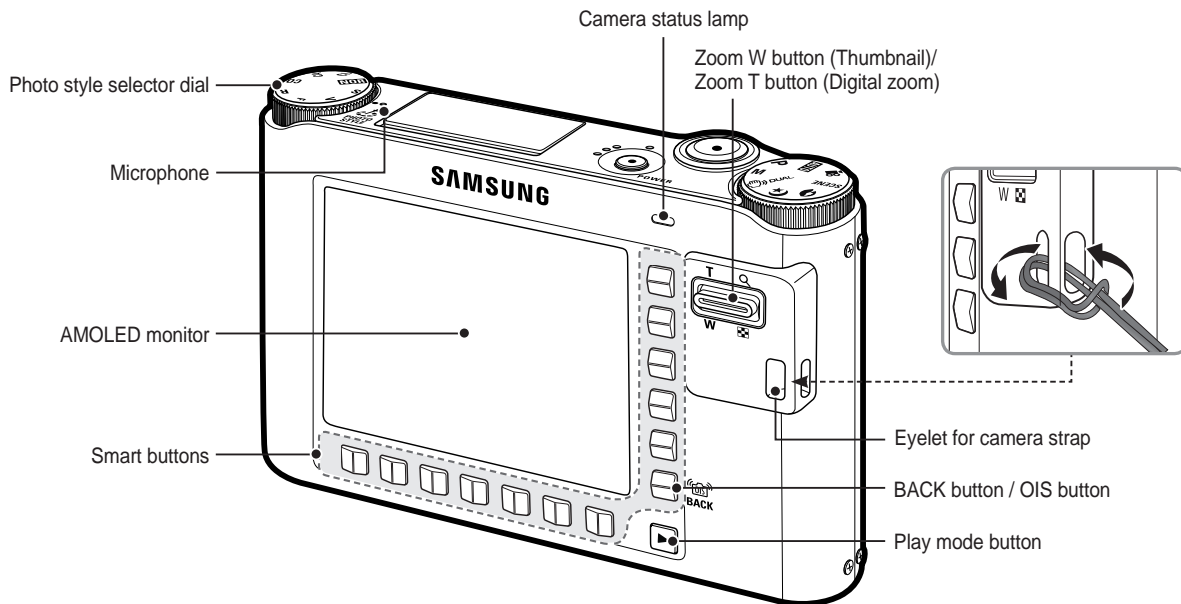

Identification of features

Bottom

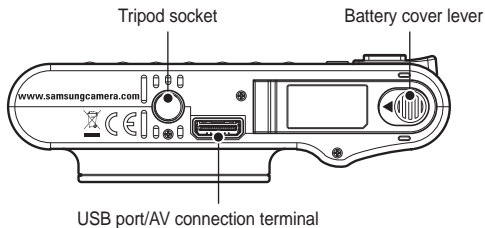

To open the battery chamber cover, slide it in the direction shown above.

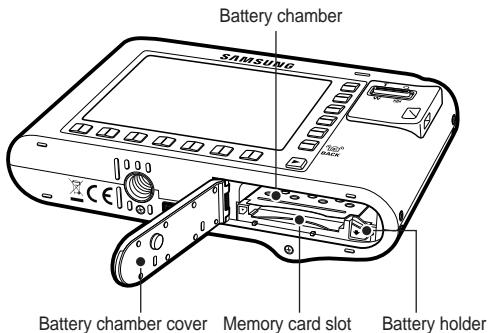



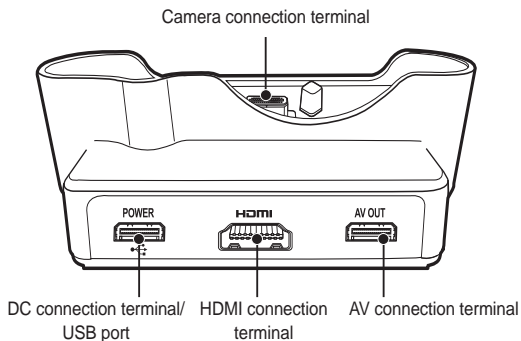

Cradle (Optional)

You can recharge your rechargeable battery, transfer a captured image to print, and download images with the cradle (optional).



Identification of features

■ Self-timer lamp









Icon	Status	Description
	Blinking	- For the first 7 seconds, the lamp blinks at 1 second intervals. - For the final 3 seconds, the lamp blinks quickly at 0.25-second intervals.
	Blinking	For 2 seconds, the lamp blinks quickly at 0.25-second intervals before taking a picture.
	Blinking	A picture will be taken after about 10 seconds and 2 seconds later a second picture will be taken.
	Blinking	Pressing the remote control shutter button will allow an interval of 2 seconds before the image is taken.















■ Camera Status Lamp

Status	Description
Power on	The lamp turns on and off when the camera is ready to take a picture.
After taking a picture	The lamp blinks while saving the image and then turns off when ready to take another picture.
When the USB cable is inserted to a PC	The lamp lights up (AMOLED monitor turns off after initializing the device)
Transmitting Data with a PC	The lamp turns on (AMOLED monitor turns off)
When the USB cable is connected to a printer	The lamp is off.

When the printer is printing	The lamp blinks.
When the AF activates	The lamp lights (The subject is in focus)
	The lamp blinks (The subject is not in focus)

■ Mode icon

	MODE			
Shooting mode	AUTO	PROGRAM	MANUAL	DUAL IS
				
	NIGHT	PORTRAIT	MOVIE	PLAYBACK
				

Scene mode	SMILE SHOT	BLINK DETECTION	CHILDREN
			
	LANDSCAPE	CLOSE UP	TEXT
			
	SUNSET	DAWN	BACKLIGHT
			
	FIREWORKS	BEACH&SNOW	SELF SHOT
			
	FOOD	CAFÉ	
			

Connecting to a Power Source

You should use the rechargeable battery (SLB-1137D) supplied with the camera. Be sure to charge the battery before using the camera.

■ SLB-1137D rechargeable battery specification

Model	SLB-1137D
Type	Lithium Ion
Capacity	1100mAh
Voltage	3.7V
Charging time (When the camera is turned off)	About 150 Min.

■ Number of images and battery life : Using the SLB-1137D

	Battery life / Number of images	Based on the following shooting conditions
Still image	Approx. 100 MIN / Approx. 200	Using the fully charged battery, Auto mode, 10M image size, Fine image quality, Shot to shot interval : 30Sec. Changing the zoom position between the Wide and the Tele after every shot. Using the flash on every second shot. Using the camera for 5 minutes and then Powering it off for 1 minute.

	Recording time	Based on the following shooting conditions
Movie	Approx. 90 MIN	Using the fully charged battery 640x480 image size 30fps frame rate

※ These figures are measured under Samsung's standard conditions and shooting conditions and may vary depending on the user's methods.

※ These figures are measured under OIS shooting condition.



Important information about battery usage.

- When the camera is not used, turn off the camera power.
- Please remove the battery if the camera will not be used for long periods. Batteries can lose power over time and are prone to leaking if kept inside the camera.
- Low temperatures (below 0°C) can affect the performance of the battery and you may experience reduced battery life.
- Battery will usually recover at normal temperatures.
- During extended use of the camera, the camera body may become warm. This is perfectly normal.

Connecting to a Power Source

You can charge the rechargeable battery (SLB-1137D) by using an SAC-47 KIT. The SAC-47 KIT consists of the AC adapter (SAC-47) and the USB cable (SUC-C4). When the AC adapter and the USB cable are assembled, it can be used as an AC cable.

- Using the SAC-47 as an AC charger

: Insert the AC adapter into the USB connector.

When the AC adapter is inserted, it can be used as an AC charger.

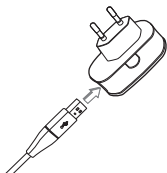

- Using the SAC-47 as an USB cable

: Remove the AC adapter from the USB cable (SUC-C4). You can transmit data with a PC (p.84) or charge the battery.

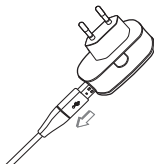

In the following cases, the battery may not be charged.

- When using a USB cable that was not supplied with this camera.
Use the supplied USB cable (SUC-C4).
- When using a USB hub. Connect the camera to the PC directly.
- When other USB devices are connected to the PC.
Disconnect the other USB devices.
- When the USB is connected to the USB port located on the front of the computer. Use the USB located on the back of the computer.
- If the USB port of the PC doesn't meet the Power output standard (4.2V, 400mA), the camera may not be charged.

Connecting to a Power Source

- You can charge the rechargeable battery (SLB-1137D) by using the cradle.
- How to charge the rechargeable battery (SLB-1137D)

When using the cradle

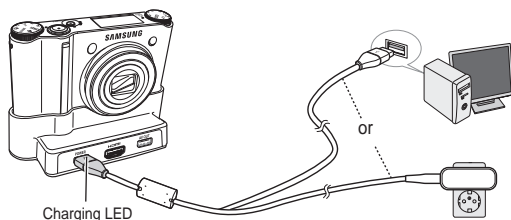

When the cradle is not used

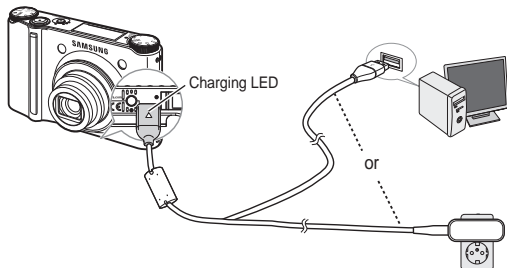

- Charging LED of the AC Adapter

	Charging LED
Being Charged	Red LED is on
Charging is complete	Green LED is on
Charging error	Red LED is off or blinking
Being discharged (Using the AC adapter)	Orange coloured LED is on



- Before inserting any cables or AC adapter, check the directions and do not insert by force. It may cause damage to the cable or camera.
- If the charging LED of the AC Charger does not turn on or blink after inserting the rechargeable battery, please check whether the battery is inserted correctly.
- If you charge the battery with the camera power on, the battery can't charge fully. Turn the camera off while charging the battery.
- If you insert the fully discharged battery to charge it, do not turn on the camera at the same time. The camera may not be turned on because of the low battery capacity. Charge the battery for more than 10 minutes before using the camera.
- Do not use the flash frequently or take a movie clip with a fully discharged battery that has only been charged for a short time.

Inserting the Battery

Insert the battery as shown

- If the camera does not turn on after you have inserted battery, please check whether the battery is inserted with the correct polarity (+ / -).
- Do not use force to open the battery chamber. This may damage the battery chamber cover.

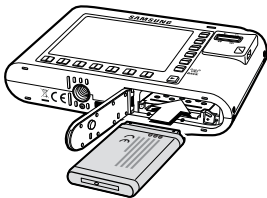



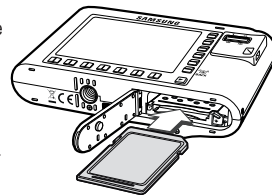

Inserting the memory card

Insert the memory card as shown.

- Turn off the camera's power before inserting the memory card.
- Have the front of the memory card facing toward the back of the camera (AMOLED monitor) and the card pins toward the front of the camera (Lens).
- Do not insert the memory card the wrong way round. Doing so may damage the memory card slot.



- There are 4 indicators for battery condition that are displayed on the AMOLED monitor.

Battery indicator				
Battery status	The battery is fully charged	Low battery capacity (Prepare to recharge or use spare battery)	Low battery capacity (Prepare to recharge or use spare battery)	Battery empty. (Recharge or use spare battery)

- ※ When using the camera and the battery in a place that is excessively cold or hot, the battery status on the AMOLED monitor may be different from the actual battery status.

Instructions on using the memory card

- Be sure to format the memory card (see p.69) if you are using a newly purchased memory card for the first time, if it contains data that the camera cannot recognise, or if it contains images captured with a different camera.
- Turn off the camera power whenever the memory card is being inserted or removed.
- Repeated use of the memory card will eventually reduce its performance. Should this be the case, you will need to purchase a new memory card. Wear and tear on the memory card is not covered by the Samsung warranty.
- The memory card is an electronic precision device.
Do not bend, drop or subject it to any heavy impact.
- Do not store the memory card in an environment with strong electronic or magnetic fields, e.g. near loudspeakers or TV receivers.
- Please do not use or store in an environment where there are extremes in temperature.
- Do not allow the memory card to become dirty or to come into contact with any liquid. Should this happen, clean the memory card with a soft cloth.
- Please keep the memory card in its case when not in use.
- During and after periods of extended use, you may notice that the memory card is warm. This is perfectly normal.
- Do not use a memory card that is used in another digital camera.
To use the memory card in this camera, format the memory card using this camera.
- Do not use a memory card formatted by another digital camera or memory card reader.
- If the memory card is subjected to any of the following, the recorded data may become corrupted :
 - When the memory card is used incorrectly.
 - If the power is switched off or the memory card is removed while recording, deleting (formatting) or reading.
- Samsung cannot be held responsible for lost data.
- It is advisable to copy important data onto other media as back-up e.g. floppy disks, hard disks, CD etc.
- If there is insufficient memory available
: A [Memory Full!] message will appear and the camera will not operate.
To optimise the amount of memory in the camera, replace the memory card or delete unnecessary images stored on the memory card.



- Don't remove the memory card when the camera status lamp is blinking as this may cause damage to data in the memory card.

Instructions on using the memory card

The camera can use SD/SDHC Memory Cards and MMC (Multi Media Cards).

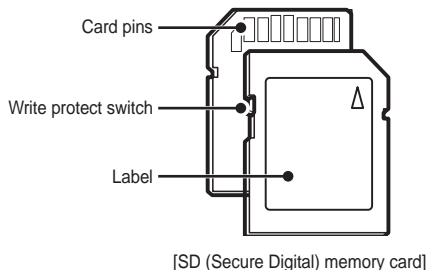

The SD/SDHC memory card has a write protect switch that prevents image files from being deleted or formatted. By sliding the switch towards the bottom of the SD/SDHC memory card, the data will be protected. By sliding the switch towards the top of the SD/SDHC memory card, the data protection will be cancelled. Slide the switch to the top of the SD/SDHC memory card before taking a picture.

When using a 256MB MMC memory, the specified shooting capacity will be as follows. These figures are approximate as image capacities can be affected by variables such as subject matter and memory card type.

Recorded image size	SUPER FINE	FINE	NORMAL	60FPS	30FPS	15FPS
Still image	10 ^m	49	94	136	-	-
	9 ^m	55	105	151	-	-
	7 ^m	68	129	183	-	-
	7 ^m	64	122	174	-	-
	5 ^m	93	173	242	-	-
	3 ^m	143	255	345	-	-
	1 ^m	418	617	732	-	-
* Movie	1280	-	-	-	about 5'23"	about 10'47"
	640	-	-	-	about 16'14"	about 25'
	320	-	-	-	about 20'18"	about 25'

* The recording times can be affected by the zoom operation. The zoom button doesn't operate while recording movies.

When Using the Camera for the First Time : Smart button

This button is used for shifting the menu cursor to select or for confirming the selected menu.

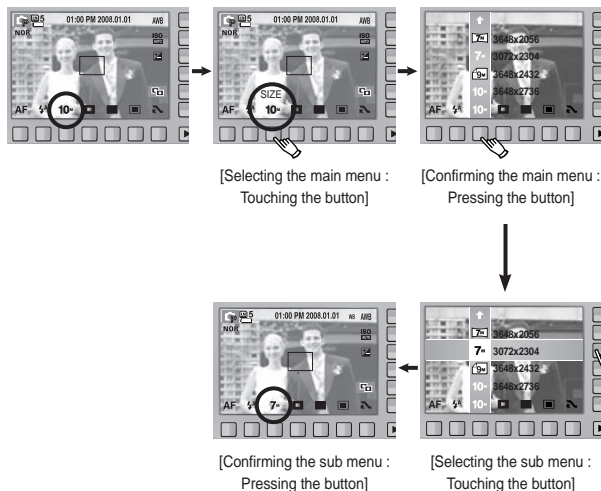

To select a sub menu, in some menus, touch the button and slide your finger to the left / right.

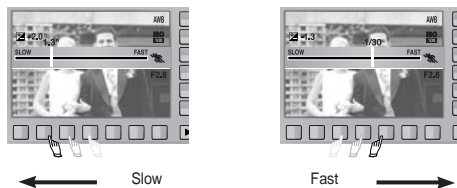

[e.g. : Manual - Selecting the shutter speed]

Extending the menus : Press the extension menu button and more available menus will be displayed.

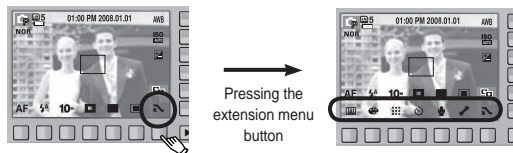

※ The AMOLED monitor will be dark when some menus are selected. After selecting the menu, the AMOLED monitor returns to the brightness set as before.

When Using the Camera for the First Time : Setting up the Date / Time and Language

When the camera is turned on for the first time, a menu will be displayed in the AMOLED monitor to set date, time and language. This menu will not be displayed again after setting up the date, time and language. Set up the date, time and language before using this camera.

■ Setting up the language

1. Press the [Language] menu button.
2. Select a desired language by pressing the vertical smart button.

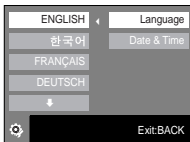

- You can select any one of 23 languages. These are listed below :
 - English, Korean, French, German, Spanish, Italian, S.Chinese, T.Chinese, Japanese, Russian, Portuguese, Dutch, Danish, Swedish, Finnish, Thai, Bahasa (Malay / Indonesian), Arabic, Persian, Polish, Hungarian, Czech and Turkish.
- Even if the camera is restarted, the language setting will be maintained.

■ Setting up the date, time and date type

1. Press the [Date & Time] menu button.
2. Select a desired date type by pressing the vertical smart button.

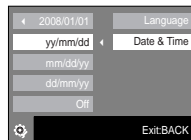

3. To change the date, select the [2008/01/01] menu and press the vertical smart button.
4. To select Year / Month / Day and Hour : Minute, press the horizontal smart button. To change the numbers, press the vertical smart button.

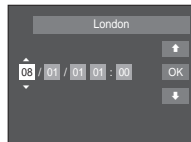

※ For more information about the World Time, refer to page 70.

Starting the recording mode

How to use the AUTO mode

Please select this mode for quick and easy picture taking with minimal user interaction.

1. Insert the battery (p.15) taking note of the correct polarity (+ / -).
2. Insert the memory card (p.15). As this camera has a 16MB internal memory, it is not essential to insert the memory card. If the memory card is not inserted, an image will be stored in the internal memory. If the memory card is inserted, an image will be stored on the memory card.
3. Close the battery chamber cover.
4. Press the power button to turn on the camera. (If the date / time that is displayed on the AMOLED monitor is incorrect, reset the date / time before taking a picture.)
5. Select the AUTO mode by rotating the mode dial.
6. Point the camera towards the subject and compose the image by using the AMOLED monitor.
7. Press the shutter button to capture an image.

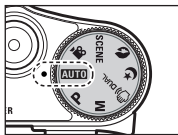

- If the Auto focus area turns to red when you press the shutter button down half way, it means that the camera cannot focus on the subject. Should this be the case, the camera is unable to capture an image clearly.
- Avoid obstructing the lens or the flash when you capture an image.

How to use the PROGRAM mode

Selecting the program mode will configure the camera with optimal settings. You can still manually configure all functions except the aperture value and shutter speed.

1. Select the PROGRAM mode by rotating the mode dial.
2. Press the horizontal smart button to configure advanced functions such as image size (p.33), quality (p.38), metering (p.36) and shooting mode (p.36).

※ Refer to page 30 ~ 44 for more information about the menus.

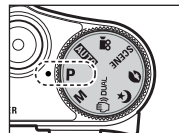

Starting the recording mode

How to use the MANUAL mode

The user can manually set both the aperture value and the shutter speed.

1. Select the MANUAL mode by rotating the mode dial.
2. Select the desired shutter speed and aperture value by using the smart button.
3. Point the camera towards the subject and compose the image by using the AMOLED monitor.
4. Press the shutter button to capture an image.

※ Refer to page 43 for more information about the menus.

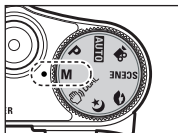

How to use the DUAL IS (Dual Image Stabilization) mode

This mode will reduce the effect of camera shake and help you get a well-exposed image in dim conditions.

1. Select the DUAL IS mode by rotating the mode dial.
2. Point the camera towards the subject and compose the image by using the AMOLED monitor.
3. Press the shutter button to capture an image.

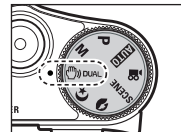

- Things to watch out for using the DUAL IS mode
 - The digital zoom will not operate in the DUAL IS mode.
 - If the lighting conditions are brighter than fluorescent lighting, the DUAL IS will not be activated.
 - If the subject is moving the final image captured may be blurred.
 - Avoid moving the camera while the [Capturing!] message is displayed to achieve a better result.
 - As the DUAL IS uses the camera's digital processor, images taken using the DUAL IS may take a little longer for the camera to process.

Starting the recording mode

Night, Portrait scene mode

Select a desired mode by rotating the mode dial.

- NIGHT : Use this for shooting still images at night or in other dark conditions.
- PORTRAIT : To take a picture of a person.

1. Select the NIGHT or PORTRAIT mode by rotating the mode dial.
2. Point the camera towards the subject and compose the image by using the AMOLED monitor.
3. Press the shutter button to capture an image.

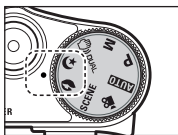

[NIGHT mode]



[PORTRAIT mode]

How to use the SCENE mode

Use the menu to easily configure optimal settings for a variety of shooting situations.

1. Select the SCENE mode by rotating the mode dial.
2. Select the required Scene mode by pressing the smart button. (p. 44)
3. Point the camera towards the subject and compose the image by using the AMOLED monitor.
4. Press the shutter button to capture an image.

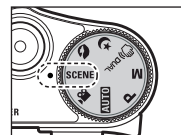

Starting the recording mode

How to use the MOVIE mode

A movie clip can be recorded for as long as the available recording time (maximum of 25 minutes) of the memory capacity allows.

1. Select the MOVIE mode by rotating the mode dial. (Available recording time will appear on the AMOLED monitor)
2. Point the camera towards the subject and compose the image by using the AMOLED monitor.

Press the shutter button and movie clips are recorded for as long as the available recording time allows. Movie clips will still be recorded if the shutter button is released.

If you wish to stop recording, press the shutter button again.

* Image size and type are listed below.

- Image size : 1280x720, 640x480, 320x240 (Selectable)
- File type : H.264(MPEG4.AVC)

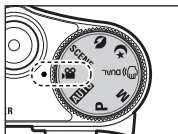

Recording HD (High Definition) movie clips

You can record HD (High Definition) movie clips. (1280X720, 30 fps) H.264(MPEG4.AVC) is a standard for the digital video codec. It supports a high quality movie clip in a small file size. You can enjoy the recorded movie clips, as good as the HDTV (High Definition Television) level when connecting to the HDTV (p.64).

1. Select [1280] to set the resolution after pressing the button.
2. Recording starts for the available recording time (maximum of 25 minutes) after you press the shutter button.



What is **H.264(MPEG4 part10/AVC)** ?

With its high-compression rate and the small file size, it is a standard for the digital video codec. It supports the recording functions in a high resolution.

Starting the recording mode

Recording the movie clip without sound

You can record the movie clip without sound.

1. Press the extension menu button.
2. Select the [VOICE] → [OFF] menu.
3. Press the shutter button and movie clip is recorded for as long as the available recording time without sound.

※ If the Zoom buttons are being pressed during the Movie clip shots, the voice will not recorded.

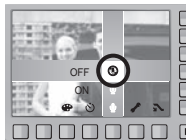

Pausing while recording a movie clip (Successive Recording)

This camera allows you to temporarily stop during unwanted scenes, while recording a movie clip. Using this function, you can record your favourite scenes into a movie clip without having to create multiple movie clips.

■ Using Successive Recording

1. Press the shutter button and movie clips are recorded for as long as the available recording time allows. Movie clips will still be recorded if the shutter button is released.
2. Press the **II** button to pause recording.
Press the **●** button again to resume the recording.
3. If you wish to stop recording, press the shutter button again.



Using Photo Style Selector Mode

By using the photo style selector dial located on the top of the camera, you can create photos that have various effects applied to them without using an image correction program.

1. Using the Photo Style Selector Dial, select a desired photo style.

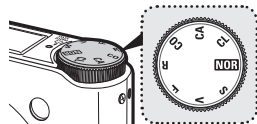

Icon	Style Mode	Description
NOR	NORMAL	No style effect is applied.
/s	SOFT	Soft style is applied.
/v	VIVID	Vivid style is applied.
/F	FOREST	Natural, clean style is applied.
/R	RETRO	Sepia tone style is applied.
/co	COOL	Cool style is applied.
/CA	CALM	Calm style is applied.
/CL	CLASSIC	Classic style is applied.

2. Point the camera towards the subject and compose the image by using the AMOLED monitor.
3. Press the shutter button to capture an image.



Photo Style Selector Mode is not available in [NIGHT], [PORTRAIT], [MOVIE] or [SCENE] Mode.

Things to Watch Out for When Taking Pictures

- Pressing the shutter button down half way.
Lightly press the shutter button to confirm focus and flash battery charge.
Press the shutter button all the way down to take the picture.

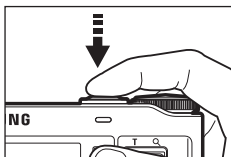

[Lightly press the shutter button]

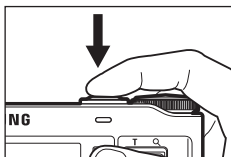

[Press the shutter button]

- The available recording time may vary depending on shooting conditions and camera settings.
- When either the Flash Off or Slow synchro mode is selected in a low lighting condition, the camera shake warning indicator (📷) may appear on the AMOLED monitor. In this case, use a tripod, support the camera on a solid surface or change to flash shot mode.
- Shooting against the light :
It is best to take pictures with the sun in the background. Taking pictures against the sun may make the picture come out dark. To take a picture against the light, please use the [Backlight] in scene shooting mode (see page 44), fill-in flash (see page 32 ~ 33), spot metering (see page 36), exposure compensation (see page 42) or ACB (see page 43) function.

- Avoid obstructing the lens or the flash when you capture an image.
- Compose the image by using the AMOLED monitor.
- In some of the following conditions the Auto focus area system may not perform as expected.
 - When photographing a subject that has little contrast.
 - If the subject is highly reflective or shiny.
 - If the subject is moving at high speed.
 - When there is strong reflected light, or when the background is very bright.
 - When the subject matter has only horizontal lines or the subject is very narrow (such as a stick or flagpole).
 - When the surroundings are dark.

Using the camera buttons to set the camera

The recording mode function can be set up by using the camera buttons.

POWER button

Used for turning the camera's power on / off. If there is no operation during the specified time, the camera's power will be turned off automatically to save battery life. Refer to page 72 for more information about the auto power off function.

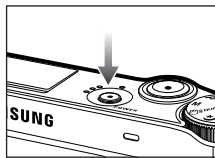

SHUTTER button

Used for taking an image or recording voice in the RECORDING mode.

• In MOVIE CLIP mode :

Pressing the shutter button down fully starts the process for recording a movie clip. Press the shutter button once and the movie clip is recorded for as long as the available recording time in the memory allows. If you wish to stop recording, press the shutter button again.

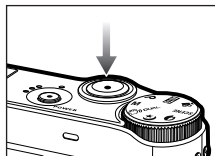

• In STILL IMAGE mode :

Pressing the shutter button down halfway activates the autofocus and checks the condition of the flash. Pressing the shutter button down fully takes and stores the image. If you select voice memo recording, the recording will start after the camera has finished storing the image data.

OIS (Optical Image Stabilization) button

Minimize camera-shake during shooting by pressing the OIS button in Shooting Mode.

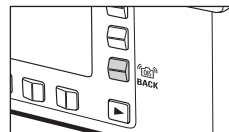

When the Shutter button is pressed halfway down, the shutter speed and aperture will appear in the AMOLED and camera-shake correction will be activated.



[Before using OIS]





[After using OIS]

※ OIS may not function properly in the following circumstances:

- To take pictures of a moving subject
- To take pictures with higher digital zoom values
- When camera shake is beyond the camera-shake correction range
- The slower the shutter speed, the lower the camera-shake correction performance.

Using the camera buttons to set the camera



- If you operate OIS function using a tripod, the image can be blurred by the vibration of the sensor of the OIS. Turn off the OIS function when you use a tripod.
- If the camera is subjected to an impact the AMOLED monitor can be affected. To make the camera function properly again, turn it on and off.
- Operate the OIS function when the battery is sufficiently charged (, ).
- If the low battery level () is showing, OIS can still be set but will not work.
- The OIS feature is not recommended in Macro mode.
- If the OIS function is set when recording video, the sound of the OIS working may be recorded.

ZOOM W / T button

If the menu is not displayed, this button works as the OPTICAL ZOOM or DIGITAL ZOOM button.

This camera has a 3.6X optical zoom and a 5X digital zoom function. Using both will offer a total zoom ratio of 18X.

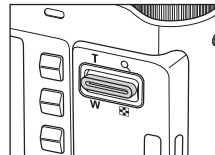

■ TELE Zoom

Optical zoom TELE : Pressing the ZOOM T button will zoom into the subject i.e. the subject will appear nearer.

Digital zoom TELE : When the maximum (3.6X) optical zoom is selected, pressing the ZOOM T button activates the digital zoom software. Releasing ZOOM T button stops the digital zooming at the required setting. Once the maximum digital zoom (5X) is achieved, pressing the ZOOM T button will have no effect.

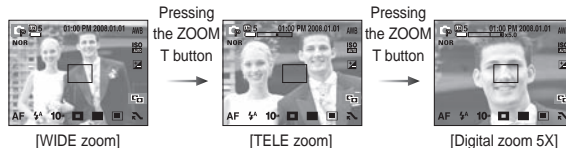
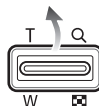

Using the camera buttons to set the camera

ZOOM W / T button

■ WIDE Zoom

Optical zoom WIDE : Pressing the ZOOM W button. This will zoom out from the subject i.e. the subject will appear farther away. Pressing the ZOOM W button continuously will set the camera to its minimum zoom setting i.e. the subject appears to be far from the camera.

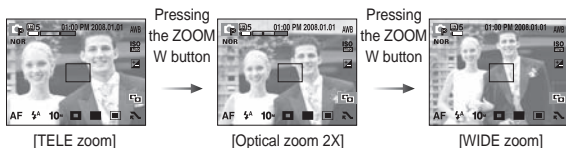

Digital zoom WIDE : When the digital zoom is in operation, pressing the ZOOM W button will reduce the digital zooming in steps. Releasing ZOOM W button stops digital zooming. Pressing the ZOOM W button will reduce the digital zoom and then it will continue to reduce the optical zoom until the minimum setting is reached.

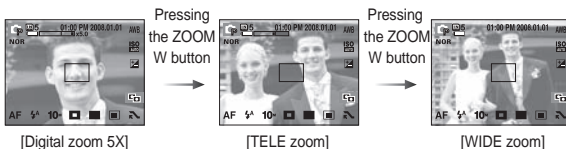
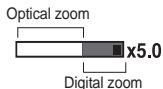

- Images taken using the digital zoom may take a little longer for the camera to process. Allow time for this to take place.
- You may notice a decrease in image quality when using the digital zoom.
- To view a clearer digital zoom image, press the shutter button halfway at the maximum optical zoom position and press the zoom T button again.
- The digital zoom can't be activated in the [DUAL IS], [MOVIE], [HIGH SPEED], [M.CAPTURE], [NIGHT], [CHILDREN], [CLOSE UP], [TEXT], [FIREWORKS], [SELF SHOT], [FOOD], [CAFÉ] modes.
- Take care not to touch the lens to avoid taking an unclear image and possibly causing camera malfunction. If the image is dim, turn the camera power off and on again to modify the lens position.
- Take care not to press the lens as this may cause a camera malfunction.
- When the camera is turned on, take care not to touch the camera's moving lens parts as this may cause the resulting image to be dim and unclear.
- You can operate the Wide and Tele zoom by using the remote control.

Using the AMOLED monitor to set the camera

You can use the menu on the AMOLED monitor to set up recording functions.

(● : Selectable, - : Partly selectable)

MENU				M				SCENE		Page
FOCUS	NORMAL (AF)	●	●	●	●	●	●	-	●	p.31
	AUTO MACRO	●			●			-		
	MACRO		●	●				-	●	
FLASH	OFF	●	●	●	●	●	●	-		p.32-33
	AUTO	●	●					-		
	RED EYE	●	●				●	-		
	FILL IN		●	●				-		
	SLOW SYNC		●			●		-		
	RED EYE FIX	●	●			●	●	-		
SIZE		●	●	●	●	●	●	●	●	p.33
FOCUS AREA	FACE DETECTION	●	●	●	●		●	-		p.34-35
	SELF PORTRAIT	●	●	●	●		●	-		
	CENTER AF	●	●	●	●	●	●	-		
	MULTI AF	●	●	●	●	●	●	-		

MENU				M				SCENE		Page
SHOOTING	SINGLE	●	●	●	●	●	●	-		p.36
	CONTINUOUS		●	●				-		
	HIGH SPEED		●	●						
	MOTION CAPTURE		●	●						
	AEB		●							
METERING	MULTI	●	●	●	●				●	p.36
	SPOT		●	●	●				●	
	CENTER		●	●	●				●	
IMAGE ADJUST	SHARPNESS		●	●						p.37
	SATURATION		●	●						
	CONTRAST		●	●						
EFFECT	NORMAL	●	●	●	●		●	-	●	p.38
	B&W		●	●			●	-	●	
	SEPIA		●	●			●	-	●	
	BLUE		●	●			●	-	●	
	RED		●	●			●	-	●	
	GREEN		●	●			●	-	●	
	NEGATIVE		●	●			●	-	●	

Using the AMOLED monitor to set the camera

MENU									Page	
QUALITY / FRAME RATE		●	●	●	●	●	●	●	p.38	
TIMER	OFF	●	●	●	●	●	●	●	p.39	
	10SEC	●	●	●	●	●	—	●		
	2SEC	●	●	●	●	●	—	●		
	DOUBLE	●	●	●	●	●	—	●		
	REMOTE	●	●	●	●	●	—	●		
VOICE	OFF	●	●	●	●	●	●	●	p.40	
	MEMO	●	●	●	●	●	●	●		
	RECORD	●	●	●	●	●	●	●		
	VOICE							●		
WB			●	●	●				●	p.41
ISO				●	●					p.42
EV			●		●				●	p.42
ACB			●							p.43
SHUTTER SPEED				●						p.43
APERTURE VALUE				●						p.43
OIS		●	●	●	●	●	●	●	●	p.27

※ Menus are subject to change without prior notice.

※ The selectable menus may vary in each scene modes.

Selecting focus type

You can select the focus type in accordance with the subject distance.

The distance ranges are show below.



[Normal]



[Macro]



[Auto Macro]

■ Types of focus modes and focus ranges

Focus Type	Wide (W)	Tele (T)
Normal	40cm ~ Infinity	80cm ~ Infinity
Macro	5cm ~ 40cm	50cm ~ 80cm
Auto Macro	5cm ~ Infinity	50cm ~ Infinity



- When the macro mode is selected, it is possible that camera shake will occur. Take care not to shake the camera while taking a picture.
- When you take a picture within 40cm in the Macro mode, select the FLASH OFF mode.

Flash

You can select the flash type in accordance with the subject distance.

The distance ranges are show below.

- When using the [DUAL IS], [CONTINUOUS], [HIGH SPEED], [M.CAPTURE], [AEB], [MOVIE], [LANDSCAPE], [CLOSE UP], [TEXT], [SUNSET], [DAWN], [FIREWORK], [SELF SHOT], [FOOD], [CAFÉ] mode, the flash will not operate.

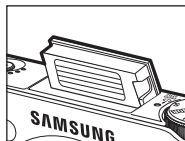

- Flash range (W : Wide, T : Tele)

(Unit : m)

ISO	Normal	Macro	Auto macro
AUTO	W: 0.4 - 5.6	W: 0.4 - 0.8	W: 0.4 - 5.6
	T: 0.5 - 2.8	T: 0.5 - 1.5	T: 0.5 - 2.8



- If you press the shutter button after selecting the Auto, Fill-in, Slow synchro flash, the first flash fires to check the shooting condition (Flash range and Power ratio of flash).
Do not move the camera until the second flash fires.
- Using the flash frequently will reduce the life of the battery.
- Under normal operating conditions the charging time for the flash is usually less than 5 seconds. If the battery is weak, the charging time will be longer.
- Take photographs within the flash range.
- The image quality is not guaranteed if the subject is too close or highly reflective.
- When taking an image in poorly lit conditions with the flash, there may sometimes be a white speck in the captured image.
The speck is caused by the reflection of the flash light from the atmospheric dust. It is not a camera malfunction.

Flash

■ Flash mode indicator

Icon	Flash mode	Description
	OFF	The flash does not fire. Select this mode when capturing images in a place or situation where flash photography is prohibited. When you capture an image in a poorly lit condition, the camera shake warning indicator () will display on the AMOLED monitor.
	AUTO	If the subject or background is dark, the camera flash will operate automatically.
	RED EYE	If a subject or background is dark, the camera flash will work automatically and will reduce the red-eye effect by using the red-eye reduction function.
	FILL IN	The flash fires regardless of the available light. The intensity of the flash will be automatically controlled to suit the prevailing conditions.
	SLOW SYNC	The flash operates with a slow shutter speed to obtain a balanced correct exposure. In poor lighting conditions the camera shake warning indicator () will display on the AMOLED monitor.
	RED EYE FIX	When a shot with "red eye" is detected, this mode will reduce the red-eye effect automatically.

Size

You can select the image size appropriate for your application.

Mode	Still image mode						
Icon	10^M		7^M		5^M	3^M	1^M
Size	3648x2736	3648x2432	3072x2304	3648x2056	2592x1944	2048x1536	1024x768
Mode	Movie clip mode						
Icon	1280	640	320				
Size	1280x720	640x480	320x240				



[Still image mode]



[Movie clip mode]



- The higher the resolution, the lower the number of shots available because high resolution images require more memory.

Focus Area

You can select your preferred Focus Area according to the shooting conditions.

[FACE DETECTION] : This mode detects the face position of the subject automatically and then sets the focus and exposure. Select this mode for quick and easy portraits.

※ Selectable modes : AUTO, PROGRAM, MANUAL, DUAL IS, PORTRAIT, SCENE (SMILE SHOT, BLINK DETECTION, CHILDREN, BEACH&SNOW, SELF SHOT, CAFÉ)

1. In a configurable shooting mode, select the Face Detection menu (). The Face Detection icon will appear.

2. The size and position of the auto focus frame is set on the face of the subject automatically.

3. Press the shutter button halfway. The focus frame turns to green when the focus is activated.

4. Press the shutter button fully to take a picture.



- This function can detect up to 10 faces.
- When the camera recognises many people at the same time, it will focus on the nearest person.
- When the camera detects a target face, the white colour focus frame will be displayed over the target face and the grey colour focus frame appears over the remaining faces. Press the shutter button halfway down to focus on the face and the white focus frame turns green.
- Return to previous AF mode if face detection failed.
- In some conditions this function cannot work properly.
 - When a person wears dark glasses or some part of the face is hidden.
 - When the subject does not look at the camera.
 - Camera doesn't detect a face as the conditions are too dark or too bright.
 - The distance between the camera and object is too great.
- The maximum available Face Detection range is 3m (Wide).
- The nearer the subject, the faster the camera can recognize the subject.
- The Digital zoom is not activated in this mode.
- It can only be set if **NOR** is selected on the photo style selector dial.
- The [EFFECT] menu does not work when the [FACE DETECTION] function is set.

Focus Area

[SELF PORTRAIT] : When taking pictures of yourself, your face is automatically detected so that you can take self portraits more easily and quickly.

※ Selectable modes : AUTO, PROGRAM, MANUAL, DUAL IS, PORTRAIT, SCENE (SMILE SHOT, BLINK DETECTION, CHILDREN, BEACH&SNOW, SELF SHOT, CAFÉ)

1. Selecting the Self Portrait menu displays the Self Portrait icon ().

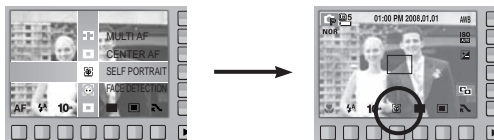

2. For self-filming, set the camera lens towards the face of the object.
It automatically detects the face of the object, and emits a guiding sound.
3. Start filming by pressing the shutter button.



- When locating the face in the center of the screen, it repeatedly emits a faster sound unlike the sounds that are emitted when the face is not in the center.
- The guiding sound can be set using the [SELF PORTRAIT] menu. (See p.67)
- It can only be set if **WOR** is selected on the photo style selector dial.
- The [EFFECT] menu does not work when the [SELF PORTRAIT] function is set.

[CENTER AF] : The rectangular area in the center of the AMOLED monitor will be focused.

[MULTI AF] : This camera selects all of available AF point from the 9 AF points.



[CENTER AF]



[MULTI AF]

※ A When the camera focuses on the subject, the auto focus frame turns to green. When the camera doesn't focus on the subject, the auto focus frame turns to red.

Continuous shot

You can select the type of shooting and the number of continuous shots.

[SINGLE] : Take one picture only

[CONTINUOUS] : Images will be taken continuously until the shutter button is released.
The shooting capacity depends on the memory.

[HIGH SPEED] : Continuous shooting is available while pressing and holding the shutter button (About 2 frames per second). The shooting speed may get slower depending on the shooting environment or the number of shots (if taking more than 20 images).

[M. CAPTURE] : This takes 10 shots per second, when the shutter is pressed and held down. After completing the continuous shooting, images are saved and the images play back on the Rear AMOLED. The maximum number of shots is 30 and the image size is fixed as 1024x768.

[AEB] : Take three pictures in a series using different exposures : standard exposure (0.0EV), Short exposure (-1/2EV) and over exposure (+1/2EV).

- ※ High resolution and picture quality increases file saving time, which increases stand-by time.
- ※ If the [CONTINUOUS], [HIGH SPEED], [M. CAPTURE] or [AEB] sub menu is selected, the flash is switched off automatically.
- ※ It is best to use a tripod for the AEB shooting as the time to save each image file is longer and blurring caused by camera shake may occur.
- ※ When the [M. CAPTURE] menu is selected, you only can select ISO AUTO, 400, 800, 1600, 3200.
- ※ The ACB function is not available when the [HIGH SPEED], [M.CAPTURE] or [AEB] options are enabled.



Metering

If you cannot obtain suitable exposure conditions, you can change the metering method to take brighter pictures.

[MULTI] : Exposure will be calculated based on an average of the available light in the image area. However, the calculation will be biased towards the centre of the image area.

This is suitable for general use.

[SPOT] : Only the rectangular area in the centre of the AMOLED monitor will be metered for light. This is suitable when you want the subject in the centre correctly exposed, regardless of the back lighting.

[CENTER] : Exposure will be calculated based on an average of the available light in the image area. However, the calculation will be biased towards the centre of the image area. This is suitable for taking a picture of small objects like flowers or insects.

- ※ If the subject is not the centre of the focus area, do not use the spot metering as this may result in an exposure error. In this circumstance, it is better to use exposure compensation.



Image Adjust

Pictures can be adjusted prior to shooting.

It can only be set if **NOR** is selected on the photo style selector dial.



Sharpness

You can adjust the sharpness of the picture you want to take. You cannot check the sharpness effect on the AMOLED monitor before you take a picture, because this function is applied only when the captured image is stored on the memory.

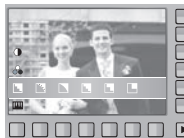

Saturation control

You can change the saturation of the image.

- + direction : High saturation
(The colour will be deep)
- direction : Low saturation
(The colour will be subtle)







Contrast

You can set the difference between bright part of the image and dark part of the image.

- + direction : Make image brighter
- direction : Make image darker



- [ / ] : The edges of the image are softened.
This effect is suitable for editing images on your PC.
- [] : The edges of the image are sharp.
This is suitable for printing.
- [ / ] : The edges of the image are emphasized.
The edges will appear sharp, but noise may occur in the recorded image.

Effect

By using the camera's digital processor, it is possible to add special effects to your images.

Pictures can be adjusted prior to shooting.

It can only be set if **NOR** is selected on the photo style selector dial.



NOR : No effect is added to the image.

BW : Captured images will be stored in black and white.

S : Captured images will be stored in a sepia tone (a range of yellowish brown colours).

B : Captured images will be stored in a blue tone.

R : Captured images will be stored in a red tone.

G : Captured images will be stored in a green tone.

+ : Save the image in negative mode.

※ The [FACE DETECTION], [SELF PORTRAIT], and White Balance (WB) menus do not work when the [EFFECT] function is set.

Quality / Frame rate

You can select the compression ratio appropriate for your application of the captured images. The higher the compression ratio, the lower the picture quality.

Mode	Still image mode			Movie clip mode		
Icon						
Sub menu	SUPER FINE	FINE	NORMAL	60FPS	30FPS	15FPS
File Type	jpeg	jpeg	jpeg	H.264	H.264	H.264



[Still image mode]



[Movie clip mode]



- This file format complies with the DCF (Design rule for Camera File system).
- JPEG (Joint Photographic Experts Group) : JPEG is the image compression standard developed by the Joint Photographic Experts Group. This is the most commonly used method of compression for photos and graphics due to its high efficiency.
- H.264(MPEG4 part10/AVC) : It was developed by the ITU-T Video Coding Experts Group (VCEG) together with the ISO/IEC Moving Picture Experts Group (MPEG) as the product of a partnership effort. With its high-compression rate and the small file size, you can record more contents compared to other storage devices.

Self-timer / Remote control

This function is used when the photographer would also like to be in the picture.

- Selecting a self-timer :

When you press the 'shutter' button, the picture will be taken after the specified time has elapsed and the self-timer function will stay on.

- Selecting a remote mode :

Pressing the shutter button of a separate remote control will allow an interval of 2 seconds before the image is taken. After taking a picture, the remote mode will be maintained. But, pressing the Power button will cancel the remote mode.



■ Description of Self-timer / Remote mode

Icon	Mode	Description
OFF	OFF	You can not use the self-timer function.
	10 SEC	Pressing the shutter button will allow an interval of 10 seconds before the image is taken.
	2 SEC	Pressing the shutter button will allow an interval of 2 seconds before the image is taken.
	DOUBLE	A picture will be taken after about 10 seconds and 2 seconds later a second picture will be taken.
	REMOTE	You can take a picture by remote control instead of using the shutter button of the camera.

■ Remote control range

When you take a picture by using the remote control, refer to the illustrations shown alongside about the remote control range.

[Shutter button on the remote control]

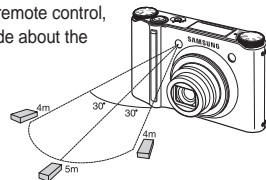

■ Replacing battery for the remote control

Make sure the + (positive) polarity is toward the top and the - (negative) polarity is toward the bottom while installing battery for the remote control. Replace battery for the remote control in the local service centre. Use the CR 2025 3V battery.

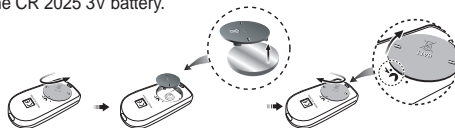

- When taking a picture using the self-timer, the self-timer lamp works as follows :
 - 10 second self-timer setting :
 - The self-timer lamp blinks at 1 second interval for the first 7 seconds.
 - It blinks at 0.25 second interval for the remaining 3 seconds.
 - 2 second self-timer setting
 - The self-timer lamp blinks at 0.25 second interval for 2 seconds.
- If you operate the Back button during the self-timer operation, the self-timer function is canceled.
- Use a tripod to prevent camera shake.

Voice recording / Voice memo

A voice can be recorded for as long as the available recording time (Max 10 hours) of the memory capacity allows. And you can add your voice-over to a stored still image.

■ Voice recording

1. Select a recording mode with the exception of the Movie clip mode by rotating the mode dial.
2. Select the Voice recording menu by using the smart button.
3. Press the shutter button to record a voice.
 - Press the shutter button once and voice is recorded for as long as the available recording time allows (Max 10 hours).
The recording time will be displayed on the AMOLED monitor. Voice will still be recorded if the shutter button is released.
 - If you wish to stop recording, press the shutter button again.
 - File type : *.wav

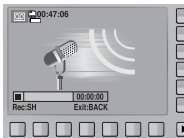

■ Voice memo

1. Select a recording mode with the exception of the Movie clip mode by rotating the mode dial.
2. Select the Voice memo menu by using the smart button. If the voice memo indicator is displayed on the AMOLED monitor, the setting is completed.
3. Press the shutter button and take a picture.
The picture is stored on the memory card.
4. Voice memo will be recorded for ten seconds from the moment the picture is stored. In the middle of the sound recording, pressing the shutter button will stop the voice memo.



- A distance of 40cm between you and the camera (microphone) is the best distance to record sound.

White balance

The white balance control allows you to adjust the colours to appear more natural. When a menu except the AWB (Auto White Balance) is selected, you can only select the negative colour effect. White Balance menu is available in the Program, Manual and DUAL IS, Movie clip mode.



Icon	Mode	Description
	AUTO	The camera automatically selects the appropriate white balance settings, depending on the prevailing lighting conditions.
	DAYLIGHT	For taking images outside.
	CLOUDY	For taking images under a cloudy and overcast sky.
	FLUORESCENT H	For shooting under daylight fluorescent types of three way fluorescent lighting.
	FLUORESCENT L	Shooting under white fluorescent lighting.
	TUNGSTEN	For shooting under tungsten (standard light bulb) lighting.
	CUSTOM	Allows the user to set the white balance according to the shooting conditions.

※ Different lighting conditions may cause a colour cast on your images.

■ Using the Custom White Balance

White balance settings may vary slightly depending on the shooting environment. You can select the most appropriate white balance setting for a given shooting environment by setting up the custom white balance.

1. Select the CUSTOM () menu of the White Balance and place a sheet of white paper in front of the camera so that the AMOLED monitor shows only white.

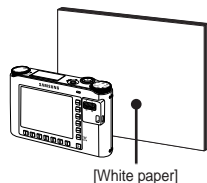

2. OK menu button : selects pre-saved custom white balance.

BACK button : cancels the custom white balance.

Shutter button : stores the new custom white balance.

- The custom white balance value will be applied, starting with the next picture you take.
- The user configured white balance will remain effective until it is overwritten.
- When set to photo style, white balance is automatically fixed (AWB).



ISO

You can select the ISO sensitivity when taking pictures.

The speed or specific light-sensitivity of a camera is rated in ISO numbers. ISO menu is available in the Program and Manual mode.



Icon	ISO mode	Description
	AUTO	The camera's sensitivity is automatically changed by variables such as lighting value or subject brightness.
	ISO 80	You can increase the shutter speed while the same amount of light is present, by increasing the ISO sensitivity. However, the image may be saturated in high luminance. The higher the ISO value, the greater is the camera's sensitivity to light; therefore it has a greater capacity for taking pictures in darker conditions. However, the noise level in the image will increase as the ISO value increases, making the image appear coarse.
	ISO 100	
	ISO 200	
	ISO 400	
	ISO 800	
	ISO 1600	
	ISO 3200	

※ When the [M. CAPTURE] menu is selected, you only can select ISO AUTO, 400, 800, 1600, 3200.

※ When the ISO 3200 menu is selected, the image size is fixed as 3M.

Exposure compensation

This camera automatically adjusts the exposure according to the ambient lighting conditions. You can also select the exposure value in the compensating exposure menu. Exposure compensation menu is available in the Program and DUAL IS, Movie mode.

■ Compensating Exposure

1. Press the exposure compensation menu button and the exposure compensation menu bar will appear as shown.
2. Touch the button and slide your finger to select the exposure value.
3. Press the exposure compensation menu button again. The value you set will be saved and the Exposure Compensation setup mode will close.



- ※ A negative exposure compensation value reduces the exposure. Note that a positive exposure compensation value increases the exposure and the AMOLED monitor will appear white or you may not get good pictures.

ACB (Auto Contrast Balance)

When this option is selected, the contrast is automatically adjusted. That is, when pictures are taken in backlight conditions where the exposure varies considerably or where there is wide variation in brightness, the brightness is automatically adjusted to obtain clear picture quality.

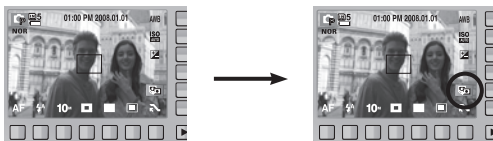

- ※ The ACB function is available in [AUTO], [PROGRAM] or [PORTRAIT] recording mode. ACB function always operates in the [AUTO], [PORTRAIT] recording mode.
- ※ The ACB function is not available when the [HIGH SPEED], [M.CAPTURE] or [AEB] options are enabled.
- ※ The ACB function is available only when ISO is set to a value between 80 and 200.

Shutter Speed

This mode will set the shutter speed for automatic exposure in manual mode. High shutter speeds can capture a moving object in a way that makes it seem as if the object is not moving. Low shutter speeds can capture a moving object, giving it a dynamic feeling of movement.



■ Setting up the shutter speed

To select the shutter speed, touch the button and slide your finger to the left or right.

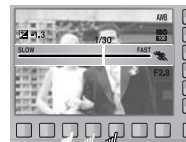

← Slow

Fast →

Aperture Value

This mode will set the aperture value for automatic exposure in manual mode. Smaller aperture values make the object sharp but blur the background. Larger aperture values make both the object and background sharp.



Scene menu

Use the menu to easily configure optimal settings for a variety of shooting situations.



Icon	Scene mode	Description
	SMILE SHOT*1	When taking a picture of smiling faces.
	BLINK DETECTION*2	When taking pictures by detecting blinking eyes it archives a successful shot.
	CHILDREN	To take a picture of fast moving objects, for example, children.
	LANDSCAPE	To take pictures of distant scenery.
	CLOSE UP	Close-up shooting for small objects such as plants and insects.
	TEXT	Use this mode to shoot a document.
	SUNSET	For taking pictures of sunsets.
	DAWN	Daybreak scenes.
	BACKLIGHT	For portraits without shadows caused by backlighting.
	FIREWORK	Firework scenes.
	BEACH&SNOW	For ocean, lake, beach and snow scape scenes.

Icon	Scene mode	Description
	SELF SHOT	Use when the photographer would also like to be in the picture.
	FOOD	For taking delicious looking food.
	CAFÉ	For taking pictures in cafes and restaurants.

- *1 The camera automatically takes a picture by detecting the face of the subject although you don't press the shutter button. If you press the shutter button, the picture is taken in the normal way. When taking a picture of smile shot, showing teethes or keeping the smiley face of your subject helps detecting the smile face of the subject.
- *2 If the eyes of the subject are closed when the shutter button is pressed, the camera takes three continuous shots and then the images are saved. The camera takes only one picture if the eyes of the subject are open when the shutter button is pressed.



- Detecting the smiling face or the blinking eyes may not be available if any of the following situations occurs:
 - If the subject is wearing sunglasses.
 - When the subject is not facing directly to the camera.
 - If the environmental light is too bright or too dark to detect the face of the subject.
 - When the camera is far from the subject. (Orange colored focusing mark)
 - If there is reflection of the light or the back light that are too bright.

Starting play mode

Turn the camera on and select Play mode by pressing the play mode button (▶). The camera can now play back the images stored in the memory.

If the memory card is inserted in the camera, all the camera functions apply only to the memory card.

If the memory card is not inserted in the camera, all the camera functions apply only to the internal memory.

Playing back a still image

1. Select the PLAY mode by pressing the play mode button (▶).

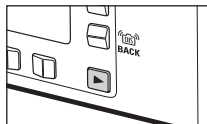

2. The last image stored on the memory is displayed on the AMOLED monitor.



3. Touch the button and slide your finger to the left or right to select an image.

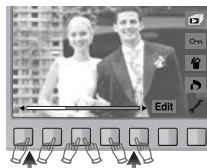

①

②

- ※ If you press the ① or ② button, the image will be played back continuously.



- Manner mode : To select the Manner mode, press the Play mode button for more than 3 seconds. In the Manner mode, Operating sound, Effect sound, Start-up sound and Shutter sound will not be generated. To cancel the Manner mode, turn on the camera by pressing the Power button.

Playing back a movie clip

1. Select the recorded movie clip that you want to play back by using the smart button.



2. Press the Play button to playback a movie clip file.

- To pause a movie file while playing it back, press the II button again.

- Pressing the ▶ button again will cause the movie clip file to restart.

- To rewind the movie clip while it is playing, press the ◀◀ button. To fast forward the movie clip, press the ▶▶ button.

Whenever the ◀◀/▶▶ button is pressed, the search speed will be increased to 2X, 4X, 8X or 16X.

- To stop playback of the movie clip, press the ■ button.



3. Press the ■ button and the menu moves to Play mode.

Starting play mode

Movie clip capture function

Capture still images from the movie clip.

1. Press the II menu button while playing back a movie file.
 2. Press the Capture menu button. The captured image is saved under a new file name.
- ※ The captured movie clip file is the same size as the original movie clip.
(1280x720, 640x480, 320x240)



On camera movie trimming

You can extract desired frames of movie clip during the movie clip play back.

1. Press the extract menu button at the point of the movie clip that you want to start extracting.
2. Press the extract menu button at the point of the movie clip that you want to stop extracting.
3. A confirmation window will be displayed.
4. Press the smart button to select a desired sub menu.
[Yes] : The extracted frames are saved as a new file name.
[No] : The movie trimming will be cancelled.



※ If the running time is under 5 seconds, the movie clip can't be trimmed.

Playing back a recorded voice

1. Select the recorded voice that you want to play back by using the smart button.
2. Press the Play button; menus for voice will be displayed.
3. Press the ▶ button to play back a voice clip file.
 - To pause a voice file while playing it back, press the II button again.
 - Pressing the ▶ button again will cause the voice file to restart.
 - To rewind the voice recording while it is playing, press the ◀ button.
 - To fast forward, press the ▶▶ button.
 - To stop playback of the voice, press the ■ button.



Playing back a recorded voice memo

1. Select the still image that includes the voice memo by using the smart button.
2. Press the Edit button and menu will be displayed.
3. Press the MEMO PLAY menu button to play back a voice memo.
 - To pause a voice file while playing it back, press the II button.
 - Pressing the ▶ button again will cause the voice file to restart.
 - To stop playback of the voice, press the ■ button.



AMOLED monitor indicator

The AMOLED monitor displays shooting information about the displayed image.

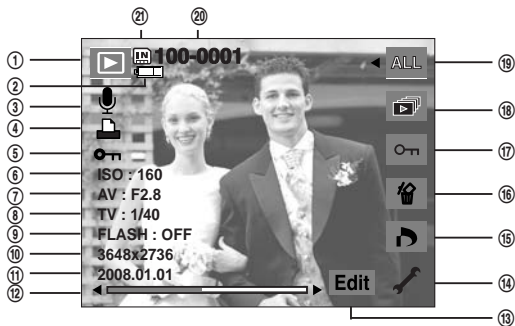

No.	Description	Icon	Page
1	Play back mode icon		-
2	Battery		p.15
3	Voice memo / Movie		p.40/p.24
4	DPOF		p.53
5	Protecting images		p.52
6	ISO	80 ~ 3200	p.42
7	Aperture value	F2.8 ~ F14.7	p.43
8	Shutter speed	16 ~ 1/2000	p.43

No.	Description	Icon	Page
9	Flash	ON/OFF	p.32-33
10	Image size	3648x2736 ~ 320x240	p.33
11	Recording date	2008.01.01	p.70
12	Slide Bar		-
13	Press the smart button		-
14	Setup menu		p.62-72
15	DPOF menu		p.53
16	Delete menu		p.52
17	Protect menu		p.52
18	Slide show menu		p.51
19	Playing Images		p.50
20	Folder name and Stored image number	100-0001	p.66
21	Memory card icon / Internal memory icon		p.15

Using the camera buttons to adjust the camera

In Play mode, you can use the buttons on the camera to conveniently set up the Play mode functions.

Play mode button

- If you have turned on the camera by pressing the POWER button, you can press the PLAY MODE button once to switch to Play mode and press it again to switch to Recording mode.
- You can turn the power on with the play mode button. The camera is turned on in play mode. Press the play mode button again to turn off the camera.

BACK button

- When the menus are displayed the BACK button allows you to return to the previous screen, and will eventually bring you out of the menu system.

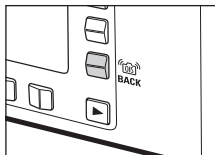

Using the remote control in play mode

You can play the movie clip and images by remote control.

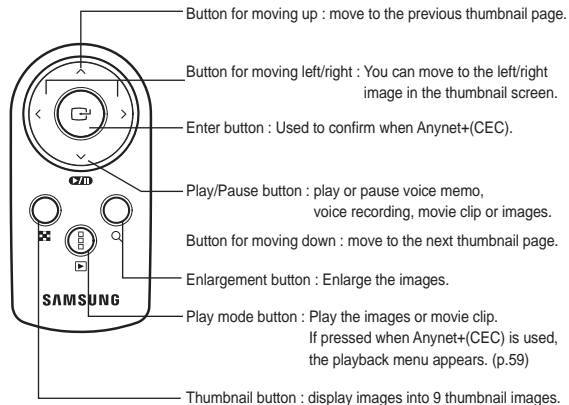

※ See page 39 about using the remote control in recording mode.

Thumbnail () / Enlargement () button

You can view multiple pictures, enlarge a selected picture, crop and use Image enlargement to save a selected area of an image.

■ Thumbnail display

1. While an image is displayed on full screen, press the thumbnail button.
2. The thumbnail display will highlight the image that had been showing at the time the thumbnail mode was selected.
3. Use the smart button to move to a desired image.
4. To view an image separately, press the enlargement button.

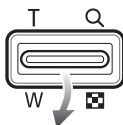

[Normal display mode]

Pressing the thumbnail button ()



Pressing the enlargement button ()



[Thumbnail display mode]

■ Image enlargement

1. Select an image that you want to enlarge and press the enlargement button.
2. Different parts of the image can be viewed by using the smart button.
3. Pressing the thumbnail button will zoom back to the original full sized image.

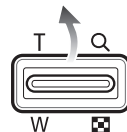



- You can tell whether the image displayed is an enlarged view by checking the image enlargement indicator shown at the top left of the AMOLED monitor. (If the image is not an enlarged view, the indicator will not be displayed.)



You can also check the area of enlargement.

- Movie clips and WAV files can't be enlarged.
- If an image is enlarged, a loss of quality may occur.

■ The maximum enlargement rate in proportion to the image size.

Image size	10 ^m		7 ^m		5 ^m	3 ^m	1 ^m
Maximum enlargement rate	x11.40	x10.13	x9.60	x8.56	x8.10	x6.40	x3.20

Thumbnail () / Enlargement () button

- Trimming : You can extract part of the image that you want and save it separately.

1. Enlarge the image by using the Zoom button.
To move the image, use the Smart button.
2. Press the smart button to display a confirmation window.
3. Press the [Yes] button.
The trimmed image will be saved as a new file name, and appear on the AMOLED monitor.

※ If there is not enough memory space to save the trimmed image, the image can't be trimmed.

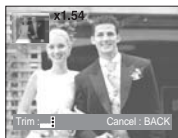

Playing Images

Images for a specific date or all images can be played.



1. Press the Play type button and menus as shown will display.

 - Play All

: All photos that were created can be checked.



- Play back by date

: Photos can be checked by the date they were created.



2. Press the Smart button to select a desired play back mode.

Starting the slide show

Images can be displayed continuously at pre-set intervals. You can view the slide show by connecting the camera to an external monitor. To start the slide show, press the Start menu button. While the slide show is playing, the movie file and the voice recording file will not be displayed.

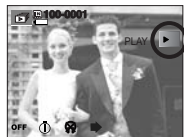

■ Configure slide show effects

Unique screen effects can be used for the slide show.

[Off] : No effect is added.

[Basic] : Fade In/Out effect is added and the images are displayed as set interval.

[Classic] : You can add noise to an image to add a more classic feel to your photo.

[Memories] : The film is aged to make it seem like an old movie.

[Rhythmic] : Images are displayed with various effects.

[Delight] : Images are displayed with various effects.



■ Setting play interval

Set the slide show play interval to the number of seconds preferred.

[1 sec] : Playback interval is 1 sec.

[3 sec] : Playback interval is 3 sec.

[5 sec] : Playback interval is 5 sec.

[10 sec] : Playback interval is 10 sec.

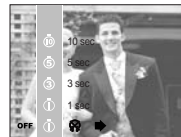

※ The interval menu functions in the [Off], [Basic] menu only.

■ Setting Background Music

Specify background music to be played during image playback.

- [Panorama], [First Smile] or [Remembrance] can be selected as background music.



■ Repeat Option

Selecting the repeat option for the slide show.

[ONE PLAY] : The slide show is closed after one cycle.

[REPEAT PLAY] : The slide show is repeated until cancelled.

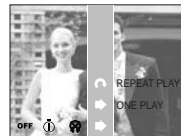

Protecting images

This is used to protect (Lock) specific shots from being accidentally erased. It also unprotects (Unlocks) images that have been previously protected.

[ONE] : Protect / release displayed image.

[ALL] : Protect / release all saved images.



- If you protect an image, the protect icon will be displayed on the AMOLED monitor. (An unprotected image has no indicator)

- An image in LOCK mode will be protected from the delete function, but will NOT be protected from the format function.



Deleting images

This is used to delete the displayed image.

[YES] : Deletes displayed or checked (✓) image.

[NO] : Cancels deleting displayed image or checked (✓) image.

- The protected images can't be deleted.
- If you wish to delete multi-image, check to delete the image by using the (✓) button and the smart button (horizontal) and then press the [Yes] menu.
- The number of images will be displayed at the bottom right of the AMOLED monitor.

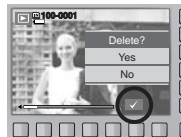

DPOF

- DPOF (Digital Print Order Format) allows you to embed printing information on your memory card's MISC folder. Select the pictures to be printed and how many prints to make.
- The DPOF indicator will appear on the AMOLED monitor when an image that has DPOF information plays back. Images can then be printed on DPOF printers, or at an increasing number of photo labs.
- This function is not available for Movie clips and Voice recording files.
- If a memory card is not inserted, the menus are still displayed in the AMOLED, but are not selectable.
- When the wide angle image is printed as a wide angle print, 8% of the left and right side of the image may not be printed. Check that your printer can support the wide angle image when you print the image. When you print the image at a photo lab, request that the image is printed as a wide angle image. (Some photo labs may not support the wide angle size print.)

DPOF : IMAGES

This function allows you to embed print quantity information on a stored image.

1. Select the DPOF menu by pressing the smart button.
2. Select the [IMAGES] menu by pressing the smart button.
3. Select a desired sub menu by pressing the smart button.

[ONE PIC] : Select a number of prints of displayed image.

[ALL PICS] : Configure number of prints for all pictures except movie and voice files.

[CANCEL] : Cancel the print setup.

4. Press the OK button to confirm the setting. If an image carries DPOF instructions, the DPOF indicator () will appear.



DPOF : Print size

You can specify the print size when printing images stored on the memory card. The [SIZE] menu is available only for DPOF 1.1 compatible printers.

■ Setting the Print Size

1. Select the [SIZE] menu by pressing the smart button.
2. Select a desired sub menu by pressing the smart button.

[ONE PIC] : Select a print size of displayed image.

[ALL PICS] : Change print size of all saved images.

[CANCEL] : Cancel all of the print size settings.

3. Press the OK button to confirm the setting.
If an image carries DPOF instructions, the DPOF indicator will show.



※ DPOF [SIZE] secondary menu : [Cancel], [3x5], [4x6], [5x7], [8x10]



- Depending on the manufacturer and printer model, cancelling the printing may take a little longer for the printer to process.

DPOF : Index

Images (except for movie clips and voice file) are printed as index type.

1. Select the [INDEX] menu by pressing the smart button.
2. Select a desired sub menu by pressing the smart button.

If [NO] is selected : Cancel the index print setting.

If [YES] is selected : The image will be printed in index format.



Rotating an image

You can rotate the stored images by various degrees. Once the playback of the rotated picture is finished, it will be saved in its rotated state.

1. Press the Edit button.
2. Press the [ROTATE] menu button.
3. Select a desired sub menu by pressing the smart button.

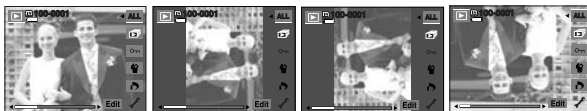
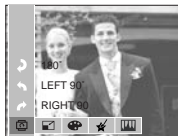

[Before rotating the image]

[RIGHT 90°]

[LEFT 90°]

[180°]

4. If you display the rotated image on the AMOLED monitor, empty spaces may appear to the left and right of the image.

Resize

Change the resolution (size) of pictures taken. Select [START IMAGE] to save an image to be the start-up image. The resized image will have a new file name.

1. Press the Edit button.
2. Press the [RESIZE] menu button.
3. Select a desired sub menu by pressing the smart button.



■ Image Resize Types

Size	3072x2304	2592x1944	2048x1536	1024x768	START IMAGE
10^M	•	•	•	•	•
7^M		•	•	•	•
5^M			•	•	•
3^M				•	•
1^M					•

Size	3264x2176	2592x1728	2048x1368	1024x680
9^M	•	•	•	•

Size	3072x1728	1920x1080	1280x720
7^M	•	•	•

Resize









- You can change the resolution of only those files compressed in the JPEG 4:2:2 format.
- The resized image will have a new file name. The [START IMAGE] image is stored not on the memory card but on the internal memory.
- Only one [START IMAGE] image can be saved. If you save a new [START IMAGE], the existing startup image will be deleted.
- If the memory capacity is insufficient to store the resized image, a [Memory Full!] message will appear on the AMOLED monitor and the resized image will not be stored.

Effect

By using the camera's digital processor, it is possible to add special effects to your images.

1. Press the Edit button.
2. Press the [EFFECT] menu button.
3. Select a desired sub menu by using the smart button.

-  : Captured images will be stored in black and white.
-  : Captured images will be stored in a sepia tone (a range of yellowish brown colours).
-  : Captured images will be stored in a blue tone.
-  : Captured images will be stored in a red tone.
-  : Captured images will be stored in a green tone.
-  : Save the image in negative mode.



Special Colour

1. Press the Edit button during playback.
2. Use the Smart button to select the (★) menu.

Colour Filter

With this menu, you can change the colour information of the image (excluding Red, Blue, Green and Yellow) to Black and White.

1. Press the [COLOR FILTER] menu button.
2. After the message [Processing!] is displayed, the corresponding effect is applied.
3. Press the OK button to save the changed image under a new filename.

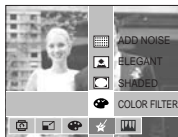

Shaded

This effect decreases the brightness of the surrounding portions, increases the brightness of the central portion, and makes the borders dark.

1. Press the [SHADED] menu button.
2. After the message [Processing!] is displayed, the corresponding effect is applied.
3. Press the OK button to save the changed image under a new filename.

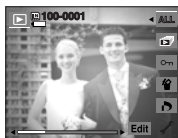
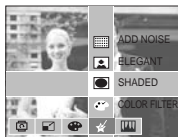

Elegant

This effect makes the photo's colours bright and rich for an elegant feel.

1. Press the [ELEGANT] menu button.
2. After the message [Processing!] is displayed, the corresponding effect is applied.
3. Press the OK button to save the changed image under a new filename.



Noise effect

You can add noise to an image to add a more classic feel to your photo.

1. Press the [ADD NOISE] menu button.
2. After the message [Processing!] is displayed, the corresponding effect is applied.
3. Press the OK button to save the changed image under a new filename.

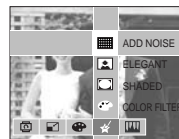

Image Adjust

1. Press the Edit button during playback.
2. Use the Smart button to select the (MENU) menu.

Red eye removal

Red eye effect can be removed from the captured image.

1. Press the [RED EYE FIX] menu button.
2. After the message [Processing!] is displayed, the corresponding effect is applied.
3. Press the OK button to save the changed image under a new filename.

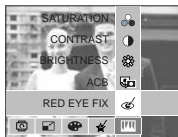

ACB

The brightness of a dark subject in the center portion of a photo can be automatically corrected.

1. Press the [ACB] menu button.
2. After the message [Processing!] is displayed, the corresponding effect is applied.
3. Press the OK button to save the changed image under a new filename.

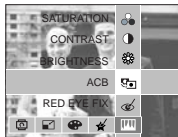

Brightness control

You can change the brightness of the image.

1. Press the [BRIGHTNESS] menu button.
2. Use the Smart button to adjust brightness as desired.
3. After the message [Processing!] is displayed, the corresponding effect is applied.
4. Press the OK button to save the changed image under a new filename.

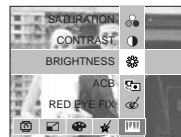

Contrast control

You can change the contrast of the image.

1. Press the [CONTRAST] menu button.
2. Use the Smart button to adjust contrast as desired.
3. After the message [Processing!] is displayed, the corresponding effect is applied.
4. Press the OK button to save the changed image under a new filename.



Image Adjust

Saturation control

You can change the saturation of the image.

1. Press the [SATURATION] menu button.
2. Use the Smart button to adjust Saturation as desired.
3. After the message [Processing!] is displayed, the corresponding effect is applied.
4. Press the OK button to save the changed image under a new filename.



Anynet+(CEC)

Anynet+(CEC) is an AV network system which controls all your connected SAMSUNG AV devices when using the TV remote control that supports Anynet+. When connected to the SAMSUNG HDTV, you can operate the playback functions by using the camera or the TV remote control. For more information about connecting the HDTV by using the HDMI cable, see page 64.

■ How to use the Anynet+(CEC)

1. Connect the cradle with the HDTV by using the HDMI cable to the HDMI connection ports while the camera is connected to the cradle. (p.64)
2. TV turns on as soon as the power button is pressed on the camera.
3. If there is no picture after turning on the TV, press the source button on the TV remote control to change to the HDMI mode.
 - Depending on the TV, it might not change to the HDMI mode although you press the source button.

Anynet+(CEC)

4. Press the Anynet+ button on the TV remote control.
5. Playback menu appears in the TV screen when you press the menu button on the TV remote control. (Or the playback button on the camera's remote control).

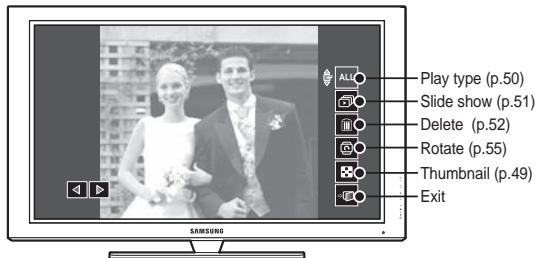

- ※ The playback menu appearing on TV screen operates the same function of the camera.
6. Select the desired playback function by using the remote control of the TV or the camera.
 - ※ To select the sub menus, move to the desired playback menu and then press the Enter button.
 - ※ For more detailed information of the remote control of the camera, see page 48.



- Only available when using the TV that supports Anynet+(CEC). (Not available by using TV that supports Anynet)
- As soon as you connect the camera with the cradle(with the camera's power turned on), the playback menu appears in the TV screen. (Available when the cradle and the TV are already connected.)
- For more detailed information of the HDTV connection, see the user manual of HDTV.

PictBridge

You can use the USB cable to connect this camera to a printer that supports PictBridge (sold separately) and print the stored images directly. Movie clips and voice files cannot be printed.

■ Setting up the camera for connection to a printer

1. Connect the camera to a printer's USB port with the supplied USB cable.
2. Select the [Printer] menu by using the smart button.

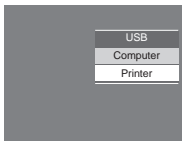

■ Connecting the Camera to a Printer

When using the cradle

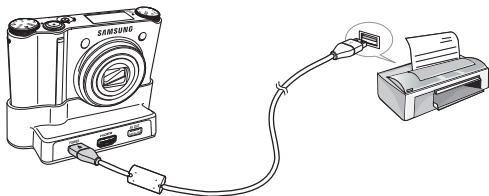

When the cradle is not used

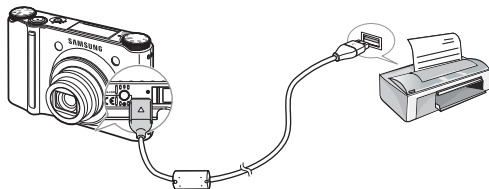

※ If you selected [Computer], when you connected the camera to your printer, the [Connecting Computer] message be displayed and the connection will not be established. Select [Printer] menu, when you connect the camera to your printer. Depending on the make and model of the printer it may not be possible to connect your camera to the printer.

■ Easy printing

When you connect the camera to printer in the Play back mode, you can print a picture easily with the default print settings.

1. In the play back mode, connect the camera and the printer.

The menu icons will appear as shown.

2. Press the  button.



3. Select the [Yes] menu and the image will print.



■ Print mode

You can select the Easy printing mode or Custom printing mode.

 : Custom Printing mode

 : Easy Printing mode

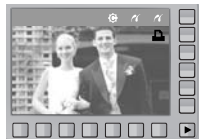

PictBridge

■ Custom Set

You can select the Paper Size, Print Format, Paper Type, Print Quality, Date Print, and File Name Print menus for printed pictures.

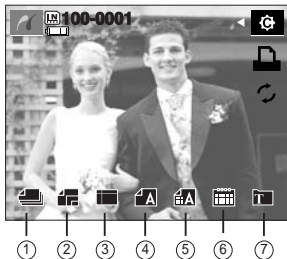

No.	Icon	Description	Menu
1		Selecting images for printing	ONE PIC, ALL PICS
2		Setting the size of the printing paper	AUTO, POSTCARD, CARD, 4x6, L, 2L, LETTER, A4, A3
3		Setting the number of pictures to be printed on a sheet of paper	AUTO, FULL, 1, 2, 4, 8, 9, 16, INDEX
4		Setting the quality of the printing paper	AUTO, PLAIN, PHOTO, FAST PHOTO
5		Setting the quality of the picture to be printed	AUTO, DRAFT, NORMAL, FINE
6		Setting whether to print the date	AUTO, OFF, ON
7		Setting whether to print the file name	AUTO, OFF, ON

※ Some menu options are not supported on all printers.
If not supported, the menus are not displayed in the AMOLED.

※ If the setting values are not changed in the automatic / manual setting, the setting values are automatically kept.

■ Printing images (Custom mode)

Images will be printed with changed printer setting.

1. In custom printing mode, press the Print menu button.

※ You can use Print menu button after selecting picture.

2. Select the [Yes] menu.

3. The screen shown on the right will appear and the picture will be printed. Press the BACK button while printing to cancel printing.

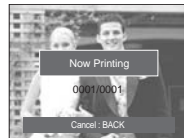

■ Reset

Initialises user-changed configurations.



- In custom printing mode, press the Reset menu button.







Setup menu

In this mode, you can set up basic settings. You can use the setup menu in all camera modes, except Voice Recording mode.

■ The items indicated by  are default settings.

Menu tab	Main menu	Sub menu		Page	
	OSD set (Recording mode)	Full	Basic	p.64	
		Func. Desc.	Hide		
		Display Save	-		
	OSD set (Playback mode)	Full	Basic		
		Hide	-		
	Display Bright	Auto	Dark		
		Normal	Bright		
	HDMI Size	1080i	720p		
		480p	576p		
	Start Image	Off	LOGO		
User Image		-			
	Sound Volume	Off	Low	p.65	
		Medium	High		
	Beep Sound	Off	Sound 1		
		Sound 2	Sound 3		
	Shutter Sound	Off	Sound 1		
		Sound 2	Sound 3		
	Start Sound	Off	Sound 1		p.66
		Sound 2	Sound 3		
AF Sound	Off	On			

Menu tab	Main menu	Sub menu			Page	
	File	Series	Reset	p.66		
	Self Portrait	Off	On	p.67		
	AF Lamp	Off	On			
	Quick View	Off	0.5, 1, 3 sec			
		Imprint	Off	Date	p.68	
Date & Time			-			
	Copy to Card	No	Yes	p.69		
	Delete All	No	Yes			
	Format	No	Yes			
	Language	ENGLISH	한국어	FRANÇAIS	p.70	
		DEUTSCH	ESPAÑOL	ITALIANO		
		简体中文	繁體中文	日本語		
		РУССКИЙ	PORTUGUÊS	DUTCH		
		DANSK	SVENSKA	SUOMI		
		ไทย	BAHASA	عربي		
		POLSKI	Magyar	Čeština		
		Türkçe	فارسی	-		
		Date&Time	2008/01/01	yy/mm/dd		mm/dd/yy
			dd/mm/yy	Off		-

Setup menu

Menu tab	Main menu	Sub menu	Page	
	Date & Time	World time available cities	p.70	
		London		Cape Verde
		Mid-Atlantic		Buenos Aires
		Newfoundland		Caracas, La Paz
		New York, Miami		Chicago, Dallas
		Denver, Phoenix		LA, San Francisco
		Alaska		Honolulu, Hawaii
		Samoa, Midway		Wellington, Auckland
		Okhotsk		Guam, Sydney
		Darwin, Adelaide		Seoul, Tokyo
		Beijing, Hong Kong		Bangkok, Jakarta
		Yangon		Almaty
		Kathmandu		Mumbai, New Delhi
		Tashkent		Kabul
	Abu Dhabi	Teheran		
	Moscow	Athens, Helsinki		
Rome, Paris, Berlin	-			
Reset	No	Yes	p.71	
Video Out	NTSC	PAL		
Power Off	Off	1, 3, 5, 10 min	p.72	

※ Menus are subject to change without prior notice.

■ How to select the setup menu

1. After pressing the  menu button, press the  button in the Camera Settings menu.



2. Each button has different setup menus.
Press the F1-5 (, , , , ) menu button.

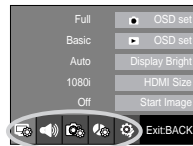

Setup menu ()

OSD set

You can check shooting (Recording mode) and displayed image (Play back mode) information.



[Recording mode menu]



[Play back mode menu]

- [Full] : When the smart button is touched, the icons will be enlarged and OSD will be displayed.
- [Basic] : When the smart button is touched, the icons will be enlarged and OSD will not be enlarged.
- [Func. Desc.] : Function description is displayed to provide detailed information on a function.
- [Hide] : If the camera doesn't operate for about 3 seconds, all OSD will disappear. When the shutter is pressed down or half way down, the available number of shots, shutter speed, Aperture value and Auto focus area will be displayed. OSD may be displayed by using the camera buttons except for the shutter button.
- [Display Save] : If the camera is not used for about 30 seconds, the power and camera status lamps blink and the AMOLED monitor turns off.

Display Bright

You can adjust the AMOLED brightness.

- Sub menus : [Auto], [Dark], [Normal], [Bright]
- If the [Auto] menu is selected, the AMOLED brightness will be set automatically according to the shooting conditions.
- If the [Auto] menu is selected in the Playback mode, the AMOLED brightness is fixed as the [Normal] menu.

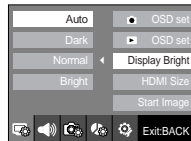

HDMI Size

When the camera is connected with the HDTV, you can select image size that is compatible with the HDTV. The image size are [1080i], [720p], [480p] and [576p]. Only when [480p] is set to [NTSC] and [576p] is set to [PAL], those resolutions will be displayed in the menu.

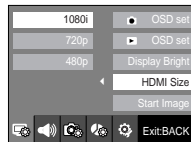

■ How to connect the camera with the HDTV

Connect the cradle with the HDTV by using the HDMI cable to the HDMI connection ports.

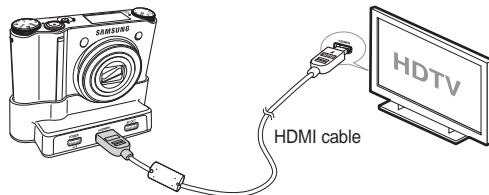

Setup menu ()



- HDMI (High Definition Multimedia Interface) is a function that allows transferring the recorded images without compression by using the HDMI cable. You can see the images in a high resolution in the HDTV.
- When Anynet+(CEC) is used and HDMI resolution is set to [480p](NTSC) or [576p](PAL), it is only available to play back the image, movie clip, voice.
- If the selected HDMI resolution is not supported by HDTV, the clear image can not be shown in the screen.
- If you try to select the HDMI resolution that is not supported by HDTV, the resolution is adjusted to the maximum resolution of the HDTV. For example, if you select "1080i" when the HDTV supports the "720p" by the maximum resolution, it is adjusted to "720p."
- You can playback the normal resolution of the movie clip as well.
- You can not connect HDMI to HDTV which is not supported. Please check up the specification of HDTV before connecting it.
- For more information of the HDTV connection, see the user manual of the HDTV.

Start up image

You can select the image that is first displayed on the AMOLED monitor whenever the camera is turned on.

- Start up image : [Off], [LOGO], [User Image]
- Use a saved image for the start-up image with the [Start Image] in the [RESIZE] menu in the play mode.
- The start-up image will not be deleted by [Delete All] or [Format] menu.
- The User images will be deleted by [Reset] menu.

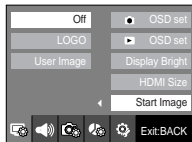

Setup menu ()

Sound Volume

You can select the sound volume levels of start sound, operation sound and shutter sound.

- Sub menus : [Off], [Low], [Medium], [High]



Operation Sound

If you set sound to [On], various sounds will be activated for camera startup, when buttons are pressed, so that you can be aware of the camera operation status.

- Sub menus : [Off], [Sound 1], [Sound 2], [Sound 3]
- If you set sound to [Off], sounds will not be activated.



Setup menu ()

Shutter sound

You can select the shutter sound.

- Sub menus : [Off], [Sound 1], [Sound 2], [Sound 3]

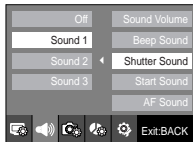

Start up sound

You can select the sound that is activated whenever the camera is turned on.

- Sub menus : [Off], [Sound 1], [Sound 2], [Sound 3]



AF sound

If you set AF sound to on, AF sound will be activated when the shutter button is pressed halfway so that you can check the operational status of the camera.

- [AF sound] sub menu : [Off], [On]



Setup menu ()

File name

This function allows the user to select the file naming format.

[Series] : New files are named using numbers that follow the previous sequence, even when a new memory card is used, or after formatting, or after deleting all pictures.

[Reset] : After using the reset function, the next file name will be set from 0001 even after formatting, deleting all or inserting a new memory card.



- The first stored folder name is 100SSCAM, and the first file name is SDC10001.
- File names are assigned sequentially from SDC10001 → SDC10002 → ~ → SDC19999.
- The folder number is assigned sequentially from 100 to 999 as follows: 100SSCAM → 101SSCAM → ~ → 999SSCAM.
- Maximum numbers of files in a folder are 9999.
- The files used with the memory card conform to the DCF (Design rule for Camera File systems) format.

Setup menu ()

Self Portrait

This feature automatically detects the location of the face and optimises the camera settings to ensure a great self portrait.

- This feature can be set by using the [Off] and [On] buttons.



Auto Focus lamp

You can turn the Auto Focus lamp on and off.

- Sub menus

[Off] : The AF lamp will not light up in a low light condition.

[On] : The AF lamp will light up in a low light condition.



Quick view

If you enable Quick View before capturing an image, you can view the image you just captured on the AMOLED monitor for the duration set in the [Quick View] setup. Quick view is possible only with still images.

- Sub menus

[Off] : The quick view function can't be activated.

[0.5, 1, 3 sec] : The captured image is briefly displayed during the selected time.

- If the shutter button is pressed during the quick view, it is cancelled.

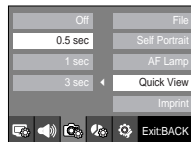

Setup menu ()

Imprinting the recording date

There is an option to include DATE / TIME on still images.

- Sub menus

[Off] : The DATE & TIME will not be imprinted on the image file.

[Date] : Only the DATE will be imprinted on the image file.

[Date&Time] : The DATE & TIME will be imprinted on the image file.



- ※ The Date & Time are imprinted at the bottom right side of the still image.
- ※ The imprint function is applied only to still photos except for the photos taken in the [TEXT] scene mode.
- ※ Depending on the manufacturer and print mode, the date printed on an image may not be printed correctly.

Setup menu ()

Copy To Card

This enables you to copy image files, movie clips and voice recording files to the memory card.

[No] : Cancels [Copy to Card].

[Yes] : All images, movie clips and voice recording files saved in the internal memory are copied to the memory card after the [Processing!] message is displayed.

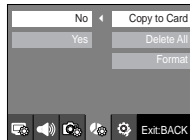

- When this menu is selected without inserting a memory card, you can select the [Copy To Card] menu but the menu can't be run.
- If there is not enough space available in the memory card to copy saved images in the internal memory (16MB), the [Copy To Card] command will copy only some of the images and display [Memory Full!] message. Then the system will return to the playback mode. Please be sure to delete any unnecessary files in the internal memory to free up space before inserting the memory card into the camera.
- When you move the images that are stored in the internal memory to the memory card, the next number of file names will be created in the card to avoid duplication of the file name.
 - When the [Reset] of the [File] setup menu is set :
The copied file names start from after the last stored file name.
 - When the [Series] of the [File] setup menu is set : The copied file names start from after the last captured file name. After completing [Copy To Card], the last stored image of the last copied folder is displayed on the AMOLED monitor.

Setup menu ()

Delete All

Of all the files stored in the memory card, the unprotected files in the DCIM subfolder will be deleted.

[No] : Cancel the [Delete All].

[Yes] : A confirmation window will be displayed. Select the [Yes] menu by pressing the smart button. A [Processing!] message appears and the unprotected files in the DCIM subfolder will be deleted.

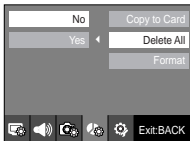

- The protected images can't be deleted.
- If there aren't any protected images, all images are deleted and a [No Image!] message will be displayed in the Play mode.

Formatting a memory

This is used for formatting the memory. If you run [Format] on the memory, all images, including the protected images, will be deleted. Be sure to download important images to your PC before formatting the memory.

- Sub menus

[No] : The memory will not be formatted.

[Yes] : A confirmation window will be displayed. Select the [Yes] menu by pressing the smart button. A [Processing!] message appears and the memory will be formatted. If you run FORMAT in Play mode, a [No Image!] message will appear.

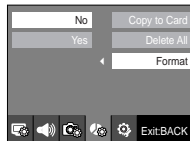

■ Be sure to run [Format] on the following types of memory card.

- A new memory card, or an unformatted memory card.
- A memory card that has a file this camera can't recognise or one that has been taken from another camera.



Always format the memory card using this camera. If you insert a memory card that has been formatted using other cameras, memory card readers, or PCs, you will get a [Card Error!] message.

Setup menu ()

Language

There is a choice of languages that can be displayed on the AMOLED monitor. Even if the battery and AC charger are removed and inserted again, the language setting will be preserved.

- LANGUAGE sub menu :

English, Korean, French, German, Spanish, Italian, S.Chinese, T.Chinese, Japanese, Russian, Portuguese, Dutch, Danish, Swedish, Finnish, Thai, Bahasa (Malay / Indonesian), Arabic, Persian, Polish, Hungarian, Czech and Turkish



Setting up the Date / Time / Date type

You can change the date and time that will be displayed on the captured images and set up the date type.

- Date type : [yy/mm/dd], [mm/dd/yy], [dd/mm/yy], [Off]

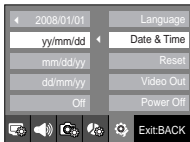

World Time

The date and time selected in the [Date&Time] serve as the date and time of your present location. Setting World Time enables you to display the local date and time on the AMOLED monitor when travelling overseas.

1. Select the [2008/01/01] menu in the [Date&Time] by using the smart button.



2. If you select [London] menu by using the smart button, move to a world time setting.



3. To set the changed summer time, select the () icon on the right side.



4. To select a city, select a desired city by using the horizontal smart button.

※ For more information about the available cities, refer to page 63.

Setup menu ()

Initialisation

All camera menu and function settings will be restored to their default values. However, values for DATE / TIME, LANGUAGE, and VIDEO OUT will not be changed.

- Sub menus

[No] : Settings will not be restored to their defaults.

[Yes] : A confirmation window will be displayed. Select the [Yes] menu by pressing the smart button. All settings will be restored to their defaults.



Selecting Video out type

The Movie output signal from the camera can be NTSC or PAL. Your choice of output will be governed by the type of device (monitor or TV, etc.) to which the camera is connected. PAL mode can support only BDGHI.

■ Connecting to an external monitor

In RECORDING / PLAY mode, you can view the stored still images or movie clips by connecting the camera to an external monitor via the AV cable. When the camera is connected to an external monitor, the AMOLED monitor will be turned off automatically.



■ Connecting to an external monitor

When using the cradle

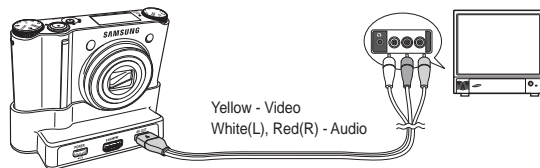

Yellow - Video
White(L), Red(R) - Audio

When the cradle is not used

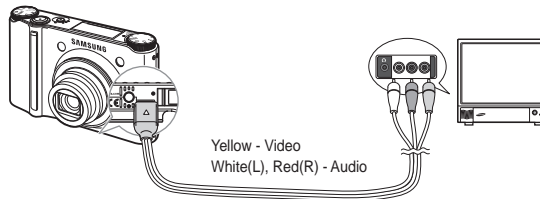

Yellow - Video
White(L), Red(R) - Audio

Setup menu ()

- NTSC : U.S.A, Canada, Japan, South Korea, Taiwan, Mexico etc.
- PAL : Australia, Austria, Belgium, China, Denmark, Finland, Germany, U.K., Holland, Italy, Kuwait, Malaysia, New Zealand, Singapore, Spain, Sweden, Switzerland, Thailand, Norway etc.
- When using a TV as an external monitor, you will need to select the external or AV channel of the TV.
- There will be a digital noise on the external monitor, but it is not a malfunction.
- If the image is not in the centre of the screen, use the TV controls to centre it.
- When the camera is connected to an external monitor, some parts of the image may not be displayed.
- When the camera is connected to an external monitor, the menu will be visible on the external monitor and the menu functions are the same as those indicated on the AMOLED monitor.
- When the camera is connected to an external monitor, the button sound may not function.

Auto power off

This function switches the camera off after a set amount of time in order to prevent unnecessary battery drainage.

- Sub menus

[Off] : [Power Off] does not work.

[1, 3, 5, 10 min] : The power will turn off automatically if not used for the period of time specified.

- After replacing the battery, the power off setting will be preserved.

- Note that the automatic power off function will not operate if the camera is in PC / Printer mode, showing a slide show, playing back a voice recording or playing back a movie file.

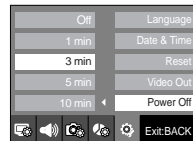

Important notes

Be sure to observe the following precautions!

- This unit contains precision electronic components. Do not use or store this unit in the following locations.
 - Areas exposed to severe changes in temperature and humidity.
 - Areas exposed to dust and dirt.
 - Areas exposed to direct sunlight or the inside of a vehicle in hot weather.
 - Environments where there is high magnetism or excessive vibration.
 - Areas with high explosives or highly flammable materials.
- Do not leave this camera in places subject to dust, chemicals (like naphthalene and mothball), high temperatures or high humidity. Keep this camera with silica gel in a hermetically sealed box when not planning to use the camera for a long period of time.
- Sand can be particularly troublesome to cameras.
 - Do not let sand get inside the camera when using it on beaches, coastal dunes, or other areas where there is lots of sand.
 - Doing so may result in failure or may render the camera permanently unusable.
- Handling the camera
 - Never drop the camera or subject it to severe shocks or vibrations.
 - Protect the large size AMOLED monitor from an impact. When this camera is not used, keep it in the camera case. You should be careful that it could be scratched easily by sand, knife, glass, coin.
 - Avoid obstructing the lens or the flash when you capture an image.
 - This camera is not waterproof. To avoid dangerous electrical shocks, never hold or operate the camera with wet hands.
 - If you use this camera in wet places, such as beach or pool, do not let water or sand get inside the camera. Doing so may result in failure or may permanently damage the unit.
- Extremes in temperature may cause problems.
 - If the camera is transferred from a cold to a warm and humid environment, condensation can form on the delicate electronic circuitry. If this seems likely, wait for at least 1 hour until all moisture is dispersed before attempting to use the camera.
Moisture built up can also occur on the memory card. If this happens, turn off the camera and remove the memory card. Wait until the moisture has dispersed.
- Caution on Using the Lens
 - If the lens is subjected to direct sunlight, it could result in the discoloration and deterioration of the image sensor.
 - Avoid getting fingerprints or foreign substances on the surface of the lens.
- If the digital camera is not used for a long period, an electric discharge can occur. It is a good idea to remove the battery and the memory card if you do not intend using the camera for an extended period of time.
- If the camera is exposed to an electronic interference, it will turn itself off to protect the memory card.

Important notes

- Camera Maintenance.
 - Use a soft brush (available from photo stores) to gently clean the lens and AMOLED assemblies. If this does not work, lens-cleaning paper with lens cleaning fluid can be used.
Clean the camera body with a soft cloth. Do not allow this camera to come into contact with solvent materials such as benzol, insecticide, thinners etc. This may damage the body shell of the camera and also affect its performance. Rough handling can damage the AMOLED monitor. Take care to avoid damage and keep the camera in a protective carrying case when not in use.
- Do not attempt to disassemble or modify the camera.
- Under certain conditions, static electricity can cause the flash unit to fire. This is not harmful to the camera and is not a malfunction.
- When images are uploaded or downloaded, the data transfer may be affected by static electricity. In this case, disconnect and re-connect the USB cable before trying the transfer again.
- Always check the condition of the camera before an important event or going on a trip.
 - Take a picture to check that the camera is working correctly and ensure you have a fully charged spare battery.
 - Samsung cannot be held responsible for camera malfunctions.
- The temperature of the surface increases if the camera is used for prolonged periods of time. This doesn't affect the camera operation and is not a problem of the camera.

Warning indicator

There are several warnings that may appear on the AMOLED display

[Memory Error!]

- Memory card error
 - Turn off the camera power and turn it on again.
 - Insert the memory card again.
 - Insert and format the memory card. (p.69)

[Card Locked!]

- The memory card is locked
 - SD/SDHC memory card : Slide the write protect switch towards the top of the memory card.

[No Card!]

- A memory card is not inserted
 - Turn off the camera power and insert the memory card again.
 - Turn off the camera power and turn it on again.

[No Image!]

- There are no images stored on the memory
 - Take images.
 - Insert a memory card that is holding some images.

[File Error!]

- File error
 - Delete the erroneous files.
- Memory card error
 - Contact a camera service centre.

Warning indicator

[Low Battery!]

- There is low battery capacity
 - Insert a fully charged battery.

[Low Light!]

- When taking pictures in dark places
 - Take pictures in Flash Photography mode.

[DCF Full Error]

- Violation of DCF format
 - Copy the images to a PC and format the memory.

Before contacting a service centre

The camera doesn't switch on

- There is low battery capacity
 - Insert a fully charged battery. (p.15)
- Battery is inserted incorrectly with the polarities reversed.
 - Insert the battery according to the polarity marks (+, -).
- The rechargeable battery is not inserted
 - Insert the battery and turn on the camera.

The camera power ceases while in use

- The battery is exhausted
 - Insert a fully charged battery.
- The Camera is turned off automatically
 - Turn on the camera power again.
- Operation has ceased in a low temperature outside of the camera usage temperature range.
 - Remove the batteries from the camera. Warm the camera and battery by placing them in your pocket and then immediately before shooting, place the battery in the camera and then shoot.

Before contacting a service centre

Camera does not take images when pressing the Shutter button

- There is insufficient memory capacity
→ Delete unnecessary image files.
- The memory card has not been formatted
→ Format the memory card. (p.69)
- The memory card is exhausted
→ Insert a new memory card.
- The memory card is locked
→ Refer to [Card Locked!] error message. (p.74)
- The camera's power is off
→ Turn the camera power on.
- The battery is exhausted
→ Insert a fully charged battery. (p.15)
- Battery is inserted incorrectly with the polarities reversed.
→ Insert the battery according to the polarity marks (+, -).

The camera suddenly stops working while in use

- The camera stopped due to a malfunction
→ Remove/re-insert battery and switch the camera on.

The images are unclear

- A picture was taken of the subject without setting an appropriate macro mode
→ Select an appropriate macro mode to take a clear image.
- Taking a picture beyond the flash range
→ Take a picture within the flash range.
- The lens is smudged or dirty
→ Clean the lens.

The flash does not fire

- Flash off mode has been selected
→ Dis-engage flash off mode.
- The camera mode can't use flash
→ Refer to the FLASH instruction. (p.32 ~ 33)

Incorrect date and time is displayed

- The date and time have been set incorrectly or the camera has adopted the default setting
→ Reset the date and time correctly.

The camera buttons do not operate

- Camera malfunction
→ Remove/re-insert battery and switch the camera on.

A card error has occurred while the memory card is in the camera

- Incorrect memory card format
→ Re-format the memory card.

The images don't play back

- Incorrect file name (Violation of DCF format)
→ Do not change the image file name.

Colour of image is different to the original scene

- White balance or effect setting is incorrect
→ Select appropriate White balance and effect.

Before contacting a service centre

Image distortion appears in the picture.

- The camera you have purchased uses a wide angle lens and this may cause image distortion. This is a special feature of the product.

Images are too bright

- Exposure is excessive
→ Reset exposure compensation.

No image on external monitor

- The external monitor has not been connected properly with the camera
→ Check the connection cables.
- There are incorrect files in the memory card
→ Insert a memory card that has correct files.

When using the PC's explorer, the [Removable Disk] file does not show

- Cable connection is incorrect
→ Check the connection.
- The camera is off
→ Turn the camera on.
- The operating system is not Windows 98SE, 2000, ME, XP, Vista / Mac OS 10.2 or later. Alternatively the PC does not support USB
→ Install Windows 98SE, 2000, ME, XP, Vista / Mac OS 10.2 or later to PC that supports USB.
- The camera driver is not installed
→ Install a [USB Storage Driver].

Specifications

Image Sensor	- Type : 1/2.3" CCD - Effective Pixel : Approx. 10.20 Mega-pixel - Total Pixel : Approx. 10.30 Mega-pixel
Lens	- Focal Length : Schneider Lens f = 4.3 ~ 15.5mm (35mm film equivalent : 24~86.5mm) - F No. : F2.8(W) ~ F5.9(T) - Digital Zoom : · Still Image mode : 1.0X ~ 5.0X · Play mode : 1.0X ~ 11.4X (depends on image size)

AMOLED Monitor - 2.5" AMOLED (230,000 pixel)

Focusing - Type : TTL auto focus (MULTI AF, CENTER AF, SELF PORTRAIT, FACE DETECTION)
- Range

Focus Type	Normal	Macro	Auto Macro
Wide (W)	40cm ~ Infinity	5cm ~ 40cm	5cm ~ Infinity
Tele (T)	80cm ~ Infinity	50cm ~ 80cm	50cm ~ Infinity

Shutter	- Speed : AUTO : 1 ~ 1/2,000 sec. MANUAL : 16 ~ 1/2,000 sec. NIGHT : 8 ~ 1/2,000 sec. FIREWORKS : 4 sec.
Exposure	- Control : AE, Manual Exposure - Metering : CENTER, SPOT, MULTI, FACE DETECTION - Compensation : ±2EV (1/3EV steps) - ISO Equivalent : Auto, 80, 100, 200, 400, 800, 1600, 3200 (image size of 3200 is fixed as 3M)

Specifications

Flash	<ul style="list-style-type: none">- Modes : RED EYE FIX, SLOW SYNC, FILL IN, RED EYE, AUTO, OFF- Range : Wide : 0.4m~5.6m, Tele : 0.5m~2.8m (ISO Auto)- Recharging Time : Approx. 5 sec.
Shake Reduction	<ul style="list-style-type: none">- Dual IS (OIS + DIS)* OIS (Optical Image Stabilization), DIS (Digital Image Stabilization)
Effect	<ul style="list-style-type: none">- Effect :<ul style="list-style-type: none">- Photo Style Selector : NORMAL, CLASSIC, CALM, COOL, RETRO, FOREST, VIVID, SOFT- Color Effect : NEGATIVE, GREEN, RED, BLUE, SEPIA, B & W- Image Adjust : CONTRAST, SATURATION, SHARPNESS- Edit :<ul style="list-style-type: none">- Image Edit : ROTATE, RESIZE, EFFECT- Color Effect : NEGATIVE, GREEN, RED, BLUE, SEPIA, B & W- Special Color : ADD NOISE, ELEGANT, SHADED, COLOR FILTER- Image Adjust : SATURATION, CONTRAST, BRIGHTNESS, ACB, RED EYE FIX
White Balance	<ul style="list-style-type: none">- Auto, Daylight, Cloudy, Fluorescent_H, Fluorescent_L, Tungsten, Custom
Voice Recording	<ul style="list-style-type: none">- Stereo- Voice Recording (Max 10 hour)- Voice Memo in Still Image (Max. 10 sec.)

Shooting	<ul style="list-style-type: none">- Still Image :<ul style="list-style-type: none">- Modes : AUTO, PROGRAM, MANUAL, DUAL IS, NIGHT, PORTRAIT, SCENE- Scene : SMILE SHOT, BLINK DETECTION, CHILDREN, LANDSCAPE, CLOSE-UP, TEXT, SUNSET, DAWN, BACKLIGHT, FIREWORKS, BEACH & SNOW, SELF-SHOT, FOOD, CAFÉ- Continuous : AEB, M. CAPTURE, HIGH SPEED, CONTINUOUS, SINGLE- Self-timer : REMOTE, DOUBLE, 2 SEC, 10 SEC- Movie Clip :<ul style="list-style-type: none">- With Audio or without Audio (Max Recording time : 25min)- Size : 1280x720, 640x480, 320x240- Frame rate : 60 FPS, 30 FPS, 15 FPS- 3.6X Optical Zoom and Mute in Zooming (Sound goes mute when operating the zoom function)- Movie Editing (Embedded) : Pause during recording, Still Image Capture, Time Trimming
Storage	<ul style="list-style-type: none">- Media<ul style="list-style-type: none">- Internal Memory : About 16MB- External Memory (Optional) : SD (up to 4GB guaranteed) SDHC Card (up to 8GB guaranteed) MMC Plus (Up to 2GB, 4bit 20MHz)* Internal Memory capacity is subject to change without prior notice.- File Format :<ul style="list-style-type: none">- Still Image : JPEG (DCF), EXIF 2.21, DPOF 1.1, PictBridge 1.0- Movie : MP4 (H.264(MPEG4.AVC))- Audio : WAV

Specifications

- Image Size and Capacity (256 MB Size)

	10 ^M	9 ^M	7 ^M	7 ^M	5 ^M	3 ^M	1 ^M
	3648x2736	3648x2432	3072x2304	3648x2056	2592x1944	2048x1536	1024x768
SUPER FINE	49	55	68	64	93	143	418
FINE	94	105	129	122	173	255	617
NORMAL	136	151	183	174	242	345	732

※ These figures are measured under Samsung's standard conditions and may vary depending on shooting conditions and camera settings.

Image Play

- Type : Single image, Thumbnails, Slide show
- * SLIDE SHOW: with selected Effect & Music by folders

Interface

- Digital output connector : USB 2.0 (30pin)
- Audio output : Mono(Internal Speaker), Stereo(Microphone)
- Video output : Stereo Output
AV: NTSC, PAL (user selectable),
HDMI 1.2 : NTSC, PAL (user selectable)
* Remarks: HDMI function is available when connected to the cradle(optional).
- DC power input connector : New 30 pin Connector, 4.2V

Power Source

- Rechargeable battery : SLB-1137D (1,100mAh)
- Adaptor : SAC-47, SUC-C4
- Cradle : SCC-NV4HD (Optional)
- * Included battery may depending on sales region.

Dimensions (WxHxD) - 98.5 x 61 x 18.95mm

Weight - 145.5g (without batteries and card)

Operating Temperature - 0 ~ 40°C

Operating Humidity - 5 ~ 85%

Software - Samsung Master, QuickTime Player 7.4, Adobe Reader

※ Specifications are subject to change without prior notice.

※ All trademarks are the property of their respective owners.

Software Notes

Please ensure that you read this instruction manual carefully before use.

- The attached software is a camera driver and image editing software tool for Windows.
- Under no circumstances should all or part of either the software or the user manual be reproduced.
- Copyrights for software are licensed only for use with a camera.
- In the unlikely event of a manufacturing fault, we will repair or exchange your camera. We cannot, however, be held responsible in any way for damage caused by inappropriate use.
- Using a Hand-made (self assembled) PC or a PC and OS that has not been guaranteed by the manufacturer is not covered by the Samsung warranty.
- Before using this manual, you should have a basic knowledge of computers and O/S (Operating Systems).

System Requirements

For Windows	For Macintosh
PC with processor better than Pentium III 450MHz (Pentium 800MHz recommended)	Power Mac G4 or later
Windows 98SE/2000/ME/XP/Vista	Mac OS 10.2 or later
250MB of available hard-disk space (1GB recommended)	250MB of available hard-disk space
Minimum 128MB RAM (512MB recommended)	Minimum 256MB RAM (256MB recommended)
USB port	USB port
CD-ROM drive	CD-ROM drive
1024x768 pixels, 16-bit color display compatible monitor (24-bit color display recommended), Microsoft DirectX 9.0 or later	

QuickTime Player 7.4 : H.264(MPEG4.AVC) playback Requirements

For Windows	For Macintosh
Intel Pentium 4, 3.2GHz or later / AMD Athlon 64FX, 2.6GHz or later	1.8GHz Power Mac G5 or 1.83 GHz Intel Core Duo or later Macintosh
Windows XP service pack2/Vista	
Minimum 512MB RAM (1GB recommended)	Minimum 256MB RAM (1GB recommended)
nVIDIA Geforce 7600GT or later / ATI X1600 series or later	64MB video card

About the software

After inserting the CD-ROM provided with this camera into the CD-ROM drive, the following window should automatically run.



Before connecting the camera to the PC, you should first install the camera driver.

- **Camera driver** : This enables images to transfer between the camera and PC.

This camera uses the USB Storage Driver as the camera driver. You can use the camera as a USB card reader. After installing the driver and connecting this camera to the PC, you can find [Removable Disk] in [Windows Explorer] or [My Computer]. A USB Storage Driver is provided only for Windows.

A USB Driver for MAC is not included with the Application CD.

You can use the camera with Mac OS 10.2 or later.

- **Samsung Master** : This is the all-in-one multi media software solution.

You can download, view, edit and save your digital images and movie files with this software. It does not support H.264(MPEG4.AVC) movie clip. This software is only compatible with Windows.

- **QuickTime Player 7.4** : The movie viewing program

QuickTime Player is a movie viewing program and is provided for the Windows OS only.



- Be sure to check the system requirements before installing the driver.
- You should allow 5 - 10 seconds for running the automatic setup program according to the capability of your computer. If the frame does not show, run the [Windows Explorer] and select [Installer.exe] in the CD-ROM Drive.
- PDF documents of user manual are included in the Software CD-ROM supplied with this camera. Search the PDF files with Windows explorer. Before opening the PDF files, you must install the Acrobat Reader included in the Software CD-ROM.
- To install the Adobe Reader 6.0.1 correctly, Internet Explorer 5.01 or later had to be installed. Visit "www.microsoft.com" and upgrade the Internet Explorer.

Setting up the application software

To use this camera with a PC, install the application software first. After this has been done, the stored images in the camera can be moved to the PC and can be edited by an image editing program.

- You can visit the Samsung web-site through the internet.

<http://www.samsungcamera.com> : English

<http://www.samsungcamera.co.kr> : Korean

1. The auto run frame will be displayed.
Click the [Samsung Digital Camera Installer] menu in the Auto run frame.



2. Install the camera driver and DirectX by selecting a button shown on the monitor. If a latest version of DirectX was installed on your computer, DirectX may not be installed.

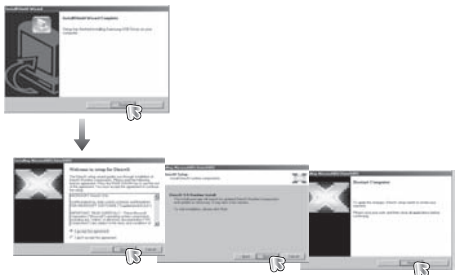

3. Install the Samsung Master in the order shown.



Setting up the application software

4. Install the QuickTime Player 7.4 in the order shown.

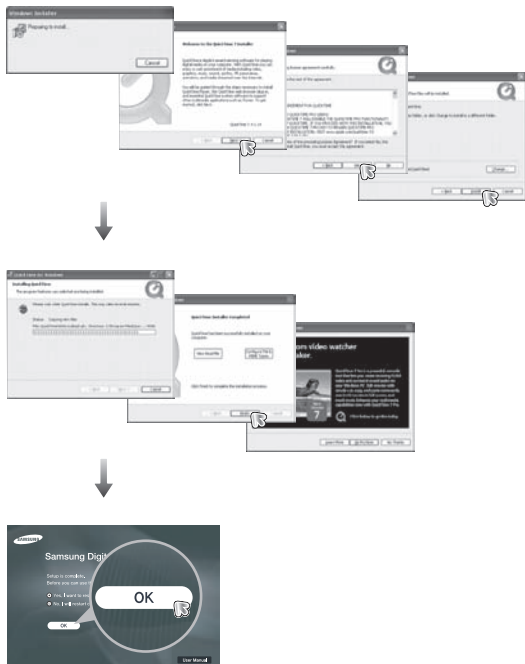

5. After restarting the computer, connect the PC to the camera with the USB cable.

6. Turn on the camera power. The [Found New Hardware Wizard] will open and the computer will recognise the camera.

※ If your OS is Windows XP / Vista, an image viewer program will open. If the download window of Samsung Master opens after starting Samsung Master, the camera driver was set up successfully.



- If you have installed the camera driver, The [Found New Hardware Wizard] may not open.
- On a Windows 98SE system, the Found New Hardware Wizard dialog box opens and a window asking you to select a driver file may appear. In this case, specify "USB Driver" in the CD supplied.

※ QuickTime Player 7.4 cannot be installed under Window 2000.

Starting PC mode

- In this mode, you can download stored images to your PC through the USB cable.
- The AMOLED monitor is always turned off in PC mode.

■ Connecting the camera to a PC

1. Connect the PC to the camera with the USB cable.
2. Select the [USB]-[Computer] menu by using the smart button.

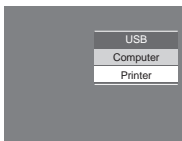

■ Connecting the camera to a PC

When using the cradle

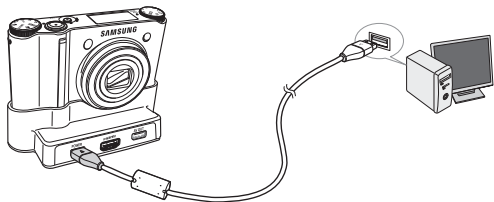

When the cradle is not used

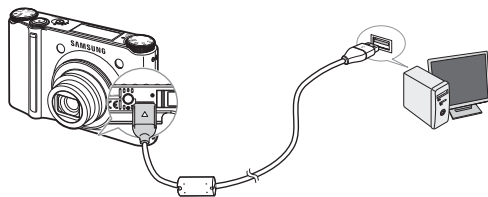

※ If you selected [Printer] in Step 2, when you connect the camera to your printer, the [Connecting Printer] message will display and the connection will not be established. In this case, disconnect the USB cable, and then follow the procedure from Step 1 and onward.

- Disconnecting the camera and PC : Refer to page 86 (Removing the removable disk).



- Before inserting any cables or AC adapter, check the directions and do not insert by force. It may damage the cable or camera.

Using Removable Disk

■ Downloading stored images

You can download the still images stored on the camera to your PC's hard disk and print them or use a photo editing software to edit them.

1. Connect the camera to your PC with the USB cable.

2. On your computer's desktop display, select [My computer] and double click [Removable Disk → DCIM → 100SSCAM].
The image files will then be displayed.



3. Select an image and press the right mouse button.



4. A pop-up menu will open.
Click the [Cut] or [Copy] menu.
- [Cut] : cuts selected files.
- [Copy] : copies selected files.



5. Click a folder where you want to paste the file.

6. Press the right mouse button and a pop-up menu will open. Click [Paste].

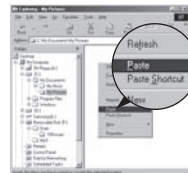

7. An image file is transferred from the camera to your PC.



- By using [Samsung Master], you can see the stored images in the memory directly on the PC monitor and you can copy or move the image files.



- We recommend that you should copy the images to the PC to view them. Opening images directly from the removable disk may be subject to unexpected disconnection.
- When you upload a file that is not taken by this camera to the Removable Disk, the [File Error!] message will be displayed on the AMOLED monitor in the PLAY mode, and nothing is displayed in Thumbnail mode.

Removing the removable disk

■ Windows 98SE

1. Check whether the camera and PC are transferring a file.
If the camera status lamp blinks, please wait until the lamp has finished blinking and is constantly on.
2. Unplug the USB cable.

■ Windows 2000/ME/XP/Vista

(The illustrations may differ from those shown depending on the Windows O/S.)

1. Check whether the camera and PC are transferring a file.
If the camera status lamp blinks, please wait until the lamp has finished blinking and is constantly on.

2. Double-click the [Unplug or Eject Hardware] icon on the task bar.



[Double-click!]

3. The [Unplug or Eject Hardware] window will open. Select the [USB Mass Storage Device] and click the [Stop] button.



4. The [Stop a Hardware device] window will open. Select the [USB Mass Storage Device] and click the [OK] button.

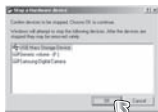

5. A [Safe to Remove Hardware] window will open. Click the [OK] button.



6. A [Unplug or Eject Hardware] window will open. Click the [Close] button and the removable disk may be safely removed.



7. Unplug the USB cable.

Setting up the USB Driver for MAC

1. A USB Driver for MAC is not included with the software CD as MAC OS supports the camera driver.
2. Check the MAC OS version during start-up. This camera is compatible with MAC OS 10.2 or later.
3. Connect the camera to the Macintosh and turn the camera power on.
4. A new icon will be displayed on the desktop after connecting the camera to the MAC.

Using the USB Driver for MAC

1. Double click a new icon on the desktop and the folder in the memory will be displayed.
2. Select an image file and copy or move it to MAC.



- For Mac OS 10.1 or later : First complete uploading from computer to camera and then remove the removable disk with the Extract command.

Removing the USB Driver for Windows 98SE

To remove the USB driver, refer to the process shown below.

1. Connect the camera to your PC and turn them on.
2. Check whether the Removable Disk is on the [My Computer].
3. Remove the [Samsung Digital Camera] on the Device manager.



4. Disconnect the USB cable.
5. Remove the [Samsung USB Driver] on the Add / Remove Programs Properties.

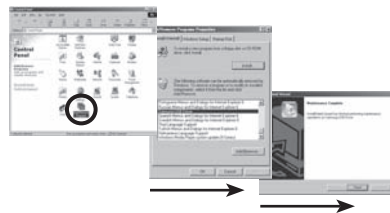

6. Uninstallation is complete.

Samsung Master

You can download, view, edit and save your images and movies with this software. It does not support H.264(MPEG4.AVC) movie clip.

This software is only compatible with Windows.

To start the program, click [Start → Programs → Samsung → Samsung Master → Samsung Master].

■ Downloading images

1. Connect the camera to your PC.

2. A window for downloading images will be displayed after connecting the camera to your PC.

- To download the captured images, select the [Select All] button.

- Select desired folder in the window and click the [Select All] button. You can save captured images and selected folders.

- If you click the [Cancel] button, downloading will be cancelled.

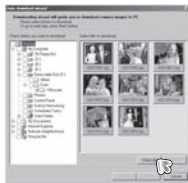

3. Click [Next >] button.



4. Select a destination and make a folder to save downloaded images and folders.

- Folder names can be made in order of date and images will be downloaded.

- Folder name will be made as you want and images will be downloaded.

- After selecting an existing folder, images will be downloaded.



5. Click [Next >] button.

6. A window will open as shown to the right.

The destination of the selected folder will be displayed on the upper side of the window. Click the [Start] button to download the images.



7. Downloaded images will be displayed.



Samsung Master

Image viewer : You can view the stored images.

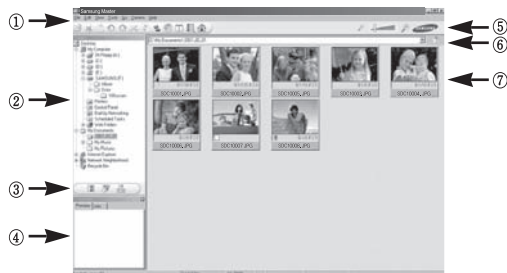

- Image viewer functions are listed below.

- ① Menu bar : You can select menus.
File, Edit, View, Tools, Change functions, Auto download, help, etc.
- ② Image selection window : You can select the desired images in this window.
- ③ Media type selection menu : You can select image viewer, image edit and movie edit functions in this menu.
- ④ Preview window : You can preview an image or a movie clip and check the multi media information.
- ⑤ Zoom bar : You can change preview size.
- ⑥ Folder display window : You can see the folder location of the selected image.
- ⑦ Image display window : Images in the selected folder are displayed.

※ Refer to the [Help] menu in Samsung Master for further information.

Image edit : You can edit the still image.

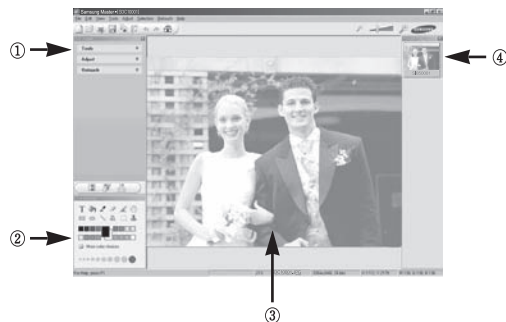

- Image edit functions are listed below.

- ① Edit menu : You can select the following menus.
 - [Tools] : You can resize or crop the selected image. See the [Help] menu.
 - [Adjust] : You can modify image quality. See the [Help] menu.
 - [Retouch] : You can change image or insert effects on the image. See the [Help] menu.
- ② Drawing tools : Tools for editing an image.
- ③ Image display window : A selected image displays in this window.
- ④ Preview window : You can preview the changed image.

※ A still image edited with Samsung Master can't be played back on the camera.

※ Refer to the [Help] menu in Samsung Master for further information.

Samsung Master

Movie edit : You can get the still image, movie clip, narration, music files together in a movie clip.



- ※ Some movie clips that were compressed with a codec that is not compatible with the Samsung Master can't play back in the Samsung Master.
- ※ Refer to the [Help] menu in Samsung Master for further information.
- ※ Samsung Master does not support the playback and editing for the H.264(MPEG4.AVC) movie clip.

- Movie clip edit functions are listed below.

① Edit menu : You can select the following menus.

[Add Media] : You can add other media elements to a movie.

[Edit Clip] : You can change the brightness, contrast, colour and saturation.

[Effects] : You can insert an effect.

[Set Text] : You can insert texts.

[Narrate] : You can insert a narration.

[Produce] : You can save the edited multi media as a new file name.
You can select AVI, Windows media (wmv) and Windows media (asf) file types.

② Frame display window : You can insert multi media in this window.

FAQ

■ Please check the following if the USB connection malfunctions.

Case 1 USB cable is not connected or it is not the supplied USB cable.
→ Connect the supplied USB cable.

Case 2 The camera is not recognised by your PC.
Sometimes, the camera may appear under [Unknown Devices] in Device Manager.
→ Install the camera driver correctly.
Turn off the camera, remove the USB cable, plug in the USB cable again, and then turn on the camera.

Case 3 There is an unexpected error during file transfer.
→ Turn the camera power off and on again. Transfer the file again.

Case 4 When using a USB hub.
→ There may be a problem in connecting the camera to the PC through a USB hub if the PC and the hub are not compatible. Wherever possible, connect the camera directly to the PC.

Case 5 Are other USB cables connected to the PC?
→ The camera may malfunction when it is connected to the PC at the same time as another USB cable. In this case, disconnect the other USB cable, and only connect the camera USB cable to the PC.

Case 6 When I open the Device Manager (by clicking Start → (Settings) → Control Panel → (Performance and Maintenance) → System → (Hardware) → Device Manager), there are Unknown Devices or Other Devices entries with a yellow question mark (?) beside them or devices with an exclamation mark (!) beside them.
→ Right-click on the entry with the question (?) or exclamation (!) mark and select "Remove". Restart the PC and connect the camera again. For Windows 98SE PC, remove the camera driver, restart the PC, and then reinstall the camera driver.

Case 7 In some security programs (Norton Anti Virus, V3, etc.), the computer may not recognise the camera as a removable disk.
→ Stop the security programs and connect the camera to the computer. Refer to the security program instructions about how to temporarily disable the program.

Case 8 The camera is connected to the USB port located on the front of the computer.
→ When the camera is connected to the USB port located on the front of the computer, the computer may not recognise the camera. Connect the camera to the USB port located on the back of the computer.

FAQ

- When you can not playback the recorded movie clip on your computer.

- ※ When you can not playback the recorded movie clip on your computer, it is mostly caused by the video codec installed on the computer.

[How to playback the H.264(MPEG4.AVC) movie clips]

- Using the QuickTime Player 7.4

Install the "QuickTime Player 7.4" provided in the CD.

(The QuickTime Player 7.4 supports the H.264(MPEG4.AVC) compression for videos.)

→ Plays back using the "QuickTime Player 7.4".

- How to use with installing United Codec

We recommend that install the latest United Codec. (Recommendable Codec : K-Lite Codec Pack Full latest version)

→ Plays back using the "video player."

(When installed K-lite codec with its full version, the Media Player Classic or Window Media Player 11 is recommended)

- ※ "QuickTime Player 7.4", "K-lite United Codec full version" should be installed in Windows ServicePack2 or later.

- ※ Although the computer is guaranteed as operated, the playback might be intermittent depending on an user's computer.

- If a PC (Windows 98SE) repeatedly stops responding while the camera and PC are connected.

→ If a PC (Windows 98SE) is turned on for a long time and the camera has to be repeatedly re-connected, the PC may not recognise the camera. In this case, restart the PC.

- If a PC connected with the camera stops responding while Windows is starting.

→ In this case, disconnect the PC and the camera and Windows will start.

If the problem happens repeatedly, set the Legacy USB Support to disable and re-start the PC. The Legacy USB Support is in the BIOS setup menu. (The BIOS setup menu differs from the PC manufacturers and some BIOS menus don't have Legacy USB Support) If you can't change the menu by yourself, contact to the PC manufacturer or BIOS manufacturer.

- If the movie clip can't be deleted, or if a removable disk can't be extracted or if an error message displays during the file transfer.

→ If you install only the Samsung Master, the problems mentioned above may occur.

- Close the Samsung Master program by clicking the Samsung Master icon on the Taskbar.

- Install all the application programs included in the software CD.

- When the screen ratio of movie player does not meet with monitor.

→ If the resolution of monitor is smaller than the resolution of recorded movie clip, the screen ratio of movie player may not meet with monitor. Using the menu of movie player, you can adjust the screen ratio.

Correct Disposal of This Product



Correct Disposal of This Product (Waste Electrical & Electronic Equipment)

(Applicable in the European Union and other European countries with separate collection systems) This marking shown on the product or its literature, indicates that it should not be disposed with other household wastes at the end of its working life.

To prevent possible harm to the environment or human health from uncontrolled waste disposal, please separate this from other types of wastes and recycle it responsibly to promote the sustainable reuse of material resources. Household users should contact either the retailer where they purchased this product, or their local government office, for details of where and how they can take this item for environmentally safe recycling. Business users should contact their supplier and check the terms and conditions of the purchase contract.

This product should not be mixed with other commercial wastes for disposal.



Samsung Techwin cares for the environment at all product manufacturing stages to preserve the environment, and is taking a number of steps to provide customers with more environment-friendly products. The Eco mark represents Samsung Techwin's will to create environment-friendly products, and indicates that the product satisfies the EU RoHS Directive.

FCC notice

■ NOTE :

This equipment has been tested and found to comply with the limits for a Class B digital device, pursuant to part 15 of the FCC Rules. These limits are designed to provide reasonable protection against harmful interference in a residential installation.

This equipment generates, uses and can radiate radio frequency energy and, if not installed and used in accordance with the instructions, may cause harmful interference to radio communications. However, there is no guarantee that interference will not occur in a particular installation. If this equipment does cause harmful interference to radio or television reception, which can be determined by turning the equipment off and on, the user is encouraged to try to correct the interference by one or more of the following measures:

- Reorientate, or relocate, the receiving antenna.
- Increase the distance between the equipment and receiver.
- Connect the equipment into an outlet on a circuit different from that to which the receiver is connected.
- Consult the dealer or an experienced radio / TV technician for help.

■ CAUTION :

Changes or modifications not expressly approved by the manufacturer responsible for compliance could void the user's authority to operate the equipment.

■ Declaration of Conformity

Trade Name : SAMSUNG TECHWIN
Model No. : Samsung NV24HD
Responsible Party : SAMSUNG ELECTRONICS AMERICA INC.
Address : 105 Challenger Road Ridgefield Park NJ
Telephone No. : 1-800-SAMSUNG(726-7864)

This device complies with Part 15 of the FCC Rules. Operation is subject to the following two conditions: (1) This device may not cause harmful interference, and (2) this device must accept any interference received, including interference that may cause undesired operation.

Correct disposal of batteries in this product



(Applicable in the European Union and other European countries with separate battery return systems.)

This marking on the battery, manual or packaging indicates that the batteries in this product should not be disposed of with other household waste at the end of their working life. Where marked, the chemical symbols Hg, Cd or Pb indicate that the battery contains mercury, cadmium or lead above the reference levels in EC Directive 2006/66. If batteries are not properly disposed of, these substances can cause harm to human health or the environment.

To protect natural resources and to promote material reuse, please separate batteries from other types of waste and recycle them through your local, free battery return system.

The rechargeable battery incorporated in this product is not user replaceable. For information on its replacement, please contact your service provider.

MEMO



Please refer to the warranty that came with the product you purchased,
or go to our website <http://www.samsungcamera.com/> for after-sales service or inquiries.

Internet address - <http://www.samsungcamera.com>



The CE Mark is a Directive conformity
mark of the European Community (EC)