

SAMSUNG

Sensory
Pleasure



NV3 User's Manual

Thank you for buying a Samsung Camera.

This manual will guide you through using the camera, including capturing images, downloading images and using the application software.

Please read this manual carefully before using your new camera.

ENGLISH

• Instructions

- Use this camera in the following order

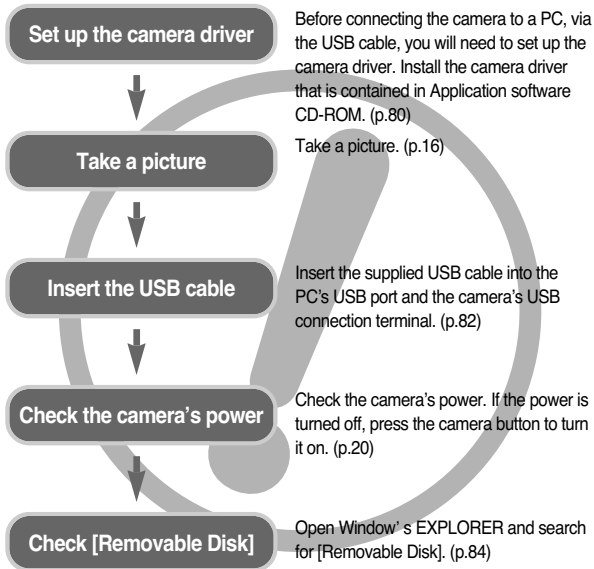

- If you use a card reader to copy the images on the memory card to your PC, the images could be damaged. When transferring the images taken with the camera to your PC, be sure to use the supplied USB cable to connect the camera to your PC. Please note that the manufacturer holds no responsibility for loss or damage of images on the memory card due to the use of a card reader.

• Getting to know your camera

Thank you for buying a Samsung Digital Camera.

- Prior to using this camera, please read this user manual thoroughly.
 - When you require After Sales service, please bring the camera and the cause of the camera malfunction (such as battery, Memory card etc.) to the A/S centre.
 - Please check that the camera is operating properly long before you intend to use it (e.g. for a trip or an important event) to avoid disappointment. Samsung camera takes no responsibility for any loss or damages that may result from camera malfunction.
 - Keep this manual in a safe place.
 - Specifications are subject to change without prior notice.
- * Microsoft, Windows and Windows logo are registered trademarks of Microsoft Corporation incorporated in the United States and/or other countries.
- * All brand and product names appearing in this manual are registered trademarks of their respective companies.



Samsung Techwin cares for the environment at all product manufacturing stages to preserve the environment, and is taking a number of steps to provide customers with more environment-friendly products. The Eco mark represents Samsung Techwin's will to create environment-friendly products, and indicates that the product satisfies the EU RoHS Directive.

• DANGER

DANGER indicates an imminently hazardous situation which, if not avoided, will result in death or serious injury.

- Do not attempt to modify this camera in any way. This may result in fire, injury, electric shock or severe damage to you or your camera. Internal inspection, maintenance and repairs should be carried out by your dealer or Samsung Camera Service centre.
- Please do not use this product in close proximity to flammable or explosive gases, as this could increase the risk of explosion.
- Should any form of liquid or a foreign object enter the camera, do not use it. Switch off the camera, and then disconnect the power source. You must contact your dealer or Samsung Camera Service centre. Do not continue to use the camera as this may cause a fire or electric shock.
- Do not insert or drop metallic or inflammable foreign objects into the camera through access points e.g. the memory card slot and battery chamber. This may cause a fire or electric shock.
- Do not operate this camera with wet hands. This could pose a risk of electric shock.

• WARNING

WARNING indicates a potentially hazardous situation which, if not avoided, could result in death or serious injury.

- Do not use the flash in close proximity to people or animals. Positioning the flash too close to your subject's eyes may cause eyesight damage.
- For safety reasons keep this product and accessories out of reach of children or animals to prevent accidents e.g.:
 - Swallowing battery or small camera accessories. If an accident should occur, please consult a doctor immediately.
 - There is the possibility of injury from the camera's moving parts.
- Battery and camera may become hot during prolonged use and it may result in camera malfunction. Should this be the case, allow the camera to sit idle for a few minutes to allow it time to cool.
- Do not leave this camera in places subject to extremely high temperatures, such as a sealed vehicle, direct sunlight or other places of extreme variances in temperature. Exposure to extreme temperatures may adversely affect the camera's internal components and could cause a fire.
- When in use, do not cover the camera or AC Charger. This may cause heat to build up and distort the camera body or cause a fire. Always use the camera and its accessories in a well-ventilated area.

CAUTION

CAUTION indicates a potentially hazardous situation which, if not avoided, may result in a minor or moderate injury.

- Leaking, overheating, or burst battery could result in fire or injury.
 - Use battery with the correct specification for the camera.
 - Do not short circuit, heat or dispose of battery in a fire.
 - Do not insert the battery with the polarities reversed.
- Remove the battery when not planning to use the camera for a long period of time. Battery may leak corrosive electrolyte and permanently damage the camera's components.
- Do not fire the flash while it is in contact with hands or objects. Do not touch the flash after using it continuously. It may cause burns.
- If you are using the AC Charger to drive the camera, do not move the camera while it is switched on.

After use, always switch off the camera before unplugging the cable from the wall socket. Then make sure that any connector cords or cables to other devices are disconnected before moving the camera. Failure to do so may damage the cords or cables and cause a fire or electric shock.
- Take care not to touch the lens or the lens cover to avoid taking an unclear image or causing a camera malfunction.
- Avoid obstructing the lens or the flash when you capture an image.
- Low temperatures can affect the performance of the LCD monitor and you may experience the following problems. (These problems will usually disappear at normal operating temperatures and are perfectly normal.)
 - The time of power on can be delayed and the colour of LCD monitor can be changed slightly.
 - Fast movement, when pointing the camera at the subject, can make an after-image appear on the LCD monitor.
- Credit cards may be demagnetized if left near case. Avoid leaving magnetic strip cards near the case.

Contents

READY

● System chart	5
● Identification of features	6
■ Front & Top	6
■ Back & Bottom	7
■ Bottom/ 5-function button	8
■ Cradle (optional)	8
■ Self-timer lamp	9
■ Camera Status Lamp	9
■ Mode icon	9
● Connecting to a Power Source	9
● Inserting the memory card	12
● Instructions on how to use the memory card	12
● When Using the Camera for the First Time	14

RECORDING

● LCD monitor indicator	15
● Starting the recording mode	16
■ How to use the Auto mode	16
■ How to use the Program mode	16
■ How to use the ASR (Advanced Shake Reduction) mode	17
■ Wise Shot	17
■ How to use the Scene modes	18
■ How to use the Movie clip mode	18
■ Recording the movie clip without voice	19

■ Pausing while recording a movie clip	19
■ How to use the VOICE RECORDING mode	19
■ Pausing while recording a voice	19
● Things to watch out for when taking pictures	20
● Using the camera buttons to set the camera	20
■ POWER button	20
■ SHUTTER button	20
● ZOOM W/ T button	21
● Voice recording / Voice memo / UP button	22
● Macro/ Down button	23
● Focus lock	24
● Flash / Left button	24
● Self-timer / Right button	26
● MENU/ OK button	27
● +/- button	27
● E (Effect) button	31
■ Colour	31
■ Preset focus frames	32
■ Composite shooting	33
■ Photo Frame	34
■ Movie Clip frame stabiliser	34
● Using the LCD monitor to adjust the camera settings	35
● How to use the menu	35
● Size	36
● Quality/ Frame rate	36

Contents

- Metering37
- Continuous shot37
- Sharpness38
- Auto Focus type38
- OSD(On Screen Display) information39
- Deleting images50
- Resize50
- Rotating an image51
- DPOF51
- DPOF : STANDARD52
- DPOF : Index52
- DPOF : Print size53
- On Screen Display information53
- Copy To Card54
- PictBridge54
- PictBridge : Picture Selection55
- PictBridge : Print Setting56
- PictBridge : Reset56

PLAY

- Starting play mode40
 - Playing back a still image40
 - Playing back a movie clip40
 - Movie clip capture function40
 - On camera movie trimming41
 - Playing back a recorded voice41
- LCD monitor indicator42
- Using the camera buttons to adjust the camera42
 - Play mode button42
- Thumbnail / Enlargement button/ Volume button43
- Voice memo/ Up button44
- Play & Pause / Down button45
- Left/ Right/ Menu/ OK button45
- E (Effect) button46
- Delete button46
- Printer button46
- Setting up the play back function using the LCD monitor47
- Starting the slide show48
- Protecting images49
- Setup menu57
 - File name58
 - Auto power off58
 - Language58
 - Format59
 - Setting up the Date/ Time/ Date type59
 - Imprinting the recording date59
 - Sound60
 - Connecting an External Device (USB)60
 - AF Sound60
 - Auto Focus lamp60
 - LCD brightness61
 - Selecting Video out type61
 - Quick view62

SETUP

- Initialisation62
- Setting up the Mycam menu62
- Start up image63
- Start up sound63
- Shutter sound63
- Display setting72
- Setting up the recording function in the MP3 mode72
- Auto Scroll72
- MP3 BGM Setting72
- Language setting72
- Important notes73
- Warning indicator74
- Before contacting a service centre75
- Specification76

MP3 / PMP / TEXT VIEWER MODE

- MP3 / PMP / TEXT VIEWER mode63
- Downloading files63
- Starting the MP3 / PMP / TEXT VIEWER mode64
- LCD monitor indicator for MP3/ PMP/ TEXT VIEWER mode66
- Using the camera buttons to adjust the camera67
 - Volume button67
 - Play & Pause/ Control button67
 - Delete button67
 - Hold / Equalizer button68
 - Playlist button68
- Setting up the play back function using the LCD monitor69
 - Resume70
 - Play mode70
 - Skin of MP3 player70
 - Delete all71
 - Setting slide show interval71
 - Playing back the slide show71
 - Frame search71
- Software Notes79
- System Requirements79
- About the software79
- Setting up the application software80
- Starting PC mode82
- Removable Disk83
- Removing the removable disk84
- Setting up the USB Driver for MAC85
- Using the USB Driver for MAC85
- Removing the USB Driver for Windows 98SE85
- Digimax Converter86
- Digimax Master87
- FAQ90

SOFTWARE

System chart

Please check that you have the correct contents before using this product. The contents can vary depending on the sales region. To buy the optional equipment, contact your nearest Samsung dealer or Samsung service centre.

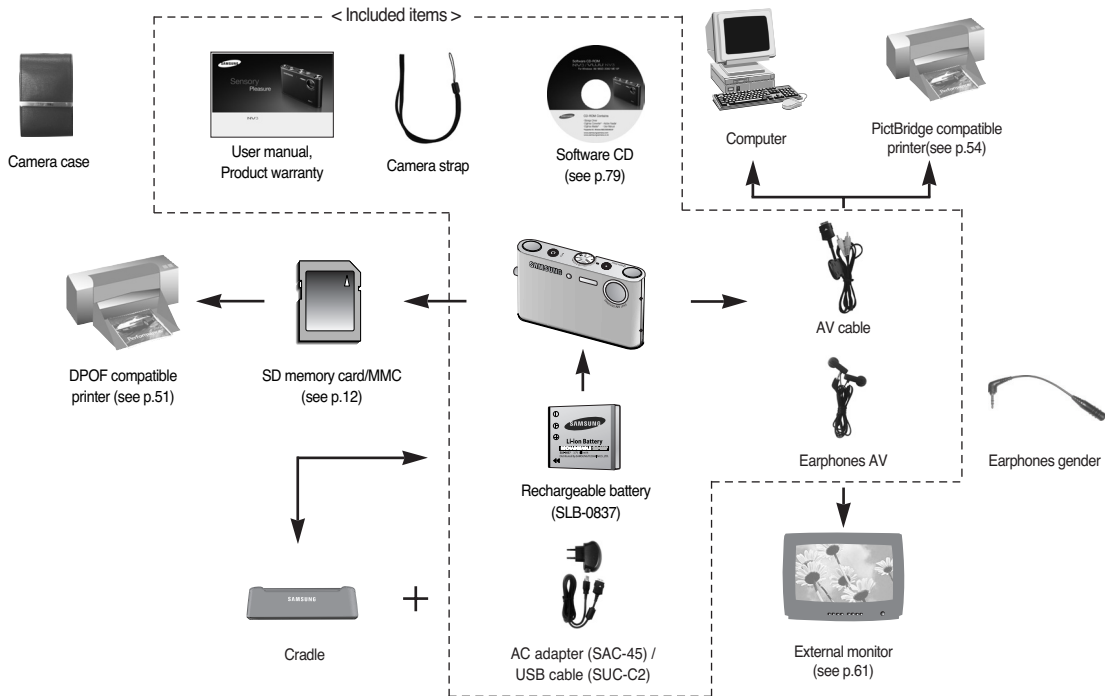

• Identification of features

Front & Top

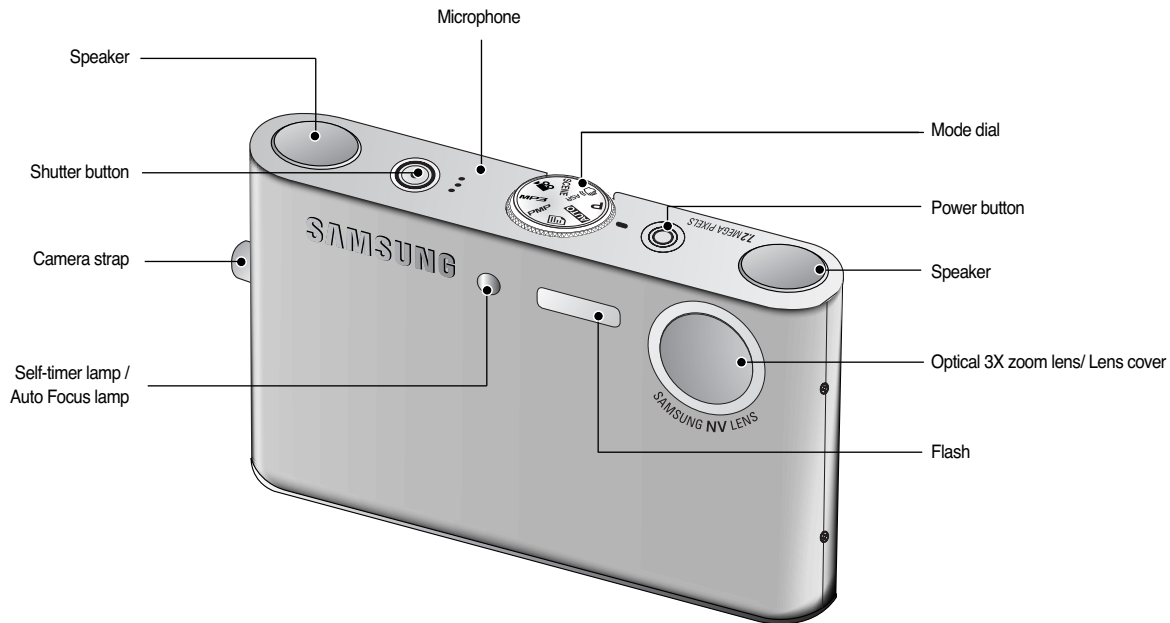

• Identification of features

Back & Bottom

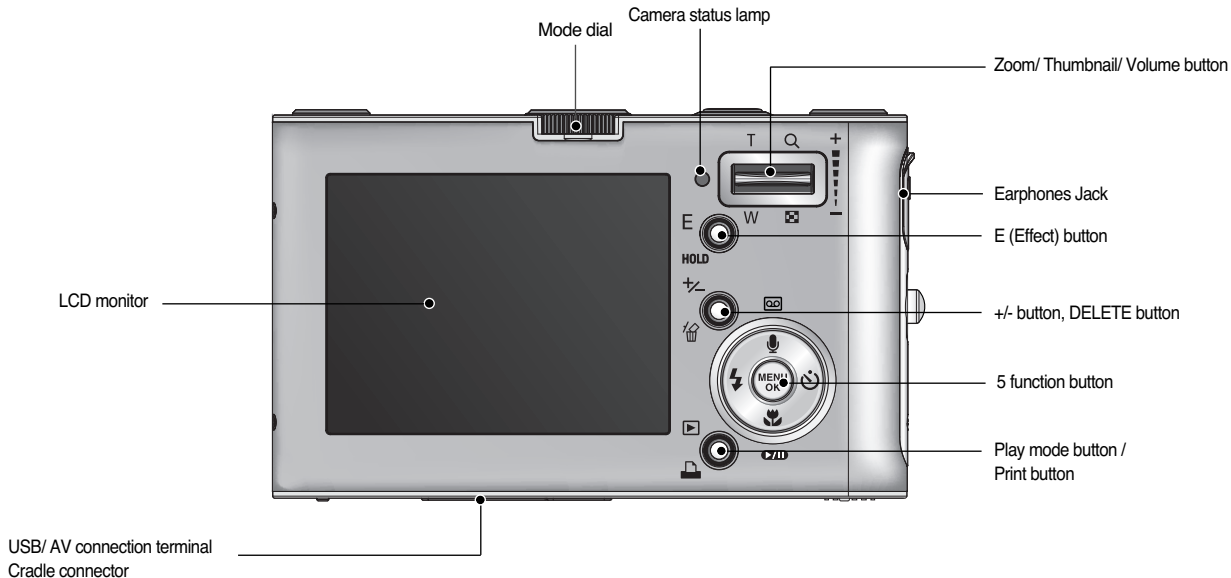

• Identification of features

Bottom/ 5-function button

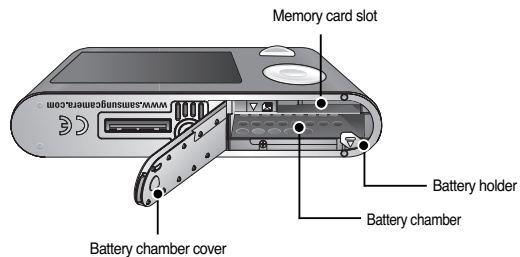

Voice memo / Voice Recording / UP button

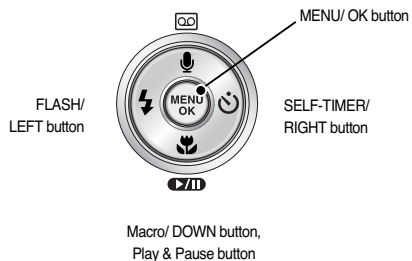

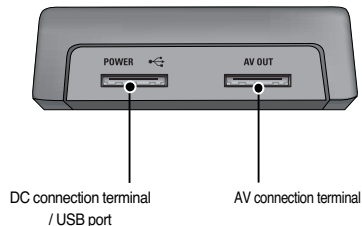
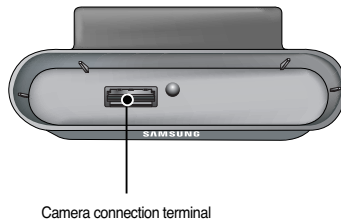

Cradle(Optional)

- You can recharge your rechargeable battery, transfer a captured image to print, and download images with the cradle. (Refer to pages 11, 54, 83)



• Identification of features





















■ Self-timer lamp

Icon	Status	Description
	Blinking	For 2 seconds the lamp blinks quickly at 0.25-second intervals.
	Blinking	For the first 8 seconds, the lamp blinks at 1 second intervals. For the final 2 seconds, the lamp blinks quickly at 0.25-second intervals.
	Blinking	A picture will be taken after about 10 seconds and 2 seconds later a second picture will be taken.

■ Camera Status Lamp

Status	Description
Power on	The lamp turns on; when the camera is ready to take a picture the lamp turns off.
After taking a picture	The lamp blinks while saving the image data and then turns off when the camera is ready to take another picture
USB cable is connected to a PC	The lamp lights up (LCD monitor turns off after initializing the device)
Transmitting Data to a PC	The lamp blinks (LCD monitor turns off)
USB cable is connected to a printer	The lamp lights up
When the printer is printing	The lamp blinks

■ Mode icon : Refer to page 16 for more information about the camera mode setting.

MODE	VOICE RECORDING	MP3	PMP	TEXT VIEWER	MOVIE	AUTO	PROGRAM	ASR	PLAY
Icon									
MODE	SCENE								
	NIGHT	PORTRAIT	CHILDREN	LANDSCAPE	CLOSE UP	TEXT			
Icon									
MODE	SUNSET	DAWN	BACKLIGHT	FIREWORKS	BEACH & SNOW	-			
Icon						-			

• Connecting to a Power Source

- You should use the rechargeable battery (SLB-0837) supplied with the camera. Be sure to charge the battery before using the camera.
- SLB-0837 rechargeable battery Specification

Model	SLB-0837
Type	Lithium Ion
Capacity	860mAh
Voltage	3.7V
Charging time (When the camera is turned off)	Approx. 150 MIN

• Connecting to a Power Source

- Number of images and battery life : Using the SLB-0837

	Battery life / Number of images	Based on the following shooting conditions
Still image	Approx. 100 MIN / About 200 shots	Using the fully charged battery, Auto mode, 7M image size, Fine image quality, Shot to shot interval : 30Sec. Changing the zoom position between the Wide and the Tele after every shot. Using the flash on every second shot. Using the camera for 5 minutes and then Powering it off for 1 minute.
Movie	Approx. 90 MIN	Using the fully charged battery 640X480 image size/ 30fps frame rate
MP3	Approx. 240 MIN	Using the fully charged battery LCD Off.
PMP	Approx. 135 MIN	Using the fully charged battery

※ These figures are measured under Samsung's standard conditions and shooting conditions and may vary depending on the user's methods.

- You can charge the rechargeable battery (SLB-0837) by using the SAC-45 KIT which consists of the AC adapter (SAC-45) and the USB cable (SUC-C2). When the SAC-45 and SUC-C2 are combined, they can be used as an AC cable.

- Using an AC cable
: Connect the AC adapter to the USB cable. It can be used as a power cable.

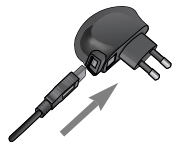

- Using a USB cable
: Remove the AC adapter (SAC-45). You can download stored images to your PC (p.83) or supply the power to your camera through the USB cable.

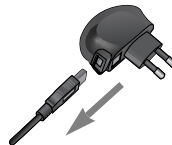

INFORMATION

Important information about battery usage.

- When the camera is not used, turn off the camera power.
- Please remove the battery if the camera will not be used for long periods.
Batteries can lose power over time and are prone to leaking if kept inside the camera.
- Low temperatures (below 0°C) can affect the performance of the battery and you may experience reduced battery life.
- Batteries will usually recover at normal temperatures.
- During extended use of the camera, the camera body may become warm.
This is perfectly normal.
- When you use earphones, do not remove the battery while the camera is turning on. It may generate a loud noise.

CAUTION

Important information about USB cable usage.

- Use a USB cable (SUC-C2) with the correct specification.
- If the camera is connected to the PC through a USB hub :
connect the camera directly to the PC.
- If the camera and other devices are connected to the PC at the same time :
remove other device.
- If the USB cable is connected to a port located on the front of the PC :
remove the cable and connect it to a port located on the back of the PC.
- If the USB port of the PC doesn't meet the Power output standard (5V, 500mA), the camera may not be charged.

• Connecting to a Power Source

- You can charge the rechargeable battery (SLB-0837) by using the cradle.
- How to charge the rechargeable battery (SLB-0837)
 - Charging with the cradle

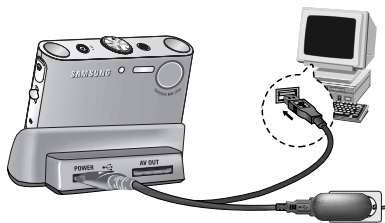

- Charging with the camera

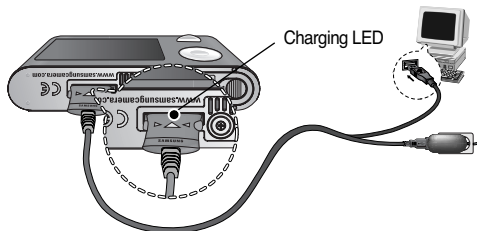

CAUTION

- Before inserting any cables or AC adapter, check the directions and do not insert by force. It may cause breakage of cable or camera.
- If the charging LED of the AC Charger does not turn on or blink after inserting the rechargeable battery, please check whether the battery is inserted correctly.
- If you charge the battery with the camera power on, the battery can't charge fully. Turn the camera off while charging the battery.

- Charging LED of the AC Adapter

	Charging LED
Being Charged	Red LED is on
Charging is complete	Green LED is on
Charging error	Red LED is off or blinking
Being discharged (Using the AC adapter)	Orange coloured LED is on

- If you insert the fully discharged battery to charge it, do not turn on the camera at the same time. The camera may not be turned on because of the low battery capacity. Charge the battery for more than 10 minutes before using the camera.
- Do not use the flash frequently or take a movie clip with the fully discharged battery charged for a short time. Even if the charger is inserted, the camera power may be turned off because the rechargeable battery is discharged again.
- When you charge the battery with the cradle, you only can use Lithium Ion battery pack (SLB-0837).

Connecting to a Power Source

- Insert the battery as shown
 - If the camera does not turn on after you have inserted battery, please check whether the battery is inserted with the correct polarity (+ / -).
 - When the battery chamber cover is opened, do not press the battery chamber cover by force. This may cause damage to the battery chamber cover.
- There are 4 indicators for battery condition that are displayed on the LCD monitor.

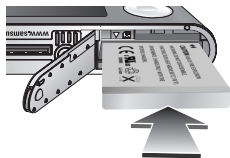

Battery indicator				
Battery status	The battery is fully charged	Low battery capacity (Prepare to recharge or use spare battery)	Low battery capacity (Prepare to recharge or use spare battery)	Low battery capacity (Prepare to recharge or use spare battery)

Inserting the memory card

- Insert the memory card as shown.
 - Turn off the camera's power before inserting the memory card.
 - Have the front of the memory card facing toward the front of the camera (lens) and the card pins toward the back of the camera (LCD monitor).
 - Do not insert the memory card the wrong way round. Doing so may damage the memory card slot.

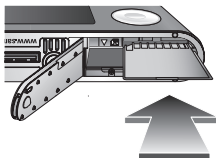

Instructions on how to use the memory card

- Be sure to format the memory card (see p.59) if you are using a newly purchased memory for the first time, if it contains data that the camera cannot recognise, or if it contains images captured with a different camera.
- Turn off the camera power whenever the memory card is being inserted or removed.
- Repeated use of the memory card will eventually reduce the memory card's performance. Should this be the case, you will need to purchase a new memory card. Wear and tear on the memory card is not covered by the Samsung warranty.
- The memory card is an electronic precision device.
 - Do not bend, drop or subject the memory card to any heavy impact.
- Do not store the memory card in an environment with strong electronic or magnetic fields, e.g. near loud speakers or TV receivers.
- Please do not use or store in an environment where there are extremes in temperature.
- Do not allow the memory card to become dirty or to come into contact with any liquid. Should this happen, clean the memory card with a soft cloth.
- Please keep the memory card in its case when not in use.
- During and after periods of extended use, you may notice that the memory card is warm. This is perfectly normal.
- Do not use a memory card that is used in another digital camera.
 - To use the memory card in this camera, format the memory card using this camera.
- Do not use a memory card formatted by another digital camera or memory card reader.
- If the memory card is subjected to any of the following, the recorded data may become corrupted :
 - When the memory card is used incorrectly.
 - If the power is switched off or the memory card is removed while recording, deleting (formatting) or reading.

Instructions on how to use the memory card

- Samsung cannot be held responsible for lost data.
- It is advisable to copy important data onto other media as back-up e.g. floppy disks, hard disks, CD etc.
- If there is insufficient memory available : A [Memory Full!] message will appear and the camera will not operate. To optimise the amount of memory in the camera, replace the memory card or delete unnecessary images stored on the memory card.

INFORMATION

- Don't remove the memory card when the camera status lamp is blinking as this may cause damage to data in the memory card.

- The camera can use SD Memory Cards and MMC (Multi Media Cards).
When using MMC cards, please consult the instructions supplied with the cards.

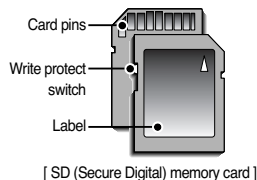

The SD memory card has a write protect switch that prevents image files from being deleted or formatted. By sliding the switch towards the bottom of the SD memory card, the data will be protected. By sliding the switch towards the top of the SD memory card, the data protection will be cancelled. Slide the switch towards the top of the SD memory card before taking a picture.

- When using a 256MB MMC (Multi Media Card), the specified shooting capacity will be as follows. These figures are approximate as image capacities can be affected by variables such as subject matter and memory card type.

Recorded image size	Super Fine	Fine	Normal	30FPS	20FPS	15FPS	
Still image	7M	Approx. 63	Approx. 116	Approx. 171	-	-	-
	6M	Approx. 74	Approx. 138	Approx. 195	-	-	-
	5M	Approx. 88	Approx. 162	Approx. 223	-	-	-
	5M(W)	Approx. 88	Approx. 162	Approx. 223	-	-	-
	4M	Approx. 118	Approx. 202	Approx. 274	-	-	-
	3M	Approx. 131	Approx. 236	Approx. 318	-	-	-
	2M	Approx. 208	Approx. 332	Approx. 422	-	-	-
	1M	Approx. 381	Approx. 520	Approx. 600	-	-	-
	VGA	Approx. 1201	Approx. 1420	Approx. 1736	-	-	-
Movie	720	-	-	-	-	About 13' 36"	-
	640	-	-	-	About 17' 19"	-	About 33' 3"
	320	-	-	-	About 37' 24"	-	About 69' 36"

- ※ The recording times can be changed by the zoom operation.
The zoom button doesn't operate while recording movies.

• When Using the Camera for the First Time

- When the camera is turned on for the first time, a menu will be displayed to set date, time and language in the LCD monitor. This menu will not be displayed again after setting up the date, time and language. Set up the date, time and language before using this camera.

- Setting up the date, time and date type

1. Select the [Date&Time] menu by pressing the UP/DOWN button and press the RIGHT button.

2. Select the desired sub menu by pressing the UP/ DOWN/ LEFT/ RIGHT button.

RIGHT button : selects YEAR/ MONTH/ DAY/
HOUR/ MINUTE/ DATE TYPE

LEFT button : Moves the cursor to the [Date&Time] main menu if the cursor is at the first item of the date and time setup. In all other instances, the cursor will be shifted to the left of its current position.

UP/ DOWN button : changes the value of each item.

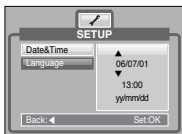

- Setting up the language

1. Select the [Language] menu by pressing the UP/DOWN button and press the RIGHT button.

2. Select the desired sub menu by pressing the UP/ DOWN button and press the OK button.

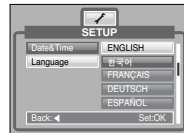

INFORMATION

- You can select one of the following 22 languages :
 - English, Korean, French, German, Spanish, Italian, S.Chinese, T.Chinese, Japanese, Russian, Portuguese, Dutch, Danish, Swedish, Finnish, Thai, BAHASA(MALAY/ INDONESIAN), Arabic, Polish, Hungarian, Czech and Turkish.
- Even if the camera is restarted, the language setting will be maintained.

• LCD monitor indicator

- The LCD monitor displays information about the shooting functions and selections.

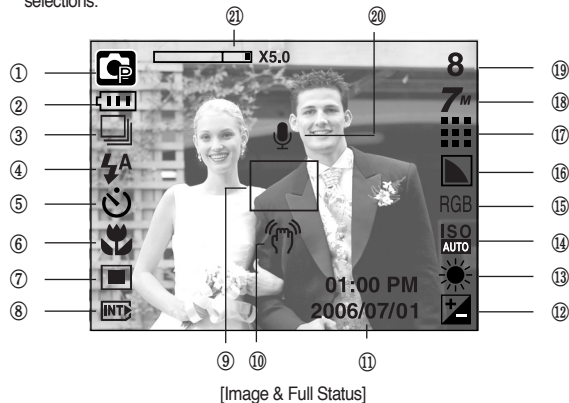

No.	Description	Icons	Page
1	Recording mode		p.9
2	Battery		p.12
3	Continuous shot		p.37/17
4	Flash		p.24
5	Self-timer		p.26
6	Macro		p.23
7	Metering		p.37

No.	Description	Icons	Page
8	Card inserted indicator		-
9	Auto focus frame		-
10	Camera shake warning		p.20
11	Date/ Time	2006/07/01 01:00 PM	p.59
12	Exposure compensation		p.30
13	White Balance	AWB	p.29
14	ISO		p.28
15	RGB	RGB	p.28
16	Sharpness		p.38
17	Image quality / Frame rate		p.36
18	Image size		P.36
19	Number of available shots remaining	8	P.13
	Remaining time (Movie clip/ Voice recording)	00:01:30/ 00:30:00	P.13
20	Voice memo/ Mic. off		p.22/19
21	Optical/ Digital Zoom bar /Digital Zoom rate	X5.0	P.21

Starting the recording mode

How to use the AUTO mode (**AUTO**)

Please select this mode for quick and easy picture taking with minimal user interaction.

1. Insert the batteries (p.12) taking note of the polarity (+ / -).
2. Insert the memory card (p.12). As this camera has a 15MB internal memory, it is not essential to insert the memory card. If the memory card is not inserted, an image will be stored in the internal memory. If the memory card is inserted, an image will be stored on the memory card.
3. Close the battery chamber cover.
4. Press the power button to turn on the camera. (If the date/ time that is displayed on the LCD monitor is incorrect, reset the date/ time before taking a picture.)
5. Select the AUTO mode by rotating the mode dial.
6. Point the camera towards the subject and compose the image by using the LCD monitor.
7. Press the shutter button to capture an image.



[AUTO mode]

How to use the PROGRAM mode (**P**)

Selecting the automatic mode will configure the camera with optimal settings. You can still manually configure all functions except the aperture value and shutter speed.

1. Select the PROGRAM mode by rotating the mode dial.
2. Press the menu button to configure advanced functions such as image size (p.35), quality (p.36), metering (p.37), continuous shooting (p.37), sharpness (p.38), AF type (p.38) and OSD information (p.39).

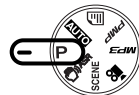

[PROGRAM mode]

INFORMATION

- If the auto focus frame turns to red when you press the shutter button down half way, it means that the camera cannot focus on the subject. Should this be the case, the camera is unable to capture an image clearly.

Starting the recording mode

- How to use the ASR (Advanced Shake Reduction) mode ()
The ASR mode can help you get clearer pictures by minimizing camera shake.

- Things to watch out for using the ASR mode

- The digital zoom will not operate in the ASR mode.
- If the lighting conditions are brighter than fluorescent lighting condition, the ASR doesn't activate.
- If the lighting condition is darker than in fluorescent lighting condition, camera shake warning indicator () will display. For best results only take pictures in situations where the camera shake warning indicator is not displayed.
- If the subject is moving, the final image captured may be blurred.
- Avoid moving the camera while the [Capturing!] message is displayed to achieve a better result.
- As the ASR uses the camera's digital processor, images taken using the ASR may take a little longer for the camera to process.



[ASR mode]

- Wise Shot
2 images are taken at a time. One is taken in the Fill-In Flash mode and the other is taken in the ASR mode. You can select and save only one of the images.

- How to use the Wise Shot

- Select the ASR mode by rotating the mode dial.
- Press the E button and the Wise Shot function is activated.
- Press the Shutter button to capture images.
- Captured images are displaying.
 - To select image, press the Left/Right button.
 - To change the enlarged part, press the E button and 5 function button.
 - Press the E button again and the enlarged part will be changed automatically.



- Press the OK / Shutter button and the selected image will be saved.

INFORMATION

- The 3072X1728 image size can't be selected when using this function.
- In the Wise shot mode, the shutter speed value shown on the LCD monitor may be different with the real shutter speed.

Starting the recording mode

How to use the SCENE mode (SCENE)

Use the menu to easily configure optimal settings for a variety of shooting situations.

1. Select the SCENE mode by rotating the mode dial.
2. Press the menu button and select a desired scene menu.

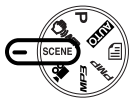

[SCENE mode]

How to use the MOVIE CLIP mode ()

A movie clip can be recorded for as long as the available recording time of the memory capacity allows.

1. Select the MOVIE CLIP mode by rotating the mode dial. (Available recording time will display on the LCD monitor)
2. The MOVIE CLIP mode icon and available recording time will display on the LCD monitor.
3. Point the camera towards the subject and compose the image by using the LCD monitor. Press the shutter button and movie clips are recorded for as long as the available recording time allows. Movie clips will still be recorded if the shutter button is released.

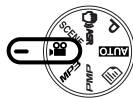

[MOVIE CLIP mode]

If you wish to stop recording, press the shutter button again.

* Image size and type are listed below.

- Image size : 720X480, 640X480, 320X240 (Selectable)
- File type : *.avi (MPEG-4)

※ The scene modes are listed below.

[Nightscene] () : Use this for shooting still images at night or in other dark conditions.

[Portrait] () : To take a picture of a person.

[Children] () : To take a picture of fast moving objects, for example, children.

[Landscape] () : To take pictures of distant scenery.

[Close up] () : Close-up shooting for small objects such as plants and insects.

[Text] () : Use this mode to shoot a document.

[Sunset] () : For taking pictures of sunsets.

[Dawn] () : Daybreak scenes.

[Backlight] () : Portrait without shadows caused by backlight.

[Firework] () : Firework scenes.

[Beach&Snow] () : For ocean, lake, beach and snow scape scenes.

Starting the recording mode

Recording the movie clip without voice

You can record the movie clip without voice.

1. Press the Up button and the () icon will display on the LCD monitor.
2. Press the shutter button and movie clip is recorded without voice for as long as the available recording time allows.
3. To stop the recording, press the shutter button again.



[MOVIE CLIP mode]

Pausing while recording a movie clip (Successive Recording)

This camera allows you to temporarily stop during unwanted scenes, while recording a movie clip. Using this function, you can record your favourite scenes into a movie clip without having to create multiple movie clips.

1. Press the Pause button while recording a movie clip and the recording will be paused.
2. Press the Pause button again to resume the recording.
3. If you wish to stop recording, press the shutter button again.



[Successive recording of a movie clip]

- ※ If a camera button is pressed during the movie recording, camera operation sound can be recorded.

How to use the VOICE RECORDING mode

A voice recording can be recorded for as long as the memory capacity allows. (Max: 1 hour).



1. In any mode with the exception of Movie clip mode, select the VOICE RECORDING mode by pressing the Voice recording button twice.
2. Press the shutter button to record a voice.
 - Press the shutter button once and voice is recorded for as long as the available recording time allows (Max : 1 hour). Voice will still be recorded if the shutter button is released.
 - If you wish to stop recording, press the shutter button again.
 - File type : *.wav



[Voice recording mode]

Pausing while recording a voice

Using this function, you can record your favorite voice clips into a voice recording file without having to create multiple voice recording files.

1. Press the Pause button () to pause recording.
2. Press the Pause button () again to resume the recording.
3. If you wish to stop recording, press the shutter button again.



[Pausing the voice recording]

INFORMATION

- A distance of 40cm between you and the camera (microphone) is the best distance to record sound.
- If the camera power is turned off while the voice recording is paused, the voice recording is cancelled.

Things to watch out for when taking pictures

- Pressing the shutter button down half way.
Lightly press the shutter button to confirm focus and flash battery charge.
Press the shutter button all way down to take the picture.

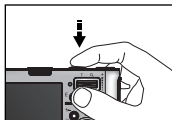

[Lightly press the shutter button]

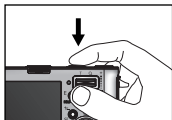

[Press the shutter button]

- The available recording time may vary depending on shooting conditions and camera settings.
- When the Flash Off or Slow synchro mode is selected in a low lighting condition, the camera shake warning indicator () may appear on the LCD monitor. In this case, use a tripod, support the camera on a solid surface or change to flash shot mode.
- Shooting against the light :
Do not take pictures into the sun. Taking a picture against the sun may make the picture dark. To take a picture against the sun, please use the [Backlight] in the scene shooting mode (see page 18), fill-in flash (see page 25), spot metering (see page 37), or exposure compensation (see page 30).
- Avoid obstructing the lens or the flash when you capture an image.
- Compose the image by using the LCD monitor.
- Under certain conditions the auto focus system may not perform as expected.
 - When photographing a subject that has little contrast.
 - If the subject is highly reflective or shiny.
 - If the subject is moving at high speed.
 - When there is strong reflected light, or when the background is very bright.
 - When the subject matter has only horizontal lines or the subject is very narrow (such as a stick or flagpole).
 - When the surroundings are dark.

Using the camera buttons to set the camera

- The recording mode function can be set up by using the camera buttons.

POWER button

- Used for turning the camera's power on/ off.
- If there is no operation during the specified time, the camera's power will be turned off automatically to save battery life.
Refer to page 58 for more information about the auto power off function.

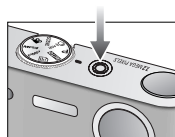

SHUTTER button

- Used for taking an image or recording voice in the RECORDING mode.
- In MOVIE CLIP mode :
Pressing the shutter button down fully starts the process for recording a movie clip. Press the shutter button once and the movie clip is recorded for as long as the available recording time in the memory allows. If you wish to stop recording, press the shutter button again.
- In STILL IMAGE mode
Pressing the shutter button down halfway activates the autofocus and checks the condition of the flash. Pressing the shutter button down fully takes and stores the image. If you select voice memo recording, the recording will start after the camera has finished storing the image data.

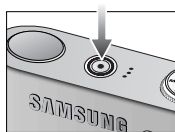

ZOOM W/ T button

- This camera has a 3X optical zoom and a 5X digital zoom function.
Using both will offer a total zoom ratio of 15X.



TELE Zoom

Optical zoom TELE : Pressing the ZOOM T button. This will zoom into the subject i.e. the subject will appear nearer.

Digital zoom TELE : When the maximum (3X) optical zoom is selected, pressing the ZOOM T button activates the digital zoom software. Releasing ZOOM T button stops the digital zooming at the required setting. Once the maximum digital zoom (5X) is achieved, pressing the ZOOM T button will have no effect.



WIDE Zoom

Optical zoom WIDE : Pressing the ZOOM W button. This will zoom out from the subject i.e. the subject will appear farther away. Pressing the ZOOM W button continuously will set the camera to its minimum zoom setting i.e. the subject appears at its farthest from the camera.



Digital zoom WIDE : When the digital zoom is in operation, pressing the ZOOM W button will reduce the digital zooming in steps. Releasing ZOOM W button stops digital zooming. Pressing the ZOOM W button will reduce the digital zoom and then it will continue to reduce the optical zoom until the minimum setting is reached.

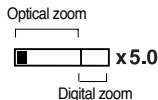

• ZOOM W/ T button

INFORMATION

- Images taken using the digital zoom may take a little longer for the camera to process. Allow time for this to take place.
- You may notice a decrease in image quality when using the digital zoom.
- To view a clearer digital zoom image, press the shutter button halfway at the maximum optical zoom position and press the zoom T button again.
- The digital zoom can't be activated in the [Nightscape], [Children], [Closeup], [Text], [Fireworks] scene modes, the Movie clip mode, the ASR (Wise shot) mode and the [Highlight], [Photo Frame], [Composite] effect menu.
- Take care not to touch the lens as this may cause a camera malfunction.

• Voice recording () / Voice memo () / UP button

- While the menu is showing, press the UP button to move up the sub menu. When the menu is not displayed on the LCD monitor, the UP button operates as the voice recording or voice memo button. You can add your voice-over to a stored still image. Refer to page 19 for more information about the voice recording.
- Recording a voice memo
 1. Rotate the MODE DIAL to select a RECORDING mode with the exception of MOVIE CLIP mode.
 2. Press the VOICE MEMO () button. If the voice memo indicator is displayed on the LCD monitor, the setting is completed.



[Preparing for Voice Memo]



[Recording Voice Memo]

3. Press the shutter button and take a picture. The picture is stored on the memory card.
4. Voice memo will be recorded for ten seconds from the moment the picture is stored. In the middle of the sound recording, pressing the shutter button will stop the voice memo.

INFORMATION

- A distance of 40cm between you and the camera (microphone) is the best distance to record sound.

• Macro (🌸)/ Down button

- While the menu is showing, the DOWN button operates as a direction button. When the menu is not showing, you can use the MACRO/ DOWN button to take macro pictures. The distance ranges are shown below. Press the Macro button until the desired macro mode indicator displays on the LCD monitor.



[Auto focus - No icon]



[Auto macro (🌸)]



[Super Macro (🌸)]



[Macro (🌸)]

- Types of focus modes and focus ranges (W: Wide, T: Tele) (Unit : cm)

Mode	Auto(📷)		
Focus Type	Super macro(🌸)	Auto macro(🌸)	Normal
Focus range	W : 1~5 (Wide only)	W : 5~Infinity T : 50~Infinity	W : 50~Infinity T : 50~Infinity
Mode	Program(📷)		
Focus Type	Super macro(🌸)	Macro(🌸)	Normal
Focus range	W : 1~5 (Wide only)	W : 5~50 T : 25~50	W : 50~Infinity T : 50~Infinity
Mode	ASR mode(📷)		
Focus Type	Super macro(🌸)	Auto Macro(🌸)	Normal
Focus range	-	W : 5~Infinity T : 50~Infinity	W : 50~Infinity T : 50~Infinity

INFORMATION

- When the macro mode is selected, be particularly careful to avoid camera shake.
 - When you take a picture within 20cm (Wide zoom) or 30cm (Tele zoom) in the Macro mode, select the FLASH OFF mode.
 - When you take a picture within the 5cm Super macro range, the auto-focus on the camera will take longer to set the correct focus distance.
- Available focusing method, by recording mode
(O: Selectable, X: Not selectable, ∞: Infinity focus range)

Mode	📷	📷	📷	📷							
Auto macro	X	O	X	O							
Super macro	X	O	O	X							
Macro	O	X	O	X							
Normal	O	O	O	O							
Mode	SCENE										
	📷	📷	📷	📷	📷	📷	📷	📷	📷	📷	📷
Auto macro	X	X	X	X	X	O	X	X	X	X	X
Super macro	X	X	X	X	X	X	X	X	X	X	X
Macro	X	X	X	O	X	X	X	X	X	X	X
Normal	O	O	O	∞	X	X	∞	∞	O	∞	O

Focus lock

- To focus on a subject not positioned in the centre of the picture, use the focus lock function.
- Using the Focus Lock
 1. Ensure the subject is in the centre of the autofocus frame.
 2. Press the SHUTTER button halfway. When the green auto focus frame lights up, it means the camera is focused on the subject. Be careful not to press the SHUTTER button all the way down to avoid taking an unwanted picture.
 3. With the SHUTTER button still pressed down only halfway, move the camera to recompose your picture as desired, and then press the SHUTTER button completely to take the picture. If you release your finger from the SHUTTER button, the focus lock function will be cancelled.

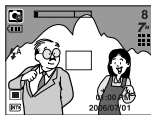

1. The image to be captured.



2. Press the SHUTTER button halfway and focus on the subject.

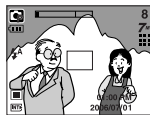

3. Recompose the picture and fully press the SHUTTER button.

Flash ()/ Left button

- When the menu is displayed on the LCD monitor, pressing the LEFT button makes the cursor shift to the left tab.
- When the menu is not displayed on the LCD monitor, the LEFT button operates as the FLASH button.
- Selecting the flash mode
 1. Rotate the MODE DIAL to select a RECORDING mode with the exception of Movie clip and Motion capture modes.
 2. Press the Flash button until the desired flash mode indicator displays on the LCD monitor.
 3. A flash mode indicator will be displayed on the LCD monitor. Use the correct flash to suit the environment.



[Selecting the Auto flash]

- Flash range (Unit : m)

ISO	Normal		Macro		Auto macro	
	WIDE	TELE	WIDE	TELE	WIDE	TELE
AUTO	0.8 ~ 3.4	0.8 ~ 2.5	0.3 ~ 0.8	0.5 ~ 0.8	0.3 ~ 3.4	0.5 ~ 2.5









- ※ When the Super Macro is selected, flash is fixed as the Flash Off mode.

Flash () / Left button

INFORMATION

- If you press the shutter button after selecting the Auto, Fill-in, Slow synchro flash, the first flash fires to check the shooting condition (Flash range and Power ratio of flash).
Do not move the camera until the second flash fires.
- Using the flash frequently will reduce the life of the battery.
- Under normal operating conditions the re-charging time for the flash is usually within 4 seconds. If the battery is weak, the charging time will be longer.
- In the ASR mode, [Macro], [Landscape], [Text], [Sunset], [Dawn], [Firework] scene modes and the Movie clip mode, the flash function will not operate.
- Take photographs within the flash range.
- The image quality is not guaranteed if the subject is too close or highly reflective.
- When taking an image in poorly lit conditions with the flash, there may be a white speck in the captured image. The speck is caused by the the flash light reflecting off atmospheric dust.





















● Flash mode indicator

Menu tab	Flash mode	Description
	Auto flash	If the subject or background is dark, the camera flash will operate automatically.
	Auto & Red eye reduction	If a subject or background is dark, the camera flash will work automatically and will reduce the red-eye effect by using the red-eye reduction function.
	Fill in flash	The flash fires regardless of the available light. The intensity of the flash will be automatically controlled to suit the prevailing conditions.
	Slow synchro	The flash operates with a slow shutter speed to obtain a balanced correct exposure. In poor lighting conditions the camera shake warning indicator () will display on the LCD monitor.
	Flash off	The flash does not fire. Select this mode when capturing images in a place or situation where flash photography is prohibited. When you capture an image in a poorly lit condition, the camera shake warning indicator () will display on the LCD monitor.
	Red-eye reduction	When a shot with "red eye" is detected, this mode will reduce the red-eye effect automatically.

Flash () / Left button

- Available flash mode, by recording mode

(O:Selectable, X:Not Selectable)

														
	X	X	O	X	X	X	X	X	X	X	X	X	X	O
	X	O	O	X	O	O	X	X	X	X	X	X	X	X
	X	X	O	X	X	X	X	X	X	X	X	O	X	X
	X	X	O	O	X	X	X	X	X	X	X	X	X	X
	O	O	O	O	O	O	O	O	O	O	O	X	O	X
	X	O	O	O	O	O	X	X	X	X	X	X	X	X

Self-timer () / Right button

- When the menu is displayed on the LCD monitor, pressing the Right button makes the cursor shift to the right tab. The right button can also be used to move to a sub menu to select a different setting. When the menu is not displayed on the LCD monitor, the RIGHT button operates as the Self-timer. This function is used when the photographer would also like to be in the image.

- Selecting the self-timer

- Press the SELF-TIMER button until the desired mode indicator displays on the LCD monitor.
- When you press the SHUTTER button, the picture will be taken after the specified time has elapsed.



[Selecting the 2 SEC self-timer]

INFORMATION

- In Movie Clip mode, only the 10SEC self-timer will work.
- When you select 2SEC self-timer with flash, the delay (2 second) can be extended according to the flash charging status.
- If you operate the Power button and Play mode button during the self-timer operation, the self-timer function is cancelled.
- Use a tripod to prevent camera shake.

MENU/ OK button

MENU button

- When you press the MENU button, a menu related to each camera mode will be displayed on the LCD monitor. Pressing it again will return the LCD to the initial display.
 - A menu option can be displayed when the following are selected :
MOVIE CLIP and STILL IMAGE mode.
- There is no menu available when the VOICE RECORDING mode is selected.

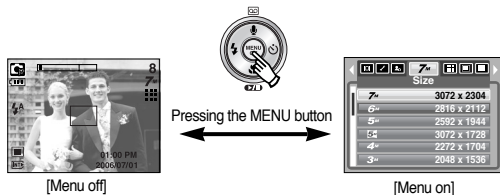

OK button



- When the menu is displayed on the LCD monitor, this button is used for shifting the cursor to the sub menu or for confirming data.

+/- button

- You can use the +/- button to adjust the values for the RGB, ISO, white balance, exposure compensation and Long Time shutter speed.
- When the ASR mode is selected, ISO value is fixed as AUTO and Exposure value is fixed as 0.0EV.

Main menu	Sub menu	Available camera mode
RGB	R (Red), G (Green), B (Blue)	
ISO	AUTO, 80, 100, 200, 400, 800, 1000	
WHITE BALANCE	AUTO, DAYLIGHT, CLOUDY, FLUORESCENT H, FLUORESCENT L, TUNGSTEN, CUSTOM.	
Exposure compensation	-2.0 ~ 0.0 ~ +2.0 (0.5EV steps)	
LT	Shutter speed/ Aperture Value (Changed by zoom rate)	

+/- button

- RGB : Allows the user to adjust the R (Red), G (Green), and B (Blue) values of the images to be captured.
- Setting RGB Values
 1. Press the +/- button, and then use the UP and DOWN buttons to select the RGB icon (). The RGB menu bar will appear as shown.
 2. Use the UP/ DOWN/ LEFT and RIGHT buttons to select the desired RGB value.
 - Up/ Down Button : Navigates between R, G, and B icons.
 - Left/ Right Button : Changes value of each icon.
 3. When you press the +/- button again, the value you set will be saved and RGB setup mode will end.
- ※ When special effect (colour) from the icon other than  is selected, it will not be able to select the RGB.



- ISO : You can select the ISO sensitivity when taking pictures.
The speed or specific light-sensitivity of a camera is rated by ISO numbers.
- Selecting an ISO Sensitivity
 1. Press the +/- button, and then use the UP and DOWN buttons to select the ISO icon(). The ISO menu bar will appear as shown.
 2. Use the LEFT and RIGHT buttons to select the desired ISO sensitivity value.
 - AUTO : The camera's sensitivity is automatically changed by variables such as lighting value or subject brightness.
- 80, 100, 200, 400, 800, 1000 : You can increase the shutter speed while the same amount of light is present, by increasing the ISO sensitivity. However, the image may be saturated in high luminance.
The higher the ISO value, the higher the camera's sensitivity to light and therefore the greater its capacity to take pictures in darker conditions. However, the noise level in the image will increase as the ISO value increases, making the image appear coarser.
 3. When you press the +/- button again, the value you set will be saved and ISO setup mode will end.



• +/- button

- White balance : The white balance control allows you to adjust the colours to appear more natural.

- Selecting a White Balance

1. Press the +/- button, and then use the UP and DOWN buttons to select the white balance icon (AWB). The white balance menu bar will appear as shown.



2. Use the LEFT and RIGHT buttons to set the white balance to the desired value. The value you set will be displayed on the LCD monitor.

AUTO AWB : The camera automatically selects the appropriate white balance settings, depending on the prevailing lighting conditions.

DAYLIGHT ☀ : For taking images outside.

CLOUDY ☁ : For taking images under a cloudy and overcast sky.

Fluorescent H ⚡ : For shooting under daylight fluorescent types of three-way fluorescent lighting.

Fluorescent L ⚡ : Shooting under white fluorescent lighting.

TUNGSTEN ⚡ : For shooting under tungsten (standard light bulb) lighting.

CUSTOM ■ : Allows the user to set the white balance according to the shooting condition.

Different lighting conditions may cause a colour cast on your images.

3. Press the +/- button again. The value you set will be saved and White Balance setup mode will end.

- Using the Custom White Balance

White balance settings may vary slightly depending on the shooting environment. You can select the most appropriate white balance setting for a given shooting environment by setting up the custom white balance.

1. Select the CUSTOM (■) menu of the White Balance.
2. Place a sheet of white paper in front of the camera so that the LCD monitor shows only white, and then press the SHUTTER button.
3. Your custom white balance value is stored.



- The custom white balance value will be applied, starting with the next picture you take.
- The user configured white balance will remain effective until it is overwritten.

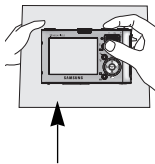

[White paper]

+/- button

- Exposure compensation : This camera automatically adjusts the exposure according to the ambient lighting conditions. You can also select the exposure value by using the +/- button.

- Compensating Exposure

1. Press the +/- button, and then use the UP and DOWN buttons to select the exposure compensation icon ().

The exposure compensation menu bar will appear as shown.

2. Use the LEFT and RIGHT buttons to set the desired exposure compensation factor.

3. Press the +/- button again. The value you set will be saved and the Exposure Compensation setup mode will close.

If you change the exposure value, the exposure indicator () will be displayed on the bottom of the LCD monitor.



- ※ A negative exposure compensation value reduces the exposure. Note that a positive exposure compensation value increases the exposure and the LCD monitor will appear white or you may not get good pictures.

- Long Time shutter :

This camera automatically adjusts the shutter speed and aperture values to the shooting environment. However, in NIGHT SCENE mode, you can set the shutter speed and aperture values to your preference.

- Adjusting the shutter speed and aperture values

1. Select the [Night] scene mode.
2. Press +/- button and Long Time shutter menu (LT, For selecting shutter speed and aperture value) will be displayed.

3. Configure the Long Time shutter value with the up/ down/ left/ right button.

4. Press the +/- button again.

The value you set will be saved and the mode will switch to NIGHT SCENE mode.



AUTO, WIDE : F3.5 ~ F6.3,
TELE : F4.5 ~ F8.0

Aperture Value

Shutter Speed

AUTO, 1~16S

E (Effect) button

- It is possible to add special effects to your images by using this button.
- Available Effects, by recording mode (O : Selectable X : Not selectable)
- When you select 3072X1728 (Wide 5M) image size, you can only select the color menu of the special effects.

Color ()	O	O	O	O	O	O	O
HighLight ()	X	X	O	O	O	O	O
Composite ()	X	X	O	O	O	O	O
Photo Frame ()	X	X	O	O	O	O	O
Stabilizer ()	O	X	X	X	X	X	X

INFORMATION

- If a special effect is selected, any previously selected special effect (HighLight, Composite, Photo Frame) is automatically cancelled.
- The digital zoom and date imprinting functions do not operate in the [HighLight], [Composite] and [Photo Frame] special effect settings.
- Even if the camera is turned off, the special effect setting will be preserved. To cancel the special effect, select the **NOR** sub menu (Color) or **OFF** sub menu (HighLight, Composite, Photo Frame).
- When an effect is selected, the preview image on the LCD may be slow to appear.

Colour

- By using the camera's digital processor, it is possible to add special effects to your images.

- Press the E button in the available camera modes and select the menu.
- Select a desired sub menu by pressing the Up/Down button and press the OK button.

NOR : No effect is added to the image

SW : Captured images will be stored in black and white.

S : Captured images will be stored in a sepia tone.

R : Captured images will be stored in a red tone.

G : Captured images will be stored in a green tone.

B : Captured images will be stored in a blue tone.

N : Save the image in negative mode.

- Press the shutter button to capture an image.



[Still image mode]

• E (Effect) button

Preset focus frames

- You can make the subject stand out from its surroundings. The subject will be sharp and in focus while making the rest out of focus.

- Press the E button in the available camera modes with the exception of Movie clip and Auto mode and select the **[+]** menu.
- Select a desired sub menu by pressing the Up/ Down button and press the OK button.

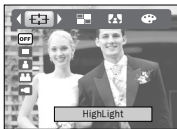

[Range 1]



[Range 2]



[Range 3]



[Range 4]

- The preset focus frame will appear.
Press the shutter button to capture an image

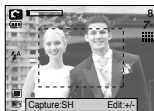

- Moving and changing the focus frame
You can change the focus frame after selecting a Range menu.

- Press the +/- button after selecting a preset focus frame.



[The frame is activated]

- Press the Up/ Down/ Left/ Right button to move the focus frame position.



[After changing the frame position]

- To select the focus frame position, press the +/- button again and you can take a picture.



E (Effect) button

Composite shooting

- You can combine 2~4 different shots in a still image.

- Press the E button in the available camera modes with the exception of Movie clip and Auto mode and select the  menu.



- Select a desired sub menu by pressing the Up/ Down button and press the OK button.



- Press the shutter button to capture an image
- To save the composite shots, press the OK button after taking the last shot.

INFORMATION

- You can use the flash button, self-timer button, macro button, voice memo button and the Zoom W/T button during the composite shooting. If you press the camera buttons (ASR button and Play mode button) during the composite shots, each mode of the camera buttons is executed. The images captured before will be deleted.
- After taking the last composite shooting, press the OK button. And then the voice memo will start.

- Changing a part of composite

Before taking the last composite shot, you can change a part of composite shot.



[Before taking the 3rd shot]



[Moving backward to the 2nd shot]

After taking the last composite shot, you can change a part of composite shot.



[After taking the 4th shot]



[Moving backward to the 2nd shot]



[Deleting the 2nd shot]



[The final picture]



[After taking the 2nd shot again]

Pressing the Shutter button

• E (Effect) button

Photo Frame

- You can add 9 types of frame-like borders to a still image you want to capture.

1. Press the E button in the available camera modes with the exception of Movie clip and Auto mode and select the  menu.
2. Select a desired sub menu by pressing the Up/ Down button and press the OK button.

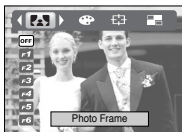

r1



r2



r3



r4



r5



r6



r7



r8



r9

3. The selected Photo Frame will appear. Press the shutter button to capture an image

※ Before taking a picture, you can change the frame type by pressing the +/- button.

Movie Clip frame stabiliser

- This function helps stabilise images captured during movie recording. You can select this menu only in the MOVIE CLIP mode. If the memory card is not inserted, this function will not operate.

1. Press the E button in the Movie clip mode and select the  menu.



















2. Select a desired sub menu by pressing the Up/ Down button and press the OK button.

Off : Movie clip frame stabilizer function is disabled.

On : Reduces camera shake during movie recording. The recording frame range will become narrower than when you select the **Off** menu. If the subject moves, the Pre-view frames may be changed slightly.

Using the LCD monitor to adjust the camera settings

- You can use the menu on the LCD monitor to set up recording functions.
- The items indicated by  are default settings.

Menu tab	Main menu	Sub menu		Camera working mode	Page
	SIZE (Still Image)	3072x2304	2816x2112		P.36
		2592x1944	3072x1728		
		2272x1704	2048x1536		
		1600x1200	1024x768		
		640x480	-		
	SIZE (Movie)	720X480	640X480		P.36
		320X240	-		
	QUALITY	Super Fine	Fine		P.36
		Normal	-		
	FRAME RATE	30 FPS	20 FPS		p.36
		15 FPS	-		
	METERING	Multi	Spot		p.37
		SHOOTING	Single		
	SHOOTING	AEB	-		p.37
			SHARPNESS		
Vivid	-				
	AUTO FOCUS	Center AF	Multi AF		p.38
			OSD INFORMATION		
LCD Save	-				

※ Menus are subject to change without prior notice.

※ When the image size (Movie clip) is 720X480, the default of the frame rate is 20 fps.

How to use the menu

- Turn on the camera and press the MENU button. A menu for each camera mode appears. However, there is no menu for Voice Recording mode ().
- Use the LEFT and RIGHT buttons to navigate through the menus.



- Use the UP and DOWN buttons to select a sub menu.



- Select a sub menu, and then the value you set will be saved. Press the MENU button and the menu will disappear.

Size

- You can select the image size appropriate for your application.

Mode	STILL IMAGE mode									MOVIE CLIP mode		
Icon	7 ^M	6 ^M	5 ^M	5 ^L	4 ^M	3 ^M	2 ^M	1 ^M	VGA	720	640	320
Size	3072X 2304	2816X 2112	2592X 1944	3072X 1728	2272X 1704	2048X 1536	1600X 1200	1024X 768	640X 480	720x 480	640x 480	320x 240

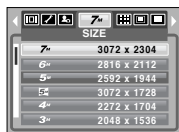

[STILL IMAGE mode]

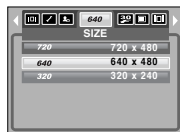

[MOVIE CLIP mode]

INFORMATION

- High resolution images use more memory than lower resolution shots. Therefore the higher the resolution selected the fewer will be the number of shots available.

Quality/ Frame rate

- You can select the compression ratio appropriate for your application of the captured images. The higher the compression ratio, the lower the picture quality.



[STILL IMAGE mode]

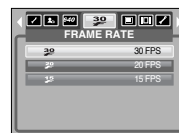

[MOVIE CLIP mode]

INFORMATION

- This file format complies with the DCF(Design rule for Camera File system).

Metering

- If you cannot obtain suitable exposure conditions, you can change the metering method to take brighter pictures.
- Multi : Exposure will be calculated based on an average of the available light in the image area. However, the calculation will be biased towards the centre of the image area. This is suitable for general use.
- Spot : Only the rectangular area in the centre of the LCD monitor will be metered for light. This is the preferable setting when you want the subject in the centre of the image exposed correctly, regardless of the back lighting.



INFORMATION

- If the subject is not the centre of the focus area, do not use the spot metering as this may result in an exposure error. In this circumstance, it is better to use exposure compensation.

Continuous shot

- You can select continuous shot, and AEB (Auto Exposure Bracketting).
 - Single : Take one picture only
 - Continuous : Images will be taken continuously until the shutter button is released. The shooting capacity depends on the memory.
 - AEB : Take three pictures in a series in different exposures: standard exposure(0.0EV), short exposure (-0.5EV) and over exposure (+0.5EV). Use the mode if it is hard to decide exposure of the object.
- ※ High resolution and picture quality increases file saving time, which increases stand-by time.
 - ※ If the [Continuous] or [AEB] sub menu is selected, the flash will be off automatically.
 - ※ If less than 3 pictures are available in the memory, the AEB shooting is not available.
 - ※ It is best to use a tripod for the AEB shooting as the time to save each image file is long and blurring caused by camera shake may occur.

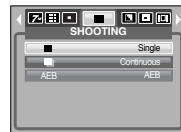

[PROGRAM mode]

Sharpness

- You can adjust the sharpness of the picture you are about to take. You cannot check the sharpness effect on the LCD monitor before you take a picture, because this function is applied only when the captured image is stored on the memory.



- Soft : The edges of the image are softened. This effect is suitable for editing images on your PC.
- Normal : The edges of the image are sharp. This is suitable for printing.
- Vivid : The edges of the image are emphasized. The edges will appear sharp, but noise may occur in the recorded image.

Auto Focus type

- You can select your preferred Auto Focus type according to the shooting condition.

- Center AF : The rectangular area in the center of the LCD monitor will be focused
- Multi AF : This camera selects a AF point from the 5 AF points.



[Program mode]



[Center AF]

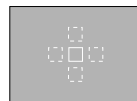

[Multi AF]

- ※ When the camera focuses on the subject, the auto focus frame turns too green. When the camera doesn't focus on the subject, the auto focus frame turns to red.

• OSD(On Screen Display) information

- In any mode with the exception of VOICE RECORDING mode, you can check the recording status in the LCD monitor.
- Idle mode : If you select the [LCD Save] and the camera isn't operated during the specified time(about 30 SEC.), the camera power will become idle automatically (LCD monitor : OFF, Camera status lamp : Blinking).
 - To use the camera again, press any of the camera buttons except the power button.
 - If there is no operation during the specified time, the camera power will be turned off automatically to save battery life. Refer to page 58 for more information about the auto power off function.



Starting play mode

- Turn the camera on and select Play mode by pressing the play mode button (). The camera can now play back the images stored in the memory.
- If the memory card is inserted in the camera, all the camera functions apply only to the memory card.
- If the memory card is not inserted in the camera, all the camera functions apply only to the internal memory.

● Playing back a still image

1. Select the PLAY mode by pressing the play mode button ().



2. The last image stored on the memory is displayed on the LCD monitor.



3. Select an image that you want to view by pressing the LEFT/ RIGHT button.



※ Press and hold the LEFT or RIGHT button to play back the images quickly.

INFORMATION

- Manner mode : Pressing the power button for more than 3 seconds changes the buzzer and start-up sound setting to OFF, even though you may have set these to ON.

● Playing back a movie clip

1. Select the recorded movie clip that you want to play back by using the LEFT/RIGHT button.



2. Press the play & pause button () to play back a movie clip file.

- To pause a movie clip file while playing it back, press the play & pause button again.

- Pressing the play & pause button again will cause the movie clip file will restart.

- To rewind the movie clip while it is playing, press the LEFT button. To fast forward the movie clip, press the RIGHT button.

- To stop playback of the movie clip, press the play & pause button, and then press the LEFT or RIGHT button.



■ Movie clip capture function : capture still images from the movie clip.

● How to capture the movie clip

1. Press the Play/ Pause button while playing the movie clip. Then press the E button.



[Paused]

2. The paused movie clip is saved in a new file name.

※ The captured movie clip file has same size as the original movie clip (720X480, 640X480, 320X240).

※ When you press the E button at the beginning of the movie clip, the first frame of the movie clip will be save as a still image.



[Press the E button]

Starting play mode

- On camera movie trimming : You can extract desired frames of movie clip during the movie clip play back.
- If the running time is under 10 seconds, the movie clip can't be trimmed.
 - Press the Pause button at the point of the movie clip that you want to start extracting.
 - Press the T button.
 - Press the Play & Pause button and the extracted range will be displayed on the status bar.
 - Press the Play & Pause button once more at the point where you wish the extracted file to stop.
 - Press the T button and a confirmation window will display.
 - Select a desired sub menu by pressing the Left/ Right button and press the OK button.
[Yes] : The extracted frames are saved as a new file name.
[No] : The movie trimming will cancel.



INFORMATION

- When a voice is playing back, you can use the earphones.
- If you want to extract the movie clip at the beginning of the frame, press the Zoom T button before starting the movie clip.
- If the time line bar passes by the start point by pressing the REW(Left) button, the first frame of the movie clip will display.
- If you don't specify the ending point of the movie clip, the trimming confirmation window will display at the point of the last frame.

- Playing back a recorded voice
 - Select the recorded voice that you want to play back by using the LEFT/ RIGHT button.
 - Press the play & pause button () to play back a recorded voice file.
 - To pause a recorded voice file, while playing it back, press the play & pause button again.
 - To resume playback of the voice file, press the play & pause button
 - To rewind the voice file while it is playing, press the LEFT button. To fast forward the voice file, press the RIGHT button.
 - To stop playback of the voice file, press the play & pause button, and then press the LEFT or RIGHT button.
 - When a voice is playing back, you can use the earphones.



LCD monitor Indicator

- The LCD monitor displays shooting information about the displayed image.

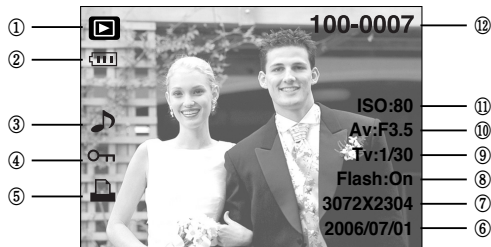

No.	Description	Icon	Page
1	Play mode icon		-
2	Battery		p.12
3	Voice Memo		p.44
4	Protect		p.49
5	DPOF		p.51
6	Recording date	2006/07/01	-
7	Image size	3072X2304 ~ 640X480	p.36
8	Flash	On/Off	p.24
9	Shutter speed	15 ~ 1/2000	p.30
10	Aperture value	F3.5 ~ F4.5	p.30
11	ISO	80 ~ 1000	p.28
12	Folder name & File name	100-0007	p.58

Using the camera buttons to adjust the camera

- In Play mode, you can use the buttons on the camera to conveniently set up the Play mode functions.

Play mode button

- If you have turned on the camera by pressing the POWER button, you can press the PLAY MODE button once to switch to Play mode and press it again to switch to Recording mode.
- You can turn the power on with the play mode button. The camera is turned on in play mode. Press the play mode button (Under 1 Sec.) again to turn off the camera.
- When pressing the Play mode button for over 1 second, you can check the recording information.



- When you press the Play mode button in the PMP, MP3, TEXT VIEWER mode, the play list of each mode will display.

Thumbnail() / Enlargement() button/ Volume button()

- You can view multiple pictures, enlarge a selected picture, and crop and save a selected area of an image.
- When a movie clip, voice memo or voice recording file is playing back, you can control the volume of those files using this button.
- Thumbnail display
 1. While an image is displayed full screen, press the thumbnail button.
 2. The thumbnail display will highlight the image that had been showing at the time the thumbnail mode was selected.
 3. Press the 5 function button to move to a desired image.
 4. To view an image separately, press the enlargement button.



[Normal display mode]

Pressing the Thumbnail button()



Pressing the enlargement button ()



[Thumbnail display mode]

- Image enlargement
 1. Select an image that you want to enlarge and press the enlargement button.
 2. Different parts of the image can be viewed by pressing the 5 function button.
 3. Pressing the thumbnail button will zoom back to the original full sized image.
 - You can tell whether the image displayed is an enlarged view by checking the image enlargement indicator shown at the bottom left of the LCD monitor. (If the image is not an enlarged view, the indicator will not be displayed.) You can also check the area of enlargement.
 - Movie clips and WAV files can't be enlarged.
 - If an image is enlarged, a loss of quality may occur.



- The maximum enlargement in proportion to the image size.

Image size	7"	6"	5"	5"	4"	3"	2"	1"	VGA
Maximum enlargement	X12.0	X11.0	X10.1	X12.0	X8.9	X8.0	X6.3	X4.0	X2.5

Thumbnail () / Enlargement () button / Volume button ()

- **Trimming** : You can extract part of the image and save it separately.
 1. Select an image that you want to enlarge and press the enlargement button.
 2. Different parts of the image can be viewed by pressing the 5 function button.
 3. Press the MENU button and a message will be displayed as shown alongside.
 4. Select a desired sub menu by pressing the UP/ DOWN button and press the OK button.
 [Yes] : The trimmed image will save as a new file name, and display on the LCD monitor.
 [No] : The trimming menu will disappear.

※ If there is insufficient memory space to save the trimmed image, the image can't be trimmed.

※ To delete the enlarged image during the trimming function, press the delete button.
- **Volume control** : When a movie clip, voice memo or voice recording file is playing back, you can control the volume using this button.





[Movie Clip : Stop]



[Movie Clip : Playing back]

Voice () memo / Up button

- When the menu is displayed on the LCD monitor, the UP button operates as a direction button.
- When the menu is not displayed on the LCD monitor, the UP button operates as the voice memo button. You can add your voice to a stored still image.
- **Adding a Voice Memo to a Still Image**
 1. Press the LEFT/ RIGHT button to select an image that you wish to add sound to.
 2. Press the voice memo button () and the voice memo indicator will display. The camera is now ready to record a voice memo.
 3. Press the shutter button to start recording and voice will be recorded to the still image for 10 seconds. While the voice is recording, the recording status window will be displayed as shown alongside. The recording can be stopped by pressing the shutter button again.
 4. The () icon will be displayed on the LCD monitor after voice memo recording has finished.
 - The voice memo will be saved in * .wav format, but has the same file name as the still image to which it corresponds.
 - If you add a new voice memo to the still image that already has a voice memo, the existing voice memo will be erased.



• Play & Pause ()/ Down button

- In Play mode, the play & pause/ down button works as follows:
 - If the menu is displayed
Press the DOWN button to move from the main menu to a sub menu, or to move down the sub menu cursor.
 - If a still image with a voice memo, a voice file, or a movie clip is playing
In Stop mode : Plays a still image with a voice memo, a voice file, or a movie clip.
During playback : Temporarily stops playback.
In Pause mode : Resumes playback



[Voice recording is stopped]

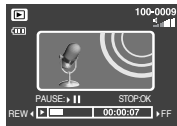

[Voice recording is playing]



[Voice recording is paused]

• Left/ Right/ Menu/ OK button

- LEFT/ RIGHT/ MENU/ OK buttons activate the following.
 - LEFT button : While the menu is showing, the LEFT button operates as a direction button. While the menu is not showing, press the LEFT button to select the previous image.
 - RIGHT button : While the menu is showing, the RIGHT button operates as a direction button. While the menu is not showing, press the RIGHT button to select the next image.
 - MENU button : When you press the MENU button, the play mode menu will be displayed on the LCD monitor. Pressing it again will return the LCD to the initial display.
 - OK button : When the menu is displayed on the LCD monitor, the OK button is used for confirming data that is changed by using the 5 function button.

• E (Effect) button

Colour

- By using the camera's digital processor, it is possible to add special effects to your images.

1. Select a still image or movie clip and press the  button.

2. Select a desired sub menu and press the OK button.

- BW** : Captured images will be stored in black and white.
- S** : Captured images will be stored in a sepia tone.
- R** : Captured images will be stored in a red tone.
- G** : Captured images will be stored in a green tone.
- B** : Captured images will be stored in a blue tone.
- I** : Save the image in negative mode.



Red eye reduction

- When a shot with "red eye" is played back, pressing this button can remove the red eye from the subject.

1. Select a still image and press the E button.

2. Select  menu by pressing the Left / Right button.

3. Press **On** the Down button and the red-eye will be edited.

4. Press the OK button and the changed image will save as a new file name.

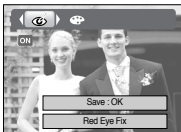

• Delete () button

- This deletes images stored on the memory card.

1. Select an image that you want to delete by pressing the LEFT/ RIGHT button and press the DELETE() button.

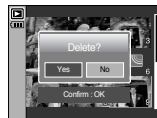
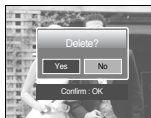

2. Select the submenu values by pressing the Left/ Right button and then press the OK button.

If [Yes] is selected : deletes the selected images.

If [No] is selected : cancels "Delete Image".

• Printer () button

- If the [USB] menu is set to the [Computer], you cannot connect a Pictbridge compatible printer to the camera through USB cable with [Connecting Computer] message. By pressing the Printer button, at this point, you can connect the easy printing mode with [Connecting Printer] message.







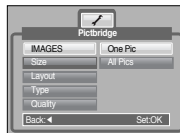

* In some instances the camera may not connect to the printer, this will depend on the make of the printer.



- After the connection, the Easy printing menu will display on the LCD monitor. To display the PictBridge menu, press the Menu button. For more information about the PictBridge menu, refer to page 54.



Setting up the play back function using the LCD monitor

- PLAY mode functions can be changed by using the LCD monitor. In the PLAY mode, pressing the MENU button displays the menu on the LCD monitor. The menus you can set up in Play mode are as follows. To capture an image after setting up the play menu, press the PLAY mode button or shutter button.

Menu tab	Main menu	Sub menu	Secondary menu	Page
	SLIDE	Show	Play, Repeat Play	p.48
		Interval	1, 3, 5, 10sec	
		Effect	Off 	
	PROTECT	Select	Unlock / Lock	p.49
		All Pics		
	DELETE	Select	-	p.50
		All Pics	-	
	RESIZE	2816X2112	-	p.50
		2048X1536	-	
		1024X768	-	
		640X480	-	
		Start Image	-	
		MP3 Skin	-	
		MP3 Skin	-	
	ROTATE	Right 90 °	-	p.51
		Left 90 °	-	
		180 °	-	
		Horizontal	-	
		Vertical	-	
	DPOF	Standard	Select/ All Pics/ Cancel	p.51
		Index	No / Yes	
		Size	Select/ All Pics/ Cancel	

Menu tab	Main menu	Sub menu	Secondary menu	Page
	OSD INFORMATION	Full	-	p.53
		Basic	-	
		OSD Off	-	
	COPY TO CARD	No	-	p.54
		Yes	-	

- This menu is available while the camera is connected to a PictBridge supporting printer (direct connection to the camera, sold separately) with a USB cable.

Menu tab	Main menu	Sub menu	Secondary menu	Page
	IMAGES	One Pic	-	p.55
		All Pics	-	
	Size	Auto	-	p.56
		PostCard	-	
		Card	-	
		4X6	-	
		L	-	
		2L	-	
		Letter	-	
		A4	-	
		A3	-	
		Auto	-	
	Layout	Full	-	
		1	-	
		2	-	
		4	-	
		8	-	
9		-		
16		-		
Index	-			

Setting up the play back function using the LCD monitor

Menu tab	Main menu	Sub menu	Secondary menu	Page
✍	Type	Auto	-	p.56
		Plain	-	
		Photo	-	
		FastPhoto	-	
	Quality	Auto	-	
		Draft	-	
		Normal	-	
		Fine	-	
	Date	Auto	-	
		Off	-	
		On	-	
	File Name	Auto	-	
		Off	-	
		On	-	
	RESET	No	-	p.56
Yes		-		

※ Menus are subject to change without prior notice.

Starting the slide show

- Images can be displayed continuously at pre-set intervals. You can view the slide show by connecting the camera to an external monitor.

- Select the [Show] sub menu by pressing the UP/DOWN button and press the RIGHT button.
- Use the Up/Down buttons to select the desired sub menu.
[Play] selected :
The slide show is closed after one cycle.
[Repeat Play] selected :
The slide show is repeated until cancelled.
- Press the OK button to start the slide show.



- Press the Pause button to pause the slide show.
- Press the Pause button (**PAUSE**) again to resume the slide show.
- To stop the slide show, press the play & pause button, and then press the LEFT or RIGHT button.

- Repeat setting : Setting the slide show to repeat after the first cycle.

- Use the Up/ Down buttons to select the Interval menu and press the Right button.
- Use the Up/ Down buttons to select the desired sub menu.
- Press the OK button to save the configuration.

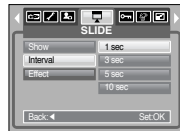

INFORMATION

- The loading time depends on the image size and quality.
- While the slide show is playing, only the first frame of a MOVIE file is displayed.
- While the slide show is playing, the voice recording file will not display.

Starting the slide show

- Configure slide show effects : Unique screen effects can be used for the slide show.

1. Select the [Effect] sub menu by pressing the UP/ DOWN button and press the RIGHT button.
2. Use the Up/ Down Button to select the type of effect.



Off : Normal display.

f : Image is displayed slowly.

☒ : Image is displayed slowly from the centre outwards.

↖ : Image moves from the top left.

↘ : The image slides diagonally from top left to bottom right.

MIX : The image slides irregularly.

3. Press the OK button to confirm the setting.

Protecting images

- This is used to protect specific shots from being accidentally erased (Lock). It also unprotects images that have been previously protected (Unlock).

Protecting Images

1. Select a desired sub menu by pressing the UP/ DOWN button and press the OK button.

[Select] : Selection window for an image to be protected/released is displayed.

- Up/ Down/ Left/ Right : Select an image

- Zoom W/T Button : Protect/ release the image

- OK Button : Your changes will be saved and the menu will disappear.

[All Pics] : Protect/ release all saved images

- Zoom W/T Button : Protect/ release the images

- OK Button : Your changes will be saved and the menu will disappear.

- If you protect an image, the protect icon will be displayed on the LCD monitor.

(An unprotected image has no indicator)

- An image in LOCK mode will be protected from the delete function, but will NOT be protected from the format function.

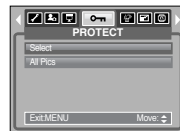

Deleting images

- Of all the files stored in the memory card, the unprotected files in the DCIM subfolder will be deleted. Remember that this will permanently delete unprotected images. Important shots should be stored on a computer before deletion takes place. The startup image and SKIN image are stored in the camera's internal memory (i.e., not on the memory card) and it will not be deleted even if you delete all files on the memory card.

Deleting images

- Select a desired sub menu by pressing the UP/ DOWN button and press the OK button.

[Select] : Selection window for an image to delete is displayed.

- Up/ Down/ Left/ Right : Select an image
- Zoom T Button : Select the image for deletion. (V mark)

- OK Button : Press the OK Button to display the confirmation message. Select the [Yes] menu and press the OK button to delete marked images.

[All Pics] : Displays confirmation window. Select the [Yes] menu and press the OK button to delete all unprotected images. If there aren't protected images, all the images are deleted and a [No Image!] message will display.

- After deletion, the screen will be changed to the play mode screen.

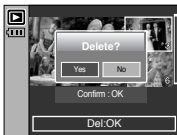

Resize

- Change the resolution(size) of pictures taken. Select [Start image],[MP3 Skin] to save an image to be the start-up image, MP3 Skin.

- Select a desired sub menu by pressing the UP/ DOWN button and press the OK button.



Image Resize Types (O : Selectable X : Not Selectable)

Size	2816X2112	2048X1536	1024X768	640X480	Start Image	MP3 Skin
7M	O	O	O	O	O	O
6M	X	O	O	O	O	O
5M	X	O	O	O	O	O
4M	X	O	O	O	O	O
3M	X	X	O	O	O	O
2M	X	X	O	O	O	O
1M	X	X	X	O	O	O
VGA	X	X	X	X	O	O

INFORMATION

- You can change the resolution of only those files compressed in the JPEG 4:2:2 format.
- The resized image will have a new file name. The [Start Image, MP3 Skin] image is stored not on the memory card but on the internal memory.
- Only two [Start Image, MP3 Skin] images can be saved. If you save a new [Start Image, MP3 Skin] image, the existing startup image will be deleted in order.
- If the memory capacity is insufficient to store the resized image, a [Memory Full!] message will display on the LCD monitor and the resized image will not be stored.
- The picture taken with 5M(Wide) can be resized only to 2560X1440, 1920X1080, 1280X720.

Rotating an image

- You can rotate the stored images by various degrees. Once the playback of the rotated picture is finished, it will switch back to the original state.

1. Select a desired sub menu by pressing the UP/ DOWN button.

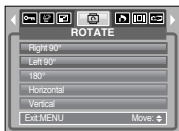

[Before rotating the image]



[Right 90°]

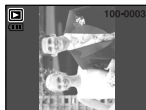

[Left 90°]



[180°]



[Horizontal]



[Vertical]

2. Press the OK button and the rotated image will be displayed. If you display the rotated image on the LCD monitor, empty spaces may appear to the left and right of the image.

DPOF

- DPOF (Digital Print Order Format) allows you to embed printing information on your memory card's MISC folder. Select the pictures to be printed and how many prints to make.
- The DPOF indicator will display on the LCD monitor when an image that has DPOF information plays back. Images can then be printed on DPOF printers, or at an increasing number of photo labs.
- This function is not available for Movie clips and Voice recording files.
- If a memory card is not inserted, the menus are still displayed in the LCD, but are not selectable.

DPOF : STANDARD

- This function allows you to embed print quantity information on a stored image.

1. Select the [Standard] menu by pressing the UP/ DOWN button and press the RIGHT button.
2. Select a desired sub menu by pressing the UP/ DOWN button.

[Select] : Selection window for an image to print is displayed.

- Up/ Down/ Left/ Right : Select an image to print.

- Zoom W/T Button : Select the number of prints.

[All Pics] : Configure number of prints for all pictures except movie and voice files.

- W/T button : Select a number of prints

[Cancel] : Cancel the print setup.

3. Press the OK button to confirm the setting.

If an image carries DPOF instructions, the DPOF indicator () will show.

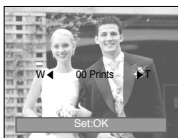

DPOF : Index

- Images (except for movie clips and voice file) are printed as index type.

1. Select the [Index] menu by pressing the UP/ DOWN button and press the RIGHT button.
2. Select a desired sub menu by pressing the UP/ DOWN button.

If [No] is selected : Cancel the index print setting.

If [Yes] is selected : The image will be printed in index format.

3. Press the OK button to confirm the setting.

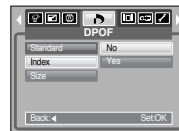

DPOF : Print size

- You can specify the print size when printing images stored on the memory card. The [Size] menu is available only for DPOF 1.1 compatible printers.

Setting the Print Size

- Select the [Size] menu by pressing the UP/ DOWN button and press the RIGHT button.
- Select a desired sub menu by pressing the UP/ DOWN button and press the OK button.

[Select] : Selection window to change the print size of an image is displayed.

- Up/ Down/ Left/ Right : Select an image.
- Zoom W/T Button : Change the print size.
- OK button : Your changes will be saved and the menu will disappear.

[All Pics] : Change print size of all saved images.

- W/ T button : Select a print size
- OK button : Confirm the changed setting.

[Cancel] : Cancel all of the print size settings.

※ DPOF [Size] secondary menu : Cancel, 3X5, 4X6, 5X7, 8X10

※ Depending on the manufacturer and printer model, cancelling the printing may take a little longer for the printer to process.

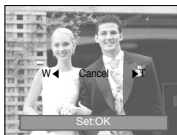

On Screen Display information

- You can check shooting information about the displayed image.

- Select a desired sub menu by pressing the UP/ DOWN button and press the OK button.

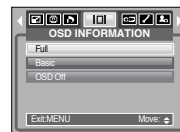

[Full]



[Basic]



[OSD Off]

Copy To Card

- This enables you to copy image files, movie clips and voice recording files on the camera's built-in internal memory to the camera's removable SD memory card.
- Copying to the Memory Card
 1. Select a desired sub menu by pressing the UP/ DOWN button and press the OK button.
 - [No] : Cancels "Copy to Card".
 - [Yes] : All images, movie clips and voice recording files saved in the internal memory are copied to the memory card after the [Processing!] message is displayed. After copying has been completed, the screen will return to play mode.

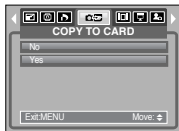

INFORMATION

- When this menu is selected without inserting a memory card, you can select the [COPY TO CARD] menu but the menu can't be run.
- If there is not enough space available in the memory card to copy saved images in the internal memory (15MB), the [COPY TO CARD] command will copy only some of the images and display [Memory Full!] message. Then the system will return to the playback mode. Please be sure to delete any unnecessary files to free up space before inserting the memory card into the camera.
- When you move images from the internal memory to the removable SD card, they will be automatically renumbered to avoid duplication of the file name. If the last file in the memory card is SNV30010.jpg, the copied file names start from SNV30011.jpg. After completing [COPY TO CARD], the last stored image of the last copied folder is displayed on the LCD monitor.

PictBridge

- You can use the USB cable to connect this camera to a printer that supports PictBridge (sold separately) and print the stored images directly. Movie clips and voice files cannot be printed.
- Setting up the camera for connection to the printer
 1. In any mode with the exception of Voice Recording mode, press the MENU button.
 2. Press the LEFT/ RIGHT button and select [SETUP] menu tab.
 3. Select [USB] menu by pressing the UP/ DOWN button and press the RIGHT button.
 4. Select [Printer] menu by pressing the UP/ DOWN button and press the OK button.
- Connecting the Camera to a Printer
 - Using the USB cable with Cradle : Connect the camera and the cradle. Connect the cradle to a printer's USB port with the supplied USB cable.
 - Using the USB cable with Camera : Connect the camera to a printer's USB port with the supplied USB cable.



[Using the USB cable with Cradle]



[Using the USB cable with Camera]



PictBridge

※ If the [USB] menu is set to the [Computer], you cannot connect a Pictbridge compatible printer to the camera through USB cable with [Connecting Computer] message. By pressing the Printer button, at this point, you can connect the easy printing mode with [Connecting Printer] message. In some instances the camera may not connect to the printer, this will depend on the make of the printer.

■ Easy printing

When you connect the camera to printer in the Play back mode, you can print a picture easily.

- Pressing the printer () button :

Currently displayed image will be printed with the printer's default setting.

- Pressing the Left / Right button :

Selects a previous / next image.



PictBridge : Picture Selection

■ You can select images you want to print

● Setting the Number of Copies to Print

1. Press the Menu button and the PictBridge menu will display.

2. Use the Left and Right buttons to select the [IMAGES] menu.

3. Use the Up and Down buttons to select a desired sub menu and press the OK button.

- Select [One Pic] or [All Pics]. A screen where you can set the number of copies to print will appear as shown below.

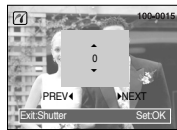
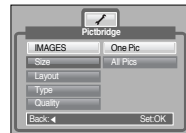

[When [One Pic] is selected]



[When [All Pics] is selected]

- Press the Up/ Down button to select the number of prints.

- When [One Pic] is selected : Use the Left/ Right button to select another picture. After selecting another picture, select the number of prints for another picture.

- After setting the number of prints, press the OK button to save.

- Press the Shutter button to return to the menu without setting the number of prints.

4. Press the Print button () and images will be printed.

• PictBridge : Print Setting

- You can select the Paper Size, Print Format, Paper Type, Print Quality, Date Print, and File Name Print menus for printed pictures.

1. Press the Menu button and the PictBridge menu will display.
2. Use the UP and DOWN buttons to select the desired menu, and then press the RIGHT button.
3. Use the UP and DOWN buttons to select the desired submenu value, and then press the OK button.

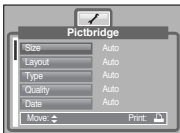

- The menus you can set up are as follows:

Menu	Function	Sub menu
Size	Set the size of the printing paper	Auto, PostCard, Card, 4X6, L, 2L, Letter, A4, A3
Layout	Set the number of pictures to be printed on a sheet of paper	Auto, Full, 1, 2, 4, 8, 9, 16, Index
Type	Set the quality of the printing paper	Auto, Plain, Photo, FastPhoto
Quality	Set the quality of the picture to be printed	Auto, Draft, Normal, Fine
Date	Set whether to print the date	Auto, Off, On
File Name	Set whether to print the file name	Auto, Off, On

- ※ Some menu options are not supported on all printers.
If not supported, the menus are still displayed in the LCD, but are not selectable.

• PictBridge : Reset

- Initialises user-changed configurations.

1. Use the Up and Down buttons to select the [RESET] menu tab. And then press the Right button.
2. Use the UP and DOWN buttons to select the desired sub menu value, and then press the OK button.

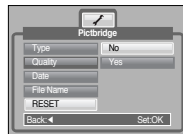







If [Yes] is selected : All print and image settings will be reset.







If [No] is selected : Settings will not be reset.

- ※ Default print setting varies depending on the printer manufacturer.
For your printer's default setting, refer to the user's guide that came with your printer.

Setup menu

- In this mode, you can set up basic settings. In any camera modes, except Voice Recording and MP3, PMP, TEXT VIEWER modes, press the MENU button. Press the LEFT/RIGHT button and select the [SETUP] menu tab. The items indicated by  are default settings.

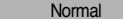
Menu tab	Main menu	Sub menu	Secondary menu	Page	
	File	Series 	-	p.58	
		Reset	-		
	Power Off	1,  , 5, 10min	-	p.58	
	Language	ENGLISH	한국어	FRANÇAIS	p.58
		DEUTSCH	ESPAÑOL	ITALIANO	
		简体中文	繁體中文	日本語	
		РУССКИЙ	PORTUGUÊS	DUTCH	
		DANSK	SVENSKA	SUOMI	
		ไทย	BAHASA	عربي	
		POLSKI	Magyar	Čeština	
		Türkçe	-	-	
	Format	No 	-	p.59	
		Yes	-		
	Date&Time	06/07/01 13:00	-	p.59	
		 yy/mm/dd	-		
		dd/mm/yy	-		
		mm/dd/yy	-		
		Off	-		
Imprint	Off 	-	p.59		
	Date	-			
	Date&Time	-			

Menu tab	Main menu	Sub menu	Secondary menu	Page
	Sound	Off	-	p.60
		Low	-	
		Medium 	-	
		High	-	
	USB	Computer 	-	p.60
		Printer	-	
	AF Sound	Off	-	p.60
		On 	-	
	AF Lamp	Off	-	p.60
		On 	-	
	LCD	Dark	-	p.61
		Normal 	-	
		Bright	-	
	Video Out	NTSC 	-	p.61
		PAL	-	
	Quick View	Off/  0.5, 1, 3sec	-	p.62
	Reset	No 	-	p.62
		Yes	-	

※ Menus are subject to change without prior notice.

Setup menu

[File name]

- This function allows the user to select the file naming format.

[Series] : New files are named using numbers that follow the previous sequence, even when a new memory card is used, or after formatting, or after deleting all pictures.

[Reset] : After using the reset function, the next file name will be set from 0001 even after formatting, deleting all or inserting a new memory card.

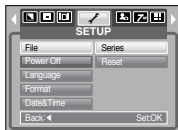

[Auto power off]

- This function switches the camera off after a set amount of time in order to prevent unnecessary battery drainage.

[1, 3, 5, 10min] : The power will turn off automatically if not used for the period of time specified.

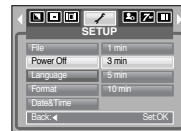

INFORMATION

- The first stored folder name is 100SSCAM, and the first file name is SNV3XXXX.
- File names are assigned sequentially from SNV30001 → SNV30002 → ~ → SNV39999.
- The folder number is assigned sequentially from 100 to 999 as follows: 100SSCAM → 101SSCAM → ~ → 999SSCAM.
- The files used with the memory card conform to the DCF(Design rule for Camera File systems) format.

INFORMATION

- Even if the battery and AC charger are removed and inserted again, the power off setting will be preserved.
- Note that the automatic power off function will not operate if the camera is; in PC / Print mode, slide show, playing back a voice recording, playing back a movie clip or playing back an MP3/ PMP file.

[Language]

- There is a choice of languages that can be displayed on the LCD monitor. Even if the battery and AC charger are removed and inserted again, the language setting will be preserved.

LANGUAGE sub menu :

English, Korean, French, German, Spanish, Italian, S.Chinese, T.Chinese, Japanese, Russian, Portuguese, Dutch, Danish, Swedish, Finnish, Thai, BAHASA(MALAY/INDONESIAN), Arabic, Polish, Hungarian, Czech and Turkish.



Setup menu

[Format]

- This is used for formatting the memory. If you run [Format] on the memory, all images, including the protected images MP3, TEXT and PMP files will be deleted. Be sure to download important images to your PC before formatting the memory.

If [No] is selected : The memory card will not be formatted. Press the menu button twice and the menu display will disappear.

If [Yes] is selected : A [Processing!] message appears and the memory card will be formatted. If you ran FORMAT in Play mode, a [No Image!] message will appear.

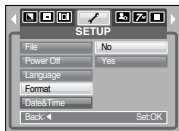

[Setting up the Date/ Time/ Date type]

- You can change the date and time that will be displayed on the captured images and set up the date type.

RIGHT button : Selects the year/ month/ day/ hour/ minute date type.

LEFT button : Moves the cursor to the [Date&Time] main menu if the cursor is at the first item of the date and time setup. In all other cases, the cursor will be shifted to the left of its current position.

UP and DOWN buttons : Changes the setting value.

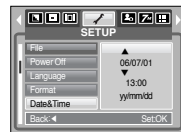

[Imprinting the recording date]

- There is an option to include DATE/ TIME on still images.

[Off] : The DATE & TIME will not be imprinted on the image file.

[Date] : Only the DATE will be imprinted on the image file.

[Date&Time] : The DATE & TIME will be imprinted on the image file.

- ※ The Date & Time are imprinted at the bottom right side of the still image.
- ※ The imprint function is applied only to still images except for the images taken in the [Text] scene mode and photo frame effect mode.
- ※ Depending on the manufacturer and print mode, the date printed on an image may not be printed correctly.



INFORMATION

- This is used for formatting the memory. If you run [Format] on the memory, all images, including the protected images, MP3, PMP and TEXT files, will be deleted. Be sure to download important images and files to your PC before formatting the memory.
- Always format the memory card using this camera. If you insert a memory card that has been formatted using other cameras, memory card readers, or PCs, you will get a [Card Error!] message.

Setup menu

[Sound]

- If you set the operation sound to on, various sounds will be activated for camera startup when buttons pressed, so that you can be aware of the camera operation status.
- [Sound] sub menu : Off/ Low/ Medium/ High



[Connecting an External Device (USB)]

- You can select an external device to which you want to connect the camera using the USB cable.

[Computer] : Select this if you want to connect the camera to your PC. Refer to page 82 for instructions on how to connect the camera to your PC.

[Printer] : Select this if you want to connect the camera to your printer. Refer to page 54 for instructions on how to connect the camera to your printer.



[AF Sound]

- If you set the operation sound to ON, various sounds will be activated for camera startup so that you can be aware of the camera operation status.



[Auto Focus lamp]

- You can turn the Auto Focus lamp on or off.

If [Off] is selected : The AF lamp will not light up.

If [On] is selected : The AF lamp will light up.

- ※ If you select [Off] menu and take an image in poorly lit conditions or select the [Night scene] mode, the camera may not be able to focus accurately.
- ※ The Auto Focus lamp will function while using the self-timer even if the configuration is set to off.



• Setup menu

[LCD brightness]

- You can adjust the LCD brightness.



[Selecting Video out type]

- The Movie output signal from the camera can be NTSC or PAL. Your choice of output will be governed by the type of device (monitor or TV, etc.) to which the camera is connected. PAL mode can support only BDGHI.



- Connecting to an external monitor

[Using the AV cable with Cradle]



[Using the AV cable with Camera]

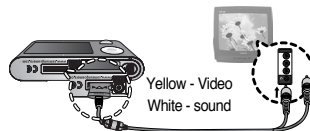

Setup menu

INFORMATION

- NTSC : U.S.A, Canada, Japan, South Korea, Taiwan, Mexico.
- PAL : Australia, Austria, Belgium, China, Denmark, Finland, Germany, U.K., Holland, Italy, Kuwait, Malaysia, New Zealand, Singapore, Spain, Sweden, Switzerland, Thailand, Norway.
- When using a TV as an external monitor, you will need to select the external or AV channel of the TV.
- There will be a digital noise on the external monitor, but it is not a malfunction.
- If the image is not in the centre of the screen, use the TV controls to centre it.
- The menu functions are the same as those indicated on the LCD monitor.

[Quick view]

- If you enable Quick View before capturing an image, you can view the image you just captured on the LCD monitor for the duration set in the [Quick View] setup. Quick view is possible only with still images.

[Off] : The quick view function can't be activated.

[0.5, 1, 3sec] : The captured image is briefly displayed during the selected time.

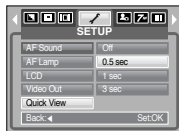

[Initialisation]

- All camera menu and function settings will be restored to their default values. However, values for DATE/TIME, LANGUAGE, and VIDEO OUT will not be changed.

If [No] is selected :

Settings will not be restored to their defaults.

If [Yes] is selected :

All settings will be restored to their defaults.

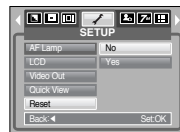

Setting up the Mycam menu

- You can set up a start up image, start up sound and shutter sound. Every working mode of camera (with the exception of Voice recording, MP3, PMP, and TEXT VIEWER modes) has the MyCAM menu. The items indicated by are default settings.

Menu tab	Main menu	Sub menu		Page
	Start Image	Off	LOGO	p.63
		User Image 1	User Image 2	
	Start Sound	Off	Sound 1	p.63
		Sound 2	Sound 3	
	Shutter Sound	Off	Sound 1	p.63
		Sound 2	Sound 3	

※ Menus are subject to change without prior notice.

Start up image

- You can select the image that is first displayed on the LCD monitor whenever the camera is turned on.
- Use a saved image for the start-up image with the [Start Image] in the [RESIZE] menu in the play mode.
- The start-up image will not be deleted by deleting all images or [Format] menu.
- The User images will be deleted by [Reset] menu.



Start up sound

- You can select the sound that is activated whenever the camera is turned on.
- If the start up image is set to [Off], the start up sound will not activate, even though you may have set these to on.



Shutter sound

- You can select the shutter sound.



MP3/ PMP/ TEXT VIEWER Mode

- This camera has an embedded MP3, TEXT VIEWER & Portable Media Player program. You can take a picture, listen to the MP3 files and watch the movie clip (Movie and Video clip) whenever you want. To use the PMP mode, you must convert the multimedia file with the Digimax Converter. In the TEXT VIEWER mode you can see the text on the LCD monitor with listening MP3 music.
- If the file name is over 128 (2 Byte language like Korean, Chinese, etc.) or 256 (1 Byte language like English) characters, the file name doesn't display on the playlist.

Downloading files

- To use MP3, PMP and TEXT VIEWER functions, MP3, PMP(multimedia files) and TEXT files must be saved in the internal memory or memory card of this camera.
 - Save the desired files on your PC.
 - Connect the camera to your PC with the USB cable and turn on the camera.
 - Open Window's EXPLORER and search for [Removable Disk].
 - Make a folder under the Removable Disk.

- MP3 Mode : [MP3]

- PMP Mode : [PMP]

-TEXT VIEWER mode
: [TEXT]

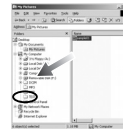
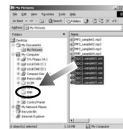
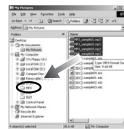

- Select desired files that you want to save and copy them to the desired folder.

• Downloading files

INFORMATION

- Take care of the illegal duplication of MP3 & multimedia files. It violates various copyright laws.
- This camera can only play back MP3 files in the MP3 mode and SDC files (modified XviD MPEG4 video / MPEG Layer2 audio type) in the PMP mode.
- If a file can not be played back on this camera, convert it into the supported file format by using the Digimax Converter. (p.86)
- Up to 200 files can be saved in a folder.
- You can make up to 100 subfolders under the MP3 or PMP folder. You can't make subdirectories under the subfolder.

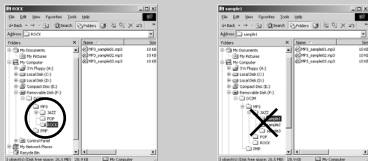

• Starting the MP3/PMP/TEXT VIEWER mode

- Insert the memory card that holds MP3, PMP and TEXT files. As this camera has a 15MB internal memory, you can save the files on the internal memory too.

1. Select the MP3/PMP/TEXT VIEWER mode by rotating the mode dial.
2. A menu will display as shown.



[Resume] : memorizes the latest stopped frame.

MP3 mode : plays back from the beginning of the file.

PMP mode : plays back from the latest stopped frame

TEXT VIEWER mode : plays back from the latest stopped frame

[Open] : The browsing menu will display to select a desired file

3. Select a desired file and press the OK button. And then the file will play back.

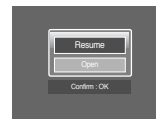

Starting the MP3/ PMP/ TEXT VIEWER mode

[MP3 mode]

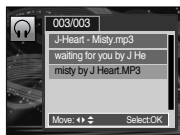

[PMP mode]

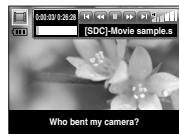
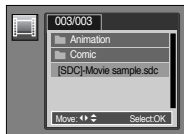

[TEXT VIEWER mode]

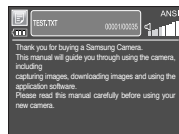
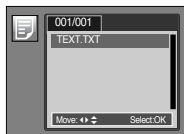

INFORMATION

- When the [Resume] menu (p.70) of each mode are set as [Off], the browsing menu doesn't open. If the last played file was deleted, the browsing menu opens though the setting is same as above.
- In the PMP mode, icons on the LCD monitor will disappear after 5-6 seconds.
- The order of play lists on the browsing menu and the order of file saved in the memory are the same.
- A title coded with unsupported language is displayed as "-----".
- The automatic power off function will not operate if the a file is playing back.
- If there over 100 files in the memory, it takes a little longer for the camera to process to the MP3/ PMP mode.
- If there is no operation during the specified time (About 30 sec.) in the MP3 / TEXT VIEWER mode (B.G.M : Off, Auto scroll : Off), the LCD monitor is turned off automatically and the camera status lamp blinks. To use the camera, press any of the camera buttons except the Power button.
- Playing back the VBR (Variable Bit Rate) file. A VBR file varies the amount of output data in each time segment based on the complexity of the input the data in that segment. When the VBR encoded files are played back, the LCD will display as shown.
 - The VBR icon will display instead of the Bit rate icon.
 - The time line isn't displayed.
 - Playing time will display but the whole running time doesn't display.
- For about 2 seconds of the start and end frames of the PMP file, no camera button except the Power button can be operated.
- When an MP3 file doesn't play back correctly, download a free MP3 conversion program and convert it before using the MP3 file on the camera .

LCD monitor indicator for MP3/PMP/TEXT VIEWER mode

- The LCD monitor displays information about the MP3, multimedia and Text file.

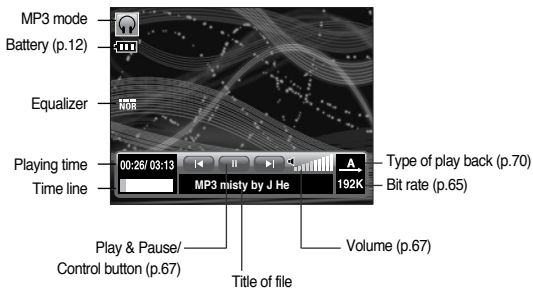

[MP3 mode]



[PMP mode]

- When you playback a movie converted with the Digimax Converter, there may be a white spot under the LCD monitor of the camera. It's not the camera malfunction and there are no problems to use the camera.

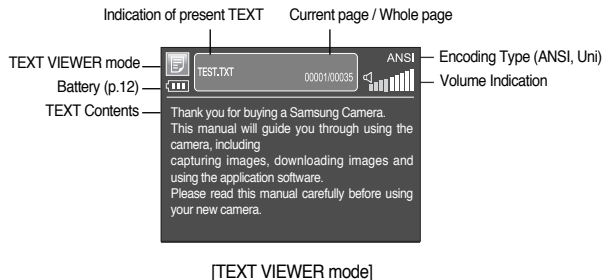

- Encoding Type : ANSI(American National Standards Institute) Type, Uni (Unicode) Type

- When the ANSI encoding type is displayed : You should set the Language of the TEXT VIEWER menu to view the text. Set the Language menu as one that is the same as the Operating System language that the text was created.
- When the UNI encoding type is displayed : The text file will be displayed with any language menu.

- If the text file size is over 10MB, it may take long time to view the text file. Divide the text file and the loading time will be shorten.

Using the camera buttons to adjust the camera

Volume button

- You can control the volume with this button.
There are 0~30 steps



Play & Pause/ Control button

- When a file is playing back, press the Down button to pause the file. Pressing it again will resume playback.
- MP3 mode
You can search the MP3 files by pressing the Left/ Right button. You can't search the MP3 file during play back.
- PMP mode
You can search the Multimedia files by pressing the Left/ Right button.
And you can search a desired frame of the file during play back by pressing the Left/ Right button.
- TEXT VIEWER mode
When the text list menu is displayed : select a text file by pressing the Up/Down button.
When the text is displayed : press the Up/Down button and previous / next page of the file will display.



Delete button

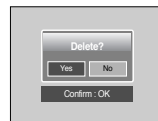

- This deletes files stored on the memory.
 1. Select a desired file to delete on the browsing menu and press the Delete button.
 2. A message will display as shown
[Yes]: deletes the selected file.
[No] : cancels "Delete files" and the browsing menu will display.



INFORMATION

- Before deleting files from the camera, take care to download files you want to keep to your computer.

Using the camera buttons to adjust the camera

Hold / Equalizer button  



- If you press the Hold button for over 1 second, the camera buttons are locked.
 - If the camera buttons are locked, the buttons can't be operated while playing back. But Power off, Video out, USB connection and LCD on functions can be operated.



- If you press the Lock button again or turn off the camera, the camera is unlocked.

- The user can select appropriate sound with this setting.
 - Press the E button and select either <Normal>, <Classic>, <Dance>, <Jazz>, <Live>, <Rock>, or <3D>.



Playlist button   

- While a multimedia file is playing back, you can select a desired file by using the browsing menu.
 1. While a multimedia file is playing back, press the Playlist button ().
 2. A playlist that is currently playing will be highlighted.
 3. Move the cursor to a desired list by pressing the Control button. Pressing the OK button : the selected file is played back. Pressing the Playlist button : the selection will be cancelled.



[MP3 Mode]



[PMP Mode]



[TEXT VIEWER Mode]

● Setting up the playback function using the LCD monitor

- MP3/ PMP mode functions can be changed by using the LCD monitor.
Press the MENU button and the menu will display on the LCD monitor.

	Menu tab	Main menu	Sub menu		Page
MP3	→	Resume	ON	OFF	p.70
	▶ MODE	Play mode	A	R	p.70
				-	
		MP3 Skin			p.70
		Delete All	NO	YES	p.71
		Show Interval	2	3	p.71
			5	-	
		Show Play			p.71
	PMP	→	Resume	ON	OFF
▶▶ TIME		Seeking	NOR	30 sec	p.71
			1 min	3 min	
			5 min	10 min	
◻		Player Display	5 sec	OFF	p.72
	Delete All	ON	-	p.71	
		NO	YES		

	Menu tab	Main menu	Sub menu						Page	
TEXT	→	Resume	ON					OFF	p.70	
		Auto Scroll	ON	0.8 sec	1.1 sec	1.4 sec	1.7 sec	2.0 sec	2.3 sec	p.72
		MP3 BGM	OFF					ON	p.72	
		Language	ENG, KOR, FRA, DEU, ESP, ITA, CHN, TWN, JPN, RUS, PRT, NLD, DNK, SWE, FIN, MYS, POL, HUN, CSK, TUR						p.72	
		Delete All		NO				YES	p.71	

※ Menus are subject to change without prior notice.

• Setting up the playback function using the LCD monitor

Resume

- You can set the playback type.
 - Press the Menu button in each mode.
 - Select a desired playing type in the [Resume] menu by pressing the Up / Down button and pressing the OK button.



[MP3 mode]

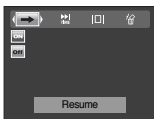





[PMP mode]



[TEXT VIEWER mode]





- ON** : When the camera is turned on/ off or camera mode is changed, this camera will memorize the latest stopped frame.
 MP3 mode : plays back from the beginning of the file.
 PMP mode : plays back from the latest stopped frame
 TEXT VIEWER mode : plays back from the latest stopped frame.
- OFF** : The browsing menu will display to select a desired file

Play mode

- You can set various repeat and shuffle options. This function is adopted only in the selected folder.
 -  : plays a single track once.
 -  : plays a single track repeatedly.
 -  : plays all tracks in the folder repeatedly.
 -  : randomly plays all tracks in the folder once.
 -  : randomly plays all tracks in the folder repeatedly.



Skin of MP3 player

- You can set the skin of MP3 player
 - [ , ] : Default skin will be set.
 - [ , ] : An image created by the [MP3 Skin] menu (p.50) will be set.



Setting up the playback function using the LCD monitor

Delete all

- All files stored on the memory card will be deleted. In the MP3 mode, only MP3 files are deleted. In the PMP mode, only multimedia files are deleted. In the TEXT VIEWER mode, TEXT files are deleted.



[MP3 mode]



[PMP mode]

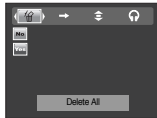

[TEXT VIEWER mode]

NO : cancels "Delete files"

YES : A confirmation window will display. Select [Yes] and press the OK button. All files will be deleted.

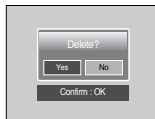



Setting slide show interval

- You can set the slide show play interval of MP3 mode.
 - Select an interval among 2, 3, 5 second.



Playing back the slide show

- While the MP3 file is playing back, captured images are displaying on the LCD monitor continuously.
 -  : Display the images once.
 -  : Display the images continuously.



- When the playing back is complete, the slide show will stop.
- To stop the slide show, press the Pause button and then press the E button.

Frame search

- You can set the time of skip range when you search the movie by pressing the Left/ Right button. You can search a frame you want easily.

[**NOR**]: This will skip frame by frame whenever you press the Left / Right button.

[**30 sec** , **1 min** , **3 min** , **5 min** , **10 min**]: This will skip a set frame whenever you press the Left / Right button.

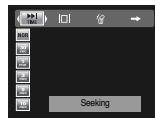

Setting up the playback function using the LCD monitor

Display setting

- You can set the play back function display on the LCD.

[5 sec] : If there is no operation during 5 seconds, Menu bar will disappear.

[Off] : Menu bar will not display on the LCD monitor.

[ON] : Menu bar will display on the LCD monitor.



- To see the caption, insert the caption file (.smi) by using the Digimax Converter. (p.86)
- If a multimedia file has a caption, the caption will display regardless of display setting.





Setting up the recording function in the MP3 mode.

- You can take a picture and listen to the MP3 files at the same time

- Press the Shutter button and the MP3 stand-by icon will display.
- Press the Shutter button and an image will be taken.



INFORMATION

- The camera settings are fixed to default setting of Auto mode ( ,  ,  , ). The settings can't be changed.
- If the memory card is not inserted, this function will not operate. Occasionally the next file will be played back when you press the Shutter button, even though a memory card is inserted.
- If the memory card is not inserted, the Auto mode will be selected when you press the Shutter button.
- To cancel the recording mode of the MP3 mode, press the E button or do not operate any buttons for about 10 seconds.

Auto Scroll

- The playing text is scrolled automatically and displays on the LCD monitor.

[Off] : The text will not be scrolled automatically.

※ Press the Up/Down button and you can use the Auto Scroll function.

[0.8 sec] **[1.1 sec]** **[1.4 sec]** **[1.7 sec]** **[2.0 sec]** **[2.3 sec]** : The text will be scrolled automatically. The interval is marked on each menu icon.



MP3 BGM Setting

- You can play MP3 files when you are playing the text.

[Off] : You cannot play the MP3 files.

[ON] : When you are playing the text, you can play the MP3 files.

※ The last played MP3 files will be executed.



Language setting

- You can setup the language of OS (Operating System) that the text file was made.

- If the characters of the text file don't display correctly, open the file on Windows 2000 or later and save it again. We recommend using 'Notepad' and it has to be saved as ANSI encoding type.

- Some unique characters may not be displayed correctly on the camera.



• Important notes

Be sure to observe the following precautions!

- This unit contains precision electronic components. Do not use or store this unit in the following locations.
 - Areas exposed to severe changes in temperature and humidity.
 - Areas exposed to dust and dirt.
 - Areas exposed to direct sunlight or the inside of a vehicle in hot weather.
 - Environments where there is high magnetism or excessive vibration.
 - Areas with high explosives or highly flammable materials.
- Do not leave this camera in places subject to dust, chemicals (like naphthalene and mothball), high temperature and high humidity. Keep this camera in a hermetically sealed box with silica gel when not planning to use it for a long period.
- Sand can be particularly troublesome to cameras.
 - Do not let sand get inside the unit when using it on beaches, coastal dunes, or other areas where there is lots of sand.
 - Doing so may result in failure or may permanently render the unit unusable.
- Handling the camera
 - Never drop the camera or subject it to severe shocks or vibrations.
 - Protect the large size LCD monitor from impact. When this camera is not used, keep this camera in the camera case.
 - Avoid obstructing the lens or the flash when you capture an image.
 - This camera is not waterproof. To avoid dangerous electrical shocks, never hold or operate the camera with wet hands.
 - If you use this camera in wet places, such as beach or pool, do not let water or sand get inside the camera. Doing so may result in failure or may permanently damage the unit.
- Extremes in temperature may cause problems.
 - If the camera is transferred from a cold to a warm and humid environment, condensation can form on the delicate electronic circuitry. If this occurs, turn the camera off and wait for at least 1 hour until all moisture is dispersed. Moisture build up can also occur in the memory card. If this happens, turn off the camera and remove the memory card. Wait until the moisture has dispersed.
- Caution on Using the Lens
 - If the lens is subjected to direct sunlight, it could result in discoloration and deterioration of the image sensor.
 - Don't get fingerprints or foreign substances on the surface of the lens.
- If the digital camera is not used for a long period, an electric discharge can occur. It is a good idea to remove the batteries and the memory card if you do not intend using the camera for an extended period of time.
- If the camera is exposed to an electronic interference, it will turn itself off to protect the memory card.
- Camera Maintenance
 - Use a soft brush (available from photo stores) to gently clean the lens and LCD assemblies. If this does not work, lens-cleaning paper with lens cleaning fluid can be used. Clean the camera body with a soft cloth. Do not allow this camera to come into contact with solvent materials such as benzol, insecticide, thinners etc. This may damage the body shell of the camera and also affect its performance. Rough handling can damage the LCD monitor. Take care to avoid damage and keep the camera in its protective carry case at all times when not in use.

• Important notes

- Do not attempt to disassemble or modify the camera.
- Under certain conditions, static electricity can cause the flash unit to fire. This is not harmful to the camera and is not a malfunction.
- When images are uploaded or downloaded (when the charger and USB cable are inserted into the cradle at the same time), the data transfer may be affected by static electricity. In this case, disconnect and re-connect the USB cable before trying the transfer again.
- Before an important event or going on a trip, you should check the camera condition.
 - Take a picture to test the camera and always carry a spare fully charged battery.
 - Samsung cannot be held responsible for camera malfunctions.
- Do not use headphones/earphones while driving, cycling, or operating any motorized vehicle. It may create a traffic hazard and can be illegal in some areas.
- Avoid using headphones/earphones at high volume. Hearing experts advise against continuously loud and extended play. If you experience a ringing in your ears, reduce volume or discontinue use.

• Warning indicator

- There are several warnings that may appear on the LCD display

Card Error!

- Memory card error
 - Turn off the camera power and turn it on again
 - Insert the memory card again
 - Insert the memory card and format the memory card (p.59)

Card Locked!

- The memory card is locked
 - SD memory card : Slide the write protect switch towards the top of the memory card

No Card!

- A memory card is not inserted
 - Turn off the camera power
 - Insert the memory card
 - Turn on the camera power

No Image!

- There are no images stored on the memory
 - Take images
 - Insert a memory card that is holding some images

File Error!

- File error
 - Delete the file
- Memory card error
 - Contact a camera service centre

Low Battery!

- There is low battery capacity
 - Insert charged battery

Low Light!

- When taking pictures in dark places
 - Take pictures in Flash Photography mode.

Out Of Number

- When selecting too many printing pages in the PictBridge menu.
 - Select printing page within the limitation.

• Before contacting a service centre

■ Please check the following

The camera doesn't switch on

- There is low battery capacity
→ Insert charged battery (p.12)
- Battery is inserted incorrectly with the polarities reversed.
→ Insert the battery according to the polarity marks (+, -)
- The rechargeable battery is not inserted
→ Insert the battery and turn on the camera

The camera power ceases while in use

- The battery are exhausted
→ Insert charged battery
- The Camera is turned off automatically
→ Turn on the camera power again.

Battery power quickly drains

- The Camera is being used in low temperatures
→ Keep the camera in warm conditions (i.e. inside a coat or jacket) and only remove it in order to take images

Camera does not take images when the Shutter button is pressed

- There is insufficient memory capacity
→ Delete unnecessary image files
- The memory card has not been formatted
→ Format the memory card (p.59)
- The memory card is exhausted
→ Insert a new memory card
- The memory card is locked
→ Refer to [Card Locked!] error message
- The camera's power is off
→ Turn the camera power on
- The battery is exhausted
→ Insert charged battery.
- Battery is inserted incorrectly with the polarities reversed.
→ Insert the battery according to the polarity marks (+, -)

The camera suddenly stops working while in use

- The camera stopped due to a malfunction
→ Remove /re-insert battery and switch the camera on

The images are unclear

- A picture was taken of the subject without setting an appropriate macro mode
→ Select an appropriate macro mode to take a clear image.
- Taking a picture beyond the flash range
→ Take a picture within the flash range
- The lens is smudged or dirty
→ Clean the lens

The flash does not fire

- Flash off mode has been selected
→ Dis-engage flash off mode
- The camera mode can't use the flash
→ Refer to the FLASH instruction (p.24)

Incorrect date and time is displayed

- The date and time have been set incorrectly or the camera has adopted the default settings
→ Reset the date and time correctly

The camera buttons do not operate

- Camera malfunction
→ Remove/re-insert battery and switch the camera on

A card error has occurred while the memory card is in the camera.

- Incorrect memory card format
→ Re-format the memory card

The images don't play back

- Incorrect file name (Violation of DCF format)
→ Do not change the image file name

Colour of image is different to the original scene

- White balance or effect setting is incorrect
→ Select appropriate White balance and effect

• Before contacting a service centre

Images are too bright

- Exposure is excessive
→ Reset exposure compensation

No image on external monitor

- The external monitor has not been connected properly with the camera
→ Check the connection cables
- There are incorrect files in the memory card
→ Insert a memory card that has correct files

When using the PC's explorer, the [Removable Disk] file does not show

- Cable connection is incorrect
→ Check the connection
- The camera is off
→ Turn the camera on
- The operating system is not Windows 98, 98SE, 2000, ME, XP/ Mac OS 9.0 ~ 10.4. Alternatively the PC does not support USB
→ Install Windows 98, 98SE, 2000, ME, XP/ Mac OS 9.0 ~ 10.4 to PC that supports USB
- The camera driver is not installed
→ Install a [USB Storage Driver]

• Specification

■ Image Sensor

- Type : 1/2.5" CCD
- Effective Pixel : Approx. 7.2 Mega-pixel
- Total Pixel : Approx. 7.4 Mega-pixel

■ Lens

- Focal Length : NV Lens f = 6.3 ~ 18.9mm
(35mm film equivalent : 38~114mm)
- F No. : F 3.5 ~ F 4.5
- Digital Zoom : · Still Image mode : 1.0X ~ 5.0X
· Play mode : 1.0X ~ 12.0X (depends on image size)

■ LCD Monitor : 2.5" Color TFT LCD

■ Focusing

- Type : TTL auto focus (Multi, Center)
- Range

	Normal	Macro	Super Macro	Auto Macro
Wide	80cm ~ infinity	5 ~ 80cm	1cm ~ 5cm	5cm ~ Infinity
Tele		40 ~ 80cm	-	40cm ~ Infinity

■ Shutter

- Speed : 2 ~ 1/2,000 sec. (Night : 15 ~ 1/2,000 sec.)

■ Exposure

- Control : Program AE, Metering : Multi, Spot
- Compensation : ± 2 EV (0.5EV steps)
- ISO Equivalent : Auto, 80, 100, 200, 400, 800, 1000

■ Flash

- Modes : Auto, Red-eye reduction, Fill-in flash, Slow sync, Flash off, Red-eye fix
- Range : Wide : 0.3m ~ 3.4m, Tele : 0.5m ~ 2.5m (ISO AUTO)
- Recharging Time : Approx. 4 sec.

Specification

- Sharpness : Soft, Normal, Vivid
- Effect : Normal, B&W, Sepia, Negative, Red, Green, Blue, RGB, Composite , Highlight, Frame
- White Balance : Auto, Daylight, Cloudy, Fluorescent_H, Fluorescent_L, Tungsten, Custom
- Voice Recording : Voice Recording (max 1 hour), Voice Memo in Still Image (max. 10 sec.)
- Date Imprinting : Date, Date&Time, Off (user selectable)
- Shooting
 - Still Image : Modes : Auto, Program, Scene, ASR
 - ※ Scene : Night, Portrait, Children, Landscape, Text, Close-up, Sunset, Dawn, Backlight, Fireworks, Beach & Snow
 - Continuous : Single, Continuous, AEB
 - Self-timer : 2 sec., 10 sec., Double(10 sec., 2 sec.)
 - Movie Clip : With Audio (recording time : Depend on Storage size)
 - Size : 720x480, 640x480, 320x240 (3X Optical Zoom with sound recording)
 - Frame rate : 30 fps, 20 fps(only 720x480 size), 15 fps
 - Color Effect & WB selectable
 - Movie Stabilizer (User Selectable)
 - Movie Editing (Embedded) : Pause during recording, Still Image Capture Time Trimming

■ Storage

- Media : Internal memory: About 15MB
External memory(Optional) : MMC/SD card (Up to 1GB Guaranteed)
*Internal memory capacity is subject to change without prior notice.
- File Format : Still Image : JPEG (DCF), EXIF 2.2, DPOF 1.1, PictBridge 1.0
Movie Clip : AVI(MPEG-4) Audio : WAV
- Image Size

7M	6M	5M	5M(W)	4M	3M	2M	1M	VGA
3072x 2304	2816x 2112	2592x 1944	3072x 1728	2272x 1704	2048x 1536	1600x 1200	1024x 768	640x 480

- Capacity (256MB MMC(Multi Media Card))

	7M	6M	5M	5M(W)	4M	3M	2M	1M	VGA
Super Fine	63	74	88	88	118	131	208	381	1201
Fine	116	138	162	162	202	236	332	520	1420
Normal	171	195	223	223	274	318	422	600	1736

- ※ These figures are measured under Samsung's standard conditions and may vary depending on shooting conditions and camera settings.
- Image Play
 - Type : Single image, Thumbnails, Slide show with Effect & BGM, Movie Clip
 - Editing : Color Effect, Trimming, Rotating, Resizing
- Interface : Digital output connector : USB 2.0
Audio : Mono for Movie clip & Voice Recording, Stereo for MP3 & PMP
Video output : NTSC, PAL (user selectable)
DC power input connector : 24pin Connector

• Specification

- Power Source : Rechargeable battery : SLB-0837 (860mAh)
Adaptor : SAC-45, SUC-C2
Cradle : SCC-NV3 (Optional)
 - ※ Included battery type may vary depending on sales region.
 - Dimensions (WxHxD) : 94.5 x 57 x 17.5 mm
 - Weight : 142g (without battery and card)
 - Operating Temperature : 0 ~ 40°C
 - Operating Humidity : 5 ~ 85%
 - Software
 - Camera Driver : Storage Driver
(Windows98/98SE/2000/ME/XP, Mac OS 9.0 ~ 10.4)
 - Application : Digimax Converter*, Digimax Master*, Adobe Reader
 - * OS : Windows 98SE/2000/ME/XP (Windows 2000/XP recommended)
 - * PentiumIII 500MHZ or above (PentiumIV recommended)
 - ※ MP3 Specification
 - Audio
 - Frequency : 20Hz~20KHz
 - Earphone Port : 2.5mm Port (Stereo Type)
 - Output : Maximum Volume Left 40mW + Right 40mW (16Ω)
 - Noise Ratio : 88 dB with 20 KHz LFP
 - File
 - File Format : MP3 (MPEG-1/2/2.5 Layer 3)
 - Bit Rate : 48 ~ 320kbps (Including VBR)
 - Sound Effect : Normal, Classic, Dance, Jazz, Live, Rock, 3D
 - Play Mode : All, Repeat One, Repeat All, Random, Random Repeat
 - Skipping in Play, Auto Skipping
 - Slide Show On/Off (User Selectable),
 - MP3&Capturing (Capturing Mode is Auto Default, 3M)
 - Auto reload function (Remember last played file)
 - Background skin of MP3 playback using user images
 - ※ PMP Specification
 - PMP Decoder
 - Movie : Xvid MPEG4 (Using Digimax Converter S/W)
 - Audio : MPEG1 Layer 2 (Using Digimax Converter S/W)
 - Play Mode
 - Seeking in Play (Max 32X), Skipping in Play,
 - Auto skipping after one file played
 - Auto reload function (Remember last played frame)
 - Support Full Screen in Converting S/W
 - Subtitle : Support SMI file (Using Digimax Converter S/W)
 - ※ TEXT VIEWER Specification
 - File : Text file (TXT extension name, up to 99999 pages)
 - File Format
 - Window : ANSI(Windows 98 or later), Unicode/Unicode(Big-Endian)/UTF-8
(Windows 2000/XP)
 - Mac : ANSI, Unicode(UTF-16)
 - Function :
 - Auto Scroll (0.8sec ~ 2.3sec)
 - Skipping by 1 page/10pages
 - Auto reload function (Remember last page)
 - Support MP3 BGM during displaying text file
 - Language : English, Korean, French, German, Spanish, Italian, Chinese, Taiwanese, Japanese, Russian, Portuguese, Dutch, Swedish, Finnish, Bahasa, Polish, Hungarian, Czech, Turkish
- * Supportable language is subject to change without prior notice.
- ※ Specifications are subject to change without prior notice.
 - ※ All trademarks are the property of their respective owners.

Software Notes

Please ensure that you read the software instructions carefully before use.

- The attached software is a camera driver and image editing software tool for Windows.
- Under no circumstances should all or part of either the software or the user manual be reproduced.
- Copyrights for software are licensed only for use with a camera.
- In the unlikely event of a manufacturing fault, we will repair or exchange your camera. We cannot, however, be held responsible in any way for damage caused by inappropriate use.
- Using a Hand-made PC or a PC and OS that has not been guaranteed by the manufacturer is not covered by the Samsung warranty.
- Before reading these instructions, you should have a basic knowledge of computers and O/S (Operating Systems).

System Requirements

For Windows	For Macintosh
PC with processor better than Pentium II 450MHz (Pentium 700MHz recommended) Windows 98/98SE/2000/ME/XP Minimum 128MB RAM 200MB of available hard disk space 1024x768 pixels, 16-bit colour display compatible monitor (24-bit colour display recommended) DirectX 9.0 or later	Power Mac G3 or later Mac OS 9.0 ~ 10.4 Minimum 64MB RAM 110MB of available hard-disk space QuickTime player or a media player that supports AVI file format.
■ Digimax Converter PC with processor better than Pentium III 500MHz (Pentium IV recommended) Windows 98SE/2000/ME/XP (Windows 2000/XP recommended)	■ For playing back a movie clip Mac OS 10.1~10.4 MPlayer, VLC Media Player

About the software

After inserting the CD-ROM provided with this camera into the CD-ROM drive, the following window should automatically run.



Before connecting the camera to the PC, you should first install the camera driver.

※ Screen Captures illustrated on this manual is based on English Edition of Windows.

■ Camera driver : This enables images to transfer between the camera and PC.

This camera uses the USB Storage Driver as the camera driver. You can use the camera as a USB card reader. After installing the driver and connecting this camera to the PC, you can find [Removable Disk] in [Windows Explorer] or [My computer]. A USB Storage Driver is provided only for Windows. A USB Driver for MAC is not included with the Application CD. You can use the camera with Mac OS 9.0 ~ 10.4.

■ XviD codec : This makes movie clips (MPEG-4) recorded with this camera play back on a PC.

To play back a movie clip recorded with this camera, you must install the XviD codec. If a movie clip recorded with this camera does not play well, install this codec. This software is only compatible with Windows.

■ Digimax Converter : Multimedia converting program

Multimedia (Movie, Video clip, etc) files can be converted into movie clips that can be played back on this camera. This software is only compatible with Windows.

• About the software

- **Digimax Master** : This is the all-in-one multi media software solution. You can download, view, edit and save your digital images and movie clips clip with this software. This software is only compatible with Windows.

INFORMATION

- Be sure to check the system requirements before installing the driver.
- You should allow 5 ~ 10 seconds for running the automatic setup program. If the frame does not show, run the [Windows Explorer] and select [Samsung.exe] in the CD-ROM Drive root directory.
- PDF documents of user manual are included in the Software CD-ROM supplied with this camera. Search the PDF files with Window's explorer. Before opening the PDF files, you must install the Adobe Reader included in the Software CD-ROM.
- To install the Adobe Reader 6.0.1 correctly, Internet Explorer 5.01 or later had to be installed. Visit "www.microsoft.com" and upgrade the Internet Explorer.

• Setting up the application software

- To use this camera with a PC, install the application software first. After this has been done, the stored images in the camera can be moved to the PC and can be edited by an image editing program.
- You can visit the Samsung web-site through the internet.

<http://www.samsungcamera.com> : English
<http://www.samsungcamera.co.kr> : Korean

1. The auto run frame will display.
Click the [Install] menu in the Auto run frame.



2. Install the camera driver and DirectX by selecting a button shown on the monitor.

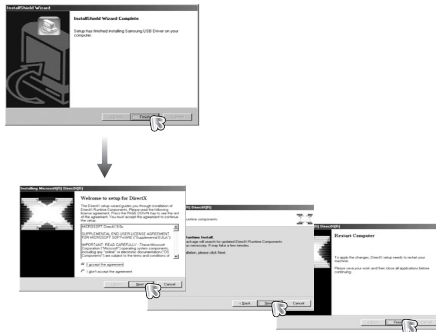

• Setting up the application software

3. To play back the movie clip recorded with this camera on the computer, install the XviD codec.



※ The XviD codec is distributed according to and under the terms and conditions of the GNU General Public License and everyone can copy, modify and distribute this codec freely, but **WITHOUT ANY WARRANTY, IMPLIED OR EXPRESSED, OF MERCHANTABILITY OR FITNESS FOR A PARTICULAR PURPOSE**; provided, however, that you have to follow the GNU General Public License whenever you are distributing this codec or modification thereof. For more information see the GNU General Public License documents (<http://www.gnu.org/copyleft/gpl.html>).

4. Install the software by instructions on the monitor.



Setting up the application software

- After restarting the computer, connect the PC to the camera with the USB cable.
- Turn the camera power on.
The [Found New Hardware Wizard] will open and the computer will recognize the camera.



- ※ If your OS is Windows XP, an image viewer program will open.
If the download window of Digimax Master opens after starting Digimax Master, the camera driver was setup successfully.

INFORMATION

- If you have installed the camera driver, The [Found New Hardware Wizard] may not open.
- On a Windows 98 or 98 SE system, the Found New Hardware Wizard dialog box opens and a window asking you to select a driver file may appear. In this case, specify "USB Driver" in the CD supplied.

Starting PC mode

- If you connect the USB cable to a USB port on your PC and then turn on the power, the camera will automatically switch to "computer connection mode".
- In this mode, you can download stored images to your PC through the USB cable.
- The LCD monitor is always turned off in PC mode.

■ Connecting the camera to a PC

- In any mode with the exception of Voice Recording mode, press the Menu button.
- Press the LEFT/ RIGHT button and select the [SETUP] menu tab.
- Select the [USB] menu by pressing the UP/ DOWN button and press the RIGHT button.
- Use the UP and DOWN buttons to select [Computer], and then press the OK button.
- Press the menu button twice and the menu will disappear.
- Connect the PC to the camera with the USB cable.



Starting PC mode

■ Connecting the camera to a PC

[Using the USB cable with Cradle (optional)]



[Using the USB cable with Camera]



※ If you selected [Printer] in Step 4, when you connect the camera to your printer, the [Connecting Printer] message will display and the connection will not be established.

In this case, disconnect the USB cable, and then follow the procedure from Step 2 and onward.

- Disconnecting the camera and PC : Refer to page 84
(Removing the removable disk).

INFORMATION

- Before inserting any cables or AC adapter, check the directions and do not insert by force. It may cause breakage of cable or camera.

Removable Disk

■ Downloading stored images

You can download the still images stored on the camera to your PC's hard disk and print them or use a photo editing software to edit them.

1. Connect the camera to your PC with the USB cable.
2. On your computer's desktop display, select [My computer] and double click [Removable Disk → DCIM → 100SSCAM].

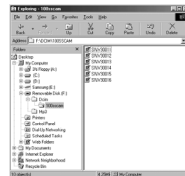

3. Select an image and press the right mouse button.

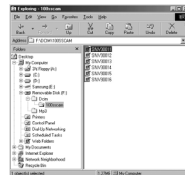

4. A pop-up menu will open.
Click the [Cut] or [Copy] menu.
 - [Cut] : cuts a selected file.
 - [Copy] : copies files.



5. Click a folder where you want to paste the file.

Removable Disk

- Press the right mouse button and a pop-up menu will open. Click [Paste].



- An image file is transferred from the camera to your PC.



CAUTION

- We recommend that you should copy the images to the PC to view them. Opening images directly from the removable disk may be subject to unexpected disconnection.
- When you upload a file that is not taken by this camera to the Removable Disk, the [File Error!] message will be displayed on the LCD monitor in the PLAY mode, and nothing is displayed in THUMBNAİL mode.

Removing the removable disk

- Windows 98/ 98SE
 - Check whether the camera and PC are transferring a file. If the camera status lamp blinks, please wait until the lamp has finished blinking and is constantly on.
 - Unplug the USB cable.
- Windows 2000/ ME/ XP
(The illustrations may differ from those shown depending on the Windows O/S.)

- Check whether the camera and PC are transferring a file. If the camera status lamp blinks, please wait until the lamp has finished blinking and is constantly on.
- Double-click the [Unplug or Eject Hardware] icon on the task bar.



[Double Click!]

- The [Unplug or Eject Hardware] window will open. Select the [USB Mass Storage Device] and click the [Stop] button.

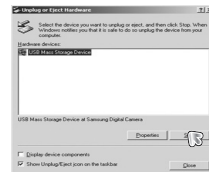

- The [Stop a Hardware device] window will open. Select the [USB Mass Storage Device] and click the [OK] button.



- A [Safe to Remove Hardware] window will open. Click the [OK] button.



● Removing the removable disk

6. A [Unplug or Eject Hardware] window will open. Click the [Close] button and the removable disk may be removed safely.

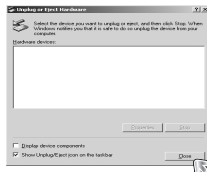

7. Unplug the USB cable.

● Setting up the USB Driver for MAC

1. A USB Driver for MAC is not included with the software CD as MAC OS supports the camera driver.
2. Check the MAC OS version during start-up.
This camera is compatible with MAC OS 9.0 ~ 10.4.
3. Connect the camera to the Macintosh and turn the camera power on.
4. A new icon will be displayed on the desktop after connecting the camera to the MAC.

● Using the USB Driver for MAC

1. Double click a new icon on the desktop and the folder in the memory will be displayed.
2. Select an image file and copy or move it to MAC.

INFORMATION

- For Mac OS 10.0 or later : First complete uploading from computer to camera and then remove the removable disk with the Extract command.
- If a movie clip can't play back on the Mac OS, please visit the following site(<http://www.divx.com/divx/mac/>) and download the codec. Or, use a media player that supports the Xvid codec (Mplayer, VLC(VideoLAN Client) media player).

● Removing the USB Driver for Windows 98SE

- To uninstall the USB driver, refer to the process shown below.
 1. Connect the camera to your PC and turn them on.
 2. Check whether the Removable Disk is on the [My Computer].
 3. Remove the [Samsung Digital Camera] on the Device manager.



4. Disconnect the USB cable.
5. Remove the [Samsung USB Driver] on the Add/ Remove Programs Properties.

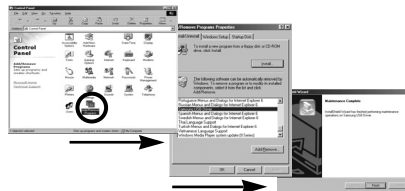

6. Uninstallation is complete.

• Digimax Converter

- Multimedia (Movie, Video clip, etc) files can be converted into movie clips that can be played back on this camera. This software is only compatible with Windows. (Windows 2000/XP recommended)

- How to use the Digimax Converter

1. Double click the Digimax Converter icon () on the desktop.
2. Click the Add icon () and select a file that you want to add.

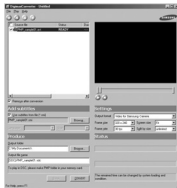

3. If you want to add a caption, check "Use subtitles from file(*.smi)".
4. Select settings that you want and click the Convert button.

- Frame size : You can set the width and height of output movie clip.
- Frame rate : You can set fps (Frame Per Second).
- Screen size : You can set type of display.
- Split by size : You can set the file size of output movie clip.

5. Connect the camera to the computer with the supplied USB cable.

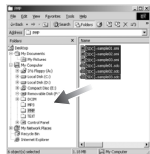

6. Copy the converted movie clip in the destination folder and paste the file in the [PMP] folder.

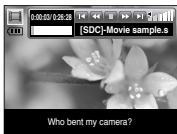

7. You can play back the converted movie clip in the Play mode of the camera.

※ Refer to the [Help] menu in Digimax Converter for further information.

INFORMATION

- Before converting a multimedia file, check whether it plays back correctly on the Windows Media Player.
- The converted files are saved as *.sdc file type that can be played back on the Windows Media Player.
- The Digimax Converter doesn't cover every kind of codecs. If a multimedia file can't play back on the Windows Media Player, install a multicodec(We recommend Full version of latest K-Lite Codec). Install the Digimax Converter again after installing the multi-codec.
- You can select destination folder of each converted file. When the folder is not selected, the converted files are saved on a folder where the source file is.
- If you convert several files at the same time, the computer may be running slow because of the CPU capacity. In this case, add the files in the program one by one.
- Computer specification, installed code and programs are the main causes of converting error. When a converting error happens, please check the following.
 - Any codecs compatible with the files were not installed or installed incorrectly. In this case, find a compatible codec and install it. If you do not find any compatible codecs, install a multi-codec.
 - If you installed various multi-codecs on your computer, it may cause converting problems. In this case, remove all codecs and install a proper multi-codec.
 - Install a latest Windows Media Player.
 - Visit device (PC, Graphic card, Sound card) manufacturer web-site and upgrade them with the latest version.
- Some kinds of multimedia files are not converted. If the converted media files are damaged, they may not play back on the camera. Unusual type of files may not be converted. The sound and scenes may not synchronise.
- The expected file sizes after converting a media file may vary. It depends on the computer system you use.

• Digimax Converter

INFORMATION

- If there is no font that is compatible with the script file on your PC, the script is shown as ' □□□□ '.
- Transferring the converted file to a removable disk is time consuming. It may take a long time. The duration depends on the file size.
- Do not use the PMP mode while driving. It may create a traffic hazard.
- A file that does not support fast search on the Windows Media Player can't select converting range and divide file size.

• Digimax Master

- You can download, view, edit and save your images and movies with this software. This software is only compatible with Windows (but not Windows 98.).
- To run the Digimax Master, double click the Digimax Master icon on the desktop.
- Downloading images
 1. Connect the camera to your PC.

2. A window for downloading images will display after connecting the camera to your PC.

- To download the captured images, select the [Select All] button.
- Select desired folder in the window and click the [Select All] button. You can save captured images and selected folder.
- If you click the [Cancel] button, downloading will be cancelled.



3. Click [Next >] button.



● Digimax Master

4. Select a destination and make a new folder in which to save downloaded images and folders.

- Folder names can be made in order of date and images will be downloaded.
- Folder name will be made as you want and images will be downloaded.
- After selecting a folder that was made before, images will be downloaded.



5. Click [Next >] button.



6. A window will open as shown alongside. The destination of the selected folder will be displayed on the upper side of the window. Click the [Start] button to download the images.

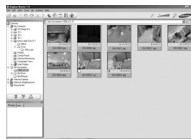

7. Downloaded images will be displayed.

● Image viewer : You can view the stored images.

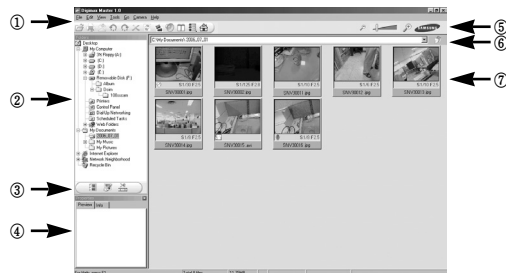

- Image viewer functions are listed below.

① Menu bar : You can select menus.

File, Edit, View, Tools, Change functions, Auto download, help, etc.

② Image selection window : You can select the desired images in this window.

③ Media type selection menu : You can select image viewer, image edit and movie edit functions in this menu.

④ Preview window : You can preview an image or a movie clip and check the multi media information.

⑤ Zoom bar : You can change preview size.

⑥ Folder display window : You can see the folder location of the selected image.

⑦ Image display window : Images in the selected folder are displayed.

※ Refer to the [Help] menu in Digimax Master for further information.

• Digimax Master

- Image edit : You can edit the still image.



- Image edit functions are listed below.

- ① Edit menu : You can select the following menus.
 - [Tools] : You can resize or crop the selected image. See the [Help] menu.
 - [Adjust] : You can modify image quality. See the [Help] menu.
 - [Retouch] : You can change the image or add effects to the image. See the [Help] menu.
- ② Drawing tools : Tools for editing an image.
- ③ Image display window : A selected image displays in this window.
- ④ Preview window : You can preview the changed image.

- ※ A still image edited with Digimax Master can't be played back on the camera.
- ※ Refer to the [Help] menu in Digimax Master for further information.

- Movie edit : You can get the still image, movie clip, narration, music files together in a movie clip.

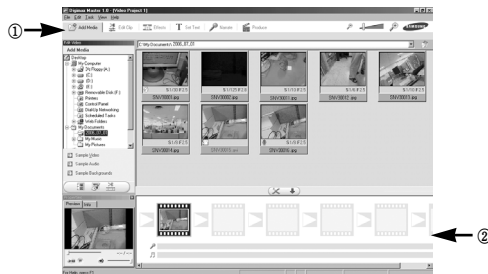

- Movie clip edit functions are listed below.

- ① Edit menu : You can select the following menus.
 - [Add Media] : You can add other media elements to a movie.
 - [Edit Clip] : You can change the brightness, contrast, colour and saturation.
 - [Effects] : You can insert an effect.
 - [Set Text] : You can insert texts.
 - [Narrate] : You can insert a narration.
 - [Produce] : You can save the edited multi media as a new file name.
 - * You can select AVI, Windows media (wmv), Windows media (asf) and movie clip for this camera (avi, MPEG-4) file types.
- ② Frame display window : You can insert multi media in this window.

- ※ Some movie clips that were compressed with a codec that is not compatible with the Digimax Master can't play back in the Digimax Master.
- ※ Refer to the [Help] menu in Digimax Master for further information.

FAQ

- Please check the following if the USB connection malfunctions.

Case 1 The USB cable is not connected or you are using a cable with an incorrect specification.

- Use a USB cable with the correct specification.

Case 2 The camera is not recognized by your PC. Sometimes, the camera may appear under [Unknown Devices] in Device Manager.

- Install the camera driver correctly. Turn off the camera, remove the USB cable, plug in the USB cable again, and then turn on the camera.

Case 3 There is an unexpected error during file transfer

- Turn the camera power off and on again. Transfer the file again.

Case 4 When using the USB hub.

- There may be a problem in connecting the camera to the PC through a USB hub if the PC and the hub are not compatible. Wherever possible, connect the camera directly to the PC.

Case 5 Are other USB cables connected to the PC?

- The camera may malfunction when it is connected to the PC at the same time as another USB cable. In this instance, disconnect the other USB cable so that only the camera's USB cable is connected to the computer.

Case 6

When I open the Device Manager (by clicking Start → (Settings) → Control Panel → (Performance and Maintenance) → System → (Hardware) → Device Manager), there are 「Unknown Devices」, 「Other Devices」, entries with a yellow question mark(?) beside them or devices with an exclamation mark(!) beside them.

- Double-click on the entry with the question (?) or exclamation (!) mark, and remove them (Click the right mouse button and 'Remove' menu will display). Re-boot your computer and connect the computer and the camera. In Windows 98, remove the camera driver and re-boot the computer. And then connect the computer and the camera.

Case 7

In some security programs (Norton Anti Virus, V3, etc.), the computer may not recognise the camera as a removable disk.

- Stop the security programs and connect the camera to the computer. Refer to the security program instructions about how to stop the program.

Case 8

The camera is connected to the USB port located on the front of the computer.

- When the camera is connected to the USB port located on the front of the computer, the computer may not recognise the camera. Connect the camera to the USB port located on the back of the computer.

FAQ

- When the movie clip doesn't play back on the PC
 - ※ When the movie clip recorded by the camera doesn't play back on the PC, the causes are mostly due to the codec installed on the PC.

- When codec for play back the movie clip isn't installed
→ Install the codec as listed below.

[Installing codec for Windows]

- 1) Insert the CD provided with the camera.
 - 2) Run the windows explorer and select [CD-ROM drive:\XviD] folder and click the XviD-1.1.0-30122005.exe file.
- ※ The XviD codec is distributed according to the GNU General Public License and everyone can copy, distribute and change this codec. This License applies to any program or other work which contains a notice placed by the copyright holder saying it may be distributed under the terms of this General Public License.

For more information, see the License documents
(<http://www.gnu.org/copyleft/gpl.html>).

[Installing codec for Mac OS]

- 1) Visit the following site for downloading the codec.
(<http://www.divx.com/divx/mac>)
 - 2) Click the [Free Download] button located at the upper right side of the page and a window for downloading the DivX codec will display.
 - 3) Select Mac OS you use and click the [Download] button. Save it to a suitable folder.
 - 4) Run the downloaded file and the codec for playing back the movie clip will be installed.
- ※ If a movie clip can't play back on the Mac OS, use a media player that supports XviD codec (Mplayer, VideoLanClient).

- When the DirectX 9.0 or later is not installed
→ Install the DirectX 9.0 or later
 - 1) Insert the CD provided with the camera
 - 2) Run the windows explorer and select the [CD-ROM drive:\ USB Driver\DirectX 9.0] folder and click the DXSETUP.exe file.
The DirectX will be installed. Visit the following site for downloading the DirectX.
<http://www.microsoft.com/directx>
- If a PC (Windows 98) stops responding while the camera and PC are connected repeatedly
→ If a PC (Windows 98) is turned on for a long time and the camera is connected repeatedly, the PC may not recognise the camera. In this case, re-start the PC.
- If a PC connected with the camera stops responding while Windows is starting.
→ In this case, disconnect the PC and the camera and Windows will start. If the problem happens continuously, set the Legacy USB Support to disable and re-start the PC. The Legacy USB Support is in the BIOS setup menu. (The BIOS setup menu differs from the PC manufacturers and some BIOS menus don't have Legacy USB Support) If you can't change the menu by yourself, contact to the PC manufacturer or BIOS manufacturer.
- If the movie clip can't be deleted, or the removable disk can't be extracted or an error message displays during the file transfer -
→ If you install only the Digimax Master, the problems mentioned above occasionally happen.
 - Close the Digimax Master program by clicking the Digimax Master icon on the Taskbar.
 - Install all the application programs included in the software CD.

Correct Disposal of This Product



Correct Disposal of This Product (Waste Electrical & Electronic Equipment)

(Applicable in the European Union and other European countries with separate collection systems) This marking shown on the product or its literature, indicates that it should not be disposed with other household

wastes at the end of its working life.

To prevent possible harm to the environment or human health from uncontrolled waste disposal, please separate this from other types of wastes and recycle it responsibly to promote the sustainable reuse of material resources. Household users should contact either the retailer where they purchased this product, or their local government office, for details of where and how they can take this item for environmentally safe recycling. Business users should contact their supplier and check the terms and conditions of the purchase contract.

This product should not be mixed with other commercial wastes for disposal.

FCC notice

■ NOTE:

This equipment has been tested and found to comply with the limits for a Class B digital device, pursuant to part 15 of the FCC Rules. These limits are designed to provide reasonable protection against harmful interference in a residential installation.

This equipment generates, uses and can radiate radio frequency energy and, if not in-stalled and used in accordance with the instructions, may cause harmful interference to radio communications. However, there is no guarantee that interference will not occur in a particular installation. If this equipment does cause harmful interference to radio or television reception, which can be determined by turning the equipment off and on, the user is encouraged to try to correct the interference by one or more of the following measures:

- Reorient or relocate the receiving antenna.
- Increase the separation between the equipment and receiver.
- Connect the equipment into an outlet on a circuit different from that to which the receiver is connected.
- Consult the dealer or an experienced radio/ TV technician for help.

■ CAUTION :

Changes or modifications not expressly approved by the manufacturer responsible for compliance could void the user's authority to operate the equipment.

■ Declaration of Conformity

Trade Name : SAMSUNG TECHWIN
Model No. : Samsung NV3
Responsible Party : Samsung Opto-Electronics America, INC.
Address : 40 Seaview Dr. Secaucus, NJ 07094
Telephone No. : 201-902-0347

This device complies with Part 15 of the FCC Rules. Operation is subject to the following two conditions: (1) This device may not cause harmful interference, and (2) this device must accept any interference received, including interference that may cause undesired operation.



SAMSUNG

SAMSUNG TECHWIN CO., LTD.

OPTICS & DIGITAL IMAGING DIVISION

145-3, SANGDAEWON 1-DONG, JUNGWONGU,
SUNGNAM-CITY, KYUNGKI-DO, KOREA
462-121

TEL : (82) 31-740-8222, 8488, 8490

FAX : (82) 31-740-8398

www.samsungcamera.com

SAMSUNG OPTO-ELECTRONICS AMERICA, INC.

1-800-SAMSUNG (726-7864)

www.samsungcamerausa.com

If you have any questions or comments relating to
Samsung cameras, Please contact
the SAMSUNG customer care center

SAMSUNG FRANCE S.A.S.

HOTLINE PHOTO NUMÉRIQUE :

00 800 22 26 37 27 (Numéro Vert-Appel Gratuit)

www.samsungphoto.fr

SAMSUNG OPTO-ELECTRONICS GmbH

ZENTRALE, KEINE REPARATUR

AM KRONBERGER HANG 6

D-65824 SCHWALBACH/TS, GERMANY

TEL : 49 (0) 6196 66 5303

FAX : 49 (0) 6196 66 5366

TECHNISCHE SERVICE HOTLINE :

00800 4526 3727

(nur kostenfrei für Anrufe aus Deutschland)

Die Adressen Ihrer Kundendienste sowie die
Garantiebestimmungen entnehmen Sie bitte aus dem
beliebigen Falblatt (SAMSUNG INTERNATIONAL
WARRANTY CERTIFICATE)

INTERNET : www.samsungcameras.de

TIANJIN SAMSUNG OPTO-ELECTRONICS CO., LTD

NO.9 ZHANGHENG STREET. MICRO-ELECTRONIC
INDUSTRIAL PARK JINGANG ROAD TIANJIN CHINA.

POST CODE : 300385

TEL : 800-810-5858

www.samsungcamera.com.cn

SAMSUNG OPTO-ELECTRONICS UK LIMITED

SAMSUNG HOUSE 1000 HILLSWOOD DRIVE
HILLSWOOD BUSINESS PARK

CHELTSEY KT16 OPS U.K.

TEL : 00800 12263727

(free for calls from UK only)

UK Service Hotline : 01932455320

www.samsungcamera.co.uk

RUSSIA INFORMATION CENTER

SAMSUNG ELECTRONICS

117545 ST. DOROZHNYA BUILDING 3,

KORPUS 6, ENTRANCE 2, MOSCOW, RUSSIA

TEL : (7) 495-363-1700

CALL FREE : (8) 800 555 55 55 (from Russia only)

www.samsungcamera.ru

Internet address - [http : //www.samsungcamera.com](http://www.samsungcamera.com)



The CE Mark is a Directive conformity
mark of the European Community (EC)