



SAMSUNG

# User Manual

## NX10

This user manual includes detailed usage instructions for your camera. Please read this manual thoroughly.

 [Click a topic](#)

Quick reference

Contents

Basic functions

Basic shooting

Extended shooting functions

Playback/Editing

Camera settings menu

Appendixes



## Health and safety information

Always comply with the following precautions and usage tips to avoid dangerous situations and ensure peak performance of your camera.



**Warning**—situations that could cause injury to yourself or others



**Caution**—situations that could cause damage to your camera or other equipment



**Note**—notes, usage tips, or additional information



### Safety warnings

#### Do not use your camera near flammable or explosive gases and liquids

Do not use your camera near fuels, combustibles, or flammable chemicals. Do not store or carry flammable liquids, gases, or explosive materials in the same compartment as the camera or its accessories.

#### Keep your camera away from small children and pets

Keep your camera and all accessories out of the reach of small children and animals. Small parts may cause choking or serious injury if swallowed. Moving parts and accessories may present physical dangers as well.

#### Prevent damage to subjects' eyesight

Do not use the flash in close proximity (closer than 1 m/3 ft) to people or animals. Using the flash too close to your subject's eyes can cause temporary or permanent damage.

#### Handle and dispose of batteries and chargers with care

- Use only Samsung-approved batteries and chargers. Incompatible batteries and chargers can cause serious injuries or damage to your camera.
- Never dispose of batteries in a fire. Follow all local regulations when disposing of used batteries.
- Never place batteries or cameras on or in heating devices, such as microwave ovens, stoves, or radiators. Batteries may explode when overheated.



### Safety precautions

#### Handle and store your camera carefully and sensibly

- Do not allow your camera to get wet—liquids can cause serious damage. Do not handle your camera with wet hands. Water damage to your camera can void your manufacturer's warranty.

- Do not expose the camera to direct sunlight or high temperatures for an extended period of time. Prolonged exposure to sunlight or extreme temperatures can cause permanent damage to your camera's internal components.
- Avoid using or storing your camera in dusty, dirty, humid, or poorly-ventilated areas to prevent damage to moving parts and internal components.
- Remove the batteries from your camera when storing it for an extended period of time. Installed batteries may leak or corrode over time and cause serious damage to your camera.
- Protect your camera from sand and dirt when using it on beaches or in other similar areas.
- Protect your camera from impact, shock, bending, or press of heavy goods when you connect either cable or power code. It may damage your camera or cable or cause by electric shock or fire.
- Exercise caution when connecting cables or adaptors and installing batteries and memory cards. Forcing the connectors, improperly connecting cables, or improperly installing batteries and memory cards can damage ports, connectors, and accessories.
- Do not insert foreign objects into any of your camera's compartments, slots, or access points. Damage due to improper use may not be covered by your warranty.
- Do not use broken power cord, plug, or wall-outlet. It may cause by electric shock or fire.

### Protect batteries, chargers, and memory cards from damage

- Avoid exposing batteries or memory cards to very cold or very hot temperatures (below 0° C/32° F or above 40° C/104° F). Extreme temperatures can reduce the charging capacity of your batteries and can cause memory cards to malfunction.
- Prevent batteries from making contact with metal objects, as this can create a connection between the + and – terminals of your battery and lead to

temporary or permanent battery damage.

- Prevent memory cards from making contact with liquids, dirt, or foreign substances. If dirty, wipe the memory card clean with a soft cloth before inserting in your camera.
- Turn off the camera when inserting or removing the memory card.
- Do not bend, drop, or subject memory cards to heavy impact or pressure.
- Do not use memory cards that have been formatted by other cameras or by a computer. Reformat the memory card with your camera.
- Never use a damaged charger, battery, or memory card.

### Use only Samsung-approved accessories

Using incompatible accessories may damage your camera, cause injury, or void your warranty.

### Protect your camera's lens

- Do not expose the lens to direct sunlight, as this may discolor the image sensor or cause it to malfunction.
- Protect your lens from fingerprints and scratches. Clean your lens with a soft, clean, debris-free lens cloth.



### Important usage information

### Allow only qualified personnel to service your camera

Do not allow unqualified personnel to service the camera or attempt to service the camera yourself. Any damage that results from unqualified service is not covered by your warranty.

### Ensure maximum battery and charger life

- Overcharging batteries may shorten battery life. After

charging is finished, disconnect the cable from your camera.

- Over time, unused batteries will discharge and must be recharged before use.
- Disconnect chargers from power sources when not in use.
- Use batteries only for their intended purpose.

### Exercise caution when using the camera in humid environments

When transferring the camera from a cold environment to a warm and humid one, condensation can form on the delicate electronic circuitry and memory card. In this situation, wait for at least 1 hour until all moisture has evaporated before using the camera.

### Check that the camera is operating properly before use

The manufacturer takes no responsibility for any loss of files or damage that may result from camera malfunction or improper use.

### Copyright information

- Microsoft Windows and the Windows logo are registered trademarks of the Microsoft Corporation.
- HDMI, the HDMI logo and the term "High Definition Multimedia Interface" are trademarks or registered trademarks of HDMI Licencing LLC.
- QuickTime® and QuickTime® logo are trademarks or registered trademarks of Apple Computer, Inc., used under licence.

- Camera specifications or contents of this manual may be changed without prior notice due to upgrade of camera functions.
- For Open Source License information, refer to the "OpenSourceInfo.pdf" in the provided CD-ROM.

## Organization of the user manual

### Basic functions 12

Learn about your camera's layout, icons, and basic functions for shooting.

### Basic shooting 38

Learn how to take a photo by selecting a mode and how to record a video.

### Extended shooting functions 50

Learn about the options you can set in shooting mode. By using the shooting options, you can enjoy more customized pictures and movies.

### Playback/Editing 78

Learn how to play back photos, videos, and edit photos or videos. Also, learn how to connect your camera to your computer, photo printer, TV, or HDTV.

### Camera settings menu 102

The camera use environment can be set to a desired state by using the setup menu.

### Appendixes 109

Refer to settings, error messages, specifications, and maintenance tips.

## Indications used in this manual

Shooting mode	Marking
Smart Auto	
Program	<b>P</b>
Aperture Priority	<b>A</b>
Shutter Speed Priority	<b>S</b>
Manual	<b>M</b>
Night	
Portrait	
Landscape	
Scene	<b>SCENE</b>
Movie	

Shooting mode explanation shown next to the title

This shows that the functions explained can only be selected from within the shooting mode. In the case of the **SCENE** mode, this corresponds to only part of the scene.

**Ex) Adjusting exposure (brightness)**

### Adjusting the exposure (brightness)

P A S SCENE

The images can be taken bright or dark according to the amount of light. In this case, appropriate adjustment can be made by controlling the amount of light entered into the lens.



▲ Applying -    ▲ 0    ▲ Applying +

**P** (Program),  
**A** (Aperture priority),  
**S** (Shutter priority),  
 (Night),  
 (Portrait),  
 (Landscape),  
**SCENE** (Scene), or  
 (Movie) mode.

The diagram below illustrates the shooting mode dial on the camera body.

To select a shooting mode, you rotate the dial until the mode you want lines up with the hash mark on the camera.

The diagram below shows the status has been changed to (SMART).

Currently selected shooting mode

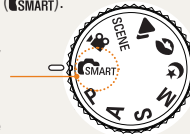

## Directional Keys in the User's Manual

When explaining the steps needed for navigating the menu, the up, down, left and right directional arrows are shown below.

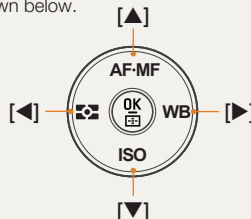

**Ex) Executing the 'Play' mode**

The user can check saved pictures and movies.

- 1 Press
  - Show most recently saved files.
- 2 Check the following pictures sequentially by using .

## Menu display used in this manual

Menu display of the photo shooting mode

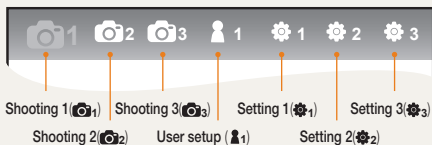



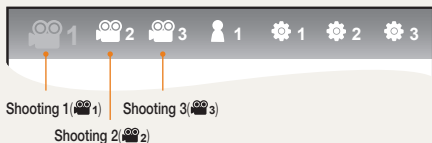

Menu display of the movie shooting mode



Ex) Setting the image quality of movie file

- 1 Set the mode dial to .
- 2 Press **[MENU]**.
- 3 Select **Shooting 1 (1)** → **Quality**.
- 4 Select a desired image quality.

## Icons used in this manual

Symbol	Explanation
	Additional information about the function
	Safety warnings and precautions
	Indicates a camera button, for example: <b>[Shutter]</b> represents the shutter button.
	Shows the reference page
	Display when selecting a menu or option within the step Example: Select <b>Shooting 1 (1)</b> → <b>Quality</b> . (represents select <b>Shooting 1 (1)</b> , and then <b>Quality</b> )
*	Comment explaining symbols

## Abbreviations used in this manual

Abbreviations	Explanation
<b>AF</b> (Auto Focus)	Auto focus
<b>BKT</b> (Bracketing)	Bracketing
<b>DPOF</b> (Digital Print Order Format)	Printing order mark
<b>EV</b> (Exposure Value)	Exposure value
<b>OIS</b> (Optical Image Stabilization)	Optical image stabilization
<b>ISO</b> (International Standard for color negative film)	Film sensitivity
<b>WB</b> (White Balance)	White balance

## Expressions used in this manual

### Pressing the shutter

- Half-press [**Shutter**]: press the shutter halfway down
- Press [**Shutter**]: press the shutter all the way down

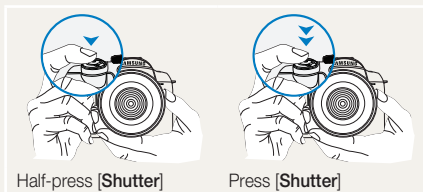

### Subject, background, and composition

- **Subject**: the main object of a scene, such as a person, animal, or still life
- **Background**: the objects around the subject
- **Composition**: the combination of a subject and background

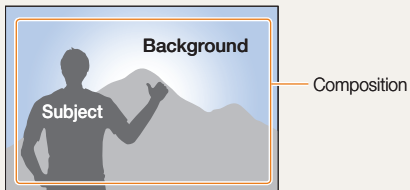

### Exposure (Brightness)

The amount of light that enters your camera determines the exposure. You can alter the exposure with shutter speed, aperture value, and ISO speed. By altering the exposure, your photos will be darker or lighter.



Normal exposure

Overexposure (too bright)

# Quick reference



## Taking photos of people

- **SCENE** mode → Beauty Shot ▶47
- Red-eye reduction ▶56
- Face Detection AF ▶64



## Taking photos at night or in the dark

- **C** mode ▶45
- Flash setting options ▶55
- ISO speed setting ▶59



## Taking action photos

- **S** mode ▶42
- Continuous, Burst shooting ▶73



## Taking photos of text, insects, or flowers

- **SMART** mode → Close-up shot ▶39
- Using the White Balance ▶68



## Adjusting the exposure (brightness)

- ISO speed setting ▶59
- Adjusting exposure ▶66
- Metering ▶67
- BRK(Bracketing) ▶74



## Applying a different effect

- Picture Wizard ▶75
- Photo Style ▶88



## Reducing camera shake

- Optical Image Stabilization (OIS) ▶35

- Viewing files by category in Smart Album ▶81
- Deleting all files on the memory card ▶83
- Viewing files as a slide show ▶84
- Viewing files on a TV or HDTV ▶92
- Connecting your camera to a computer ▶93
- Adjusting sound and volume ▶104
- Adjusting the brightness of the display ▶104
- Changing the display language ▶104
- Setting the date and time ▶106
- Formatting the memory card ▶105
- Troubleshooting ▶115



# Contents

---

Basic functions .....	12	Setting the automatic/manual focus function.....	34
Unpacking.....	13	Zooming.....	34
Title and role of each part.....	14	Optical Image Stabilization (OIS).....	35
Diopter adjustment dial/eye-cup/Status lamp.....	16	Using the OIS in the menu option .....	36
Description for each part of the lens.....	17	Depth preview .....	37
Preparations before shooting .....	18	<b>Basic shooting .....</b>	<b>38</b>
Charging the battery.....	18	Using the Smart Auto mode.....	39
Installing the battery.....	19	Using the Program mode.....	40
Installing the memory card .....	20	Using the Aperture Priority, Shutter Priority, or Manual mode.....	41
Mounting/dismounting the lens .....	21	Using the Aperture Priority mode.....	41
Connecting the strap.....	22	Aperture value .....	41
Turning on the power and initialization .....	23	Using the Shutter Priority mode.....	42
Icons .....	25	Shutter speed.....	42
Option/menu selection method.....	26	Using the Manual mode .....	43
Using the dial.....	26	Using the Night/Portrait/Landscape mode .....	45
Using [Fn] .....	27	Using the night mode .....	45
Setting the display and sound.....	28	Using the portrait mode.....	45
Changing the display type .....	28	Using the landscape mode.....	45
Setting user display .....	29	Using the Scene mode.....	46
Setting the sound .....	29	Using the Beauty Shot mode .....	47
Setting the screen display .....	30	Recording a Movie .....	48
Simple picture-taking method .....	31	Setting the aperture value.....	48
Tips for getting a clearer photo.....	32	To fade out the screen .....	48
Holding your camera correctly.....	32	Using the Wind Cut .....	49
Image stabilization .....	32		
Half-pressing the shutter button.....	32		
Getting your subject in focus.....	33		

Extended shooting functions.....	50	Self-portrait face detection .....	65
Setting the resolution and quality .....	51	<b>Brightness and color adjustment of picture .....</b>	<b>66</b>
Setting a resolution.....	51	Adjusting the exposure (brightness).....	66
Setting the image quality of the picture.....	52	Exposure adjustment.....	66
Setting the quality of movie.....	52	Changing the brightness measurement method.....	67
Noise reduction .....	53	Setting the white balance .....	68
Using the timer function .....	54	Color space.....	71
Setting the timer function.....	54	Smart range .....	72
Taking a picture in a dark place.....	55	<b>Changing the shooting method.....</b>	<b>73</b>
Using the flash popup button .....	55	Successive shooting method and timer setup.....	73
Setting the flash option.....	55	Detailed bracket setup .....	74
Using the red-eye fix function .....	56	<b>Special effect/photo retouching .....</b>	<b>75</b>
1st Curtain, 2nd Curtain .....	56	Picture wizard.....	75
Adjusting the amount of flash light.....	57	<b>Key Mapping.....</b>	<b>77</b>
Using an external flash unit (purchased separately) ..	58	Setting the Key Mapping .....	77
Adjusting the ISO sensitivity.....	59		
Focusing methods .....	60		
Changing the Focusing methods.....	60		
AF Priority.....	60		
Using the AF assist light .....	61		
Changing the focus area .....	61		
Setting the focus of the selected area .....	62		
Setting the MF Assist.....	63		
Face detection .....	64		
Normal face detection .....	64		

Playback/Editing .....	78	Printing photos with a photo printer (PictBridge) .....	101
Play (picture/movie).....	79	Camera settings menu.....	102
Viewing pictures in the play mode .....	79	Camera settings menu .....	103
View files in the smart album by category.....	81	Sound .....	104
Converting into the thumbnail view.....	81	Display.....	104
File protection.....	82	Normal setup 1.....	105
Deleting a file.....	82	Normal setup 2.....	106
Enlargement/reduction .....	84	Normal setup 3.....	107
View a movie.....	85	Appendixes .....	109
Picture editing .....	87	Error messages.....	110
Changing the resolution.....	87	Camera maintenance.....	111
Rotating.....	87	Cleaning your camera.....	111
Red-eye fix .....	88	About memory cards.....	112
Adjusting the backlight .....	88	About the battery.....	113
Picture style.....	88	Before contacting a service center .....	115
Face retouching.....	88	Camera specifications.....	118
Setting the print info (DPOF) .....	89	Lens specifications.....	122
Viewing files on a TV or HDTV.....	91	Accessories (optional items).....	123
Transferring files to your computer.....	93	Index.....	125
For Windows users.....	93		
For Mac users .....	96		
Using Samsung Master .....	97		
Using the Samsung RAW Converter .....	98		
Correcting the exposure.....	99		
Handling the JPEG/TIFF files as you edit RAW files ..	100		
Saving the RAW files into JPEG or TIFF format .....	100		

# Basic functions

Learn about your camera's layout, icons, and basic functions for shooting.

Unpacking .....	13
Title and role of each part .....	14
Preparations before shooting .....	18
Turning on the power and initialization .....	23
Option/menu selection method .....	26
Setting the display and sound.....	28
Simple picture-taking method.....	31
Tips for getting a clearer photo .....	32

# Unpacking

Check your product box for the following items.



Camera (Body cap, eye-cup, Hot-shoe cover included)



USB cable



Battery



Strap

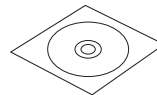

Software installation CD (including user's manual)

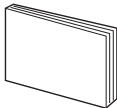

Quick Start Manual



Charger/AC power cable





The actual components or optional parts may differ from the illustrations above.  
For information about optional items, see "Accessories (optional items)." (p. 123)

# Title and role of each part

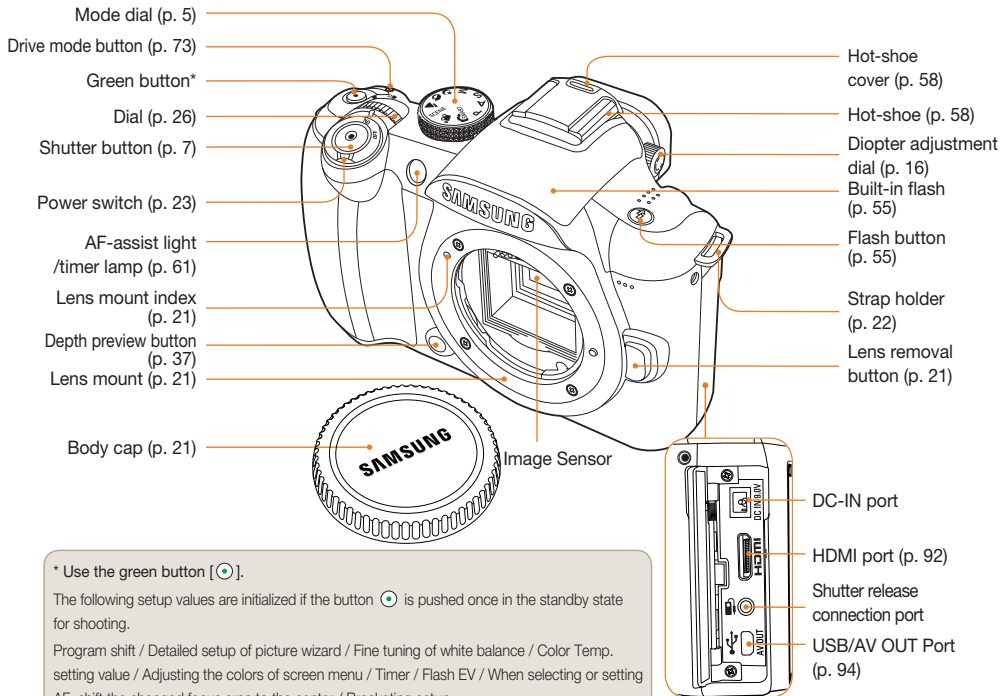
14



\* Use the green button [  ].

The following setup values are initialized if the button  is pushed once in the standby state for shooting.

Program shift / Detailed setup of picture wizard / Fine tuning of white balance / Color Temp. setting value / Adjusting the colors of screen menu / Timer / Flash EV / When selecting or setting AF, shift the changed focus area to the center / Bracketing setup

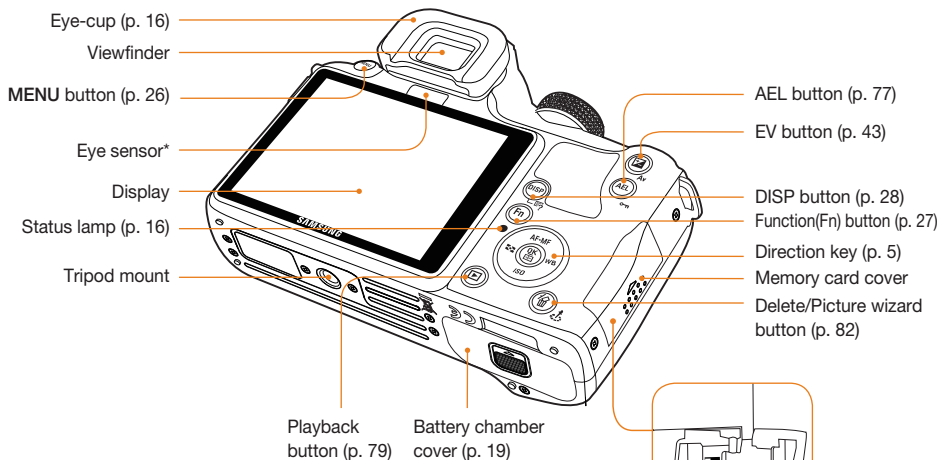

**\* Use of eye sensor**

This product will automatically convert to EVF when the users try to use the view-finder (EVF) by operating the eye sensor in Auto Select mode and all the information will be shown on the view-finder. Do not cover the eye sensor with your hands or materials.

## Diopter adjustment dial/Eye-cup/ Status lamp

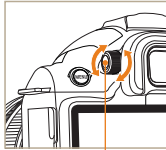

Eyesight  
adjustment dial

### Use of Diopter adjustment dial

It is possible to adjust the viewfinder appropriate for the eyesight of user.

If the image is not shown clearly through the viewfinder, move the eyesight adjustment dial in the left/right direction to have a clear view.

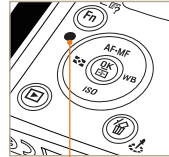

Status lamp

### Status lamp

In the case of saving a picture or shooting a movie, this shows the operating status of the camera by blinking the status indicator lamp

- **Blinking:** When saving photos, recording movies, being read by a computer or printer.
- **Steady:** When there is no data transfer or when connecting to a computer or printer is complete.

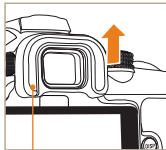

Eye-cup

### Removal of Eye-cup

When the camera is shipped, the eyecup is attached to the viewfinder. Push the Eye-cup up as shown in the figure for removal.



## Description for each part of the lens

17

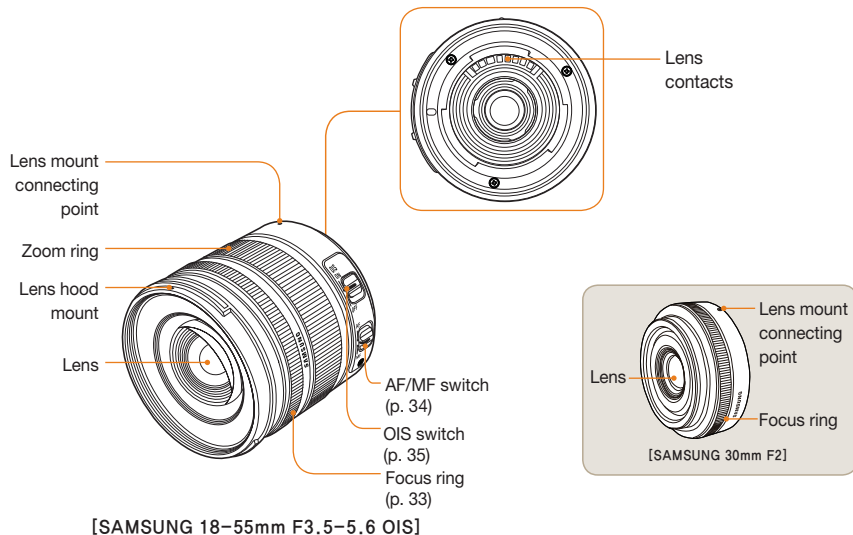

- When purchasing the lens separately, please contact a Samsung service center to verify the compatibility of the camera and lens.
- This information in this user manual is based on the **SAMSUNG 18-55mm F3.5-5.6 OIS** lens. Please refer to the lens user manual for more information about the lens.

# Preparations before shooting

## Charging the battery

Please charge the battery fully before using this product.

Please make the connections as in the following figure.

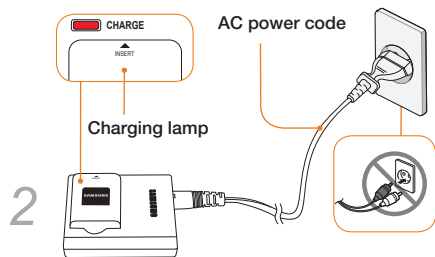
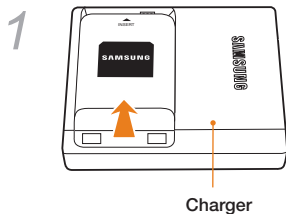

- To remove the battery from the charger, lift slightly in the direction of the arrow.
- Please use designated charger or batteries for proper use. SAMSUNG is not responsible for any accident that may occur from using a product other than designated.

Color of charge lamp	Charging status
Red	Charging
Green	Fully charged
Turned off, or Yellow	Charging error

## Installing the battery

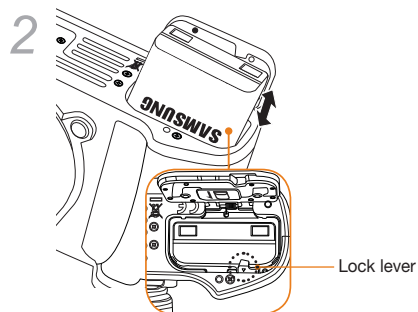
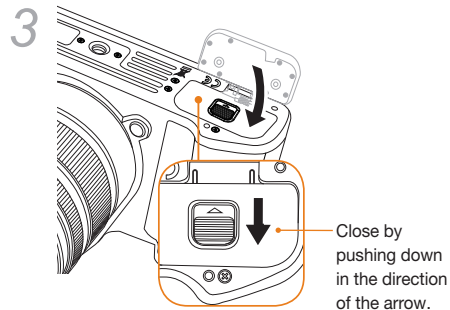
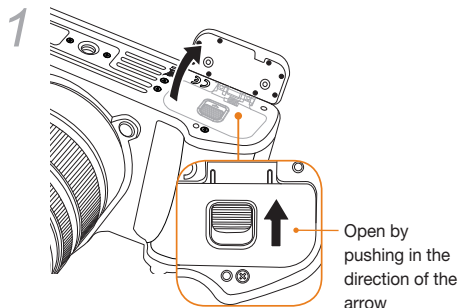

When taking out the battery, pull down slightly on the lock lever. You can then remove the battery.

## Installing the memory card

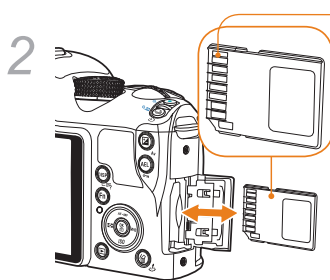
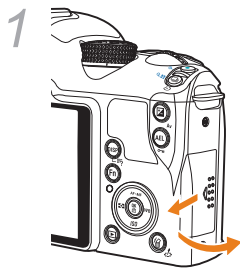

After checking the direction of metal terminal, you can insert the memory card.

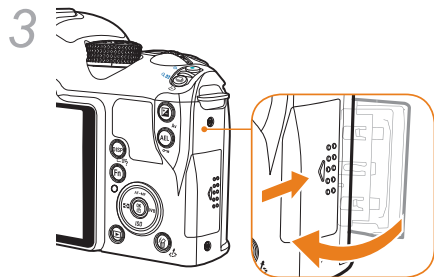

- To remove the memory card, push the card slightly in the direction of insertion.
- Please do not remove the memory card or battery while the status indicator lamp is blinking. It may cause loss of data or product damage.

## Mounting/dismounting the lens

Please remove the lens mount cover and body cap prior to the installation of lens.

After matching the lens mount index (red) of camera body with the point (red) of lens mount, join the lens by turning the lens clockwise until it clicks. When removing the lens, turn the lens counter clockwise while holding down the lens dismount button.

### Before mounting the lens



### Lens mounting

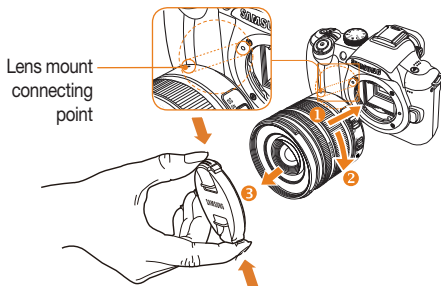

### Dismounting the lens

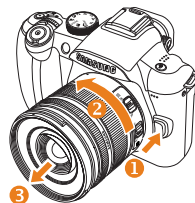

- Mounting or dismounting the lens while the camera is powered off is desirable to ensure the stable operation of the lens.
- SAMSUNG is not responsible for any accident, damage, or trouble caused by using other company's lens.
- The body cap protects the product from scratches or dust when you transport it.



- Change lenses in a clean, low dust environment. Foreign particles inside the body or lens of the camera can cause the camera to malfunction.
- When mounting the lens, please do not touch the inner part of the camera with your finger. Dust or foreign particles inside the camera can affect image quality or cause the camera to malfunction.

## Connecting the strap

Connecting the strap to the camera body so you can carry the camera easily.

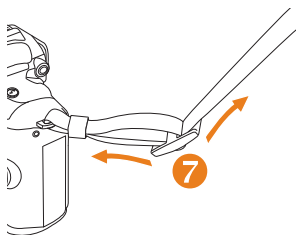
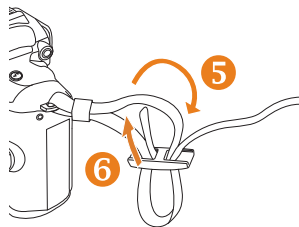
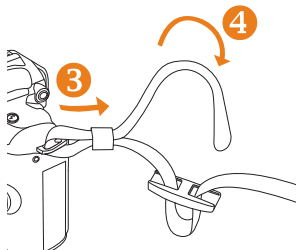
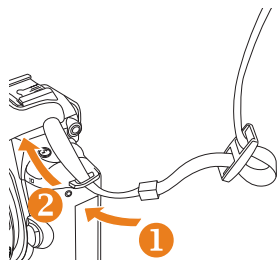

## Turning on the power and initialization

When turning the power on/off, please set the power switch to **ON/OFF**.

When you turn on the camera for the first time, the camera may ask you to set the language and date.



- 1 Press [▼] to select **Language**, and then press [OK].
- 2 Press [▲/▼/◀/▶] to select a language, and then press [OK].
  - The screen appears in the language you selected.



- 3 Press [▲/▼] to select **Date**, and then press [OK].
- 4 Press [▲/▼/◀/▶] to set the date, and then press [OK].



- 5 Press [▼] to select **Time Zone** and then press [OK].
- 6 Select a desired world time zone by pressing [◀/▶].

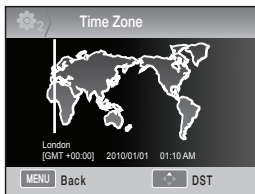

- 7 To set daylight saving time, press [▲]. Press [▲] again to disable.
- 8 Press [OK] to save.
- 9 Press [▼] to select **Time**, and then press [OK].
- 10 Set desired time by pressing [▲/▼/◀/▶], and then press [OK].

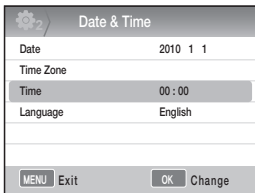

- 11 Press [MENU] to finish setting.

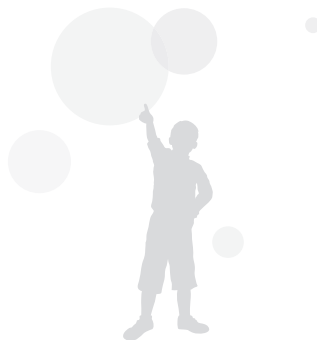



## Turning on the power and initialization

All the details shown on the view finder will appear identically on the display.

By using the live view function, the user can take a picture conveniently without having to look through the viewfinder. The icons shown on the screen are for when the OIS and AF/MF switches on the lens are in use.

### Icons

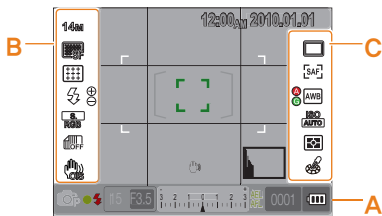

#### A Information display

	Shooting mode
	Movie shooting mode
	Focus checking
	Flash
15	Shutter speed
F3.5	Aperture value
	Adjusted value of exposure
AEL AFL	AEL/AFL setting
0001	Possible no. of shots
	Battery information
	Displays no-insertion of memory card
	Warning of camera shake
12:00 PM 2010.01.01	Time, date and year info
	Focus indicator
	Spot metering area
	AF zone
	Histogram
	Grid display

#### B Shooting option display(left)

	Size
	Movie size
	Image quality
	Movie quality
	Focus area
	Flash
	Flash light adjustment
	Color space
	Smart range
	OIS
	Voice recording
	Fader
	Wind Cut

#### C Shooting option display(right)

	Drive mode
	Timer
	AF mode
	White balance
	White balance adjustment
	ISO
	Metering option
	Picture wizard



The display shows the icons for the currently selected option.

# Option/menu selection method

After pressing [MENU], you can select an option or menu by pressing [▲/▼] or [OK].

- 1 Press [MENU] in the Shooting mode.
- 2 You can select a desired option or menu by pressing [▲/▼/◀/▶] or [OK].

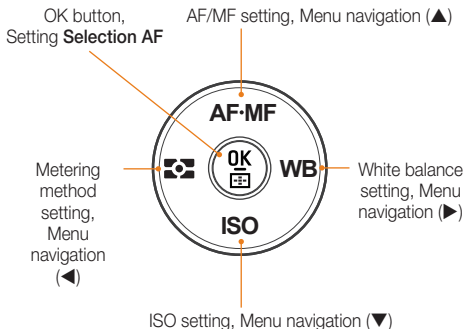

- 3 To save a selected option or menu, press [OK].

## Return to the previous screen.

To return to the previous menu screen, press [MENU].



The user can return to the state of shooting by pressing [Shutter].

## Using the dial

The user may change the menu setting's value by either using the dial or move the menu screen to a desired direction. For example when taking a picture in the shutter speed priority mode, this allows you to quickly adjust the desired shutter speed.

### Example. Using the dial in the S mode

- 1 Set the Mode dial to **S**.
- 2 Adjust the shutter speed by turning the dial.
  - The camera sets aperture value automatically according to the shutter speed you set.

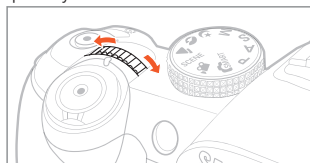

## Using [Fn]

By pressing the **[Fn]** function button, you can easily access major functions such as Quality, Size, AF area, Flash, Color Space, Smart Range, and OIS.

### Example. Flash setting in the P mode

- 1 Set the Mode dial to **P**.
- 2 Press the **[Fn]** button on the body of camera.
- 3 Select **Flash** using the **[◀/▶]** or dial.



- 4 Press **[▲]**.
- 5 Set the flash menu option using the **[◀/▶]** or dial.

- 6 Press **[▲]**.
- 7 Set the flash intensity using the **[◀/▶]** or dial.
  - You can adjust the intensity of the flash by  $\pm 2$  levels.

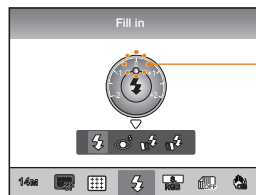

Displays the level of flash intensity adjustment

- 8 Align your subject in the frame and half-press **[Shutter]** to focus.
- 9 Press **[Shutter]** to take a photo.

# Setting the display and sound

Learn how to change basic display and sound settings according to your preferences.

## Changing the display type

You can select the icons and options the camera displays in the Shooting and Play modes by selecting a Display Type.

Press **[DISP]** repeatedly.

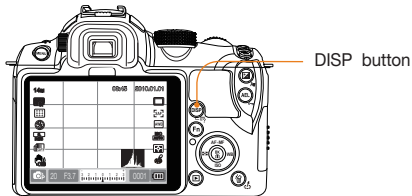

### Viewing the function descriptions of menu

- 1 In the Shooting mode, press **[MENU]**.
- 2 Select a menu option.
  - Press and hold **[DISP]**. The function descriptions of the menu appears on the screen.



<b>Shooting mode</b>	<ul style="list-style-type: none"><li>• Display all the shooting information except for User Display setting values.</li><li>• Display all the shooting modes set by user. (p. 29)</li><li>• Hide all the information except for shooting mode, shutter speed, aperture value, exposure, number of available shots, and battery information.</li></ul>
<b>Playback mode</b>	<ul style="list-style-type: none"><li>• Display the shooting meta information.</li><li>• Display the RGB histogram, currently selected histogram option, and date set.</li><li>• Display shutter speed, aperture value, ISO, file in play, and total number of files saved.</li></ul>

## Setting user display P A S M SCENE

You can add or remove shooting information from the display.

- 1 Press **[MENU]** in the shooting mode.
- 2 Select **User setup** ( ) → **User Display** → an option.

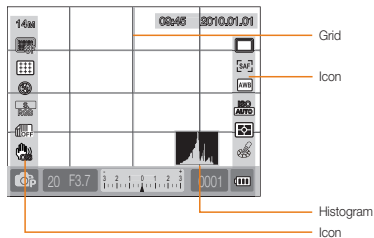

### About histogram

A histogram is a graph that shows the brightness distribution of picture. This represents a dark picture if the graph is inclined to the left and if the graph is leaning to the right, this represents a bright picture. The height of graph is related to the color information and the graph gets higher if a specific color is distributed more.

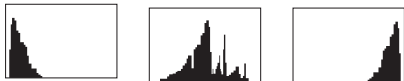

▲ Insufficient exposure ▲ Balanced exposure ▲ Excessive exposure

## Setting the sound

P A S M SCENE

You can set the sound the camera makes when you press the OK button.

- 1 In Shooting or Playback mode, press **[MENU]**.
- 2 Select **Setup2**( ) → **Sound** → **System Volume** → an option.

Off	The camera makes no sound when you press <b>[OK]</b> .
Low, Medium, High	The camera makes a signal sound when you press <b>[OK]</b> .

- 3 Press **[MENU]** to return to the previous mode.

## Setting the screen display

SMART P A S M SCENE

The screen display can be set according to the user's convenience.

- 1 In Shooting or Playback mode, press **[MENU]**.
- 2 Select **Setting 3 (⚙️)** → **Display Select**
- 3 Select a desired option.

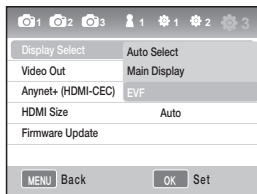

<b>Auto Select</b>	Convert between Main Display and EVF by eye sensor
<b>Main Display</b>	The screen will be shown only through Main Display
<b>EVF</b>	The screen will be shown only through EVF



# Simple picture-taking method

Using the Smart Auto mode, you can take a picture easily with minimum setup.

- 1 Rotate the mode dial to **SMART**.



- 2 Align your subject in the frame.

All the details shown on the view finder will appear identically on the display.

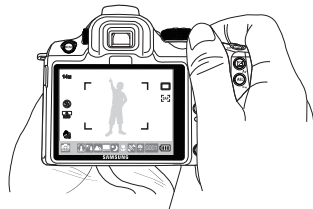

- 3 Half-press **[Shutter]** to focus.

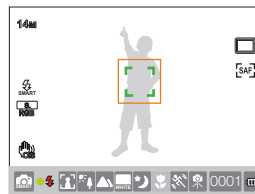

- Green: Focus is set.
- Red: Focus is not set.

- 4 Press **[Shutter]** to take a photo.



- Please refer to the "Tips for getting a clearer photo" (p. 32) to take a clear picture.
- Press **[Q]** to see the saved images on the screen.

## Tips for getting a clearer photo

### Holding your camera correctly

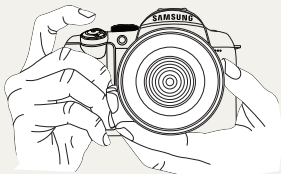

Please make sure that your hand, hair, and strap do not interfere with the lens or flash.

### Half-pressing the shutter button



In order to check in advance whether the focus of composition is set appropriately, please use the half-shutter function. If you press the shutter half-way down, the focus and exposure will be adjusted automatically.

### Image stabilization



- To avoid the blurring effect of camera shake, set the optical Image Stabilization (OIS) function. (p.35)

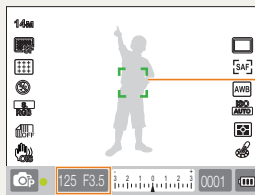

Shows the shutter speed and aperture value being set.

#### Focus frame

- If green, take the picture by pressing the [Shutter].
- If red, either change the composition or adjust the focus again since the focus is not correctly set.





## Getting your subject in focus

Under the following circumstances, it may be difficult to get your subject in focus when:

- When the color contrast is not clear  
(When someone is wearing clothes similar in color to the background)
- When the subject is in front of a strong backlight
- When the subject generates strong reflected light
- When there is a horizontally repeated line pattern (window blinds, etc.)
- When the subject is not located in the center
- When there is a flat white wall behind the subject which does not have specific patterns.
- When there is a fast moving subject.
- When the subject is too close to the camera.



### Please try to use the focus lock function.

Adjust the focus by using the half-shutter function where the camera can focus easily. Then, simply press the **[Shutter]** button after moving the camera to a desired composition. Keep pressing and holding down the half-shutter until you actually make a photo shot.

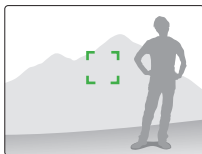
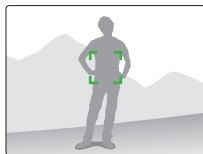

Under the half-shutter state, press the **[AEL]** button of the camera to fix the exposure value and focus information at the same time according to the setting. To cancel the function, press the **[AEL]** button once more. (p. 77)

## Using the manual focus

If the auto focus function does not operate normally due to the environmental factors, you can set the lens to **Manual Focus (MF)** and adjust the focus manually. When the lens' focus method is set to Manual Focus (MF), this function helps focus the subject by expanding the screen automatically. If the focus is adjusted by using the expanded image, the focus can be adjusted more accurately. (p. 63)



- Use the **[AF/MF]** control switch on the lens to switch the camera to manual focus.
- If the lens doesn't have an AF/MF switch you may be able to select **Manual Focus** in the AF mode menu.
- The availability of this option differs, depending on the lens you are using.
- When you adjust the focus manually, the picture may appear blurred if you don't set the focus accurately. Take pictures after setting the focus accurately.
- When using the manual focus function, the **AF Area** is not available to use.
- In the movie shooting mode, you can not set the focus by using the expanded image.

## Setting the automatic/manual focus function

You can set the camera to adjust focus automatically or manually by using the AF/MF switch on the side of the lens.

### 1 Using automatic focus

Set the AF/MF switch of the lens to **AF**.  
The focus adjusts automatically when you press the shutter button half way down.

### 2 Using manual focus

Set the AF/MF switch of the lens to **MF**.  
You can adjust the focus manually by turning the focus ring.

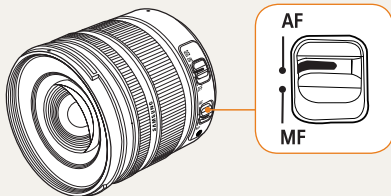

Some lens models do not have the AF/MF switch. Please consider this when purchasing a lens. (p.60)

## Zooming

Using the zoom ring, you can enlarge (telephoto angle) or reduce (wide angle) the size of an image by changing the focal length value of the camera lens.

Adjust the image to the desired size, and then take a picture.

- 1 Check the focus, and then turn the zoom ring to the left/right.
  - The focal length of the lens changes and the subject appears enlarged or reduced.
- 2 Half-press **[Shutter]** to focus.
- 3 Press **[Shutter]** to take a photo.



Since the focus can change slightly when you zoom in or out, we recommend you adjust the focus again prior to taking a picture.



## Optical Image Stabilization (OIS)

Use the optical image stabilization (OIS) function when taking pictures to minimize camera shake and improve focus.

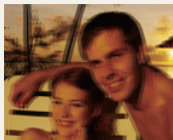

▲ Before applying OIS

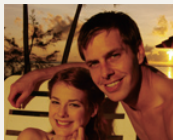

▲ After applying OIS

### Using the OIS switch of lens

The OIS function can be used only in the case that the lens in use has the OIS function.

To use this function, please set [OIS] to ON.

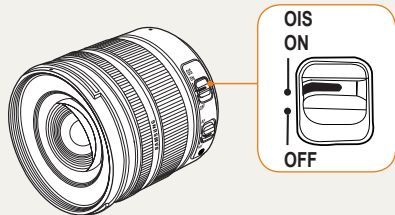





## Using the OIS in the menu option

After setting the OIS switch, select the OIS function in the menu option

- 1 In Shooting mode, press **[MENU]**.
- 2 Select **Shooting3** (📷/📷3) → **OIS** → an option.

	<b>Mode 1</b>	The OIS function is applied only when pressing the shutter in full or half.
	<b>Mode 2</b>	The OIS function is always applied.



- The OIS function may not work well in the following situations:
  - When you take a picture while tracing a moving object
  - When a big vibration occurs beyond the range of stabilization
  - When the shutter speed is too slow due to a circumstance like night shooting
  - When the battery capacity is not sufficient
  - When you are shooting a close-up shot
- When you use a tripod, please disable the OIS function since the image can be shaken due to the vibration of OIS function.
- If the camera is struck or dropped while you are taking a picture, the display can be impaired. If this occurs, turn the camera off and then on, and the camera should operate normally again.
- Since the battery consumption can increase along with the use of OIS function, it is recommended to use the function only if needed.
- To set the OIS function by using the menu, set **[OIS]** of lens to **ON**. This function may not operate depending on the lens model.
- The function can be set directly by pressing **[Fn]** in the shooting mode.



## Depth preview P A S M

When you are not using the depth preview function, you can only see the subject through the camera in the condition of the maximum aperture (minimum f-number) in the shooting mode.

Use the Depth of Field Preview function before taking a picture to view the depth of field of the scene as it looks with the lens set to its current f-stop number.

- 1 Press the **[Depth Preview]** in the Shooting mode.

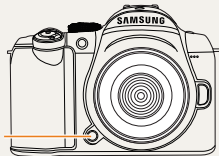

Depth preview button

- 2 You can check the depth of field result actually taken through the display and viewfinder.



You can set the function of a button differently by using the **Key Mapping** menu option. (p. 77)

### What is the depth of field?

When you focus on a specific subject, there is a range in which objects closer and further away are all in focus. This focused range is called the depth of field.

The wider the wide-angle lens, the higher the aperture value, the greater the depth of field.

For example, the aperture stop, f 11 is higher than f 2.8.

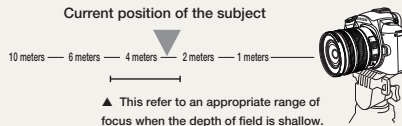
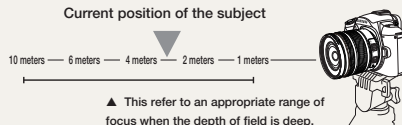

# Basic shooting

Learn how to take a photo by selecting a mode and how to record a video.

Using the Smart Auto mode .....	39
Using the Program mode .....	40
Using the Aperture Priority, Shutter Priority, or Manual mode .....	41
Using the Night/Portrait/Landscape mode .....	45
Using the Scene mode .....	46
Recording a Movie .....	48







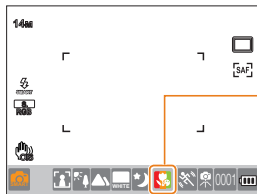

# Using the Smart Auto mode







The smart auto mode allows taking pictures under an optimized condition since the camera recognizes various photographing conditions automatically. Therefore, even a beginner can use the camera easily.

- 1 Rotate the mode dial to  SMART.
- 2 Align your subject in the frame.
  - The camera automatically detects the type of scene and displays the corresponding scene icon in the display.





The camera displays the scene icon corresponding to the scene it detects.

	Outdoor landscape shot
	Highly bright background shot
	Night landscape shot
	Outdoor portrait shot at night
	Backlight landscape shot without a man
	Portrait shot under backlight
	Portrait shot
	Close-up shot
	Close-up character shot

	Sunset shot
	Blue sky shot
	Nature shot such as forest and leaves
	Close-up shot for the subject with various colors
	Close-up portrait shot
	With the camera on a tripod, a shot of a subject that does not move for a period of time.
	Shot of fast moving subject or subject that moves frequently.



- If the camera does not detect a type of scene, it takes pictures with the basic settings of the  mode.
- Even if it detects a face, the camera may not select portrait mode because of the orientation and brightness of the face.
- The camera may not recognize a scene because of adverse photograph conditions such as bad lighting, camera shake, and subject distance.
- The camera may not recognize the  mode, even if the camera is on a tripod, depending on the movement of the subject.

- 3 Half-press **[Shutter]** to focus.
- 4 Press **[Shutter]** to take a photo.





# Using the Aperture Priority, Shutter Priority, or Manual mode

By using the aperture value of adjusting light volume and shutter speed, you can take pictures of desired exposure.

As for the shooting modes that allows adjusting the aperture value and shutter speed, there are the aperture priority mode, shutter speed priority mode, and manual mode.

## Using the Aperture Priority mode

The Aperture Priority mode lets you to set the aperture value manually while the camera automatically selects an appropriate shutter speed.

- 1 Rotate the Mode dial to **A**.
- 2 Rotate the dial to adjust the aperture value.

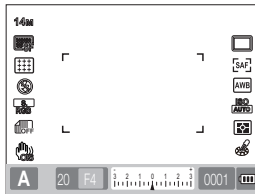

- 3 Set options.
  - For a list of options, refer to “Extended shooting functions.”(p. 50)
- 4 Align your subject in the frame and half-press **[Shutter]** to focus.
- 5 Press **[Shutter]** to take a photo.

## Aperture value

The aperture value of a lens can be adjusted to control the amount of light reaching the image sensor. When opening the aperture (reduce the aperture value), objects closer and further away than the focused subject will be out of focus. When closing the aperture (increase the aperture value), the range in focus expands forward and backward.

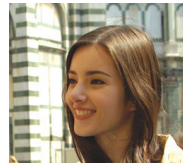

▲ Increased aperture value (narrower opening)



▲ Reduced aperture value (wider opening)

## Using the Shutter Priority mode

The Shutter Priority mode lets you set the shutter speed manually while the camera automatically selects an appropriate aperture value.

- 1 Rotate the Mode dial to **S**.
- 2 Rotate the dial to adjust the shutter speed.

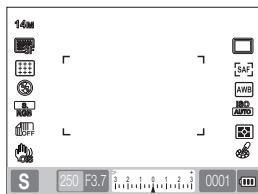

- 3 Set options.
  - For a list of options, refer to “Extended shooting functions.”(p. 50)
- 4 Align your subject in the frame and half-press **[Shutter]** to focus.
- 5 Press **[Shutter]** to take a photo.

## Shutter speed

Shutter speed is the length of time the shutter is open. You can create many interesting effects by adjusting the shutter speed. A low shutter speed blurs motion on the image. You can feel the speed in the picture when the low shutter speed is used for a shot.

A fast shutter speed is essential for capturing the movement. A faster shutter speed froze the subject in its movement.



▲ Slow shutter speed

▲ Fast shutter speed

## Using the Manual mode

In the manual mode, you can take pictures by setting various shot options directly including the shutter speed and aperture value.

- 1 Rotate the Mode dial to **M**.
- 2 Rotate the dial to adjust the shutter speed.
- 3 Rotate the dial to adjust the aperture value while press and hold the **[EV]**.

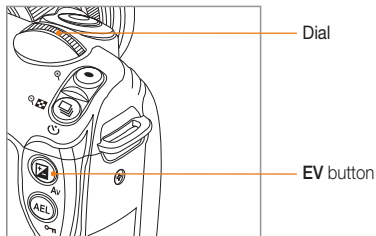

- 4 Set desired shooting options.
  - For a list of options, refer to “Extended shooting functions.”(p. 50)
- 5 Align your subject in the frame and half-press **[Shutter]** to focus.
- 6 Press **[Shutter]** to take a photo.



- In the P (Program), S (Shutter Priority), or A (Aperture Priority) modes, when a value appears in red, it is outside the range of values that produces good pictures.
  - P** mode: Shutter speed and aperture value can appear in red.
  - S** mode: Shutter speed can appear in red.
  - A** mode: Aperture value can appear in red.
- The camera can not set the ISO speed automatically in the **M** (manual) mode.

### Using the bulb exposure

By using the bulb exposure, you can set the shutter speed as long as you want.

- 1 Rotate the Mode dial to **M**.
- 2 Rotate the dial and set the shutter speed to **Bulb**.
  - Bulb exposure indication appears next to the shutter speed of 30"(seconds).

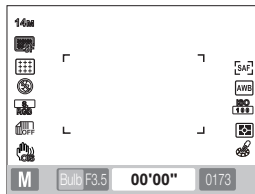

- 3 To adjust the aperture value, press and hold the **[EV]** while rotating the dial.
- 4 Align your subject in the frame and half-press **[Shutter]** to focus.
- 5 Press **[Shutter]** to take a photo.
  - The exposure time continues until you finish holding the **[Shutter]**. Press and hold the **[Shutter]** for desired time. As soon as you finish holding the **[Shutter]**, the shooting is complete.



- To improve image stability in the Bulb Exposure mode, we recommend you use a reliable tripod or shutter release (purchased separately).
- With long exposures, the time the camera takes to save images gets longer as well. This is not a problem with the product and you do not need to replace the battery.
- Before using Bulb Exposure to take long exposures, we recommend you fully charging the battery.
- When you use Bulb Exposure to take long exposures, visual noise can occur. To control visual noise, we recommend you turn the Noise Reduction function on. The Noise Reduction function operates when the shutter exposure exceeds 1 seconds.
- When you use Bulb Exposure, the Successive Shooting function is unavailable.
- When you use Bulb Exposure, you can not set the ISO Speed to **AUTO**.

# Using the Night/Portrait/Landscape mode

## Using the night mode

Night mode provides the optimal exposure settings for dark or night time environments.

- 1 Rotate the Mode dial to .
- 2 Align your subject in the frame and half-press **[Shutter]** to focus.
- 3 Press **[Shutter]** to take a photo.



When you use Night mode, we recommended you also use a tripod, shutter release, or Timer function (purchased separately) to minimize camera shake.

## Using the portrait mode

In Portrait mode, the camera automatically sets optimal portrait shot settings.

- 1 Rotate the Mode dial to .
- 2 Align your subject in the frame and half-press **[Shutter]** to focus.
- 3 Press **[Shutter]** to take a photo.



In the portrait mode, the focus area is automatically set to the face as it is set to the **Face Detection AF** mode automatically.

## Using the landscape mode

Landscape mode provides the optimal exposure and focus settings for natural landscapes.

- 1 Rotate the mode dial to .
- 2 Align your subject in the frame and half-press **[Shutter]** to focus.
- 3 Press **[Shutter]** to take a photo.



In the landscape mode, the camera adjusts shutter speed automatically according to the aperture value.

We recommend you use a tripod in case the camera selects a slow shutter speed setting.

## Using the Scene mode

Since an appropriate option is set in advance by the scene, the shot can be taken conveniently by selecting a scene appropriate for the situation.

- 1 Rotate the Mode dial to **SCENE**.
- 2 Select a scene.
  - Press **[MENU]** to select a scene. You can select a desired scene.
  - For the Beauty Shot mode, see “Using the Beauty Shot mode.”

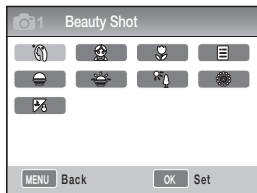

- 3 Align your subject in the frame and half-press **[Shutter]** to focus.
- 4 Press **[Shutter]** to take a photo.



If you have the camera set to Standby mode and the Mode dial set to **SCENE**, you can directly select a desired scene by pressing **[Fn]**.



## Using the Beauty Shot mode SCENE

In the beauty shot mode, you can take pictures with options that make faces appear smooth and blemish-free.

- 1 Rotate the Mode dial to **SCENE**.
- 2 Press **[MENU]**.
- 3 Select **Shooting1** (📷<sub>1</sub>) → **SCENE** → **Beauty Shot**.
- 4 Select **Shooting3** (📷<sub>3</sub>) → **Face Tone**.
- 5 Set options.
  - Select a higher setting to make skin tone appear lighter.

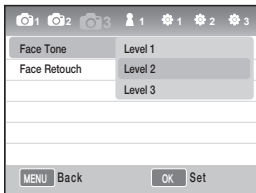

- 6 Select **Shooting3** (📷<sub>3</sub>) → **Face Retouch**.

- 7 Set options.

- Select a higher setting to make skin tone appear lighter.

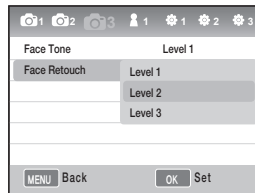



- 8 Align your subject in the frame and half-press **[Shutter]** to focus.
- 9 Press **[Shutter]** to take a photo.



In the **Beauty Shot** mode, AF area is set to **Face Detection AF** or **Self-Portrait AF**.

# Recording a Movie

In the movie shooting mode, you can shoot videos in High Definition quality (1280x720). You can continue recording movies up to 25 minutes. The recorded video is saved as an H.264 (MPEG-4.AVC) file.

- 1 Rotate the Mode dial to .
- 2 Press **[MENU]**.
- 3 Select **Shooting1** () → **Quality**.
- 4 Set options.
- 5 Select **Shooting3** () → **Voice**.
- 6 Select whether to record sound.
- 7 Press **[Shutter]** to start recording.



- 8 Press **[Shutter]** again to stop recording.





- Movie frame speed is fixed at 30 fps (30 frames/sec).
- While shooting a movie, push the **[Depth Preview]** button once to activate the AF function and once again to cancel the function. This function may not work depending on the lens you are using.

## Setting the aperture value

You can set the aperture value when shooting a movie.





- 1 In Shooting mode, press **[MENU]**.
- 2 Select **Shooting1** () → **Movie AE Mode** → an option.

 <b>Program</b>	The aperture value is adjusted automatically.
 <b>Aperture Priority</b>	Set the aperture value by using the dial before taking the movie.

## To fade out the screen

You can make the movie screen darker or brighter gradually in recording by using the fader function.

- 1 In Shooting mode, press **[MENU]**.
- 2 Select **Shooting3** () → **Fader**.

 <b>Off</b>	Fader function not used
 <b>In</b>	Scene gradually fades in when recording starts.
 <b>Out</b>	Scene gradually fades out when recording ends
 <b>In-Out</b>	The fader function is applied at the start and end of the scene.





- When you use the Fader function, it may take longer to save images.

## Using the Wind Cut

Use the wind noise removal function to remove some surrounding noise in addition to the wind noise.

- 1 In the Shooting mode, press **[MENU]**.
- 2 Select **Shooting3** → **Wind Cut** → an option.

### Pause while recording a movie

By using the pause function, you can shoot only desired scenes into one file without generating several movie files.

To pause during the recording, press **[OK]**

- To continue on recording, press **[OK]**



- H.264 (MPEG-4 part10/AVC) is the latest video coding format established in 2003 collaboratively by ISO-IEC and ITU-T. Since this format uses a high compression rate, more data can be saved in less memory space.
- If you use a slow writing memory card, your movie's recording can be interrupted because the card can not process data at the rate the video is being shot. If this occurs, replace the card with a faster memory card or reduce the image size.
- If you have the image stabilizer option on when shooting a movie, the camera may record the image stabilizer sound.
- When the size of a movie file exceeds 4GB, the camera automatically stops recording. If this occurs, continue the movie by starting a new movie file.
- When formatting a memory card, always format using this camera. If you format on another camera or a PC, you can cause a change in the capacity of the card or make it incompatible with your camera.
- If you remove the camera lens while recording a movie, the recording will be interrupted. Do not change the lens while recording.
- While you shoot a movie, the camera can record the sounds of the zoom mechanism working and the sounds the camera makes when you press the buttons.
- If you change the shooting angle of the camera suddenly while shooting a movie, the camera may not be able to record images accurately. We recommend using a tripod when shooting a movie. In this way, you can minimize camera shake.
- In the Movie Shooting mode, the camera supports only the **Multi AF** function. You can not use any other focus area setting functions, such as **Face Detection AF**.

# Extended shooting functions

Learn about the options you can set in shooting mode.

By using the shooting options, you can enjoy more customized pictures and movies.

Setting the resolution and quality .....	51
Using the timer function .....	54
Taking a picture in the dark place .....	55
Focusing methods .....	60
Face detection .....	64
Brightness and color adjustment of picture .....	66
Changing the shooting method .....	73
Special effect/photo retouching .....	75
Key Mapping .....	77

# Setting the resolution and quality



You can also set the Resolution function by pressing [Fn] in the shooting mode.



## Setting a resolution

To capture the high level of detail and excellent image quality in your picture or video, it is a good idea to set the resolution to the highest setting. The main drawback is that the file size becomes relatively big.

### Setting picture resolution

- 1 In Shooting mode, press [MENU].
- 2 Select **Shooting 1** (📷) → **Photo Size** → an option.

	Picture size (display ratio)	Proper use
14M	<b>4592 x 3056</b> (3:2)	For printing photos on A1 size prints
10M	<b>3872 x 2592</b> (3:2)	For printing photos on A2 size prints
6M	<b>3008 x 2000</b> (3:2)	For printing photos on A3 size prints
2M	<b>1920 x 1280</b> (3:2)	For printing photos on A5 size prints
	<b>4592 x 2584</b> (16:9)	When outputting to HDTV (16:9) or printing A1 size prints.
	<b>3872 x 2176</b> (16:9)	When outputting to HDTV (16:9) or printing A3 size prints.

	<b>3008 x 1688</b> (16:9)	When outputting to HDTV (16:9) or printing A4 size prints
	<b>1920 x 1080</b> (16:9)	When outputting to HDTV (16:9) or printing A5 size prints.

### Setting video resolution

- 1 Press [MENU] in the Video Shooting mode.
- 2 Select **Shooting 1** (📹) → **Movie Size** → an option.

	<b>1280</b> (16:9)	When outputting to HDTV
640	<b>640</b> (4:3)	When outputting to normal TV
320	<b>320</b> (4:3)	When uploading and using on the web

You can also set the Quality function by pressing **[Fn]** in the shooting mode.

## Setting the image quality of a picture

P A S M SCENE

The camera saves pictures in either in the JPEG or RAW format.

The compression ratio is reduced as the image quality gets better. It is necessary to increase the file size to have a better quality picture.

- 1 In Shooting mode, press **[MENU]**.
- 2 Select **Shooting 1** () → **Quality** → an option.

<b>Super Fine</b>	Set to super fine quality
<b>Fine</b>	Set to fine quality
<b>Normal</b>	Set to normal quality
<b>RAW</b>	Save in the RAW file format
<b>S.Fine+RAW</b>	Save super-fine image and RAW file at the same time
<b>Fine+RAW</b>	Save fine image and RAW file at the same time
<b>Normal+RAW</b>	Save normal image and RAW file at the same time



- The camera saves RAW file format images without data loss and only in the 14M (4592 x 3056) photo size. Although settings for white balance, contrast, saturation, and sharpness, etc. are not reflected in the image, they are saved as information. If you want to save the RAW data into an image file format such as JPEG or TIFF, use the provided software (SAMSUNG RAW Converter). RAW files have an "SRW" extension. (For example: "SAM\_9999.SRW")

## Setting the quality of a movie

The camera saves movies in normal or high quality.

- 1 In the Shooting mode, press **[MENU]**.
- 2 Select **Shooting 1** () → **Quality** → an option.

<b>Normal</b>	Set normal quality
<b>HQ</b>	Set high quality

## Noise reduction P A S M

This function can be set to reduce the noise in pictures.

- 1 In the Shooting mode, press **[MENU]**.
- 2 Select **User setup (👤)** → **Noise Reduction** → an option.

<b>High ISO NR</b>	This function reduces noise that may occur when you set a high-speed ISO (3200).
<b>Long Term NR</b>	This function reduces noise when you set the camera for a long exposure (over 1 seconds). It requires additional processing time equal to the shutter speed you used to take the picture.



When the **Noise reduction** function is disabled, there might be a noise in the recorded picture.



# Using the timer function

The function can be set directly by pressing [ ] in the shooting mode.

## Setting the timer function

SMART P A S M SCENE

- 1 In the Shooting mode, press [MENU].
- 2 Select **Shooting 2** (📷<sub>2</sub>) → **Drive**.
- 3 Press [Fn] after selecting Timer.
- 4 Select the operation time by rotating the dial or pressing [◀ / ▶].
  - You can select the timer setting pressing of 2 ~ 30 seconds.

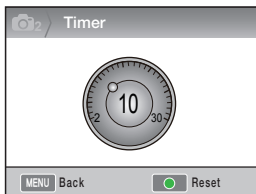

- 5 The shot is taken automatically after the time being set has passed by pressing [Shutter].



To cancel the self timer function, press [ ] one more time, or press [Shutter].



# Taking a picture in a dark place

The function can be set directly by pressing **[Fn]** in the shooting mode.

## Using the flash popup button P A S M

The flash operates when you pop-up the built-in flash by pressing the flash button. When the flash is closed, it will not burst out the light and the **SMART-SCENE**, **☺**, and **☺** modes support automatic popup and flash light.

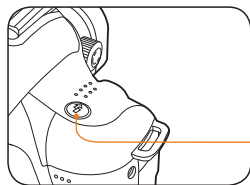

Flash button

- 1 In the Shooting mode, press **[Fn]**.
- 2 Align your subject in the frame and half-press **[Shutter]** to focus.
- 3 Press **[Shutter]** to take a photo.
  - Even if you have opened the flash using the 'Flash' button, the flash will not work if you have the Flash Option in the menu set to **Off**.

## Setting the flash option

**SMART P A S M ☺ ☺ SCENE**

If a picture is taken in a dark place, the picture may appear to be dark since the light source is not sufficient. Press **[Fn]** to pop up the flash.

- 1 In the Shooting mode, press **[MENU]**.
- 2 Select **Shooting 2 (☺2)** → **Flash** → an option.

	<b>Off</b>	The flash light doesn't operate.
	<b>Smart Flash</b>	The camera automatically adjusts the brightness of the flash according to the amount of light in the surrounding environment.
	<b>Auto</b>	The flash light operates automatically in the dark place.
	<b>Auto+Red</b>	The flash light operates automatically and prevents the red-eye effect.
	<b>Fill in</b>	<ul style="list-style-type: none"><li>• The flash operates whenever you take a picture.</li><li>• The brightness of the flash is automatically controlled.</li></ul>
	<b>Fill-in Red</b>	The flash operates whenever you take a picture and prevents the red-eye effect.
	<b>1st Curtain</b>	The flash operates immediately after the shutter opens.
	<b>2nd Curtain</b>	The flash operates just before the shutter closes.



- You can take a better picture if the subject is located within the operational range of the flash. (Refer to the Guide Number in "Specification.")
- You can set the auto flash option for external flashes on the NX-series models only.
- The flash options available differ, depending on the shooting modes.

## Using the red-eye fix function

P A S M  

When you take a portrait using the flash, the bright burst of light can cause the red-eye effect. To prevent the red eye effect, set the flash option to **Auto+Red** or **Fill-in Red**.



- When you set the red-eye fix function, the camera prevents red-eye by emitting a preliminary flash prior to the brighter flash it emits when capturing the image.
- When the subject is moving or is far away from the camera at the time of the preliminary flash, the function may not function well.

## 1st Curtain, 2nd Curtain P A S M

The following images were obtained by taking the pictures of straight-moving subject along with the respective options of **1st Curtain** and **2nd Curtain**. In case of using the **1st Curtain** flash function, the front part of action is remained clearly since the flash will burst light immediately upon shutter opening. Since the flash bursts the light at a later time when having used the **2nd Curtain** option, the picture expresses the last image of the subject clearly.

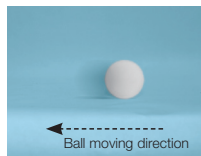

▲ Use of early 1st Curtain option

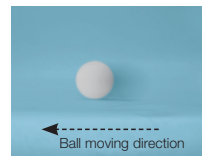

▲ Use of 2nd Curtain option



## Adjusting the amount of flash light

P A S M SCENE

When setting a flash option, you can adjust the brightness of the flash.

- 1 In the Shooting mode, press **[MENU]**.
- 2 Select **Shooting 2** () → **Flash**.
- 3 Press the **[Fn]** button after selecting a desired item.
- 4 Adjust the brightness of the flash by rotating the dial or pressing **[◀ / ▶]**.
  - You can adjust flash brightness by  $\pm 2$  levels.

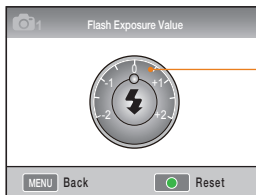

Display the level of flash light adjustment



- If the subject is too close, the ISO sensitivity is high, or the exposure value is too large or small, the adjustment effect will be reduced.
- The Flash Brightness Adjustment function is not available in some shooting modes.
- If an external flash unit has a flash control function, the light control value of the external flash is applied when you connect it to the camera.
- If the distance from the subject is quite close when taking images by using the built-in flash, part of the images may appear dark as the lens is interfered with the flash light. Please check the distance between camera and subject when taking pictures. The distance interfered with flash light may vary by the type of lens in use.
- If you've installed a lens hood, the hood can block light from the built-in flash. Please remove the lens hood when using the built-in flash.

## Using an external flash unit (purchased separately)

You can use the A-TTL auto flash mode when you attach an external flash unit (SEF20A or SEF42A) to the camera.

This section of the user manual was prepared based on the model SEF20A flash.

For more details about the external flash units, see the flash units user's manual.

### Installing the flash

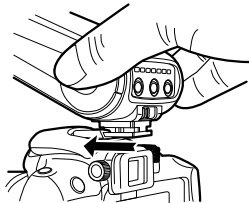

- 1 Install the external flash after removing the hot shoe cover.
- 2 Turn on the external flash.
  - The burst mode of external flash is set to the TTL auto mode.
- 3 Make sure the external flash is fully charged, and then start shooting.

### The available flash modes

The flash modes available are determined by the camera lens or camera exposure mode you are using.

#### 1 Smart Flash Mode

- The camera automatically adjusts the brightness of the flash according to amount of light in the surrounding environment.

#### 2 Auto

- The flash operates automatically in dim or dark light.

#### 3 Auto + Red

- The flash operates automatically in dim or dark light and prevents the red-eye effect.

#### 4 Fill in

- The flash operates whenever you take a picture and its brightness is controlled automatically.

#### 5 Fill-in Red

- Always operates the flash light, and prevents the red-eye effect.

#### 6 1st Curtain

- The flash operates immediately after the shutter opens.

#### 7 2nd Curtain

- The flash operates just before the shutter closes.



- Only a flash device manufactured for the NX series automatically adjusts the brightness of the flash. To enjoy the auto mode functions, please use the flash manufactured for NX models. Although the flash fires without the battery being fully charged, we recommend using the flash only after you charge the battery fully.
- If an external flash unit has a flash control function, the light control value of the external flash is applied when you connect it to the camera.

## Adjusting the ISO sensitivity P A S M

The ISO sensitivity, as the film sensitivity established by the international standards organization (ISO), represents the degree of reaction when camera receives light. Since it reacts more sensitively with greater ISO value, a natural shot can be obtained in a dark place by raising the ISO value. This reduces the degree of camera shaking with faster shutter speed.

- 1 In the Shooting mode, **[MENU]**.
- 2 Select **Shooting 1** (📷1) → **ISO** → an option.



- The higher the ISO speed you select, the more visual noise you may get.
- When the noise reduction function is used, the noise caused by the high-sensitive ISO(3200) can be reduced.
- The available ISO setting options may differ depending on the Shooting mode.
- You can set the ISO directly by pressing **[ISO]** in the Shooting mode.







# Focusing methods

## Changing the Focusing methods

P A S M SCENE 

You can select a focusing method appropriate to the subject you are photographing.

- 1 In the Shooting mode, press **[MENU]**.
- 2 Select **Shooting 2** () → **AF Mode** → an option.

 <b>Single AF</b>	When you press <b>[Shutter]</b> half way down, the focus fixes in one position.
 <b>Continuous AF</b>	When you hold the <b>[Shutter]</b> half-way down, the focus adjusts continually as the subject changes position.
 <b>Manual Focus</b>	Adjust the focus manually by turning the focus ring.



- If your lens has an **[AF/MF]** switch, you can set the lens to MF and adjust the focus manually.
- If there is no AF/MF switch on the lens, you can switch to manual focus by selecting **Manual Focus** in the AF mode menu.
- The selectable option may differ according to the lens in use.
- When adjusting the focus manually, the picture may appear blurred if you don't set the focus accurately. Please take a picture after setting the focus accurately. (p. 32).
- You can also set the AF/MF function directly by pressing **[AF•MF]** on top of the directional button while in Shooting mode.

## AF Priority P A S M

When you use the AF focusing function, the AF Priority function prevents the shutter from firing if the focus is not appropriately set.

- 1 In the Shooting mode, press **[MENU]**.
- 2 Select **Shooting 2** () → **AF Priority** → an option.

<b>Off</b>	Camera takes a shot regardless of the focus.
<b>On</b>	The camera takes a shot only if the focus is set correctly when you press the shutter button. Even if the focus is set correctly when you press the shutter half way, the camera will not take the shot if the focus is not set correctly when you press the shutter button fully.



- Even with **AF Priority** on, the Continuous and the Burst Shot options let the shutter fire whether the focus is set correctly or not.

## Using the AF assist light

 P A S M   SCENE

The auto focus functions more accurately in dark places when the AF assist light is on.

- 1 In the Shooting mode, press **[MENU]**.
- 2 Select **User setup** (  ) → **AF Lamp**.





Off	AF assist light not used
On	AF assist light turns on when light is not sufficient.

## Changing the focus area

P A S M   SCENE

The AF Area function changes the positions of the focus area or areas and can give you clearer, sharper pictures.

- 1 In the Shooting mode, press **[MENU]**.
- 2 Select **Shooting 2** (  ) → **AF Area** → an option.

	<b>Selection AF</b>	Sets the focus appropriately for an area you have selected.
	<b>Multi AF</b>	Displays a green rectangle in all the Face places where focus is set correctly.
	<b>Face Detection AF</b>	Shows the areas that the focus is correctly set in the display.
	<b>Self-Portrait AF</b>	When the sound effect is heard at the time of self-shot, you can check the position of the subject's face.



- The available options may differ by Shooting mode.
- When you set the **AF/MF** switch on the lens to **MF**, you can not change the AF area using the Shooting menu.
- When you select the **Multi AF** function, the AF areas that are in focus appear in green.
- You can select this function directly by pressing **[Fn]** in the Shooting mode.

## Setting the focus of the selected area

P A S M SCENE

In the shooting composition, a shot may be taken by setting the focus to the area desired by user.

- 1 In the Shooting mode, press **[MENU]**.
- 2 Select **Shooting 2** () → **AF Area** → **Selection AF**.

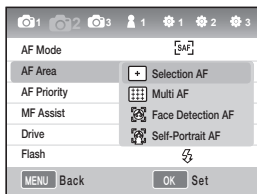

- 3 Press **[MENU]** to return to the previous mode.

- 4 In the Shooting mode, press **[OK]**.

- 5 Press **[▲/▼/◀/▶]** to move the focus area.

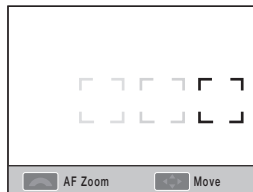

- 6 Adjust the size of focus area by using the dial.

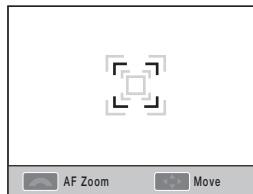

- 7 Align your subject in the frame and half-press **[Shutter]** to focus.

- 8 Press **[Shutter]** to take a photo.

## Setting the MF Assist

SMART P A S M SCENE

When the lens' focus method is set to Manual Focus (MF), this function helps focus the subject by expanding the screen automatically.

- 1 Set the focus method to Manual Focus.
- 2 Select **Shooting 2** () → **MF Assist**
- 3 Select a desired option.

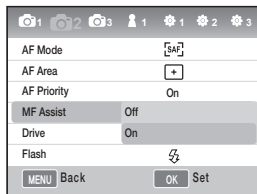

Off	Do not enlarge the subject on screen when it is in Manual focus mode.
On	Enlarge the subject on screen when you adjust the focus in Manual focus mode



# Face detection

When you use the **Face Detection AF** function, you can set the focus around a person's face when taking a portrait shot. This function can also be useful when shooting a self-portrait.

## Normal face detection P A S M Q SCENE

When you use the **Face Detection AF** option, the camera sets the auto focus based on the faces in the frame.

When the shooting composition is set, the camera automatically detects as many as 10 faces and sets the focus and exposure.

1 In the Shooting mode, press **[MENU]**.

2 Select **Shooting 2** (📷) → **AF Area** → **Face Detection AF**.

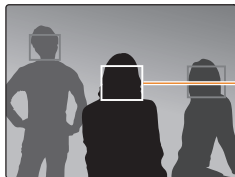

The focus frame is shown by white for the closest face and by gray for the rest of faces.



- Face detection may not be effective when.
  - The subject is too far away
  - The light is too bright or dark
  - The subject is not facing the camera
  - When part of the face is hidden by an object like sunglasses.
  - Part of the subject's face is hidden by sunglasses or similar objects
  - The subject makes a large facial expression
  - The light or backlight on the subject's face is not uniform
- Depending on the Picture Wizard option, the camera may not recognize the subject's face
- The options available may differ depending on the shooting mode.
- This function is not available if you have selected such options as Manual Focus and Selection AF.
- The face detection function works faster when the camera is closer to the subject.
- When you use the **Face Detection AF** option, the white focus area is automatically set to focus.



## Self-portrait face detection

### P A S M Q SCENE

With Self-Portrait AF on, the camera chirps rapidly when your face is in focus.

- 1 In the Shooting mode, press **[MENU]**.
- 2 Select **Shooting 2** (📷<sub>2</sub>) → **AF Area** → **Self-Portrait AF**.
- 3 Press **[Shutter]** if having an info sound of shooting.

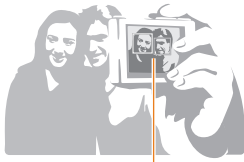

Check the focus of the subject in Shooting mode



# Brightness and color adjustment of picture

## Adjusting the exposure (brightness)

P A S SCENE

The images can be taken bright or dark according to the amount of light. In this case, appropriate adjustment can be made by controlling the amount of light entered into the lens.



▲ Applying -      ▲ 0      ▲ Applying +

- 1 Check the accurate focus of subject in the shooting mode
- 2 To adjust the exposure value, hold down the **[]** button, and then rotate the dial.
  - The adjustment value of exposure can be checked from the viewfinder and display.
- 3 Press the **[Shutter]** button to take a picture.



- When fixing and using the exposure value being set, it may be excessively bright or dark according to the shooting environment. Please take a picture by adjusting the exposure value appropriate for the shooting environment.
- When it is difficult to judge an appropriate value of exposure, please set the detailed setting of **AE BKT (successive shots of exposure increase/decrease)**. This takes 3 pictures successively, including one step darker one and one step brighter one (p. 73).
- The camera displays the exposure warning in red for each step beyond the  $\pm 3$  range.

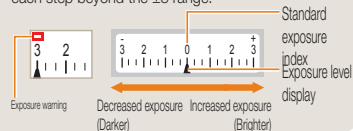

## Exposure adjustment

P A S M SCENE

You can set the size of the exposure adjustment.



- 1 In the Shooting mode, press **[MENU]**.
- 2 Select **User setup (1)** → **EV Step** → an option.



1/3	Change the exposure level by 1/3 step.
1/2	Change the exposure level by 1/2 step.

## Changing the brightness measurement method P A S M

If the composition of image is set, the camera measures the amount of light.

At this time, the brightness and overall mood of the picture may vary depending on how the measurement is made.

- 1 In the Shooting mode, press **[MENU]**.
- 2 Select **Shooting 3** (/ ) → **Metering** → an option.

 <b>Spot</b>	<ul style="list-style-type: none"><li>• Calculate the amount of light in the center.</li><li>• This is suitable when taking a portrait shot where there is a strong backlight.</li><li>• When the subject is not located in the center of the display, the subject can appear to be too bright or too dark.</li></ul>
 <b>Center-weighted</b>	<ul style="list-style-type: none"><li>• This calculates the amount of light in the center portion of the shot and averages the result over the entire image.</li><li>• This is suitable when the area of the subject is large when compared to the overall composition of the picture.</li></ul>
 <b>Multi</b>	<ul style="list-style-type: none"><li>• Calculate the amount of light in multiple areas.</li><li>• Suitable for normal pictures.</li></ul>



The function can be set directly by pressing  in the shooting mode.



## Setting the white balance P A S M

Different light sources will affect the resulting color of your picture. To take a picture with colors close to what is seen with our own eyes, please select the white balance appropriate for the light source or manually adjust the color temperature desired.

In case of a light source that is difficult to take in to effect, the shot can be taken by adjusting the white balance manually according to the picture-taking situation.



 Auto





 Daylight











 Cloudy



 Incandescent bulb

- 1 In the Shooting mode, press **[MENU]**.
- 2 Select **Shooting 1** () () → **White Balance** → an option.

 <b>Auto WB</b>	The camera automatically selects the optimal white balance settings.
 <b>Daylight</b>	For shooting outdoors on a clear day.
 <b>Cloudy</b>	For shooting outdoors on a cloudy day.
 <b>Fluorescent White</b>	Daylight, fluorescent lamp, suitable especially for the white fluorescent light with the color temperature of about 4200K
 <b>Fluorescent NW</b>	Daylight, fluorescent lamp, suitable especially for the daylight fluorescent lighting with the color temperature of about 5,000K
 <b>Fluorescent Daylight</b>	Daylight, fluorescent lamp, suitable especially for the daylight-like fluorescent lighting with the color temperature of about 6,500K
 <b>Tungsten</b>	For shooting under halogen lamps and standard, incandescent bulbs.
 <b>Flash WB</b>	Suitable when using the built-in flash light.
 <b>Custom Set</b>	To create a custom white balance setting.
<b>K</b> <b>Color Temp.</b>	To set the color temperature manually.



The function can be set directly by pressing **[WB]** in the shooting mode.

### Fine adjustment of the white balance

- 1 In the Shooting mode, press **[MENU]**.
- 2 Select **Shooting 1** (📷/📷) → **White Balance**.
- 3 Select a White Balance option, and then press **[Fn]**.

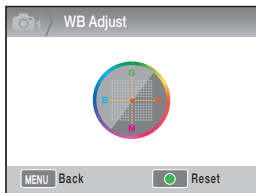

- G: Green
- A: Amber
- M: Magenta
- B: Blue

- 4 Adjust a desired white balance by using the dial or **[▲/▼/◀/▶]**.
- 5 Press **[OK]** to save.

### User setup method

If the shot is taken after setting the composition of white paper, filled in full frame, an appropriate white balance value is set according to the measured light source.

- 1 In the Shooting mode, press **[MENU]**.
- 2 Select **Shooting 1** (📷/📷) → **White Balance**.
- 3 Select **Custom Set**, and then press **[Fn]**.
- 4 After setting the composition to show only the white paper, press **[Shutter]**.

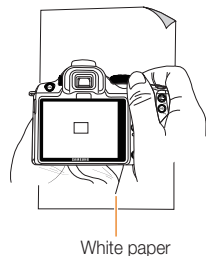

### Adjusting the color temperature

You can change the white balance by adjusting the color temperature.

- 1 In the Shooting mode, press **[MENU]**.
- 2 Select **Shooting 1** (📷<sub>1</sub>/📷<sub>1</sub>) → **White Balance**.
- 3 Select the **Color Temp.** option, and then press **[Fn]**.
- 4 Set desired color temperature by rotating the dial or pressing **[◀▶]**.

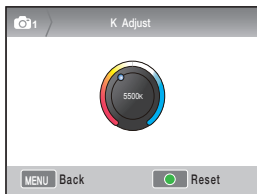

- 5 Press **[OK]** to save.

### What is color temperature?

Color temperature refers to the temperature that has expressed the color change of light in the absolute temperature (K). This can express cold sense with the rising color temperature and warm sense with the falling color temperature.

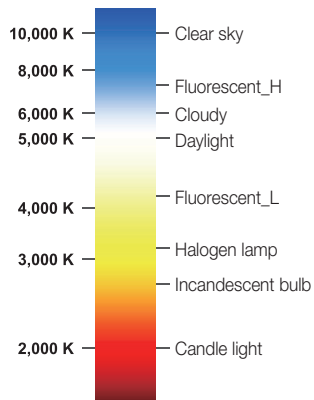

## Color space

You can set the color space the camera uses.

- 1 Press **[MENU]** in the shooting mode.
- 2 Select **Shooting 1** () → **Color Space** → an option.

<b>sRGB</b>	Set the color space to sRGB.
<b>Adobe RGB</b>	Set the color space to Adobe RGB.



- When you set the color space to Adobe RGB, the camera saves picture files in the ".SAMXXX.JPG" format.
- You can set the Color Space function directly by pressing **[Fn]** in the Shooting mode.

## What is color space?

The image In/Output devices such as digital camera, monitor and printer hold different ranges of reproducing each color.

The possible range of color reproduction is referred to as color space. Several standards of color space are fixed for each device. This camera support sRGB and Adobe RGB. sRGB is diversely used in the devices like computer. It is recommended to use sRGB for regular images. sRGB standards for International standard of color space established by the IEC (International Electrotechnical Commission).

This is defined from color space for PC monitors and is also used as the standard color space for Exif.

Adobe RGB is the color space recommended by Adobe Systems, Inc. for commercial printing and has wider range of color reproduction than sRGB. Adobe RGB covers most of the color range so colors only available when printed are not lost when editing images from a computer. When image is opened by non-compatible software, the colors look lighter.

## Smart range PASM

Smart Range automatically corrects for the loss of bright detail that can occur due to shading differences in the picture.



▲ Canceling smart range    ▲ Use of smart range

- 1 In the Shooting mode, press **[MENU]**.
- 2 Select **Shooting 3** (📷) → **Smart Range** → an option.



- When you turn on Smart Range, you cannot select the ISO 100 option.
- The Smart range function is not available in some shooting modes, and it may automatically operate while you use the **☑** and **📷** shooting options.
- You can set the Smart Range function directly by pressing **[Fn]** in the Shooting mode.





# Changing the shooting method

It can be difficult to take a picture of a fast moving object, a quick facial expression, or the rapid motion of a person. In this case, please select the successive shooting option appropriate for the situation.

## Successive shooting method and timer setup



You can select the successive shooting option appropriate for the situation.

- 1 In the Shooting mode, press **[MENU]**.
- 2 Select **Shooting 2** (📷) → **Drive** → an option.

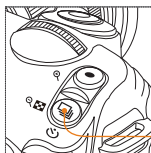

Drive mode button

You can set this option directly by pressing the **[□]** in the Shooting mode.

	<b>Single</b>	Take one photo shot whenever you press the shutter.
	<b>Continuous</b>	Take shots successively while pressing and holding down the shutter, possible to take 3 shots per second
	<b>Burst</b>	Press the shutter button and the camera takes up to 30 shots in a row.
	<b>Timer</b>	Press the shutter button and the camera takes a picture within 2 to 30 seconds. (in increments of 1 second).
	<b>AE BKT</b>	When you press the shutter, the camera takes 3 consecutive shots: the original, one a step darker, and one a step lighter.
	<b>WB BKT</b>	When the shutter is pressed the camera will take 3 consecutive shots, the original and 2 more with different white balance settings.
	<b>P Wiz BKT</b>	When the shutter is pressed, the camera will take 3 consecutive shots; all three will have different picture wizard settings.



- The options may differ depending on the Shooting mode.
- The **WB BKT** and **P Wiz BKT** functions correct the image after you take the shot.
- If you set the photo quality to the RAW format, you can not use the bracketing options (WB BKT, P Wiz BKT).
- When you select the **Burst** shooting option, you can not select the image size, and the image quality is fixed at 1472x976. Also, when you are shooting using the **Burst** option, the camera can take longer to save the images.
- With the **Burst** shooting option, the camera can not save images in the RAW file format. Also, you can not set the ISO to 100.
- Both the built-in and external flash do not fire when you use the **Burst** shooting option.
- The shutter speed can be set to 1/30 Sec or faster when the **Burst** shooting option is in use.
- This product supports **Burst Shooting** mode which takes up to 30 shots per second. The images taken in **Burst Shooting** can be saved with a little bit enlarged size.

## Detailed bracket setup P A S M

The details for the exposure, white balance and picture wizard of bracket shot can be set.

- 1 Press **[MENU]** in the shooting mode.
- 2 Select **Shooting 3** (📷3) → **BKT Set** → an option.

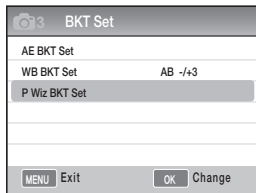

- 3 Select the detailed options.

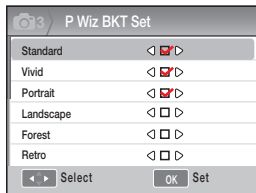

<b>AE BKT Set</b>	When using the exposure BKT function, this allows setting the image shot sequence and exposure interval. <b>BKT Order:</b> Set the shooting orders <b>BKT Area:</b> Set the exposure steps
<b>WB BKT Set</b>	When using the WB BKT function, this allows setting the adjusted interval of white balance value. Example) <b>MG-/+3</b> adjusts the Magenta value of 3 steps minus or plus.
<b>P Wiz BKT Set</b>	When using the picture wizard BKT function, this allows setting the shot order.

# Special effect/photo retouching

## Picture wizard PASM

The Picture Wizard function lets you select various looks and emotional moods for your pictures.

### ▼ Example



Standard



Vivid



Portrait



Landscape



Forest



Retro



Cool



Calm



Classic

- 1 In the Shooting mode, press [MENU].
- 2 Select **Shooting 1** (📷1) → **Picture Wizard** → an option.

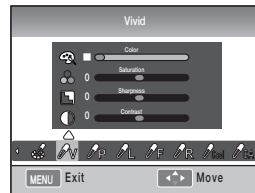

- 3 Adjust the detailed items of picture wizard that were selected by using [▲/▼/◀/▶].
  - You can control the color, saturation, sharpness, and contrast.
- 4 Set to a desired value.



- The option can be set directly by pressing the [P] button of camera in the shooting mode.

### Custom picture wizard setup

You can choose the customize options and then save images in 3 different ways.

- 1 In the Shooting mode, press **[MENU]**.
- 2 Select **Shooting 1** (📷<sub>1</sub>) → **Picture Wizard** → **Custom** → an option.

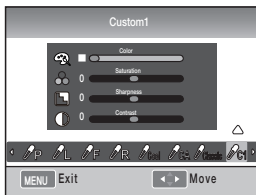

- 3 Adjust the Picture Wizard value by using **[▲/▼/◀/▶]**
  - You can control the color, saturation, sharpness, and contrast.
- 4 Set to a desired value.



# Key Mapping

## Setting Key Mapping P A S M

The function of camera button can be changed.

- 1 In the Shooting mode, press **[MENU]**.
- 2 Select **User setup (1)** → **Key Mapping** → an option.



AEL

You can choose among three settings for the **[AEL]** button:

- AEL, which executes the auto exposure lock function.
- AFL, which executes the auto focus lock function.
- AEL + AFL, which executes the auto exposure and focus lock functions together.



Preview

You can choose between two settings for the Depth Preview button:

- One-Touch WB which executes the Custom White Balance function.
- Optical Preview which executes the Depth of Field Preview function for the current aperture value.



- While shooting a movie, push the **[Depth Preview]** button once to activate the AF function and once again to cancel the function.
- Refer to the "Depth Preview" function. (p. 37)
- The function of **AEL** button cannot be changed in the **M**(manual) mode.

### What is AEL function?

The auto exposure lock (AEL) and auto focus lock (AFL) functions of the camera are the functions that maintain the settings until the shooting is completed by remembering the exposure value and focus when pushing the **[AEL]** button of camera.

**Reaction of the half-shutter release when the AEL button is set to the following status.**

Status of AEL setting	Reaction of the half-shutter release
AEL	Auto focus
AFL	Exposure lock
AEL+AFL	None

# Playback/Editing

Learn how to play back and edit photos/videos. Also, learn how to connect your camera to your computer, photo printer, TV, or HDTV.

Play (picture/movie) .....	79
Picture editing .....	87
Viewing files on a TV or HDTV.....	91
Transferring files to your computer .....	93
Using the Samsung RAW Converter .....	98
Printing photos with a photo printer (PictBridge) .....	101

# Play (picture/movie)

## Viewing pictures in the play mode

You can view saved pictures and movies.

- 1 Press [▶].
  - Shows most recently saved file.
- 2 View the pictures sequentially using [◀/▶].
  - When the playback screen is selected more than once, the last shown picture or movie is selected to be shown during playback.

79

### Photo playback information screens

The display information appears by pressing [DISP] in the play mode.

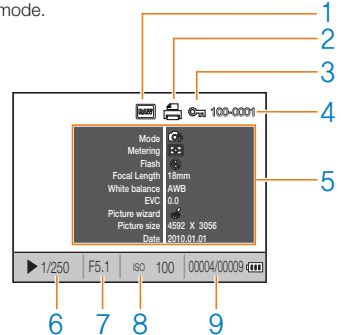

1	RAW file indicator
2	File that includes development info
3	Protected file indicator
4	File no.
5	Meta value of picture
6	Shutter speed info
7	Aperture value
8	ISO setup value info
9	File playing/total no. of files stored/battery information

80

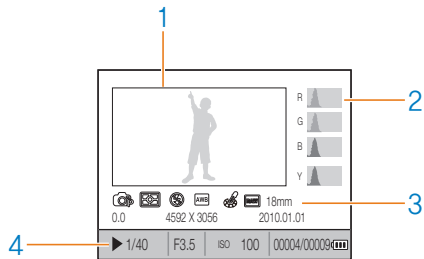

1	Shot image
2	RGB histogram
3	Shooting mode, metering, flash, white balance, picture wizard, focal length
4	Shutter speed, aperture value, ISO, selected file/total number of files/ battery information

Movie playback information screen

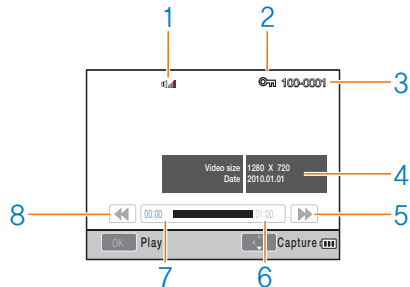

1	Volume control display
2	Protected file
3	File no.
4	Meta value of movie
5	Fast forward
6	Total play time of selected file
7	Current play time
8	Rewind



## View files in the smart album by category

The files can be classified and shown by the file, date (day), date (week), and type.

- 1 In Playback mode, press [].
- 2 Press [MENU].
- 3 Select a desired playback method.

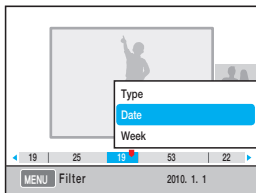

Type	Classify by the saved file form
Date	Classify by date recorded.
Week	Classify by week recorded.

- 4 You can view items by turning the dial or pressing [/▶].
- 5 Press [] to return to the previous function.



When you start Smart Album or change the filter method, the time it takes for the camera to classify and display files depends on the number of files saved. Please wait a until Smart Album appears.

## Converting to the thumbnail view

Since several files can be shown on one display, files can be searched quickly.

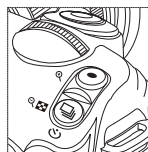

To have a thumbnail view of 9 images, press [] two times, or press [] three times to have a thumbnail view of 20 images.

(Press [] to cancel)

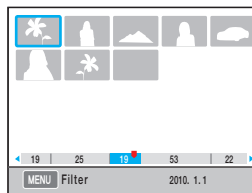

## File protection

You can protect files from accidental deletion.

- 1 Press **[AEL]** in the play mode.
- 2  appears on the display.
- 3 Press **[AEL]** to cancel.

## Deleting a file

Files can be selected and deleted in the play mode.





The function can be set by pressing **[MENU]** in the playback mode.

### Deleting one picture

You can delete only one picture by selecting a desired file.

- 1 After selecting the file to be deleted in the play mode, press .
- 2 From the popup window, select **Yes**.

### Deleting selected file

- 1 After selecting the file to be deleted in the play mode, press .
- 2 From the popup window, select **Multiple Delete**.
- 3 After selecting a file to be deleted, press 
  - To cancel your selection, press  again.
- 4 Press .
- 5 From the popup window, select **Yes**.

#### Deleting all files

All the files saved in the memory card can be deleted at once.

- 1 In Playback mode, press **[MENU]**.
- 2 Select **Playback**  → **Delete** → **All**.
- 3 From the popup window, select **Yes**.

#### Auto rotate

Show the pictures taken in the vertical frame by rotating them automatically while in playing.

- 1 In Playback mode, press **[MENU]**.
- 2 Select **Playback**  → **Auto Rotate** → **On**.



If the photo shot is taken when the direction of the camera was aimed at the bottom, the direction of the image can be different in the playback mode.

#### High Light

This informs the excessively bright part from the image taken.

- 1 In Playback mode, press **[MENU]**.
- 2 Select **Playback**  → **High Light** → **On**.

## Enlargement/reduction

A picture can be enlarged when searching in play mode.

### Enlargement

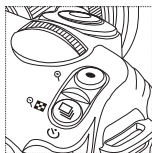

Press [**○**] to enlarge.  
(Press [**□**] to reduce)

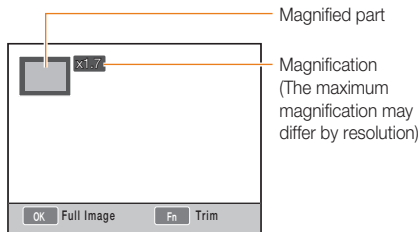

Move enlargement  
on screen

Press [**▲/▼/◀/▶**].

Trim the enlarged  
image

Press the [**Fn**] button to select a  
portion of the image to be cut.

### See the slide show

Pictures can be shown in a slide show by applying various effects and music.

- 1 In Playback mode, press [**MENU**] → [**▶**].
- 2 Select a desired option.
  - To play without selecting an option, go to **step 4**.

Images	Select the pictures you want in the slide show. <ul style="list-style-type: none"> <li>• <b>All</b> : Include all the saved pictures in the slide show.</li> <li>• <b>Date</b> : Include pictures taken on a specific date in the slide show.</li> <li>• <b>Select</b> : Select pictures and see them in the slide show</li> </ul>
Effect	<ul style="list-style-type: none"> <li>• Select the transition effects between pictures.</li> <li>• In order not to use the changing effect, select the <b>off</b> option.</li> </ul>
Interval	<ul style="list-style-type: none"> <li>• Select the scene changing time</li> </ul>
Music	Execute the background music

- 3 Set to a desired option.
- 4 Select **Slide Show** → **Play**.
  - To play the slide show repeatedly, please select the **repeat** option.
- 5 Watch the slide show.
  - To stop slide show, press [OK] and then press [◀/▶].

Pause/Play	Press the [OK] button.
------------	------------------------

## View a movie

While a movie is being played back, you are able to select and cut a desired part of the scene.

- 1 After selecting a desired movie in the play mode, press [OK].
- 2 Enjoy movie.

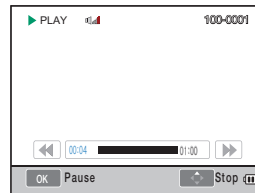

Rewind	Press [◀]
Pause/Play	Press [OK].
Fast rewind	Press [▶]
Volume control	Turn the dial to the left/right
Stop	Press [▲]

### Capturing a picture

You can capture a frame of the movie as a picture while playing back the movie.

- 1 Press [OK] in the play mode.
- 2 Press [OK] while playing a movie.
- 3 Press [▼] in the pause state.



- The resolution of the captured image is the same as the movie resolution.
- The captured file is saved as a separate file under a new file name.

### Cutting part of a movie

- 1 Press [OK] in the play mode.
- 2 Select the start point to cut by pressing [OK] → [G] while playing a movie.
- 3 Select the end point of cutting by pressing [OK] → [G].
- 4 From the popup window, press **Yes**.



- The cut file is saved by using a different file name.



# Picture editing

Pictures can be edited in various ways by using the edit menu. The function can be set directly by pressing **[Fn]** in the shooting mode.

## Changing the resolution

- 1 After selecting a desired picture in the play mode, press **[MENU]**.
- 2 Select **Image Edit** → **Resize**.

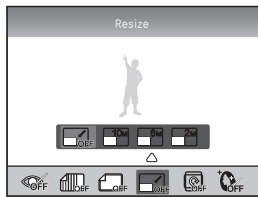

- 3 Select desired image resolution.
  - The edited file is saved by using the different file name.



- The resolution to be changed will be limited according to the resolution of original picture.

## Rotating

- 1 After selecting a desired picture in the play mode, press **[MENU]**.
- 2 Select **Image Edit** → **Rotate**.

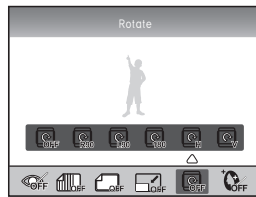

- 3 Select a desired rotation state



- Depending on the size of the picture, when you rotate the original, the new file may be smaller compared to the original.

## Red-eye fix

- 1 After selecting a desired picture in the play mode, press **[MENU]**.
- 2 Select **Playback** [▶] → **Image Edit** → **Red-eye Fix**.

## Adjusting the backlight

- 1 After selecting a desired picture in the play mode, press **[MENU]**.
- 2 Select **Playback** [▶] → **Image Edit** → **Backlight**.

## Picture style

Selecting picture style allows you to express various moods of emotion in your picture.

- 1 After selecting a desired picture in the play mode, press **[MENU]**.
- 2 Select **Playback** [▶] → **Image Edit** → **Photo Style Selector**.
- 3 Set to a desired option.

## Face retouching

- 1 After selecting a desired picture in the play mode, press **[MENU]**.
- 2 Select **Playback** [▶] → **Image Edit** → **Face Retouch**.
- 3 Set to a desired option.
  - The level of face retouch gets better as the value becomes larger.





## Setting the print info (DPOF)

The size and number of copies to be printed can be designated for the picture.

Since the designated information is saved in the MISC folder of memory card, it is convenient to print the designated size and number of copies while using the pictures of designated info simply by taking the memory card to a digital printing shop.



- The print info you enter can only be used for the digital printer or digital picture printing shop that supports the digital print order format (DPOF).
- For pictures with a wide resolution, the left and right portion of the image may not be printed. When placing a print order, identify the wide resolution pictures.
- The DPOF option is not available for RAW formatted images and the movie files.

1 Press **[MENU]** → **Playback** [**▶**] → **DPOF** → **Standard** in the playback mode.

2 Select a desired option.

Select	Printing selected pictures
All	Printing all
Reset	Initializing the standard print option

3 When having made the selections, press **[Fn]** after selecting the picture and number of copies to be printed by using the dial.

- When having selected all, press **[▲/▼]** to select the number of copies to be printed and then, press **[OK]**.

4 Select **[MENU]** → **DPOF** → **SIZE** in the playback mode.

5 Select an option.

Select	Select desired print size according to the picture.
All	Select the print size of all the pictures saved in the memory card.
Reset	Initializing the print size option

6 When having selected the **select** option, select the picture to be printed and press **[Fn]** after selecting the print size by using the dial.

- When having selected all, press **[▲/▼]** and select the print size. Then, select the print size and press **[OK]**.

### Index printing

1 Press **[MENU]** → Playback **[▶]** → **DPOF** → **Index** in the playback mode.

2 From the popup window, press **Yes**.



The designated print size can only be applied onto the DPOF1.1 compatible printer.

## Viewing files on a TV or HDTV

Play back photos or videos by connecting your camera to a TV using the provided A/V cable.

### Viewing files on a regular TV

- 1 Select a video signal output according to your country or region. (p. 107)
- 2 Connect the TV and the camera using the A/V cable.

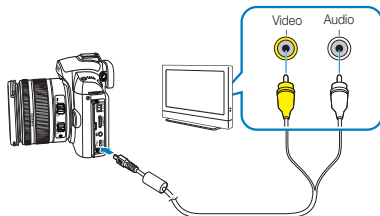

- 3 Make sure the TV and camera are turned on and select the video output mode of TV.
- 4 View the videos and pictures using the buttons of camera body.



- On some TVs, digital noise may occur or part of an image may not appear.
- Images may not appear centered on the TV screen depending on your TV settings.
- You cannot capture photos or videos while the camera is connected to a TV.

### Viewing files on an HDTV

- 1 Select a video signal output according to your country or region. (p. 107)
- 2 In Shooting or Playback mode, select **[MENU]** → **Setting 3** (⚙️<sub>3</sub>) → **HDMI Size** → an option.
- 3 Connect the HDTV and the camera using the HDMI cable.



If both A/V and HDMI cables are connected at the same time, the HDMI cable has the highest priority. We recommend you disconnect the A/V cable for better playback.

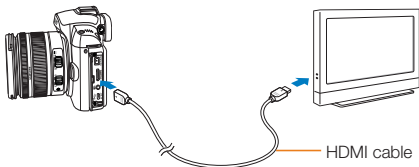

- 4 Make sure the HDTV and camera are turned on and select the HDMI mode of TV.
  - The HDTV screen shows the same display of the camera.

- 5 View the videos and pictures using the buttons of camera body.



- When using the HDMI cable, the user can connect the camera to an HDTV using the Anynet+(CEC) method. The Anynet+(CEC) functions allows you to control connected devices using the TV remote control.
- In the case that the HDTV supports Anynet+(CEC), the power of the TV is automatically turned on when used in conjunction with the camera.
- When connected to an HDTV by an HDMI cable, the camera can not take a pictures or movies.
- When connected to an HDTV, some playback functions may not be available.

# Transferring files to your computer

## For Windows users

Transfer files by connecting your camera to your PC.

### Installing programs

#### Hardware and software requirements

Item	Requirements
CPU	Pentium III 500 MHz or better (Pentium III 800 MHz or better recommended)
RAM	256 MB or more (512 MB or more recommended)
OS	Windows 2000/XP/Vista
Hard disk capacity	250 MB or more (1 GB or more recommended)
Others	<ul style="list-style-type: none"><li>• USB port</li><li>• CD-ROM drive</li><li>• 1024 x 768 pixels, 16-bit color display compatible monitor (24-bit color display recommended)</li><li>• Microsoft Direct X 9.0c or later</li></ul>



#### Requirements for QuickTime Player 7.6

- Intel Pentium 4, 3.2 GHz or higher/AMD Athlon™ 64FX, 2.6 GHz or higher
- Windows XP service pack2 or Vista
- Minimum 512 MB RAM (1 GB and above recommended)
- nVIDIA Geforce 7600GT or higher/ATI X1600 series or higher recommended



- Using a self-assembled PC or a PC and OS that are not supported may void your warranty.
- The programs may not work properly on 64-bit Edition of Windows XP and Vista.

#### Programs contained on the CD

Program	Purpose
Samsung Master	Edit photos and videos.
QuickTime Player 7.6	View videos (H.264 (MPEG-4.AVC) files) on a PC.
Samsung RAW Converter	Convert RAW files into the desired file format.
Adobe Reader	View the user manual.

- 1 Insert the installation CD in a compatible CD-ROM drive.
- 2 When the setup screen is displayed, click **Samsung Digital Camera Installer** to start installation.



- 3 Select programs to install, and follow the onscreen instructions.
- 4 Click **Exit** to complete the installation, and then restart your computer.

### Transferring files to your PC

When you connect the camera to your PC, the PC recognizes the camera as a removable drive.

- 1 Connect your camera to your PC with the USB cable.



You must plug the end of the cable with the correct connection plug into your camera. If the cable is reversed, it may damage your files. The manufacturer is not responsible for any loss of data.

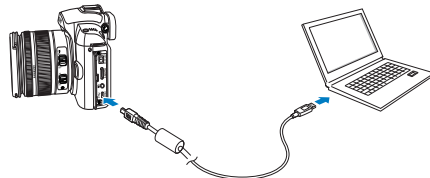

- 2 Turn on the camera.
  - In the popup window, select **Computer**.
- 3 On your PC, select **My Computer** → **Removable Disk** → **DCIM** → "XXXPHOTO," or select "XXX\_MMDD" folder.
- 4 Select the files you want, and then drag or save them to your PC.



- If the Folder Type is set to Date, the folder name appears as "XXX\_MMDD."
- For example, if shot at January 1st, the folder name appears as "101\_0101."

#### Disconnecting the camera (for Windows XP)

The way to disconnect the USB cable for Windows 2000 and Vista is similar.

- 1 If the status lamp on your camera is blinking, it means the data transfer is in progress. Please wait until the status lamp stops blinking.
- 2 Click  on the tool bar at the bottom right of your PC screen.
- 3 Click the pop-up message.
- 4 Remove the USB cable.



## For Mac users

When you connect the camera to a Macintosh computer, the computer recognizes the camera automatically. You can transfer files directly from the camera to the computer without installing any programs.



### Requirements for QuickTime Player 7.6

- 1.8 GHz Power Mac G5/1.83 GHz Intel Core Duo or higher
- Mac OS X version 10.4.10 or later
- Minimum 256 MB RAM (1 GB and above recommended)
- 64 MB or greater video card

- 1 Connect your camera to a Macintosh computer with the USB cable.



When using the USB cable, make sure to match the plugs on the cable to the USB jacks on the camera and computer.

- If the cable is reversed, it may damage your files. The manufacturer is not responsible for any loss of data.
- Please use only the accessories that SAMSUNG provides. The manufacturer takes no responsibility for any loss of files or damage that may result from the use of other manufacturer's product.

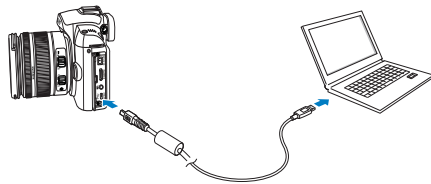

- 2 Turn on the camera.
  - In the popup window, select **Computer**.
- 3 Double-click the removable disk icon.
- 4 Transfer photos or videos to the computer.



## Using Samsung Master

You can download files or edit photos or videos stored on your PC. For details, see the Help menu.



This program does not support the editing of video files (H.264 (MPEG-4, AVC)) on the camera.

### Downloading files using Samsung Master

When you connect the camera to the PC, a window for downloading files automatically appears.

- 1 Select the files you want to download.
- 2 Click Next, and then follow the onscreen instructions.

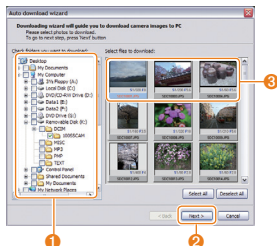

No.	Description
1	Select a location for downloaded files.
2	Click to download the selected files.
3	Thumbnails of files. Click an image to download.

### Using the Samsung Master Interface

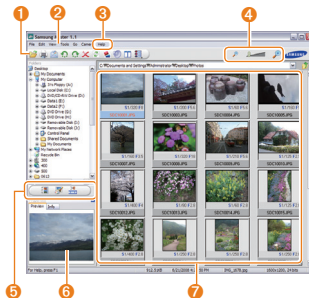

No.	Description
1	Toolbar
2	Menus
3	Click for more information about the program.
4	Click to enlarge or reduce the thumbnails in the list.
5	Change the mode. <ul style="list-style-type: none"> <li>• : View mode</li> <li>• : Edit mode for photos</li> <li>• : Edit mode for videos</li> </ul>
6	Preview information about the selected file.
7	The photos in the folder you selected. Double-click to switch to full-screen view.

# Using the Samsung RAW Converter

Using the Samsung RAW Converter, you can develop RAW files after editing them as you like. You can also edit JPEG or TIFF files in the same way you edit the RAW files. This software is only compatible with Windows XP and Vista.

To start the program, click [Start → All Programs → Samsung RAW Converter → Samsung RAW Converter]

## ■ Editing the RAW files



- Image edit functions are listed below.

### ① Menu bar

### ② Image editing tools

[Exposure bias]: Compensates the exposure value.

[White balance]: Adjusts the white balance value.

[Color]: Adjusts the color of the image.

[Tone]: Changes the color tone.

[Sharpness/Noise reduction]: Adjusts the sharpness.

[Development]: Previewing is available for the final output.

### ③ Highlight controller

Adjusts the saturation and highlights of the selected image.

### ④ Histogram

Displays the color layers of the selected image.

### ⑤ Preview window

Displays the selected image.



- Refer to the [Help] menu in the Samsung RAW Converter for further information.
- You can download the Samsung RAW Converter program for Macintosh from the Samsung website.

## Correcting the exposure

The main feature of the Samsung RAW Converter is that you can keep the best quality of the images as you make changes to the RAW files while editing.

After making changes to the brightness or contrast, you can still obtain the same result no matter which you change first. The following images show how you can change the exposure on an image using the Samsung RAW Converter.

You can adjust the exposure by using the menu option as shown in the picture below.



Menu option for adjusting the exposure.



▲ Original image  
P Mode, Aperture:  
f = 8,  
Shutter Speed:  
1/15sec, ISO = 100



▲ Changed image  
after correcting the  
exposure.

You can see the results of the exposure adjustment in the histograms below:

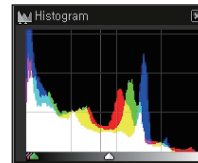

▲ Original image

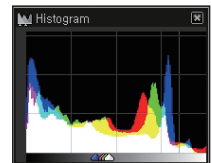

▲ Changed image  
after correcting the  
exposure.

## Handling the JPEG/TIFF files as you edit RAW files

Using the Samsung RAW Converter, you can edit JPEG/TIFF files in the same way you edit RAW files. You can adjust the white balance, sharpness, and reducing the noise is also available. The following images show how to change the contrast on a TIFF image using the Samsung RAW Converter.

You can adjust the contrast by using the menu option as shown in the picture.

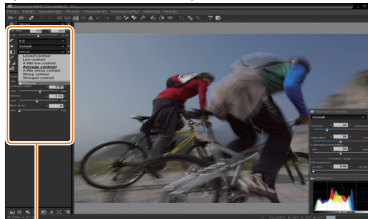

Menu option for adjusting the contrast



▲ Original image P Mode,  
Aperture: f = 8, Shutter  
Speed: 1/15sec, ISO = 100



▲ Changed image after  
correcting the contrast.

## Saving the RAW files in JPEG or TIFF format

You can save the RAW files in JPEG or TIFF format using the Samsung RAW Converter.

1. Choose the image you want to edit, and then select [File(F)] → [Development...].

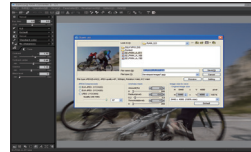

2. Select the type of file as JPEG or TIFF and then click [Save(S)].  
- The selected file is saved as JPEG or TIFF format.

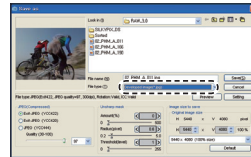

# Printing photos with a photo printer (PictBridge)

Print photos with a PictBridge-compatible printer by connecting your camera directly to the printer.

- 1 With the printer on, connect your camera to the printer with a USB cable.

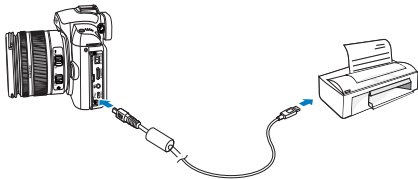

- 2 Turn on your camera.
  - Select **Printer** in the popup window.



- If your printer has the mass storage feature, you must first set the USB mode to **Printer** in the settings menu.

- 3 Press [**◀/▶**] to select a photo.
  - Press [**MENU**] to set printing options.
- 4 Press [**OK**] to print.

## Configuring print settings

1	2
Images	One Photo
Size	Auto
Layout	Auto
Type	Auto
Quality	Auto
Date	Auto
<input type="checkbox"/> Print	<input type="checkbox"/> MENU Exit

<b>Images</b>	Select whether to print the current photo or all photos.
<b>Size</b>	Specify the size of the print.
<b>Layout</b>	Create thumbnail prints.
<b>Type</b>	Select the type of paper.
<b>Quality</b>	Set the printing quality.
<b>Date</b>	Set to print the date.
<b>File Name</b>	Set to print the name of the file.
<b>Reset</b>	Reset the print options.



Some options are not supported by some printers.

# Camera settings menu

You can set the camera use environment using the setup menu.

Camera settings menu ..... 103

# Camera settings menu

You can set the camera use environment using the setup menu.

- 1 Press **[MENU]** in the shooting or play mode.
- 2 Select a desired setup menu

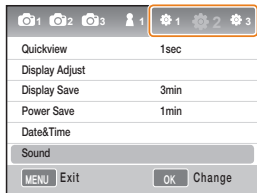

Setup menu items

- 3 Select a desired item

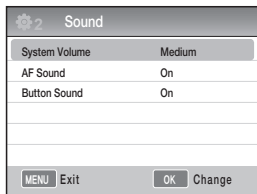

- 4 Press **[MENU]** to return to the previous mode.

103



## Sound

\* Default value

System Volume	You can set the camera use environment using the setup menu. (Off, Low, Medium*, High)
AF Sound	Sets the sound the camera makes in AF mode on or off. (Off, On*)
Button Sound	Sets the sound the camera makes when you press buttons on or off. (Off, On*)

104

## Display

\* Default value

Language	Select the language the camera shows on the display.
Display Adjust	Adjust the display brightness, auto brightness setting, or display color. <b>Display Brightness:</b> You can adjust the display brightness using the [▲/▼] to one of five brightness levels. <b>Auto Brightness:</b> Adjust the brightness of screen. <b>Display Color:</b> Depending on whether the user uses the screen or the viewfinder, the display color can be adjusted by using the [▲/▼/◀/▶].
Display Save	Sets the display off time. (Off, 0.5min*, 1min, 3min, 5min, 10min)
Quickview	This allows setting the quick view (view immediately upon a shot) time. (Off, 1sec*, 3sec, 5sec, Hold)



## Normal setup 1 (⚙️ 1)

\* Default value

Format	<p>This formats the memory card (deleting all the files including protected files). <b>(Yes, No*)</b></p> <p> Error can occur if using a card formatted by another brand of camera, memory card reader or computer. Please use the card after formatting it from the camera.</p>
Reset	<p>This resets the setup menu and shooting options. (The date, time, language, and video output value are kept.) <b>(Yes, No*)</b></p>
File Name	<p>This sets the method of designating filename. <b>Standard*</b> : SAM_XXXX.JPG(sRGB)/_SAMXXXX.JPG(Adobe RGB) <b>Date</b> : MMDDXXXX.JPG(sRGB)/_MDDXXXX.JPG(Adobe RGB, Jan. ~ Sep./_ADDXXXX.JPG(Adobe RGB, indicating A for Oct, B for Nov, C for Dec) For example, the image taken by setting Jan 01 sRGB is saved in "0101xxxx.jpg".</p>
File Number	<p>This sets the method of designating file number. <b>(Series*, Reset)</b></p> <ul style="list-style-type: none"> <li>• The folder name that has taken pictures for the first time becomes 100PHOTO and the filename will be SAM_0001 (when the color space is sRGB).</li> <li>• File name numbers are increased by 1 from SAM_0001 to SAM_9999.</li> <li>• Folder numbers are increased by 1 from 100PHOTO to 999PHOTO.</li> <li>• The maximum number of files that can be saved in one folder is 9999.</li> <li>• File names are assigned according to DCF (Design rule for Camera File system) specifications.</li> <li>• If you change a file name (for example, on a computer), the camera will not be able to play the file.</li> </ul>
Folder Type	<p>This sets the type of folder. <b>Standard*</b> : XXXPHOTO <b>Date</b> : XXX_MMDD</p>

## Normal setup 2 (⚙️<sub>2</sub>)



\* Default value

<p>Power Save</p>	<p>This sets the power turned off automatically if not being used for a while. <b>(0.5 min, 1 min*, 3min, 5min, 10min, 30min)</b></p> <ul style="list-style-type: none"> <li>• The camera retains the power-off time setting even if you replace the battery.</li> <li>• Power Save may not work if the camera is connected to a computer, TV, or printer, playing a slide show or movie.</li> </ul>
<p>Date &amp; Time</p>	<p>This sets the date and time.</p> <p><b>(Type, Date, Time Zone, Time, Imprint)</b></p> <ul style="list-style-type: none"> <li>• Only the date is shown on the lower right side of the picture in play.</li> <li>• When printing a picture, the date may not be printed appropriately from certain manufacturer or printer model.</li> </ul>

## Normal setup 3 ( 3 )

\* Default value

<p>Display Select</p>	<p><b>Auto Select*</b>: Convert between Main Display and EVF by eye sensor  <b>Main Display</b>: The screen will be shown only through Main Display  <b>EVF</b>: The screen will be shown only through EVF</p>
<p>Sensor Cleaning</p>	<p><b>Sensor Cleaning</b>: Removes the dust of sensor when executing this menu  <b>Start Up Action</b>: If set, the dust of sensor is removed whenever turning on the power. <b>(On, Off*)</b></p> <p> Because this product uses interchangeable lenses, the sensor can get dust on it when you change lenses. This can lead to dust particles appearing in the pictures you take. We recommend that you do not change lenses when you are in a particularly dusty area. Also, make sure to attach the lens cap to the lens when not using it.</p>
<p>Video Out</p>	<p>Select the video output signal appropriate for your country when connecting the camera to an external video device such as a monitor or TV.  <b>NTSC*</b> : US, Canada, Japan, Korea, Taiwan, Mexico, etc.  <b>PAL</b> (supporting only the BDGHI method) : Australia, Austria, Belgium, China, Holland, Finland, Germany, England, Italy, Kuwait, Malaysia, New Zealand, Singapore, Spain, Sweden, Switzerland, Thailand, Norway, etc.</p>
<p>Anynet+ (HDMI- CEC)</p>	<p>When you connect the camera to an HDTV that supports Anynet+ (HDMI-CEC), you can control the play function of the camera with the TV remote controller (p. 90).  <b>On*</b> : You can control the play function of camera with the TV remote controller.  <b>Off</b> : You can NOT control the play function of camera with the TV remote controller.</p>

<p>HDMI Size</p>	<p>The resolution on an HDTV can be changed when using an HDMI cable.  (In case of NTSC method : <b>Auto*</b>, <b>1080i</b>, <b>720p</b>, <b>480p</b>)  (In case of PAL method : <b>Auto*</b>, <b>1080i</b>, <b>720p</b>, <b>576p</b>)</p> <p> If the connected HDTV does not support the selected resolution, you select, the camera sets the resolution one level lower.</p>
<p>Firmware Update</p>	<p>Displays the firmware version of the camera body and lens, and upgrades the firmware.  <b>Body Firmware:</b> Upgrades the firmware of the camera body.  <b>Lens Firmware:</b> Upgrades the firmware of the lens.</p> <p> • You can download firmware upgrades from <a href="http://www.samsungimaging.co.kr">www.samsungimaging.co.kr</a> or <a href="http://www.samsung.com">www.samsung.com</a>.  • You can not run a firmware upgrade without a fully charged the battery. Recharge the battery fully before running a firmware upgrade or attach the adaptor to provide power (optional).  • After upgrading the firmware, the user customized options are reset to the default value.  (The date, time, language, and video output values are kept.)</p>

# Appendixes

Refer to error messages, specifications, and maintenance tips.

Error messages .....	110
Camera maintenance .....	111
Before contacting a service center.....	115
Camera specifications .....	118
Lens specifications .....	122
Accessories (optional items) .....	123
Index .....	125

## Error messages

When the following error messages appear, try these remedies.

Error message	Suggested remedies
Card Error	<ul style="list-style-type: none"><li>• Turn off your camera, and then turn it on again.</li><li>• Remove your memory card, and then insert it again.</li><li>• Format your memory card. (p. 105)</li></ul>
Card Locked	Unlock the memory card.
DCF Full Error	File names do not match the DCF standard. Transfer the files on the memory card to your computer and format the card. (p. 105)
File Error	Delete the damaged file or contact a service center.
Low Battery	Insert a charged battery or recharge the battery.
Memory Full	Delete unnecessary files or insert a new memory card.
No Image File	Take photos or insert a memory card that has some photos.
Check the lens.	Check whether dust or foreign substances between Lens contacts and Lens mount index. Remove either dust or foreign substances if dirt or foreign substances are appeared. Please be care for avoid getting dirt foreign substances inside the camera.
Error 00	Turn off the camera, remove the lens, and then mount the lens again.
Error 01/02	Turn off the camera, remove the battery, and then insert it again.

# Camera maintenance

---

## Cleaning your camera

### Camera lens and display

Use a blower brush to remove dust and wipe the lens gently with a soft cloth. If any dust remains, apply lens cleaning liquid to a piece of lens cleaning paper and wipe gently.

### About dust in the image sensor

Depending on the different shooting conditions, dust may appear in the photo images because the image sensor can be exposed to the external environment. This is not a problem of the product, and the exposure to dust can occur in everyday use of camera.

For example, replacing the lens may get dust in the camera's image sensor. This product has the sensor cleaning function that removes the dust of sensor when executing this menu. (P. 107)

Dust in the image sensor may remain after executing the sensor cleaning function. In that case, please contact to the service center. When using the dust blower, do not insert the blower through the lens mount, the camera may malfunction.

### Camera body

Wipe gently with a soft, dry cloth.



- Never use benzene, thinners, or alcohol to clean the device. These solutions can damage the camera or cause it to malfunction.

## About memory cards

### Memory cards you can use

You can use SD (Secure Digital) and SDHC (Secure Digital High Capacity) memory cards.

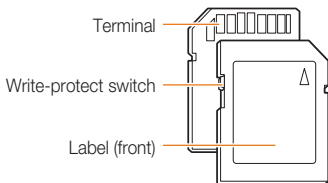

You can prevent files from being deleted by using the write-protect switch on the SD or SDHC card. Slide the switch down to lock or slide it up to unlock. Lock the card to prevent deletions. Unlock the card when shooting.

### Memory card capacity

The memory capacity may vary depending on the scenes you shoot or the shooting conditions. These capacities are based on a 1GB SD card:

Size	Super Fine	Fine	Normal	RAW	RAW+SF	RAW+F	RAW+N
14M (3:2)	142	278	408	35	28	31	32
10M (3:2)	197	382	724	-	32	34	36
6M (3:2)	322	615	1128	-	36	38	39
2M (3:2)	738	1334	2238	-	41	42	43
12M (16:9)	168	328	630	-	30	33	35
8M (16:9)	234	454	860	-	34	36	37
5M (16:9)	381	727	1334	-	38	39	40
2M (16:9)	872	1573	2638	-	42	43	43
Burst	1201	2092	3320	-	-	-	-

	Size	HQ	Normal
*Movies (30fps)	1280 (16:9)	Approx. 15mins	Approx. 22mins
	640 (4:3)	Approx. 44mins	Approx. 66mins
	320 (4:3)	Approx. 145mins	Approx. 210mins

\* The time available for recording may differ if you use the zoom. Several movies were recorded in succession to determine the total recording time.



## About the battery

Use only Samsung-approved batteries.

### Battery specifications

Mode	BP1310
Type	Lithium-ion battery
Cell capacity	1300 mAh
Voltage	7.4 V
Charging time (When fully discharged)	Approx. 150 min

### Battery life

Shooting mode	Number of photos
Photos	Approx. 200 min/Approx. 400 photos
Videos	Approx. 130 min

- The figures above are measured by Samsung's standards and may differ depending on actual usage.
- The shooting time may change depending on the shooting environment and shot intervals.
- Several videos were recorded in succession to determine the total recording time.

#### Notes about charging the battery

- If the charging indicator light does not light, make sure that the battery is inserted correctly.
- If the indicator light blinks in red or does not illuminate, reconnect the adaptor cable, or remove the battery and insert it again.
- If you charge the battery when it is warm, the indicator light may turn orange. Charging will start when the battery cools down.

#### When using the battery, please keep the following guidelines.

- Failure to follow these guideline may cause excessive heat, fire, or explosion.
- If the battery is bulging or distorted, contact a Samsung service center. It may present a physical danger.
- It may present physical dangers.
- Use only the recommended battery charger.
- Do not place the product close to any high temperature source.
- Do not insert the product into a microwave.
- Do not place the product inside a car during the summer.
- Do not place the product in a hot, humid environment.
- Do not place the camera on a carpet, comforter, or electronic mattress for a long time.
- Do not leave the product turned on where there is little or no air circulation.
- Do not let accessories like necklaces, coins, keys, watches, etc., come in contact with the battery chamber.
- Use Advanced Lithium Batteries with a guarantee from the manufacturing company.

- Do not disassemble the battery or perforate the battery with a pin.
- Do not subject the battery or camera to high pressure.
- Do not drop or strike the camera or battery, or subject either to rough handling or sudden shocks.
- Do not expose the battery or camera to temperatures over 60°C (140°F) degree.
- Do not expose the product to water or humidity.
- Battery shall not be exposed to excessive heat such as sunshine, fire or the like.

#### Guidelines of disposal

- Follow the disposal instructions and properly dispose of the used battery.
- Do not dispose of the battery by throwing it in a fire.
- Disposal instructions may differ depending on your country or specific region.
- Follow the disposal instructions of your country, state, etc.

#### Guideline of recharging the battery.

- Do not recharge the battery using a method that differs from the method detailed in this users manual. Failure to follow these instruction may cause a fire or explosion.

# Before contacting a service center

If you are having trouble with your camera, try these troubleshooting procedures before contacting a service center. If you have attempted the troubleshooting solution and are still having problems with your device, contact your local dealer or authorized Samsung service center.

Situation	Suggested remedies
Cannot turn on the camera	<ul style="list-style-type: none"><li>• Make sure that the battery is inserted.</li><li>• Make sure that the battery is inserted correctly.</li><li>• Charge the battery.</li></ul>
The power turns off suddenly	<ul style="list-style-type: none"><li>• Charge the battery.</li><li>• Your camera may be in Power save mode. (p. 106)</li><li>• The power automatically turns off to prevent the camera from malfunctioning in the case that the unit overheats.</li></ul>
The camera is losing battery power quickly	<ul style="list-style-type: none"><li>• The battery may lose power more quickly in low temperatures (below 0° C). Keep the battery warm by putting it into your pocket.</li><li>• Using the flash or recording videos depletes the battery quickly. Recharge if needed.</li><li>• The ability of a Lithium battery to hold a charge diminishes over time. If your battery loses its charge rapidly on a regular basis, purchase a new battery.</li></ul>
Cannot take photos	<ul style="list-style-type: none"><li>• There is no space on the memory card. Delete unnecessary files or insert a new card.</li><li>• Format the memory card. (p. 105)</li><li>• The memory card is defective. Get a new memory card.</li><li>• The memory card is locked. Unlock the card. (p. 112)</li><li>• Make sure that the camera is switched on.</li><li>• Charge the battery.</li><li>• Make sure that the battery is inserted correctly.</li><li>• When you use the <b>AF Priority</b> function, you cannot take a picture without adjusting the focus on the subject correctly. Disable the <b>AF Priority</b> function, or set the focus accurately.</li></ul>
The camera freezes	Remove the battery, and then insert it again.
The flash does not work	<ul style="list-style-type: none"><li>• The flash option may be set to <b>Off</b>. (p. 55)</li><li>• You cannot use the flash in the 📷 mode, or some <b>SCENE</b> modes.</li></ul>
The flash fires unexpectedly	The flash may fire due to static electricity. This is not a malfunction of the camera.

Situation	Suggested remedies
The date and time are incorrect	Set the date and time in the <b>Setting2</b> (⚙️ <sub>2</sub> ) menu.
The display or buttons do not work	Remove the battery, and then insert it again.
The memory card has an error	The memory card has not been reset. Format the card. (p. 105)
Cannot play back files	If you change the name of a file, your camera may not be able to play the file (the name of the file should meet the DCF standard). If you encounter this situation, play back files on your computer.
The photo is blurry	<ul style="list-style-type: none"> <li>• If the subject is out of focus, the photo may be blurry. Make a change to the shooting condition.</li> <li>• If the camera is shaken while shooting, the photo may be blurry. Use a tripod to avoid camera shake.</li> <li>• Make sure that the lens is clean. If not, clean the lens. (p. 111)</li> </ul>
The colors in the photo do not match the actual scene	An incorrect white balance can create unrealistic color. Select the proper white balance option to suit the light source. (p. 68)
The photo is too bright	<p>Your photo is overexposed.</p> <ul style="list-style-type: none"> <li>• Adjust the exposure value. (p. 66)</li> <li>• Adjust the aperture value or the shutter speed. (p. 41)</li> <li>• Turn off the flash. (p. 55)</li> <li>• Adjust the ISO speed. (p. 59)</li> </ul>
The photo is too dark	<p>Your photo is underexposed.</p> <ul style="list-style-type: none"> <li>• Adjust the exposure value.</li> <li>• Adjust the aperture value or the shutter speed.</li> <li>• Turn on the flash.</li> <li>• Adjust the ISO speed.</li> </ul>
The photo is distorted	The wide-angle lens may distort the image. This is a normal feature of the wide-angle lens.

117

Situation	Suggested remedies
The TV does not display your photos	<ul style="list-style-type: none"> <li>• Make sure that the camera is correctly connected to the TV with the A/V and HDMI cable.</li> <li>• Make sure that your memory card contains photos.</li> </ul>
Your computer does not recognize your camera	<ul style="list-style-type: none"> <li>• Make sure that the USB cable is connected correctly.</li> <li>• Make sure that your camera is switched on.</li> <li>• Make sure that you are using a supported operating system.</li> </ul>
Your computer disconnects the camera while transferring files	<p>The file transmission may be interrupted by static electricity. Disconnect the USB cable, and then connect it again.</p>
Your computer cannot play videos	<p>The codec installed in your computer may not be compatible with the video files you want to play. Use QuickTime® Player or install Codec Pack Full.</p> <ul style="list-style-type: none"> <li>• <b>Using QuickTime® Player 7.6</b> <ol style="list-style-type: none"> <li>1. Install QuickTime® Player 7.6 which supports MP4 (H.264 (MPEG-4.AVC)).</li> <li>2. Play videos using QuickTime® Player.</li> </ol> </li> <li>• <b>Using Codec Pack Full</b> <ol style="list-style-type: none"> <li>1. Install the latest version of Codec Pack Full.</li> <li>2. Play videos using the media player (Media Player Classic or Windows Media Player 11 recommended).</li> </ol> </li> </ul> <p> • Install QuickTime® Player 7.6 or K-Lite Codec Pack Full on Windows XP SP2 or later.</p> <ul style="list-style-type: none"> <li>• Depending on your computer environment, the video playback may be intermittent.</li> </ul>

# Camera specifications

118

Specification		
Image Sensor	Type	CMOS
	Sensor size	23.4×15.6mm
	Effective Pixel	Approx. 14.6 Mega-pixels
	Total Pixel	Approx. 15.1 Mega-pixels
	Color Filter	RGB primary color filter
Lens	Mount	Samsung NX Mount
	Usable Lens	Samsung Lenses
Image Stabilization	Type	Lens Shift (depends on Lens)
Dust Reduction	Type	Super sonic drive
Display	Type	AMOLED
	Size	3.0"
	Resolution	VGA (640x480) 614k dots (PenTile).
	Live view	Field of view : Approx. 100%

Specification		
Viewfinder	Type	EVF
	Resolution	VGA (640x480) 921k dots equiv.
	Field of View	Approx. 100%
	Magnification	Approx. 0.86x (APS-C, 50mm, -1m <sup>-1</sup> )
	Eyepoint	About 20.2mm
	Diopter Adjustment	Approx. -4.0 ~ +2.0m <sup>-1</sup>
	Focusing	Type
Focusing point		Selection : 1point (Free selection) Multi : Normal 15points, Close Up 35points Face Detection : Max. 10faces
Modes		Single AF, Continuous AF, MF
AF-assist lamp		Yes (Green LED)
Shutter	Type	Electronically controlled vertical-run focal plane shutter
	Speed	Auto: 1/4000sec. ~ 30sec. Manual: 1/4000sec. ~ 30sec. (1/3EV or 1/2EV step) Bulb (Limit time : 8 min)

Specification		
Exposure	Metering System	TTL 247 (19x13) Block segment  Metering : Multi, Center-weighted, Spot  Metering range : EV0 ~ 18 (ISO100-30mm F2.0)
	Compensation	±3 EV (1/2EV, 1/3EV step)
	AE Lock	AEL button
	ISO Equivalent	Auto, 100, 200, 400, 800, 1600, 3200 (1EV step)
Drive Mode	Modes	Single, Continuous, Burst, Self-timer, Bracket (AE, WB, PW)
	Continuous	JPEG : 3fps up to 10shots, Burst mode : 30fps, 30shots by 1 released RAW : 3fps up to 3shots
	Bracket	Auto Exposure Bracket (±3EV), White Balance Bracket (±3step), Picture Wizard Bracket (Selectable 3modes)
	Self-timer	2-30sec. (1sec. step)
	Remote controller	Wired : SR9NX01 (Optional)

Specification		
Flash	Type	TTL Auto Pop-up flash
	Modes	Smart Flash, Auto, Auto + Red-eye reduction, Fill-in, Fill-in + Red-eye reduction, 1 <sup>st</sup> Curtain, 2 <sup>nd</sup> Curtain, OFF
	Guide Number	11 (at ISO 100)
	Angle of View Coverage	28mm wide-angle (Equivalent to 35mm)
	Sync. Speed	Less than 1/180sec.
	Flash Compensation	-2 - +2EV (0.5EV step)
	External Flash	Samsung External Flash available (SEF42A, SEF20A) (optional)
	Synchro (Flash attachment)	Hot Shoe
	White Balance	Modes
Micro adjustment		Each 7steps in Amber / Blue / Green / Magenta axis
Picture Wizard	Modes	Standard, Vivid, Portrait, Landscape, Forest, Retro, Cool, Calm, Classic, Custom (1-3)
	Parameter	Contrast, Sharpness, Saturation, Color tone

120

Specification		
Shooting	Modes	Smart Auto, Program, Shutter Priority AE, Aperture Priority AE, Manual, Night, Portrait, Landscape, Scene, Movie
	Scene Mode	Beauty shot, Children, Close Up, Text, Sunset, Dawn, Backlight, Fireworks, Beach & Snow
	Image Size	<b>JPEG (3:2):</b> 14M (4592x3056), 10M (3872x2592), 6M (3008x2000), 2M (1920x1280), 1.4M (1472x976): Burst mode only <b>JPEG (16:9):</b> 12M (4592x2584), 8M (3872x2176), 5M (3008x1688), 2M (1920x1080) <b>RAW:</b> 14M (4592x3056)
	Quality	Super fine , Fine, Normal
	RAW Format	SRW
	Color Space	sRGB, Adobe RGB

Specification		
Movie	Format	MP4 (H.264)
	Compression	Movie : H.264 , Sound : AAC
	Movie Clip	With Audio or without Audio (user selectable, recording time : 25 minutes)
	Image size	1280x720 , 640x480 , 320x240
	Frame rate	30fps
	Sound	Mono Sound
	Movie Editing	Still Image Capture, Time Trimming
Image Play	Type	Single image, Thumbnails (3/9/20 images), Slide show, Movie
	Highlight Warning	Available
	Editing	Red eye fix, Back light comp., Photo Style Selector, Resize, Rotate, Face Retouch
	Photo Style Selector	Soft, Vivid, Forest, Autumn, Misty, Gloomy, Classic



Specification		
Storage	Media	External memory card(optional): SD card (up to 4GB guaranteed), SDHC card (up to 8GB guaranteed)
	File Format	RAW (SRW), JPEG (EXIF 2.21), DCF, DPOF 1.1, PictBridge 1.0
	Capacity (1GB)	14M : RAW 35 14M : Super Fine 142, Fine 278, Normal 408 10M : Super Fine 197, Fine 382, Normal 724 6M : Super Fine 322, Fine 615, Normal 1128 2M : Super Fine 738, Fine 1334, Normal 2238 Burst (1.4M) : Super Fine 1201, Fine 2092, Normal 3320 12M(W) : Super Fine 168, Fine 328, Normal 630 8M(W) : Super Fine 234, Fine 454, Normal 860 5M(W) : Super Fine 381, Fine 727, Normal 1334 2M(W) : Super Fine 872, Fine 1573, Normal 2638 Movie : 1280x720 : High Quality 15min., Normal 22min. 640x480 : High Quality 44min., Normal 66min. 320x240 : High Quality 145min., Normal 210min. ※ These figures are measured under the Samsung standard

Specification		
Direct Printing		PictBridge
Interface	Digital Output Connector	USB 2.0 (HI-SPEED)
	Video output	NTSC, PAL (user selectable) HDMI 1.3 : (1080i, 720P, 576P / 480P)
	External Release	Yes
	DC power input connector	DC 9.0V, 1.5A (100 ~ 240V)
Power Source	Type	Rechargeable battery : BP1310 (1300mAh) Charger: BC1310 AC Adaptor : AD9NX01 (Optional) * Included battery may vary depending on sales region
	Physical Specification	Dimensions (WxHxD)
Weight		353g (without batteries and card)
Operating Temperature		0 ~ 40 °C
Operating Humidity		5 ~ 85%
Software	Application	Samsung Master, Samsung RAW Converter, QuickTime Player 7.6

- \* Specifications are subject to change without prior notice
- \* All trademarks are the property of their respective owners

## Lens specifications

Lens Name	SAMSUNG 30mm F2	SAMSUNG 18-55mm F3.5-5.6 OIS	SAMSUNG 50-200mm F4-5.6 ED OIS
Focal Length	30mm (equivalent to 46.2mm in 35mm format)	18 - 55mm (equivalent to 27.7-84.7mm in 35mm format)	50 - 200mm (equivalent to 77-308mm in 35mm format)
Elements in Groups	5 elements in 5 groups (1 Aspherical lens included)	12 elements in 9 groups (1 Aspherical lens included)	17 elements in 13 groups (2 Extra-low Dispersion lens included)
Angle of View	50.2°	75.9°- 28.7°	31.4°- 8.0°
Aperture	F2 (Min. F22), (Number of Blades : 7 , Circular Aperture Diaphragm)	F3.5 - 5.6 (Min. F22), (Number of Blades : 7 , Circular Aperture Diaphragm)	F4 - 5.6 (Min. F22), (Number of Blades : 7 , Circular Aperture Diaphragm)
Mount Type	Samsung NX Mount	Samsung NX Mount	Samsung NX Mount
Optical Image Stabilizer	No	Yes	Yes
Minimum Focus Distance	0.25m ~ ∞	0.28m ~ ∞	0.98m ~ ∞
Maximum Magnification	Approx. 0.16X	Approx. 0.22X	Approx. 0.2X
Lens Hood	Optional	Included	Included
Filter Size	43mm	58mm	52mm
Max. Diameter x Length	61.5 x 21.5mm	63 x 65.1mm	70 x 100.5mm
Weight	Approx. 85g (without hood)	Approx. 198g (without hood)	Approx. 417g (without hood)
Operating Temperature	0 ~ 40°C	0 ~ 40°C	0 ~ 40°C
Operating Humidity	5 ~ 85%	5 ~ 85%	5 ~ 85%



The lens provided may differ by the model.

## Accessories (optional items)

---



### Lens

Make better pictures with a 30mm, 18-55mm, or 50-200mm lens made exclusively for the Samsung NX-series camera.

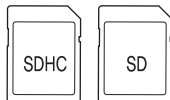

### Memory card

In this camera, the memory cards such as SD (Secure Digital) and SDHC (Secure Digital High Capacity) may be used.

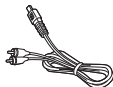

### A/V cable

The camera can be connected to an external device by using an A/V cable.



### Shutter release

This product minimizes the possible shaking of camera when taking pictures by using a tripod or taking pictures at a low shutter speed.

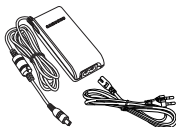

### Adaptor

The power needed in the camera can be supplied by connecting to a power socket using this adaptor.



#### Strap

Straps can be purchased separately.



#### Camera bag

Camera bag can be purchased separately.



#### Filter

Optional filters can be purchased and attached to the lens.

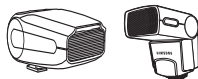

#### Flash

Optional flash(SEF20A or SEF42A) can be purchased for your various shooting experience.

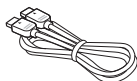

#### HDMI Cable

You can view high-quality and uncompressed photos or videos on an HDMI (High Definition Multimedia Interface) using the optional HDMI cable.



#### Battery pack

Battery pack can be purchased separately.



The image of components or optional parts can differ from that of the actual products. Please refer to the user's manual of the optional items.

# Index

---

125

## A

Adjusting exposure 5  
Automatic focus 34  
Aperture priority mode 41  
Aperture value 41  
AF Priority 60  
AF assist light 61  
AE BKT 73  
AEL function 77  
AF Sound 104  
Anynet+ 107  
Appendixes 109  
Accessories (optional items) 123

## B

Background 7  
Bulb exposure 44  
Bracket setup 74  
Backlight adjustment 88  
Button sound 104  
Battery 18, 115

## C

Composition 7  
Close-up 39  
Continuous AF 60  
Center-weighted metering 67  
Color temperature 70  
Color space 71  
Changing the shooting method 73  
Continuous shooting 73  
Camera maintenance 111

Camera specifications 120

## D

Direction keys 5  
Diopter adjustment dial 16  
Display type 28  
Depth of field 37  
Depth Preview 37  
Deleting a file 82  
Display 104  
Date&Time 106

## E

Eye sensor 15  
Eye-cup 16  
EV button 43  
External flash 58  
Error message 110

## F

Fn 27  
Flash popup button 55  
Focusing methods 60  
Face detection 64  
File protection 82  
Face retouching 88  
Format 105  
File name 105  
File number 105  
Folder type 105  
Firmware update 108

## H

Half-shutter 32  
HDTV 92  
HDMI Size 108

## I

ISO sensitivity 59  
Icons 25  
Image stabilization 32  
Index printing 90

## J

JPEG 100

## K

Key mapping 77

## L

Lens 17  
Landscape mode 45  
Language 104  
Lens specifications 122

## M

Mounting/dismounting the lens 21  
Manual focus 34  
Manual mode 43  
Multi AF 61  
Multi-metering 67  
Mac users 96  
Memory card 112

**N**

Night mode 45  
Noise reduction 53

**O**

Option/menu selection method 26  
OIS 35

**P**

Program mode 40  
Portrait mode 45  
P Wiz BKT 73  
Picture wizard 75  
Playback 79  
Picture editing 87  
Picture style 88  
Print info 89  
Photo printer 101  
PictBridge 101  
Power save 106

**Q**

Quality 52  
QuickTime player 93  
Quickview 104

**R**

Recording a movie 48  
Resolution 51  
Red-eye reduction 56  
Rotating 87  
Red-eye fix 88  
Regular TV 91  
RAW 100  
Reset 105

**S**

Shooting mode 5  
Subject 7  
Status lamp 16  
Strap 22  
Sound 29  
Smart Auto mode 39  
Shutter Priority mode 42  
Shutter speed 42  
Scene mode 46  
Setting the flash option 55  
Single AF 60  
Selection AF 61  
Self-portrait face detection 65  
Spot metering 67  
Smart range 72  
Shooting method 73  
Smart album 81  
Slide show 84  
Samsung Master 97  
Samsung Raw Converter 98

System volume 104  
Sensor cleaning 107

**T**

Title and role of each part 14  
Turning on the power 23  
Tips 32  
Timer 54  
Thumbnail view 81

**U**

Unpacking 13  
Using the dial 26  
User display 29

**V**

View a movie 85  
Video Out 107

**W**

Wind Cut 49  
White balance 68  
Windows users 93  
WB BKT 73

**Z**

Zoom 34  
  
1st Curtain 56  
2nd Curtain 56



### Correct Disposal of This Product (Waste Electrical & Electronic Equipment)

(Applicable in the European Union and other European countries with separate collection systems)

This marking on the product, accessories or literature indicates that the product and its electronic accessories (e.g. charger, headset, USB cable) should not be disposed of with other household waste at the end of their working life. To prevent possible harm to the environment or human health from uncontrolled waste disposal, please separate these items from other types of waste and recycle them responsibly to promote the sustainable reuse of material resources. Household users should contact either the retailer where they purchased this product, or their local government office, for details of where and how they can take these items for environmentally safe recycling. Business users should contact their supplier and check the terms and conditions of the purchase contract. This product and its electronic accessories should not be mixed with other commercial wastes for disposal.



#### Samsung Eco-mark

It is Samsung's own symbol mark is used to effectively communicate Samsung's environmental friendly product activities to the consumers. The mark represents Samsung's continuous effort on development of environmental conscious products.



### Correct disposal of batteries in this product

(Applicable in the European Union and other European countries with separate battery return systems)

This marking on the battery, manual or packaging indicates that the batteries in this product should not be disposed of with other household waste at the end of their working life. Where marked, the chemical symbols Hg, Cd or Pb indicate that the battery contains mercury, cadmium or lead above the reference levels in EC Directive 2006/66. If batteries are not properly disposed of, these substances can cause harm to human health or the environment.

To protect natural resources and to promote material reuse, please separate batteries from other types of waste and recycle them through your local, free battery return system.

This Class [B] digital apparatus complies with Canadian ICES-003.



Please refer to the warranty that came with your product or visit our website  
<http://www.samsungimaging.com> for after-sales service or inquiries.

