

The Samsung logo is located in the top left corner of the blue cover. It consists of the word "SAMSUNG" in a bold, white, sans-serif font, enclosed within a white oval shape. The background of the cover is a solid blue color with a subtle, abstract pattern of overlapping, semi-transparent white circles and lines that create a sense of depth and movement.

SAMSUNG

User Manual

WB5000

Thank you for buying a Samsung Camera. This manual will help you learn to capture images, share or print your photos, and edit photos with the accompanying software. Please read this manual thoroughly.

Instructions

Use this camera in the following order.

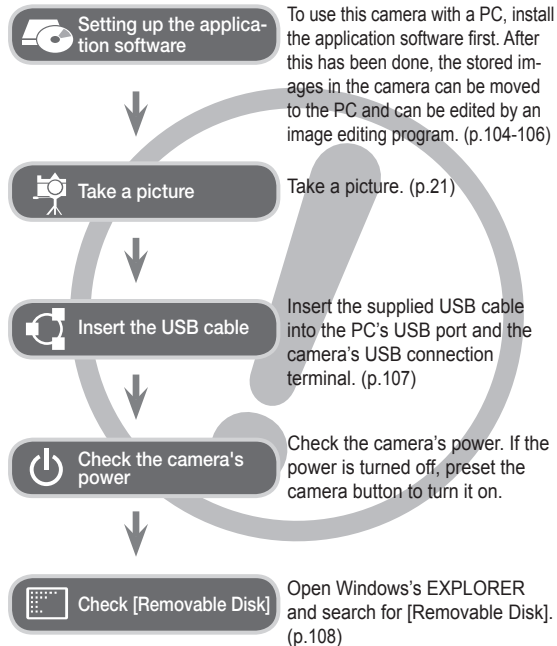

Getting to Know your camera

Thank you for buying a Samsung Digital Camera.

- Prior to using this camera, please read the user manual thoroughly.
 - If you require After Sales service, please bring the camera and the cause of the camera malfunction (such as battery, Memory card etc.) to the A/S centre.
 - Please check that the camera is operating properly prior to when you intend to use it (e.g. for a trip or an important event) to avoid disappointment. Samsung takes no responsibility for any loss or damage that may result from camera malfunction.
 - Keep this manual in a safe place.
 - If you use a card reader to copy the images on the memory card to your PC, the images could be damaged. When transferring the images taken with the camera to your PC, be sure to use the supplied USB cable to connect the camera to your PC. Please note that the manufacturer holds no responsibility for loss or damage of images on the memory card due to the use of a card reader.
 - The contents and illustrations of this manual are subject to change without prior notice for upgrading the camera functions.
- ※ Microsoft, Windows and Windows logo are registered trademarks of Microsoft Corporation incorporated in the United States and/or other countries.
- ※ Apple, Mac and QuickTime logo are registered trademarks of Apple computer.
- ※ Adobe and Reader are either trademarks or registered trademarks in the United States and/or other countries.
- ※ All brand and product names appearing in this manual are registered trademarks of their respective companies.

Danger

DANGER indicates an imminently hazardous situation which, if not avoided, will result in death or serious injury.

- Do not attempt to modify this camera in any way. To do so may result in fire, injury, electric shock or severe damage to you or your camera. Internal inspection, maintenance and repairs should only be carried out by your dealer or Samsung Camera Service centre.
- Please do not use this product in close proximity to flammable or explosive gases, as this could increase the risk of explosion.
- Should any form of liquid or a foreign object enter the camera, do not use it. Switch off the camera, and then disconnect the power source. You must contact your dealer or Samsung Camera Service centre. Do not continue to use the camera as this may cause a fire or electric shock.
- Do not insert or drop metallic or inflammable foreign objects into the camera through access points e.g. the memory card slot and battery chamber. This may cause a fire or electric shock.
- Do not operate this camera with wet hands. This could pose a risk of electric shock.

Warning

WARNING indicates a potentially hazardous situation which, if not avoided, could result in death or serious injury.

- Do not use the flash in close proximity to people or animals. Positioning the flash too close to your subject's eyes may cause eyesight damage.
- For safety reasons keep this product and accessories out of reach of children or animals to prevent accidents e.g.:
 - Swallowing battery or small camera accessories. If an accident should occur, please consult a doctor immediately.
 - There is the possibility of injury from the camera's moving parts.
- Battery and camera may become hot during prolonged use and it may result in camera malfunction. Should this be the case, allow the camera to sit idle for a few minutes to allow it time to cool.
- Do not leave this camera in places subject to extremely high temperatures, such as a sealed vehicle, direct sunlight or other places of extremes in temperature. Exposure to extreme temperatures may adversely affect the camera's internal components and could cause a fire.
- When in use, do not cover the camera or Charger. This may cause heat to build up and distort the camera body or cause a fire. Always use the camera and its accessories in a well-ventilated area.

Caution

CAUTION indicates a potentially hazardous situation which, if not avoided, may result in a minor or moderate injury.

- Leaking, overheating, or damaged battery could result in fire or injury.
 - Use battery with the correct specification for the camera.
 - Do not short circuit, heat or dispose of battery in fire.
 - Do not insert the battery with the polarities reversed.
- Remove the battery when not planning to use the camera for a long period of time. Otherwise the battery may leak corrosive electrolyte and permanently damage the camera's components.
- Do not fire the flash while it is in contact with hands or objects. Do not touch the flash after using it continuously. It may cause burns.
- Do not move the camera while it is switched on, if you are using the AC adapter. After use, always switch off the camera before unplugging the cable from the wall socket. Then make sure that any connector cords or cables to other devices are disconnected before moving the camera. Failure to do so may damage the cords or cables and cause a fire or electric shock.
- Take care not to touch the lens or lens cover to avoid taking an unclear image and possibly causing camera malfunction.
- Avoid obstructing the lens or the flash when you capture an image.
- When using this camera in low temperatures, you may experience the following. These are not camera malfunctions and usually recover at normal temperature.
 - It takes longer to turn on the LCD monitor and the colour may differ from the subject.
 - When changing the composition, there may be an after image on the LCD monitor.
- Credit cards may be demagnetized if left near case. Avoid leaving magnetic strip cards near the case.
- Never connect the 20 pin connector to the USB port of a PC. This carries a high risk of computer malfunction.

Contents

READY	007	System chart
	007	Package Contents
	007	Sold Separately
	008	Identification of features
	008	Front & Top
	009	Back
	011	Bottom
	011	Smart dial
	012	Self-timer lamp
	012	Camera Status Lamp
	012	Mode icon
	013	Connecting to a Power Source
	015	Inserting the memory card
	016	Instructions on how to use the memory card
	018	When using the camera for the first time
	019	LCD monitor indicator
	020	How to use the menu
RECORDING	021	Starting the recording mode
	021	Selecting modes
	022	How to use the Smart Auto mode
	023	How to use the Program mode
	023	How to use the Aperture. Shutter Priority mode
	024	How to use the Manual mode
	024	How to use the User Setting shooting mode
	025	How to use the Nightscene modes
	025	How to use the Beauty Shot mode
	026	How to use the Scene modes

Contents

027	How to use the Movie clip mode	047	Face Detection
028	Recording HD (High Definition) movie clips	049	Face Tone
028	Recording the movie clip without sound	049	Face Retouch
029	Things to Watch Out for When Taking Pictures	050	Image Size
030	Focus lock	050	Quality / Frame rate
030	Using the camera buttons to set the camera	051	Dynamic range
030	POWER button	051	Metering
031	SHUTTER button	052	Drive mode
031	Zoom W/T Lever	052	Setting AEB area
033	Diopter adjustment lever	053	Auto Focus type
033	AEL/Image protection button	053	Flash Intensity
033	Flash pop-up button	054	Photo Style Selector
034	Exposure compensation button	055	Image Adjust
034	EVF/LCD button	056	Image Stabilization
035	MENU button	057	Key mapping
036	OK/AF point button	057	Voice Memo
036	Info (DISP) / Up button	058	Voice Recording
037	Macro / Down button	059	Recording the movie clip without voice
040	Flash / Left button	059	Distortion compensation
042	Self-timer / Right button	060	Setting user mode
043	Functions	060	Movie clip frame stabiliser
044	How to Enable Functions Using the MENU Button		
045	White balance		
046	Fine-tuning the white balance		
046	ISO		
		SETUP	061 Sound menu
			061 Sound
			061 Volume
			061 Start up sound
			061 Shutter sound
			061 Beep Sound
			062 AF sound
			062 Self Portrait
		062 Setup menu	

Contents

- 062 Display**
- 062 Language
- 063 Setting the Grid Line
- 063 Function Description
- 063 Start up image
- 063 Display Bright
- 064 Quick view
- 064 Display SAVE
- 065 Settings**
- 065 Formatting a memory
- 065 Initialisation
- 066 Setting up the Date / Time / Date type
- 066 Time Zone
- 066 File name
- 067 Imprinting the recording date
- 067 Auto power off
- 068 Auto Focus lamp
- 068 Selecting Video out type
- 069 Setting the USB
- PLAY 070 Starting play mode**
- 070 Playing back a still image
- 070 Playing back a movie clip
- 071 Movie clip capture function
- 071 Playing back a recorded voice
- 071 Playing back a voice memo
- 072 LCD monitor Indicator**
- 073 Using the camera buttons to set the camera**
- 073 Thumbnail / Digital Zoom Lever**
- 073 Smart Album
- 075 Info (DISP) / Up button**
- 075 Play & Pause / OK button**
- 076 Left / Right / Down / MENU button**
- 076 Delete button**
- 077 Setting up the play back function using the LCD monitor**
- 079 Edit**
- 079 Resize
- 080 Rotating an image
- 080 Photo Style Selector
- 081 Image Adjust
- 083 View**
- 083 Starting the Multi Slide Show**
- 083 Start the Multi Slide Show
- 084 Selecting Images
- 084 Configure Multi Slide show effects
- 085 Setting play interval
- 085 Setting Background Music
- 085 File Options**
- 085 Deleting images
- 086 Protecting images
- 087 Registering faces
- 088 Recycle Bin
- 088 Voice memo
- 089 DPOF
- 091 Copy To Card
- 092 PictBridge**
- 093 PictBridge : Picture Selection**
- 093 PictBridge : Print Setting**

Contents

094	PictBridge : Reset
094	Important notes
096	Warning indicator
097	Before contacting a service centre
099	Specifications

SOFTWARE	101	Software Notes
	102	System Requirements
	102	QuickTime Player 7.6 : H.264(MPEG4. AVC) playback Requirements
	103	About the software
	104	Setting up the application software
	107	Starting PC mode
	109	Removing the removable disk
	110	Samsung Master
	113	Using the Samsung RAW Converter
	114	Correcting the exposure
	115	Handling the JPEG/TIFF files as you edit RAW files
	115	Saving the RAW files into JPEG or TIFF format
	116	Setting up the USB Driver for MAC
	116	Using the USB Driver for MAC
	117	FAQ

System chart

Please check that you have the correct contents before using this product. The contents can vary depending on the sales region. To buy the optional equipment, contact your nearest Samsung dealer or Samsung service centre. Parts and accessories illustrated below may differ from exact appearance.

Package Contents



Camera



Rechargeable battery



AC adapter / USB cable



Neck strap (see p.10)



Lens cap (see p.10)

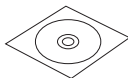

Software CD
(see p.103)



User manual,
Product warranty

Sold Separately



SD/SDHC memory card
(see p.16)



AV cable

Identification of features

Front & Top

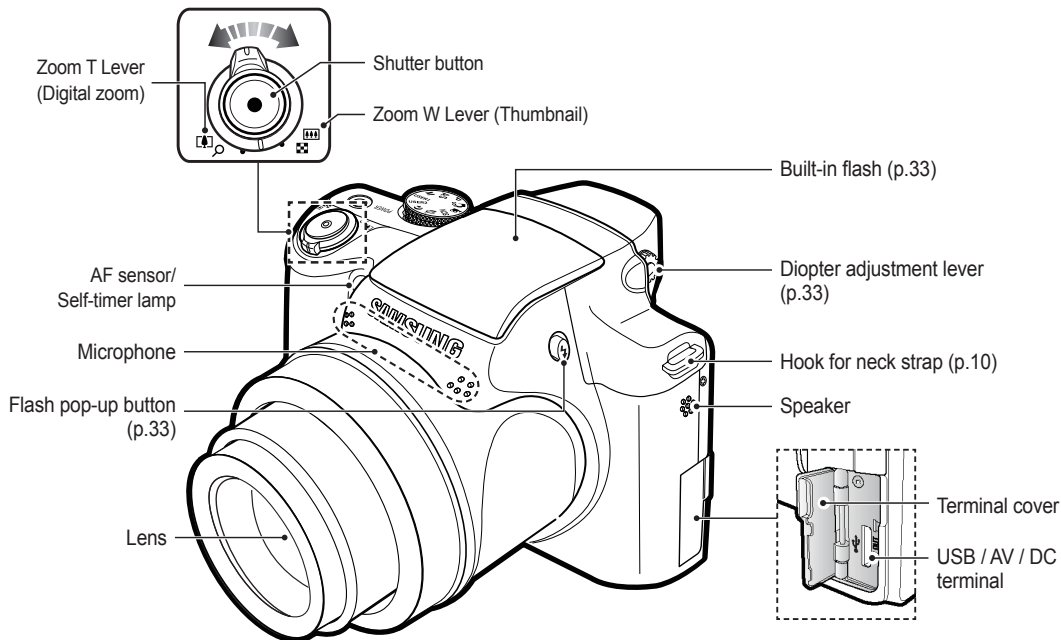

Identification of features

Back

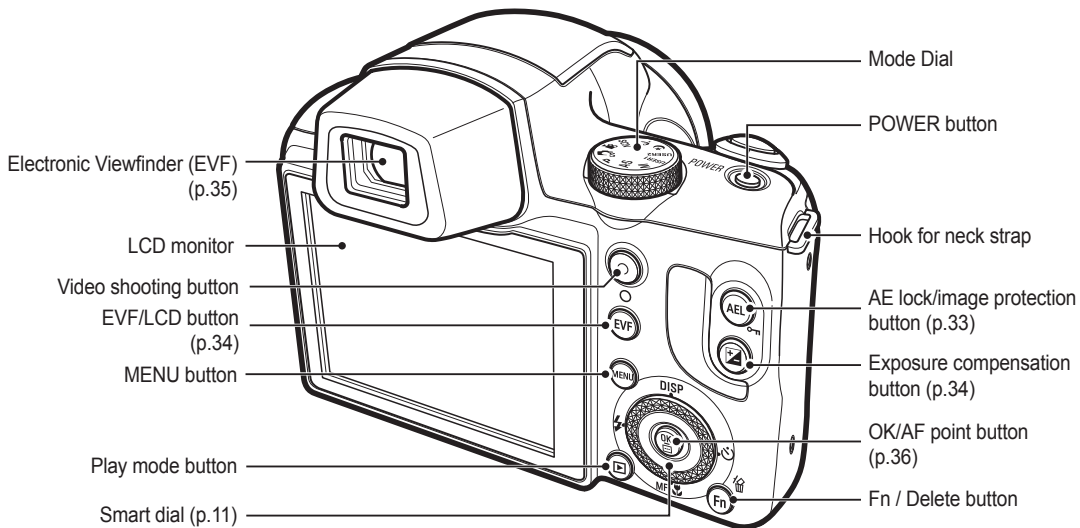

Identification of features

■ Attaching the neck strap

Attach the neck strap as shown below.

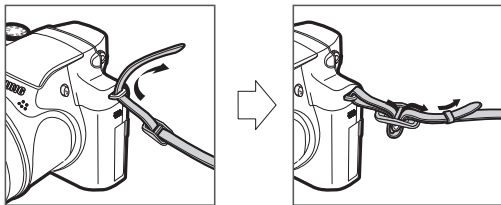

 Ensure that the neck strap is attached correctly, or the camera may fall.

■ Attaching a lens cap to the camera

1. Insert the lens cap string into the hole in the lens cap.

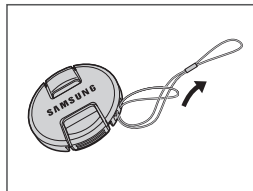

2. Attach the lens cap to the neck strap.

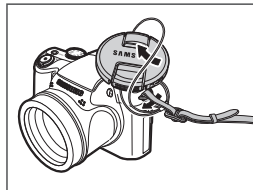

3. Attach the lens cap as shown in the image.

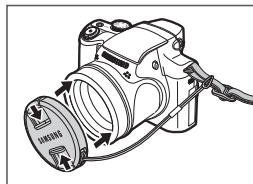

Identification of features

Bottom

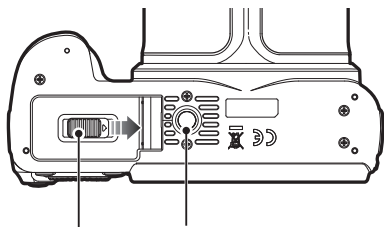

Battery chamber cover lever Tripod socket

Push the battery chamber cover lever in the direction of the arrow to open the battery chamber cover.

Battery chamber Battery chamber cover

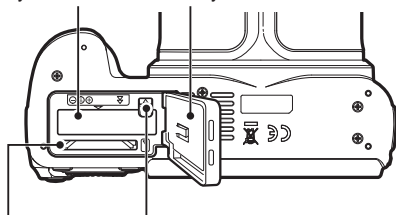

Memory card slot Battery holder

Smart dial

■ When pressing the Smart Dial

- Move UP/DOWN /LEFT/RIGHT
- Execute options in the shooting mode:
 - ① Change the display
 - ② Change the timer option
 - ③ Change the close-up shooting option
 - ④ Change the flash option

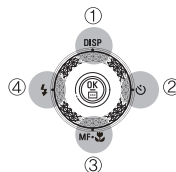



■ When turning the Smart Dial

- Move option or menu
- Adjust the shutter speed, aperture value, exposure value and set the automatic exposure bracketing (AEB) area in the shooting mode.
- Search files in the playback mode.



Identification of features

Self-timer lamp











Icon	Status	Description
	Blinking	- For the first 8 seconds, the lamp blinks at 1 second intervals. - For the final 2 seconds, the lamp blinks quickly at 0.25-second intervals.
	Blinking	For the 2 seconds, the lamp blinks quickly at 0.25-second intervals.
	Blinking	A picture will be taken after about 10 seconds and 2 seconds later a second picture will be taken.











Camera Status Lamp

Status	Description
Power on	The lamp turns on and off when the camera is ready to take a picture
After taking a picture	The lamp blinks while saving the image data and turns off when the camera is ready to take a picture
When flash battery is charging	The lamp blinks
When the USB cable is inserted to a PC	The lamp lights up (LCD monitor turns off after initializing the device)
Transmitting Data with a PC	The lamp blinks (LCD monitor turns off)
When the USB cable is inserted into a printer	The lamp blinks
When the printer is printing	The lamp blinks
When the AF activates	The lamp turns on (The camera focus on the subject)
	The lamp blinks (The camera doesn't focus on the subject)

Mode icon

Refer to page 21 for more information about the camera mode setting.

MODE	Smart Auto	Program	Aperture. Shutter Priority
ICON			
MODE	Manual	User	Night
ICON		 	
MODE	Beauty Shot	Scene	Movie
ICON			

MODE	SCENE			
	Frame Guide	Portrait	Children	Landscape
ICON				
MODE	Close up	Text	Sunset	Dawn
ICON				
MODE	Backlight	Firework	Beach&Snow	
ICON				

Connecting to a Power Source

You should use the rechargeable battery SLB-11A supplied with the camera. Be sure to charge the battery before using the camera.

■ SLB-11A rechargeable battery Specification

Model	SLB-11A
Type	Lithium Ion
Capacity	1130mAh
Voltage	3.8V
Charging time	Approximately 150 Minutes

■ Number of images and battery life: Using the SLB-11A

	Battery life / Number of images	Conditions
Still image	Approx. 90 MIN / Approx. 180 shots	Using the fully charged battery, Auto mode, 12M image size, Fine image quality, Shot to shot interval: 30Sec. Changing the zoom position between the Wide and the Tele after every shot. Using the flash on every second shot. Using the camera for 5 minutes and then powering it off for 1 minute.
Movie	Approx. 70 MIN	Using the fully charged battery 640x480 image size 30fps frame rate

※ These figures are measured under Samsung's standard conditions and shooting conditions and may vary depending on the user's methods.



Important information about battery usage.

- When camera is not in use, turn off the power.
- Please remove the battery if the camera will not be used for long periods. Batteries can lose power over time and are prone to leaking if kept inside the camera.
- Low temperatures (below 0°C) can affect the performance of the battery and you may experience reduced battery life.
- Batteries will usually recover at normal temperatures.
- During extended use of the camera, the camera body may become warm. This is perfectly normal.

- Connecting the AC adapter with the USB cable can be used as an AC cable, and you can charge the rechargeable battery with the AC cable.

- Using an AC cable:
Connect the AC adapter to the USB cable. It can be used as a power cable.

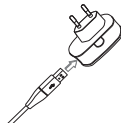

- Using a USB cable:
Remove the AC adapter.
You can download stored images to your PC (p.107) or supply the power to your camera through the USB cable.

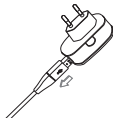

Connecting to a Power Source



Important information about USB cable usage.

- Use a USB cable with the correct specification.
- If the camera is connected to the PC through a USB hub : connect the camera directly to the PC.
- If the camera and other devices are connected to the PC at the same time : remove other device.
- Camera can not be detected using the front side USB port of computer. In this case, use the back side USB port of computer.
- If the USB port of the PC doesn't meet the Power output standard (5V, 500mA), the camera may not be charged.

■ How to charge the rechargeable battery

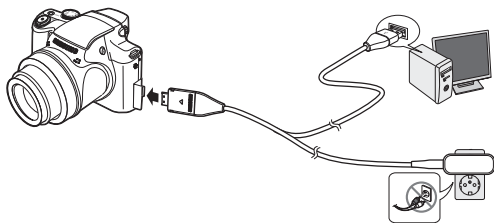

- Before inserting any cables or AC adapter, check the directions and do not insert by force. It may cause breakage of cable or camera.
- If the charging LED of the AC Charger does not turn on or blink after inserting the rechargeable battery, please check whether the battery is inserted correctly.
- If you charge the battery with the camera power on, the battery won't be fully charged. Turn the camera off while charging the battery.

■ Charging LED of the AC Adapter

	Charging LED
Being Charged	Red LED is on
Charging is complete	Green LED is on
Charging error	Orange LED is off or blinking

- If you insert the fully discharged battery to charge it, do not turn on the camera at the same time. The camera may not be turned on because of the low battery capacity. Charge the battery for more than 10 minutes before using the camera.
- Do not use the flash frequently or take a movie clip with the fully discharged battery charged for a short time. Even if the charger is inserted, the camera power may be turned off because the rechargeable battery is discharged again.

Connecting to a Power Source

■ Insert the battery as shown

- If the camera does not turn on after you have inserted battery, please check whether the battery (+ / -).
- When the battery chamber cover is opened, do not force it. This may cause damage to the battery chamber cover.

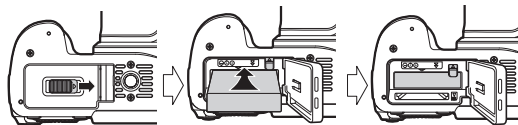

■ There are 4 indicators for battery condition that are displayed on the LCD monitor.

Battery indicator				
Battery status	The battery is fully charged	Low battery capacity (Prepare to recharge or use spare battery)	Low battery capacity (Prepare to recharge or use spare battery)	Battery empty. (Recharge or use spare battery)

※ When using the camera and the battery in a place that is excessively cold or hot, the battery status on the LCD may be different from the actual battery status.

Inserting the memory card

■ Insert the memory card as shown.

- Turn off the camera's power before inserting the memory card.
- Have the front label of the memory card facing toward the front of the camera (Lens) and the card pins toward the back of the camera (LCD monitor).
- Do not insert the memory card the wrong way round. Doing so may damage the memory card slot.

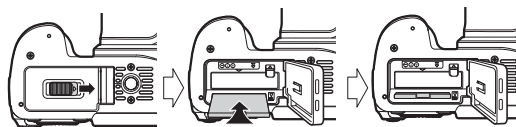

Instructions on how to use the memory card

- Be sure to format the memory card (see p.65) if you are using a newly purchased memory card for the first time, if it contains data that the camera cannot recognise, or if it contains images captured with a different camera.
- Turn off the camera power whenever the memory card is being inserted or removed.
- Repeated use of the memory card will eventually reduce the memory card's performance. Should this be the case, you will need to purchase a new memory card. Wear and tear on the memory card is not covered by the Samsung warranty.
- The memory card is an electronic precision device. Do not bend, drop or subject the memory card to any heavy impact.
- Do not store the memory card in an environment with strong electronic or magnetic fields, e.g. near loud speakers or TV receivers.
- Please do not use or store in an environment where there are extremes in temperature.
- Do not allow the memory card to become dirty or to come into contact with any liquid. Should this happen, clean the memory card with a soft cloth.
- Please keep the memory card in its case when not in use.
- During and after periods of extended use, you may notice that the memory card is warm. This is perfectly normal.
- Do not use a memory card that is used in another digital camera. To use the memory card in this camera, format the memory card using this camera.
- Do not use a memory card formatted by another digital camera or memory card reader.
- If the memory card is subjected to any of the following, the recorded data may become corrupted :
 - When the memory card is used incorrectly.
 - If the power is switched off or the memory card is removed while recording, deleting (formatting) or reading.
- Samsung cannot be held responsible for lost data.
- It is advisable to copy important data onto other media as back-up e.g. hard disks, CD etc.
- If there is insufficient memory available :
A [Memory Full] message will appear and the camera will not operate. To optimise the amount of memory in the camera, replace the memory card or delete unnecessary images stored on the memory card.



- Don't remove the memory card when the camera status lamp is blinking as this may cause damage to data in the memory card.

Instructions on how to use the memory card

The camera can use SD/SDHC Memory Cards and MMC (Multi Media Cards).

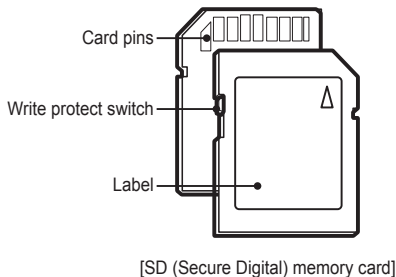

- The SD/SDHC memory card has a write protect switch that prevents image files from being deleted or formatted. By sliding the switch to the bottom of the SD/SDHC memory card, the data will be protected. By sliding the switch to the top of the SD/SDHC memory card, the data protection will be cancelled.
- Slide the switch to the top of the SD/SDHC memory card before taking a picture.

When using a 1GB SD memory, the specified shooting capacity will be as follows. These figures are approximate as image capacities can be affected by variables such as subject matter and memory card type.

Recorded image size	RAW	+RAW	+RAW	+RAW	CF	F	F	
Still image	12M	45	33	37	39	134	222	333
	10M	-	-	-	-	152	250	375
	9M	-	-	-	-	179	295	442
	8M	-	-	-	-	201	331	494
	5M	-	-	-	-	318	519	769
	3M	-	-	-	-	502	820	1198
	2M	-	-	-	-	751	1198	1731
	1M	-	-	-	-	1833	2833	3896

Recorded image size	60 F	30 F	15 F	
Movie clip	1280 1920	-	14'26"	20'00"
	640	-	41'31"	110'46"
	320	89'48"	158'14"	227'37"

- The recording times can be changed by the zoom operation. The Zoom W/T lever doesn't function during the movie recording.
- Several videos were recorded in succession to determine the total recording time.

When using the camera for the first time

- Charge the rechargeable battery fully before using the camera for the first time.
- When the camera is turned on for the first time, a menu will be displayed in the LCD monitor to set date, time and language. This menu will not be displayed again after setting up the date, time and language. Set up the date, time and language before using this camera.

■ Setting up the language

1. Select the [Language] menu by pressing the Up/Down button and press the Right button.
2. Select the desired sub menu by pressing the Up/Down button and press the OK button.



■ Setting up the Time Zone

1. Select the [Time Zone] menu by pressing the Up/Down button and press the Right button.
2. Press the Left/Right button to select the desired mode.



■ Setting up the date, time and date type

1. Select the [Date&Time] menu by pressing the Up/Down button and press the Right button.
2. Select the desired sub menu by pressing the Up/Down/Left/Right button and press the OK button.

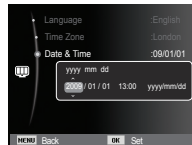

Left/Right button : Selects world time/year/ month/ day/hour/ minute/ date type.

Up/Down button : Changes the value of each item.

※ For more information about the World Time, refer to the page 66.

LCD monitor indicator

- The LCD monitor displays information about the shooting functions and selections.

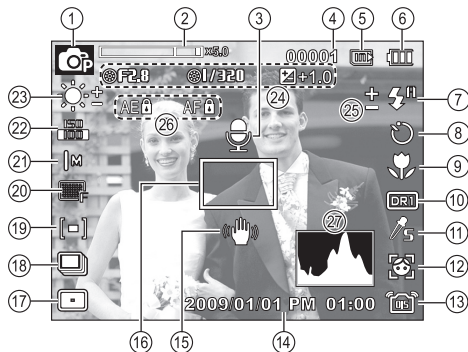

[Image & Full Status]

No.	Description	Icons	Page
1	Recording mode		p. 21
2	Optical / Digital Zoom bar / Digital Zoom rate		p. 31
3	Voice Memo		p. 57
4	Number of available shots remaining	00001	p. 17
	Remaining time	00:00:00	p. 17
5	Memory card icon / Internal memory icon		-

No.	Description	Icons	Page
6	Battery		p. 15
7	Flash		p. 40
8	Self-timer		p. 42
9	Macro		p. 37
10	Dynamic Range		p. 51
11	Photo Style Selector		p. 54
12	Face Detection		p. 47
13	Camera shake compensation / Without Sound		p. 56/59
14	Date / Time	2009/01/01 PM 01:00	p. 66
15	Camera shake Warning		p. 29
16	Auto Focus Frame		p. 53
17	Auto Focus type		p. 53
18	Drive mode		p. 52
19	Metering		p. 51
20	Image Quality / Frame Rate	RAW	p. 50
21	Image Size	12M	p. 50
22	ISO / Face Retouch	150	p. 46/25
23	White Balance / Face Tone		p. 45/25
24	Aperture Value/Shutter Speed/ Exposure compensation	F2.8	p. 23-24/ 34
25	Flash EVC		p. 53
26	Locking the Exposure/ Locking the Focus	AE	p. 57
27	Histogram		p. 37

How to use the menu

1. Turn on the camera and press the MENU button. A menu for each camera mode appears.

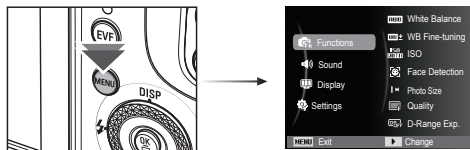

2. Use the up or down buttons to navigate through the menus.

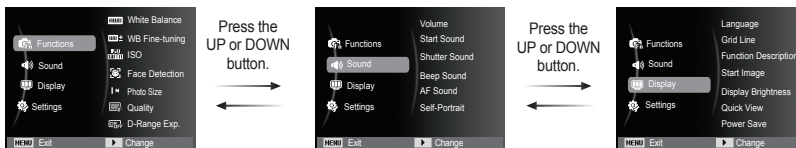

3. Use the left or right buttons to select a sub menu.

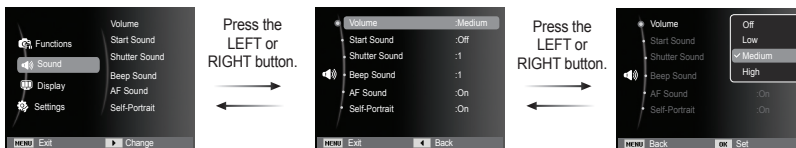

4. Select a submenu and click the OK button to save settings and return to the previous window.

Starting the recording mode

Selecting modes



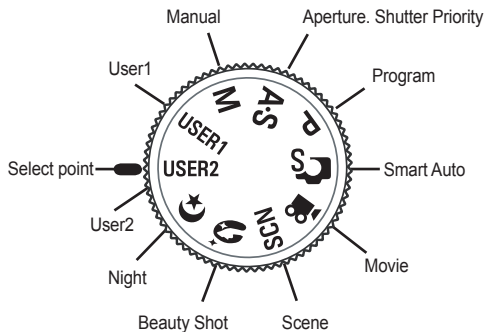

You can select the shooting modes by using the mode dial on the upper of your camera.

■ How to use the mode dial

Select the shooting mode by turning the mode dial to the selection point.



■ Shooting modes

	Smart Auto	The appropriate option can be set automatically for a shooting scene by recognizing shooting scenes.
P	Program	Various shooting options can be set manually.
A/S	Aperture. Shutter Priority	Aperture values or shutter speed can be set manually.
M	Manual	Various shooting options, including the shutter speed and the aperture values, can be set manually.
USER1 USER2	User	Frequently used shooting options can be preset.
	Night	This mode can be used at night or in poor lighting conditions.
	Beauty Shot	The skin tone of a subject can be corrected.
SCN	Scene	The appropriate options for shooting scenes are preset per scene.
	Movie	Movies can be recorded.

Starting the recording mode

How to use the Smart Auto mode()











The camera automatically chooses the appropriate camera settings based on a detected type of scene. It will be helpful if you are not familiar with the camera settings for various scenes.

1. Select Smart Auto mode by using the Mode dial. (p.21)
2. Point the camera towards the subject and compose the image by using the LCD monitor.
3. Press the Shutter button to capture an image.



-  If the camera does not recognize a proper scene mode, the default settings will be used.
- Even if there is a face detected, the camera may not select a portrait mode depending on the subject's position or lighting.
- The camera may not select the correct scene depending on shooting environments, such as camera shake, lighting, and distance to the subject.
- The [Night] mode recognizes scenes only when the flash is set to off. The camera operates the [Tripod] mode after checking the shooting condition on the tripod for a certain time.
- Despite using a tripod, the camera may not select a tripod mode depending on the subject's movement.

■ Each scene is recognized in the following conditions;

- [Landscape] () : When shooting outdoor scenes
- [White] () : When shooting in a very bright environment
- [Night] () : When shooting the nighttime scenes
- [Night Portrait] () : When shooting people in a dark outdoor place
- [Backlight] () : When shooting a backlit scenery without a portrait
- [Backlight Portrait] () : When shooting a backlit portrait
- [Portrait] () : When shooting a portrait
- [Macro] () : When shooting close-ups
- [Macro Text] () : When shooting texts in a close focus
- [Tripod] () : When shooting a subject without any movement on the tripod
- [Action] () : When shooting a subject making frequent movements

Starting the recording mode

How to use the Program mode (P)

Selecting the Smart Auto mode will configure the camera with optimal settings. You can still manually configure all functions.

1. Select the Program mode by using the Mode dial. (p.21)
2. Press the Menu button to configure advanced functions.



How to use the Aperture. Shutter Priority mode (A-S)

When the user configures the aperture value or shutter speed, an appropriate aperture value or shutter speed is configured automatically. When the user configures an aperture value, the camera adjusts the shutter speed automatically. When the user selects the shutter speed, the camera selects an aperture value for optimal exposure.

1. Select the Aperture. Shutter Priority mode by using the Mode dial. (p.21)
2. Select an aperture value or shutter speed by turning the Smart Dial. An "A" icon will appear on the selected item.
3. Select the aperture value or shutter speed by pressing the left or right button and then adjust a desired value by turning the Smart Dial.
4. Point the camera towards the subject and compose the image by using the LCD monitor.
5. Press the Shutter button to capture an image.



Starting the recording mode

How to use the Manual mode (**M**)

The user can manually set both the aperture value and the shutter speed.

1. Select the Manual mode by using the Mode dial. (p.21)
2. Select an aperture value or shutter speed by turning the Smart Dial. An "M" icon will appear on the selected item.
3. Select the aperture value or shutter speed by pressing the left or right button and then adjust a desired value by turning the Smart Dial.
4. Point the camera towards the subject and compose the image by using the LCD monitor.
5. Press the Shutter button to capture an image.



How to use the User Setting shooting mode (**1 USER 2 USER**)

The user's own shooting mode can be used by saving the shooting options which are configured in the [Program], [Aperture. Shutter Priority] and [Manual] modes.

See page 60 to see how to set the User mode.

1. Set a User setting mode (User 1, User 2) by turning the Mode Dial. (p.21)
2. Point the camera towards the subject and compose the image by using the LCD monitor.
3. Press the Shutter button to capture an image.



Starting the recording mode

How to use the Nightscene modes ()

Select this mode at night or in low light conditions.

1. Select the Nightscene mode by using the Mode dial. (p.21)
2. Point the camera towards the subject and compose the image by using the LCD monitor.
3. Press the Shutter button to capture an image.



How to use the Beauty Shot mode ()

Take a photo of portraits by setting options to clear facial imperfections.

1. Select the Beauty Shot mode by using the Mode dial. (p.21)
2. Press the Up/Down button in [Functions] menu to select [Face Tone] or [Face Retouch].
3. Press the Left/Right button to select a desired level of [Face Tone] or [Face Retouch] features. And then press the OK button.
4. Press the Shutter button to capture images.



Starting the recording mode

How to use the Scene modes ()

Use the menu to easily configure optimal settings for a variety of shooting situations.







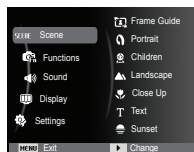



1. Select the Scene mode by using the Mode dial. (p.21)
2. Press the Left/Right button to select the desired mode.
3. Point the camera towards the subject and compose the image by using the LCD monitor.
4. Press the shutter button to capture an image.



※ To change the Scene mode, press the MENU button and select a desired scene menu.



The scene modes are listed below.

- [Frame Guide] () : Use this mode when you want someone else to take a picture for you from the angle you choose.
- [Portrait] () : To take a picture of a person.
- [Children] () : To take a picture of fast moving objects, for example, children.
- [Landscape] () : To take pictures of distant scenery.
- [Close Up] () : Close-up shooting for small objects such as plants and insects.
- [Text] () : Use this mode to shoot a document.
- [Sunset] () : For taking pictures of sunsets.
- [Dawn] () : Daybreak scenes.
- [Backlight] () : Portrait without shadows caused by backlight.
- [Firework] () : Firework scenes.
- [Beach&Snow] () : For ocean, lake, beach and snowscape scenes.

Starting the recording mode

■ How to use the [Frame Guide] mode

Set [Frame Guide] mode when you want someone else to take a picture for you from the angle you choose.

1. Take a picture from the angle you choose.
- A guide appears round the sides of the picture.

Guide



2. Then another person can take the picture by aligning the edge of the picture to be taken with the guide framing the sides of the window.

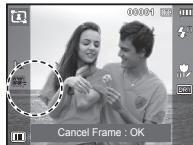
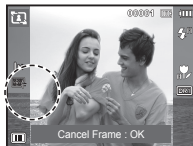

How to use the Movie clip mode ()

A movie clip can be recorded for as long as the available recording time(maximum 20 minutes at once) of the memory capacity allows.

1. Select the Movie clip mode by using the Mode dial. (p.21)
2. Point the camera towards the subject and compose the image by using the LCD monitor.
3. Press the shutter button once and movie clips are recorded for as long as the available recording time allows. Movie clips will still be recorded if the shutter button is released. If you wish to stop recording, press the shutter button again.



- ※ The user can shoot movies when pressing the movie shooting button in the shooting mode and the playback mode. When the user presses the movie shooting button once more, the function for shooting a movie is disabled.



- ※ Image size and type are listed below.
 - Image size: 1280X720HQ, 640x480, 320x240 (1280X720HQ are the settings for recording high-quality videos.)
 - Movie clip file type: H.264(MPEG4.AVC)
 - Frame Rate: 60FPS, 30FPS, 15FPS

-  Select [Zoom Mute] from the recording menu during video recording to disable the recording of zoom sound.

Starting the recording mode

Recording HD (High Definition) movie clips

You can record HD (High Definition) movie clips. (1280X720HQ, 30 fps)
H.264(MPEG4.AVC) is a standard for the digital video codec.
It supports a high quality movie clip in a small file size.

1. Select the Movie clip mode by using the Mode dial. (p.21)
2. Press the Fn button to set the resolution to [1280HQ].
3. Press the Shutter button to record video for the available recording time.

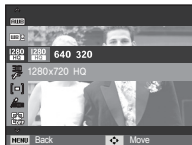

- What is **H.264(MPEG4 part10/AVC)**?

With its high-compression rate and the small file size, it is a standard for the digital video codec. It supports the recording functions in a high resolution.

Recording the movie clip without sound

You can record the movie clip without sound.

Steps from 1 -3 are the same as those for MOVIE mode.

4. Press the Menu button.
5. Press the Up / Down button to select the [Functions] menu and press the Right button.
6. Select the [Voice] menu by pressing the Up / Down button and press the OK button.
7. Select the [Off] menu by pressing the Left / Right button.
8. Press the OK button. You can record a movie without sound.

※ See p.59 for further details.



Things to Watch Out for When Taking Pictures

- Pressing the shutter button half way.
Lightly press the shutter button to confirm focus and flash battery charge. Press the shutter button all way down to take the picture.

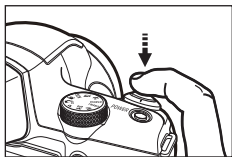

[Lightly press the shutter button]

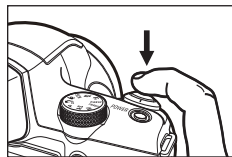

[Press the shutter button]

- The available memory capacity may vary depending on shooting conditions and camera settings.
- When shooting in low lighting conditions, the camera shake warning indicator () may appear on the LCD monitor. In this case, use a tripod, support the camera on a solid surface or change to flash shot mode.
- Shooting against the light : It is best to take pictures with the sun in the background. Taking pictures against the sun may make the picture come out dark. To take a picture against the light, please use the [Backlight] in scene shooting mode (see page 22), fill-in flash (see page 41), spot metering (see page 51), exposure compensation (see page 34) or ACB (see page 81) function.

- Avoid obstructing the lens or the flash when you capture an image.
- Compose the image by using the LCD monitor.
- Under certain conditions the auto focus system may not perform as expected.
 - When photographing a subject that has little contrast.
 - If the subject is highly reflective or shiny.
 - If the subject is moving at high speed.
 - When there is strong reflected light, or when the background is very bright.
 - When the subject matter has only horizontal lines or the subject is very narrow (such as a stick or flagpole).
 - When the surroundings are dark.

Focus lock

To focus on a subject not positioned in the centre of the picture, use the focus lock function.

■ Using the Focus Lock

1. Ensure the subject is in the centre of the autofocus frame.
2. Press the SHUTTER button halfway. When the green auto focus frame lights up, it means the camera is focused on the subject. Be careful not to press the SHUTTER button all the way down to avoid taking an unwanted picture.
3. With the SHUTTER button still pressed down only halfway, move the camera to recompose your picture as desired, and then press the SHUTTER button completely to take the picture. If you release your finger from the SHUTTER button, the focus lock function will be cancelled.



1. The image to be captured.



2. Press the SHUTTER button halfway and focus on the subject.



3. Recompose the picture and fully depress the SHUTTER button.

Using the camera buttons to set the camera

The recording mode function can be set up by using the camera buttons.

POWER button

Used for turning the camera's power on / off. If there is no operation during the specified time, the camera's power will be turned off automatically to save battery life. Refer to page 67 for more information about the auto power off function.

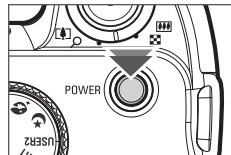

SHUTTER button

Used for taking an image or recording voice in the RECORDING mode.

- In MOVIE CLIP mode

Pressing the shutter button down fully starts the process for recording a movie clip. Press the shutter button once and the movie clip is recorded for as long as the available recording time in the memory allows. If you wish to stop recording, press the shutter button again.

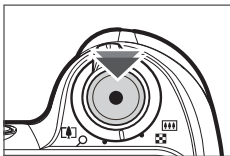

- In STILL IMAGE mode

Pressing the shutter button halfway activates the autofocus and checks the condition of the flash. Pressing the shutter button down fully takes and stores the image. If you select voice memo recording, the recording will start after the camera has finished storing the image data.

Zoom W/T Lever

If the menu is not displayed, this lever works as the OPTICAL ZOOM or DIGITAL ZOOM lever.

This camera has a 24X optical zoom and a 5X digital zoom function. Using both will offer a total zoom ratio of 120X.

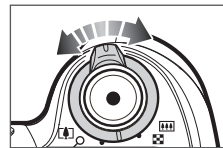

- TELE Zoom

Optical zoom TELE : Move the Zoom W/T lever to the right to see the subject closer.

Digital zoom TELE : Move the Zoom W/T lever to the right once again in optical 24x zoom mode to enable digital zoom (software tele). Stop moving the Zoom W/T lever to stop the operation of digital zoom (tele). In digital 5x zoom mode, digital zoom is disabled even if you operate the Zoom W/T lever.



[WIDE zoom]



[TELE zoom]



[Digital zoom 5.0X]

Zoom W/T Lever

■ WIDE Zoom

Optical zoom WIDE : Move the Zoom W/T lever to the left in optical zoom mode to see subjects in the distance. Continue to move the Zoom W/T lever to the left to disable optical zoom.



[TELE zoom]



[Optical zoom 2X]



[WIDE zoom]

Digital zoom WIDE : Move the Zoom W/T lever to the left in digital zoom mode to enable digital zoom (software wide). Stop moving the Zoom W/T lever to stop the operation of digital zoom. Continue to move the Zoom W/T lever to the left when digital zoom is disabled to disable optical zoom (optical tele).

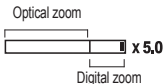

[Digital zoom 5.0X]



[TELE zoom]



[WIDE zoom]



- If the Zoom W/T lever is fully turned, the zoom adjusts quickly. If the Zoom W/T lever is turned a little, the zoom adjusts slowly.
- Images taken using the digital zoom may take a little longer for the camera to process. Allow time for this to take place.
- Zooming during video recording may record operation sound of the Zoom W/T lever.
- Select [Zoom Mute] from the recording menu during video recording to disable the recording of zoom sound.
- You may notice a decrease in image quality when using the digital zoom.
- To view a clearer digital zoom image, press the shutter button halfway at the maximum optical zoom position and move the Zoom W/T lever to the right again.
- The digital zoom can't be activated in the [Face Detection], [Beauty Shot], [Smart Auto], [Movie] and some Scene modes.
- Take care not to touch the lens to avoid taking an unclear image and possibly causing camera malfunction. If the image is dim, turn the camera power off and on again to modify the lens position.
- Take care not to press the lens as this may cause a camera malfunction.
- When the camera is turned on, take care not to touch the camera's moving lens parts as this may cause the resulting image to be dim and unclear.
- Take care not to touch the lens while operating the Zoom W/T lever.

Diopter adjustment lever

When the electronic viewfinder is out of focus, the user can achieve the clearest focus by turning the diopter adjustment lever. (p.35)

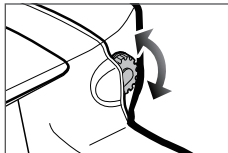

AEL/Image protection button (O-T)

An exposure value can be saved prior to shooting when the AEL button is pressed. When a subject is too small to obtain the appropriate exposure or for backlight shots, this button can be used.

The AEL button can be used for AFL, AEL/AFL, and AF (see page 57 for setting procedure). In the playback mode, this button can be used as an image protection button (O-T) (p. 86).

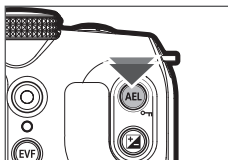

Flash pop-up button

When a background is brighter than a subject, or when intentionally turning on the flash, e.g. backlight shooting or shooting in poor lighting conditions, the user must pop up the flash by pressing the flash pop-up button.

See page 40 to set the desired flash mode for a shooting situation when using the flash.

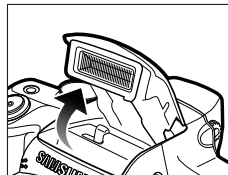

Precautions when using built-in flash

- Do not attempt to open the built-in flash forcibly, as it may damage the camera.
- Ensure that the flash is always closed when it is not used. If the flash is pushed backwards, it may damage the flash.

Exposure compensation button

This camera adjusts the appropriate amount of exposure automatically for a shooting situation. The user can use the exposure compensation button to shoot with excessive exposure (bright images) or insufficient exposure (dark images). The range of exposure compensation is -2 to +2 (EV), and can be set with intervals of 1/3 EV.

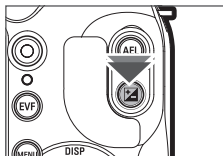

■ How to set exposure compensation

1. Press the exposure compensation button in the shooting mode.
2. Set a desired exposure compensation value by using the LEFT/RIGHT buttons or the Smart Dial.
3. Press the OK button to save a configured value and the setting for exposure compensation is complete. The exposure compensation icon (☒) appears on the LCD monitor after setting the exposure compensation, if the exposure compensation value is not 0.0EV.



※ Note that the LCD monitor looks blurry or good images can't be obtained if [+] exposure compensation is made. If [-] exposure compensation is made, exposure becomes insufficient.

- Exposure compensation setting is available in the [Program], [Aperture. Shutter Priority] and [Movie] modes.

EVF/LCD button

The user can shoot with the electronic viewfinder when it is difficult for the user to see the LCD display due to bright lighting.

The user can switch between EVF and LCD by pressing the EVF/LCD button.

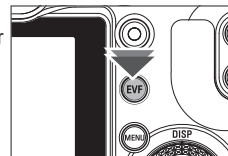

[LCD monitor]

[Press the EVF/LCD button.]

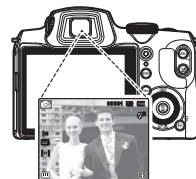

[Electronic viewfinder]

EVF/LCD button

■ Using the electronic viewfinder (EVF)

The electronic viewfinder shows the same display as the LCD monitor, and is used when it is difficult for the user to see the LCD monitor due to bright lighting. Pressing the EVF/LCD button will switch between the electronic viewfinder and the LCD monitor. The display remains the same when the camera is turned off or when the user selects another mode with the Mode Dial.

When the electronic viewfinder is out of focus, turn the diopter adjustment lever to obtain the clearest image.

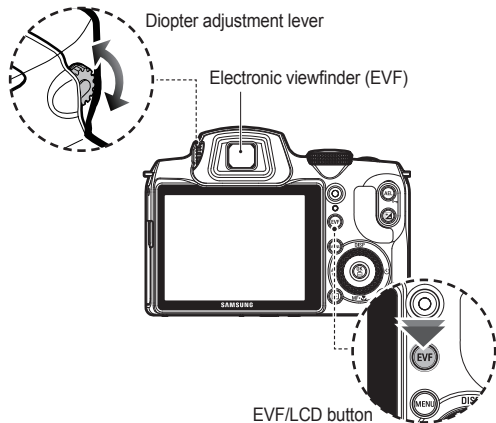

MENU button

- When you press the MENU button, a menu related to each camera mode will be displayed on the LCD monitor. Pressing it again will return the LCD to the initial display.
- The menu screen is available in the [Smart Auto], [Program], [Aperture. Shutter Priority], [Manual], [Night], [Beauty Shot], [Scene] and [Movie] modes, but it is not available in the voice recording function.

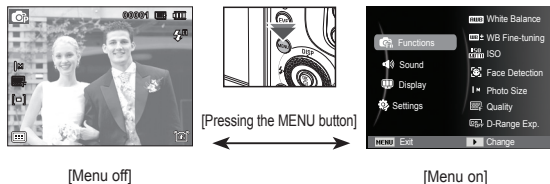

OK/AF point button (OK)

When the menu is displayed on the LCD monitor, this button is used for shifting the cursor to the sub menu or for confirming data.

This button is used when moving to or saving the changed data on the menu screen.

Press the UP/DOWN/LEFT/RIGHT buttons to shift the AF points.

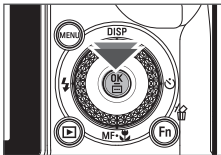

[Pressing the OK button]

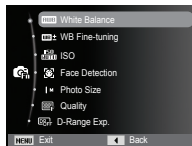

Info (DISP) / Up button

While the menu is showing, the Up button operates as a direction button. In the recording modes or playback mode, pressing this button will display the image information.



[Filming screen]



[Histogram/Grid Window]



[Information screen]

-  • Histogram is not displayed when setting the [Face Detection] function.

Info (DISP) / Up button

■ Histogram/Grid Window ()

Histogram

Histogram shows you the distribution of brightness in recorded images. If the bars in the histogram are higher towards the right, the image may be too bright. If the bars are higher on the left, the image may be too dark. If the lighting conditions are too bright to check the subject by using the LCD, checking the histogram will enable more precise exposure control for the shots.

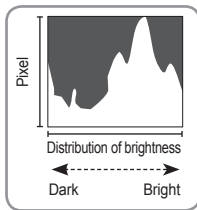

Grid

If you focus on the subject using a variety of horizontal or vertical grids, you will be able to take pictures at better angles, checking size, horizontality, or proportions. For information on types of grid and how to set them, refer to Page 63.

Macro () / Down button

While the menu is showing, the DOWN button operates as a direction button.

When the menu is not showing, you can use the MACRO () / DOWN button to take macro pictures.

The focus ranges are shown on the next page.

Press the Macro button until the desired macro mode indicator appears on the LCD monitor.



[Auto Focus]



[Macro ()]



[Auto Macro ()]



[Super Macro ()]



[Manual Focus ()]

Macro (🌸) / Down button

■ How to Set Focus Manually

If it is difficult to get the automatic focus to work (for example in low light), you can manually control the focus.

1. Press the Macro button to enable manual focus.
- Then the control bar for manual focus will appear.
2. Press the Left/Right button to control the focus as you want.



Control Bar for Manual Focus

※ Set the manual focus to expand the center of the window to the entire window. Press the shutter button halfway down to return to the initial state.

- Note that the picture may be blurred if manual focusing is not performed properly.

■ Types of focus mode and focus range

(Unit: cm)

Mode	Program (P) / Aperture. Shutter Priority (A-S) / Manual (M)				
Focus Type	Normal	Auto Macro	Macro	Super Macro	Manual Focus
Focus range	Wide	Wide	Wide	1 ~ 10	10 ~ Infinity
	80 ~ Infinity	10 ~ Infinity	10 ~ 80		
	Tele	Tele	Tele		
	170 ~ Infinity	170 ~ Infinity	80 ~ 150		



- When the macro mode is selected, be particularly careful to avoid camera shake.
- When using the Super Macro function, you cannot operate the zoom and adjust the zoom magnification rate.

Macro (🌸) / Down button

- Available focusing method, by recording mode
(o : Selectable, ∞ : Infinity focus range)

Mode	Normal	Auto Macro	Macro	Super Macro	Manual Focus
	o		o	o	o
	o		o	o	o
	o		o	o	o
	o				
		o			
	o		o	o	
	o		o	o	o
	o		o	o	o





- Focus range is automatically selected in [Smart Auto] mode.

Mode	SCENE				
	Normal	Auto Macro	Macro	Super Macro	Manual Focus
		o			
	o				
	o				
	o				
			o		
		o			
	o				
	o				
	o				
	o				
	∞				
	o				

Flash () / Left button

When the menu is displayed on the LCD monitor, pressing the LEFT button makes the cursor shift to the left tab.

When the menu is not displayed on the LCD monitor, the flash () /LEFT button operates as the flash () button.

■ Selecting the flash mode

1. Press the Flash pop-up button to pop up the flash.
 2. Select the desired Recording mode, except for the [Movie] mode. (p.21)
 3. Press the Flash button until the desired flash mode indicator is displayed on the LCD monitor.
 4. A flash mode indicator will be displayed on the LCD monitor. Use the correct flash to suit the environment.
- ※ You can control the flash intensity in the [Functions] menu. (p.53)



- If you press the shutter button after selecting the flash, the first flash fires to check the shooting condition (Flash range and Power ratio of flash). Do not move the camera until the second flash fires.
- Using the flash frequently will reduce the life of the battery.
- Under normal operating conditions the re-charging time for the flash is usually within 5 seconds. If the battery is weak, the charging time will be longer.
- The camera flash does not operate in the [Movie] and some Scene modes.
- Take photographs within the flash range.
- The image quality is not guaranteed if the subject is too close or highly reflective.
- When taking an image in poorly lit conditions with the flash, there may be a white speck in the captured image. The speck is caused by the flash light reflecting off atmospheric dust.
- If flash doesn't pop up, can not use the flash.



■ Flash range

(Unit: m)

	Shooting range		ISO
	Wide	Tele	
Normal	0.3 ~ 6.0	1.7 ~ 3.0	AUTO
Auto macro	0.3 ~ 6.0	1.7 ~ 3.0	
Macro	0.3 ~ 0.8	0.8 ~ 1.5	
Super Macro	-		
Manual Focus	0.3 ~ 6.0	1.7 ~ 3.0	

Flash () / Left button

■ Flash mode indicator

Icon	Flash mode	Description
	Auto flash	If the subject or background is dark, the camera flash will operate automatically.
	Auto & Red eye reduction	If a subject or background is dark, the camera flash will work automatically and will reduce the red-eye effect by using the red-eye reduction function.
	Fill in flash	The flash fires regardless of the available light. The intensity of the flash will be automatically controlled to suit the prevailing conditions.
	Slow synchro	The flash operates with a slow shutter speed to obtain a balanced correct exposure. In poor lighting conditions the camera shake warning indicator () will display on the LCD monitor.
	Red-eye reduction	When a shot with "red eye" is detected, this mode will reduce the red-eye effect automatically.
	Flash off	The flash does not fire. Select this mode when capturing images in a place or situation where flash photography is prohibited. When you capture an image in poorly lit conditions, the camera shake warning indicator () will appear on the LCD monitor.

■ Available flash mode, by recording mode (o : Selectable)

Mode						
	o	o	o	o	o	o
			o	o		o
			o			o
				o	o	o
		o			o	o
						o
Mode	SCENE					
	o				o	o
		o			o	o
		o				o
						o
						o
						o
						o
						o
			o			
						o
	o					

- Smart Auto Flash () icon will appear in [Smart Auto] mode.

Self-timer () / Right button

When the menu is displayed on the LCD monitor, pressing the Right button makes the cursor shift to the right tab.

When the menu is not displayed on the LCD monitor, the RIGHT button operates as the Self-timer () button. This function is used when the photographer would also like to be in the image.



- If you operate the Self-timer button during the self-timer operation, the self-timer function is cancelled.
- Use a tripod to prevent the camera from shaking.
- In [Smart Auto], [Frame Guide], [Movie] mode, only the 10SEC self-timer will work.

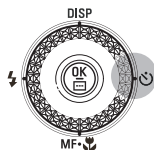

■ Selecting the self-timer

1. Select a Recording mode with the exception of Voice recording mode. (p.21)
2. Press the SELF-TIMER / RIGHT () button until the desired mode indicator displays on the LCD monitor.
A 10 second, 2 second or Double Self-timer icon appears on the LCD monitor.
3. When you press the SHUTTER button, the picture will be taken after the specified time has elapsed.

















































































































































[Selecting the 10 SEC self-timer]

































■ Self-timer mode indicator

Icon	Mode	Description
	10SEC self-timer	Pressing the shutter button will allow an interval of 10 seconds before the image is taken.
	2SEC self-timer	Pressing the shutter button will allow an interval of 2 seconds before the image is taken.
	Double self-timer	A picture will be taken after about 10 seconds and 2 seconds later a second picture will be taken. When using the flash, the 2-second self-timer may be delayed for longer than 2 seconds depending on the flash charging time.

Functions (Fn)

Use the menu that enables the functions, or the Fn button, to bring up the menus below:

Mode	Menu	Available mode	Page
 (Functions)	White Balance	   	p.45
	WB Fine-tuning	   	p.46
	ISO	  	p.46
	Face Detection	      	p.47-49
	Face Tone		p.49
	Face Retouch		
	Photo Size / Movie Size	                     	p.50
	Quality / Frame Rate	                     	p.50
	D-Range Exp.	      	p.51
	Metering	    	p.51
	Drive	    	p.52
	AEB Area	  	p.52
	Focus Area	                    	p.53
	Flash EVC	  	p.53
	Photo Style Selector	          	p.54
Image Adjust	  	p.55	
Image Stabiliser	                    	p.56	

Mode	Menu	Available mode	Page
 (Functions)	Key mapping	  	p.57
	Voice	                   	p.57-59
	Distortion Control	   	p.59
	User Mode Set	  	p.60
	Stabilizer		p.60

Functions (Fn)

How to Enable Functions Using the MENU Button

1. Press the MENU button in an available mode.
2. Press the Up / Down button to select the [Functions] menu and press the Right/OK button.

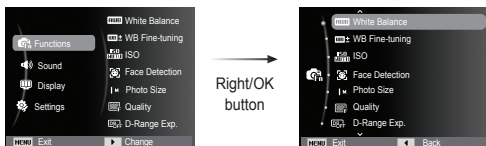

3. Select a desired menu by pressing the Up / Down button and then press the OK button.

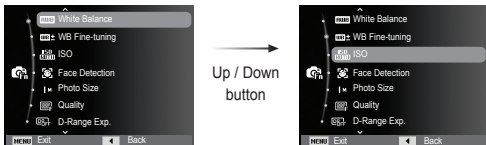

4. Select a desired menu by pressing the Left / Right button and then press the OK button.

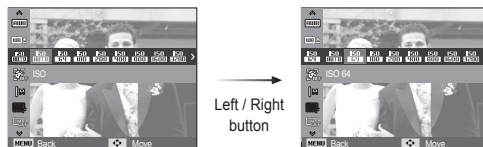







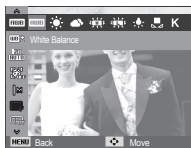

 Use the Fn button on the rear of the camera to bring up the menus that enable frequently used functions faster.

Functions ()

White balance

The white balance is a function that makes adjustments in accordance with the lighting conditions and colours of a scene so that the white in the photograph appears white. The white balance control allows you to adjust the colours to appear more natural depending on the lighting conditions.



Mode	Icon	Description
Auto WB		The camera automatically selects the appropriate white balance settings, depending on the prevailing lighting conditions.
Daylight		For taking images outside.
Cloudy		For taking images under a cloudy and overcast sky.
Fluorescent_H		For shooting under daylight fluorescent types of three-way fluorescent lighting.
Fluorescent_L		Shooting under white fluorescent lighting.
Tungsten		For shooting under tungsten (standard light bulb) lighting.
Custom Set		Allows the user to set the white balance according to the shooting condition.
Color Temperature	K	Allows the user to set the desired colour temperature according to the shooting condition.

※ Different lighting conditions may cause a colour cast on your images.

■ Using the Custom White Balance

White balance settings may vary slightly depending on the shooting environment. You can select the most appropriate white balance setting for a given shooting environment by setting up the custom white balance.

1. Select the CUSTOM () menu of the White Balance and place a sheet of white paper in front of the camera so that the LCD monitor shows only white.

2. OK button : selects previous custom white balance.
Shutter button : saves new custom white balance.

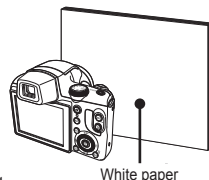

- The custom white balance value will be applied, starting with the next picture you take.
- The user configured white balance will remain effective until it is overwritten.

Functions ()



What is colour temperature?

The colour of the light changes to blue when the colour temperature goes up, but it changes to red when the colour temperature goes down. The change in the colour of the light is indicated in kelvins (K) and is called the colour temperature. This camera allows the user to set the white balance settings to shoot with natural colours in the variety of lighting conditions.

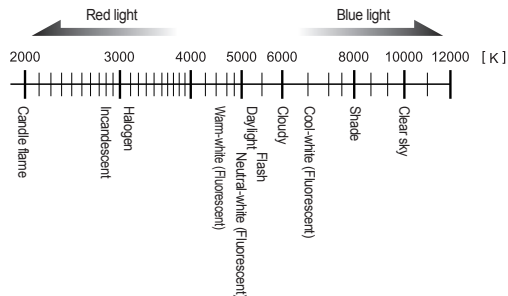

Fine-tuning the white balance

Press the UP/DOWN/LEFT/RIGHT buttons to adjust the desired white balance. Seven levels (196 patterns) are available on the G-M and B-A axis.

- G: Green
- A: Amber
- M: Magenta
- B: Blue

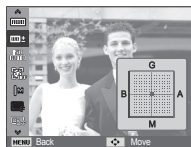

ISO

You can select the ISO sensitivity when taking pictures. The speed or specific light-sensitivity of a camera is rated by ISO numbers.



[Auto] : The camera's sensitivity is automatically changed by variables such as lighting value or subject brightness.

[ISO 64, 100, 200, 400, 800, 1600, 3200, 6400] :

You can increase the shutter speed while the same amount of light is present, by increasing the ISO sensitivity. However, the image may be saturated in high luminance.

The higher the ISO value, the higher the camera's sensitivity to light and therefore the greater its capacity to take pictures in dark conditions. However, the noise level in the image will increase as the ISO value increases, making the image appear coarse.

- ※ When [Motion Capture] is set, ISO speed will be set to Auto.
- ※ ISO setting is available in the [Program], [Aperture. Shutter Priority] and [Manual] modes.
- ※ ISO 3200 and ISO 6400 can be set below 5M and 3M respectively.

Functions ()

Face Detection

If you use face detection options, your camera can detect a human face. When focusing on a human face, the brightness of the face is also adjusted. You can also capture natural facial expressions by using self portrait.

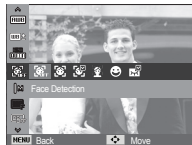

※ Selectable modes: Program, Aperture, Shutter Priority, Manual, Beauty Shot, Portrait, Children, Beach & Snow

■ Normal

This mode detects the face position of the subject automatically and then sets the focus and exposure. Select this mode for quick and easy face picture.

1. The size and position of the auto focus frame is set at the face of the subject automatically.



2. Press the shutter button halfway.
The focus frame turns to green when the focus is activated.

3. Press the shutter button fully to take a picture.

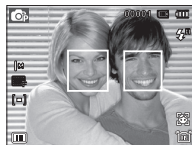

- This function can detect up to 10 persons.
- When the camera recognises many people at the same time, it will focus on the nearest person.
- The Digital zoom is not activated in this mode.
- When the camera detects a target face, the white colour focus frame will be displayed over the target face and the grey colour focus frame appears over the remaining faces. Press the shutter button halfway down to focus on the face and the white focus frame turns green.
- Return to previous AF mode if face detection was failure.
- In some conditions this function cannot work properly.
 - When a person wears dark glasses or some part of the face is hidden.
 - When the person being taken does not look at the camera.
 - Camera doesn't detect a face as the brightness is too dark or too bright.
 - The distance between the camera and object are far.
- The maximum available Face Detection range is 2.5m (Wide).
- The nearer the subject, the faster the camera can recognize the subject.
- In [Beauty Shot], [Portrait], and [Children] mode, the [Face Detection] function setting is set to its default value.

Functions ()

■ Smart face detection

The camera registers the frequently detected faces of up to 17 people. Focus and exposure for the registered faces are adjusted automatically in order of priority. The order of priority for the registered faces can be checked in graphs. However, the smart face detection function is available only when inserting an external memory card.

- When a registered face is not detected:
operates the same as with the face detection function.

- When a registered face is detected:
a priority level is indicated on the detected face.

- When more than two registered faces are detected:
order of priority is indicated on the detected faces.



-  • The same person can be recognised as a different person and vice versa depending on glasses, brightness, extreme change of pose or facial expressions.
- If you register a new face when 17 faces are already registered, the 17th face with the lowest priority is switched with the newly added face.

- A maximum of 3 people can be registered in a scene.
- If the camera doesn't recognise a registered face, it detects the face regardless of the priority.
- Even though a face is not registered, a face detection graph may appear if the face detection ratio is good.
- Categorizing pictures is available in the playback mode according to the priority of faces (p. 73).
- Even though a face is recognised, it may not be categorized in the Smart Album according to the priority.
- Faces can be registered manually in the playback mode (p. 87).

■ Self Portrait

When taking pictures of yourself, the area of your face is automatically detected so that you can take self pictures more easily and quickly.

1. For self-filming, set the camera lens towards the face of the object. It automatically detects the face of the object, and emits a guiding sound.
2. Start filming by pressing the shutter button.



-  • When locating the face in the center of the screen, it repeatedly emits a faster sound unlike the sounds that are emitted when the face is not in the center.
- The guiding sound can be set using the sound setting menu. (p.62)

Functions (Fn)

■ Smile Shot

The camera automatically takes a picture by detecting the face of the subject although you don't press the shutter button. If you press the Shutter button, the picture is taken in the normal way. When taking a picture of smile shot, showing teethes or keeping the smiley face of your subject helps detecting the smile face of the subject.



■ Blink Detection

If the eyes of the subject are closed when the shutter button is pressed, the camera takes 2 continuous shots and then the images are saved. The camera takes only one picture if the eyes of the subject are open when the Shutter button is pressed.



- Detecting the smiling face or the blinking eyes may not be available if any of the following situations occurs:
 - If the subject is wearing sunglasses.
 - When the subject is not facing directly to the camera.
 - If the environmental light is too bright or too dark to detect the face of the subject.
 - When the camera is far from the subject. (Orange colored focusing mark)
 - If there is reflection of the light or the back light that are too bright.

Face Tone

This menu allows you to control the skin tone in images in beauty shot mode. The higher the level you select, the brighter the skin tone.

1. Select [Face Tone] by pressing the Up/Down button.
2. Select a desired face tone by pressing the Left / Right button and then press the OK button.
3. Press the Shutter button to take an image.



Face Retouch

This menu allows you to make skin appear clear and beautiful before recording in beauty shot mode. The higher the level selected, the more effective the control.

1. Select [Face Retouch] by pressing the Up/Down button.
2. Select a desired face retouch by pressing the Left / Right button and then press the OK button.
3. Press the Shutter button to take an image.

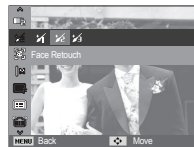

Functions (Fn)

Image Size

You can select the image size appropriate for your application.

(Unit: pixel)

Still image mode							
Icon	12M	10M	9M	8M	5M	3M	1M
Size	4000x3000	3984x2656	3968x2232	3264x2448	2592x1944	2048x1536	1024x768

Movie clip mode			
Icon	1280 HQ	640	320
Size	1280x720HQ	640x480	320x240

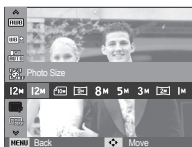

[STILL IMAGE mode]

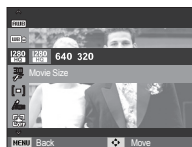

[MOVIE CLIP mode]



- The higher the resolution, the lower the number of shots available because high resolution images require more memory.

Quality / Frame rate

You can select the compression ratio appropriate for your application of the captured images. The higher the compression ratio, the lower the picture quality.

Mode	STILL IMAGE mode						
Icon	RAW	+RAW	+RAW	+RAW	5F	F	n
Sub menu	RAW	RAW + S.Fine	RAW + Fine	RAW + Normal	Super Fine	Fine	Normal
File Format	DNG	DNG+JPEG	DNG+JPEG	DNG+JPEG	jpeg	jpeg	jpeg

Mode	MOVIE CLIP mode		
Icon	60 F	30 F	15 F
Sub menu	60 FPS	30 FPS	15 FPS
File Format	H.264	H.264	H.264



[STILL IMAGE mode]

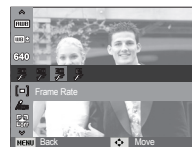

[MOVIE CLIP mode]



- This file format complies with the DCF (Design rule for Camera File system).
- JPEG (Joint Photographic Experts Group) : JPEG is the image compression standard developed by the Joint Photographic Experts Group. This type of compression is most commonly used for compressing photos and graphics because it can compress the files efficiently.

Functions (Fn)

Dynamic range

The dynamic range can be set to an image for shooting. When you use the dynamic range, detailed expressions of dark areas and bright areas can be achieved. The level of brightness adjustment of [D-Range Exp.2] is set higher than [D-Range Exp.1]

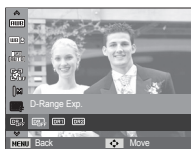

- If the dynamic range is set too high, a noise may occur.

Metering

If you cannot obtain suitable exposure conditions, you can change the metering method to take brighter pictures.

[Multi] (☐) : Exposure will be calculated based on an average of the available light in the image area. However, the calculation will be biased towards the centre of the image area. This is suitable for general use.

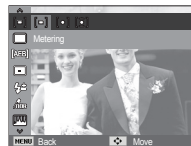

[Spot] (•) : Only the rectangular area in the centre of the LCD monitor will be metered for light. This is suitable when the subject in the centre is exposed correctly, regardless of the back lighting.

[Center Weighted] (☺) : Exposure will be calculated based on an average of the available light in the image area. However, the calculation will be biased towards the centre of the image area. This is suitable for taking a picture of small object like a flower or insects.

※ If the subject is not the centre of the focus area, do not use the spot metering as this may result in an exposure error. In this circumstance, it is better to use exposure compensation.

Functions (Fn)

Drive mode

You can select continuous shot, and AEB (Auto Exposure Bracketing).

[Single] (📷) : Take one picture only.

[Continuous] (📷) : Images will be taken continuously until the shutter button is released.

[High-speed] (HS) : Continuous shooting is available while pressing and holding the Shutter button (About 5.5 frames per second). The shooting speed may get slower depending on the shooting environment or the number of shots.

[Motion Capture] (📷) : This takes 11.5 shots per second, when the shutter is pressed and held down. After completing the continuous shooting, images are saved and the images play back on the Rear LCD. The maximum number of shots is 20 and the image size is fixed as 640X480.

[AEB] (AEB) : Take three consecutive photos with varying exposure values. Use this mode if it is hard to decide exposure of the object.



- High resolution and picture quality increases file saving time, which increases stand-by time.
- If the [Continuous], [High-speed], [Motion Capture], [AEB] sub menu is selected, the flash will be off automatically.



- If less than 3 pictures are available in the memory, the AEB shooting is not available.
- It is best to use a tripod for the AEB shooting as the time to save each image file is longer and blurring caused by camera shake may occur.

Setting AEB area

The ranges and intervals of three photos can be set during AEB shooting.

- Set a standard for the exposure bracket by pressing the LEFT/RIGHT buttons.
- Set a range for the left and right exposure bracket by using the Smart Dial.

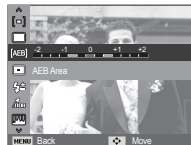



Functions ()

Auto Focus type

You can select your preferred Focus Area according to the shooting conditions.

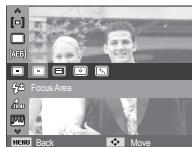
[Center AF] () : The rectangular area in the center of the LCD monitor will be focused



[Multi AF] () : This camera selects all of available AF point from the 9 AF points.

[Selection AF] () : Focus on the desired position of the LCD monitor.

[Tracking AF] () : The focus moves along with the movements of a subject.

※ When the camera focuses on the subject, the auto focus frame turns to green. When the camera doesn't focus on the subject, the auto focus frame turns to red.

■ How to Enable Selection AF

After setting [Selection AF], press the OK button and then the screen for setting the location of a focus frame will appear. Press the Up/Down/Left/Right button to move the focus mark to the desired position. Press the shutter button to enable Selection AF. Once setting is complete, the focus mark will be fixed at the position set.



Focus Mark

Press the OK button once again to change the location of the focus frame and the focus frame will appear again.

- ※ Even if you turn off the power and turn on it again, the previous setting will be maintained.
- ※ [Selection AF] is not available when operating the [Face Detection] function.

Flash Intensity

You can control flash intensity. (You can set flash intensity within the range of +/- 2EV in intervals of 1EV.)

[-2], [-1], [0], [+1], [+2]

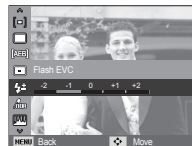

- The [Flash EVC] function is not available in the [Smart Auto], [Beauty Shot], [Scene] and [Movie], [Night] modes.
- If the subject is too close or the sensitivity is too high, changing the value to a negative value (-) may not have any effect.
- If the flash intensity is out of the control range because the exposure value is too high or low, the camera may not operate properly.

Functions (Fn)

Photo Style Selector

You can add various effects to the image without using image editing software.

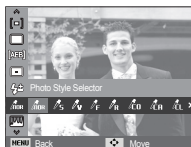

1. Select the desired Photo style selector by pressing the Left/Right button and press the OK button.
2. Press the Shutter button to take an image.

Style mode	Icon	Description
Normal		No style effect is applied.
Soft		Soft style is applied.
Vivid		Vivid style is applied.
Forest		Forest style is applied.
Retro		Sepia style is applied.
Cool		Cool style is applied.
Calm		Calm style is applied.
Classic		Black & white effect is applied.
Negative		Negative effect is applied.
Custom RGB		Define an RGB tone to create your own photo style.

- Custom colour : You can change the R (Red), G (Green) and B (Blue) values of the image.



- Up/Down button : Selects R, G, B
- Left/Right button : Changes the values



- When picture style is set, face detection is not available.
- When Soft or Vivid in photo style is set, saturation is not available.
- When Negative in photo style is set, contrast is not available.

Functions (Fn)

Image Adjust

■ Contrast

You can change the contrast of the image.

1. Select [Contrast] by pressing the Up/Down button.
2. Change the contrast by pressing the Left/Right button.
3. Press the Shutter button to take an image.

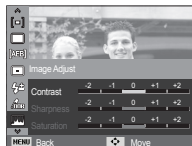

- When Negative in photo style is set, contrast is not available.

■ Sharpness

You can adjust the sharpness of the picture you are about to take.

You cannot check the sharpness effect on the LCD monitor before you take a picture, because this function is applied only when the captured image is stored on the memory.

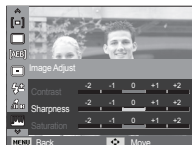

1. Select [Sharpness] by pressing the Up/Down button.
2. Change the Sharpness by pressing the Left/Right button.
3. Press the Shutter button to take an image.

■ Saturation

You can change the saturation of the image.

1. Select [Saturation] by pressing the Up/Down button.
2. Change the saturation by pressing the Left/Right button.
3. Press the Shutter button to take an image.

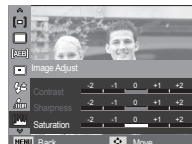



- When Soft or Vivid in photo style is set, saturation is not available.

Functions ()

Image Stabilization

This feature allows you to minimize camera shake while taking a picture.

[OIS] () : Performs optical image stabilization.

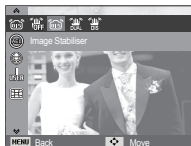

[DUAL IS] () : Performs optical image stabilization and digital image stabilization simultaneously.

[DIS] () : Performs digital image stabilization.



- OIS function may not work sufficiently in the following cases.
 - To take pictures of a moving subject.
 - To take pictures with higher zoom values.
 - When camera shake is beyond the camera-shake correction range.
 - When the shutter speed is slow.
 - When the battery is low.
- If you operate OIS function using a tripod, the image can be blurred by the vibration of the sensor of the OIS. Turn off the OIS function when you use a tripod.
- If the camera is subjected to an impact, the LCD monitor can be affected. To make the camera function properly again, turn it on and off.

■ Things to watch out for using the DUAL IS/DIS mode

- The digital zoom will not operate in the DUAL IS/DIS mode.
- If the lighting conditions are brighter than fluorescent lighting conditions, the DUAL IS/DIS will not activate.
- If the lighting conditions are darker than in fluorescent lighting conditions, camera shake warning indicator () will be displayed. For best results only take pictures in situations where the camera shake warning indicator () is not displayed.
- If the subject is moving, the captured image may be blurred.
- As the DUAL IS/DIS uses the camera's digital signal processor, it may take a little longer for the camera to process and save the images.

Functions (Fn)

Key mapping

A desired AEL button can be set.

[AEL]: Shooting is available while the exposure is being locked.

[AFL]: Shooting is available while the focus is being locked.

[AEL + AFL]: Shooting is available while the exposure and the focus are locked.

[AF-On]: This function is a replacement for pressing the shutter halfway down (metering and autofocus).

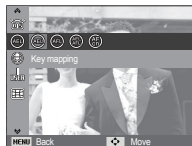

Voice Memo

You can add your voice-over to a stored still image. (Max. 10 sec.)

- If the voice memo indicator is displayed on the LCD monitor, the setting is completed.

- Press the shutter button and take a picture. The picture is stored on the memory card.

- Voice memo will be recorded for ten seconds from the moment the picture is stored. In the middle of the sound recording, pressing the shutter button will stop the voice memo.

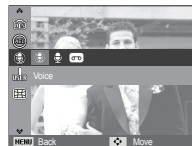

Functions ()

Voice Recording

A voice can be recorded for as long as the available recording time (maximum 8 hours at once) allows.

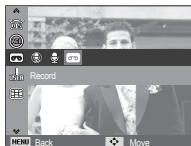

Press the shutter button to record a voice.

- Press the shutter button once and voice is recorded for as long as the available recording time (maximum 8 hours at once) allows.

The recording time will be displayed on the LCD monitor. Voice will still be recorded if the shutter button is released.

- If you wish to stop recording, press the shutter button again.

- File type : *.wav



[Voice recording mode]

■ Pausing while recording a voice

Using this function, you can record your favourite voice clips into a voice recording file without having to create multiple voice recording files.

1. Press the OK button to pause recording.
2. Press the OK button again to resume the recording.
3. If you wish to stop recording, press the shutter button again.



[Voice recording mode]



- A distance of 40cm between you and the camera (microphone) is the best distance to record sound.
- If the camera power is turned off while the voice recording is paused, the voice recording is cancelled.

Functions (Fn)

Recording the movie clip without voice

You can record the movie without voice.

Select [Off] of [Voice] menu in the Movie clip mode. () icon will appear on the LCD monitor. Press the Shutter button and a movie will record for as long as the memory capacity allows without voice.

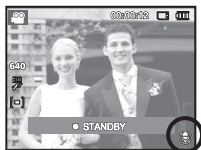
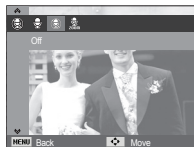



Distortion compensation

Distortion of the centre of an image due to a wide-angle lens can be compensated for. If you use the distortion compensation function, the size of the photo will be smaller than one taken with normal shooting.

[Off]: Distortion is not compensated for.

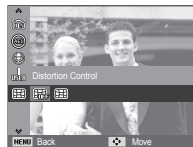
[On]: Distortion is compensated for.



-  • Even though the [Distortion Control] function is set, the [Blink Detection] function is not available.

Functions (Fn)

Setting user mode

You can use your own shooting mode by saving the shooting options which are set in the [Program], [Aperture. Shutter Priority] and [Manual] modes.

Set a desired option and save the setting information.

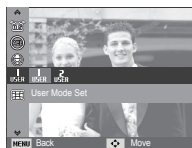

■ How to set the user mode

1. Select a mode from [Program], [Aperture. Shutter Priority] or [Manual] modes.
2. Select the desired mode.
3. Select [User Mode Set] in the [Functions] menu.
4. Select [User Mode 1] or [User Mode 2] by pressing the LEFT/RIGHT buttons and press the OK button to save the setting information.

Movie clip frame stabiliser

This function helps stabilize images captured during movie recording.

You can select this menu only in the Movie clip mode.

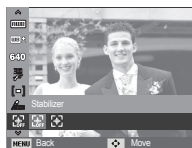

[Off]: Movie clip frame stabilizer function is disabled.

[On]: Minimises camera shake during movie recording.

※ The recording frame range becomes narrow when you select this menu.

Sound menu

In this mode, you can set up sound settings. You can use the setup menu in all camera modes, except Voice Recording mode.

- The items indicated by * are default settings.
- ※ Menus are subject to change without prior notice.

Sound ()

Volume

You can select a volume of start up sound, shutter sound, beep sound and AF sound.

- [Volume] sub menu : [Off], [Low], [Medium]*, [High]

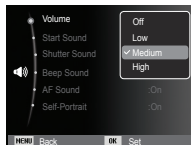

Start up sound

You can select the sound that is activated whenever the camera is turned on.

- Start up sound : [Off]*, [1], [2], [3]
- If the start up image is set to [Off], the start up sound will not activate, even though you may have set these to on.



Shutter sound

You can select the shutter sound.

- Shutter sound : [Off], [1]*, [2], [3]

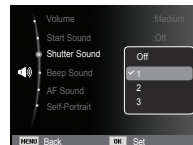

Beep Sound

If you set sound to ON, a beep will sound when buttons are pressed, letting you know the camera operation status.

- [Beep Sound] sub menu : [Off], [1]*, [2], [3]

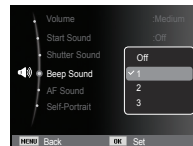

Sound ()

AF sound

If you set AF sound to on, AF sound will be activated when the Shutter button is pressed down half way so that you can be aware of the camera operation status.

- [AF sound] sub menu : [Off], [On]*

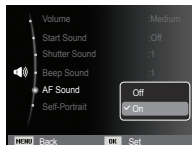

Self Portrait

This occurs when it automatically detects the location of the subject's face when taking a self-portrait.

- This feature can be set by using the [Off] and [On]* buttons.

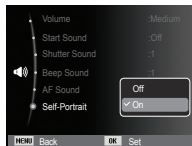

Setup menu

In this mode, you can set up basic settings. You can use the setup menu in all camera modes, except Voice Recording mode.

- The items indicated by * are default settings.
- ※ Menus are subject to change without prior notice.

Display ()

Language

There is a choice of language that can be displayed on the LCD monitor. Even if the battery is removed and inserted again, the language setting will be preserved.



Display ()

Setting the Grid Line

You can set the type of grid displayed on the histogram/grid window. (p.36)

- [Grid Line] sub menus:

[+]:



[3 X 3]:



[X]:

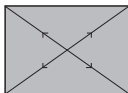

[2 X 2]*:

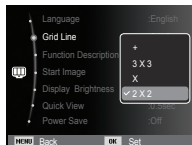
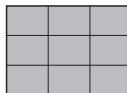

Function Description

You can select whether the function description can be displayed on the window in recording mode.

- Function Description sub menu

[Off] : The function description function can't be activated.

[On]* : The name and description of the option is displayed.

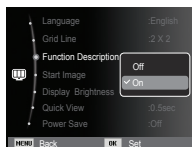

Start up image

You can select the image that is first displayed on the LCD monitor whenever the camera is turned on.

- Sub menu : [Off]*, [Logo], [User Image]
- Use a saved image for the start-up image with the [Start Image] in the [Resize] menu in the play mode.
- The start-up image will not be deleted by [Delete] or [Format] menu.
- The User images will be deleted by [Reset] menu.

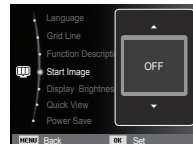

Display Bright

You can adjust the LCD brightness.

- Sub menu : [Auto]*, [Dark], [Normal], [Bright]

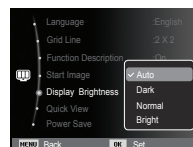

Display ()

Quick view

If you enable Quick View before capturing an image, you can view the image you just captured on the LCD monitor for the duration set in the [Quick View] setup. Quick view is possible only with still images.

- Sub menus

[Off] : The quick view function can't be activated.

[0.5 sec]*, [1 sec], [3 sec]

: The captured image is briefly displayed during the selected time.

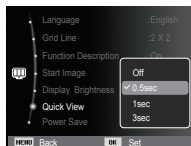

Display SAVE

If you set the [Power Save] to On and the camera isn't operated during the specified time, the LCD monitor will be turned off automatically.

- Sub menus

[Off]* : The LCD monitor will not be turned off.

[On] : If the camera isn't operated during the specified time (about 30 SEC.), the camera power will be idle (Camera status lamp:Blinking) automatically.



※ You can't set the [Power Save] menu of Playback Mode.

Settings ()

Formatting a memory

This is used for formatting the memory. If you run [Format] on the memory, all images, including the protected images, will be deleted. Be sure to download important images to your PC before formatting the memory.

- Sub menus

[No]* : The memory will not be formatted.

[Yes] : A window for confirming the selection displays. Select the [Yes] menu. A [Formatting] message appears and the memory will be formatted.

If you run FORMAT in Play mode, a [Format is completed] message will appear.



■ Be sure to run [Format] on the following types of memory card.

- A new memory card, or an unformatted memory card
- A memory card that has a file this camera can't recognise or one that has been taken from another camera.
- Always format the memory card using this camera. If you insert a memory card that has been formatted using other cameras, memory card readers, or PCs, you will get a [Card Error] message.

Initialisation

All camera menu and function settings will be restored to their default values. However, values for DATE / TIME, LANGUAGE, and VIDEO OUT will not be changed.

- Sub menus

[No]* : Settings will not be restored to their defaults.

[Yes] : A window to confirm the selection will be displayed. Select the [Yes] menu and all settings will be restored to their defaults.

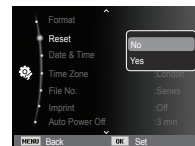

Settings ()

Setting up the Date / Time / Date type

You can change the date and time that will be displayed on the captured images and set up the date type. Setting [Time Zone] enables you to display the local date and time on the LCD monitor when travelling overseas.

- Date type : [yyyy/mm/dd], [mm/dd/yyyy],
[dd/mm/yyyy], [Off]*

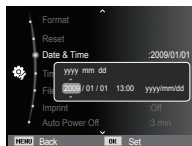

Time Zone

■ Available cities:

London, Cape Verde, Mid-Atlantic, Buenos Aires, Newfoundland, Caracas, La Paz, NewYork, Miami, Chicago, Dallas, Denver, Phoenix, LA, San Francisco, Alaska, Honolulu, Hawaii, Samoa, Midway, Wellington, Auckland, Okhotsk, Guam, Sydney, Darwin Adelaide, Seoul, Tokyo, Beijing, Hong Kong, Bangkok, Jakarta, Yangon, Almaty, Kathmandu, Mumbai, New Delhi, Tashkent, Kabul, Abu Dhabi, Teheran, Moscow, Athens, Helsinki, Rome, Paris, Berlin



※ DST : Daylight Saving Time

File name

This function allows the user to select the file naming format.

[Reset] : After using the reset function, the next file name will be set from 0001 even after formatting, deleting all or inserting a new memory card.

[Series]* : New files are named using numbers that follow the previous sequence, even when a new memory card is used, or after formatting, or after deleting all pictures.

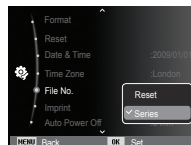

- The first stored folder name is 100PHOTO, and the first file name is SAM_0001.
- File names are assigned sequentially from SAM_0001 → SAM_0002 → ~ → SAM_9999.
- The folder number is assigned sequentially from 100 to 999 as follows: 100PHOTO → 101PHOTO → ~ → 999PHOTO.
- Maximum numbers of files in a folder are 9999.
- The files used with the memory card conform to the DCF (Design rule for Camera File systems) format. If you change the image file name, the image may not play back.

Settings ()

Imprinting the recording date

There is an option to include DATE / TIME on still images.

- Sub menus

- [Off]* : The DATE & TIME will not be imprinted on the image file.
- [Date] : Only the DATE will be imprinted on the image file.
- [Date & Time] : The DATE & TIME will be imprinted on the image file.

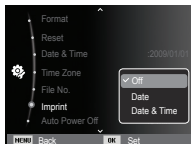

- ※ The Date & Time are imprinted at the bottom right side of the still image.
- ※ The imprint function is applied only to still images.
- ※ Depending on the manufacturer and print mode, the date printed on an image may not be printed correctly.

Auto power off

This function switches the camera off after a set amount of time in order to prevent unnecessary battery drainage.

- Sub menus

[Off] : The power off function will not operate.

[1 min], [3 min]*, [5 min], [10 min] : The power will turn off automatically if not used for the period of time specified.

- After replacing the battery, the power off setting will be preserved.
- Note that the automatic power off function will not operate if the camera is in the PC / Printer mode, slide show, playing back a voice recording and playing back a movie clip.

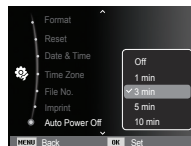

Settings ()

Auto Focus lamp

You can turn on and off the Auto Focus lamp.

- Sub menus

[Off] : The AF lamp will not light up in low light conditions.

[On]* : The AF lamp will light up in low light conditions.

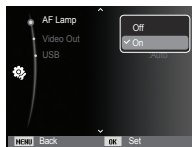

Selecting Video out type

The Movie output signal from the camera can be NTSC or PAL. Your choice of output will be governed by the type of device (monitor or TV, etc.) to which the camera is connected. PAL mode can support only BDGHI.

■ Connecting to an external monitor

When the camera is connected to an external monitor, the image and menus on the LCD monitor will be visible on the external monitor and the LCD monitor of the camera.

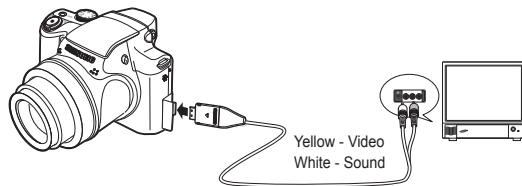

Settings ()

- NTSC : U.S.A, Canada, Japan, South Korea, Taiwan, Mexico.
- PAL : Australia, Austria, Belgium, China, Denmark, Finland, Germany, U.K., Holland, Italy, Kuwait, Malaysia, New Zealand, Singapore, Spain, Sweden, Switzerland, Thailand, Norway.
- When using a TV as an external monitor, you will need to select the external or AV channel of the TV.
- There will be a digital noise on the external monitor, but it is not a malfunction.
- If the image is not in the centre of the screen, use the TV controls to centre it.
- When the camera is connected to an external monitor, some parts of the image may not be displayed.
- When the camera is connected to an external monitor, the menu will be visible on the external monitor and the menu functions are the same as those indicated on the LCD monitor.

Setting the USB

If the camera is set to connect automatically to a PC or a printer using a USB cable, you can manually set [Computer] or [Printer].

-[USB] sub menus:

[Auto]* : Automatically enables an external device connected with a USB cable.

[Computer] : Sets computer connection mode if the connected external device cannot be recognized automatically.

[Printer] : Sets printer connection mode if the connected external device cannot be recognized automatically.



Starting play mode

Turn the camera on and select Play mode by pressing the play mode button (). The camera can now play back the images stored in the memory. If the memory card is inserted in the camera, all the camera functions apply only to the memory card.

If the memory card is not inserted in the camera, all the camera functions apply only to the internal memory.

■ Manner mode

To select the Manner mode, press the Play mode button for more than 3 seconds. In the Manner mode, Operating sound, Effect sound, Start-up sound and Shutter sound will not be generated. To cancel the Manner mode, turn on the camera by pressing the POWER button.

Playing back a still image

1. Select the PLAY mode by pressing the play mode button ().
 2. The last image stored on the memory is displayed on the LCD monitor.
 3. Select an image that you want to view by pressing the Left/ Right button.
- ※ Press and hold the Left or Right button to play back the images quickly.



Playing back a movie clip

1. Select the recorded movie clip that you want to play back by using the Left/Right button.
2. Press the OK button to play back a movie clip file.
 - To pause a movie clip file while playing it back, press the OK button again.
 - Pressing the OK button again will cause the movie clip file to restart.
 - To rewind the movie clip while it is playing, press the Left button.
 - To fast forward the movie clip, press the Right button.
 - To stop playback of the movie clip, press the OK button, and then press the Left or Right button.



-  • Video files (H.264 (MPEG4.AVC)) recorded with another camera cannot be played back.

■ How to Control Volume While Playing Back Movie clip

While a movie clip is playing, if you turn the Zoom W/T lever to the left, the volume turns down. If you turn the Zoom W/T lever to the right, the volume turns up.



- ※ Even though voice memo, movie clip, voice recording is playing, you can control the volume.

Starting play mode

Movie clip capture function

You can capture still images from the movie clip.

■ How to capture the movie clip

1. Press the OK button while playing the movie clip. Then press the Down button.
2. The paused movie clip is saved in a new file name.

- ※ The captured movie clip file is the same size as the original movie clip (1280x720HQ, 640x480, 320x240).
- ※ When you press the down button at the beginning of the movie clip, the first frame of the movie clip will be saved as a still image.



[Paused]

Playing back a recorded voice

1. Select the recorded voice that you want to play back by using the Left/Right button.
2. Press the OK button to play back a recorded voice file.
 - To pause a recorded voice file, while playing it back, press the OK button again.
 - To resume playback of the voice file, press the OK button.
 - To rewind the voice file while it is playing, press the Left button.
 - To fast forward the voice file, press the Right button.
 - To stop playback of the voice memo, press the Down button.

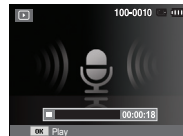

Playing back a voice memo

1. Select a still image that has the voice memo.
2. Press the OK button to play back the voice memo.
 - To pause the voice memo, while playing it back, press the OK button again.
 - To resume playback of the voice memo, press the OK button.



LCD monitor Indicator

The LCD monitor displays shooting information about the displayed image.

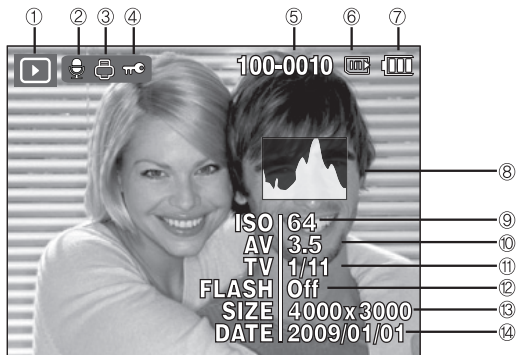

No.	Description	Icon	Page
1	Playback mode		p.70
2	Voice Memo		p.88
3	DPOF		p.89
4	Protect		p.86
5	Folder name & File name	100-0010	p.66
6	Memory card indicator		-
7	Battery		p.15
8	Histogram		p.37
9	ISO	64~6400	p.46
10	Aperture value	F2.8 ~ F8.0	-
11	Shutter speed	16 ~ 1/2,000	-
12	Flash	On/Off	p.40
13	Image size	4000x3000 ~ 320x240	p.50
14	Recording date	2009/01/01	p.66

Using the camera buttons to set the camera

In Play mode, you can use the buttons on the camera to conveniently set up the Play mode functions.

Thumbnail () / Digital Zoom () Lever

Smart Album

You can view multiple pictures, enlarge a selected picture, and crop and save a selected area of an image.

1. Turn the lever to the left to enter the Smart Album mode when a picture is displayed.
2. Move to the desired picture by using the LEFT/RIGHT buttons.
3. Move to the normal playback screen by turning the digital zoom lever to the right.



[Highlighted image]

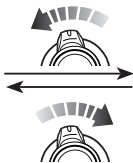

[Smart Album Window]

Thumbnail () / Digital Zoom () Lever

■ Searching or Deleting Files

1. Turn the lever to the left when the Smart Album screen is displayed.
2. Whenever you turn the lever, categories and files are displayed on the Smart Album screen.
3. Select the file by pressing the Up/Down/Left/Right buttons.
4. Press the Delete () button to delete the selected file.



[9-Thumbnail Window]

[20-Thumbnail Window]



- When Smart Album feature runs or a category is selected, it may take few seconds depends on recorded data volume. However, it is not a malfunction please wait until Smart Album screen appears.

■ Smart Album Filter

1. Press the MENU button in Smart Album mode.
2. Selecting the desired category enables to categorize and search the files by using the Up/Down button.

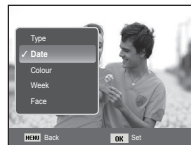

Thumbnail () / Digital Zoom () Lever

■ Details of Each Category

Category	Description	File Format
Type	Categorized depending on the file type (e.g., picture, video, or voice)	Pictures, Videos, Voice
Date	Categorized depending on the sequence of recorded dates.	
Colour	Categorized depending on the main color.	
Week	Categorized depending on the sequence of recorded weeks.	
Face	Categorized depending on the faces photographed in the Face Detection mode.	

■ Image enlargement

1. Select an image that you want to enlarge and press the enlargement button.
2. Different parts of the image can be viewed by pressing the 5 function button.
3. Pressing the thumbnail button will zoom back to the original full sized image.





- You can tell whether the image displayed is an enlarged view by checking the image enlargement indicator shown at the top left of the LCD monitor. (If the image is not an enlarged view, the indicator will not be displayed.) You can also check the area of enlargement.



- Movie clips and WAV files can't be enlarged.

- If an image is enlarged, a loss of quality may occur.

■ The maximum enlargement rate in proportion to the image size

Image size	12M	 10M	 9M	8M	5M	3M	 2M	1M
Maximum enlargement rate	X12.5	X10.4	X10.4	X10.2	X8.1	X6.4	X5.0	X3.2

■ Trimming : You can extract part of the image that you want and save it separately.

1. Select an image that you want to enlarge and press the enlargement button. Press the OK button and a message will be displayed.
2. Select a desired sub menu by pressing the Up / Down button and press the OK button.

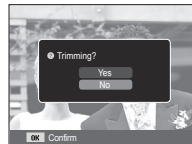

- [Yes] : The trimmed image will be saved as a new file name, and appear on the LCD monitor.
- [No] : The trimming menu will disappear.

※ If there is not enough memory space to save the trimmed image, the image can't be trimmed.

Info (DISP) / Up button

When the menu is displayed on the LCD monitor, the UP button operates as a direction button.

When the menu is not displayed on the LCD monitor, pressing the Info button will display image information on the LCD monitor.

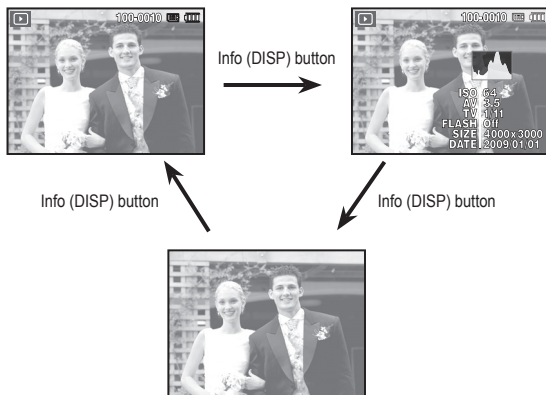

Play & Pause / OK button

In Play mode, the play & pause/ OK button works as follows:

- When the menu is displayed on the LCD monitor, the OK button is used for confirming data that is changed by using the 5 function button.

- If a still image with a voice memo, a voice file, or a movie clip is playing

·In Stop mode : Plays a still image with a voice memo, a voice file, or a movie clip.

·During playback : Temporarily stops playback.

·In Pause mode : Resumes playback



[Voice recording is stopped]

[Voice recording is playing]

[Voice recording is paused]

Left / Right / Down / MENU button

LEFT / RIGHT / DOWN / MENU buttons activate the following.

- LEFT button : While the menu is showing, the LEFT button operates as a direction button. While the menu is not showing, press the LEFT button to select the previous image.
- RIGHT button : While the menu is showing, the RIGHT button operates as a direction button. While the menu is not showing, press the RIGHT button to select the next image.
- DOWN button : If the menu is displayed Press the DOWN button to move from the main menu to a sub menu, or to move down the sub menu cursor.
- MENU button : When you press the MENU button, the play mode menu will be displayed on the LCD monitor. Pressing it again will return the LCD to the initial display.

Delete () button

This deletes images stored on the memory card.

1. Select an image that you want to delete by pressing the Left / Right button and press the DELETE () button.

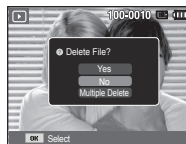

[Single Image]

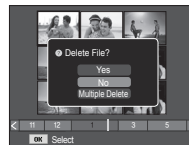

[Thumbnail Image]

2. To add images to delete, select the [Multiple Delete] menu.

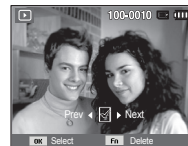

- Left/Right button : Selects images
- OK button : checks for deletion
- Fn button : deletes the selected images.



3. Select the submenu values by pressing the Up / Down button and then press the OK button.
 - If [Yes] is selected : deletes the selected images.
 - If [No] is selected : cancels "Delete Image".

Setting up the play back function using the LCD monitor

PLAY mode functions can be changed by using the LCD monitor. In the PLAY mode, pressing the MENU button displays the menu on the LCD monitor. The menus you can set up in Play mode are as follows. To capture an image after setting up the play menu, press the PLAY mode button or shutter button.

Menu Tab	Main Menu	Sub Menu		Page
Edit 	Resize	2592x1944	2048x1536	p.79
		1024X768	2592X1728	
		1800X1200	2592X1458	
		1920X1080	Start Image	
	Rotate	Right 90°	Left 90°	p.80
		180°	Horizontal	
		Vertical	-	
	Photo Style Selector	Normal	Soft	p.80
		Vivid	Forest	
		Retro	Cool	
		Calm	Classic	
		Negative	Custom	
Image Adjust	Off	ACB	p.81	
	Red-eye Fix	Face Retouch		
	Brightness	Contrast		
	Saturation	Add Noise		
View 	Single, 9, 20			p.83
Multi Slide Show 	Start	Play / Repeat	-	p.83
	Images	All	Date	p.84
Select		-		

Menu Tab	Main Menu	Sub Menu		Secondary Menu	Page
Multi Slide Show 	Effect	Off	Calm	-	p.84
		Sweet	Lively	-	
		Shine	-	-	
	Interval	1, 3, 5, 10 sec		-	p.85
	Music	Off	Mist	-	p.85
Muse		Fall	-		
Drops		Trip	-		
Select		-	p.85		
All		Yes / No			
Protect	Select		-	p.86	
	All		Unlock / Lock		
Face Registration	No		Yes	p.87	
Recycle Bin	Off		On	p.88	
	Retrieve		-		
Voice memo	Off		-	p.88	
	On		-		
DPOF	Standard		Select / All / Reset	p.89	
	Index		Yes / No		
	Size		Select / All / Reset		
Copy To Card	Yes		-	p.91	
	No		-		

Setting up the play back function using the LCD monitor

This menu is available while the camera is connected to a PictBridge supporting printer (direct connection to the camera, sold separately) with a USB cable.

Menu Tab	Main Menu	Sub Menu	Secondary Menu	Page
	Images	One Photo	-	p.93
		All Photos	-	
	Size	Auto	-	p.93
		PostCard	-	
		Card	-	
		4X6	-	
		L	-	
		2L	-	
		Letter	-	
		A4	-	
		A3	-	
		Layout	Auto	
	Full		-	
	1		-	
	2		-	
	4		-	
	8		-	
	9		-	
	16		-	
Index	-			

Menu Tab	Main Menu	Sub Menu	Secondary Menu	Page
	Type	Auto	-	p.93
		Plain	-	
		Photo	-	
		FastPhoto	-	
	Quality	Auto	-	
		Draft	-	
		Normal	-	
		Fine	-	
	Date	Auto	-	
		Off	-	
		On	-	
	File Name	Auto	-	
		Off	-	
		On	-	
Reset	Yes	-	p.94	
	No	-		

※ Menus are subject to change without prior notice.

Edit ()

Resize

Change the resolution (size) of pictures taken. Select [Start image] to save an image to be the start-up image.

1. Press the play mode button and press the MENU button.
2. Click the Up/Down button from the Edit menu to select [Resize] () menu tab and press the OK button.
3. Select a desired sub menu by pressing the Left / Right button and press the OK button.



■ Image Resize Types

(o : Selectable)

	5M	3M	1M	
12M	o	o	o	o
8M	o	o	o	o
5M		o	o	o
3M			o	o
1M				o

	4M	2M
10M	o	o
	4M	2M
9M	o	o

- A large sized image can be resized to a smaller sized image, but not vice versa.
- Only JPEG images can be resized. Movie clip (H.264), Voice recording (WAV) files can't be resized.
- You can change the resolution of only those files compressed in the JPEG 4:2:2 format.
- The resized image will have a new file name. The [Start Image] image is stored not on the memory card but on the internal memory.
- If a new user image is saved, one of the two user images will be deleted in order.
- If the memory capacity is insufficient to store the resized image, a [Memory Full] message will appear on the LCD monitor and the resized image can't be stored.

Edit ()

After using [Edit] feature, the edited image will be saved at a smaller size than original image.

Rotating an image

You can rotate the stored images by various degrees.

1. Press the play mode button and press the MENU button.
2. Click the Up/Down button from the Edit menu to select [Rotate] () menu tab and press the OK button.
3. Select a desired sub menu by pressing the Left / Right button and press the OK button.

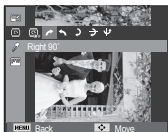
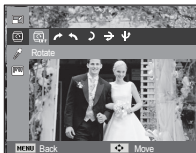

[] : Right 90°
: Rotate picture in a
clock-wise direction



[] : Left 90°
: Rotate picture in a
counter-clock-wise direction

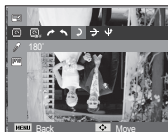

[] : 180°
: Rotate picture 180
degrees

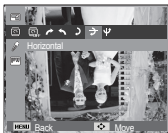

[] : Horizontal
: Rotate picture horizontally



[] : Vertical
: Rotate picture vertically











※ If you display the rotated image on the LCD monitor, empty spaces may appear to the left and right of the image.

Photo Style Selector

It is possible to add various effects to your images by using this function.

1. Press the play mode button and press the MENU button.
2. Click the Up/Down button from the Edit menu to select [Photo Style Selector] () menu tab and press the OK button.
3. Select a desired sub menu by pressing the Left / Right button and press the OK button.



Style mode	Icon	Description
Normal		No style effect is applied.
Soft		Soft style is applied.
Vivid		Vivid style is applied.
Forest		Forest style is applied.
Retro		Sepia style is applied.
Cool		Cool style is applied.
Calm		Calm style is applied.
Classic		Black & white effect is applied.
Negative		Negative effect is applied.
Custom RGB		Define an RGB tone to create your own photo style.

4. The changed image is saved as a new file name.

Edit ()

■ Custom colour

You can change the R (Red), G (Green) and B (Blue) values of the image.

- OK button : Select / setup the Custom Colour
- Up / Down button : Selects R, G, B
- Left / Right button : Change the values



Image Adjust

1. Press the play back button and press the MENU button.
2. Click the Up/Down button from the Edit menu to select [Image Adjust] () menu tab and press the OK button.

■ ACB

You can automatically adjust the brightness of the dark area, caused by under exposure to the light source.

1. Select () by pressing the Left/Right button and press the OK button.
2. The [Making New Image] message is displayed and the image is saved as a new file name.



■ Red eye Removal

Red eye effect can be removed from the captured image.

1. Select () by pressing the Left/Right button and press the OK button.
2. The [Making New Image] message is displayed and the image is saved as a new file name.



■ Face Retouch

You can make the skin in an image appear clear and beautiful.

1. Select () by pressing the Left/Right button and press the OK button. Then a bar for selecting the face retouch will be displayed.
2. Change the face retouch by pressing the Left/Right button.
3. Press the OK button and the image will be saved as a new file name.



Edit (📷)

■ Brightness control

You can change the brightness of the image.

1. Select (☀️) by pressing the Left/Right button and press the OK button. Then a bar for selecting the brightness will be displayed.
2. Change the brightness by pressing the Left/Right button.
3. Press the OK button and the image will be saved as a new file name.



■ Saturation control

You can change the saturation of the image.

1. Select (🌈) by pressing the Left/Right button and press the OK button. Then a bar for selecting the saturation will be displayed.
2. Change the saturation by pressing the Left/Right button.
3. Press the OK button and the image will be saved as a new file name.



■ Contrast control

You can change the contrast of the image.

1. Select (🔍) by pressing the Left/Right button and press the OK button. Then a bar for selecting the contrast will be displayed.
2. Change the contrast by pressing the Left/Right button.
3. Press the OK button and the image will be saved as a new file name.

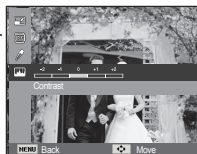

■ Noise effect

You can add noise to an image to add a more classic feel to your photo.

1. Select (🔍) by pressing the Left/Right button and press the OK button.
2. The [Making New Image] message is displayed and the image is saved as a new file name.



View ()

You can view the thumbnails and easily categorize or search a large amount of content such as pictures and videos.

1. Press the MENU button in playback mode.
2. Press the Up/Down button to select the desired menu.
3. Press the OK button and selected thumbnail screen will appear.

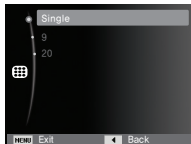

Starting the Multi Slide Show ()

Images can be displayed continuously at pre-set intervals. You can view the Multi Slide Show by connecting the camera to an external monitor.

1. Press the play mode button and press the menu button.
2. Press the Up / Down button and select the [Multi Slide Show] menu tab and press the OK button.

Start the Multi Slide Show

The Multi Slide Show can start only in the [Start] menu.

1. Use the Up / Down buttons to select the [Start] menu and press the Right button.
2. Select a desired sub menu by pressing the Up / Down button.
[Play] : The Multi Slide Show is closed after one cycle.
[Repeat] : The Slide show is repeated until cancelled.
3. Press the OK button and the slideshow will be started.
 - To pause the slide shown while playing it back, press the OK button again.
 - Pressing the OK button again will cause the Multi Slide Show restart.
 - To stop playback of the Multi Slide Show, press the OK button, and then press the Left or Right button.

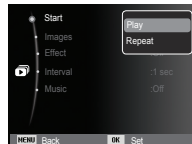

Starting the Multi Slide Show ()

Selecting Images

You can select image to view

1. Use the Up / Down buttons to select the [Images] menu and press the Right button.
2. Select a desired sub menu by pressing the Up / Down button.

[All] : All images saved in the Memory are played back.

Press the OK button and the settings are saved.

[Date] : Images taken in a specified date are played back.
Press the OK button and the settings are saved.

[Select] : Play only the selected images. If you press the Up / Down button, you can select the desired images to play back. The selected image can be saved as [Select1], [Select2] and [Select3]. If you save the selected image with the [New Select] command, it will be saved as [Select1]. But when a new image is saved again using [New Select], the former image which had been saved as [Select1] will be saved as [Select2] automatically. You can change and cancel the images which were saved as [Select1], [Select2] and [Select3]. Press the Fn button and the settings are saved.

3. Select [Play] or [Repeat] in the [Start] menu to start the multi slide show.

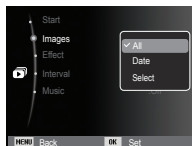

Configure Multi Slide show effects

Unique screen effects can be used for the Multi Slide Show.

1. Select the [Effect] sub menu by pressing the UP / DOWN button and press the RIGHT button.
2. Use the Up / Down button to select the type of effect.
3. Press the OK button to confirm the setting.

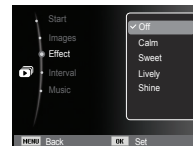



Starting the Multi Slide Show ()

Setting play interval

Set the Multi Slide Show play interval.

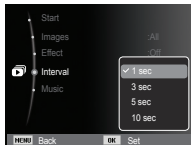
1. Select the [Interval] sub menu by pressing the UP / DOWN button and press the RIGHT button.
2. Use the Up / Down buttons to select the desired interval.
3. Press the OK button to save the configuration.



-  • The loading time depends on the image size and quality.
- While the Multi Slide Show is playing, only the first frame of a MOVIE file is displayed.
- While the Multi Slide Show is playing, the voice recording file will not display.
- The interval menu functions in the [Off] menu only.

Setting Background Music

Set the Multi Slide Show music.

1. Select the [Music] sub menu by pressing the UP / DOWN button and press the RIGHT button.
2. Use the Up / Down buttons to select the desired Music.
3. Press the OK button to save the configuration.

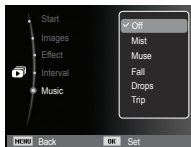

File Options ()

1. Press the play mode button and press the menu button.
2. Press the Up / Down button and select the [File Options] menu tab and press the OK button.

Deleting images

This deletes images stored on the memory.

1. Press the Up / Down button and select the [Delete] menu tab. And then press the Right button.
2. Select a desired sub menu by pressing the UP / DOWN button and press the OK button.
[Select] : Selection window for an image to delete is displayed.
 - Up/ Down/ Left/ Right : Select an image
 - OK button : Select the image for deletion. (✓ mark)
 - Fn Button : Press the Fn button to display the confirmation message. Select the [Yes] menu and press the OK button to delete marked images.

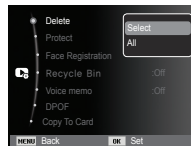

[All] : Displays confirmation window.

- Select the [Yes] menu and press the OK button to delete all unprotected images. If there aren't protected images, all the images are deleted and a [No Image] message will appear.
3. After deletion, the screen will be changed to the play mode screen.

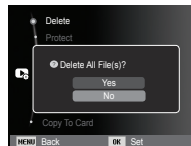

File Options ()



- Of all the files stored in the memory card, the unprotected files in the DCIM subfolder will be deleted. Remember that this will permanently delete unprotected images. Important shots should be stored on a computer before deletion takes place. The startup image is stored in the camera's internal memory (i.e., not on the memory card) and it will not be deleted even if you delete all files on the memory card.

Protecting images

This is used to protect specific shots from being accidentally erased (Lock). It also unprotects images that have been previously protected (Unlock).

1. Press the Up / Down button and select the [Protect] menu tab. And then press the Right button.
2. Select a desired sub menu by pressing the UP / DOWN button and press the OK button.

- [Select] : Selection window for an image to be protected / released is displayed.
- Up / Down / Left / Right : Select an image
 - OK button : Protect / release the image
 - Fn button : Your changes will be saved and the menu will disappear.

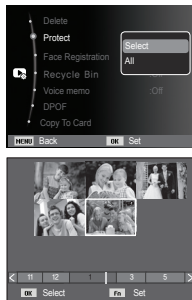

[All] : Protect / release all saved images

- If you protect an image, the protect icon will be displayed on the LCD monitor. (An unprotected image has no indicator)
- An image in LOCK mode will be protected from the delete function or [Delete] functions, but will NOT be protected from the [Format] function.

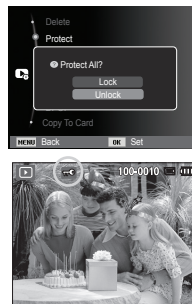

- Image protection is enabled when selecting an image in playback mode and pressing the image protection button. (Fn)

File Options ()

Registering faces

You can register faces amongst portrait shots. Registered faces can be viewed by categorizing the priority in Smart Album. However, the face registration function can be used only when inserting an external memory card.

■ For a portrait shot

1. Select a portrait shot and press the MENU button.
2. Select the [Face Registration] menu by pressing the UP/DOWN buttons and then press the RIGHT button.
3. Select the desired sub menu by pressing the UP/DOWN buttons.

[No]: The face registration function is disabled.

[Yes]: The face registration function is enabled.

4. A registration window for face detection appears when pressing the OK button.
5. Select [Yes] by pressing the UP/DOWN buttons.
6. A face is registered in order of priority when pressing the OK button.

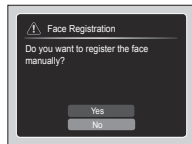
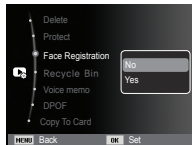

■ For a group shot

Steps 1 to 3 are identical to the procedure for a portrait shot.

4. When using the OK button, a focus frame and a check box appear on a face which can be registered.
5. Select the desired face for registration by pressing the LEFT/RIGHT buttons and then press the OK button.
6. A registration window for face detection appears when pressing the Fn button.
7. Select [Yes] by pressing the UP/DOWN buttons.
8. A face is registered in order of priority when pressing the OK button.

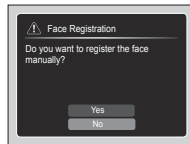
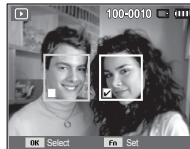

- Face registration is available for up to 3 people in playback mode. When the face registration exceeds the limitation, the first registered face is cancelled and the new face is added.

File Options ()

Recycle Bin

You can activate the [Recycle Bin] function or restore photos saved in the recycle bin. By turning on this function, you can temporarily save photos up to a total 10MB capacity. You can also restore photos from the recycle bin.

1. Select the [Recycle Bin] menu by pressing the UP/DOWN buttons and then press the RIGHT button.
2. Select a desired sub menu by pressing the UP/DOWN buttons and press the OK button.

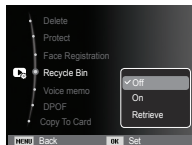

[Off]*: Do not want to use the Recycle Bin function.

[On]: Deleted photos are saved in the Recycle folder.

[Retrieve]: You can restore the deleted photos from the Recycle folder.

3. Press the OK button to save the changed setting.



- The Recycle Bin function only works with photos.
- When you delete all files at once, the files are not saved in the Recycle Bin. When the Recycle bin is full of space, it removes photos in sequence from the first deleted photo.
- Although you turn off the Recycle function, the Recycle bin still keeps the photos.
- When you format the built-in/external memory, all photos in the Recycle Bin are deleted.

Voice memo

You can add your voice to a stored still image.

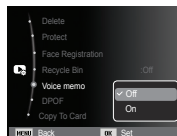

[Voice memo menu]



[Ready for recording]



[Voice is recording]

- Once you press the shutter button, the voice will record for 10 seconds.
- To stop the recording, press the shutter button.

File Options ()

DPOF

- DPOF(Digital Print Order Format) allows you to embed printing information on your memory card's MISC folder. Select the pictures to be printed and how many prints to make.
- The DPOF indicator will display on the LCD monitor when an image that has DPOF information plays back. Images can then be printed on DPOF printers, or at an increasing number of photo labs.
- This function is not available for Movie clips and Voice recording files.
- When the wide angle image is printed as a wide angle print, 8% of the left and right side of the image may not be printed. Check that your printer can support the wide angle image when you print the image. When you print the image at a photo lab, request that the image is printed as a wide angle image. (Some photo labs may not support the wide angle size print.)

-  • Depending on the printer, the image saved in portrait orientation may not be printed in portrait orientation.

■ Standard

This function allows you to embed printing quantity information on a stored image.

1. Press the Up / Down button and select the [DPOF] menu tab. And then press the Right button.
2. Press the Right button again and [Standard] sub menu will display.
3. Select a desired sub menu by pressing the Up / Down button and press the OK button.

[Select] : Selection window for an image to print is displayed.

- Up / Down / Left / Right : Select an image to print.

- Zoom button : Select the number of prints.

[All] : Configure number of prints for all pictures except movie and voice files.

- Up / Down button : Select a number of prints

[Reset] : Cancel the print setup.

4. Press the OK button to confirm the setting. If an image carries DPOF instructions, the DPOF indicator () will show.



File Options ()

■ Index

Images (except for movie clips and voice file) are printed as index type.

1. Press the Up / Down button and select the [DPOF] menu tab. And then press the Right button.
2. Select the [Index] menu and press the Right button again. Sub menu will display.
3. Select a desired sub menu by pressing the UP / DOWN button.
If [Yes] is selected : The image will be printed in index format.
If [No] is selected : Cancel the index print setting.
4. Press the OK button to confirm the setting.

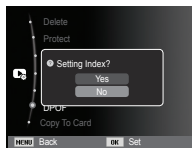

■ Print size

You can specify the print size when printing images stored on the memory card. The [Size] menu is available only for DPOF 1.1 compatible printers.

1. Press the Up / Down button and select the [DPOF] menu tab. And then press the Right button.
2. Select the [Size] menu and press the Right button again. Sub menu will display.
3. Select a desired sub menu by pressing the UP / DOWN button and press the OK button.
[Select] : Selection window to change the printed size of the image is displayed.
 - Up / Down / Left / Right : Select an image.
 - Zoom W/T Button : Change the print size.
 - Fn button : Your changes will be saved and the menu will disappear.
[All] : Change print size of all saved images.
 - Up / Down button : Select a print size
 - OK button : Confirm the changed setting.
[Reset] : Cancel all of the print size settings.

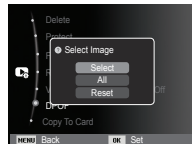

※ DPOF [Size] secondary menu : Cancel, 3X5, 4X6, 5X7, 8X10



- Depending on the manufacturer and print model, cancelling the printing may take a little longer for the printer to process.

File Options ()

Copy To Card

This enables you to copy image files, movie clips and voice recording files to the memory card.

1. Select the [Copy To Card] menu tab by pressing the Up / Down button. And then press the Right button.
2. Select a desired sub menu by pressing the UP/ DOWN button and press the OK button.

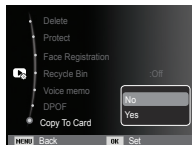

- [No] : Cancels "Copy to Card".
- [Yes] : All images, movie clips and voice recording files saved in the internal memory are copied to the memory card after the [Copying] message is displayed. After copying has been completed, the screen will return to play mode.



- If there is not enough space available in the memory card to copy saved images in the internal memory (About 20MB), the [Copy To Card] command will copy only some of the images and display [Memory Full] message. Then the system will return to the playback mode. Please be sure to delete any unnecessary files to free up space before inserting the memory card into the camera.
- When you move the images that are stored in the internal memory by doing [Copy To Card] to the card, the next number of file names will be created in the card to avoid duplication of the file name.
 - When the [Reset] of the [File No.] setup menu is set : The copied file names start from after the last stored file name.
 - When the [Series] of the [File No.] setup menu is set : The copied file names start from after the last captured file name. After completing [Copy To Card], the last stored image of the last copied folder is displayed on the LCD monitor.

PictBridge

You can use the USB cable to connect this camera to a printer that supports PictBridge (sold separately) and print the stored images directly. Movie clips and voice files cannot be printed.

■ Setting up the camera for connection to the printer

1. Connect the camera and printer with USB cable.
2. Once the camera is turned on, the camera automatically recognizes the printer and is connected to it.

- ※ If automatic connection fails, set the [USB] menu to [Printer]. (p.69)
- ※ For a printer that can enable removable disks, set the [USB] menu to [Printer].

■ Connecting the Camera to a Printer

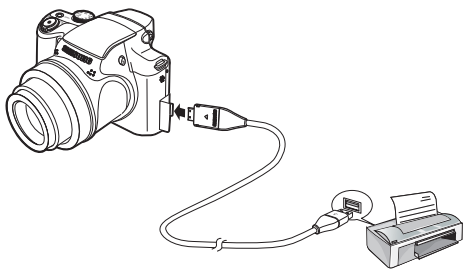

■ Easy printing

When you connect the camera to printer in the Play back mode, you can print a picture easily.

- Pressing the Left / Right button :
Selects a previous / next image.
- Pressing the OK button :

Currently displayed image will be printed with the printer's default setting.

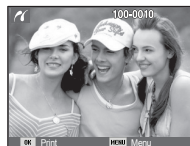

PictBridge : Picture Selection

You can select images you want to print.

■ Setting the Number of Copies to Print

1. Press the Menu button and the PictBridge menu will display.
2. Use the Up / Down buttons to select the [Images] menu and press the Right button.
3. Use the Up / Down buttons to select a desired sub menu and press the OK button.
 - Select [One Photo] or [All Photos]. A screen where you can set the number of copies to print will appear as shown below.

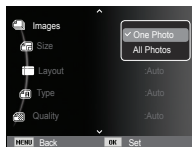

[When [One Photo] is selected]



[When [All Photos] is selected]

- Press the Up / Down button to select the number of prints.
- When [One Photo] is selected : Use the Left / Right button to select another picture. After selecting another picture, select the number of prints for another picture.
- After setting the number of prints, press the OK button to save.
- Press the Shutter button to return to the menu without setting the number of prints.

4. Press the play mode button () and images will be printed.

PictBridge : Print Setting

You can select the Paper Size, Print Format, Paper Type, Print Quality, Date Print, and File Name Print menus for printed pictures.

1. Press the Menu button and the PictBridge menu will display.
2. Use the Up / Down buttons to select the desired menu, and then press the Right button.
3. Use the Up / Down buttons to select the desired sub menu value, and then press the OK button.

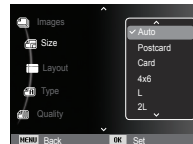

Menu	Function	Sub menu
Size	Set the size of the printing paper	Auto, PostCard, Card, 4X6, L, 2L, Letter, A4, A3
Layout	Set the number of pictures to be printed on a sheet of paper	Auto, Full, 1, 2, 4, 8, 9, 16, Index
Type	Set the quality of the printing paper	Auto, Plain, Photo, Fast-Photo
Quality	Set the quality of the picture to be printed	Auto, Draft, Normal, Fine
Date	Set whether to print the date	Auto, Off, On
File Name	Set whether to print the file name	Auto, Off, On

- ※ Some menu options are not supported on all printers. If not supported, the menus are still displayed in the LCD, but are not selectable.

PictBridge : Reset

Initialises user-changed configurations.

1. Use the Up / Down buttons to select the [Reset] menu tab. And then press the Right button.
2. Use the Up / Down buttons to select the desired sub menu value, and then press the OK button.



If [Yes] is selected : All print and image settings will be reset.

If [No] is selected : Settings will not be reset.

- ※ Default print setting varies depending on the printer manufacturer.
For your printer's default setting, refer to the user's guide that came with your printer.

Important notes

Be sure to observe the following precautions!

- **This unit contains precision electronic components. Do not use or store this unit in the following locations.**
 - Areas exposed to severe changes in temperature and humidity.
 - Areas exposed to dust and dirt.
 - Areas exposed to direct sunlight or the inside of a vehicle in hot weather.
 - Environments where there is high magnetism or excessive vibration.
 - Areas with high explosives or highly flammable materials.
- **Do not leave this camera in places subject to dust, chemicals (like naphthalene and mothballs), high temperature and high humidity. Keep this camera with silica gel in a hermetically sealed box when not planning to use the camera for a long period of time.**
- **Sand can be particularly troublesome to cameras.**
 - Do not let sand get inside the camera when using it on beaches, coastal dunes, or other areas where there is lots of sand.
 - Doing so may result in failure or may permanently render the camera unusable.
- **Handling the camera**
 - Never drop the camera or subject it to severe shocks or vibrations.
 - Protect the large size LCD monitor from an impact. When this camera is not used, keep it in the camera case.
 - Avoid obstructing the lens or the flash when you capture an image.
 - This camera is not waterproof.
To avoid dangerous electrical shocks, never hold or operate the camera with wet hands.
 - If you use this camera in wet places, such as beach or pool, do not let water or sand get inside the camera. Doing so may result in failure or may permanently damage the unit.

Important notes

- **Extremes in temperature may cause problems.**

- If the camera is transferred from a cold to a warm and humid environment, condensation can form on the delicate electronic circuitry. If this occurs, turn the camera off and wait for at least 1 hour until all moisture is dispersed. Moisture built up can also occur on the memory card. If this happens, turn off the camera and remove the memory card. Wait until the moisture has dispersed.

- **Caution on Using the Lens**

- If the lens is subjected to direct sunlight, it could result in the discoloration and deterioration of the image sensor.
- Take care not to get fingerprints or foreign substances on the surface of the lens.

- **If the digital camera is not used for a long period, an electric discharge can occur. It is a good idea to remove the battery and the memory card if you do not intend using the camera for an extended period of time.**

- **If the camera is exposed to an electronic interference, it will turn itself off to protect the memory card.**

- **Camera Maintenance**

- Use a soft brush (available from photo stores) to gently clean the lens and LCD assemblies. If this does not work, lens-cleaning paper with lens cleaning fluid can be used. Clean the camera body with a soft cloth. Do not allow this camera to come into contact with solvent materials such as benzol, insecticide, thinners etc. This may damage the body shell of the camera and also affect its performance. Rough handling can damage the LCD monitor. Take care to avoid damage and keep the camera in its protective carry case at all times when not in use.

- **Do not attempt to disassemble or modify the camera.**

- **Under certain conditions, static electricity can cause the flash unit to fire. This is not harmful to the camera and is not a malfunction.**

- **When images are uploaded or downloaded, the data transfer may be affected by static electricity. In this case, disconnect and re-connect the USB cable before trying the transfer again.**

- **Before an important event or going on a trip, you should check the camera condition.**

- Take a picture for testing the camera condition and prepare extra battery.
- Samsung cannot be held responsible for camera malfunctions.

- **If the digital camera is not used for a long period, the date and time may adopt the default settings by automatical battery discharged. In this case, reset the date and time correctly before the recording.**

Warning indicator

There are several warnings that may appear on the LCD display.

[Card Error]

- Memory card error
 - Turn off the camera power and turn it on again
 - Insert the memory card again
 - Insert and format the memory card (p.65)

[Card Locked]

- The memory card is locked
 - SD/SDHC memory card : Slide the write protect switch to the top of the memory card

[Memory Full]

- The memory card or internal memory is full.
 - Insert new memory card.
 - Delete the unnecessary image files

[No Image File]

- There are no images stored on the memory
 - Take images
 - Insert a memory card that is holding some images

[File Error]

- File error
 - Delete the file.
- Memory card error
 - Contact a camera service centre.

[Low Battery]

- There is low battery capacity
 - Insert fresh batteries.

[Power turns off automatically to prevent malfunction due to high temperatures. Wait a minute before use.]

- The power is automatically tuned off at a high temperature above 60°C.
 - If the camera is turned off because of the temperature increase in the product, cool off the heat and turn it on again.
 - If the camera is turned off because of high temperature in the surrounding air, turn on the power at less warm area.

Before contacting a service centre

Please check the following

The camera doesn't switch on

- There is low battery capacity
→ Insert fresh batteries. (p.15)
- Battery is inserted incorrectly with the polarities reversed.
→ Insert the battery according to the polarity marks (+, -).

The camera power ceases while in use

- The battery is exhausted
→ Insert fresh batteries.
- The Camera is turned off automatically
→ Turn on the camera power again.
- Operation has ceased in a low temperature outside of the camera usage temperature range.
→ Make the camera and battery warm by placing them in your pocket, etc. and then immediately before shooting, place the battery in the camera and then shoot.

Camera does not take images when pressing the Shutter button

- There is insufficient memory capacity
→ Delete unnecessary image files
- The memory card has not been formatted
→ Format the memory card (p.65)
- The memory card is exhausted
→ Insert a new memory card
- The memory card is locked
→ Refer to [Card Locked] error message
- The camera's power is off
→ Turn the camera power on
- The battery is exhausted
→ Insert fresh batteries (p.15)
- Battery is inserted incorrectly with the polarities reversed.
→ Insert the battery according to the polarity marks (+, -)

The camera suddenly stops working while in use

- The camera stopped due to a malfunction
→ Remove /re-insert battery and switch the camera on

The images are unclear

- A picture was taken of the subject without setting an appropriate macro mode
→ Select an appropriate macro mode to take a clear image.
- Taking a picture beyond the flash range
→ Take a picture within the flash range
- The lens is smudged or dirty
→ Clean the lens

Before contacting a service centre

The flash does not fire

- Flash off mode has been selected
→ Dis-engage flash off mode
- The camera mode can't use the flash
→ Refer to the FLASH instruction (p.40)

Incorrect date and time is displayed

- The date and time have been set incorrectly or the camera has adopted the default settings
→ Reset the date and time correctly

The camera buttons do not operate

- Camera malfunction
→ Remove/re-insert battery and switch the camera on

A card error has occurred while the memory card is in the camera.

- Incorrect memory card format
→ Re-format the memory card

The images don't play back

- Incorrect file name (Violation of DCF format)
→ Do not change the image file name

Colour of image is different to the original scene

- White balance or effect setting is incorrect
→ Select appropriate White balance and effect

Images are too bright

- Exposure is excessive
→ Reset exposure compensation

No image on external monitor

- The external monitor has not been connected properly with the camera
→ Check the connection cables
- There are incorrect files in the memory card
→ Insert a memory card that has correct files

When using the PC's explorer, the [Removable Disk] file does not show

- Cable connection is incorrect
→ Check the connection
- The camera is off
→ Turn the camera on
- The operating system is not Windows 2000, XP, Vista / Mac OS 10.4. Alternatively the PC does not support USB
→ Install Windows 2000, XP, Vista / Mac OS 10.4 to PC that supports USB

A part of the LCD screen does not occasionally turn on or a spot appears.

- Although the LCD screen is manufactured with high precision technology, the precision pixels are not occasionally lighted or the red, white and blue spots appear.
→ This phenomenon does not affect the quality of the recorded image and it is not a malfunction.

A vertical line appears on the LCD screen when taking a picture of a bright object.

- If a subject is exposing bright lights, a gray, black, red or purple vertical line may appear.
→ This is a phenomenon called smear and it does not affect the quality of the recorded image. This is not a malfunction.

Specifications

- Image Sensor** - Type : 1/2.33" CCD
 - Effective Pixel : Approx. 12.47 Mega-pixel
 - Total Pixel : Approx. 12.7 Mega-pixel
-
- Lens** - Focal Length : Schneider-Kreuznach Lens
 f = 4.6 ~ 110.4mm (35mm film equivalent : 26 ~ 624mm), 24X Zoom
 - F No. : F2.8(W) ~ F5.0(T)
 - Digital Zoom : · Still Image mode : 1.0X ~ 5.0X
 · Play mode : 1.0X ~ 12.5X (depends on image size)
-
- Image Stabilization** - Dual IS (OIS + DIS), OIS, DIS
 ※ OIS (Optical Image Stabilization), DIS (Digital Image Stabilization)
-
- LCD Monitor** - 3.0"(7.62cm) color TFT LCD (230,000 dots)
-
- Focusing** - Type : TTL auto focus (Multi AF, Center AF, Selection AF, Tracking AF, Face Detection)
 - Range

	Normal	Auto Macro	Macro	Super Macro	Manual Focus
Focus range	Wide	Wide	Wide	1cm ~ 10cm	10cm ~ Infinity
	80cm ~ Infinity	10cm ~ Infinity	10cm ~ 80cm		
	Tele	Tele	Tele		
	170cm ~ Infinity	170cm ~ Infinity	80cm ~ 150cm		

- Shutter** - Program : 1/2 ~ 1/2,000 sec., A-S/Manual : 16 ~ 1/2,000 sec. (Continuous, AEB : 1/4 ~ 1/2,000 sec.)
-
- Exposure** - Control : Program AE
 - Metering : Multi, Spot, Center-Weighted, Face Detection
 - Compensation : ±2EV (1/3EV steps)
 - ISO : Auto, 64, 100, 200, 400, 800, 1600, 3200(5M), 6400(3M)



- Flash** - Modes : Auto, Auto & Red-eye reduction, Fill-in flash, Slow sync, Flash off, Red Eye Fix
 - Range : Wide: 0.3 ~ 6.0 m, Tele: 0.8 ~ 3.0 m (ISO Auto)
 - Recharging Time : Approx. 5 sec
-
- Sharpness** - Soft+, Soft, Normal, Vivid, Vivid+
-
- White Balance** Auto, Daylight, Cloudy, Fluorescent_H, Fluorescent_L, Tungsten, Custom
-
- Voice Recording** - Voice Recording (max. 4GB)
 - Voice Memo in Still Image (max. 10 sec.)
-
- Date Imprinting** - Date, Date & Time, Off (user selectable)
-
- Shooting** - Still Image
 · Mode : Smart Auto, Program, A-S, Manual, Night, Beauty Shot, Scene, User1, User2
 · Scene : Frame Guide, Portrait, Children, Landscape, Close-up, Text, Sunset, Dawn, Backlight, Firework, Beach & Snow
 · Smart Auto : Macro, Macro Text, White, Landscape, Action, Tripod, Night, Night Portrait, Backlight, Backlight Portrait, Portrait
 · Shooting : Single, Continuous, High Speed, Motion Capture, AEB
 · Self-timer : 10 sec., 2 sec., Double

Specifications









- Movie Clip
 - With Audio or without Audio (user selectable, recording time : max 20min)
 - Size : 1280x720HQ(30FPS & 15FPS), 640x480(30FPS & 15FPS), 320x240(60FPS & 30FPS & 15FPS)
 - Movie Editing (Embedded): Still Image Capture

Storage

- Media
 - Internal memory : About 20MB flash memory
 - External memory (Optional) : SD card (Up to 4GB guaranteed) SDHC card (Up to 8GB guaranteed)
- File Format
 - Still Image : JPEG (DCF), EXIF 2.21, DPOF 1.1, PictBridge 1.0, RAW (DNG1.1)
 - Movie Clip : MP4 (H.264(MPEG4.AVC))
 - Audio : WAV
- Image Size

12M			8M	5M	3M		1M
4000x3000	3984x2656	3968x2232	3264x2448	2592x1944	2048x1536	1920x1080	1024x768

- Capacity (1GB Size)

	12M			8M	5M	3M		1M
RAW	45	-	-	-	-	-	-	-
	33	-	-	-	-	-	-	-
	37	-	-	-	-	-	-	-
	39	-	-	-	-	-	-	-
	134	152	179	201	318	502	751	1833
	222	250	295	331	519	820	1198	2833
	333	375	442	494	769	1198	1731	3896

※ These figures are measured under Samsung standard conditions and may vary depending on shooting conditions and camera settings.

Effect

- Effect : Photo Style Selector, Image Adjust (Sharpness, Contrast, Saturation), Distortion Control
- Editing : Resize, Rotate, Photo Style Selector, Image Adjust (ACB, Face Retouch, Red Eye Fix, Brightness, Contrast, Saturation, Add Noise), Face Registration

Image Play

- Type : Single image, Thumbnails, Smart Album, Multi slide show, Movie Clip
- ※ Multi slide show : Slide show with Effect & Music

Specifications

Interface	- Digital output connector : USB 2.0 - Audio : Microphone: Stereo, Internal Speaker: Mono - Video output : NTSC, PAL (user selectable) - DC power input connector : 4.4 V
Power Source	- Rechargeable battery : SLB-11A, 3.8V (1130mAh) ※ Included battery may vary depending on sales region.
Dimensions (WxHxD)	- 116.1×82.8×91.1mm (excluding protrusions)
Weight	- Approx. 398g (without batteries and card)
Operating Temperature	- 0 ~ 40°C
Operating Humidity	- 5 ~ 85%
Software	- Samsung Master, Adobe Reader, QuickTime Player, Samsung RAW Converter

※ Specifications are subject to change without prior notice.

※ All trademarks are the property of their respective owners.

Software Notes

Please ensure that you read the instruction manual carefully before use.

- Under no circumstances should all or part of either the software or the user manual be reproduced.
- Copyrights for software are licensed only for use with a camera.
- In the unlikely event of a manufacturing fault, we will repair or exchange your camera.
We cannot, however, be held responsible in any way for damage caused by inappropriate use.
- Using a Hand-made PC or a PC and OS that has not been guaranteed by the manufacturer is not covered by the Samsung warranty.
- Before reading this manual, you should have a basic knowledge of computers and O/S (Operating Systems).

Software Notes

System Requirements

	For Windows	For Macintosh
USB Connection Specifications	PC with processor better than Pentium III 500MHz (Pentium III 800MHz recommended) Windows 2000 / XP / Vista Minimum 256MB RAM (Over 512MB recommended) 250MB of available hard disk space (Over 1GB recommend)	Power Mac G3 or later Mac OS 10.4 or later Minimum 256MB RAM (Over 512MB recommended) 110MB of available hard disk space
Software Support Specifications	1024x768 pixels, 16bit color display compatible monitor (24bit color display recommended) Microsoft DirectX 9.0c or later	-

- ※ It is not compatible with Windows XP and Vista 64-bit Edition.
- ※ Samsung is not responsible for any defects or damages caused by the use of unauthorized computer including an assembled PC.

QuickTime Player 7.6 : H.264(MPEG4.AVC) playback Requirements

For Windows	For Macintosh
Intel Pentium 4, 3.2GHz or later / AMD Athlon 64FX, 2.6GHz or later	1.8GHz Power Mac G5 or 1.83GHz Intel Core Duo or later Macintosh
Windows XP service pack2/Vista	Mac OS 10.4.10 or later
Minimum 512MB RAM (1GB recommended)	Minimum 256MB RAM (1GB recommended)
nVIDIA Geforce 7600GT or later / ATI X1600 series or later	64MB video card

About the software

After inserting the CD-ROM provided with this camera into the CD-ROM drive, the following window should automatically run.

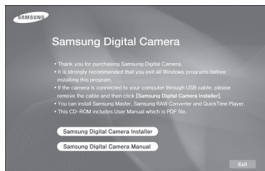

- You should allow 5 ~ 10 seconds for running the automatic setup program according to the capability of your computer. If the frame does not appear, run the [Windows Explorer] and select [Installer.exe] in the CD-ROM Drive root directory.

- **Samsung Master** : This is the all-in-one multi media software solution.

You can download, view, edit and save your digital images and movie clips with this software. This software is only compatible with Windows.

- **QuickTime Player 7.6** : The movie viewing program

QuickTime Player is a movie viewing program and is provided for the Windows OS only.

- **Samsung RAW Converter**: RAW data editing program

Files in a RAW (*.dng) format can be converted to JPEG or TIFF file formats.

Setting up the application software

To use this camera with a PC, install the application software first. After this has been done, the stored images in the camera can be moved to the PC and can be edited by an image editing program.

- You can visit the Samsung web-site through the internet.

<http://www.samsungcamera.com> : English
<http://www.samsungcamera.co.kr> : Korean

1. The auto run frame will display. Click the [Samsung Digital Camera Installer] menu in the Auto run frame.



2. Install the DirectX by selecting a button shown on the monitor. If a latest version of DirectX was installed on your computer, DirectX may not be installed.

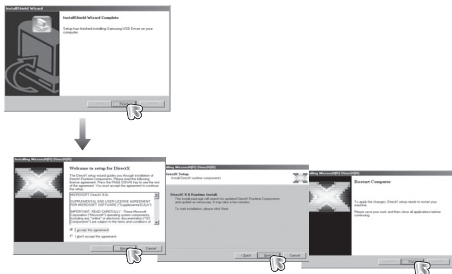

3. Install the Samsung Master in the order shown.

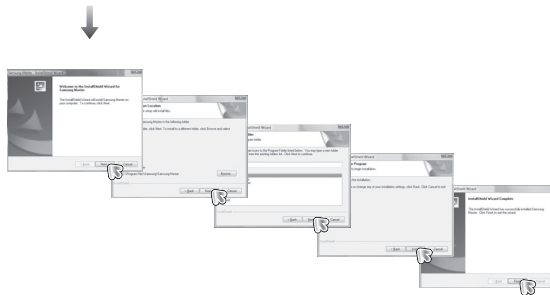
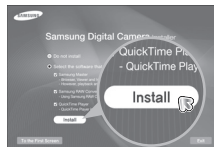

Setting up the application software

6. After restarting the computer, connect the PC to the camera with the USB cable.
7. Turn on the camera power. The [Found New Hardware Wizard] will open and the computer will recognise the camera.
 - ✕ If your OS is Windows XP / Vista, an image viewer program will open.

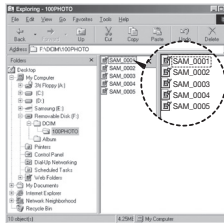

- PDF documents of user manual are included in the Software CD-ROM supplied with this camera. Search the PDF files with Windows explorer. Before opening the PDF files, you must install the Adobe Reader included in the Software CD-ROM. Install Adobe Reader from the CD provided. If the Internet is not enabled, install Adobe Reader by using the executable file located in the CD.
- To install the Adobe Reader 6.0.1 correctly, Internet Explorer 5.01 or later has to be installed. Visit "www.microsoft.com" and upgrade the Internet Explorer.

Starting PC mode

If you connect the USB cable to a USB port on your PC and then turn on the power, the camera will automatically switch to "computer connection mode". In this mode, you can download stored images to your PC through the USB cable.

■ Camera settings for connection

1. Turn on the camera.
2. Connect the camera and computer with the supplied USB cable.
3. Once the camera is turned on, the camera automatically recognizes the computer and is connected to it.

※ If automatic connection fails, set the [USB] menu to [Computer].
(p.69)

■ Connecting the camera to a PC

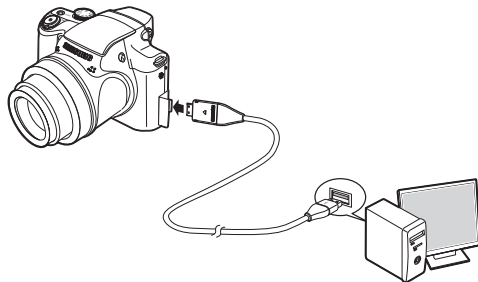

■ Disconnecting the camera and PC

Refer to page 109 (Removing the removable disk).

Starting PC mode

■ Downloading stored images

You can download the still images stored on the camera to your PC's hard disk and print them or use a photo editing software to edit them.

1. Connect the camera to your PC with the USB cable.

2. On your computer's desktop display, select [My computer] and double click [Removable Disk → DCIM → 100PHOTO]. The image files will then be displayed.

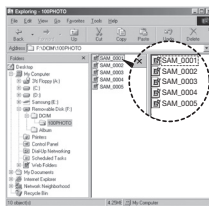

3. Select an image and press the right mouse button.

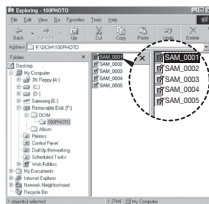

4. A pop-up menu will open.
Click the [Cut] or [Copy] menu.
 - [Cut] : cuts a selected file.
 - [Copy] : copies files.

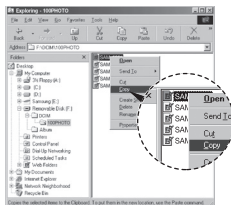

5. Click a folder where you want to paste the file.

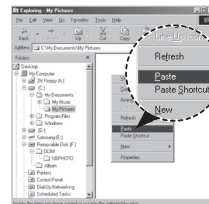

6. Press the right mouse button and a pop-up menu will open.
Click [Paste].

7. An image file is transferred from the camera to your PC.

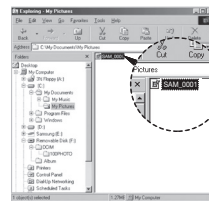

- By using [Samsung Master], you can see the stored images in the memory directly on the PC monitor and you can copy or move the image files.



- We recommend that you should copy the images to the PC to view them. Opening images directly from the removable disk may be subject to unexpected disconnection.
- When you upload a file that is not taken by this camera to the Removable Disk, the [File Error] message will be displayed on the LCD monitor in the PLAY mode, and nothing is displayed in THUMBNAIL mode.

Removing the removable disk

■ Windows 2000/XP/Vista

(The illustrations may differ from those shown depending on the Windows O/S.)

1. Check whether the camera and PC are transferring a file.
If the camera status lamp blinks, please wait until the lamp has finished blinking and is constantly on.

2. Double-click the [Unplug or Eject Hardware] icon on the task bar.



[Double-click!]

3. The [Unplug or Eject Hardware] window will open. Select the [USB Mass Storage Device] and click the [Stop] button.

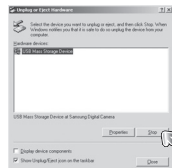

4. The [Stop a Hardware device] window will open. Select the [USB Mass Storage Device] and click the [OK] button.

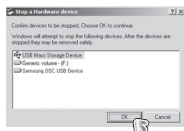

5. A [Safe to Remove Hardware] window will open. Click the [OK] button.



6. A [Unplug or Eject Hardware] window will open. Click the [Close] button and the removable disk will be removed safely.

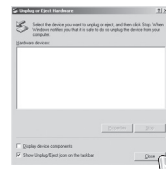

7. Unplug the USB cable.

Samsung Master

You can download, view, edit and save your images and movies with this software. This software is only compatible with Windows.

To start the program, click [Start → Programs → Samsung → Samsung Master].

■ Downloading images

1. Connect the camera to your PC.

2. A window for downloading images will be displayed after connecting the camera to your PC.

- To download the captured images, select the [Select All] button.

- Select desired folder in the window and click the [Select All] button. You can save captured images and selected folder.

- If you click the [Cancel] button, downloading will be cancelled.

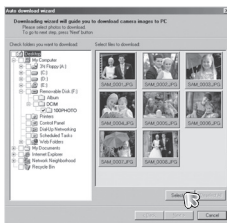

3. Click [Next >] button.

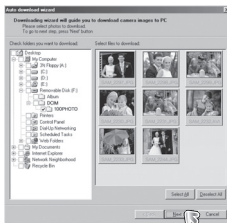

4. Select a destination and make a folder to save downloaded images and folders.

- Folder names can be made in order of date and images will be downloaded.

- Folder name will be made as you want and images will be downloaded.

- After selecting a folder that was made before, images will be downloaded.

5. Click [Next >] button.

6. A window will open as shown alongside. The destination of the selected folder will be displayed on the upper side of the window. Click the [Start] button to download the images.



7. Downloaded images will be displayed.

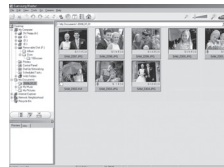
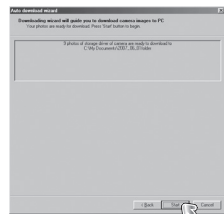

Samsung Master

■ Image viewer : You can view the stored images.

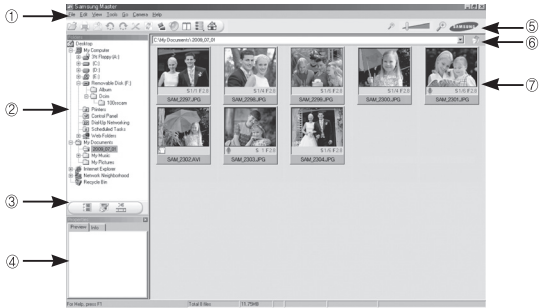

- Image viewer functions are listed below.

- ① Menu bar : You can select menus. File, Edit, View, Tools, Change functions, Auto download, help, etc.
 - ② Image selection window : You can select the desired images in this window.
 - ③ Media type selection menu : You can select image viewer, image edit and movie edit functions in this menu.
 - ④ Preview window : You can preview an image or a movie clip and check the multi media information.
 - ⑤ Zoom bar : You can change preview size.
 - ⑥ Folder display window : You can see the folder location of the selected image.
 - ⑦ Image display window : Images of the selected folder are displayed.
- ※ Refer to the [Help] menu in Samsung Master for further information.

■ Image edit : You can edit the still image.

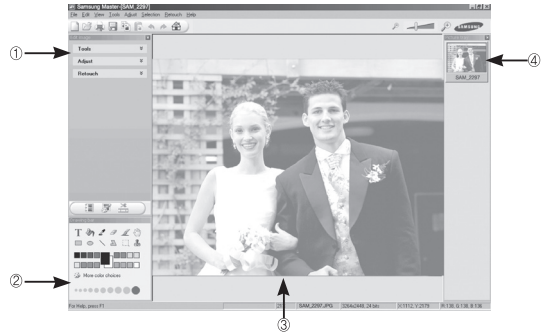

- Image edit functions are listed below.

- ① Edit menu : You can select the following menus.
 - [Tools] : You can resize or crop the selected image. See the [Help] menu.
 - [Adjust] : You can modify image quality. See the [Help] menu.
 - [Retouch] : You can change image or insert effects on the image. See the [Help] menu.
 - ② Drawing tools : Tools for editing an image.
 - ③ Image display window : A selected image displays in this window.
 - ④ Preview window : You can preview the changed image.
- ※ A still image edited with Samsung Master can't be played back on the camera.
- ※ Refer to the [Help] menu in Samsung Master for further information.

Using the Samsung RAW Converter

Using the Samsung RAW Converter, you can develop RAW files after editing them as you like. You can also edit JPEG or TIFF files in the same way you edit the RAW files. This software is only compatible with Windows OS. This software is only compatible with Windows XP and Vista. You can use this software using the Windows 98SE, ME, 2000. However, the complete operation can not be warranted for use.

To start the program, click [Start → All Programs → Samsung RAW Converter → Samsung RAW Converter]

■ Developing the RAW files

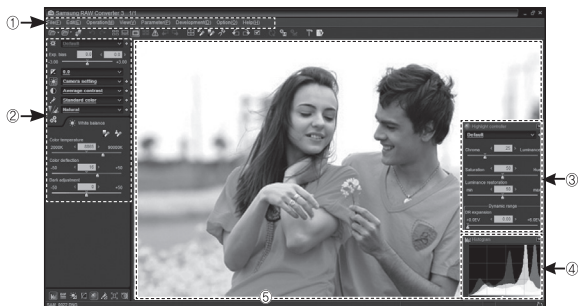

- Image edit functions are listed below.

- ① Menu bar
- ② Image editing tools
 - [Exposure bias] Compensates the exposure value.
 - [White balance] Adjusts the white balance value.
 - [Tone] Adjusts the contrast.
 - [Colour] Changes the colour.
 - [Sharpness] Adjusts the sharpness.
 - [Development] Previewing is available for the final output.
- ③ Highlight controller
 - Adjusts the saturation and highlights of the selected image.
- ④ Histogram
 - Displays the colour layers of the selected image.
- ⑤ Preview window
 - Displays the selected image.

 Refer to the [Help] menu in Samsung RAW Converter for further information.

Using the Samsung RAW Converter

Correcting the exposure

The main feature of the Samsung RAW Converter is that you can keep the best quality of the images as you make changes to the RAW files while editing.

After making changes to the brightness or contrast, you can still obtain the same result whichever you change first. The following images show how you can change the exposure to the image using the Samsung RAW Converter.

You can adjust the exposure by using the menu option as shown in the picture.

Menu option for adjusting the exposure.

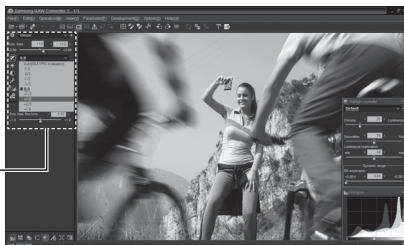

▲ Original image
P Mode, Aperture: f = 8,
Shutter Speed: 1/15sec, ISO = 64



▲ Changed image after
correcting the exposure.

You can see the changed results in the histogram windows as shown images:

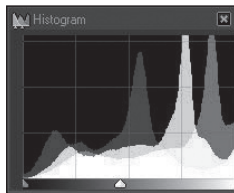

▲ Original image

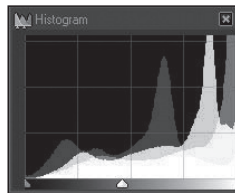

▲ Changed image after
correcting the exposure.

Using the Samsung RAW Converter

Handling the JPEG/TIFF files as you edit RAW files

Using the Samsung RAW Converter, you can handle the JPEG/TIFF files as you edit RAW files. You can adjust the white balance, sharpness, and reducing the noise is also available. The following images show how the contrast was changed on the TIFF image using the Samsung RAW Converter.

You can adjust the contrast by using the menu option as shown in the picture.

Menu option for adjusting the contrast

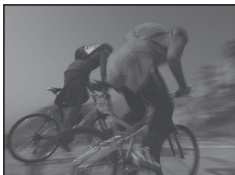
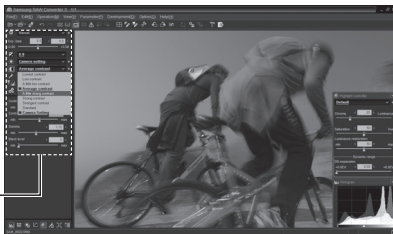

▲ Original image
P Mode, Aperture: f = 8,
Shutter Speed: 1/15sec, ISO = 64



▲ Changed image after
correcting the contrast.

Saving the RAW files into JPEG or TIFF format

You can save the RAW files into JPEG or TIFF format using the Samsung RAW Converter.

1. Choose the image you want to edit and then select [File(F)] → [Development...].



2. Select the type of file as JPEG or TIFF and then click [Save(S)].
- The selected file is saved as JPEG or TIFF format.

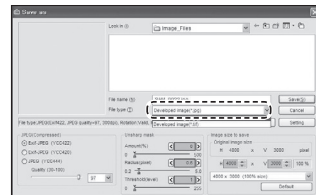

Setting up the USB Driver for MAC

1. A USB Driver for MAC is not included with the software CD as MAC OS supports the camera driver.
2. Check the MAC OS version during start-up. This camera is compatible with MAC OS 10.4.
3. Connect the camera to the Macintosh and turn the camera power on.
4. A new icon will be displayed on the desktop after connecting the camera to the MAC.

Using the USB Driver for MAC

1. Double click a new icon on the desktop and the folder in the memory will be displayed.
2. Select an image file and copy or move it to MAC.



- First complete uploading from computer to camera and then remove the removable disk with the Extract command.

FAQ

Please check the following if the USB connection malfunctions.

Case 1 USB cable is not connected or it is not the supplied USB cable.

→ Connect the supplied USB cable.

Case 2 The camera is not recognised by your PC. Sometimes, the camera may appear under [Unknown Devices] in Device Manager.

→ Turn off the camera, remove the USB cable, plug in the USB cable again, and then turn on the camera.

Case 3 There is an unexpected error during file transfer.

→ Turn the camera power off and on again. Transfer the file again.

Case 4 When using the USB hub.

→ There may be a problem in connecting the camera to the PC through the USB hub if the PC and the hub are not compatible. Wherever possible, connect the camera to the PC directly.

Case 5 Are other USB cables connected to the PC?

→ The camera may malfunction when it is connected to the PC at the same time as another USB cable. In this case, disconnect the other USB cable, and connect only one USB cable to the camera.

Case 6 When I open the Device Manager (by clicking Start → (Settings) → Control Panel → (Performance and Maintenance) → System → (Hardware) → Device Manager), there are Unknown Devices or Other Devices entries with a yellow question mark(?) beside them or devices with an exclamation mark(!) beside them.

→ Right-click on the entry with the question (?) or exclamation (!) mark and select "Remove". Restart the PC and connect the camera again.

Case 7 In some security programs (Norton Anti Virus, V3, etc.), the computer may not recognise the camera as a removable disk.

→ Stop the security programs and connect the camera to the computer. Refer to the security program instructions about how to temporarily disable the program.

Case 8 The camera is connected to the USB port located on the front of the computer.

→ When the camera is connected to the USB port located on the front of the computer, the computer may not recognise the camera. Connect the camera to the USB port located on the back of the computer.

FAQ

- When you can not playback the recorded movie clip on your computer.
 - ※ When you can not playback the recorded movie clip on your computer, it is mostly caused by the video codec installed on the computer.

[How to playback the H.264(MPEG4.AVC) movie clips]

- Using the QuickTime Player 7.6

Install the "QuickTime Player 7.6" provided in the CD.

(The QuickTime Player 7.6 supports the H.264(MPEG4.AVC) compression for videos.)

→ Plays back using the "QuickTime Player 7.6".

- How to use with installing United Codec

We recommend that install the latest United Codec. (Recommended Codec : K-Lite Codec Pack Full latest version)

→ Plays back using the "video player."

(When installed K-lite codec with its full version, the Media Player Classic or Windows Media Player 11 is recommended)

- ※ "QuickTime Player 7.6", "K-lite United Codec full version" should be installed in Windows ServicePack2 or later.
- ※ Although the computer is guaranteed as operated, the playback might be intermittent depending on an user's computer.

- When the DirectX 9.0c or later is not installed
 - Install the DirectX 9.0c or later
 - 1) Insert the CD provided with the camera
 - 2) Run the windows explorer and select the [CD-ROM drive:\DirectX] folder and click the DXSETUP.exe file.

The DirectX will be installed. Visit the following site for downloading the DirectX.<http://www.microsoft.com/directx>

- If a PC connected with the camera stops responding while Windows is starting.
 - In this case, disconnect the PC and the camera and Windows will start. If the problem happens continuously, set the Legacy USB Support to disable and re-start the PC. The Legacy USB Support is in the BIOS setup menu. (The BIOS setup menu differs from the PC manufacturers and some BIOS menus don't have Legacy USB Support) If you can't change the menu by yourself, contact to the PC manufacturer or BIOS manufacturer.

FAQ

- If the movie clip can't be deleted, or the removable disk can't be extracted or an error message displays during the file transfer.
 - If you install only the Samsung Master, the problems mentioned above occasionally happen.
 - Close the Samsung Master program by clicking the Samsung Master icon on the Taskbar.
 - Install all the application programs included in the software CD.
- When the screen ratio of movie player does not meet with monitor.
 - If the resolution of monitor is smaller than the resolution of recorded movie clip, the screen ratio of movie player may not meet with monitor.
Using the menu of movie player, you can adjust the screen ratio.

Correct disposal of batteries in this product



Correct disposal of batteries in this product
(Applicable in the European Union and other European countries with separate battery return systems.)

This marking on the battery, manual or packaging indicates that the batteries in this product should not be disposed of with other household waste at the end of their working life. Where marked, the chemical symbols Hg, Cd or Pb indicate that the battery contains mercury, cadmium or lead above the reference levels in EC Directive 2006/66. If batteries are not properly disposed of, these substances can cause harm to human health or the environment.

To protect natural resources and to promote material reuse, please separate batteries from other types of waste and recycle them through your local, free battery return system.

The rechargeable battery incorporated in this product is not user replaceable. For information on its replacement, please contact your service provider.

Correct Disposal of This Product



Correct Disposal of This Product (Waste Electrical & Electronic Equipment) (Applicable in the European Union and other European countries with separate collection systems)

This marking shown on the product or its literature, indicates that it should not be disposed with other household waste at the end of its working life. To prevent possible harm to the environment or human health from uncontrolled waste disposal, please separate this from other types of waste and recycle it responsibly to promote the sustainable re-use of material resources. Household users should contact either the retailer where they purchased this product, or their local government office, for details of where and how they can take this item for environmentally safe recycling. Business users should contact their supplier and check the terms and conditions of the purchase contract. This product should not be mixed with other commercial waste for disposal.

This Class [B] digital apparatus complies with Canadian ICES-003.



Samsung Eco-mark

It is Samsung's own symbol mark is used to effectively communicate Samsung's environmental friendly product activities to the consumers. The mark represents Samsung's continuous effort on development of environmental conscious products.



Please refer to the warranty that came with the product you purchased,
or go to our website <http://www.samsungcamera.com/> for after-sales service or inquiries.

