

The Samsung logo is located in the top left corner of the page. It consists of the word "SAMSUNG" in a bold, white, sans-serif font, enclosed within a white oval shape that has a slight gradient and shadow.

User Manual

WB700/WB710

This user manual includes detailed usage instructions for your camera. Please read this manual thoroughly.

 [Click a topic](#)

Basic troubleshooting

Quick reference

Contents

Basic functions

Extended functions

Shooting options

Playback/Editing

Settings

Appendixes

Index

Health and safety information

Always comply with the following precautions and usage tips to avoid dangerous situations and ensure peak performance of your camera.



Warning—situations that could cause injury to yourself or others

Do not disassemble or attempt to repair your camera.

This may result in electric shock or damage to the camera.

Do not use your camera near flammable or explosive gases and liquids.

This may cause a fire or explosion.

Do not insert flammable materials into the camera or store these materials near the camera.

This may cause a fire or electric shock.

Do not handle your camera with wet hands.

This may result in electric shock.

Prevent damage to subjects' eyesight.

Do not use the flash in close proximity (closer than 1 m/3 ft) to people or animals. If you use the flash too close to your subject's eyes, this can cause temporary or permanent eyesight damage.

Keep your camera away from small children and pets.

Keep your camera and all accessories out of the reach of small children and animals. Small parts may cause choking or serious injury if swallowed. Moving parts and accessories may present physical dangers as well.

Do not expose the camera to direct sunlight or high temperatures for an extended period of time.

Prolonged exposure to sunlight or extreme temperatures can cause permanent damage to your camera's internal components.

Avoid covering the camera or charger with blankets or clothes.

The camera may overheat, which may distort the camera or cause a fire.

If liquid or foreign objects enter your camera, immediately disconnect all power sources, such as the battery or charger, and then contact a Samsung service center.



Caution—situations that could cause damage to your camera or other equipment

Remove the batteries from your camera when storing it for an extended period of time.

Installed batteries may leak or corrode over time and cause serious damage to your camera.

Use only authentic, manufacturer-recommended, Lithium-ion replacement batteries. Do not damage or heat the battery.

Inauthentic, damaged, or heated batteries may cause a fire or personal injury.

Use only Samsung-approved batteries, chargers, cables and accessories.

- Using unauthorized batteries, chargers, cables or accessories can cause batteries to explode, damage your camera, or cause injury.
- Samsung is not responsible for damage or injuries caused by unapproved batteries, chargers, cables or accessories.

Use the battery only for its intended purpose.

Misusing the battery may cause a fire or electric shock.

Do not touch the flash while it fires.

The flash is very hot when fired and may burn your skin.

When you use AC charger, turn off the camera before you disconnect the power to the AC charger.

Failing to do so may result in fire or electric shock.

Disconnect the charger from the wall socket when not in use.

Failing to do so may result in fire or electric shock.

Do not use a damaged power supply cord, plug, or loose outlet when you charge batteries.

This may cause a fire or electric shock.

Do not allow the AC charger to come in contact with the +/- terminals on the battery.

This may cause a fire or electric shock.

Do not force the camera's parts or apply pressure to the camera.

This may cause your camera to malfunction.

Exercise caution when you connect cables or adapters and install batteries and memory cards.

If you force the connectors, improperly connect cables, or improperly install batteries and memory cards, you can damage ports, connectors, and accessories.

Keep cards with magnetic strips away from the camera case.

Information stored on the card may be damaged or erased.

Never use a damaged charger, battery, or memory card.

This may result in electric shock or camera malfunction or cause a fire.

Check that the camera is operating properly before use.

The manufacturer takes no responsibility for any loss of files or damage that may result from camera malfunction or improper use.

You must plug the end of the cable with the indicator light (▲) into your camera.

If the cable is reversed, it may damage your files. The manufacturer is not responsible for any loss of data.

Copyright information

- Microsoft Windows and the Windows logo are registered trademarks of the Microsoft Corporation.
- Mac is a registered trademark of the Apple Corporation.
- HDMI, the HDMI logo and the term "High Definition Multimedia Interface" are trademarks or registered trademarks of HDMI Licensing LLC.
- Trademarks and trade names used in this manual are the property of their respective owners.

- Camera specifications or contents of this manual may be changed without prior notice due to upgrade of camera functions.
- You are not allowed to reuse or distribute any part of this manual without prior permission.
- For Open Source License information, refer to the 'OpenSourceInfo.pdf' in the provided CD-ROM.

Outline of the User Manual

Basic functions 12

Learn about your camera's layout, icons, and basic functions for shooting.

Extended functions 31

Learn how to capture a photo, record a video, and voice memo by selecting a mode.

Shooting options 45

Learn how to set the options in Shooting mode.

Playback/Editing 71

Learn how to play back photos, videos, or voice memos and edit photos or videos. Also, learn how to connect your camera to your computer, photo printer, TV, or HDTV.



Settings 96

Refer to options to configure your camera's settings.

Appendixes 102

Get information about error messages, specifications, and maintenance.

Indicators used in this manual

Shooting mode	Indicator
Smart Auto	
Program	P
Aperture Priority	A
Shutter Priority	S
Manual	M
DUAL IS	
Scene	SCN
Movie	

Shooting mode icons

These icons appear in the text when a function is available in a mode. See the example below.

Note: The **SCN** mode may not support functions for all scenes.

For example:

Adjusting the exposure manually (EV)

P A S 





Depending on the intensity of the ambient light, your photos may be too bright or dark. In these cases, you can adjust the exposure to get a better photo.



Darker (-) Neutral (0) Brighter (+)

Available in Program, Aperture Priority, Shutter Priority, DUAL IS, and Movie modes

Icons used in this manual

Icon	Function
	Additional information
	Safety warnings and precautions
[]	Camera buttons. For example, [Shutter] represents the shutter button.
()	Page number of related information
→	The order of options or menus you must select to perform a step; for example: Select  → Photo Size (represents Select  , and then select Photo Size).
*	Annotation

Abbreviations used in this manual

Abbreviation	Definition
AEB	Auto Exposure Bracket
AF	Auto Focus
DIS	Digital Image Stabilization
DPOF	Digital Print Order Format
EV	Exposure Value
ISO	International Organization for Standardization
OIS	Optical Image Stabilization
WB	White Balance

Expressions used in this manual

Pressing the shutter

- Half-press [**Shutter**]: press the shutter halfway down
- Press [**Shutter**]: press the shutter all the way down

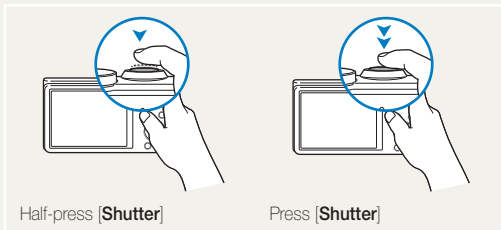

Exposure (Brightness)

The amount of light that enters your camera determines the exposure. You can alter the exposure with shutter speed, aperture value, and ISO sensitivity. By altering the exposure, your photos will be darker or lighter.



Normal exposure

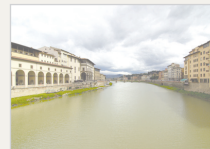

Overexposure (too bright)





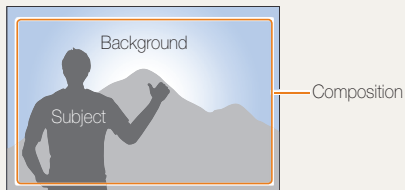







Subject, background, and composition

- **Subject**: the main object in a scene, such as a person, animal, or still life
- **Background**: the objects around the subject
- **Composition**: the combination of a subject and background



Basic troubleshooting

Learn to solve common problems by setting shooting options.

	The subject's eyes appear red.	<p>Red eye occurs when the subject's eyes reflect light from the camera flash.</p> <ul style="list-style-type: none">• Set the flash option to  Red-eye or  Red-eye Fix. (p. 49)• If the photo has already been captured, select  Red-eye Fix in the edit menu. (p. 84)
	Photos have dust spots.	<p>If dust particles are present in the air, you may capture them in photos when you use the flash.</p> <ul style="list-style-type: none">• Turn off the flash or avoid capturing photos in a dusty place.• Set ISO sensitivity options. (p. 51)
	Photos are blurred.	<p>Blurring can occur if you capture photos in low light conditions or hold the camera incorrectly.</p> <ul style="list-style-type: none">• Use the OIS function or half-press [Shutter] to ensure the subject is focused. (p. 29)• Use the  DUAL mode. (p. 40)
	Photos are blurred when shooting at night.	<p>As the camera tries to let in more light, the shutter speed slows. This can make it difficult to hold the camera steady long enough to take a clear picture and may result in camera shake.</p> <ul style="list-style-type: none">• Select  Night in SCN mode. (p. 34)• Turn on the flash. (p. 49)• Set ISO sensitivity options. (p. 51)• Use a tripod to prevent your camera from shaking.
	Subjects come out too dark because of backlighting.	<p>When the light source is behind the subject or when there is a high contrast between light and dark areas, the subject may appear too dark.</p> <ul style="list-style-type: none">• Avoid shooting toward the sun.• Select  Backlight in SCN mode. (p. 34)• Set the flash option to  Fill in. (p. 49)• Adjust the exposure. (p. 61)• Set the metering option to  Spot if a bright subject is in the center of the frame. (p. 62)

Quick reference



Capturing photos of people

- **SCN** mode > Beauty Shot ▶ 34
- Red-eye/Red-eye Fix (to prevent or correct red-eye) ▶ 49
- Face Detection ▶ 56



Capturing photos at night or in the dark

- **SCN** mode > Night, Dawn, Sunset ▶ 34
- Flash options ▶ 49
- ISO sensitivity (to adjust the sensitivity to light) ▶ 51



Capturing action photos

- **S** mode ▶ 38
- Continuous, Motion Capture ▶ 66



Adjusting the exposure (brightness)

- ISO sensitivity (to adjust the sensitivity to light) ▶ 51
- EV (to adjust exposure) ▶ 61
- Metering ▶ 62
- AEB (to capture 3 photos of the same scene with different exposures) ▶ 66



Capturing photos of text, insects, or flowers

- **SCN** mode > Text ▶ 34
- Macro ▶ 52



Applying effects to photos

- Smart Filter effects ▶ 67
- Image Adjust (to adjust Contrast, Sharpness, or Saturation) ▶ 70



Reducing camera shake

- Optical Image Stabilization (OIS) ▶ 28
- **DUAL** mode ▶ 40

- Viewing files by category in Smart Album ▶ 74
- Viewing files as thumbnails ▶ 75
- Deleting all files on the memory card ▶ 76
- Viewing files as a slide show ▶ 78
- Viewing files on a TV or HDTV ▶ 87
- Connecting your camera to a computer ▶ 89
- Adjusting sound and volume ▶ 98
- Adjusting the brightness of the display ▶ 99
- Changing the display language ▶ 99
- Setting the date and time ▶ 99
- Before contacting a service center ▶ 112

Contents

Basic functions	12
Unpacking	13
Camera layout	14
Inserting the battery and memory card	16
Charging the battery and turning on your camera	17
Charging the battery	17
Turning on your camera	17
Performing the initial setup	18
Learning icons	20
Selecting options or menus	21
Setting the display and sound	23
Setting the display type	23
Setting the sound	24
Setting the user button	24
Capturing photos	25
Zooming	26
Reducing camera shake (OIS)	28
Tips for getting a clearer photo	29

Extended functions	31
Using the Smart Auto mode	32
Using the Scene mode	34
Using the Beauty Shot mode	34
Using the Program mode	36
Using the Aperture Priority, Shutter Priority, or Manual mode	37
Using the Aperture Priority mode	38
Using the Shutter Priority mode	38
Using the Manual mode	39
Using the DUAL IS mode	40
Using the Movie mode	41
Using the Smart Scene Detection mode	43
Recording voice memos	44
Recording a voice memo	44
Adding a voice memo to a photo	44

Shooting options	45	Using Face Detection	56
Selecting a resolution and quality	46	Detecting faces	56
Selecting a resolution	46	Capturing a self portrait shot	57
Selecting image quality	47	Capturing a smile shot	57
Using the timer	48	Detecting eye blinking	58
Shooting in the dark	49	Using Smart Face Recognition	58
Preventing red-eye	49	Registering faces as your favorites (My Star)	59
Using the flash	49	Adjusting brightness and color	61
Adjusting the ISO sensitivity	51	Adjusting the exposure manually (EV)	61
Changing the camera's focus	52	Changing the metering option	62
Using macro	52	Selecting a light source (White balance)	63
Using auto focus	52	Using drive modes	66
Focusing on a selected area	54	Applying effects/Adjusting images	67
Using tracking auto focus	54	Applying Smart Filter effects	67
Adjusting the focus area	55	Adjusting your photos	70

Playback/Editing	71
Viewing photos or videos in Playback mode	72
Starting Playback mode	72
Viewing photos	77
Playing a video	79
Playing a voice memo	80
Editing a photo	82
Resizing photos	82
Rotating a photo	82
Applying Smart Filter effects	83
Adjusting your photos	84
Creating a print order (DPOF)	86
Viewing files on a TV or HDTV	87
Transferring files to your Windows computer	89
Transferring files with Intelli-studio	90
Transferring files by connecting the camera as a removable disk	92
Disconnecting the camera (for Windows XP)	93
Transferring files to your Mac computer	94
Printing photos with a PictBridge photo printer	95

Settings	96
Settings menu	97
Accessing the settings menu	97
Sound	98
Display	98
Settings	99
Appendixes	102
Error messages	103
Camera maintenance	104
Cleaning your camera	104
Using or storing the camera	105
About memory cards	106
About the battery	108
Before contacting a service center	112
Camera specifications	115
Glossary	119
FCC notice	124
Index	125

Basic functions

Learn about your camera's layout, icons, and basic functions for shooting.

Unpacking	13	Setting the display and sound	23
Camera layout	14	Setting the display type	23
Inserting the battery and memory card ...	16	Setting the sound	24
Charging the battery and turning on your camera	17	Setting the user button	24
Charging the battery	17	Capturing photos	25
Turning on your camera	17	Zooming	26
Performing the initial setup	18	Reducing camera shake (OIS)	28
Learning icons	20	Tips for getting a clearer photo	29
Selecting options or menus	21		

Unpacking

The following items are included in your product box.



Camera



AC adapter/
USB cable

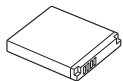

Rechargeable battery



Strap

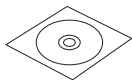

User Manual CD-ROM



Quick Start Manual

Optional accessories. Not included.



Camera case

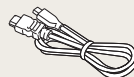

HDMI cable

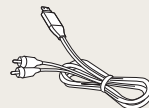

AV cable

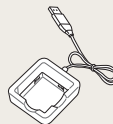

Battery charger



Memory card



The illustrations may differ slightly from the items shipped with your product.

Camera layout

Before you start, familiarize yourself with your camera's parts and their functions.

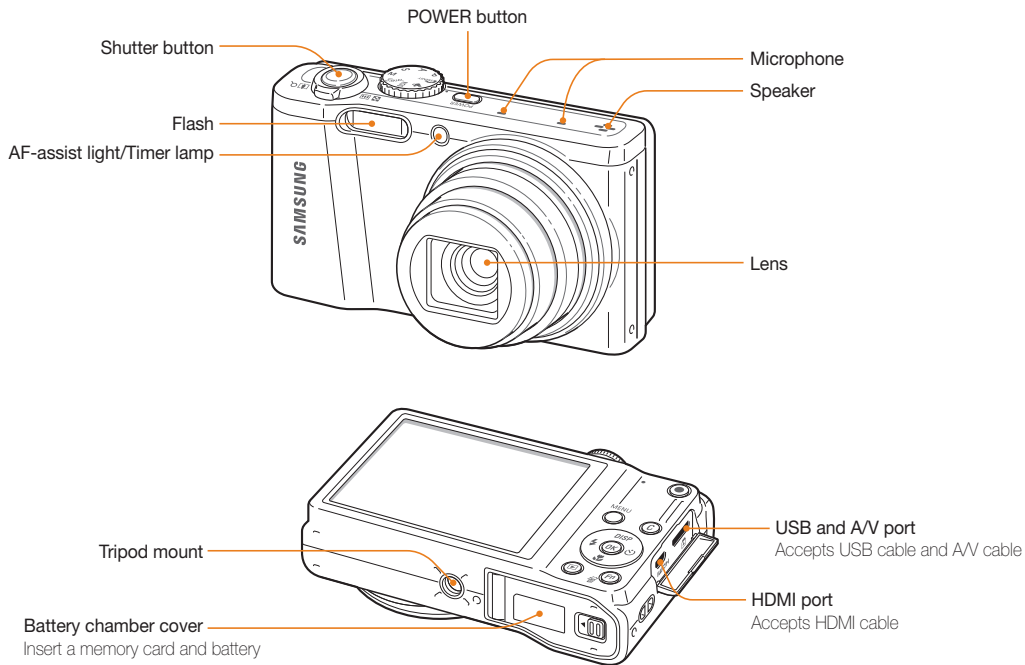

Camera layout

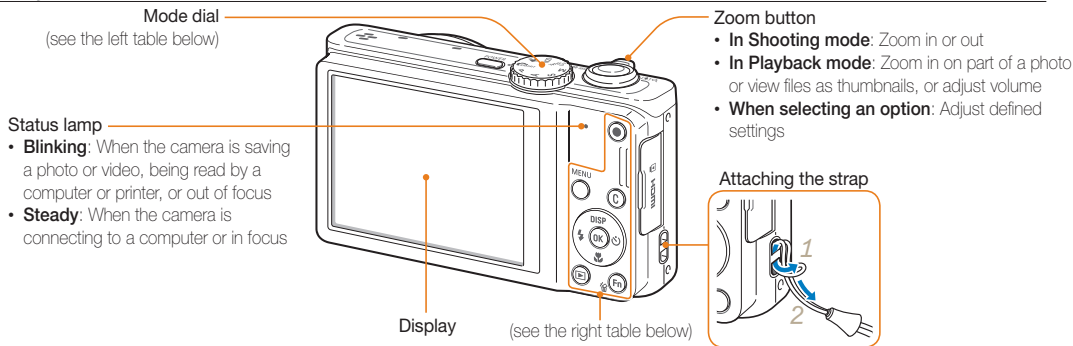

Icon	Description
	Smart Auto: Capture a photo with a scene mode selected automatically by the camera.
P	Program: Capture a photo by setting options except the shutter speed and aperture value which the camera sets automatically.
A	Aperture Priority: The camera selects a shutter speed based on the aperture value you have set manually.
S	Shutter Priority: The camera selects an aperture value based on the shutter speed you have set manually.
M	Manual: Adjust various camera settings including shutter speed and aperture value.
	DUAL IS: Capture a photo with options that reduce camera shake.
SCN	Scene: Capture a photo with options preset for a specific scene.
	Movie: Customize settings to record a video.

Button	Description															
	Start recording a video.															
	Access options or menus.															
	Access an option that you have selected. (p. 24)															
	<table border="1"> <thead> <tr> <th></th> <th>Basic functions</th> <th>Other functions</th> </tr> </thead> <tbody> <tr> <td></td> <td>Change the display option.</td> <td>Move up</td> </tr> <tr> <td></td> <td>Change the macro option.</td> <td>Move down</td> </tr> <tr> <td></td> <td>Change the flash option.</td> <td>Move left</td> </tr> <tr> <td></td> <td>Change the timer option.</td> <td>Move right</td> </tr> </tbody> </table>		Basic functions	Other functions		Change the display option.	Move up		Change the macro option.	Move down		Change the flash option.	Move left		Change the timer option.	Move right
	Basic functions	Other functions														
	Change the display option.	Move up														
	Change the macro option.	Move down														
	Change the flash option.	Move left														
	Change the timer option.	Move right														
	Confirm the highlighted option or menu.															
	Enter Playback mode.															
	<ul style="list-style-type: none"> Access options in Shooting mode. Delete files in Playback mode. 															

Inserting the battery and memory card

Learn how to insert the battery and an optional memory card into the camera.

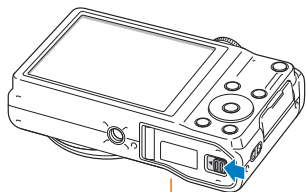

Insert a memory card with the gold-colored contacts facing up.

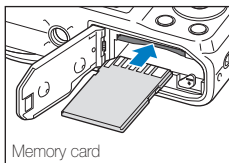

Insert the battery with the Samsung logo facing up.

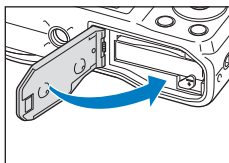
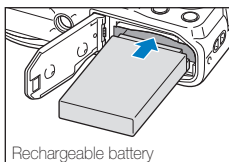

Removing the battery and memory card

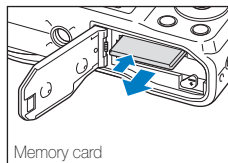

Push the card gently until it disengages from the camera, and then pull it out of the slot.

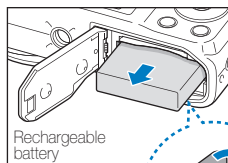

Slide the lock down to release the battery.

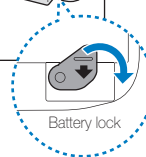

You can use the internal memory for temporary storage if a memory card is not inserted.

Charging the battery and turning on your camera

Charging the battery

Before you use the camera for the first time, you must charge the battery. Attach the USB cable to the AC adapter, and then plug the end of cable with the indicator light into your camera.

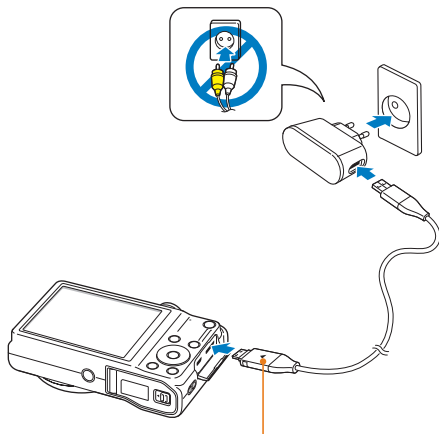

Indicator light

- **Red:** Charging
- **Orange:** Error
- **Green:** Fully charged

Turning on your camera

Press **[POWER]** to turn your camera on or off.

- The initial setup screen appears when you turn on the camera for the first time. (p. 18)

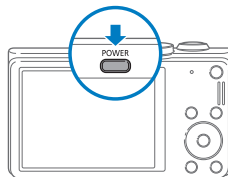

Turning on your camera in Playback mode

Press **[▶]**. The camera turns on and immediately accesses Playback mode.

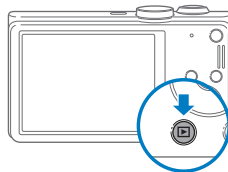

If you turn on your camera by pressing and holding **[▶]** for about 5 seconds, the camera does not emit any sounds.

Performing the initial setup

When the initial setup screen appears, follow the steps below to configure the camera's basic settings.

- 1 Press [OK] to select **Language**, and then press [OK] or [OK].

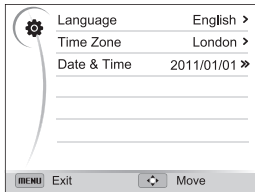

- 2 Press [DISP/🌿/⚡/🕒] to select a language, and then press [OK].
- 3 Press [🌿] to select **Time Zone**, and then press [OK] or [OK].

- 4 Press [DISP/🌿] to select **Home**, and then press [OK].
 - When you travel to another country, select **Visit**, and then select a new time zone.
- 5 Press [⚡] or [🕒] to select a time zone, and then press [OK].
 - To set daylight-savings time, press [DISP].



- 6 Press [**⚡**] → [**👉**] to select **Date & Time**, and then press [**👈**] or [**OK**].

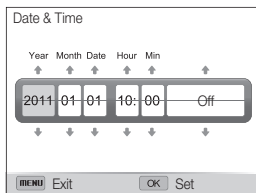

- 7 Press [**⚡**] or [**👈**] to select an item.
- 8 Press [**DISP**] or [**👉**] to set the date and time or select a date format, and then press [**OK**].
- 9 Press [**MENU**] to switch to Shooting mode.

Learning icons

The icons the camera displays on the screen change according to the mode you select or the options you set.

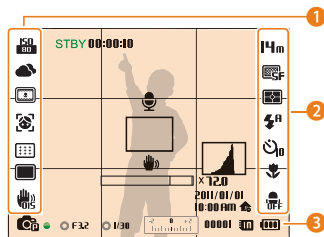

1 Shooting options (left)

Icon	Description
	ISO sensitivity
	White Balance
	Smart filter
	Image adjustment (contrast, sharpness, and saturation)
	Face detection
	Face tone
	Face retouch
	Focus area
	Drive type
	Optical Image Stabilization (OIS)

2 Shooting options (right)

Icon	Description
	Photo resolution
	Video resolution
	Photo quality
	Frame rate
	Metering
	Flash
	Flash intensity
	Timer
	Auto focus option
	Microphone muted
	Smart zoom on

3 Shooting information

Icon	Description
	Shooting mode
	Focus
F3.2	Aperture value
1/30	Shutter speed
	Exposure value

Icon	Description
00001	Available number of photos
	Memory card not inserted (Internal memory)
	Memory card inserted
	<ul style="list-style-type: none"> : Fully charged : Partially charged : Empty (Recharge)
00:00:10	Available recording time
	Voice memo
	Auto focus frame
	Camera shake
	Zoom indicator
x 12.0	Zoom ratio
	Histogram (p. 23)
2011/01/01 10:00 AM	Current time and date

Selecting options or menus

You can select options by pressing **[MENU]**, and then pressing **[DISP/↓/⚡/☺]**, or **[OK]**.

 You can also access shooting options by pressing **[Fn]**, but some options may not be available.

1 In Shooting mode, press **[MENU]**.

2 Select an option or menu.

- To move up or down, press **[DISP/↓]**.
- To move left or right, press **[⚡/☺]**.

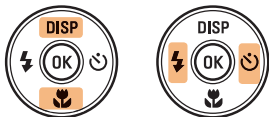

3 Press **[OK]** to confirm the highlighted option or menu.

Going back to the previous menu

Press **[MENU]** again to go back to the previous menu.

 Half-press **[Shutter]** to return to Shooting mode.

For example, to select a White Balance option in Program mode:

- 1 Rotate the mode dial to **P**.



- 2 Press **[MENU]**.

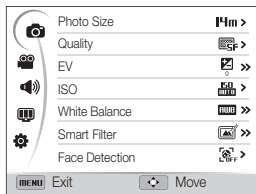

- 3 Press **[DISP/🌸]** to select **📷**, and then press **[👉]** or **[OK]**.

- 4 Press **[DISP/🌸]** to select **White Balance**, and then press **[👉]** or **[OK]**.

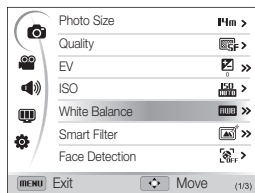

- 5 Press **[⚡/👉]** to select a White Balance option.

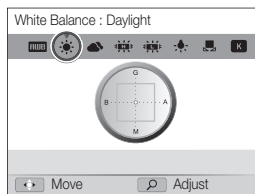

- 6 Press **[OK]** to save your settings.
- 7 Press **[MENU]** to return to Shooting mode.

Setting the display and sound

Learn how to change the basic display information, sound settings, and user button settings.

Setting the display type

You can select a display type for the Shooting or Playback mode. Each type displays different shooting or playback information. See the table below

Press **[DISP]** repeatedly to change the display type.

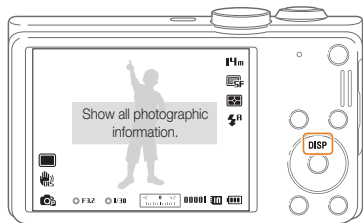

Mode	Display Type Choices
Shooting	<ul style="list-style-type: none">• Hide all information about shooting.• Hide information about shooting, except the information on the bottom line.• Display all information about shooting.• Display histogram.
Playback	<ul style="list-style-type: none">• Hide all information about the current file.• Display all information about the current file.• Display information about the current file, except the shooting settings and histogram.

About histograms

A histogram is a graph that illustrates how light is distributed in your photo. If the histogram has a high peak on the left, the photo is underexposed and will appear dark. A peak on the right of the graph means that the photo is overexposed and will appear washed out. The height of the peaks is related to color information. The more of a particular color, the taller the peak.

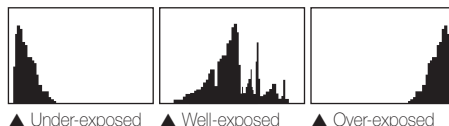

Setting the sound

Set the sound your camera emits when you perform functions.

- 1 In Shooting or Playback mode, press **[MENU]**.
- 2 Select  → **Beep Sound**.
- 3 Select an option.

Option	Description
Off	The camera does not emit any sounds.
1/2/3	The camera emits sounds.

Setting the user button

You can directly access an option by setting the user button.

- 1 In Shooting mode, press **[MENU]**.
- 2 Select  → **Custom Set**.
- 3 Select an option. (EV, ISO, White Balance)
 - Press **(C)** to adjust the settings of the option.

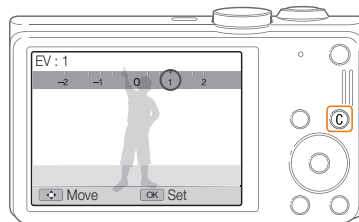

Capturing photos

Learn how to capture photos easily and quickly in Smart Auto mode.

- 1 Rotate the mode dial to **SMART**.



- 2 Align your subject in the frame.

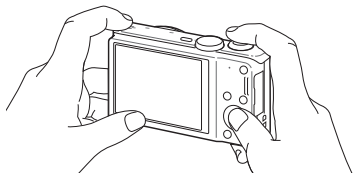

- 3 Half-press **[Shutter]** to focus.

- A green frame means the subject is in focus.
- A red frame means the subject is out of focus.

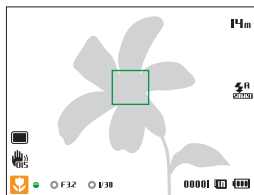

- 4 Press **[Shutter]** to capture a photo.



See page 29 for tips to get clearer photos.

Zooming

You can capture close-up photos by adjusting the zoom. Your camera has an 18X Optical zoom and 4X Digital zoom. You can also use a 24X Smart zoom and 3X Digital zoom to zoom in on a subject with less quality deterioration.

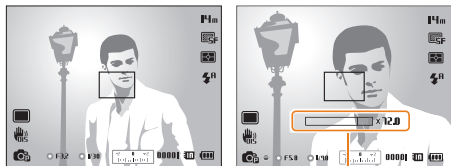

Zoom ratio



The available zoom ratio for videos differs from the photo zoom ratio.

Digital zoom P A S M SCN

The Digital zoom is supported by default in Shooting mode. If you zoom in on a subject in Shooting mode and the zoom indicator is in the digital range, your camera is using the Digital zoom. By using both the Optical zoom and Digital zoom, you can zoom in up to 72 times.

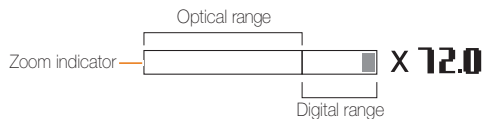

- The Digital zoom is not available with the Face detection option, Smart Filter effect, Tracking AF option, Drive option, or Manual Focus.
- If you capture a photo with the Digital zoom, the photo quality may be lower than normal.

Smart zoom P A S M

Smart zoom lets you zoom in a subject without less picture quality degradation than when you use the Optical zoom and Digital zoom. By using both the Smart zoom and Digital zoom, you can zoom in up to 72 times.

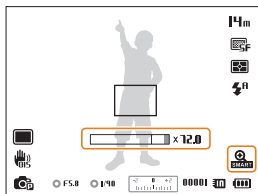

- Smart zoom is not available with the Face detection option, Smart Filter effect, Tracking AF option, Drive option, or Manual Focus.
- If you capture a photo with the Smart zoom, the photo quality may be lower than normal.

Setting Smart zoom

- 1 In Shooting mode, press **[MENU]**.
- 2 Select → **Smart Zoom**.
- 3 Select an option.

Icon	Description
	Off: The Smart zoom is deactivated.
	On: The Smart zoom is activated.

Reducing camera shake (OIS) P A S M SCN 📷

Reduce camera shake optically in Shooting mode.

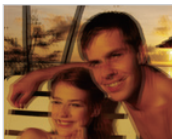

Before correction





After correction

1 In Shooting mode, press **[MENU]**.

2 Select  or  → **OIS**.

3 Select an option.

Icon	Description
	Off: OIS is deactivated.
	On: OIS is activated.



- OIS may not function properly when:
 - you move your camera to follow a moving subject
 - you use the Digital zoom
 - there is too much camera shake
 - the shutter speed is slow (for example, when you capture night scenes)
 - the battery is low
 - you capture a close-up shot
- If you use the OIS function with a tripod, your images may be blurred by the vibration of the OIS sensor. Deactivate the OIS function when you use a tripod.
- If the camera is hit or dropped, the display will be blurry. If this occurs, turn off the camera, and then turn it on again.

Tips for getting a clearer photo

☺ Holding your camera correctly

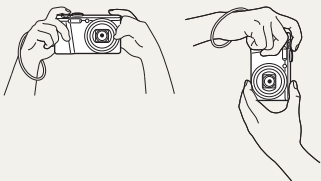

Ensure nothing is blocking the lens.

☺ Half-pressing the shutter button

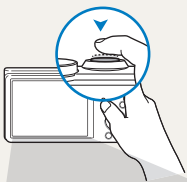

Half-press **[Shutter]** and adjust the focus. The camera adjusts the focus and exposure automatically.

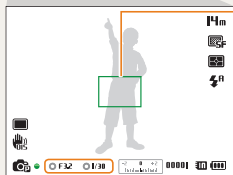

Focus frame

- Press **[Shutter]** to capture the photo if the focus frame appears in green.
- Change the composition and half-press **[Shutter]** again if the focus frame appears in red.

The camera sets the aperture value and shutter speed automatically.

☺ Reducing camera shake



- Set the Optical Image Stabilization option to reduce camera shake optically. (p. 28)
- Select the **DUAL** mode to reduce camera shake both optically and digitally. (p. 40)

☺ When 🖐️ is displayed

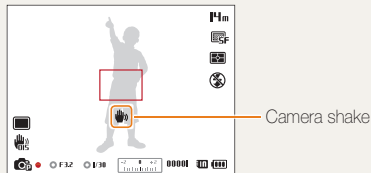

When you shoot in the dark, avoid setting the flash option to **Slow Sync** or **Off**. The aperture remains open longer and it may be harder to hold the camera steady long enough to take a clear picture.

- Use a tripod or set the flash option to **Fill in**. (p. 49)
- Set ISO sensitivity options. (p. 51)



Preventing your subject from being out of focus

It may be difficult to get your subject in focus when:

- there is little contrast between the subject and background (for example, when your subject is wearing clothing that is similar in color to the background)
- the light source behind the subject is too bright
- the subject is shiny or reflective
- the subject includes horizontal patterns, such as blinds
- the subject is not positioned in the center of the frame



Using the focus lock

Half-press **[Shutter]** to focus. When the subject is in focus, you can reposition the frame to change the composition. When you are ready, press **[Shutter]** to capture your photo.

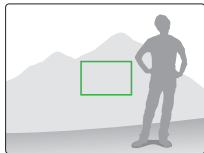
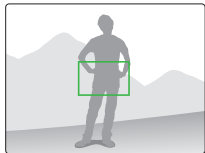

- When you capture photos in low light



Turn on the flash.
(p. 49)

- When subjects are moving rapidly

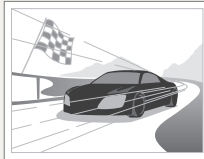

Use the Continuous
or Motion Capture
function. (p. 66)

Extended functions

Learn how to capture a photo, record a video, and voice memo by selecting a mode.







Using the Smart Auto mode	32	Using the DUAL IS mode	40
Using the Scene mode	34	Using the Movie mode	41
Using the Beauty Shot mode	34	Using the Smart Scene Detection mode ...	43
Using the Program mode	36	Recording voice memos	44
Using the Aperture Priority, Shutter Priority, or Manual mode	37	Recording a voice memo	44
Using the Aperture Priority mode	38	Adding a voice memo to a photo	44
Using the Shutter Priority mode	38		
Using the Manual mode	39		

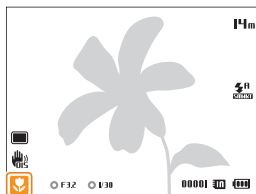









Using the Smart Auto mode

In Smart Auto mode, your camera automatically chooses the appropriate camera settings based on the type of scene it detects. The Smart Auto mode is helpful if you are not familiar with the camera settings for various scenes.

- 1 Rotate the mode dial to .
- 2 Align your subject in the frame.
 - The camera automatically selects a scene. An appropriate scene icon appears at the bottom left of the screen. The icons are listed below.



Icon	Description
	Landscapes
	Scenes with bright white backgrounds
	Landscapes at night (when the flash is off)
	Portraits at night
	Landscapes with backlighting
	Portraits with backlighting

Icon	Description
	Portraits
	Close-up photos of objects
	Close-up photos of text
	Sunsets
	Clear skies
	Forested areas
	Close-up photos of colorful subjects
	Camera is stabilized or on a tripod (when shooting in the dark)
	Actively moving subjects
	Fireworks (when using a tripod)

- 3 Half-press **[Shutter]** to focus.
 - In several scenes, the camera automatically captures a photo when you half-press **[Shutter]**.
- 4 Press **[Shutter]** to capture the photo.



- If the camera does not recognize an appropriate scene mode, it uses the default settings for the SMART mode.
- Even if it detects a face, the camera may not select a portrait mode depending on the subject's position or lighting.
- The camera may not select the correct scene depending on the shooting conditions, such as camera shake, lighting, or distance to the subject.
- Even if you use a tripod, the camera may not detect the mode if the subject is moving.
- In SMART mode, the camera consumes more battery power, because it changes settings often to select appropriate scenes.

Using the Scene mode

In Scene mode, you can capture a photo with options that are preset for a specific scene.

- 1 Rotate the mode dial to **SCN**.
- 2 Select a scene.

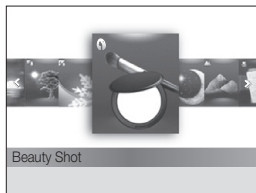

- To change a scene mode, press **[MENU]**, and then select **SCENE**. You can select any of the scenes listed.
 - For the Beauty Shot mode, see "Using the Beauty Shot mode" in the next column.
- 3 Align your subject in the frame, and then half-press **[Shutter]** to focus.
 - 4 Press **[Shutter]** to capture the photo.

Using the Beauty Shot mode

In Beauty Shot mode, you can capture a portrait with options to hide facial imperfections.

- 1 Rotate the mode dial to **SCN**.
- 2 Select **Beauty Shot**.
- 3 Press **[MENU]**.
- 4 Select  → **Face Tone**.
- 5 Select an option.
 - For example, increase the face tone setting to make skin appear lighter.

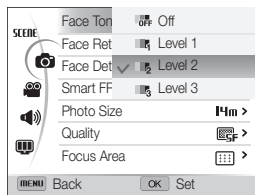

- 6 Select **Face Retouch**.

7 Select an option.

- For example, increase the face retouch setting to hide more imperfections.

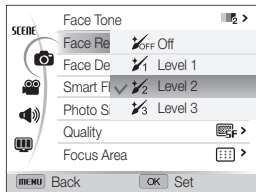

8 Press **[MENU]** to return to Shooting mode.

9 Align your subject in the frame, and then half-press **[Shutter]** to focus.

10 Press **[Shutter]** to capture the photo.



When you use the Beauty Shot mode, the focus distance will be set to Auto Macro.

Using the Program mode

In Program mode, you can set most options, except the shutter speed and aperture value, which the camera sets automatically.

- 1 Rotate the mode dial to **P**.
- 2 Set the desired options. (For a list of options, refer to page 45.)

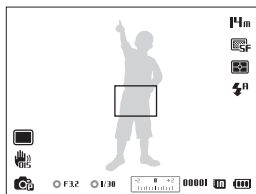

- 3 Align your subject in the frame, and then half-press **[Shutter]** to focus.
- 4 Press **[Shutter]** to capture the photo.

Using the Aperture Priority, Shutter Priority, or Manual mode

Adjust the aperture value or shutter speed to control the exposure of your photos. You can use these options in the Aperture Priority, Shutter Priority, and Manual modes.

Aperture value

The aperture is a hole that lets light into the camera. The aperture housing contains thin, metal plates that open and close, widening or narrowing the aperture, and controlling the amount of light that enters the camera. The size of the aperture is closely related to the brightness of a photo: the larger the aperture, the brighter the photo; the smaller the aperture, the darker the photo.

Note that the larger the aperture value, the smaller the aperture size. For example, an aperture set to 5.6 is larger than an aperture set to 11.



▲ Small aperture value (The size of the aperture is large.)



▲ Large aperture value (The size of the aperture is small.)

Shutter speed

Shutter speed, which is an important factor in the brightness of a photo, refers to the amount of time it takes to open and close the shutter. A slow shutter speed allows more time to let light in. All things being equal, photos are brighter, but fast moving objects tend to blur. On the other hand, a fast shutter speed allows less time to let light in. Photos are darker, but objects in motion are captured more clearly.



▲ Slow shutter speed



▲ Fast shutter speed

Using the Aperture Priority mode

The Aperture Priority mode allows you to set the aperture value manually while the camera automatically selects an appropriate shutter speed.

- 1 Rotate the mode dial to **A**.
- 2 Press **[OK]** → **[DISP/☞]** to adjust the aperture value.
 - See page 37 for more information about the aperture value.

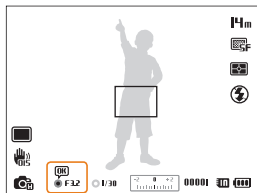

- 3 Set options. (For a list of options, refer to “Shooting options.”)
- 4 Align your subject in the frame, and then half-press **[Shutter]** to focus.
- 5 Press **[Shutter]** to capture the photo.

Using the Shutter Priority mode

The Shutter Priority mode allows you to set the shutter speed manually while the camera automatically selects an appropriate aperture value.

- 1 Rotate the mode dial to **S**.
- 2 Press **[OK]** → **[DISP/☞]** to adjust the shutter speed.
 - See page 37 for more information about the shutter speed.

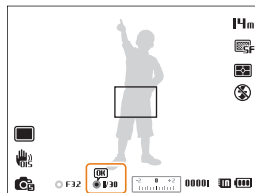

- 3 Set options. (For a list of options, refer to “Shooting options.”)
- 4 Align your subject in the frame, and then half-press **[Shutter]** to focus.
- 5 Press **[Shutter]** to capture the photo.

Using the Manual mode

The Manual mode allows you to adjust both the aperture value and the shutter speed manually.

- 1 Rotate the mode dial to **M**.
- 2 Press **[OK]** to select the aperture value or shutter speed.

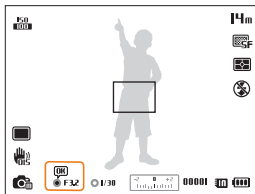

- 3 Press **[DISP/🌸]** to adjust the aperture value or shutter speed.

- 4 Set options. (For a list of options, refer to “Shooting options.”)
- 5 Align your subject in the frame, and then half-press **[Shutter]** to focus.
- 6 Press **[Shutter]** to capture the photo.

Using the DUAL IS mode

Reduce camera shake and prevent blurred photos with Optical and Digital Image Stabilization functions.

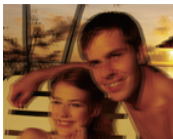

Before correction



After correction

- 1 Rotate the mode dial to  **DUAL**.
- 2 Align your subject in the frame, and then half-press **[Shutter]** to focus.
- 3 Press **[Shutter]** to take the photo.



- The Digital zoom and Smart zoom are not available in  **DUAL** mode.
- The camera will correct photos optically only when the light source is brighter than fluorescent light.
- If your subject is moving rapidly, the photo may be blurry.
- Set the Optical Image Stabilization option to reduce camera shake in different shooting modes. (p. 28)

Using the Movie mode

In Movie mode, you can customize settings to record high-definition videos of up to 20 minutes in length. The camera saves recorded videos as MP4 (H.264) files.

-  • H.264 (MPEG-4 part10/AVC) is a high-compression video format established by the international standard organizations ISO-IEC and ITU-T.
- Some memory cards may not support high definition recording. In this case, set a lower resolution.
- Memory cards with slow writing speeds will not support high-resolution videos and high-speed videos. To record high-resolution or high-speed videos, use memory cards with faster writing speeds.
- If you activate the OIS function while recording a video, the camera may record the operating sound of the OIS function.
- If you use the zoom function when recording a video, the camera may record the noise of the zoom operating. To decrease zoom noise, use the Sound Alive function. See Steps 5 and 6 below.

1 Rotate the mode dial to .

2 Press **[MENU]**.



3 Select  → **Frame Rate**.

4 Select a frame rate (the number of frames per second).

- As the frame rate increases, action appears more natural, but the file size also increases.

5 Select **Voice**.

6 Select a Sound Alive option.

Icon	Description
	Sound Alive On: Turn on the Sound Alive function to reduce the zoom noise.
	Sound Alive Off: Turn off the Sound Alive function to record the zoom noise.
	Mute: Do not record sounds.

-  • Do not block the microphone when you use the Sound Alive function.
- Recordings made with Sound Alive may differ from actual sounds.

- 7 Set desired options. (For a list of options, refer to page 45.)
- 8 Press **OK** (Video recording) to start recording.
- 9 Press **OK** (Video recording) again to stop recording.



- You can start recording a video in any mode by pressing **OK** (Video recording) without having to rotate the mode dial to **Movie**.
- You can capture a photo in Movie mode by pressing [**Shutter**].

Pause recording

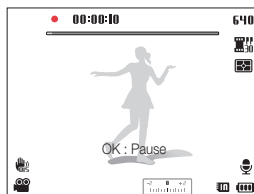

The camera allows you to temporarily pause a video while recording. With this function, you can record separate scenes as a single video.



- Press [**OK**] to pause while recording.
- Press [**OK**] to resume.



Using the Smart Scene Detection mode

In Smart Scene Detection mode, your camera automatically chooses the appropriate camera settings based on the scene it has detected.

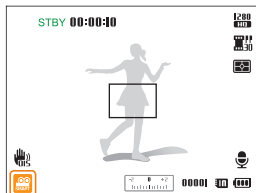
- 1 Rotate the mode dial to .
- 2 In Shooting mode, press **[MENU]**.
- 3 Select  → **Smart Scene Detection** → **On**.
- 4 Press **[MENU]** to return to Shooting mode.
- 5 Align your subject in the frame.
 - The camera automatically selects a scene. An appropriate scene icon will appear at the bottom left of the screen.



Icon	Description
	Landscapes
	Sunsets
	Clear skies
	Forested areas

- 6 Press  (Video recording) to start recording.
- 7 Press  (Video recording) again to stop recording.



- If the camera does not recognize an appropriate scene mode, it uses the default settings for the Smart Scene Detection mode.
- The camera may not select the correct scene depending on the shooting conditions, such as camera shake, lighting, and distance to the subject.
- Smart Filter effects are not available in Smart Scene Detection mode.

Recording voice memos

P A S M  SCN

Learn how to record a voice memo that you can play back later. You can also add a voice memo to a photo to remind you of shooting conditions.

 You will get the best sound quality when you speak 16 in (40 cm) away from the camera.

Recording a voice memo

- 1 In Shooting mode, press **[MENU]**.
- 2 Select  → **Voice** → **Record**.
- 3 Press **[Shutter]**.
 - Press **[OK]** to pause or press **[OK]** to resume.
 - Each memo can be up to 10 hours long if memory is available.



- 4 Press **[Shutter]** again to stop recording.
 - Press **[Shutter]** again to record a new voice memo.
- 5 Press **[MENU]** to return to Shooting mode.

Adding a voice memo to a photo

- 1 In Shooting mode, press **[MENU]**.
- 2 Select  → **Voice** → **Memo**.
- 3 Press **[MENU]** to return to Shooting mode.
- 4 Align your subject in the frame, and then capture a photo.
 - The camera begins to record a voice memo right after you capture the photo.
- 5 Record a short voice memo (10 seconds maximum).
 - Press **[Shutter]** to stop recording a voice memo before the 10 seconds are up.

 You cannot add voice memos to photos in the Drive mode.

Shooting options

Learn how to set the options in Shooting mode.

Selecting a resolution and quality	46	Using Face Detection	56
Selecting a resolution	46	Detecting faces	56
Selecting image quality	47	Capturing a self portrait shot	57
Using the timer	48	Capturing a smile shot	57
Shooting in the dark	49	Detecting eye blinking	58
Preventing red-eye	49	Using Smart Face Recognition	58
Using the flash	49	Registering faces as your favorites (My Star)	59
Adjusting the ISO sensitivity	51	Adjusting brightness and color	61
Changing the camera's focus	52	Adjusting the exposure manually (EV)	61
Using macro	52	Changing the metering option	62
Using auto focus	52	Selecting a light source (White balance) ...	63
Focusing on a selected area	54	Using drive modes	66
Using tracking auto focus	54	Applying effects/Adjusting images	67
Adjusting the focus area	55	Applying Smart Filter effects	67
		Adjusting your photos	70

Selecting a resolution and quality

Learn how to change the image resolution and quality settings.

Selecting a resolution

As you increase the resolution, your photo or video will include more pixels, so it can be printed on larger paper or displayed on a larger screen. When you use a high resolution, the file size will also increase.

Setting the photo resolution

SMART P A S M SCN

- 1 In Shooting mode, press **[MENU]**.
- 2 Select → **Photo Size**.
- 3 Select an option.

Icon	Description
14m	4320 X 3240 : Print on an A1 paper.
12m	4320 X 2880 : Print on an A1 paper in wide ratio (3:2).
10m	3648 X 2736 : Print on an A2 paper.
10m	4320 X 2432 : Print on an A2 paper in panorama ratio (16:9) or play back on an HDTV.
8m	3264 X 2448 : Print on an A3 paper.
5m	2592 X 1944 : Print on an A4 paper.
5m	1920 X 1080 : Print on an A5 paper in panorama ratio (16:9) or play back on an HDTV.
1m	1024 X 768 : Attach to an email.

Setting the video resolution

SMART P A S M SCN

- 1 In Shooting mode, press **[MENU]**.
- 2 Select → **Movie Size**.
- 3 Select an option.

Icon	Description
1280	1280 X 720 HQ : Play back high-quality files on an HDTV.
1280	1280 X 720 : Play back on an HDTV.
640	640 X 480 : Play back on an analog TV.
320	320 X 240 : Post on a web page.



If a memory card is not inserted, the camera supports only **640** and **320**.



Selecting image quality

Set the photo and video quality settings. Higher image quality settings will result in larger file sizes.

Setting the photo quality **P A S M QUAL SCN**

The camera compresses and saves the photos you capture in the JPEG format.



- 1 In Shooting mode, press **[MENU]**.
- 2 Select  → **Quality**.
- 3 Select an option.

Icon	Description
	Super Fine: Capture photos in super high quality.
	Fine: Capture photos in high quality.
	Normal: Capture photos in normal quality.

Setting the video quality

The camera compresses and saves the videos you record in the MP4 (H.264) format.

- 1 In Shooting mode, press **[MENU]**.
- 2 Select  → **Frame Rate**.
- 3 Select an option.

Icon	Description
	30 FPS: Record 30 frames per second.
	15 FPS: Record 15 frames per second.



As the frame rate increases, action appears more natural, but the file size also increases

Using the timer



SMART P A S M ^{HD}DUAL SCN 

Learn how to set the timer to delay shooting.

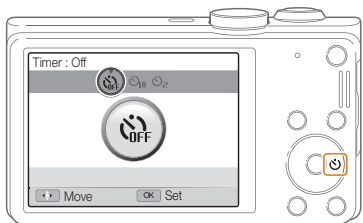
1 In Shooting mode, press [⏻].



2 Select an option.

Icon	Description
	Off: The timer is not active.
	10 Sec: Capture a photo after a 10-second delay.
	2 Sec: Capture a photo after a 2-second delay.

3 Press [Shutter] to start the timer.

- The AF-assist light/timer lamp blinks. The camera will automatically capture a photo after the specified time has elapsed.



- Press [Shutter] to cancel the timer.
- Depending on the timer option, some Face Detection options are not available.
- The timer options are not available if you set Drive options.

Shooting in the dark

Learn how to capture photos at night or in low light conditions.

Preventing red-eye P SCN

If the flash fires when you capture a photo of a person in the dark, a red glow may appear in the person's eyes. To prevent this, select **Red-eye** or **Red-eye Fix**. Refer to flash options in "Using the flash."







Using the flash SMART P A S M SCN

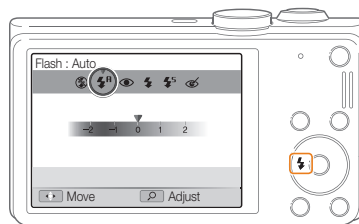



Use the flash when you capture photos in the dark or when you need more light in your photos.

1 In Shooting mode, press .



2 Select an option.

Icon	Description
	Off: <ul style="list-style-type: none">The flash will not fire.The camera will display the shake warning  when you are shooting in low light.
	Auto: The camera will select a proper flash setting for the scene it detects in Smart Auto mode.
	Auto: The flash will fire automatically when the subject or background is dark.

Icon	Description
	<p>Red-eye:</p> <ul style="list-style-type: none"> The flash will fire twice when the subject or background is dark to reduce the red-eye effect. There is an interval between the 2 bursts of the flash. Do not move until the flash fires a second time.
	<p>Fill in:</p> <ul style="list-style-type: none"> The flash always fires. The camera automatically adjusts light intensity.
	<p>Slow Sync:</p> <ul style="list-style-type: none"> The flash fires and the shutter stays open longer. This option is recommended when you want to capture ambient light to reveal more details in the background. Use a tripod to prevent your photos from blurring. The camera will display the shake warning  when you are shooting in low light.
	<p>Red-eye Fix:</p> <ul style="list-style-type: none"> The flash fires when the subject or background is dark and the camera corrects red-eyes through its advanced software analysis. There is an interval between the 2 bursts of the flash. Do not move until the flash fires a second time.

Available options may differ depending on the shooting conditions.



- Flash options are not available if you set Drive options or select **Self-Portrait** or **Blink Detection**.
- Make sure that your subjects are within the recommended distance from the flash. (p. 116)
- If light from the flash is reflected or there is a substantial amount of dust in the air, tiny spots may appear in your photo.

Adjusting the flash intensity

Adjust the flash intensity to avoid over-exposed or under-exposed photos.

- In Shooting mode, press .
- Scroll to an option.
- Rotate **[Zoom]** to the right.

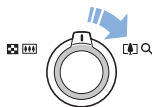

4 Press [**Flash/ISO**] to adjust the intensity.

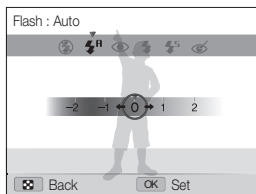

5 Press [**OK**] to save your settings.



- Adjusting the flash intensity may not be effective if:
 - the subject is too close to the camera
 - you set a high ISO sensitivity
 - the exposure value is too big or too small
- In some shooting modes, you cannot use this function.

Adjusting the ISO sensitivity P A S M

The ISO sensitivity is the measure of a film's sensitivity to light as defined by the International Organization for Standardization (ISO). The higher ISO sensitivity you select, the more sensitive to light your camera becomes. With a higher ISO sensitivity, you can get a better photo without using the flash.

1 In Shooting mode, press [**MENU**].

2 Select **ISO** → **ISO**.

3 Select an option.

- Select **ISO** to use an appropriate ISO sensitivity based on the brightness of the subject and lighting.



Higher ISO sensitivities may result in more image noise.

Changing the camera's focus

Learn how to adjust the camera's focus to suit the subject and the shooting conditions.

Using macro P A S M

Use macro to capture close-up photos of subjects, such as flowers or insects.



- Try to hold the camera firmly to prevent blurry photos.
- Turn off the flash if the distance to the subject is less than 16 in (40 cm).

Using auto focus P A S M

To capture sharp photos, select the appropriate focus option according to your distance from the subject.

- 1 In Shooting mode, press .

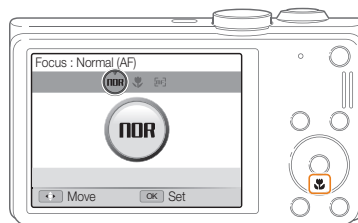

2 Select an option.

Icon	Description
	Normal (AF): Focus on a subject farther than 32 in. (80 cm) (137 in. [350 cm] when you use the zoom).
	Macro: Manually focus on a subject that is 2-32 in. (5-80 cm) from the camera (70-137 in. [180-350 cm] when you use the zoom).
	Auto Macro: Focus on a subject farther than 2 in. (5 cm) (farther than 70 in. [180 cm] away when you use the zoom).
	Manual Focus: Focus on a subject by adjusting the focus distance manually. (p. 53)

Available options may differ depending on the shooting conditions.

Adjusting the focus distance manually P A S M

- 1 In Shooting mode, press [].
- 2 Scroll to **Manual Focus**.
- 3 Rotate [Zoom] to the right.
- 4 Press [] to adjust the focus distance.

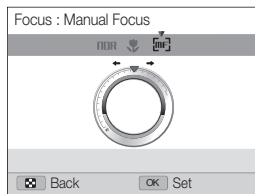

- 5 Press [**OK**] to save your settings.



- When you adjust the focus distance manually and the subject is out of focus, the photo may become blurry.
- If you use this function, you cannot set focus area options and Face Detection options.

Focusing on a selected area P A S M

You can focus on an area that you have selected.

- 1 In Shooting mode, press **[MENU]**.
- 2 Select  → **Focus Area** → **Selection AF**.
- 3 Press **[MENU]** to return to Shooting mode.
- 4 Press **[OK]** → **[DISP/⏏/⚡/⏏]** to move the frame to a desired area.

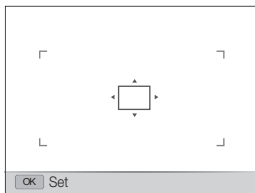

- 5 Press **[OK]**.
- 6 Press **[Shutter]** to capture the photo.
 - Press **[OK]** to change the focus area.



If you use this function, you cannot set Face Detection options, Drive options, and Smart Filter effects.

Using tracking auto focus P A S M

Tracking AF allows you to track and auto focus on your subject, even when you are moving.

- 1 In Shooting mode, press **[MENU]**.
- 2 Select  → **Focus Area** → **Tracking AF**.
- 3 Press **[MENU]** to return to Shooting mode.
- 4 Focus on the subject you want to track, and then press **[OK]**.
 - A focus frame appears on the subject and follows the subject as you move the camera.

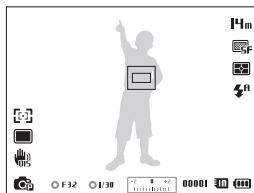

- The white frame means that your camera is tracking the subject.
- When you half-press **[Shutter]**, the green frame means that your subject is in focus.







- If you do not select a focus area, the focus frame will appear in the center of the screen.
- Tracking a subject may fail when:
 - the subject is too small
 - the subject moves excessively
 - the subject is backlit or you are shooting in a dark place
 - colors or patterns on the subject and the background are the same
 - the subject includes horizontal patterns, such as blinds
 - the camera shakes excessively
- When tracking a subject fails, the focus frame will appear as a white single-line frame (□).
- If the camera fails to track the subject, you must reselect the subject to track.
- If the camera fails to focus, the focus frame will change to a red single-line frame (□).
- If you use this function, you cannot set Face Detection options, Drive options, and Smart Filter effects.

Adjusting the focus area P A S M SCN

In addition to Selection AF and Multi AF, you can also use the Center AF and Multi-AF functions to change the focus area. Choose the appropriate focus area function according to your subject's location in the scene.

- 1 In Shooting mode, press [MENU].
- 2 Select  → **Focus Area**.
- 3 Select an option.

Icon	Description
	Center AF: Focus on the center of the frame (suitable when subjects are located at or near the center).
	Multi AF: Focus on one or more of 9 possible areas.
	Selection AF: Focus on the area that you select. (p. 54)
	Tracking AF: Focus on and track the subject. (p. 54)

Available shooting options may differ depending on the shooting mode.

Using Face Detection P A S M QUAL SCN

If you use Face Detection options, your camera can automatically detect a human face. When you focus on a human face, the camera adjusts the exposure automatically. Use **Blink Detection** to detect closed eyes or **Smile Shot** to capture a smiling face. You can also use **Smart Face Recognition** to register faces and prioritize the focus on them.



- When your camera detects a face, it tracks the detected face automatically.
- Face Detection may not be effective when:
 - the subject is far from the camera (The focus frame will appear orange for the Smile Shot and Blink Detection.)
 - it is too bright or too dark
 - the subject is not facing the camera
 - the subject is wearing sunglasses or a mask
 - the subject's facial expression changes drastically
 - the subject is backlit or the lighting conditions are unstable
- Face Detection is not available when you set Smart Filter effects, Selection AF, Tracking AF, or Manual Focus.
- Depending on the shooting options you selected, available Face Detection options may differ.
- Depending on the Face Detection options you selected, the timer function may not be available or available Timer options may differ.
- Depending on the Face Detection options you selected, some Drive options are not available.
- When you capture photos of detected faces, they will be registered in the face list.
- You can view registered faces in order of priority in Playback mode. (p. 73) Even though faces are registered successfully, they may not be classified in Playback mode.
- A face detected in Shooting mode may not appear in the face list or Smart Album.

Detecting faces

Your camera automatically detects up to 10 human faces in one scene.

- 1 In Shooting mode, press [MENU].
- 2 Select  → **Face Detection** → **Normal**.

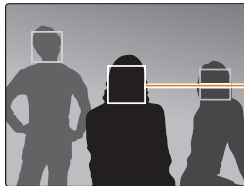

The nearest face appears in a white focus frame and the rest of the faces appear in gray focus frames.



- The closer you are to the subjects, the quicker your camera will detect faces.
- If you have set Drive options, the camera may not register detected faces.

Capturing a self portrait shot

Capture photos of yourself. The camera sets the focus distance to close-up, and then emits a beep when ready.

- 1 In Shooting mode, press **[MENU]**.
- 2 Select  → **Face Detection** → **Self-Portrait**.
- 3 Press **[MENU]** to return to Shooting mode.
- 4 When you hear a quick beep, press **[Shutter]**.

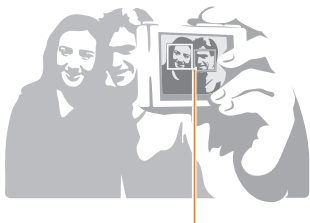

When faces are located in the center, the camera beeps rapidly.



If you turn **Volume** off in the sound settings, the camera will not emit a beep.
(p. 98)

Capturing a smile shot

The camera automatically releases the shutter when it detects a smiling face.

- 1 In Shooting mode, press **[MENU]**.
- 2 Select  → **Face Detection** → **Smile Shot**.
- 3 Press **[MENU]** to return to Shooting mode.
- 4 Compose your shot.
 - The camera automatically releases the shutter when it detects a smiling face.

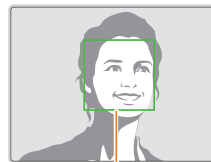

When your subject smiles broadly, your camera can detect the smile more easily.

Detecting eye blinking

If your camera detects closed eyes, it will automatically capture 2 photos in succession.

- 1 In Shooting mode, press [MENU].
- 2 Select  → **Face Detection** → **Blink Detection**.



- Hold your camera still while "Capturing" is displayed on the screen.
- If Blink Detection fails, the "Picture taken with eyes closed." message appears. Capture another photo.



Using Smart Face Recognition

The camera automatically registers faces that you frequently photograph. The Smart Face Recognition feature will automatically prioritize the focus on those faces and on favorite faces. The Smart Face Recognition feature is available only when you use a memory card.

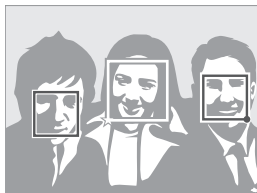
- 1 In Shooting mode, press [MENU].
- 2 Select  → **Face Detection** → **Smart Face Recognition**.



The nearest face appears in a white focus frame and the rest of the faces appear in gray focus frames.

- : Faces that you have registered as favorites. (To register faces as favorites, refer to page 59.)
- : Faces that the camera has automatically registered.



- The camera may recognize and register faces incorrectly depending on lighting conditions, drastic changes in the subject's pose or face, and whether or not the subject is wearing glasses.
- The camera can automatically register up to 12 faces. If the camera recognizes a new face when 12 faces have already been registered, it will replace the lowest priority face with the new one.
- The camera can detect up to 5 favorite faces in one scene.

Registering faces as your favorites (My Star)

You can register your favorite faces to prioritize the focus and exposure on those faces. This feature is available only when you use a memory card.

- 1 In Shooting mode, press **[MENU]**.
- 2 Select  → **Smart FR Edit** → **My Star**.
- 3 Align your subject's face with the oval guideline, and then press **[Shutter]** to register the face.

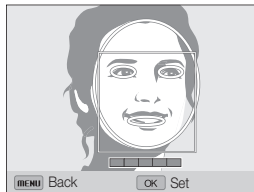

- If the subject's face is not aligned with the oval guideline, the white frame will not appear.
- Capture photos of one person at a time when registering faces.
- Capture 5 photos the subject's face for best results: one each from the front, left, right, above, and below.
- When capturing photos from the left, right, above, and below, instruct the subject not to turn his or her face more than 30 degrees.
- You can register a face even if you capture only one photo of the subject's face.

4 When you are finished capturing the photos, the face list appears.

- Your favorite faces are indicated with a ★ on the face list.



- You can register up to 8 favorite faces.
- The flash will not fire when you register a favorite face.
- If you register the same face twice, you can delete one of the faces in the face list.

Viewing your favorite faces

1 In Shooting mode, press **[MENU]**.

2 Select  → **Smart FR Edit** → **Face List**.



- To change the ranking of your favorite faces, press **[Fn]**, and then select **Edit Ranking**. (p. 73)
- To delete a favorite face, press **[Fn]**, and then select **Delete**. (p. 74)

Adjusting brightness and color

Learn how to adjust the brightness and color for better image quality.

Adjusting the exposure manually (EV)

P A S  

Depending on the intensity of the ambient light, your photos may be too bright or dark. In these cases, you can adjust the exposure to get a better photo.



Darker (-)



Neutral (0)



Brighter (+)

1 In Shooting mode, press **[MENU]**.

2 Select  or  → **EV**.

3 Select a value to adjust the exposure.

- The photo will be brighter as the exposure value increases.

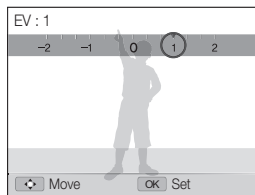



4 Press **[OK]** to save your settings.





- Once you adjust the exposure, the setting will be stored automatically. You may need to change the exposure value later to avoid overexposure or underexposure.
- If you cannot decide on an appropriate exposure, select **AEB** (Auto Exposure Bracket). The camera will capture 3 consecutive photos, each with a different exposure: normal, underexposed, and overexposed. (p. 66)

Changing the metering option **P A S M**

The metering mode refers to the way in which a camera measures the quantity of light. The brightness and lighting of your photos will vary depending on the metering mode you select.

- 1 In Shooting mode, press **[MENU]**.
- 2 Select  or  → **Metering**.
- 3 Select an option.

Icon	Description
	<p>Spot:</p> <ul style="list-style-type: none"> Your camera measures only the light intensity at the very center of the frame. If a subject is not in the center of the frame, your photo may be improperly exposed. Suitable for a subject with backlighting.

Icon	Description
	<p>Multi:</p> <ul style="list-style-type: none"> Your camera divides the frame into several areas, and then measures the light intensity of each area. Suitable for general photos.
	<p>Center-weighted:</p> <ul style="list-style-type: none"> Your camera averages the meter reading of the entire frame with emphasis placed on the center. Suitable for photos with subjects in the center of the frame.

Selecting a light source (White balance)

P A S M  

The color of your photo depends on the type and quality of the light source. If you want the color of your photo to be realistic, select a White Balance setting that is appropriate for the lighting conditions, such as Auto WB, Daylight, Cloudy, or Tungsten.



 Auto WB





 Daylight











 Cloudy





 Tungsten

- 1 In Shooting mode, press [MENU].
- 2 Select  or  → **White Balance**.
- 3 Select an option.

Icon	Description
	Auto WB: Automatically set the White Balance based on the lighting conditions.
	Daylight: For outdoor photos on a sunny day.
	Cloudy: For outdoor photos on a cloudy day or in shadows.
	Fluorescent_H: For shooting under a daylight fluorescent or 3-way fluorescent light.
	Fluorescent_L: For shooting under white fluorescent light.
	Tungsten: For shooting indoor photos under incandescent bulbs or halogen lamps.
	Custom Set: Use White Balance settings that you defined. (p. 64)
	Color Temp.: Adjust the color temperature of the light source. (p. 65)

Customizing preset White Balance options

- 1 In Shooting mode, press **[MENU]**.
- 2 Select  or  → **White Balance**.
- 3 Scroll to a desired option.
- 4 Rotate **[Zoom]** to the right.
- 5 Press **[DISP/⏏/⚡/☺]** to adjust the value on the coordinates.

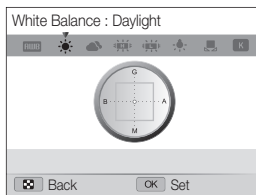



- **G:** Green
- **A:** Amber
- **M:** Magenta
- **B:** Blue

- 6 Press **[OK]** to save your settings.



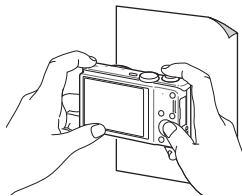

Defining your own White Balance

You can create a customized the White Balance by capturing a photo of a white surface, such as a piece of paper, under the lighting conditions in which you intend to capture a photo. The White Balance feature will help you to match the colors in your photo with the actual scene.

- 1 In Shooting mode, press **[MENU]**.
- 2 Select  or  → **White Balance**.
- 3 Scroll to **Custom Set**.
- 4 Aim the lens at a piece of white paper, and then press **[Shutter]**.



Adjusting color temperature

- 1 In Shooting mode, press **[MENU]**.
- 2 Select  or  → **White Balance**.
- 3 Scroll to **Color Temp.**
- 4 Rotate **[Zoom]** to the right.
- 5 Press / to adjust the color temperature.

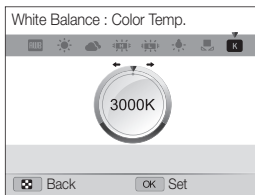

- 6 Press **[OK]** to save your settings.

Color temperature

Color temperature is a measurement in degrees Kelvin that indicates the hue of a specific type of light source. As the color temperature increases, the color distribution becomes cooler. Alternatively, as the color temperature decreases, the color distribution becomes warmer.

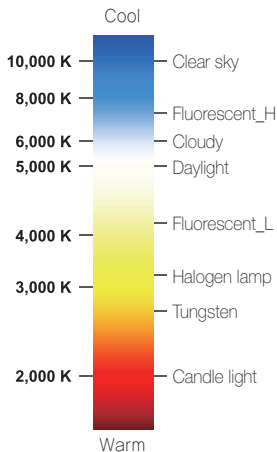





Using drive modes P A S M

It can be difficult to capture photos of fast-moving subjects or capture natural facial expressions and gestures of your subjects in photos. In these cases, select one of the Drive modes to capture multiple photos rapidly.



- 1 In Shooting mode, press **[MENU]**.
- 2 Select  → **Drive**.
- 3 Select an option.

Icon	Description
	Single: Capture a single photo.
	Continuous: <ul style="list-style-type: none">• While you are pressing [Shutter], the camera continuously captures photos.• The maximum number of photos depends on the capacity of your memory card.

Icon	Description
	AEB: <ul style="list-style-type: none">• Capture 3 consecutive photos, each with a different exposure: normal, underexposed, and overexposed.• Use a tripod to prevent blurry photos.
	Motion Capture: While you are pressing [Shutter] , the camera captures VGA photos (6 photos per second; maximum of 30 photos).



- You can use the flash, timer, and Smart Filter options only when you select **Single**.
- When you select **Motion Capture**, your camera will set the resolution to VGA and set the ISO sensitivity to **Auto**.
- Depending on the Face Detection option you selected, some Drive options may not be available.

Applying effects/Adjusting images

Applying Smart Filter effects P A S M

Apply various filter effects to your photos and videos to create unique images.



Miniature





Vignetting













Fish-eye





Sketch









- 1 In Shooting mode, press **[MENU]**.
- 2 Select  or  → **Smart Filter**.
- 3 Select an effect.







Available filters in Program, Aperture Priority, Shutter Priority, and Manual modes

Icon	Description
	Off: No effect
	Miniature: Apply a tilt-shift effect to make the subject appear in miniature.
	Vignetting: Apply the retro-looking colors, high contrast, and strong vignette effect of Lomo cameras.
	Soft-Focus: Hide facial imperfections or apply dreamy effects.
	Old Film 1: Apply a vintage film effect 1.
	Old Film 2: Apply a vintage film effect 2.
	Half Tone Dot: Apply a halftone effect.
	Sketch: Apply a pen sketch effect.
	Fish-eye: Blacken the edges of the frame and distort objects to imitate the visual effect of a fisheye lens.
	Defog: Make image clearer.
	Classic: Apply a black and white effect.



Icon	Description
	Retro: Apply a sepia tone effect.
	Negative: Apply a negative film effect.
	Custom RGB: Customize a color value.

Available filters in Movie mode

Icon	Description
	Off: No effect
	Palette Effect 1: Create a vivid look with sharp contrast and strong color.
	Palette Effect 2: Make scenes clean and clear.
	Palette Effect 3: Apply a soft brown tone.
	Palette Effect 4: Create a cold and monotone effect.
	Miniature: Apply a tilt-shift effect to make the subject appear in miniature.
	Vignetting: Apply the retro-looking colors, high contrast, and strong vignette effect of Lomo cameras.
	Half Tone Dot: Apply a halftone effect.

Icon	Description
	Sketch: Apply a pen sketch effect.
	Fish-eye: Distort close objects to imitate the visual effect of a fisheye lens.
	Defog: Make image clearer.
	Classic: Apply a black and white effect.
	Retro: Apply a sepia tone effect.
	Negative: Apply a negative film effect.
	Custom RGB: Customize a color value.

Defining your own RGB tone

- 1 In Shooting mode, press [MENU].
- 2 Select  or  → **Smart Filter**.
- 3 Scroll to **Custom RGB**.
- 4 Rotate [Zoom] to the right.
- 5 Select a color (R: Red, G: Green, B: Blue).

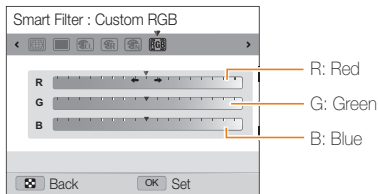

- 6 Select an option.
- 7 Press [OK] to save your settings.



- If you select **Miniature** when you are recording a video, the speed of the video will increase.
- If you select **Miniature** when you are recording a video, the camera will not record sound.
- If you select **Miniature, Vignetting, Half Tone Dot, Sketch, Fish-eye, or Defog**, the recording speed will be set to **1/25** and the recording resolution will be set to less than **640**.
- If you set Smart Filter effects, you cannot set Face Recognition options, Image Adjustment options, Drive options, Tracking AF, or Selection AF.
- If you select **Sketch** when you capture a photo, the photo resolution will change to **5m** and below.

Adjusting your photos P A S M

Adjust the sharpness, saturation, or contrast of your photos.

- 1 In Shooting mode, press **[MENU]**.
- 2 Select  → **Image Adjust**.
- 3 Select an option.
 - Contrast
 - Sharpness
 - Saturation
- 4 Adjust each value.

Contrast	Description
-	Decrease the color and brightness.
+	Increase the color and brightness.

Sharpness	Description
-	Soften the edges on your photos (suitable for editing the photos on your computer).
+	Sharpen the edges to improve the clarity of your photos. This may also increase the noise in your photos.

Saturation	Description
-	Decrease the saturation.
+	Increase the saturation.



- Select 0 if you do not want to apply any effects (suitable for printing).
- If you set adjustment functions, you cannot use Smart Filter options.

Playback/Editing

Learn how to play back photos, videos, or voice memos and edit photos or videos. Also, learn how to connect your camera to your computer, photo printer, TV, or HDTV.

Viewing photos or videos in	
Playback mode	72
Starting Playback mode	72
Viewing photos	77
Playing a video	79
Playing a voice memo	80
Editing a photo	82
Resizing photos	82
Rotating a photo	82
Applying Smart Filter effects	83
Adjusting your photos	84
Creating a print order (DPOF)	86
Viewing files on a TV or HDTV	87
Transferring files to your	
Windows computer	89
Transferring files with Intelli-studio	90
Transferring files by connecting the camera as a removable disk	92
Disconnecting the camera (for Windows XP)	93
Transferring files to your Mac computer ...	94
Printing photos with a	
PictBridge photo printer	95

Viewing photos or videos in Playback mode

Learn how to play back photos, videos, or voice memos and how to manage files.

Starting Playback mode

View photos or play videos and voice memos stored in your camera.

- 1 Press [▶].
 - The most recent file will be displayed.
 - If the camera is off, it will turn on and display the most recent file.
- 2 Press [⏪/⏩] to scroll through files.
 - Press and hold [⏪/⏩] to scroll through files quickly.



- If you want to view files stored in the internal memory, remove your memory card.
- The camera will not properly play back files of unsupported sizes or files that were captured with other cameras.

Photo file information

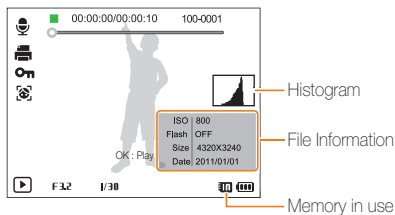

Icon	Description
	Photo includes a voice memo
00:00:00/ 00:00:10	Current playback time/Voice memo length
100-0001	Folder name – File name
	Print order has been set (DPOF)
	Protected file
	Photo includes a registered face (available only when you use a memory card)



To display file information on the screen, press [DISP].

Video file information

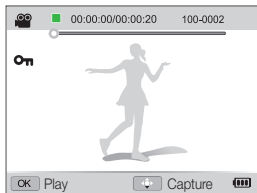

Icon	Description
	Video file
00:00:00/ 00:00:20	Current playback time/Video length
100-0002	Folder name–File name
	Protected file

Ranking your favorite faces

You can rank your favorite faces. The favorite face feature is available only when you insert a memory card into the camera.

- 1 In Playback mode, press **[MENU]**.
- 2 Select → **Face List Edit** → **Edit Ranking**.
- 3 Select a face from the list, and then press **[OK]**.

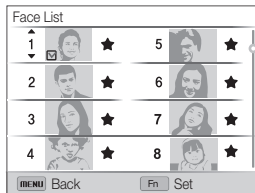

- 4 Press **[DISP/👉]** to change the ranking of the face, and then press **[Fn]**.

Deleting favorite faces

You can delete your favorite faces. The favorite face feature is available only when you insert a memory card into the camera.

- 1 In Playback mode, press **[MENU]**.
- 2 Select  → **Face List Edit** → **Delete**.
- 3 Select a face, and then press **[OK]**.
- 4 Press **[Fn]**.
- 5 When the pop-up message appears, select **Yes**.

Viewing files by category in Smart Album

View files by category, such as date, face, or file type.

- 1 In Playback mode, rotate **[Zoom]** to the left.
- 2 Press **[MENU]**.
- 3 Select a category.

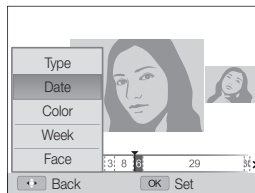

Option	Description
Type	View files by the file type.
Date	View files by the date they were saved.
Color	View files by the dominant color of the image.
Week	View files by the day of the week they were saved.
Face	View files by recognized faces and favorite faces. (Up to 20 people)

- 4 Press [**DISP**]/[**W**]/[**Q**] to scroll through files.
 - Press and hold [**DISP**]/[**W**]/[**Q**] to scroll through files quickly.
- 5 Press [**OK**] to return to the normal view.



It may take some time for the camera to open Smart Album, change the category, or reorganize files.

Viewing files as thumbnails

Scan thumbnails of files.

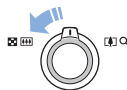

In Playback mode, rotate [**Zoom**] to the left to view thumbnails (3 at a time). Rotate [**Zoom**] to the left once or twice more to display more thumbnails (9 or 20 at a time). Rotate [**Zoom**] to the right to return to the previous view.

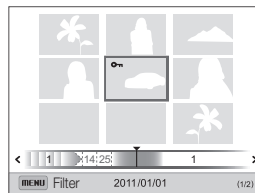

To	Description
Scroll through files	Press [DISP]/[W]/[Q].
Delete files	Press [Fn], and then select Yes .

Protecting files

Protect your files from accidental deletion.

- 1 In Playback mode, press **[MENU]**.
- 2 Select  → **Protect** → **Select**.
 - To protect all files, select **All** → **Lock**.
- 3 Scroll to the file you want to protect, and then press **[OK]**.
 - Press **[OK]** again to cancel your selection.

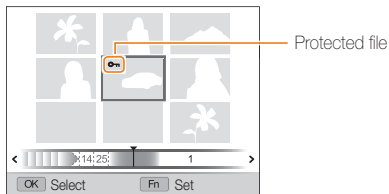

- 4 Press **[Fn]**.



You cannot delete or rotate a protected file.

Deleting files

Select files to delete in Playback mode.

Deleting a single file

You can select one file, and then delete it.

- 1 In Playback mode, select a file, and then press **[Fn]**.
- 2 When the pop-up message appears, select **Yes**.

Deleting multiple files

You can select multiple files, and then delete them at once.

- 1 In Playback mode, press **[Fn]**.
- 2 When the pop-up message appears, select **Multiple Delete**.
 - You can also delete multiple files in Playback mode by pressing **[MENU]**, and then selecting  → **Delete** → **Select**.
- 3 Scroll to each file you want to delete, and then press **[OK]**.
 - Press **[OK]** again to cancel your selection.
- 4 Press **[Fn]**.
- 5 When the pop-up message appears, select **Yes**.

Deleting all files

You can select all files, and then delete them at once.

- 1 In Playback mode, press **[MENU]**.
- 2 Select  → **Delete** → **All**.
- 3 When the pop-up message appears, select **Yes**.

Copying files to a memory card

Copy files from the internal memory to a memory card.

- 1 In Playback mode, press **[MENU]**.
- 2 Select  → **Copy to Card**.
- 3 Select **Yes**.

Viewing photos

Enlarge part of a photo or view photos as a slide show.

Enlarging a photo

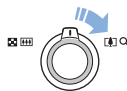

In Playback mode, rotate **[Zoom]** to the right to enlarge a portion of the photo. Rotate **[Zoom]** to the left to zoom out.

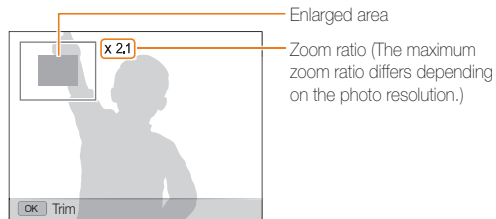

To	Description
Move the enlarged area	Press [DISP] /  /  /  .
Trim the enlarged photo	Press [OK] , and then select Yes . (It will be saved as a new file).



When you view photos that were captured by another camera, the zoom ratio may differ.

Playing a slide show

Apply effects and audio to a slide show of your photos. The slide show function does not work for videos or voice memos.

- 1 In Playback mode, press **[MENU]**.
- 2 Select .
- 3 Select a slide show effect option.
 - Skip to step 4 to start a slide show with no effects.

* Default

Option	Description
Start	Set whether or not to repeat the slide show. (Play , Repeat)
Images	Set the photos you want to view as a slide show. <ul style="list-style-type: none"> • All*: View all photos in a slide show. • Select: View selected photos in a slide show. • Date: View photos captured on a specific date in a slide show.
Interval	<ul style="list-style-type: none"> • Set the interval between photos. (1 sec*, 3 sec, 5 sec, 10 sec) • You must set the Effect option to Off to set the interval.

Option	Description
Effect	<ul style="list-style-type: none"> • Set a scene change effect between photos. (Off*, Calm, Shine, Relax, Lively, Sweet) • Select Off to cancel effects. • When you use the Effect option, the interval between photos will be set to 1 second.
Music	Set background audio. (Off* , Mist , Drops , Muse , Trip , Fall)

- 4 Select **Start** → **Play**.
 - Select **Repeat** to loop the slide show.
- 5 View the slide show.
 - Press **[OK]** to pause the slide show.
 - Press **[OK]** again to resume the slide show.



Press **[OK]**, and then press  to stop the slide show and return to Playback mode.

Playing a video

In Playback mode, you can view a video, and then capture or trim parts of the playing video. You can save the captured or trimmed segments as new files.

- 1 In Playback mode, select a video, and then press **[OK]**.
- 2 View the video.

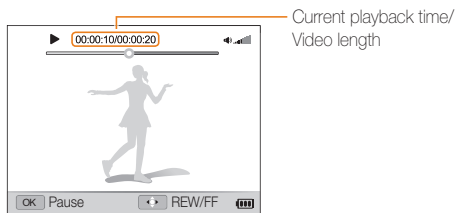

To	Description
Scan backward	Press [⏮] . Each time you press [⏮] , you change the scan speed in this order: 2X, 4X, 8X.
Pause or resume playback	Press [OK] .
Scan forward	Press [⏭] . Each time you press [⏭] , you change the scan speed in this order: 2X, 4X, 8X.
Adjust the volume level	Rotate [Zoom] to the left or right.

Trimming a video

- 1 While viewing a video, press **[OK]** at the point where you want the trimming to begin.
- 2 Rotate **[Zoom]** to the right, and then press **[OK]**.
- 3 Press **[OK]** at the point where you want the trimming to end.
- 4 Rotate **[Zoom]** to the right.
- 5 When the pop-up message appears, select **Yes**.



- The original video should be at least 10 seconds long.
- The camera will save the edited video as a new file.

Capturing an image from video

- 1 While viewing a video, press **[OK]** at the point where you want to capture an image.
- 2 Press **[📷]**.



- The resolution of the captured image will be the same as the original video.
- The captured image is saved as a new file.

Playing a voice memo

Listening to a voice memo

- 1 In Playback mode, select a voice memo, and then press **[OK]**.
- 2 Listen to the voice memo.

To	Description
Scan backward	Press [⏮] .
Pause or resume playback	Press [OK] .
Scan forward	Press [⏭] .
Stop playback	Press [📷] .
Adjust the volume level	Rotate [Zoom] to the left or right.

Adding a voice memo to a photo

- 1 In Playback mode, select a photo, and then press **[MENU]**.
- 2 Select  → **Voice Memo** → **On**.
- 3 Press **[Shutter]** to record a short voice memo.
 - Maximum recording time is 10 seconds.
 - Press **[Shutter]** to stop recording a voice memo.

Playing voice memos that are attached to photos

- 1 In Playback mode, select a photo that includes a voice memo, and then press **[OK]**.
- 2 Listen to a voice memo.
 - Press **[OK]** to pause playback.
 - Press **[OK]** to resume playback.

Editing a photo

Learn how to edit photos.

- The camera will save edited photos as new files. When you rotate a picture, the camera overwrites the original file.
- When you edit photos, the camera will automatically convert them to a lower resolution. Photos that you rotate or resize manually are not automatically converted to a lower resolution.

Resizing photos

Change the size of a photo and save it as a new file. You can set a photo to be displayed when the camera turns on.

- 1 In Playback mode, select a photo, and then press **[MENU]**.
- 2 Select **[▶] → Resize**.
- 3 Select an option.
 - Select **Start Image** to save the photo as a start image. (p. 98)

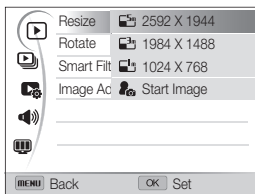

- Available resize options differ depending on the original size of the photo.

Rotating a photo

- 1 In Playback mode, select a photo, and then press **[MENU]**.
- 2 Select **[▶] → Rotate**.
- 3 Select an option.

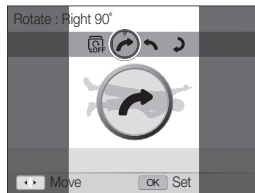

- The camera will overwrite the original file.

Applying Smart Filter effects

Apply special effects to your photos.

- 1 In Playback mode, select a photo, and then press **[MENU]**.
- 2 Select **[▶]** → **Smart Filter**.
- 3 Select an effect.
 - To see available filter options, refer to page 67.

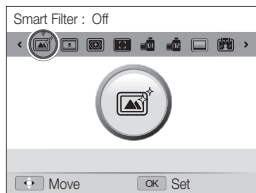

Defining your own RGB tone

- 1 In Playback mode, select a photo, and then press **[MENU]**.
- 2 Select **[▶]** → **Smart Filter**.
- 3 Scroll to **Custom RGB**.
- 4 Rotate **[Zoom]** to the right.
- 5 Select a color (R: Red, G: Green, B: Blue).

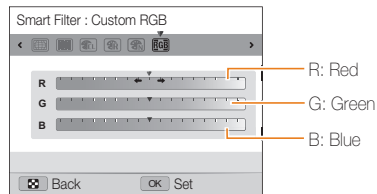

- 6 Adjust the amount of the selected color.
- 7 Press **[OK]** to save your settings.



Adjusting your photos

Learn how to correct the red-eye effect, adjust the skin tone, and adjust the brightness, contrast, or saturation. The camera will save an edited photo as a new file, but may convert it to a lower resolution.

Removing red-eye



- 1 In Playback mode, select a photo, and then press **[MENU]**.
- 2 Select  → **Image Adjust** → **Red-eye Fix**.
- 3 Press **[OK]** to save your settings.



Retouching faces

- 1 In Playback mode, select a photo, and then press **[MENU]**.
- 2 Select  → **Image Adjust** → **Face Retouch**.
- 3 Rotate **[Zoom]** to the right.
- 4 Press [/] to adjust the skin tone.
 - As the number increases, the skin tone becomes brighter.
- 5 Press **[OK]** to save your settings.

Adjusting brightness, contrast, or saturation

- 1 In Playback mode, select a photo, and then press **[MENU]**.
- 2 Select  → **Image Adjust**.
- 3 Select an adjusting option.

Icon	Description
	Brightness
	Contrast
	Saturation



- 4 Rotate **[Zoom]** to the right.
- 5 Press / to adjust the option.
- 6 Press **[OK]** to save your settings.

Adding noise to the photo

- 1 In Playback mode, select a photo, and then press **[MENU]**.
- 2 Select  → **Image Adjust** → **Add Noise**.
- 3 Press **[OK]** to save.

Creating a print order (DPOF)

Select photos to print and save print options in the Digital Print Order Format (DPOF). This information is saved in the MISC folder on your memory card for convenient printing on DPOF-compatible printers.

- 1 In Playback mode, press **[MENU]**.
- 2 Select  → **DPOF** → **Standard** → **Select**.
 - Select **All** to print all photos.
- 3 Scroll to a photo you want to print, rotate **[Zoom]** to the left or right to select the number of copies, and then press **[Fn]**.
 - If you select **All**, press **[DISP/🌸]** to select the number of copies, and then press **[OK]**.
- 4 Press **[MENU]**.
- 5 Select  → **DPOF** → **Size** → **Select**.
 - Select **All** to choose the print size for all photos.
- 6 Scroll to a photo you want to print, rotate **[Zoom]** to the left or right to select the print size, and then press **[Fn]**.
 - If you select **All**, press **[DISP/🌸]** to select the print size, and then press **[OK]**.

Printing photos as thumbnails

Print photos as thumbnails to check all the photos at once.

- 1 In Playback mode, press **[MENU]**.
- 2 Select  → **DPOF** → **Index**.
- 3 When the pop-up message appears, select **Yes**.



- You can take the memory card to a print shop that supports DPOF (Digital Print Order Format) or you can print photos directly through a DPOF-compatible printer at home.
- Photos with dimensions that are wider than the paper may be cut off on the left and right edges. Ensure that your photo dimensions are compatible with the paper you select.
- You cannot set DPOF options for photos stored in the internal memory.
- If you specify the print size, you can print photos only with DPOF 1.1-compatible printers.

Viewing files on a TV or HDTV

Play back photos or videos by connecting your camera to a TV with the A/V cable.

- 1 In Shooting or Playback mode, press **[MENU]**.
- 2 Select **⚙️** → **Video Out**.
- 3 Select the video signal output for your country or region.
(p. 101)
- 4 Turn off your camera and TV.
- 5 Connect your camera to your TV with the A/V cable.

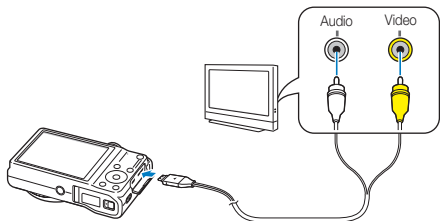

- 6 Turn on your TV, and then select the A/V video source with the TV remote control.
- 7 Turn on your camera, and then press **[▶]**.
- 8 View photos or play videos using the camera buttons.



- Depending on the TV model, you may see some digital noise or part of an image may not appear.
- Images may not be centered on the TV screen depending on your TV settings.
- You can capture photos or record videos while the camera is connected to a TV.

Viewing files on an HDTV

You can view high-quality and uncompressed photos or videos on an HDTV using the optional HDMI cable. HDMI (High Definition Multimedia Interface) is supported by most HDTVs. For details, see the HDMI Kit manual.

- 1 In Shooting or Playback mode, press **[MENU]**.
- 2 Select  → **HDMI Size**.
- 3 Select an HDMI resolution. (p. 101)
- 4 Turn off your camera and HDTV.
- 5 Connect your camera to your HDTV using the optional HDMI cable.

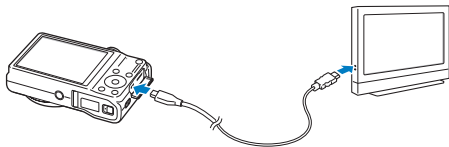

6 Turn on your camera.

- If you have an Anynet+ compatible Samsung HDTV, and you have turned the Anynet+ function on in your camera, the HDTV turns on automatically and displays the camera screen, and the camera automatically enters Playback mode.
- If you turn Anynet+ off in your camera, the HDTV does not turn on automatically.
- If you don't have Anynet+ on your TV or Anynet+ is turned off in your camera, turn on your TV, and then select the HDMI source on your TV using your TV's remote control.

7 View files using the buttons on your camera or a remote control of your HDTV.



- If your HDTV supports the Anynet+(CEC) profile, turn Anynet+ on in the camera's settings menu (p. 101) to control the camera and TV with the TV's remote control.
- Anynet+ lets you control all connected Samsung A/V devices with the TV remote control.
- The time it takes for the camera to connect to your HDTV may vary with the type of SD or SDHC card you use. A faster SD or SDHC card will not necessarily result in a faster HDMI transfer, because the main function of the card is to improve transfer rate during shooting.

Transferring files to your Windows computer

Transfer files to your Windows computer, edit them with Intelli-studio, and upload them to the web.

Requirements

Item	Requirements
CPU	Intel Pentium 4, 3.2 GHz or higher/ AMD Athlon™ FX 2.6 GHz or higher
RAM	Minimum 512 MB RAM (1 GB or more recommended)
OS	Windows XP SP2, Windows Vista, or Windows 7 (32-bit editions)
Hard disk capacity	250 MB or more (1 GB and above recommended)
Others	<ul style="list-style-type: none">• CD-ROM drive• 1024 X 768 pixels, 16-bit color display compatible monitor (1280 X 1024 pixels, 32-bit color display recommended)• USB 2.0 port• nVIDIA Geforce 7600GT or higher/ ATI X1600 series or higher• Microsoft DirectX 9.0c or higher

* The programs may not work properly on 64-bit editions of Windows XP, Windows Vista, and Windows 7.



- The requirements are recommendation only. Intelli-studio may not work properly even when the computer meets the requirements, depending on the condition of your computer.
- If your computer does not meet the requirements, videos may not play correctly or it may take longer to edit videos.
- Install DirectX 9.0c or above before you use Intelli-studio.
- Your computer must be running Windows XP, Windows Vista, or Windows 7 for you to connect the camera as a removable disk.





The manufacturer is not responsible for any damage that results from using unqualified computers such as a computer you assembled yourself.

Transferring files with Intelli-studio

Intelli-studio will start automatically when you connect the camera to your computer with the USB cable.

 The battery will charge while the camera is connected to a computer with the USB cable.

- 1 In Shooting or Playback mode, press **[MENU]**.
- 2 Select  → **PC Software** → **On**.
- 3 Turn off the camera.
- 4 Connect the camera to your computer with the USB cable.

 You must plug the end of the cable with the indicator light (▲) into your camera. If the cable is reversed, it may damage your files. The manufacturer is not responsible for any loss of data.

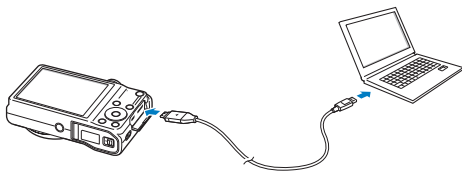

5 Turn on the camera.

- The computer recognizes the camera automatically and Intelli-studio launches automatically.

 If you set the USB option to **Select**, select **Computer** in the pop-up window.

6 Select a destination folder on your computer, and then select **Yes**.

- New files stored on the camera will automatically transfer to the selected folder.
- If your camera has no new files, the pop-up window for saving new files will not appear.

 For Windows Vista and Windows 7, select **Run iStudio.exe** from the Auto Play window to start Intelli-studio.

Using Intelli-studio

Intelli-studio is a built-in program that allows you to play back and edit files. For details, select **Help** → **Help** from the program toolbar.

- To enjoy more features, such as creating slide shows with templates, install the full version of Intelli-studio by selecting **Web Support** → **Update Intelli-studio** → **Start Update** from the program toolbar.
- You can update the firmware of your camera by selecting **Web Support** → **Upgrade firmware for the connected device** from the program toolbar.
- If you install Intelli-studio on your computer, the program will launch more quickly. To install the program, select **Tool** → **Install Intelli-studio on PC**.
- You cannot edit files directly on the camera. Transfer files to a folder on your computer before editing.
- Intelli-studio supports the following formats:
 - Videos: MP4 (Video: H.264, Audio: AAC), WMV (WMV 7/8/9), AVI (MJPEG)
 - Photos: JPG, GIF, BMP, PNG, TIFF

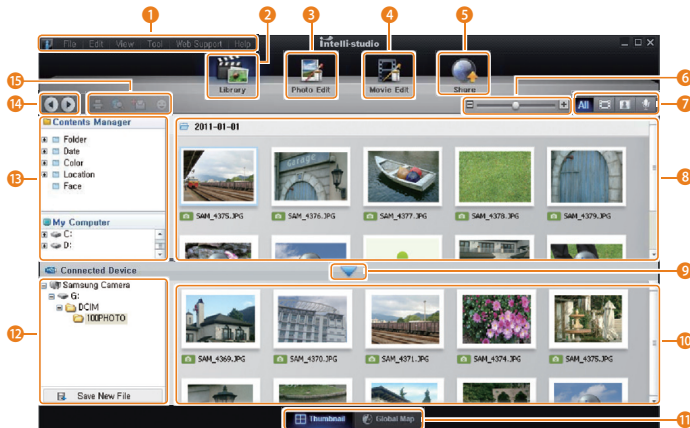

No.	Description
1	Open menus.
2	Display files in the selected folder.
3	Switch to the Photo edit mode.
4	Switch to the Video edit mode.
5	Switch to the Sharing mode (to send files by email or upload files to websites, such as Flickr or YouTube).
6	Enlarge or reduce the thumbnails in the list.
7	Select a file type.
8	View files in the selected folder on your computer.
9	Show or hide files on the connected camera.
10	View files in the selected folder on the camera.
11	View files as thumbnails or on a map.
12	Browse folders stored on the camera.
13	Browse folders stored on your computer.
14	Move to the previous or next folder.
15	Print files, view files on a map, store files in My Folder, or register faces.

Transferring files by connecting the camera as a removable disk

Connect the camera to your computer as a removable disk.

- 1 In Shooting or Playback mode, press **[MENU]**.
- 2 Select **⚙️** → **PC Software** → **Off**.
- 3 Turn off the camera.
- 4 Connect the camera to your computer with the USB cable.



You must plug the end of the cable with the indicator light (▲) into your camera. If the cable is reversed, it may damage your files. The manufacturer is not responsible for any loss of data.

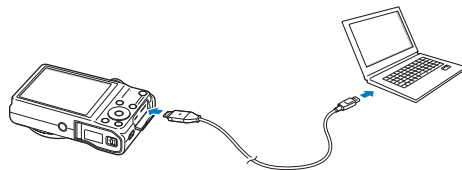

5 Turn on the camera.

- The computer recognizes the camera automatically.



If you set the USB option to **Select**, select **Computer** in the pop-up window.

6 On your computer, select **My Computer** → **Removable Disk** → **DCIM** → **100PHOTO**.

7 Drag or save files to your computer.

Disconnecting the camera (for Windows XP)

With Windows Vista and Windows 7, the methods for disconnecting the camera are similar.

- 1 If the status lamp on your camera is blinking, wait until it stops.
- 2 Click  on the tool bar at the bottom right of your computer screen.



- 3 Click the pop-up message.
- 4 Click the message box indicating safely removed.
- 5 Remove the USB cable.



The camera may not disconnect safely while Intelli-studio is running. End the program before disconnecting the camera.

Transferring files to your Mac computer

When you connect the camera to a Macintosh computer, the computer will automatically recognize the device. You can transfer files directly from the camera to the computer without installing any programs.

 Mac OS 10.4 or later is supported.

1 Connect your camera to a Macintosh computer with the USB cable.

 You must plug the end of the cable with the indicator light (▲) into your camera. If the cable is reversed, it may damage your files. The manufacturer is not responsible for any loss of data.

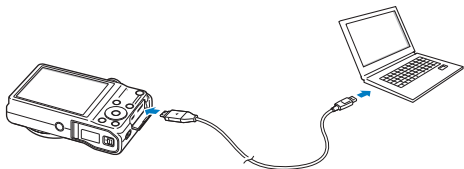

2 Turn on the camera.

- The computer recognizes the camera automatically and displays a removable disk icon.

 If you set the USB option to **Select**, select **Computer** in the pop-up window.

3 Double-click the removable disk icon.

4 Drag or save files to your computer.

Printing photos with a PictBridge photo printer

Print photos with a PictBridge-compatible printer by connecting your camera directly to the printer.

- 1 In Shooting or Playback mode, press **[MENU]**.
- 2 Select **⚙️** → **USB** → **Printer**.
- 3 Turn on the printer, and then connect your camera to the printer with the USB cable.

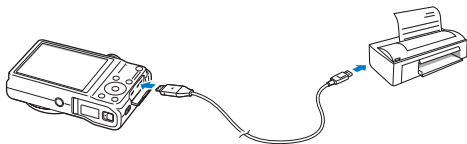

- 4 If the camera is off, press **[POWER]** or **[▶]** to turn it on.
 - The printer recognizes the camera automatically.
- 5 Press **[⚡/⏸]** to select a file to print.
 - Press **[MENU]** to set printing options. See "Configuring print settings."
- 6 Press **[OK]** to print.
 - Printing starts. Press **[⚡]** to cancel printing.

Configuring print settings

Press **[MENU]** to configure print settings.

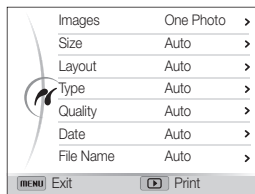

Option	Description
Images	Select whether to print the current photo or all photos.
Size	Set the print size.
Layout	Set the number of photos to be printed on a single sheet of paper.
Type	Set the type of paper.
Quality	Set the print quality.
Date	Set to print the date.
File Name	Set to print the file name.
Reset	Reset settings to their default values.



Some options may not be supported by some printers.

Settings

Refer to options to configure your camera's settings.

Settings menu	97
Accessing the settings menu	97
Sound	98
Display	98
Settings	99



Settings menu

Learn to configure your camera's settings.

Accessing the settings menu

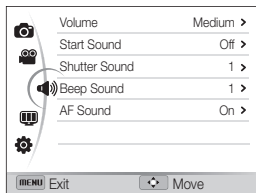
- 1 In Shooting or Playback mode, press **[MENU]**.
- 2 Select a menu.



Option	Description
	Sound: Set various camera sounds and the volume. (p. 98)
	Display: Customize the display settings. (p. 98)
	Settings: Customize the settings for the camera system. (p. 99)

- 3 Select an item.

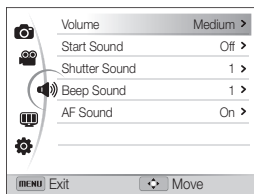

- 4 Select an option.

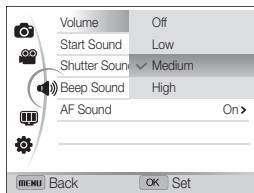

- 5 Press **[MENU]** to return to the previous screen.

Sound



* Default

Item	Description
Volume	Set the volume of any sound. (Off , Low , Medium* , High)
Start Sound	Set the sound the camera emits when you turn on your camera. (Off* , 1 , 2 , 3)
Shutter Sound	Set the sound the camera emits when you press the shutter button. (Off , 1* , 2 , 3)
Beep Sound	Set the sound the camera emits when you press the buttons or switch modes. (Off , 1* , 2 , 3)
AF Sound	Set to emit a sound when you half-press the shutter button. (Off , On*)

Display

* Default

Item	Description
Function Description	Display a brief description of an option or menu. (Off , On*)
Grid Line	Select a guide to help you compose a scene. (Off* , 3 X 3 , 2 X 2 , + , X)
Start Image	Set a start image to display when the camera turns on. <ul style="list-style-type: none"> • Off*: Display no start image. • Logo: Display a default image stored in the internal memory. • User Image: Display a custom image. (p. 82)  <ul style="list-style-type: none"> • The camera will save only one user image in the internal memory at a time. • If you select a new photo as a user image or reset your camera, the camera will delete the current image.

Item	Description
Display Brightness	Adjust the brightness of the screen. (Auto* , Dark , Normal , Bright)  Normal is fixed in Playback mode even if you have selected Auto .
Quick View	Set the duration for reviewing a captured image before returning to the Shooting mode. (Off , 0.5 sec* , 1 sec , 3 sec)
Power Save	If you perform no operations for 30 seconds, the camera automatically switches to Power save mode. (Off* , On)  <ul style="list-style-type: none"> In Power save mode, press any button other than [POWER] to resume using the camera. Even if you do not set the Power save mode, the screen will dim 30 seconds after the last operation to save power.



* Default

Settings

Item	Description
Format	Format the internal memory and the memory card (formatting will delete all files, including protected files). (No , Yes)  Errors can occur if you use a memory card formatted by another brand of camera, a memory card reader, or a computer. Please format memory cards in the camera before using them to capture photos.
Reset	Reset menus and shooting options (date and time, language, and video output settings will not be reset). (No , Yes)
Language	Set a language for the display text.
Time Zone	Set the time zone for your location. When you travel to another country, select Visit , and then select the appropriate time zone. (Home* , Visit)
Date & Time	Set the date, time, and a date format. (Off* , YYYY/MM/DD , MM/DD/YYYY , DD/MM/YYYY)

* Default

Item	Description	* Default
File No.	<p>Specify how to name files.</p> <ul style="list-style-type: none"> • Reset: Set the file number to start from 0001 when you insert a new memory card, format a memory card, or delete all files. • Series*: Set the file number to resume from the previous file number when you insert a new memory card, format a memory card, or delete all files. 	
	<p> • The default name of the first folder is 100PHOTO and the default name of the first file is SAM_0001.</p> <ul style="list-style-type: none"> • The file number increases one at a time from SAM_0001 to SAM_9999. • The folder number increases one at a time from 100PHOTO to 999PHOTO. • The maximum number of files that can be stored in one folder is 1000. • The camera defines file names according to the Design rule for Camera File system (DCF) standard. If you intentionally change file names, the camera may not play back the files. 	

Item	Description	* Default
Imprint	<p>Set whether or not to display the date and time on captured photos. (Off*, Date, Date & Time)</p> <p> • The date and time will be displayed on the bottom right corner of the photo.</p> <ul style="list-style-type: none"> • Some printer models may not print the date and time properly. • If you select Text in SCN mode, the camera will not display the date and time. 	
Auto Power Off	<p>Set the camera to automatically turn off when you perform no operations for a specified period. (Off, 1 min, 3 min*, 5 min, 10 min)</p> <p> • Your settings will not change when you replace the battery.</p> <ul style="list-style-type: none"> • The camera will not automatically turn off when the camera is connected to a computer or printer, when you are playing a slide show or videos, and when you are recording a voice memo. 	

* Default

Item	Description
Video Out	<p>Set the video signal output for your region.</p> <ul style="list-style-type: none"> • NTSC*: USA, Canada, Japan, Korea, Taiwan, Mexico • PAL (supports only BDGHI): Australia, Austria, Belgium, China, Denmark, England, Finland, Germany, Italy, Kuwait, Malaysia, Netherlands, New Zealand, Norway, Singapore, Spain, Sweden, Switzerland, Thailand
AF Lamp	<p>Set a light to automatically turn on in dark places to help you focus. (Off, On*)</p>
Anynet+ (HDMI-CEC)	<p>Turn on to control the camera with a TV remote control when you connect it to an HDTV that supports the Anynet+(CEC) profile.</p> <ul style="list-style-type: none"> • Off: View files without using an HDTV remote control. • On*: Control the camera with an HDTV remote control.

* Default

Item	Description
HDMI Size	<p>Set the resolution of photos when the camera plays back files on an HDTV via the HDMI cable. (NTSC: 1080i*, 720p, 480p/ PAL: 1080i*, 720p, 576p)</p> <ul style="list-style-type: none"> • If the HDTV does not support the selected resolution, the HDTV automatically selects the next lower resolution. • If you select 480p or 576p, the playback menus and Smart Album will not be available when you connect the camera to a TV.
USB	<p>Select the mode to use when you connect the camera to a computer or printer with a USB cable.</p> <ul style="list-style-type: none"> • Computer*: Connect your camera to a computer for transferring files. • Printer: Connect your camera to a printer for printing files. • Select: Manually select the USB mode when you connect your camera to a device.
PC Software	<p>Set Intelli-studio to launch automatically when you connect your camera to your computer. (Off, On*)</p>

Appendixes

Get information about error messages, specifications, and maintenance.

Error messages	103
Camera maintenance	104
Cleaning your camera	104
Using or storing the camera	105
About memory cards	106
About the battery	108
Before contacting a service center	112
Camera specifications	115
Glossary	119
FCC notice	124
Index	125

Error messages

When the following error messages appear, try these remedies.

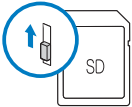
Error message	Suggested remedies
Card Error	<ul style="list-style-type: none">• Turn off your camera, and then turn it on again.• Remove your memory card, and then insert it again.• Format your memory card.
Card Locked	<p>You can lock an SD or SDHC card to prevent files from being deleted. Unlock the card when shooting.</p>  A diagram showing an SD card with a lock icon on its side. A blue circle highlights the lock icon, and a blue arrow points upwards from the lock icon, indicating the action to unlock the card.
Card not supported.	<p>The inserted memory card is not supported by your camera. Insert a SD or SDHC memory card.</p>
DCF Full Error	<p>File names do not match the DCF standard. Transfer the files on the memory card to your computer, and then format the card.</p>

Error message	Suggested remedies
File Error	<p>Delete the damaged file or contact a service center.</p>
File system not supported.	<p>Your camera does not support the FAT file structure of the inserted memory card. Format the memory card on the camera.</p>
Low Battery	<p>Insert a charged battery or recharge the battery.</p>
Memory Full	<p>Delete unnecessary files or insert a new memory card.</p>
No Image File	<p>Capture photos or insert a memory card that contains some photos.</p>

Camera maintenance

Cleaning your camera

Camera lens and display

Use a blower brush to remove dust and wipe the lens gently with a soft cloth. If any dust remains, apply lens cleaning liquid to a piece of lens cleaning paper and wipe gently.

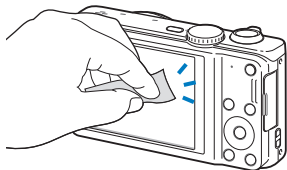
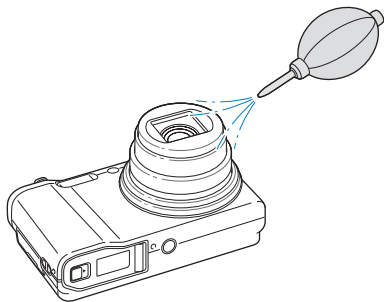

Camera body

Wipe gently with a soft, dry cloth.

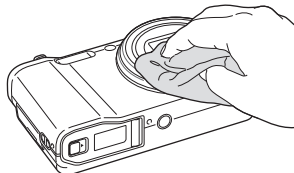

- Never use benzene, thinners, or alcohol to clean the device. These solutions can damage the camera or cause it to malfunction.
- Do not press on the lens cover or use a blower brush on the lens cover.

Using or storing the camera

Inappropriate places to use or store the camera

- Avoid exposing the camera to very cold or very hot temperatures.
- Avoid using your camera in areas with extremely high humidity, or where the humidity changes drastically.
- Avoid exposing the camera to direct sunlight and storing it in hot, poorly-ventilated areas, such as in a car during summer time.
- Protect your camera and the display from impact, rough handling, and excessive vibration to avoid serious damage.
- Avoid using or storing your camera in dusty, dirty, humid, or poorly-ventilated areas to prevent damage to moving parts and internal components.
- Do not use your camera near fuels, combustibles, or flammable chemicals. Do not store or carry flammable liquids, gases, or explosive materials in the same compartment as the camera or its accessories.
- Do not store the camera where there are mothballs.

Using on beaches or shores

- Protect your camera from sand and dirt when you use it on beaches or in other similar areas.
- Your camera is not waterproof. Do not handle the battery, adapter, or memory card with wet hands. Operating the camera with wet hands may cause damage to your camera.

Storing for extended period of time

- When you store the camera for an extended period, place it in a sealed container with an absorbent material, such as silica gel.
- Remove the batteries from your camera when storing it for an extended period. Installed batteries may leak or corrode over time and cause serious damage to your camera.
- Over time, unused batteries will discharge and must be recharged before use.

Using the camera with caution in humid environments

When you transfer the camera from a cold environment to a warm one, condensation can form on the lens or internal components of the camera. In this situation, turn off the camera and wait for at least 1 hour. If condensation forms on the memory card, remove the memory card from the camera and wait until all moisture has evaporated before reinserting it.

Other cautions

- Do not swing your camera by the strap. This may cause injury to yourself or others or damage to your camera.
- Do not paint your camera, as paint can clog moving parts and prevent proper operation.
- Turn off the camera when not using it.
- Your camera consists of delicate parts. Avoid impacts to the camera.
- Protect the display from external force by keeping it in the case when not in use. Protect the camera from scratches by keeping it away from sand, sharp implements, or loose change.
- Do not expose the lens to direct sunlight, as this may discolor the image sensor or cause it to malfunction.
- Protect your lens from fingerprints and scratches. Clean your lens with a soft, clean, debris-free lens cloth.
- The camera may turn off if impacted from the outside. This is to protect the memory card. Turn on the camera to use it again.
- While you use the camera, it may heat up. This is normal and should not affect your camera's lifespan or performance.
- When you use the camera in low temperatures, it may take some time to turn on, the color of the display may be changed temporarily, or after-images may appear. These conditions are not malfunctions and they will correct themselves when the camera is returned to normal temperatures.

- Paint or metal on the outside of the camera may cause allergies, itchy skin, eczema, or swelling for people with sensitive skin. If you experience any of these symptoms, stop using the camera immediately and consult a doctor.
- Do not insert foreign objects into any of your camera's compartments, slots, or access points. Damage due to improper use may not be covered by your warranty.
- Do not allow unqualified personnel to service the camera or attempt to service the camera yourself. Any damage that results from unqualified service is not covered by your warranty.

About memory cards

Supported memory cards



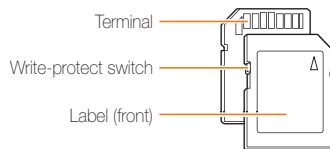

Your camera supports SD or SDHC memory cards.



You can prevent files from being deleted by using the write-protect switch on an SD or SDHC card. Slide the switch down to lock or slide it up to unlock. Unlock the card when capturing photos and videos.

Memory card capacity

The memory capacity may differ depending on shooting scenes or shooting conditions. These capacities are based on a 1 GB SD card:

	Size	Super Fine	Fine	Normal	30 FPS	15 FPS
P h o t o s	 14m	140	207	272	-	-
	 12m	157	231	304	-	-
	10m	194	285	372	-	-
	 10m	185	272	355	-	-
	8m	240	351	455	-	-
	5m	369	531	682	-	-
	 2m	802	1103	1358	-	-
	1m	1676	2115	2433	-	-
* V i d e o s	 1280 10	-	-	-	Approx. 12' 04"	Approx. 21' 57"
	1280	-	-	-	Approx. 16' 33"	Approx. 23' 55"
	640	-	-	-	Approx. 32' 40"	Approx. 49' 28"
	320	-	-	-	Approx. 70' 03"	Approx. 101' 43"

* Available recording time may vary if you use the zoom. Several videos were recorded in succession to determine the total recording time.

Cautions when using memory cards

- Insert a memory card in the correct direction. Inserting a memory card in the wrong direction may damage your camera and memory card.
- Do not use memory cards that have been formatted by other cameras or by a computer. Reformat the memory card with your camera.
- Turn off the camera when you insert or remove the memory card.
- Do not remove the memory card or turn off your camera while the lamp is blinking, as this may damage your data.
- When the lifespan of a memory card has expired, you cannot store any more photos on the card. Use a new memory card.
- Do not bend, drop, or subject memory cards to heavy impact or pressure.
- Avoid using or storing memory cards near strong magnetic fields.
- Avoid using or keeping memory cards in areas with high temperature, high humidity, or corrosive substances.
- Prevent memory cards from making contact with liquids, dirt, or foreign substances. If dirty, wipe the memory card clean with a soft cloth before you insert the memory card in your camera.
- Do not allow liquids, dirt, or foreign substances to come in contact with memory cards or the memory card slot. Doing so may cause memory cards or the camera to malfunction.

- When you carry a memory card, use a case to protect the card from electrostatic discharges.
- Transfer important data to other media, such as a hard disk, CD, or DVD.
- When you use the camera for an extended period, the memory card may become warm. This is normal and does not indicate a malfunction.



The manufacturer is not responsible for any loss of data.

About the battery

Use only Samsung-approved batteries.

Battery specifications

Specification	Description
Model	SLB-10A
Type	Lithium-ion battery
Cell capacity	1050 mAh
Voltage	3.7 V
Charging time* (when the camera is switched off)	Approximately 150 min

* Charging the battery by connecting it to a computer may take longer.

Battery life

Average shooting time/ Number of photos		Test conditions (when the battery is fully charged)
Photos	Approximately 110 min/ Approximately 220 photos	The battery life was measured under the following conditions: in P mode, in darkness, 4m resolution, Fine quality, OIS on. <ol style="list-style-type: none"> 1. Set the flash option to Fill in, take a single shot, and zoom in or out. 2. Set the flash option to Off, take a single shot, and zoom in or out. 3. Perform steps 1 and 2 for 30 seconds and repeat for 5 minutes. Then turn off the camera for 1 minute. 4. Repeat steps 1 to 3.
	Videos	Record videos at 1280 X 720 HQ resolution and 30 FPS.

- The figures above are measured by Samsung's standards. Your results may differ, depending on your actual usage.
- Several videos were recorded in succession to determine the total recording time.

Low battery message

When the battery has fully discharged, the battery icon will turn red and the "Low Battery" message will appear.

Notes about using the battery

- Avoid exposing batteries or memory cards to very cold or very hot temperatures (below 0 °C/32 °F or above 40 °C/104 °F). Extreme temperatures can reduce the charging capacity of your batteries and can cause memory cards to malfunction.
- When you use the camera for an extended period, the area around the battery chamber may become warm. This does not affect the normal use of the camera.
- Do not pull the power supply cord to disconnect the plug from the power outlet, as this may cause a fire or electric shock.
- In temperatures below 0 °C/32 °F, battery capacity and battery life may decrease.
- Battery capacity may decrease in low temperatures but will return to normal in milder temperatures.

Cautions about using the battery

Protect batteries, chargers, and memory cards from damage

Prevent batteries from making contact with metal objects, as this can create a connection between the + and – terminals of your battery and lead to temporary or permanent battery damage and may cause a fire or electric shock.

Notes about charging the battery

- If the indicator light is off, make sure that the battery is inserted correctly.
- If the camera is on while charging, the battery may not fully charge. Turn off the camera before charging the battery.
- Do not use your camera when you charge the battery. This may cause a fire or electric shock.
- Do not pull the power supply cord to disconnect the plug from the power outlet, as this may cause a fire or electric shock.
- Let the battery charge for at least 10 minutes before turning on the camera.
- If you connect the camera to an external power source while the battery is depleted, using some high energy-consuming functions will cause the camera to turn off. To use the camera normally, recharge the battery.

- Using the flash or recording videos depletes the battery quickly. Charge the battery until the indicator light turns green.
- If the indicator light blinks in orange or does not illuminate, reconnect the cable, or remove the battery and insert it again.
- If you charge the battery when the cable is overheated or the temperature is too high, the indicator light may turn orange. Charging will start when the battery cools down.
- Overcharging batteries may shorten battery life. After charging is finished, disconnect the cable from your camera.
- Do not bend or place heavy objects on the AC cable. Doing so may damage the cable.

Notes about charging with a computer connected

- Use only the provided USB cable.
- The battery may not charge when:
 - you use a USB hub
 - other USB devices are connected to your computer
 - you connect the cable to the port on the front side of your computer
 - the USB port of your computer does not support the power output standard (5 V, 500 mA)

Handling and disposing of batteries and chargers with care

- Never dispose of batteries in a fire. Follow all local regulations when you dispose of used batteries.
- Never place batteries or cameras on or in heating devices, such as microwave ovens, stoves, or radiators. Batteries may explode when they are overheated.



Personal injury or death can occur if the battery is handled carelessly or improperly. For your safety, follow these instructions for proper battery handling:

- The battery can ignite or explode if not handled properly. If you notice any deformities, cracks, or other abnormalities in the battery, immediately discontinue use of the battery and contact a service center.
- Use only authentic, manufacturer-recommended battery chargers and adapters and charge the battery only by the methods described in this user manual.
- Do not place the battery near heating devices or expose it to excessively warm environments, such as the inside of an enclosed car in the summertime.
- Do not place the battery in a microwave oven.
- Avoid storing or using the battery in hot, humid places, such as spas or shower enclosures.
- Do not rest the device on flammable surfaces, such as bedding, carpets, or electric blankets for a prolonged period.
- When the device is switched on, do not leave it in any confined space for a prolonged period.
- Do not allow battery terminals to come in contact with metallic objects, such as necklaces, coins, keys, or watches.
- Use only authentic, manufacturer-recommended, Lithium-ion replacement batteries.

- Do not disassemble or puncture the battery with any sharp object.
- Avoid exposing the battery to high pressure or crushing forces.
- Avoid exposing the battery to major impacts, such as dropping it from high places.
- Do not expose the battery to temperatures of 60 °C (140 °F) or above.
- Do not allow the battery to come in contact with moisture or liquids.
- Do not expose the battery to sources of excessive heat such as sunshine, fire or the like.

Disposal guidelines

- Dispose of the battery with care.
- Do not dispose of the battery in a fire.
- Disposal regulations may differ by country or region. Dispose of the battery in accordance with all local and federal regulations.

Guidelines for charging the battery

Charge the battery only by the method described in this user manual. The battery can ignite or explode if not charged properly.

Before contacting a service center

If you are having trouble with your camera, try these troubleshooting procedures before you contact a service center. If you have attempted the suggested remedy and are still having problems with your device, contact your local dealer or service center.

 When you leave your camera at a service center, be sure to also leave the other components that may have contributed to the malfunction, such as the memory card and battery.

Situation	Suggested remedies
Cannot turn on the camera	<ul style="list-style-type: none">• Ensure that the battery is inserted.• Ensure that the battery is inserted correctly. (p. 16)• Charge the battery.
The power turns off suddenly	<ul style="list-style-type: none">• Charge the battery.• Your camera may be in Power save mode. (p. 99)• The camera may turn off to prevent the memory card from being damaged due to an impact. Turn on your camera again.
The camera is losing battery power quickly	<ul style="list-style-type: none">• The battery may lose power more quickly in low temperatures (below 0 °C/32 °F). Keep the battery warm by putting it into your pocket.• Using the flash or recording videos depletes the battery quickly. Recharge if needed.• Batteries are consumable parts that must be replaced over time. Get a new battery if the battery life is diminishing quickly.

Situation	Suggested remedies
Cannot capture photos	<ul style="list-style-type: none">• There is no space on the memory card. Delete unnecessary files or insert a new card.• Format the memory card.• The memory card is defective. Get a new memory card.• Make sure that the camera is switched on.• Charge the battery.• Make sure that the battery is inserted correctly.
The camera freezes	Remove the battery and insert it again.
The camera heats up	While you use the camera, it may heat up. This is normal and should not affect your camera's lifespan or performance.
The flash does not work	<ul style="list-style-type: none">• The flash option may be set to Off. (p. 49)• You cannot use the flash in some modes.

Situation	Suggested remedies
The flash fires unexpectedly	The flash may fire due to static electricity. The camera is not malfunctioning.
The date and time are incorrect	Set the date and time in the display settings. (p. 99)
The display or buttons do not work	Remove the battery, and then insert it again.
The camera display responds poorly	If you use your camera at very low temperatures, it may cause the camera screen to malfunction or discolor. For better performance of your camera screen, use your camera in moderate temperatures.
The memory card has an error	<ul style="list-style-type: none"> • Turn off your camera, and then turn it on again. • Remove your memory card, and then insert it again. • Format your memory card. See "Cautions when using memory cards" for more detail. (p. 107)
Cannot play back files	If you change the name of a file, your camera may not play the file (the name of the file should meet the DCF standard). If you encounter this situation, play back the files on your computer.

Situation	Suggested remedies
The photo is blurry	<ul style="list-style-type: none"> • Make sure that the focus option you set is suitable for close-up shots. (p. 52) • Make sure that the lens is clean. If not, clean the lens. (p. 104) • Make sure that the subject is within range of the flash. (p. 116)
The colors in the photo do not match the actual scene	An incorrect White Balance can create unrealistic color. Select the proper White Balance option to suit the light source. (p. 63)
The photo is too bright	Your photo is overexposed. <ul style="list-style-type: none"> • Turn off the flash. (p. 49) • Adjust the ISO sensitivity. (p. 51) • Adjust the exposure value. (p. 61)
The photo is too dark	Your photo is underexposed. <ul style="list-style-type: none"> • Turn on the flash. (p. 49) • Adjust the ISO sensitivity. (p. 51) • Adjust the exposure value. (p. 61)

Situation	Suggested remedies
The TV does not display your photos	<ul style="list-style-type: none"> • Make sure that the camera is correctly connected to the TV with the AV cable. • Make sure that your memory card contains photos.
Your computer does not recognize your camera	<ul style="list-style-type: none"> • Make sure that the USB cable is connected correctly. • Make sure that your camera is switched on. • Make sure that you are using a supported operating system.
Your computer disconnects the camera while transferring files	The file transmission may be interrupted by static electricity. Disconnect the USB cable and connect it again.
Your computer cannot play videos	Videos may not play on some video player programs. To play video files captured with your camera, install and use the Intelli-studio program on your computer. (p. 90)

Situation	Suggested remedies
Intelli-studio is not functioning properly	<ul style="list-style-type: none"> • End Intelli-studio and restart the program. • You cannot use Intelli-studio on Macintosh computers. • Make sure that PC Software is set to On in the settings menu. (p. 101) • Depending on your computer's specifications and environment, the program may not launch automatically. In this case, click Start → My Computer → Intelli-studio → iStudio.exe on your computer.

Camera specifications

Image sensor	
Type	1/2.33" (Approximately 7.76 mm) CCD
Effective pixels	Approximately 14.2 mega-pixels
Total pixels	Approximately 16.4 mega-pixels
Lens	
Focal length	Schneider-KREUZNACH Lens f = 4.0 mm-72.0 mm (35 mm film equivalent : 24-432 mm)
F-stop range	F3.2 (W)-F5.8 (T)
Digital zoom	<ul style="list-style-type: none"> Still image mode: 1.0X-18.0X (Optical zoom X Digital zoom: 72.0X, Smart zoom X Digital zoom: 72.0X) Playback mode: 1.0X-8.4X
Display	
Type	TFT LCD
Feature	3.0" (7.62 cm) QVGA (230K)
Focusing	
Type	TTL auto focus (Multi AF, Center AF, Selection AF, Manual Focus, Face Detection AF, Tracking AF, Smart Face Recognition AF)

Range		Wide (W)	Tele (T)
	Normal (AF)	80 cm-infinity	350 cm-infinity
Macro	5 cm-80 cm	180 cm-350 cm	
Auto Macro	5 cm-infinity	180 cm-infinity	
Manual Focus	5 cm-infinity	180 cm-infinity	

Shutter speed

- Auto: 1/8 - 1/2,000 sec.
- Program: 1 - 1/2,000 sec.
- Manual: 16 - 1/2,000 sec.
- Night: 8 - 1/2,000 sec.
- Fireworks: 2 sec.

Exposure

Control	Program AE, Manual Aperture Adjustment
Metering	Multi, Spot, Center-weighted, Face Detection
Compensation	±2EV (1/3 EV Step)
ISO equivalent	Auto, ISO 80, ISO 100, ISO 200, ISO 400, ISO 800, ISO 1600, ISO 3200

Flash	
Mode	Auto, Red-eye, Fill in, Slow Sync, Off, Red-eye Fix
Range	<ul style="list-style-type: none"> Wide: 0.3 m-3.6 m (ISO Auto) Tele: 0.5 m-2 m (ISO Auto)
Recharging time	Approximately 4 sec.
Shake reduction	
DUAL IS [Optical Image Stabilization (OIS) + Digital Image Stabilization (DIS)]	
Effect	
Photo Shooting mode	<ul style="list-style-type: none"> Smart Filter: Off, Miniature, Vignetting, Soft-Focus, Old Film 1, Old Film 2, Half Tone Dot, Sketch, Fish-eye, Defog, Classic, Retro, Negative, Custom RGB Image Adjust: Sharpness, Contrast, Saturation
Video Shooting mode	Smart Filter: Off, Palette Effect 1, Palette Effect 2, Palette Effect 3, Palette Effect 4, Miniature, Vignetting, Half Tone Dot, Sketch, Fish-eye, Defog, Classic, Retro, Negative, Custom RGB
White Balance	
Auto WB, Daylight, Cloudy, Fluorescent_H, Fluorescent_L, Tungsten, Custom Set, Color Temp.	

Date Imprinting	
Date & Time, Date, Off	
Shooting	
Photos	<ul style="list-style-type: none"> Modes: Smart Auto (Portrait, Night Portrait, Backlight Portrait, Night, Backlight, Landscape, White, Natural Green, Blue Sky, Sunset, Macro, Macro text, Macro Color, Tripod, Action, Fireworks), Program, Aperture Priority, Shutter Priority, Manual, DUAL IS, Scene (Beauty Shot, Night, Landscape, Text, Sunset, Dawn, Backlight, Beach & Snow), Movie Drive: Single, Continuous, Motion Capture, AEB Timer: 10 Sec, 2 Sec
Videos	<ul style="list-style-type: none"> Modes: Smart Scene Detection (Landscape, Blue Sky, Natural Green, Sunset), Movie Format: MP4 (H.264) (Max recording time: 20 min) Size: 1280 X 720 HQ Fine, 1280 X 720 Normal, 640 X 480 Normal, 320 X 240 Normal Frame Rate: 30 FPS, 15 FPS Sound Alive: Sound Alive On, Sound Alive Off, Mute OIS: On, Off Video editing (embedded): Pause during recording, Still image capture, Time trimming

Camera specifications

Playback	
Type	Single image, Thumbnails, Multi Slide Show with Music and Effect, Movie clip, Smart Album* * Smart Album category: Type, Date, Color, Week, Face
Edit	Resize, Rotate, Image Adjust, Smart Filter, Trim
Effect	<ul style="list-style-type: none"> Image Adjust: Red-eye Fix, Face Retouch, Brightness, Contrast, Saturation, Add Noise Smart Filter: Off, Miniature, Vignetting, Soft-Focus, Old Film 1, Old Film 2, Half Tone Dot, Sketch, Fish-eye, Defog, Classic, Retro, Negative, Custom RGB
Voice recording	
	<ul style="list-style-type: none"> Voice Recording (Maximum 10 hours) Voice Memo in a photo (Maximum 10 sec.)
Storage	
Media	<ul style="list-style-type: none"> Internal memory: Approximately 23 MB External memory (Optional): SD card (up to 8 GB guaranteed), SDHC card (up to 8 GB guaranteed) Internal memory capacity may not match these specifications.

File format	<ul style="list-style-type: none"> DCF, EXIF 2.21, DPOF 1.1, PictBridge 1.0 Still Image: JPEG (DCF) Movie Clip: MP4 (Video: MPEG-4.AVC/H.264, Audio: AAC) Audio file: WAV 				
Image size	For 1 GB SD: Number of photos				
			Super Fine	Fine	Normal
	14m	4320 X 3240	140	207	272
	12m	4320 X 2880	157	231	304
	10m	3648 X 2736	194	285	372
	10m	4320 X 2432	185	272	355
	8m	3264 X 2448	240	351	455
	5m	2592 X 1944	369	531	682
	2m	1920 X 1080	802	1103	1358
	1m	1024 X 768	1676	2115	2433
These figures are measured under Samsung's standard conditions. Your results may vary depending on the shooting conditions and camera settings.					

Camera specifications

Interface

Digital output connector	USB 2.0
Audio input/output	Internal speaker (Mono), Microphone (Stereo)
Video output	<ul style="list-style-type: none">• A/V: NTSC, PAL (selectable)• HDMI 1.4: NTSC, PAL (selectable)
DC power input connector	20 pin, 4.4 V

Power source

Rechargeable battery	Lithium-ion battery (SLB-10A, 1050 mAh)
----------------------	---

The power source may differ depending on your region.

Dimensions (W X H X D)

105.0 X 58.9 X 24.9 mm (4.13 X 2.32 X .98 in.) (without protrusions)

Weight

200 g (7.025 oz.) (without battery and memory card)

Operating Temperature

0-40 °C (32-104 °F)

Operating Humidity

5-85 %

Software

Intelli-studio

Specifications may change without notice to improve performance.

Glossary

AEB (Auto Exposure Bracket)

This feature automatically captures several images at different exposures to help you capture a properly-exposed image.

AF (Auto Focus)

A system that automatically focuses the camera lens on the subject. Your camera uses the contrast to focus automatically.

Aperture

The aperture controls the amount of light that reaches the camera's sensor.

Camera shake (Blur)

If the camera is moved while the shutter is open, the entire image may appear blurred. This occurs more often when the shutter speed is slow. Prevent camera shake by raising the sensitivity, using the flash, or using a faster shutter speed. Alternately, use a tripod, the DIS or OIS function to stabilize the camera.

Composition

Composition in photography means arranging objects in a photo. Usually, abiding by the rule of thirds leads to a good composition.

DCF (Design rule for Camera File system)

A specification to define a file format and file system for digital cameras created by the Japan Electronics and Information Technology Industries Association (JEITA).

Depth of field

The distance between the nearest and farthest points that can be acceptably focused in a photograph. Depth of field varies with lens aperture, focal length, and distance from the camera to the subject. Selecting a smaller aperture, for example, will increase the depth of field and blur the background of a composition.

Digital zoom

A feature that artificially increases the amount of zoom available with a zoom lens (Optical zoom). When using the Digital zoom, the image quality will deteriorate as the magnification increases.

DPOF (Digital Print Order Format)

A format for writing printing information, such as selected images and number of prints, on a memory card. DPOF-compatible printers, sometimes available at photo shops, can read the information from the card for convenient printing.

EV (Exposure Value)

All the combinations of the camera's shutter speed and lens aperture that result in the same exposure.

EV Compensation

This feature allows you to quickly adjust the exposure value measured by the camera, in limited increments, to improve the exposure of your photos. Set the EV compensation to -1.0 EV to adjust the value one step darker and 1.0 EV to one step brighter.

Exif (Exchangeable Image File Format)

A specification to define an image file format for digital cameras created by the Japan Electronic Industries Development Association (JEIDA).

Exposure

The amount of light allowed to reach the camera's sensor. Exposure is controlled by a combination of the shutter speed, the aperture value, and ISO sensitivity.

Flash

A speed light that helps to create adequate exposure in low-light conditions.

Focal length

The distance from the middle of the lens to its focal point (in millimeters). Longer focal lengths result in narrower angles of view and the subject is magnified. Shorter focal lengths result in wider angles of view.

Histogram

A graphical representation of the brightness of an image. The horizontal axis represents the brightness and the vertical axis represents the number of pixels. High points at the left (too dark) and right (too bright) on the histogram indicate a photo that is improperly exposed.

H.264/MPEG-4

A high-compression video format established by international standard organizations ISO-IEC and ITU-T. This codec is capable of providing good video quality at low bit rates developed by the Joint Video Team (JVT).

Image sensor

The physical part of a digital camera that contains a photosite for each pixel in the image. Each photosite records the brightness of the light that strikes it during an exposure. Common sensor types are CCD (Charge-coupled Device) and CMOS (Complementary Metal Oxide Semiconductor).

ISO sensitivity

The sensitivity of the camera to light, based on the equivalent film speed used in a film camera. At higher ISO sensitivity settings, the camera uses a higher shutter speed, which can reduce blur caused by camera shake and low light. However, images with high sensitivity are more susceptible to noise.

JPEG (Joint Photographic Experts Group)

A lossy method of compression for digital images. JPEG images are compressed to reduce their overall file size with minimal deterioration of the image resolution.

LCD (Liquid Crystal Display)

A visual display commonly used in consumer electronics. This display needs a separate backlight, such as CCFL or LED, to reproduce colors.

Macro

This feature allows you to capture close-up photos of very small objects. When using the macro feature, the camera can maintain a sharp focus on small objects at a near life-size ratio (1:1).

Metering

The metering refers to the way in which the camera measures the quantity of light to set the exposure.

MJPEG (Motion JPEG)

A video format which is compressed as a JPEG image.

Noise

Misinterpreted pixels in a digital image that may appear as misplaced or random, bright pixels. Noise usually occurs when photos are shot with a high sensitivity or when a sensitivity is automatically set in a dark place.

Optical zoom

This is a general zoom which can enlarge images with a lens and does not deteriorate quality of images.

Quality

An expression of the rate of compression used in a digital image. Higher quality images have a lower rate of compression, which usually results in a larger file size.

Resolution

The number of pixels present in a digital image. High resolution images contain more pixels and typically show more detail than low resolution images.

Shutter speed

Shutter speed refers to the amount of time it takes to open and close the shutter, and it is an important factor in the brightness of a photo, as it controls the amount of light which passes through the aperture before it reaches the image sensor. A fast shutter speed allows less time to let light in and the photo becomes darker and more easily freezes subjects in motion.

Vignetting

A reduction of an image's brightness or saturation at the periphery (outer edges) compared to the center of the image. Vignetting can draw interest to subjects positioned in the center of an image.

White balance (color balance)

An adjustment of the intensities of colors (typically the primary colors red, green, and blue), in an image. The goal of adjusting the white balance, or color balance, is to correctly render the colors in an image.



**Correct Disposal of This Product
(Waste Electrical & Electronic Equipment)**

(Applicable in the European Union and other European countries with separate collection systems)

This marking on the product, accessories or literature indicates that the product and its electronic accessories (e.g. charger, headset, USB cable) should not be disposed of with other household waste at the end of their working life. To prevent possible harm to the environment or human health from uncontrolled waste disposal, please separate these items from other types of waste and recycle them responsibly to promote the sustainable reuse of material resources. Household users should contact either the retailer where they purchased this product, or their local government office, for details of where and how they can take these items for environmentally safe recycling. Business users should contact their supplier and check the terms and conditions of the purchase contract. This product and its electronic accessories should not be mixed with other commercial wastes for disposal.



PlanetFirst represents Samsung Electronics' commitment to sustainable development and social responsibility through eco-driven business and management activities.



Correct disposal of batteries in this product

(Applicable in the European Union and other European countries with separate battery return systems)

This marking on the battery, manual or packaging indicates that the batteries in this product should not be disposed of with other household waste at the end of their working life. Where marked, the chemical symbols Hg, Cd or Pb indicate that the battery contains mercury, cadmium or lead above the reference levels in EC Directive 2006/66. If batteries are not properly disposed of, these substances can cause harm to human health or the environment.

To protect natural resources and to promote material reuse, please separate batteries from other types of waste and recycle them through your local, free battery return system.

This Class [B] digital apparatus complies with Canadian ICES-003.

Dispose unwanted electronics through an approved recycler.
To find the nearest recycling location, go to our website:
www.samsung.com/recyclingdirect Or call, (877) 278 - 0799

FCC notice

- **NOTE:**

This equipment has been tested and found to comply with the limits for a Class B digital device, pursuant to part 15 of the FCC Rules. These limits are designed to provide reasonable protection against harmful interference in a residential installation. This equipment generates, uses and can radiate radio frequency energy and, if not installed and used in accordance with the instructions, may cause harmful interference to radio communications. However, there is no guarantee that interference will not occur in a particular installation. If this equipment does cause harmful interference to radio or television reception, which can be determined by turning the equipment off and on, the user is encouraged to try to correct the interference by one or more of the following measures:

- Reorientate, or relocate, the receiving antenna.
- Increase the distance between the equipment and receiver.
- Connect the equipment into an outlet on a circuit different from that to which the receiver is connected.
- Consult the dealer or an experienced radio / TV technician for help.

- **CAUTION:**

Changes or modifications not expressly approved by the manufacturer responsible for compliance could void the user's authority to operate the equipment.

- **Declaration of Conformity**

Trade Name	: Samsung Electronics America, Inc.
Model No.	: Samsung WB700
Responsible Party	: Samsung Electronics America, Inc.
Address	: 85 Challenger Road, Ridgefield Park, NJ 07660
Telephone No.	: 1-800-SAMSUNG (726-7864)

This device complies with Part 15 of the FCC Rules. Operation is subject to the following two conditions:
(1) This device may not cause harmful interference, and (2) this device must accept any interference received, including interference that may cause undesired operation.

Index

A

AF-assist light

- location 14
- settings 101

AF Lamp 101

AF Sound 98

Anynet+ 101

Aperture Priority mode 38

Aperture value 37

Auto Exposure Bracket (AEB) 66

A/V port 14

B

Battery

- caution 109
- charging 17
- inserting 16

Beauty Shot mode 34

Blink Detection 58

Brightness

- Playback mode 85
- Shooting mode 61

C

Camera maintenance 104

Camera specifications 115

Capturing an image from video 80

Charging 17

Cleaning

- camera body 104
- display 104
- lens 104

Connecting to a computer

- Mac 94
- Windows 89

Contrast

- Playback mode 85
- Shooting mode 70

D

Date & Time 99

Deleting files 76

Digital Print Order Format (DOF) 86

Digital zoom 26

Disconnecting the camera 93

Display brightness 99

Display type 23

Drive modes

- Auto Exposure Bracket 66
- Continuous 66
- Motion Capture 66

DUAL IS mode 40

E

Editing photos 82

Editing videos

- capturing 80
- trimming 79

Enlarging 77

Error messages 103

Exposure 61

F

Face Detection 56

Flash

- Auto 49
- Fill in 50
- intensity 50
- Off 49
- Red-eye 50
- Red-eye Fix 50
- Slow Sync 50

Focus area

- Center AF 55
- Multi AF 55
- Selection AF 55
- Tracking AF 55

Formatting 99**Function button 15****G****Grid Line 98****H****Half-press shutter 29****HDMI Size 101****HDTV 88****I****Icons**

- Playback mode 72
- Shooting mode 20

Image Adjustment

- Add Noise 85
- Brightness
 - Playback mode 85
 - Shooting mode 61
- Contrast
 - Playback mode 85
 - Shooting mode 70
- Red-eye 84
- Saturation
 - Playback mode 85
 - Shooting mode 70
- Sharpness 70

Image quality 47**Imprint 100****Intelli-studio 91****ISO sensitivity 51****L****Language settings 99****M****Macro**

- Auto Macro 53
- Macro 53
- Manual Focus 53

Manual mode 39**Memory card**

- Caution 107
- Insert 16

Menu button 15**Metering**

- Center-weighted 62
- Multi 62
- Spot 62

Mode dial 15**Motion Capture 66****Movie mode 41****My star**

- cancelling 74
- ranking 73
- registering 59

O**Optical Image Stabilization (OIS) 28****Optional accessories 13****P****PictBridge 95****Playback button 15****Playback mode 72****Power button 14****Power save mode 99****Printing photos 95****Program mode 36****Protecting files 76****Q****Quick view 99**

R**Red-eye**

- Playback mode 84
- Shooting mode 49

Reset 99**Resolution**

- Playback mode 82
- Shooting mode 46

Retouching faces

- Playback mode 84
- Shooting mode 34

Rotating 82**S****Saturation**

- Playback mode 85
- Shooting mode 70

Scene mode 34**Self portrait 57****Service center 112****Settings 99****Sharpness 70****Shooting portraits**

- Beauty Shot mode 34
- Blink Detection 58
- Face Detection 56
- Red-eye 50
- Red-eye fix 50
- Self portrait 57
- Smart Face Recognition 58
- Smile Shot 57

Shutter button 14**Shutter Priority mode 38****Slide show 78****Smart Album 74****Smart Auto mode 32****Smart Face Recognition 58****Smart Filter**

- Playback mode 83
- Shooting mode 67

Smart Scene Detection mode 43**Smart zoom 27****Smile Shot 57****Sound settings 24****Start image 98****Status lamp 15****T****Thumbnails 75****Timer**

- Shooting mode 48
- Timer lamp 14

Time settings 18**Time zone settings 18, 99****Transferring files**

- Mac 94
- Windows 89

Tripod mount 14**U****Unpacking 13****USB port 14****User button 24****V****Video**

- playing 79
- shooting 41

Video out 101**Viewing files**

- Slide show 78
- Smart Album 74
- Thumbnails 75
- TV 87

Voice memo

- playing 80
- recording 44

W

White Balance 63

Z

Zoom

- using the zoom 26
- zoom button 15
- zoom sound settings 41



Please refer to the warranty that came with your product or visit our website www.samsung.com/ for after-sales service or inquiries.

