

SONY®

4-159-241-11 (1)

α

Preparing the camera

Before your operation

Shooting images

Using the shooting  
function

Using the viewing  
function

Changing your setup

Viewing images on a  
computer

Printing images

Additional information on this product and answers to frequently asked questions can be found at our Customer Support Website.

<http://www.sony.net/>

Printed using VOC (Volatile Organic Compound)-free vegetable oil based ink.

Printed in Thailand



4 15924 1110

α450

Digital Single Lens Reflex Camera  
**Instruction Manual**

**DSLR-A450**



InfoLITHIUM™



MEMORY STICK™

HDMI



© 2010 Sony Corporation

## Owner's Record

The model and serial numbers are located on the bottom.

Record the serial number in the space provided below.

Refer to these numbers whenever you call upon your Sony dealer regarding this product.

Model No. DSLR-A450

Serial No. \_\_\_\_\_

## WARNING

**To reduce fire or shock hazard, do not expose the unit to rain or moisture.**

# IMPORTANT SAFETY INSTRUCTIONS SAVE THESE INSTRUCTIONS. DANGER - TO REDUCE THE RISK OF FIRE OR ELECTRIC SHOCK, CAREFULLY FOLLOW THESE INSTRUCTIONS.

If the shape of the plug does not fit the power outlet, use an attachment plug adaptor of the proper configuration for the power outlet.

## Caution

### Battery pack

If the battery pack is mishandled, the battery pack can burst, cause a fire or even chemical burns. Observe the following cautions.

- Do not disassemble.
- Do not crush and do not expose the battery pack to any shock or force such as hammering, dropping or stepping on it.
- Do not short circuit and do not allow metal objects to come into contact with the battery terminals.
- Do not expose to high temperature above 60°C (140°F) such as in direct sunlight or in a car parked in the sun.
- Do not incinerate or dispose of in fire.
- Do not handle damaged or leaking lithium ion batteries.
- Be sure to charge the battery pack using a genuine Sony battery charger or a device that can charge the battery pack.

- Keep the battery pack out of the reach of small children.
- Keep the battery pack dry.
- Replace only with the same or equivalent type recommended by Sony.
- Dispose of used battery pack promptly described the instructions.

### Battery charger

Even if the CHARGE lamp is not lit, the battery charger is not disconnected from the AC power source (mains) as long as it is connected to the wall outlet (wall socket). If some trouble occurs while using the battery charger, immediately shut off the power by disconnecting the plug from the wall outlet (wall socket).

## For Customers in the U.S.A. and Canada

### RECYCLING LITHIUM-ION BATTERIES

Lithium-Ion batteries are recyclable.

You can help preserve our environment by returning your used rechargeable batteries to the collection and recycling location nearest you.



For more information regarding recycling of rechargeable batteries, call toll free 1-800-822-8837, or visit <http://www.rbc.org/>

**Caution:** Do not handle damaged or leaking Lithium-Ion batteries.

### Battery pack

This device complies with Part 15 of the FCC Rules, Operation is subject to the following two conditions:

(1) This device may not cause harmful interference, and (2) this device must accept any interference received, including interference that may cause undesired operation.

This Class B digital apparatus complies with Canadian ICES-003.

## For Customers in the U.S.A.

UL is an internationally recognized safety organization. The UL Mark on the product means it has been UL Listed.

If you have any questions about this product, you may call:

Sony Customer Information Services  
Center  
1-800-222-SONY (7669)

The number below is for the FCC related matters only.

### Regulatory Information

Declaration of Conformity  
Trade Name: SONY  
Model No.: DSLR-A450  
Responsible Party: Sony Electronics Inc.  
Address: 16530 Via Esprillo,  
San Diego, CA 92127 U.S.A.  
Telephone No.: 858-942-2230

This device complies with Part 15 of the FCC Rules. Operation is subject to the following two conditions: (1) This device may not cause harmful interference, and (2) this device must accept any interference received, including interference that may cause undesired operation.

### CAUTION

You are cautioned that any changes or modifications not expressly approved in this manual could void your authority to operate this equipment.

**Note:**

This equipment has been tested and found to comply with the limits for a Class B digital device, pursuant to Part 15 of the FCC Rules.

These limits are designed to provide reasonable protection against harmful interference in a residential installation. This equipment generates, uses, and can radiate radio frequency energy and, if not installed and used in accordance with the instructions, may cause harmful interference to radio communications. However, there is no guarantee that interference will not occur in a particular installation. If this equipment does cause harmful interference to radio or television reception, which can be determined by turning the equipment off and on, the user is encouraged to try to correct the interference by one or more of the following measures:

- Reorient or relocate the receiving antenna.
- Increase the separation between the equipment and receiver.
- Connect the equipment into an outlet on a circuit different from that to which the receiver is connected.
- Consult the dealer or an experienced radio/TV technician for help.

The supplied interface cable must be used with the equipment in order to comply with the limits for a digital device pursuant to Subpart B of Part 15 of FCC Rules.

**For Customers in Europe****Notice for the customers in the countries applying EU Directives**

The manufacturer of this product is Sony Corporation, 1-7-1 Konan Minato-ku Tokyo, 108-0075 Japan. The Authorized Representative for EMC and product safety is Sony Deutschland GmbH, Hedelfinger Strasse 61, 70327 Stuttgart, Germany. For any service or guarantee matters please refer to the addresses given in separate service or guarantee documents.

This product has been tested and found compliant with the limits set out in the EMC Directive for using connection cables shorter than 3 meters (9.8 feet).

**Attention**

The electromagnetic fields at the specific frequencies may influence the picture and sound of this unit.

**Notice**

If static electricity or electromagnetism causes data transfer to discontinue midway (fail), restart the application or disconnect and connect the communication cable (USB, etc.) again.

### **Disposal of Old Electrical & Electronic Equipment (Applicable in the European Union and other European countries with separate collection systems)**



This symbol on the product or on its packaging indicates that this product shall not be treated as household waste. Instead it shall be handed over to the applicable collection point for the recycling of electrical and electronic equipment. By ensuring this product is disposed of correctly, you will help prevent potential negative consequences for the environment and human health, which could otherwise be caused by inappropriate waste handling of this product. The recycling of materials will help to conserve natural resources. For more detailed information about recycling of this product, please contact your local Civic Office, your household waste disposal service or the shop where you purchased the product.

### **Disposal of waste batteries (applicable in the European Union and other European countries with separate collection systems)**



This symbol on the battery or on the packaging indicates that the battery provided with this product shall not be treated as household waste.

On certain batteries this symbol might be used in combination with a chemical symbol. The chemical symbols for mercury (Hg) or lead (Pb) are added if the battery contains more than 0.0005% mercury or 0.004% lead.

By ensuring these batteries are disposed of correctly, you will help prevent potentially negative consequences for the environment and human health which could otherwise be caused by inappropriate waste handling of the battery. The recycling of the materials will help to conserve natural resources.



In case of products that for safety, performance or data integrity reasons require a permanent connection with an incorporated battery, this battery should be replaced by qualified service staff only. To ensure that the battery will be treated properly, hand over the product at end-of-life to the applicable collection point for the recycling of electrical and electronic equipment.

For all other batteries, please view the section on how to remove the battery from the product safely. Hand the battery over to the applicable collection point for the recycling of waste batteries.

For more detailed information about recycling of this product or battery, please contact your local Civic Office, your household waste disposal service or the shop where you purchased the product.

## Notice for customers in the United Kingdom

A moulded plug complying with BS 1363 is fitted to this equipment for your safety and convenience.

Should the fuse in the plug supplied need to be replaced, a fuse of the same rating as the supplied one and approved by ASTA or BSI to BS 1362, (i.e., marked with an  or  mark) must be used.

If the plug supplied with this equipment has a detachable fuse cover, be sure to attach the fuse cover after you change the fuse.

Never use the plug without the fuse cover.

If you should lose the fuse cover, please contact your nearest Sony service station.

# Notes on using your camera

## Shooting procedure

In manual focus check Live View mode, the recorded image may be different from the image you monitored with the LCD monitor.

## No compensation for contents of the recording

The contents of the recording cannot be compensated for if recording or playback is not possible due to a malfunction of your camera or a memory card, etc.

## Back up recommendation

To avoid the potential risk of data loss, always copy (back up) data to other medium.

## Notes on the LCD monitor and lens

- The LCD monitor is manufactured using extremely high-precision technology so over 99.99% of the pixels are operational for effective use. However, there may be some tiny black points and/or bright points (white, red, blue or green in color) that constantly appear on the LCD monitor. These points are normal in the manufacturing process and do not affect the images in any way.

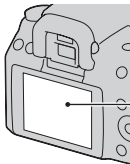

Black, white, red,  
blue and green  
points

- Do not expose the camera to direct sunlight. If sunlight is focused on a nearby object, it may cause a fire. When you must place the camera under direct sunlight, attach the lens cap.
- Images may trail across on the LCD monitor in a cold location. This is not a malfunction. When turning on the camera in a cold location, the LCD monitor may become temporarily dark. When the

camera warms up, the monitor will function normally.

- Do not press against the LCD monitor. The monitor may be discolored and that may cause a malfunction.

## Warning on copyright

Television programs, films, videotapes, and other materials may be copyrighted. Unauthorized recording of such materials may be contrary to the provisions of the copyright laws.







## The pictures used in this manual

The photographs used as examples of pictures in this manual are reproduced images, and are not actual images shot using this camera.

## On the data specifications described in this Instruction Manual



The data on performance and specifications is defined under the following conditions, except as described in this Instruction Manual: at an ordinary ambient temperature of 25°C (77°F), and using a fully charged battery pack.

# Table of Contents

	Notes on using your camera .....	7
<b>Preparing the camera</b>	Checking the accessories supplied .....	12
	Preparing the battery pack .....	13
	Attaching a lens .....	20
	Inserting a memory card .....	22
	Preparing the camera .....	25
	Using the accessories supplied .....	27
	Checking the number of recordable images .....	29
	Cleaning .....	31
<b>Before your operation</b>	Identifying parts and screen indicators .....	34
	Front side .....	34
	Rear side .....	35
	Top .....	36
	Sides/Bottom .....	37
	Switching the recording information display (DISP) .....	38
	LCD monitor (Graphic Display) .....	39
	LCD monitor (Standard Display) .....	41
	Viewfinder .....	43
	Selecting a function/setting .....	44
	Selecting a function with the Fn (Function) button ...	45
	The functions selected by the Fn (Function) button ...	46
	The functions selected by the MENU button .....	46
<b>Shooting images</b>	Shooting an image without camera shake .....	48
	Correct posture .....	48
	Using the SteadyShot function .....	49
	Using a tripod .....	50
	<b>AUTO</b> /  Shooting with the automatic setting.....	51
	Shooting with a suitable setting for the subject (Scene Selection) .....	53
	 Taking portrait photos .....	54
	 Taking landscape photos .....	55
	 Taking small-subject photos .....	56
	 Taking moving-subject photos .....	57
	 Taking sunset photos .....	58
	 Taking night view photos .....	59



	Shooting an image the way you want it (Exposure mode)	60
	P Shooting with program auto	61
	A Shooting by controlling the blur of the background (Aperture priority)	62
	S Shooting a moving subject with various expressions (Shutter speed priority)	64
	M Shooting with the exposure adjusted manually (Manual exposure)	66
	M Shooting trails with long exposure (BULB)	69
<b>Using the shooting function</b>	Selecting the focus method	71
	Using autofocus	71
	Shooting with your desired composition (Focus-lock)	73
	Selecting the focus method to suit the movement of the subject (Autofocus mode)	74
	Selecting the focus area (AF area)	75
	Adjusting the focus manually (Manual focus)	76
	Shooting with the manual focus check Live View	77
	Switching the recording information display (DISP)	79
	LCD monitor	80
	Using the flash	82
	Performing wireless flash shooting	85
	Adjusting the brightness of the image (Exposure, Flash compensation, Metering)	86
	Shooting with fixed brightness (AE Lock)	86
	Using brightness compensation for the entire image (Exposure compensation)	87
	Adjusting the amount of flash light (Flash compensation)	88
	Selecting the flash control mode to set the amount of flash light (Flash control)	89
	Selecting the method for measuring the brightness of a subject (Metering mode)	90

Compensating for the brightness and contrast automatically (D-Range) .....	91
Correcting the brightness of the image (D-Range Optimizer) .....	91
Compensating automatically with rich gradation (Auto High Dynamic Range) .....	92
Image processing .....	94
Selecting your desired image processing (Creative Style) .....	94
Changing the range of color reproduction (Color Space) .....	95
Setting ISO .....	96
Adjusting the color tones (White balance) .....	97
Adjusting the white balance to suit a specific light source (Auto/Preset white balance) .....	97
Setting the color temperature and a filter effect (Color Temperature/Color filter) .....	98
Registering the color tones (Custom white balance) .....	99
 /  Selecting the drive mode .....	101
Shooting single shot .....	101
Shooting continuously .....	101
Using the self-timer .....	102
Shooting images with the exposure shifted (Exposure bracket) .....	103
Shooting with white balance shifted (WB bracket) .....	104
Shooting with the Wireless Remote Commander ....	105
<b>Using the viewing function</b>	
Playing back images .....	106
Checking the information of recorded images .....	111
Protecting images (Protect) .....	114
Deleting images (Delete) .....	115
Viewing images on a TV screen .....	117

<b>Changing your setup</b>	Setting image size and image quality .....	120
	Setting the method for recording on a memory card .....	122
	Changing the noise reduction setting .....	124
	Changing the function of the AEL button .....	125
	Changing other settings .....	126
	Setting the LCD monitor .....	127
	Confirming the version of the camera .....	128
Resetting to the default .....	129	
<b>Viewing images on a computer</b>	Using your computer .....	131
	Using the software .....	138
<b>Printing images</b>	Specifying DPOF .....	143
	Printing images by connecting the camera to a PictBridge compliant printer .....	145
<b>Others</b>	Specifications .....	147
	Troubleshooting .....	151
	Warning messages .....	160
	Precautions .....	163
<b>Index</b> .....		<b>165</b>

# Checking the accessories supplied

The number in parentheses indicates the number of pieces.

- BC-VM10 Battery charger (1)/  
Power cord (mains lead) (1)
- Instruction Manual (This manual)  
(1)



- Rechargeable battery pack NP-FM500H (1)



- USB cable (1)



- Shoulder strap (1)

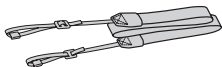

- Eyepiece cover (1)



- Body cap (1) (Attached on the camera)



- Eyecup (1) (Attached on the camera)
- CD-ROM (Application Software for  $\alpha$  camera) (1)

# Preparing the battery pack

When using the camera for the first time, be sure to charge the NP-FM500H “InfoLITHIUM” battery pack (supplied).

## Charging the battery pack

The “InfoLITHIUM” battery pack can be charged even when it has not been fully depleted.

It can also be used when it has not been fully charged.

### 1 Insert the battery pack on the battery charger.

Push the battery pack until it clicks.

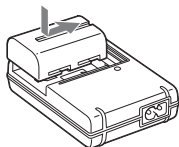

### 2 Connect the power cord (mains lead).

Light on: Charging

Light off: Normal charge completed

One hour after the lamp is turned off: Full charge completed

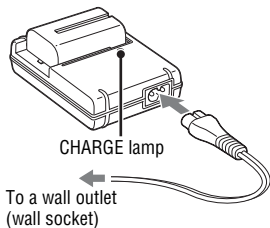

### About charging time

- Time required to charge a fully depleted battery pack (supplied) at a temperature of 25°C (77°F) is as follows.

Full charge	Normal charge
Approx. 235 min.	Approx. 175 min.

- The charging time differs depending on the remaining capacity of the battery pack or charging conditions.

- We recommend charging the battery pack in an ambient temperature of between 10 to 30°C (50 to 86°F). You may not be able to efficiently charge the battery pack outside of this temperature range.

### **Notes**

- Connect the battery charger to the nearest wall outlet (wall socket).
- When charging is finished, disconnect the power cord (mains lead) from the wall outlet (wall socket), and remove the battery pack from the battery charger. If you leave the charged battery pack on the charger, battery life may be decreased.
- Do not charge any battery pack other than the “InfoLITHIUM” M series battery pack in the battery charger (supplied) with your camera. Batteries other than the specified kind may leak, overheat, or explode if you attempt to charge them, posing a risk of injury from electrocution and burns.
- When the CHARGE lamp flashes, this may indicate a battery error or that a battery pack other than the specified type has been installed. Check that the battery pack is the specified type. If the battery pack is the specified type, remove the battery pack, replace it with new one or another one and check if the battery charger operates correctly. If the battery charger operates correctly, a battery error may have occurred.
- If the battery charger is dirty, charging may not be performed successfully. Clean the battery charger with dry cloth, etc.

### **To use your camera abroad — Power sources**

You can use your camera and the battery charger and the AC-PW10AM AC Adaptor (sold separately) in any country or region where the power supply is within 100 V to 240 V AC, 50/60 Hz.

### **Note**

- Do not use an electronic transformer (travel converter), as this may cause a malfunction.

## Representative plug of power supply cord of countries/regions around the world.



A Type  
(American  
Type)



B Type  
(British  
Type)



BF Type  
(British  
Type)



B3 Type  
(British  
Type)



C Type  
(CEE  
Type)



SE Type  
(CEE  
Type)



O Type  
(Ocean  
Type)

The representative supply voltage and plug type are described in this chart.  
Depend on an area, Different type of plug and supply voltage are used.

Attention: Power cord meeting demands from each country shall be used.

-For only the United States

Use a UL Listed, 1.5-3 m (5-10 ft.), Type SPT-2 or NISPT-2, AWG no. 18 power supply cord, rated for 125 V 7 A, with a non-polarized NEMA 1-15P plug rated for 125 V 15 A.”

### Europe

Countries/regions	Voltage	Frequency (Hz)	Plug type
Austria	230	50	C
Belgium	230	50	C
Czech	220	50	C
Denmark	230	50	C
Finland	230	50	C
France	230	50	C
Germany	230	50	C
Greece	220	50	C
Hungary	220	50	C
Iceland	230	50	C
Ireland	230	50	C/BF
Italy	220	50	C
Luxemburg	230	50	C
Netherlands	230	50	C
Norway	230	50	C
Poland	220	50	C
Portugal	230	50	C
Romania	220	50	C
Russia	220	50	C
Slovak	220	50	C
Spain	127/230	50	C
Sweden	230	50	C
Switzerland	230	50	C
UK	240	50	BF

### Asia

Countries/regions	Voltage	Frequency (Hz)	Plug type
China	220	50	A
Hong Kong	200/220	50	BF
India	230/240	50	C
Indonesia	127/230	50	C
Japan	100	50/60	A
Korea (rep)	220	60	C
Malaysia	240	50	BF
Philippines	220/230	60	A/C

Singapore	230	50	BF
Taiwan	110	60	A
Thailand	220	50	C/BF
Vietnam	220	50	A/C

### Oceania

Countries/regions	Voltage	Frequency (Hz)	Plug type
Australia	240	50	O
New Zealand	230/240	50	O

### North America

Countries/regions	Voltage	Frequency (Hz)	Plug type
Canada	120	60	A
USA	120	60	A

### Central America

Countries/regions	Voltage	Frequency (Hz)	Plug type
Bahamas	120/240	60	A
Costa Rica	110	60	A
Cuba	110/220	60	A/C
Dominican (rep)	110	60	A
El Salvador	110	60	A
Guatemala	120	60	A
Honduras	110	60	A
Jamaica	110	50	A
Mexico	120/127	60	A
Nicaragua	120/240	60	A
Panama	110/220	60	A

### South America

Countries/regions	Voltage	Frequency (Hz)	Plug type
Argentina	220	50	C/BF/O
Brazil	127/220	60	A/C
Chile	220	50	C
Colombia	120	60	A
Peru	220	60	A/C
Venezuela	120	60	A

### Middle East

Countries/regions	Voltage	Frequency (Hz)	Plug type
Iran	220	50	C/BF
Iraq	220	50	C/BF
Israel	230	50	C
Saudi Arabia	127/220	50	A/C/BF
Turkey	220	50	C
UAE	240	50	C/BF

### Africa

Countries/regions	Voltage	Frequency (Hz)	Plug type
Algeria	127/220	50	C
Congo (dem)	220	50	C
Egypt	220	50	C
Ethiopia	220	50	C
Kenya	240	50	C/BF
Nigeria	230	50	C/BF
South Africa	220/230	50	C/BF
Tanzania	230	50	C/BF
Tunisia	220	50	C



## Inserting the charged battery pack

- 1** While sliding the battery cover open lever, open the battery cover.

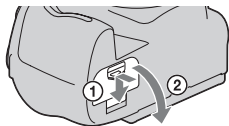

- 2** Firmly insert the battery pack all the way while pressing the lock lever with the tip of the battery.

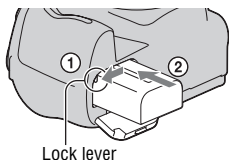

- 3** Close the battery cover.

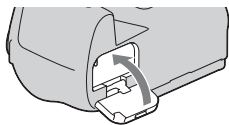

### To remove the battery pack

Turn off the camera and slide the lock lever in the direction of the arrow. Be careful not to drop the battery pack.

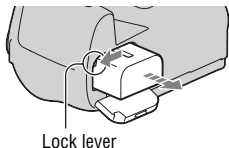

## To remove the battery cover

The battery cover can be removed to attach the VG-B50AM Vertical Grip (sold separately).

To remove the cover, push the lever in the direction of the arrow and slide it out.

To attach the cover, put the knob in the hole, pull down the lever, and slide it in.

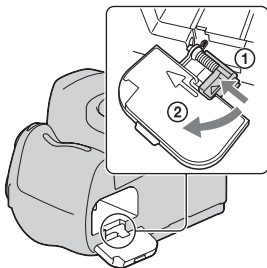

## To check the remaining battery level

Check the level with the following indicators and percent figures displayed on the LCD monitor.

Battery level						<b>"Battery exhausted"</b>
	High  Low					You cannot shoot any more pictures.

## What is an "InfoLITHIUM" battery pack?

An "InfoLITHIUM" battery pack is a lithium-ion battery pack that has functions for exchanging information related to operating conditions with your camera. Using the "InfoLITHIUM" battery pack, the remaining battery time in percent figures is displayed according to the operating conditions of your camera.

### Notes

- The displayed level may not be correct under certain circumstances.
- Do not expose the battery pack to water. The battery pack is not water-resistant.
- Do not leave the battery pack in extremely hot places, such as in a car or under direct sunlight.

## Available battery packs

Use only an NP-FM500H battery pack. Note that the NP-FM55H, NP-FM50 and NP-FM30 cannot be used.

### **Effective use of the battery pack**

- Battery performance decreases in low temperature surroundings. So, the time that the battery pack can be used is shorter in cold places and the speed of continuous shooting slows down. We recommend that you put the battery pack in a pocket close to your body to warm it up, and insert it in your camera immediately before you start shooting.
- The battery pack will run out quickly if you use the flash frequently, use continuous shooting often, or turn the camera on and off frequently.
- When you use the manual focus check Live View function, the time available is shorter than that available when you shoot using the viewfinder only.

### **Battery life**

- The battery life is limited. Battery capacity decreases little by little as you use it more and more, and as time passes. If the battery operating time seems shortened considerably, a probable cause is that the battery pack has reached the end of its life. Buy a new battery pack.
- The battery life varies according to how it is stored and the operating conditions and environment in which each battery pack is used.

### **How to store the battery pack**

If the battery pack is not to be used for a long time, fully charge it and then fully use it up once a year on your camera before storing the battery pack in a dry, cool place to prolong the battery life.

# Attaching a lens

---

## 1 Remove the body cap from the camera and the packaging lid from the rear of the lens.

- When changing the lens, quickly change the lens away from dusty locations so as to keep dust or debris from getting inside the camera.

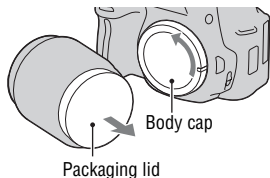

## 2 Mount the lens by aligning the orange index marks on the lens and camera.

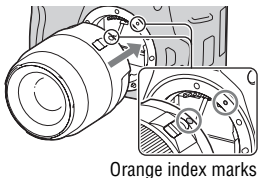

## 3 Turn the lens clockwise until it clicks into the locked position.

- Be sure to put the lens on straight.

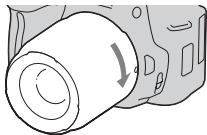

---

### Notes

- When attaching a lens, do not press the lens release button.
- Do not use force when attaching a lens.

## To remove the lens

- 1 Press the lens release button all the way in and turn the lens counterclockwise until it stops.**

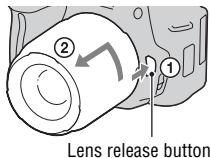

- 2 Replace the packaging lid on the lens and attach the body cap to the camera.**

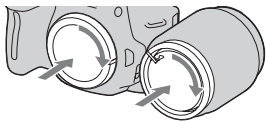

- Before you attach them, remove dust from them.
- A rear lens cap is not supplied with the DT 18-55mm F3.5-5.6 SAM Lens Kit. When you store the lens without attaching it to the camera, purchase the Rear Lens Cap ALC-R55.

### Note on changing the lens

When changing the lens, if dust or debris gets inside the camera and lands on the surface of the image sensor (the part that acts as the film), it may appear on the image, depending on the shooting environment.

The camera is equipped with an anti-dust function to prevent dust from landing on the image sensor. However, quickly change the lens away from dusty locations when attaching/removing a lens.

### If dust or debris lands on the image sensor

Clean the image sensor using [Cleaning mode] in the  Setup menu (page 32).

# Inserting a memory card

Only “Memory Stick PRO Duo” media, “Memory Stick PRO-HG Duo” media, SD memory cards and SDHC memory cards can be used with this camera. A MultiMediaCard cannot be used with this camera.

The “Memory Stick PRO Duo” media and “Memory Stick PRO-HG Duo” media are referred to as the “Memory Stick PRO Duo” media and the SD memory card and SDHC memory card are referred to as the “SD memory card” in this Instruction Manual.

## 1 Open the memory card cover.

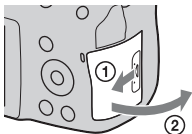

## 2 Insert “Memory Stick PRO Duo” media or an SD memory card.

- Insert the memory card until it clicks as illustrated.

Face side (SD memory card)

Terminal part

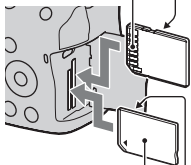

Face side (“Memory Stick PRO Duo”)

Terminal part

## 3 Select the type of memory card you want to use using the memory card switch.

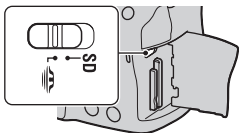

## 4 Close the memory card cover.

## To remove the memory card

Check that the access lamp is not lit, then open the memory card cover, and push the memory card once.

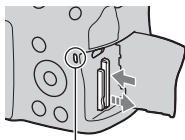

Access lamp



## Notes on using memory cards

- Do not strike, bend or drop the memory card.
- Do not use or store the memory card under the following conditions:
  - High temperature locations such as the hot interior of a car parked in direct sunlight.
  - Locations exposed to direct sunlight.
  - Humid locations or locations with corrosive substances present.
- The memory card may be hot just after it has been used for a long time. Be careful when you handle it.
- When the access lamp is lit, do not remove the memory card or the battery pack, or turn off the power. The data may be corrupted.
- Data may be damaged if you place the memory card near strongly-magnetized material or use the memory card in a static-prone or electrically noisy environment.
- We recommend backing up important data, such as to a hard disk of a computer.
- When you carry or store the memory card, put it in the case supplied with it.
- Do not expose the memory card to water.
- Do not touch the terminal section of the memory card with your hand or a metal object.
- When the write-protect switch of a memory card is set to the LOCK position, you cannot perform operations, such as recording or deleting images.
- The “Memory Stick PRO Duo” media with a capacity up to 32 GB or the SD memory cards with a capacity up to 32 GB have been confirmed to operate properly with this camera.

- The memory cards formatted with a computer are not guaranteed to operate with this camera. Be sure to format the memory cards using the camera.
- Data read/write speeds differ depending on the combination of the memory cards and the equipment used.
- Do not press down hard when you write down on the memo area.
- Do not attach a label on the memory cards themselves.
- Do not disassemble or modify the memory cards.
- Do not leave the memory cards within the reach of small children. They might accidentally swallow it.

### Notes on the “Memory Stick” media used with the camera

The types of “Memory Stick” media that can be used with this camera are listed in the table below. However, proper operation cannot be guaranteed for all “Memory Stick PRO Duo” media functions.

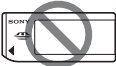
“Memory Stick PRO Duo” media*	Available with your camera	
“Memory Stick PRO-HG Duo” media*		
“Memory Stick Duo” media	Unavailable with your camera	
“Memory Stick” media and “Memory Stick PRO” media	Unavailable with your camera	

\* This is equipped with MagicGate function. MagicGate is copyright protection technology that uses encryption technology. Data recording/playback that requires MagicGate functions cannot be performed with this camera.

\* Supports high-speed data transfer using a parallel interface.



# Preparing the camera

## Setting up the date

When you turn the camera on for the first time, the date/time setup screen appears.

### 1 Set the power switch to ON to turn the camera on.

- To turn the camera off, set it to OFF.

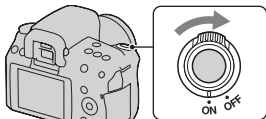

### 2 Verify that [OK] is selected on the LCD monitor, then press the center of the controller.

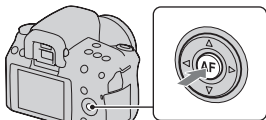

### 3 Select each item with ◀/▶ and set the numeric value with ▲/▼.

- When changing the sequence of [YYYY/MM/DD], first select [YYYY/MM/DD] with ◀/▶, then change it with ▲/▼.

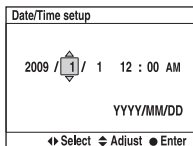
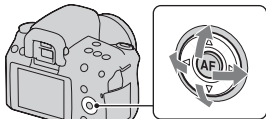

### 4 Repeat step 3 to set other items, then press the center of the controller.

---

## 5 Verify that [OK] is selected, then press the center of the controller.

---

### To cancel the date/time setting operation

Press the MENU button.

### To set up the date/time again

**MENU button** →  **1** → [Date/Time setup]

## Adjusting the focus of the finder (diopter adjustment)

### Adjust the diopter-adjustment dial to your eyesight until the display appears clearly in the viewfinder.

- Training the camera on a light allows you to adjust the diopter easily.
- When the indicators do not appear clearly, even if you adjust the diopter, it is recommended that you use a dioptic adjustment attachment (sold separately).

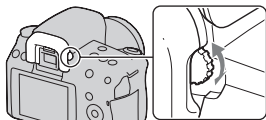

### When it is hard to rotate the diopter-adjustment dial

Put your fingers under the eyecup, and slide it upward to remove the eyecup, then adjust the diopter.

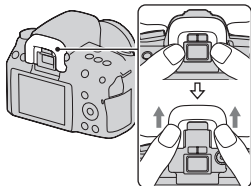

## Using the accessories supplied

This section describes how to use the shoulder strap, the eyepiece cover, and eyecup. The other accessories are described in the following pages.

- Rechargeable battery pack (page 13)
- Battery charger, Power cord (mains lead) (page 13)
- USB cable (pages 132, 145)
- CD-ROM (page 139)

### Attaching the shoulder strap

**Attach both ends of the strap onto the camera.**

- You can also attach the eyepiece cover (page 28) on the strap.

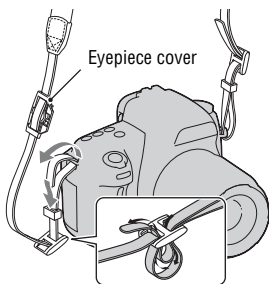

## Using the eyepiece cover and eyecup

You can prevent light from entering through the viewfinder and affecting the exposure. When the shutter is released without the use of the viewfinder, as in shooting with the self-timer, attach the eyepiece cover.

### 1 Carefully slide the eyecup off by pushing on each side of the eyecup.

- Put your fingers under the eyecup, and slide it upward.
- When attaching the FDA-MIAM Magnifier (sold separately), the FDA-AIAM Angle Finder (sold separately), or the FDA-ME1AM Magnifying Eyepiece (sold separately) to the camera, remove the eyecup as illustrated and attach them.

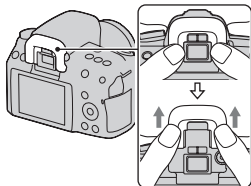

### 2 Slide the eyepiece cover over the viewfinder.

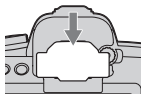

#### Notes

- When shooting with the eyepiece cover, the eyepiece sensors cannot be activated. When using the eyepiece cover, turn off both [Eye-Start AF] (page 73) and [Auto off w/ VF] (page 127).
- To turn the LCD monitor on and off, use the DISP (Display) button.

# Checking the number of recordable images

Once you insert a memory card into the camera and set the power switch to ON, the number of images that can be recorded (should you continue to shoot using the current settings) is displayed on the LCD monitor.

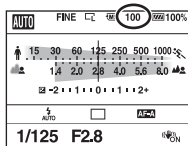

## Notes

- When “0” (the number of recordable images) flashes in yellow, the memory card is full. Replace the memory card with another one, or delete images in the current memory card (page 115).
- When “NO CARD” (the number of recordable images) flashes in yellow, it means no memory card has been inserted. Insert a memory card.

## The number of images that can be recorded on a memory card

The table shows the approximate number of images that can be recorded on a memory card formatted with this camera. The values are defined using Sony standard memory cards for testing. The values may vary depending on the shooting conditions.

**Image size: L 14M**

**Aspect ratio: 3:2\***

**“Memory Stick PRO Duo”**

**(Units: Images)**

Size \ Capacity	2GB	4GB	8GB	16GB	32GB
Standard	451	893	1796	3642	7188
Fine	319	633	1273	2582	5096
RAW & JPEG	92	184	370	752	1485
RAW	131	260	523	1062	2097

## SD memory card

(Units: Images)

Size \ Capacity	2GB	4GB	8GB	16GB	32GB
Standard	442	890	1793	3642	7188
Fine	313	631	1271	2582	5096
RAW & JPEG	90	183	370	752	1485
RAW	128	259	522	1062	2097

\* When [Aspect ratio] is set to [16:9], you can record more images than the numbers shown in the table above. However, if it is set to [RAW], the number is the same as that of the [3:2] aspect ratio.

## The number of images that can be recorded using a battery pack

The approximate number of images that can be recorded is 1050 when you use the camera with the battery pack (supplied) at full capacity.

Note that the actual numbers may be less than those indicated depending on the conditions of use.

- The number is calculated with a battery pack at full capacity and in the following situation:
  - At an ambient temperature of 25°C (77°F).
  - [Quality] is set to [Fine].
  - [Autofocus mode] is set to **AF-A** (Automatic AF).
  - Shooting once every 30 seconds.
  - The flash strobes once every two times.
  - The power turns on and off once every ten times.
- The measurement method is based on the CIPA standard.  
(CIPA: Camera & Imaging Products Association)

# Cleaning

## Cleaning the camera

- Do not touch the inside of the camera, such as lens contacts, or the mirror. Since dust on the mirror or around the mirror may affect the autofocus system, blow away dust using a commercially available blower\*. For details on cleaning the image sensor, see the next page.
  - \* Do not use a spray blower. Using one may cause a malfunction.
- Clean the camera surface with a soft cloth slightly moistened with water, then wipe the surface with a dry cloth. Do not use the following as they may damage the finish or the casing.
  - Chemical products such as thinner, benzine, alcohol, disposable cloths, insect repellent, sunscreen or insecticide, etc.
  - Do not touch the camera with the above on your hand.
  - Do not leave the camera in contact with rubber or vinyl for a long time.

## Cleaning the lens

- Do not use a cleaning solution containing organic solvents, such as thinner, or benzine.
- When cleaning the lens surface, remove dust using a commercially available blower. In case of dust that sticks to the surface, wipe it off with a soft cloth or tissue paper slightly moistened with lens cleaning solution. Wipe in a spiral pattern from the center to the outside. Do not spray lens cleaning solution directly onto the lens surface.

## Cleaning the image sensor

If dust or debris enters the camera and lands on the image sensor (the part that acts as the film), it may appear on the photo image, depending on the shooting environment. If there is dust on the image sensor, use a commercially available blower and clean the image sensor following the steps below. You can easily clean the image sensor using only the blower and the anti-dust function.

### Notes

- Cleaning can be performed only when the battery level is  (three remaining battery icons) or more. Low battery power during cleaning can cause damage to the shutter. The cleaning should be completed quickly. The use of an AC-PW10AM AC Adaptor (sold separately) is recommended.
- Do not use a spray blower because it may scatter water droplets inside the camera body.

---

### 1 Confirm that the battery is fully charged (page 18).

---

### 2 Press the MENU button, then select 3 with on the controller.

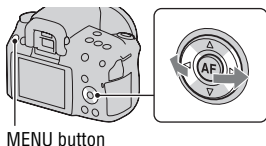

---

### 3 Select [Cleaning mode] with , then press the center of the controller.

The message “After cleaning, turn camera off. Continue?” appears.

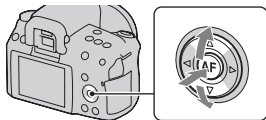

---

### 4 Select [OK] with , and press the center of the controller.

After the image sensor vibrates for a short time, the mirror in front is lifted.

---

### 5 Detach the lens (page 21).



---

## 6 Use the blower to clean the image sensor surface and the surrounding area.

- Do not touch the image sensor with the tip of the blower. Complete the cleaning quickly.
- Hold the camera's face downward to prevent the dust from resettling in the camera.
- When cleaning the image sensor, do not put the tip of a blower into the cavity beyond the mount.

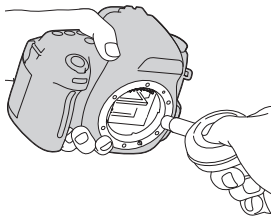

---

## 7 Attach the lens and turn the camera off.

---

### Note

- The camera starts beeping if the battery pack becomes low during cleaning. Stop cleaning immediately and turn the camera off.

# Identifying parts and screen indicators

See the pages in parentheses for details of operation.

## Front side

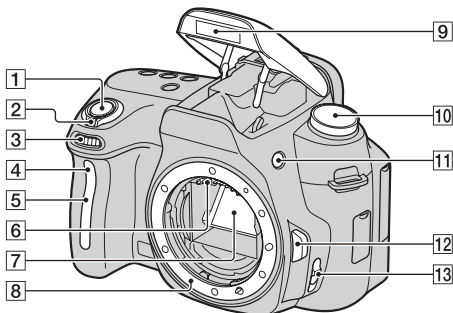

- 1 Shutter button (51)
- 2 Power switch (25)
- 3 Control dial (63)
- 4 Self-timer lamp (102)
- 5 Remote sensor
- 6 Lens contacts\*
- 7 Mirror\*
- 8 Mount
- 9 Built-in flash\* (82)
- 10 Mode dial (51 – 70)
- 11 ⚡ (Flash pop-up) button (82)
- 12 Lens release button (21)
- 13 Focus mode switch (71, 76)

\* **Do not directly touch these parts.**

## Rear side

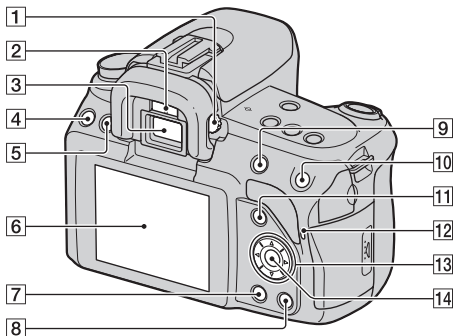

1 Diopter-adjustment dial (26)

2 Eyepiece sensors (73, 127)

3 Viewfinder\* (26, 43)

4 MENU button (46)



5 DISP (Display) button (38, 79, 106)

6 LCD monitor (39, 106, 111)

7  (Playback) button (106)

8  (Delete) button (115)

9 For shooting:  (Exposure) button (87)

For viewing:  (Zoom out) button (107)/ (Image index) button (108)

10 For shooting: AEL (AE lock) button (68, 86)

For viewing/manual focus check Live View mode:  (Zoom in) button (77, 107)

11 For shooting: Fn (Function) button (45, 46)  
For viewing:  (Image rotation) button (107)



12 Access lamp (23)

13 Controller () (44)

14 Controller (Enter) (44)/AF button (75)

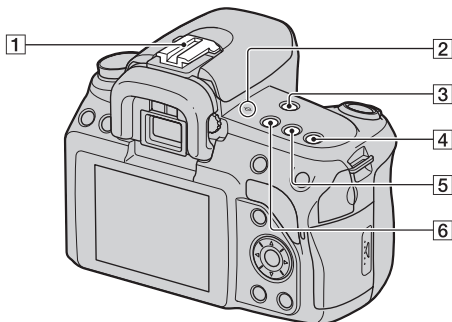
\* **Do not directly touch these parts.**



- 1 Accessory shoe (85)
- 2  Image sensor position mark (73)
- 3 MF CHECK LIVE VIEW (Manual focus check Live View) button (77)
- 4 ISO button (96)
- 5  (Drive) button (101)
- 6 D-RANGE (Dynamic range) button (91)

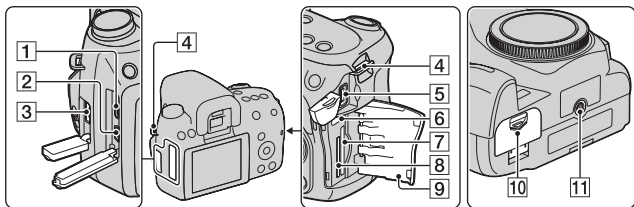

- 1** HDMI terminal (117)
- 2**  (USB) terminal (132, 145)
- 3** REMOTE terminal
- When connecting the RM-S1AM/RM-L1AM Remote Commander (sold separately) to the camera, insert the plug of the Remote Commander in the REMOTE terminal, aligning the guide of the plug on the guide of the REMOTE terminal.
- 4** Hooks for shoulder strap (27)
- 5** DC IN terminal
- When connecting the AC-PW10AM AC Adaptor (sold separately) to the camera, turn the camera off, then plug the connector of the AC Adaptor to the DC IN terminal on the camera.
- 6** Memory card switch
- 7** SD memory card insertion slot (22)
- 8** “Memory Stick PRO Duo” media insertion slot (22)
- 9** Memory card cover
- 10** Battery cover (17)
- 11** Tripod receptacle
- Use a tripod with a screw length of less than 5.5 mm (7/32 inch). You will be unable to firmly secure the camera to tripods having screws longer than 5.5 mm (7/32 inch), and may damage the camera.

## Switching the recording information display (DISP)

Press the DISP button to switch between the Graphic Display and the Standard Display.

When you rotate the camera to a vertical position, the display automatically rotates to adjust to the camera position.

For details on the screen status in the manual focus check Live View mode, see page 79.

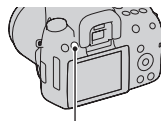

DISP button

### Graphic Display (Default setting)

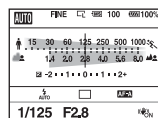

### Standard Display

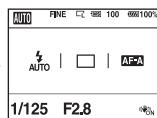



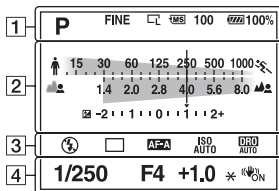

No display

## LCD monitor (Graphic Display)



The Graphic Display graphically shows the shutter speed and aperture value and clearly illustrates how the exposure works. In AUTO or Scene Selection mode, some items may not be displayed. See the pages in parentheses for details of operation.





1





Display	Indication
<b>AUTO P A S M</b> 	Mode dial (51 – 70)
<b>RAW</b> <b>RAW+J</b> <b>FINE STD</b>	Image quality (120)
	Image size (120)/Aspect ratio (120)
	Memory card (22)
<b>100</b>	Remaining number of recordable images (29)
	Remaining battery (18)

2

Display	Indication
	Shutter speed indicator (64)
	Aperture indicator (62)

Display	Indication
	Exposure compensation (87)/Metered Manual (67)
	EV scale (67, 104)

3

Display	Indication
	Flash mode (82)/Red-eye reduction (84)
	Drive mode (101)
	Focus mode (74)
	ISO sensitivity (96)
	D-Range Optimizer (91)/Auto HDR (92)

Display	Indication
<b>1/250</b>	Shutter speed (64)
<b>F4</b>	Aperture (62)
<b>+1.0</b>	Exposure compensation (87)
<b>*</b>	AE lock (86)
	SteadyShot (49)



## LCD monitor (Standard Display)

See pages in parentheses for details of operation.

### In AUTO or Scene Selection mode

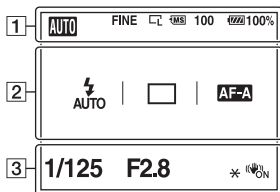

### In P/A/S/M mode

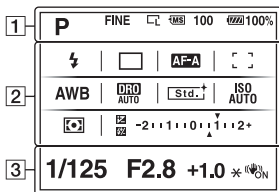

1

Display	Indication
<b>AUTO P A S M</b> 	Mode dial (51 – 70)
<b>RAW</b> <b>RAW+J</b> <b>FINE</b> <b>STD</b>	Image quality (120)
	Image size (120)/Aspect ratio (120)
	Memory card (22)
<b>100</b>	Remaining number of recordable images (29)
	Remaining battery (18)

2

Display	Indication
	Flash mode (82)/Red-eye reduction (84)

Display	Indication
	Drive mode (101)
<b>AF-A</b> <b>AF-S</b> <b>AF-C</b> <b>MF</b>	Focus mode (74)
	AF area (75)
<b>AWB</b>	White balance (Auto, Preset, Custom, Color temperature, Color filter) (97)
<b>7500K G9</b>	
<b>D-R</b> OFF <b>DRO</b> AUTO <b>HDR</b> AUTO	D-Range Optimizer (91)/Auto HDR (92)
	Creative Style (94)
	Metering mode (90)
	Exposure compensation (87)/Metered Manual (67)
	Flash compensation (88)
	EV scale (67, 104)
<b>ISO</b> AUTO	ISO sensitivity (96)

3

Display	Indication
<b>1/125</b>	Shutter speed (64)
<b>F2.8</b>	Aperture (62)
<b>+1.0</b>	Exposure (87)
<b>*</b>	AE lock (86)
	SteadyShot (49)

# Viewfinder

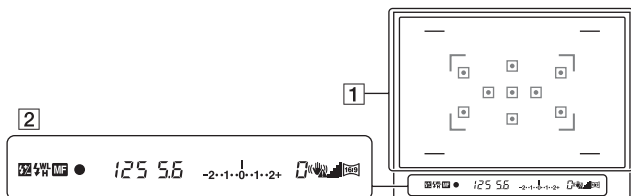

1

Display	Indication
	AF area (75)
	Wide AF area (75)
	Shooting area for aspect ratio 16:9 (120)

2

Display	Indication
	Flash compensation (88)
	Flash charging (82)
<b>WL</b>	Wireless flash (85)
<b>H</b>	High-speed sync*
<b>MF</b>	Manual focus (76)
	Focus
<b>125</b>	Shutter speed (64)
<b>5.6</b>	Aperture (62)
	EV scale (67, 104)
<b>*</b>	AE lock (86)
<b>0</b>	“Shooting unavailable” warning (101)
	Camera shake warning (49)
	SteadyShot scale (49)
	Aspect ratio 16:9 (120)

\* When using the HVL-F58AM/HVL-F42AM Flash (sold separately), you can shoot with the High-speed sync feature at any shutter speed. For details, refer to the operating instructions supplied with the flash.

# Selecting a function/setting

You can select a function for shooting or playback with the one of buttons, such as the Fn (Function) button, or the MENU button.

When you start an operation, an operation guide of controller functions will be displayed at the bottom of the screen.

◀▶: Press ▲/▼/◀/▶ on the controller to move the cursor.

●: Press the center button to execute the selection.

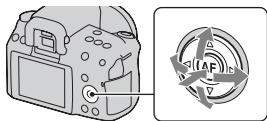







In this Instruction Manual, the process of selecting a function with the controller from the list displayed on the screen is described as follows (we explain the process with the default icons.):

**Example: Fn button → AWB (White balance) → Select the desired setting**

## The operation guide list

The operation guide also indicates operations other than the controller operation. The indications of icons are as follows.

	MENU button
	Returns with MENU button
	🗑️ (Delete) button
	⊕ (Zoom in) button
	⊖ (Zoom out) button
	▶ (Playback) button
	Control dial

## Selecting a function with the Fn (Function) button

This button is used for setting up or executing functions used frequently in shooting.

### 1 Press the Fn button.

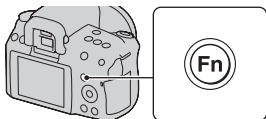

### 2 Select the desired item with ▲/▼/◀/▶ on the controller, then press the center ● to execute.

The setup screen appears.

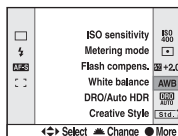

### 3 Following the operation guide, select and execute the desired function.

- For details on how to set up each item, see the corresponding page.

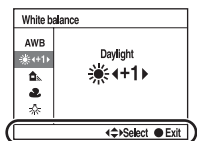

Operation guide

## To set up the camera directly from the recording information screen

Turn the control dial without pressing the center ● in step 2. You can set up the camera directly from the recording information screen.

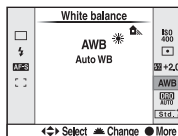



## The functions selected by the Fn (Function) button

Drive mode (101)	Metering mode (90)
Flash mode (82)	Flash compens. (88)
Autofocus mode (74)	White balance (97)
AF area (75)	DRO/Auto HDR (91)
ISO sensitivity (96)	Creative Style (94)

## The functions selected by the MENU button

You can set up the basic settings for the camera as a whole or execute functions such as shooting, playback, or other operations.

### Recording menu

 1	Image size (120) Aspect ratio (120) Quality (120) Flash control (89) AF illuminator (84) SteadyShot (49) Color Space (95)	 2	Long exp.NR (124) High ISO NR (124)
--	---	---	--



### Custom menu

 1	Eye-Start AF (73) AEL button (86) Red eye reduc. (84) Auto review (127) Auto off w/ VF (127) Grid Line (127)
--	---

### Playback menu

 1	Delete (115) Format (123) Slide show (109) Protect (114) Specify Printing (143) PlaybackDisplay (106)
--	--

## Setup menu

 <b>1</b>	LCD brightness (127) Date/Time setup (25) Power Save (LV) (126) Power Save (OVF) (126) CTRL FOR HDMI (119)  Language (126) Help Guide disp. (126)
--	--

 <b>2</b>	File number (122) Folder name (122) Select folder (123) New folder (123) USB connection (132, 145) Audio signals (126)
--	---

 <b>3</b>	Cleaning mode (32) Version (128) Reset default (129)
--	--

# Shooting an image without camera shake

“Camera shake” refers to unwanted movement of the camera that occurs after the shutter button has been pressed, resulting in a blurred image. To reduce camera shake, follow the instructions below.

## Correct posture

**Stabilize your upper body and take a position that keeps the camera from moving.**

When using the viewfinder



In manual focus check Live View mode (page 77)

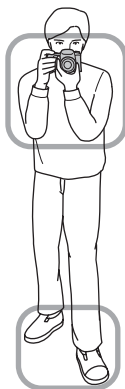

### Point ①

One hand holds the grip of the camera, and the other hand supports the lens.

### Point ②

Take a secure stance with your feet shoulder-width apart.



### Point ③

Lightly tuck your elbows against your body.

When shooting in a kneeling position, steady your upper body by placing your elbow on your knee.

### Camera shake warning indicator

Due to potential camera shake, the  (Camera shake warning) indicator flashes in the viewfinder. In this case, use a tripod or the flash.

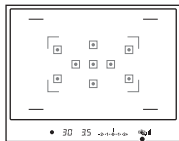

 (Camera shake warning) indicator

### Note

- The  (Camera shake warning) indicator is displayed only in the modes that automatically set the shutter speed. This indicator is not displayed in M/S modes.

## Using the SteadyShot function

The SteadyShot function is set to [On] in the default setting.

### The SteadyShot scale indicator

The  (SteadyShot scale) indicator shows the camera shake status. Wait until the scale becomes low, then start shooting.

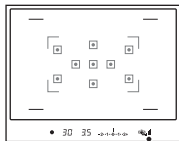

 (SteadyShot scale) indicator

### To deactivate the SteadyShot function

**MENU button** →  **1** → [SteadyShot] → [Off]

**Note**

- The SteadyShot function may not work optimally when the power has just been turned on or when the shutter button has been pressed all the way down without stopping halfway.

## Using a tripod

In the following cases, we recommend that you mount the camera on a tripod.

- Shooting without a flash under dark conditions.
- Shooting with slow shutter speeds, which are typically used in night-time shooting.
- Shooting a close subject, such as in macro shooting.
- Shooting with a telescopic lens.

**Note**

- When using a tripod, deactivate the SteadyShot function because there is a potential for malfunction of the SteadyShot function.

# **AUTO** / Shooting with the automatic setting

The “AUTO” mode allows you to easily shoot any subject under any conditions because the camera makes appropriate judgments on the situation to adjust the settings.

Select  when shooting in a location where the use of a flash is restricted. When you turn the mode dial, the explanation of the selected mode and methods of shooting are displayed on the screen (Help Guide disp.). You can clear the Help Guide (page 126).

- 1 Set the mode dial to **AUTO** or  (Flash Off).**

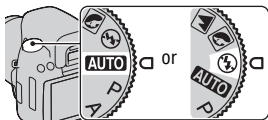

- 2 Hold the camera and look into the viewfinder.**

The subject overlaid onto the focus area comes into focus automatically (Eye-Start AF, page 73).

- 3 Overlay the AF area on the desired subject.**

- If the  (Camera shake warning) indicator flashes, carefully shoot the subject, holding the camera steady, or by using a tripod.

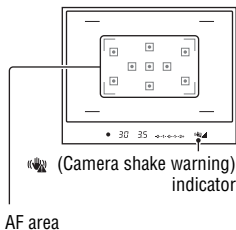

- 4 When using a zoom lens, turn the zoom ring, then decide on your shot.**

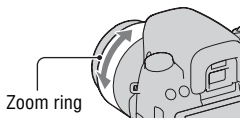

---

## 5 Press the shutter button halfway down to focus.

When the focus is confirmed, ● or (●) (Focus indicator) lights up (page 72).

- Waiting until the  (SteadyShot scale) indicator is low makes the SteadyShot function more effective.

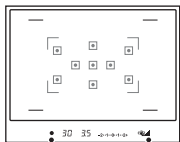
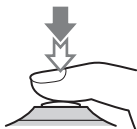

Focus indicator

 (SteadyShot scale) indicator

---

## 6 Press the shutter button fully down to shoot.

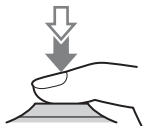

---

### Note

- Since the camera turns on the automatic setting function, many features will be unavailable, such as exposure compensation, ISO setting. If you want to adjust various settings, set the mode dial to P, then shoot your subject.

# Shooting with a suitable setting for the subject (Scene Selection)

Selecting an appropriate mode for the subject or the shooting conditions allows you to shoot the image with a suitable setting for the subject. When you turn the mode dial, the explanation of the selected mode and methods of shooting are displayed on the screen (Help Guide disp.).

## Notes

- Since the camera judges the settings automatically, many features will be unavailable, such as exposure compensation, ISO setting.
- The flash is set to  $\frac{f}{\text{AUTO}}$  (Autoflash) or  $\text{Ⓞ}$  (Flash Off) for each Scene Selection mode. You can change these settings (page 82).



## Taking portrait photos

### This mode is suitable for

- Blurring away backgrounds and sharpening the subject.
- Expressing skin tones softly.



Set the mode dial to  (Portrait).

### Shooting techniques

- To blur the background more, set the lens to the telephoto position.
- You can shoot a vivid image by focusing on the eye that is closer to the lens.
- Use the lens hood (sold separately) to shoot backlit subjects.
- Use the red-eye reduction function if the eyes of your subject turn red from the flash (page 84).



## Taking landscape photos

### This mode is suitable for

- Shooting the entire range of scenery in sharp focus with vivid colors.



Set the mode dial to  (Landscape).

### Shooting technique

- To accentuate the openness of the scenery, set the lens to wide angle.



## Taking small-subject photos

### This mode is suitable for

- Shooting close subjects such as flowers, insects, dishes, or small goods.



Set the mode dial to  (Macro).

### Shooting techniques

- Get close to the subject and shoot at the minimum distance of the lens.
- You can shoot a closer subject using a macro lens (sold separately).
- Set the flash mode to  (Flash Off) when you shoot a subject within 1 m (3.3 feet).
- When shooting in macro mode, the SteadyShot function will not be fully effective. Use a tripod to achieve better results.





## Taking moving-subject photos

### This mode is suitable for

- Shooting moving subjects outdoors or in bright places.



Set the mode dial to  (Sports Action).

### Shooting techniques

- The camera shoots images continuously while the shutter button is pressed.
- Press and hold the shutter button halfway down until the right moment.



## Taking sunset photos

### This mode is suitable for

- Shooting the red of the sunset beautifully.



Set the mode dial to  (Sunset).

### Shooting technique

- Used to shoot an image accentuating the red color compared with other modes. This is also suitable for shooting the beautiful red of the sunrise.



## Taking night view photos

### This mode is suitable for

- Shooting portraits in night scenes.
- Shooting night scenes at a distance without losing the dark atmosphere of the surroundings.



### Set the mode dial to (Night Port./View).

Set the flash mode to  (Flash Off) when you shoot a night view without persons (page 82).

### Shooting techniques

- Take care that the subject does not move to prevent the image from blurring.
- The shutter speed is slower, so using a tripod is recommended.

### Note

- The picture may not be taken properly when shooting a wholly dark night scene.

# Shooting an image the way you want it (Exposure mode)

With a single lens reflex camera, you can adjust the shutter speed (how long the shutter is open) and aperture (the range that is in focus: depth of field) to enjoy a variety of photographic expressions.

Adjusting the shutter speed and aperture not only creates the photographic effects of movement and focus, but also determines the brightness of the image by controlling the amount of exposure (the amount of light the camera takes in), which is the most important factor in photo shooting.

## Changing the brightness of the picture by the amount of exposure



Amount of  
exposure

low



high

When using a faster shutter speed, the camera opens the shutter for a shorter time. This means less time for the camera to take in light, resulting in a darker picture. To take a brighter picture, you can open the aperture (the hole through which the light passes) to some extent in order to adjust the amount of light the camera takes in at one time.

The brightness of the picture adjusted by the shutter speed and aperture is called “exposure.”

This section will show you how to adjust the exposure and enjoy various photo expressions by the use of movement, focus, and light.

When you turn the mode dial, the explanation of the selected mode and methods of shooting are displayed on the screen (Help Guide disp.). You can clear the Help Guide (page 126).

## P Shooting with program auto

### This mode is suitable for

- Using the automatic exposure, while keeping the custom settings for ISO sensitivity, Creative Style, D-Range optimizer, etc.



---

**1 Set the mode dial to P.**

---

**2 Set the shooting functions to your desired settings (pages 71 to 105).**

- To fire the flash, press the  button.

---

**3 Adjust the focus and shoot the subject.**

---

## A Shooting by controlling the blur of the background (Aperture priority)

### This mode is suitable for

- Putting the subject in sharp focus and blur everything in front of and beyond the subject. Opening the aperture narrows the range that is in focus. (Depth of field becomes shallower.)
- Shooting the depth of the scenery. Narrowing down the aperture widens the range that is in focus. (Depth of field becomes deeper.)



---

### 1 Set the mode dial to A.

## 2 Select the aperture value (F-number) with the control dial.

- Smaller F-number: The foreground and background of the subject are blurred.  
Larger F-number: The subject and its foreground and background are all in focus.
- You cannot check the blurring of an image in the viewfinder. Check the recorded image and adjust the aperture.

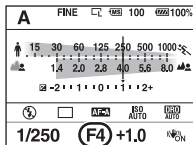
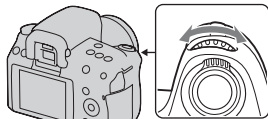

Aperture (F-number)

## 3 Adjust the focus and shoot the subject.

The shutter speed is automatically adjusted to obtain correct exposure.

- When the camera judges that the proper exposure is not obtained with the selected aperture value, the shutter speed flashes. In such cases, adjust the aperture again.

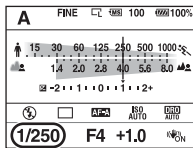

Shutter speed

### Shooting techniques

- The shutter speed may become slower depending on the aperture value. When the shutter speed is slower, use a tripod.
- To blur the background more, use a telephoto lens or a lens that is equipped with a smaller aperture value (bright lens).

### Note

- Press the  button when you shoot with the flash. However, the flash range differs according to the aperture value. When you shoot with the flash, check the flash range (page 84).

## S Shooting a moving subject with various expressions (Shutter speed priority)

### This mode is suitable for

- Shooting a moving subject at a moment in time. Use a faster shutter speed to crisply shoot an instant of the movement.
- Tracing the movement to express the dynamism and flow. Use a slower shutter speed to shoot a trailing image of the moving subject.



---

### 1 Set the mode dial to S.



## 2 Select the shutter speed with the control dial.

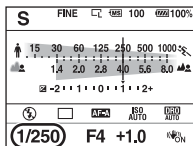
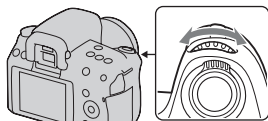

Shutter speed

## 3 Adjust the focus and shoot the subject.

The aperture is automatically adjusted to obtain correct exposure.

- When the camera judges that the proper exposure is not obtained with the selected shutter speed, the aperture value flashes. In such cases, adjust the shutter speed again.

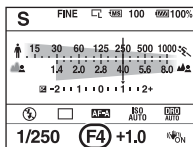



Aperture (F-number)

### Shooting techniques

- When the shutter speed is slower, use a tripod.
- When shooting an indoor sport, select a higher ISO sensitivity.

### Notes

- The  (Camera shake warning) indicator is not indicated in shutter speed priority mode.
- The higher the ISO sensitivity, the more conspicuous the noise.
- When the shutter speed is one second or more, noise reduction (Long exp.NR) will be done after shooting. You cannot do any further shooting during the reduction.
- Press the  button when you shoot with the flash. However, when using the flash, if you close the aperture (a larger F-number) by making the shutter speed slower, the light of the flash will not reach distant subjects.

## M Shooting with the exposure adjusted manually (Manual exposure)

### This mode is suitable for

- Shooting with the desired exposure setting by adjusting both the shutter speed and aperture.



### 1 Set the mode dial to M.

- ### 2 Rotate the control dial to adjust the shutter speed, and while pressing the button, rotate the control dial to adjust the aperture.

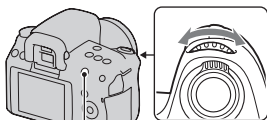

 button

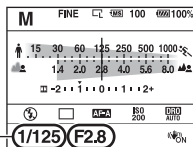

Aperture (F-number)

Shutter speed

### 3 Shoot the image after the exposure is set.

- Check the exposure value on the EV scale (Metered Manual).

Toward +: Images become brighter.

Toward -: Images become darker.

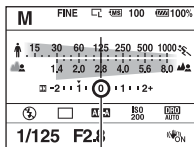

: Metered Manual

When the camera is in M mode, it will show an under or over compensation value based on the correct exposure using the index on the exposure compensation indicator.



Standard value

#### Notes

- The  (Camera shake warning) indicator is not indicated in manual exposure mode.
- When the mode dial is set to M, the ISO setting [AUTO] is set to [200]. In M mode, the ISO setting [AUTO] is not available. Set the ISO sensitivity as necessary (page 96).
- Press the  button when you shoot with the flash. However, the flash range differs according to the aperture value. When you shoot with the flash, check the flash range (page 84).

#### The EV scale in M mode

The  arrow appears if the set exposure is beyond the range of the EV scale. The arrow starts flashing if the difference becomes greater.

LCD monitor (Standard Display)



Standard value

Viewfinder

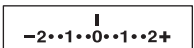

Standard value

## Manual shift

You can change the shutter speed and aperture value combination without changing the exposure you set.

Rotate the control dial while pressing the AEL button to select the shutter speed and aperture value combination.

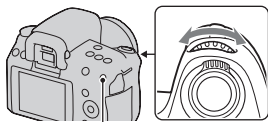

AEL button

## M Shooting trails with long exposure (BULB)

**This mode is suitable for**

- Shooting trails of light, such as fireworks.
- Shooting trails of stars.



**1** Set the mode dial to M.

**2** Rotate the control dial to the left until [BULB] is indicated.

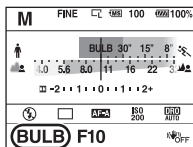
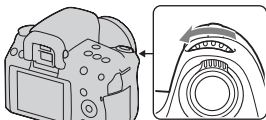

BULB

**3** While pressing the  button, rotate the control dial to adjust the aperture (F-number).

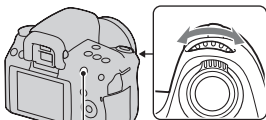

 button

---

## 4 Press the shutter button halfway down to adjust the focus.

---

## 5 Press and hold the shutter button for the duration of the shooting.

As long as the shutter button is pressed, the shutter remains open.

---

### Shooting techniques

- Use a tripod.
- Set the focus to infinity in manual focus mode when shooting fireworks, etc.
- Use the Wireless Remote Commander (sold separately) (page 105). Pressing the SHUTTER button on the Wireless Remote Commander triggers BULB shooting and pressing it again stops BULB shooting. You do not need to press and hold the SHUTTER button on the Wireless Remote Commander.
- If you use a Remote Commander that is equipped with a shutter button lock function (sold separately), you can leave the shutter open using the Remote Commander.

### Notes

- When using a tripod, turn off the SteadyShot function (page 49).
- The longer the exposure time, the more conspicuous the noise on the image.
- After shooting, noise reduction (Long exp.NR) will be done for the same amount of time that the shutter was open. You cannot do any further shooting during the reduction.
- When the Auto HDR function is activated, you cannot set the shutter speed to [BULB].
- If the Auto HDR function is used with the shutter speed set to [BULB], the shutter speed is temporarily set to 30 seconds.

# Selecting the focus method

There are two methods for adjusting the focus: autofocus and manual focus. Depending on the lens, the method for switching between the auto focus and manual focus is different.

The type of lens	The switch to be used	To switch to auto focus	To switch to manual focus
The lens is equipped with a focus mode switch	Lens (Always set the focus mode switch on the camera to AF.)	Set the focus mode switch on the lens to AF.	Set the focus mode switch on the lens to MF.
The lens is not equipped with a focus mode switch	Camera	Set the focus mode switch on the camera to AF.	Set the focus mode switch on the camera to MF.

## Using autofocus

- 1 Set the focus mode switch on the camera to AF.**

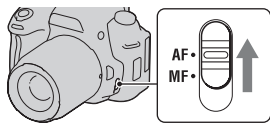

- 2 When the lens is equipped with the focus mode switch, set it to AF.**

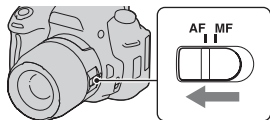

- 3 Look into the viewfinder.**

The subject overlaid onto the focus area comes into focus automatically (Eye-Start AF, page 73).

#### 4 Press the shutter button halfway down to check the focus and shoot the image.

- When the focus is confirmed, the focus indicator changes to ● or (●) (below).
- The sensor used for focusing in the AF area illuminated in red (page 75).

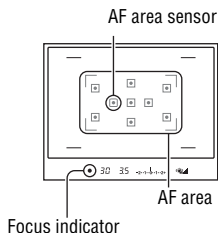

#### Shooting technique

- To select the AF area used for focusing, set up [AF area] (page 75).

#### Focus indicator

Focus indicator	Status
● lit	Focus locked. Ready to shoot.
(●) lit	Focus is confirmed. Focal point moves following a moving subject. Ready to shoot.
(C) lit	Still focusing. You cannot release the shutter.
● flashing	Cannot focus. The shutter is locked.

#### Subjects that may require special focusing

Using the autofocus, it is hard to focus on the following subjects. In such cases, use the focus lock shooting feature (page 73) or manual focus (page 76).

- A subject that is low in contrast, such as blue sky or a white wall.
- Two subjects at different distances overlapping in the AF area.
- A subject that is composed of repeating patterns, such as the facade of a building.
- A subject that is very bright or glittering, such as the sun, the body of an automobile, or the surface of water.
- Ambient light is not sufficient.



## To measure the exact distance to the subject

The  $\ominus$  mark located on the top of the camera shows the location of the image sensor\*. When you measure the exact distance between the camera and the subject, refer to the position of the horizontal line.

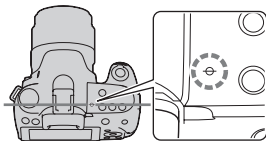

\* The image sensor is the part of the camera that acts as the film.

### Note

- If the subject is closer than the minimum shooting distance of the attached lens, the focus cannot be confirmed. Make sure you put enough distance between the subject and the camera.

## To deactivate the Eye-Start AF function

**MENU button** → **⚙ 1** → **[Eye-Start AF]** → **[Off]**

- When using the camera with the FDA-M1AM Magnifier (sold separately), the FDA-A1AM Angle Finder (sold separately), or the FDA-ME1AM Magnifying Eyepiece (sold separately) attached, turn off both [Eye-Start AF] and [Auto off w/ VF] because these accessories cover the eyepiece sensors located above the viewfinder.

## Shooting with your desired composition (Focus-lock)

- 1 Place the subject within the AF area and press the shutter button halfway down.**

The focus and exposure are fixed.



**2** Keep the shutter button halfway down, and put the subject back in the original position to re-compose the shot.



**3** Press the shutter button fully down to take the picture.

Selecting the focus method to suit the movement of the subject (Autofocus mode)







**Fn button** → **AF-A** (Autofocus mode) → **Select the desired setting**

<b>AF-S</b> (Single-shot AF)	The camera focuses and the focus is locked when you press the shutter button halfway down.
<b>AF-A</b> (Automatic AF)	The [Autofocus mode] is switched between Single-shot AF and Continuous AF according to the movement of the subject. When you press and hold the shutter button halfway down, if the subject is motionless, the focus is locked and if the subject is in motion, the camera continues to focus.
<b>AF-C</b> (Continuous AF)	The camera continues to focus while the shutter button is pressed and held halfway down. <ul style="list-style-type: none"><li>• The audio signals will not sound when the subject is in focus.</li><li>• Focus-lock cannot be used.</li></ul>

### Shooting techniques

- Use **AF-S** (Single-shot AF) when the subject is motionless.
- Use **AF-C** (Continuous AF) when the subject is in motion.

## Note



- **AF-A** (Automatic AF) is selected when the exposure mode is set to AUTO or one of the following Scene Selection modes:  (Portrait),  (Landscape),  (Sunset), or  (Night Port./View).
- **AF-S** (Single-shot AF) is selected when the exposure mode is set to  (Macro) in Scene Selection.
- **AF-C** (Continuous AF) is selected when the exposure mode is set to  (Sports Action) in Scene Selection.

## Selecting the focus area (AF area)

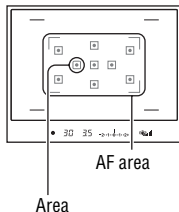
Select the desired AF area to suit the shooting conditions or your preference. The AF area used for focusing is illuminated briefly.



### **Fn button** → (AF area) → **Select the desired setting**

 (Wide)	The camera determines which of the nine AF areas is used in focusing.
 (Spot)	The camera uses the AF area located in the center area exclusively.
 (Local)	Choose the area for which you want to activate the focus from among nine AF areas with the controller. To select the AF areas located in the center area, press the AF button.

## Notes

- When the exposure mode is set to AUTO or Scene Selection,  (Wide) and you cannot select the other settings.
- The AF area may not be illuminated during continuous shooting or when the shutter button is pressed all the way down without pause.

## Adjusting the focus manually (Manual focus)

When it is difficult to get the proper focus in autofocus mode, you can adjust the focus manually.

- 1 Set the focus mode switch on the lens to MF.**

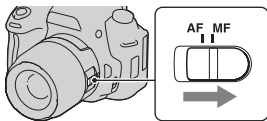

- 2 When the lens is not equipped with the focus mode switch, set the focus mode switch on the camera to MF.**

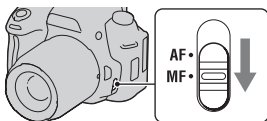

- 3 Rotate the focusing ring of the lens to achieve a sharp focus.**

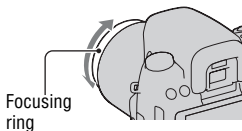

### Notes

- In the case of a subject that can be focused in autofocus mode, the ● indicator lights up in the viewfinder when the focus is confirmed. When the Wide AF area is used, the center area is used, and when the Local AF area is used, the area that is selected with the controller is used.
- When using a tele converter (sold separately), etc., rotation of the focusing ring may not be smooth.
- The correct focus in the viewfinder is not achieved if the diopter is not adjusted properly (page 26).

# Shooting with the manual focus check Live View

You can check the focus by enlarging the image on the LCD monitor before shooting using the image sensor used for recording.

## 1 Press the MF CHECK LIVE VIEW button.

The mirror slides up and the image is displayed on the LCD monitor in the 100-percent frame coverage.

- The indication of the shutter speed and aperture are fixed when the manual focus check Live View starts. The camera meters the light again right before shooting and the exposure is set.
- The image is displayed with the proper brightness regardless of the determined exposure. The exposure compensation is not reflected in the displayed image, however, it is reflected in the recorded image.

MF CHECK LIVE VIEW button

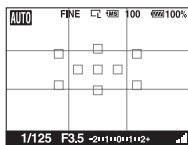
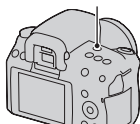

LCD monitor display

## 2 Press the $\oplus$ button to enlarge the image and select the portion you want to enlarge with $\blacktriangle$ / $\blacktriangledown$ / $\blacktriangleleft$ / $\blacktriangleright$ on the controller.

- Each time you press the  $\oplus$  button, the zoom scaling changes as follows: Full display  $\rightarrow$  Approx.  $\times 7$   $\rightarrow$  Approx.  $\times 14$

$\oplus$  button

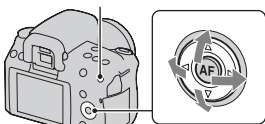

---

### 3 Confirm and adjust the focus.

- You can adjust the focus manually in manual focus check Live View mode.
- If you press the AF button in autofocus mode, the autofocus is activated. The mirror slides down in autofocus mode and the display is interrupted.
- When [AF area] is set to  (Local), the autofocus can also be activated using the controller.

---

### 4 Press the shutter button fully down to shoot the image.

- You can record images when the zoom scaling is set to approx.  $\times 7$  or  $\times 14$ , however the recorded image is for full display.
  - The manual focus check Live View function will be released after shooting.
- 

#### Shooting techniques

- If you press the MF CHECK LIVE VIEW button when the camera is in AE lock mode, you can check a version of the image that reflects the compensated exposure. When you start shooting from this point, the camera starts exposure at the AE lock state.
- You can remove a grid line (page 127).

#### Notes

- The camera does not focus on a subject when you press the shutter button halfway down.
- The image in the viewfinder is not visible in manual focus check Live View mode.
- When  is indicated, the temperature of the camera is increasing. If you intend to continue to perform the manual focus check Live View, you cannot use the camera until the temperature decreases (page 161).
- It is recommend that you attach the eyepiece cover (page 28).
- When you perform continuous or exposure bracket shooting in manual focus check Live View mode, the autofocus is set at the first shot.



## LCD monitor

The status of the screen in manual focus check Live View mode is as follows.

### Recording information display

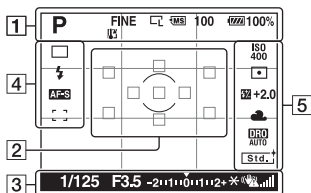

1

Display	Indication
<b>AUTO P A S M</b> [P] [M] [S]	Mode dial (51 – 70)
<b>RAW</b> <b>RAW+J</b> <b>FINE</b> <b>STD</b>	Image quality (120)
[H]	Overheating warning (161)
[L] [M] [S] [L] [M] [S]	Image size (120)/Aspect ratio (120)
[MS] [SD]	Memory card (22)
<b>100</b>	Remaining number of recordable images (29)
[100%]	Remaining battery (18)

2

Display	Indication
[C]	Spot metering area (90)
[••••]	AF area (75)

3

Display	Indication
<b>1/125</b>	Shutter speed (64)
<b>F3.5</b>	Aperture (62)
-2 +1 0 +1 +2	EV scale (67, 104)
*	AE lock (77)
[Hand icon]	Camera shake warning (49)
[Bar graph]	SteadyShot scale (49)







4

Display	Indication
[Hi] [C] [0.3ev]	Drive mode (101)
[AUTO] [SLOW]	Flash mode (82)/Red-eye reduction (84)
[AF-A] [AF-S] [AF-C] [MF]	Focus mode (74)



Display	Indication
	AF area (75)

5

Display	Indication
ISO 400	ISO sensitivity (96)
	Metering (90)
 <b>+2.0</b>	Flash compensation (88)
<b>AWB</b>  WB  <b>7500K G9</b>	White balance (Auto, Preset, Custom, Color temperature, Color filter) (97)
<b>D-R</b>  <b>HDR</b> 	D-Range Optimizer (91)/ Auto HDR (92)
	Creative Style (94)

# Using the flash

In a dark location, using the flash allows you to shoot the subject brightly, and it also helps to prevent camera shake. When shooting into the sun, you can use the flash to shoot a bright image of the backlit subject.

---

## 1 Fn button → ⚡ (Flash mode) → Select the desired setting

---

## 2 Press the ⚡ button.

The flash pops up.

- In AUTO or Scene Selection mode, the flash automatically pops up if the amount of light is insufficient or the subject is backlit. The built-in flash does not pop up even if you press the ⚡ button.

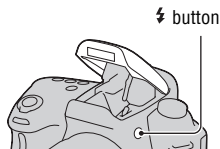

---

## 3 After the flash has finished charging, shoot the subject.





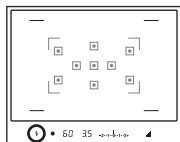

⚡ Flashing: The flash is being charged. When the indicator flashes, you cannot release the shutter.

⚡ Lit: The flash has been charged and is ready to fire.

- When you press the shutter button halfway down under dark lighting in autofocus mode, the flash may be fired to help focus on a subject (AF illuminator).





⚡ (Flash charging) indicator

 <b>(Flash Off)</b>	Does not fire even the built-in flash pops up. This is not selectable when the mode dial is set to P, A, S, or M.
 <b>(Autoflash)</b>	Fires if it is dark or against light. This is not selectable when the mode dial is set to P, A, S, or M.
 <b>(Fill-flash)</b>	Fires every time you trigger the shutter.
 <b>(Slow sync.)</b>	Fires every time you trigger the shutter. Slow sync shooting allows you to shoot a clear image of both the subject and the background by slowing the shutter speed.
 <b>(Rear sync.)</b>	Fires right before the exposure is completed everytime you trigger the shutter.
 <b>(Wireless)</b>	Fires an external flash (sold separately) that is off the camera and away from it (Wireless flash shooting).

### Shooting techniques

- The lens hood (sold separately) may block the light of the flash. Remove the lens hood when using the flash.
- When using the flash, shoot the subject at a distance of 1 m (3.3 feet) or greater.
- When shooting indoors or shooting nightscapes, you can use slow sync to shoot a brighter image of people and backgrounds.
- You can use rear sync to shoot a natural image of the trail of a moving subject such as a moving bicycle or a walking person.

### Notes



- Do not hold the camera by grabbing the flash emitter.
- Shooting conditions required to prevent shadows from appearing on an image vary, depending on the lens.
- When the exposure mode is set to AUTO or Scene Selection, the  (Slow sync.),  (Rear sync.), and  (Wireless) items cannot be selected.

## The flash range

The range of the built-in flash depends on the ISO sensitivity and aperture value. Refer to the following table.

Aperture		F2.8	F4.0	F5.6
ISO setting	200	1 – 6 m (3.3 – 20 feet)	1 – 4.3 m (3.3 – 14 feet)	1 – 3 m (3.3 – 9.8 feet)
	400	1.4 – 8.6 m (4.6 – 28 feet)	1 – 6 m (3.3 – 20 feet)	1 – 4.3 m (3.3 – 14 feet)
	800	2 – 12 m (6.6 – 39 feet)	1.4 – 8.6 m (4.6 – 28 feet)	1 – 6 m (3.3 – 20 feet)

## The AF illuminator

- AF illuminator does not operate when [Autofocus mode] is set to **AF-C** (Continuous AF) or the subject is moving in **AF-A** (Automatic AF). (The  or  indicator lights.)
- The AF illuminator may not operate with focal lengths of 300 mm or longer.
- When an external flash (sold separately) is attached, the AF illuminator of the external flash is used.

## To deactivate the AF illuminator

**MENU button** →  **1** → [AF illuminator] → [Off]

## To use the red-eye reduction

The red-eye reduction reduces the red-eye phenomenon by providing pre-flash (low-flash light) a few times before shooting when using the flash.

**MENU button** →  **1** → [Red eye reduc.] → [On]

## Performing wireless flash shooting

With a flash that has a wireless shooting function (sold separately), you can shoot with the flash without a cord, even when the flash is not attached to the camera. By changing the position of the flash, you can shoot an image with a three dimensional feel by highlighting the contrast of light and shadow on the subject.

For the actual steps of shooting, refer to the operating instructions of the flash.

---

### 1 Attach the wireless flash to the accessory shoe and turn both the camera and the flash on.

---

### 2 Fn button → (Flash mode) → (Wireless)

---

### 3 Remove the wireless flash from the accessory shoe and pop up the built-in flash.

- If you perform a test fire of the flash, press the AEL button.

---

#### Notes

- The camera cannot carry out the wireless lighting ratio control.
- Turn off the wireless flash mode after wireless flash shooting. If the built-in flash is used while the wireless flash mode is still active, inaccurate flash exposures will result.
- Change the channel of the external flash when another photographer is using a wireless flash nearby and his/her built-in flash light causes your external flash to fire. To change the channel of the external flash, refer to the operating instructions supplied with it.

#### Setup of the AEL button

When using a wireless flash, it is recommended that you set [AEL button] to [AEL hold] in the  Custom menu (page 125).

# Adjusting the brightness of the image (Exposure, Flash compensation, Metering)

## Shooting with fixed brightness (AE Lock)

When shooting into the sun or by a window, the exposure may not be appropriate for the subject because of the big difference in lighting between the subject and the background. In such cases, use the light meter where the subject is bright enough and lock the exposure before shooting. To reduce the brightness of the subject, point the camera forwards a spot that is brighter than the subject and use the light meter to lock the exposure of the entire image. To make the subject brighter, point the camera forwards a spot that is darker than the subject and use the light meter to lock the exposure of the entire image.

This section describes how to shoot a brighter image of the subject using the  (Spot).

The spot where you lock the exposure.



---

**1** Fn button →  (Metering mode) →  (Spot)

---

**2** Adjust the focus on the portion you want to lock the exposure.

The exposure is set when the focus is achieved.

### 3 Press the AEL button to lock the exposure.

\* (AE lock mark) appears.

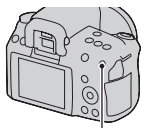

AEL button

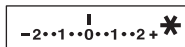

### 4 While pressing the AEL button, focus on the subject, and shoot the subject.

- If you continue to shoot with the same exposure value, press and hold the AEL button after the shooting. The setting is canceled when the button is released.

## Using brightness compensation for the entire image (Exposure compensation)

Except for exposure mode M, the exposure is automatically selected (Automatic exposure).

Based on the exposure acquired by the automatic exposure, you can perform exposure compensation by shifting the exposure to either the + side or the - side, depending on your preference. You can make the entire image brighter by shifting to the + side. The entire image becomes darker when you shift it to the - side.

Adjust in the -  
direction



Base exposure



Adjust in the +  
direction



---

## 1 Press the button to display the exposure compensation screen.

 button



---

## 2 Adjust the exposure with the control dial.

Toward + (over): Brightens an image.

Toward - (under): Darkens an image.

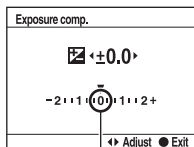

Standard exposure

---

## 3 Adjust the focus and shoot the subject.

---

### Shooting techniques

- Adjust the compensation level by checking the recorded image.
- Using bracket shooting, you can shoot multiple images with the exposure shifted to the plus or minus sides (page 103).

### Note

- This item cannot be set when the exposure mode dial is set to AUTO, M, or Scene Selection.

## Adjusting the amount of flash light (Flash compensation)

When shooting with the flash, you can adjust the amount of flash light alone, without changing the exposure compensation. You can only change the exposure of a main subject which is within the flash range.

### **Fn button** → (Flash compens.) → **Select the desired setting**

Toward +: Makes the flash level higher.

Toward -: Makes the flash level lower.

### Notes

- This item cannot be set when the exposure mode is set to AUTO or Scene Selection.



- If you have adjusted the flash level,  appears in the viewfinder when the built-in flash is pulled up. When you adjust it, be careful not to forget to reset the value.
- The higher flash effect may not be visible due to the limited amount of flash light, if the subject is outside the maximum range of the flash. If the subject is very close, the lower flash effect may not be visible.

### Exposure compensation and flash compensation

Exposure compensation changes the shutter speed, aperture, and ISO sensitivity (when [AUTO] is selected) to perform the compensation. If the flash is used, the amount of flash light is also changed.

However, flash compensation only changes the amount of flash light.

## Selecting the flash control mode to set the amount of flash light (Flash control)

**MENU button** →  **1** → **[Flash control]** → **Select the desired setting**

<b>ADI flash</b>	This method controls the lighting of the flash, factoring in the focus distance information and light metering data from the pre-flash. This method enables an accurate flash compensation with virtually no effect from the reflection off the subject.
<b>Pre-flash TTL</b>	This method controls the amount of flash light depending on the data only from pre-flash light metering. This method is susceptible to the reflection off the subject.

ADI: Advanced Distance Integration

TTL: Through the lens

- When [ADI flash] is selected, using a lens that is provided with a distance encoder feature can perform more accurate flash compensation by using more accurate distance information.



### Notes

- When the distance between the subject and the external flash (sold separately) cannot be determined (wireless flash shooting using an external flash (sold separately), shooting with an off-camera flash using a cable, shooting with a macro twin flash, etc.), the camera automatically selects Pre-flash TTL mode.
- Select [Pre-flash TTL] in the following cases, as the camera cannot perform flash compensations with ADI flash.
  - A wide panel is attached to the HVL-F36AM flash.
  - A diffuser is used for flash shooting.

- A filter with an exposure factor, such as an ND filter, is used.
- A close-up lens is used.
- ADI flash is only available in combination with a lens that is provided with a distance encoder. To determine if the lens is equipped with a distance encoder, refer to the operating instructions supplied with the lens.

## Selecting the method for measuring the brightness of a subject (Metering mode)

**Fn button →  (Metering mode) → Select the desired mode**

 <b>(Multi segment)</b>	This mode measures light on each area after dividing the total area into multiple areas and determines the proper exposure of the entire screen.
 <b>(Center weighted)</b>	While emphasizing the central area of the screen, this mode measures the average brightness of the entire screen.
 <b>(Spot)</b>	This mode measures light at or around the focus area located in the center of the frame.

### Shooting techniques

- Use  (Multi segment) metering for general shooting.
- When there is a high contrast subject in the AF area, measure the light of the subject you want to shoot with the optimal exposure using the spot metering function and take advantage of an AE lock shooting (page 86).

### Note

- When the exposure mode is set to AUTO or Scene Selection, [Metering mode] is fixed to  (Multi segment) and you cannot select other modes.

# Compensating for the brightness and contrast automatically (D-Range)

**D-RANGE button** → Select the desired setting

D-RANGE button

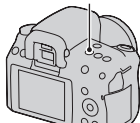

<b>D-R</b> OFF (Off)	Does not use the DRO/Auto HDR functions.
<b>DRO</b> (D-RangeOptimizer)	By dividing the image into small areas, the camera analyses the contrast of light and shadow between the subject and the background, producing the image with the optimal brightness and gradation.
<b>HDR</b> (Auto HDR)	Shoots two images with different exposures, and then overlays the bright area of the under exposed image and the dark area of the over exposed image to create an image with rich gradation.

## Correcting the brightness of the image (D-Range Optimizer)



**1 D-RANGE button** → **DRO** (D-RangeOptimizer)

**2 Select an optimal level with ◀/▶ on the controller.**

<b>DRO</b> AUTO (Auto)	Corrects the brightness automatically.
<b>DRO</b> (Level)*	Optimizes the gradations of a recorded image in each area of the image. Select the optimal level between Lv1 (weak) and Lv5 (strong).

\* Lv\_ displayed with **DRO** is the step currently selected.



## Notes

- The setting is fixed to **OFF** (Off) when  (Sunset) or  (Night Port./View) is selected in Scene Selection. The setting is fixed to **AUTO** (Auto) when other modes are selected in Scene Selection.
- When shooting with the D-Range optimizer, the image may be noisy. Select the proper level by checking the recorded image, especially when you enhance the effect.

## Compensating automatically with rich gradation (Auto High Dynamic Range)

### 1 D-RANGE button → (Auto HDR)

### 2 Select an optimal level with on the controller.

 (Auto Exposure Diff.)	Corrects the exposure difference automatically.
 (Exposure Difference Level)*	Sets the exposure difference, based on the contrast of the subject. Select the optimal level between 1.0Ev (weak) and 3.0Ev (strong).

\* \_Ev displayed with  is the step currently selected.

## Shooting technique

- Since the shutter is released twice for one shot, be careful about the following:
  - Use this function when the subject is motionless or does not blink.
  - Do not recompose.

## Notes

- When the exposure mode is set to AUTO or Scene Selection, you cannot select [Auto HDR].
- You cannot start the next shoot until the capture process is completed after you shoot.
- You may not obtain a desired effect depending on the luminance difference of a subject and the shooting conditions.
- When the flash is used, this function has little effect.
- An image recorded with this function is limited to one overlaid image.







- You cannot use this function on RAW images.
- When the contrast of the scene is low or when camera shake or subject blur is occurred, you may not obtain good HDR images. In such cases, **HDR**  is indicated on the recorded image to inform you of this situation. Shoot again, as necessary, paying attention to the contrast or blur.



# Image processing



Selecting your desired image processing (Creative Style)

**1** Fn button →  (Creative Style) → Select the desired setting



**2** When you want to adjust  (Contrast),  (Saturation), or  (Sharpness), select the desired item with , then adjust the value with /.

 (Standard)	For shooting various scenes with rich gradation and beautiful colors.
 (Vivid)	The saturation and contrast are heightened for shooting striking images of colorful scenes and subjects such as flowers, spring greenery, blue sky, or ocean views.
 (Portrait)	For shooting the skin color in a soft tone, ideally suited to shooting portraits.
 (Landscape)	The saturation, contrast, and sharpness are heightened for shooting vivid and crisp scenery. Distant landscapes also stand out more.
 (Sunset)	For shooting the beautiful red of the setting sun.
 (B/W)	For shooting images in black and white monotone.

 (Contrast),  (Saturation), and  (Sharpness) can be adjusted for each Creative Style item.

 (Contrast)	The higher the value selected, the more the difference of light and shadow is accentuated, thus making an impact on an image.
 (Saturation)	The higher the value selected, the more vivid the color. When a lower value is selected, the color of the image is restrained and subdued.
 (Sharpness)	Adjusts the sharpness. The higher the value selected, the more the contours are accentuated, and the lower the value selected, the more the contours are softened.

## Notes

- When the exposure mode is set to AUTO or Scene Selection, [Creative Style] is fixed to  (Standard) and you cannot select other settings.
- When  (B/W) is selected, you cannot adjust the saturation.

## Changing the range of color reproduction (Color Space)

The way colors are represented with combinations of numbers or the range of color reproduction is called “color space.” You can change the color space, depending on your purpose.

**MENU button** →  **1** → **[Color Space]** → **Select the desired setting**

<b>sRGB</b>	This is the standard color space of the digital camera. Use sRGB in normal shooting, such as when you intend to print out the images without any modification.
<b>AdobeRGB</b>	This has a wide range of color reproduction. When a large part of the subject is vivid green or red, Adobe RGB is effective. <ul style="list-style-type: none"><li>• The file name of the image starts with “_DSC.”</li></ul>

## Notes

- Adobe RGB is for applications or printers that support color management and DCF2.0 option color space. Using some applications or printers that do not support them may result in or print images that do not faithfully reproduce the color.
- When displaying images that were recorded with Adobe RGB on the camera or non-Adobe RGB-compliant devices, the images are displayed with low saturation.

# Setting ISO

Sensitivity to light is expressed by the ISO number (recommended exposure index). The larger the number, the higher the sensitivity.

---

## 1 Press the ISO button to display the ISO screen.

ISO button

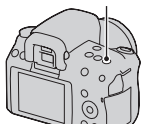

---

## 2 Select the desired value with ▲/▼ on the controller.

- The larger the number, the higher the noise level.

---





### Notes

- When the exposure mode is set to AUTO or Scene Selection, ISO is fixed to AUTO and you cannot select other ISO numbers.
- When the exposure mode is set to P/A/S and ISO is set to [AUTO], ISO is automatically set between ISO 200 and ISO 1600.
- The [AUTO] setting is not provided in exposure mode M. If you change the exposure mode to M with the [AUTO] setting, it is switched to [200]. Set the ISO according to your shooting conditions.



## Adjusting the color tones (White balance)

The color tone of the subject changes depending on the characteristics of the light source. The table below shows how the color tone changes based on various light sources, compared with a subject that appears white under the sunlight.

<b>Weather/ lighting</b>	Daylight 	Cloudy 	Fluorescent 	Incandescent 
<b>Characteristics of light</b>	White	Bluish	Green-tinged	Reddish

White balance is a feature that adjusts the color tone to approximate what you see. Use this feature when the color tone of the image did not come out as you expected, or when you want to change the color tone on purpose for photographic expression.







### Notes

- When the exposure mode is set to AUTO or Scene Selection, [White balance] is fixed to AWB (Auto WB) and you cannot select other modes.
- If the only light source available is a mercury lamp or a sodium lamp, the camera will not be able to acquire the accurate white balance because of the characteristics of the light source. Use the flash in such cases.

### Adjusting the white balance to suit a specific light source (Auto/Preset white balance)

#### **Fn button** → **AWB (White balance)** → **Select the desired setting**

- When [AWB] is not selected, you can fine tune the color tone with ◀/▶ on the controller. Adjusting it toward + turns the image reddish and adjusting it toward – turns the image bluish.

<b>AWB (Auto WB)</b>	The camera automatically detects a light source and adjusts the color tones.
 <b>(Daylight)</b>	If you select an option to suit a specific light source, the color tones are adjusted for the light source (preset white balance).
 <b>(Shade)</b>	
 <b>(Cloudy)</b>	
 <b>(Incandescent)</b>	
 <b>(Fluorescent)</b>	
 <b>(Flash)</b>	

### Shooting techniques

- Use the white balance bracket function if you cannot get the desired color in the selected option (page 104).
- When you select [5500K] (ColorTemperature) or [0] (Color filter), you can adjust the value to the desired value (below).
- When you select  (Custom), you can register your setting (page 99).

### Setting the color temperature and a filter effect (Color Temperature/Color filter)

#### **Fn button → AWB (White balance) → [5500K] (ColorTemperature) or [0] (Color filter)**

- To set the color temperature, select the value with ◀/▶.
- To set the color filter, select the compensation direction with ◀/▶.

#### **Note**

- Since color meters are designed for film cameras, the values differ under fluorescent/sodium lamp/mercury lamps. We recommend that you use the custom white balance or do a test shooting.

<b>5500K*<sup>1</sup></b> <b>(ColorTemperature)</b>	Sets the white balance by the color temperature. The higher the number, the more reddish the image and the lower the number, the more bluish the image.
<b>0*<sup>2</sup></b> <b>(Color filter)</b>	Achieves the effect of CC (Color Compensation) filters for photography. Based on using the set color temperature as the standard, the color can be compensated to G (Green) or M (Magenta).

\*1 The value is the color temperature value currently selected.

\*2 The value is the color filter value currently selected.

## Registering the color tones (Custom white balance)

In a scene where the ambient light consists of multiple types of light source, use of custom white balance is recommended in order to accurately reproduce the whiteness.

**1 Fn button → AWB (White balance) →  (Custom)**

**2 Select [ SET] with ◀/▶ on the controller, then press the center of the controller.**

**3 Hold the camera so that the white area fully covers the AF area located in the center, and then press the shutter button down.**

The shutter clicks and the calibrated values (ColorTemperature and Color filter) are displayed.

**4 Press the center of the controller.**

The monitor returns to the recording information display with the memorized custom white balance setting retained.

- The custom white balance setting registered in this operation is effective until a new setting is registered.

**Note**

- The message “Custom WB error” indicates that the value is beyond the expected range. (When the flash is used on a subject in close proximity or a subject with a bright color is in the frame.) If you register this value, the  indicator turns yellow on the recording information display on the LCD monitor. You can shoot at this point, but it is recommended that you set the white balance again to get a more correct white balance value.

**To call the custom white balance setting**

**Fn button → AWB (White balance) →  (Custom)**

**Note**

- If the flash is used when the shutter button is pressed, a custom white balance is registered with the flash light taken into account. Take pictures with the flash in later shootings.

## / **Selecting the drive mode**

This camera has seven drive modes, such as single-shot advanced, and continuous advanced. Use them to suit your purpose.

### Shooting single shot

This mode is for normal shooting.



 /  **button** →  **(Single-shot adv.)**

#### Note

- When the exposure mode is set to  (Sports Action) in Scene Selection, you cannot shoot single shot.

### Shooting continuously

The camera records the images continuously at the following speeds\*.

 Hi	 Lo
Maximum 5 images per second	Maximum 3 images per second

\* Our measurement conditions. The speed of continuous shooting is slower, depending on shooting conditions.

---

**1**  /  **button** →  **(Continuous adv.)** → **Select the desired speed**

---

**2 Adjust the focus and shoot the subject.**

- When you press and hold the shutter button, the recording continues.
- 

#### The maximum number of continuous shots

The number of continuous shooting images obtainable has an upper limit.

<b>Fine</b>	32 images
<b>Standard</b>	116 images
<b>RAW &amp; JPEG</b>	7 images
<b>RAW</b>	14 images

## To shoot continuously at higher speeds

The camera shoots continuously at a maximum of seven images per second. The exposure and focus are set at the first shot.

 /  **button** →  (**Spd.Prty.Cont.Adv.**)

### Notes

- You cannot shoot images continuously when “0” flashes in the viewfinder. Wait until the indicator disappears.
- You cannot shoot continuously when using Scene Selection modes other than  (Sports Action).

## Using the self-timer

The 10-second self-timer is convenient when the photographer appears in a photo and the 2-second self-timer is convenient to reduce the camera shake.

---

**1**  /  **button** →  (**Self-timer**) → **Select the desired setting**

- The number after  is the number of seconds that is currently selected.

---

## 2 Adjust the focus and shoot the subject.

- When the self-timer is activated, audio signals and the self-timer lamp indicate the condition. The self-timer lamp flashes quickly and the audio signal sounds quickly right before the shooting.

---

## To cancel the self-timer

Press the  /  button.

### Note

- When you press the shutter button without looking into the viewfinder, use the eyepiece cover (page 28).

## Shooting images with the exposure shifted (Exposure bracket)



Bracket shooting allows you to shoot several images, each with different degrees of exposure. Specify the value of deviation (steps) from the base exposure, and the camera shoots three images while automatically shifting the exposure. Press and hold the shutter button until the shooting stops. When the flash is fired, flash bracket shooting is used to shift the amount of flash light. To shoot, press the shutter button shot by shot.

---

**1**  /  button → **BRK C (Bracket: Cont.)** → **Select the desired bracket step**

---

## **2 Adjust the focus and shoot the subject.**







The base exposure is set at the first shot in the bracket.

---

### **Notes**

- When the mode dial is set to M, the exposure is shifted by adjusting the shutter speed.
- When you adjust the exposure, the exposure is shifted based on the compensated value.
- The bracket cannot be used when the exposure mode is set to AUTO or Scene Selection.

## The EV scale in bracket shooting

	Ambient light* bracket 0.3 steps, three shots Exposure compensation 0	Flash bracket 0.7 steps, three shots Flash compensation -1.0
<b>LCD monitor (Standard Display)</b>	 Shown in the top row.	 Shown in the bottom row.
<b>Viewfinder</b>		
<b>LCD monitor (Manual focus check Live View mode)</b>		

\* Ambient light: Any light other than the flash light that shines on the scene for an extended period of time, such as natural light, a light bulb, or a fluorescent light.

- In bracket shooting, the same number of indices as the number of recordable images is displayed on the EV scale. However, in flash bracket shooting, the indices are not displayed in the viewfinder.
- When the bracket shooting starts, the indices that indicate already recorded images start to disappear one by one.

## Shooting with white balance shifted (WB bracket)

Based on the selected white balance, and the color temperature/color filter, three images are recorded with the white balance shifted.

**1**  button → **BRK**WB (WB bracket) → **Select the desired setting**

- When Lo is selected, it is shifted by 10 mired\*, and when Hi is selected, it is shifted by 20 mired.

**2 Adjust the focus and shoot the subject.**

\* Mired: a unit to indicate the color conversion quality in color temperature filters.



## Shooting with the Wireless Remote Commander

You can shoot using the SHUTTER and 2SEC (the shutter is released after 2 seconds) buttons on the RMT-DSLR1 Wireless Remote Commander (sold separately). Also, refer to the operating instructions supplied with the Wireless Remote Commander.

---

**1**  /  button →  (Remote Commander)

---

**2** Focus on the subject, point the transmitter of the Wireless Remote Commander to the remote sensor, and shoot the image.

---

### Note

- When you press the shutter button without looking into the viewfinder, use the eyepiece cover (page 28).

# Playing back images

The last recorded image is displayed on the LCD monitor.

**1** Press the  button.

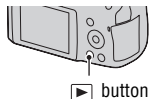

**2** Select an image with  on the controller.

**To return to the shooting mode**

Press the  button again.

**To switch the recording data display**

Press the DISP button.

Each time you press the DISP button, the screen changes as follows.

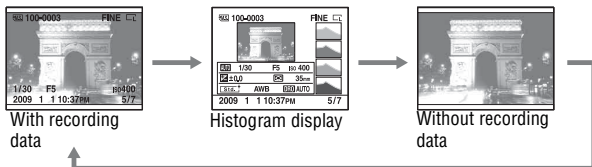

**To select the orientation when playing back an image recorded in the portrait position**

**MENU button** →  **1** → **[PlaybackDisplay]** → **Select the desired setting**

**Note**

- When you play back the image on a TV or a computer, the image will be displayed in the portrait position even if [Manual rotate] is selected.

## Rotating an image

- 1 Display the image you want to rotate, then press the  button.

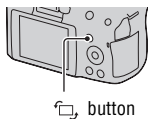

- 2 Press the center of the controller.

The image is rotated counter-clockwise. When you want to do another rotation, repeat step 2.

- Once you rotate the image, the image is played back in the rotated position, even if you turn off the power.

### To return to the normal playback screen

Press the  button.

#### Note

- When you copy rotated images to a computer, “PMB” contained on the CD-ROM (supplied) can display the rotated images correctly. However, the images may not be rotated depending on the software.

## Enlarging images

An image can be enlarged for closer examination. This is convenient to check the focus condition of a recorded image.

- 1 Display the image you want to enlarge, then press the  button.

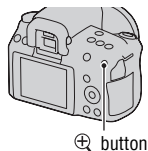

---

## 2 Zoom the image in or out with the button or button.

- Rotating the control dial switches the image at the same display magnification. When you shoot multiple images with the same composition, you can compare their focus conditions.

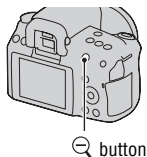

---

## 3 Select the portion you want to enlarge with , , , or on the controller.

### To cancel the enlarged playback

Press the  button so that the image returns to the normal size.

### Scaling range

The scaling range is as follows.

Image size	Scaling range
L	Approx. $\times 1.1$ – $\times 14$
M	Approx. $\times 1.1$ – $\times 11$
S	Approx. $\times 1.1$ – $\times 7.2$

## Switching to the display of the image list

---

### 1 Press the button.

The screen changes to the image index screen.

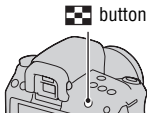

## 2 Press the DISP button repeatedly to select the desired screen format.

- The screen changes in the following order: 9 images → 4 images

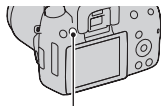

DISP button

### To return to the single-image screen

Press the  button or the center of the controller when you select the desired image.

### To select a folder

- ① Select the folder bar with ◀/▶ on the controller, then press the center.
- ② Select the desired folder with ▲/▼, then press the center.

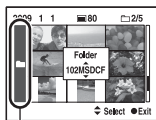

Folder bar

## Playing back images automatically (Slide show)

**MENU button** →  1 → [Slide show] → [OK]

Plays back recorded images in order (Slide show). The slide show automatically stops after all the images have been played back.

- You can view the previous/next image with ◀/▶ on the controller.

### To pause the slide show

Press the center of the controller. Pressing again starts the slide show again.

### To end in the middle of the slide show

Press the MENU button.

### To choose the interval between the images in slide show

**MENU button** →  1 → [Slide show] → [Interval] → Select the desired number of seconds

To play back repeatedly

**MENU button** →  **1** → **[Slide show]** → **[Repeat]** → **[On]**

# Checking the information of recorded images

Each time you press the DISP button, the information display changes (page 106).

## Basic information display

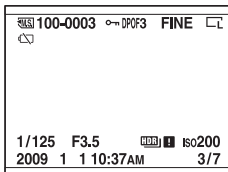

Display	Indication
	Memory card (22)
<b>100-0003</b>	Folder - file number (136)
	Protect (114)
<b>DPOF3</b>	DPOF set (143)
<b>RAW</b> <b>RAW+J</b> <b>FINE</b> <b>STD</b>	Image quality (120)
	Image size (120)/Aspect ratio (120)
	Remaining battery warning (18)
<b>1/125</b>	Shutter speed (64)
<b>F3.5</b>	Aperture (62)
<b>ISO200</b>	ISO sensitivity (96)
<b>2009 1 1</b> <b>10:37AM</b>	Date of recording
<b>3/7</b>	File number/total number of images

Display	Indication
	Auto HDR image warning (92)

## Histogram display

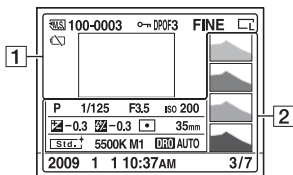

1

Display	Indication
	Memory card (22)
<b>100-0003</b>	Folder - file number (136)
	Protect (114)
<b>DPOF3</b>	DPOF set (143)
<b>RAW RAW+J FINE STD</b>	Image quality (120)
	Image size (120)/Aspect ratio (120)
	Remaining battery warning (18)

2

Display	Indication
	Histogram (113)
<b>AUTO P A S M</b> 	Mode dial (51 – 70)
<b>1/125</b>	Shutter speed (64)
<b>F3.5</b>	Aperture (62)
<b>ISO200</b>	ISO sensitivity (96)
<b>-0.3</b>	Exposure compensation (87)

Display	Indication
<b>-0.3</b>	Flash compensation (88)
	Metering mode (90)
<b>35mm</b>	Focal length (149)
	Creative Style (94)
<b>AWB</b> <b>+1</b> <b>5500K M1</b>	White balance (Auto, Preset, Color temperature, Color filter, Custom) (97)
<b>D-R OFF</b> <b>DRO AUTO</b> <b>HDR AUTO</b> <b>HDR !</b>	D-Range Optimizer (91)/Auto HDR/Auto HDR image warning (92)
<b>2009 1 1</b> <b>10:37AM</b>	Date of recording
<b>3/7</b>	File number/total number of images



## How to check the histogram

The histogram displays the luminance distribution that shows how many pixels of a particular brightness exist in the picture. To display the histogram, press the DISP button (pages 38 and 106).

When the image has a high-key or low-key portion, that portion is flashed on the histogram display (Luminance limit warning).

The exposure compensation will change the histogram accordingly. The right illustration is an example. Shooting with the exposure compensation on the positive side brightens the whole picture, making the entire histogram shift to the bright side (right side). If the exposure compensation is applied on the negative side, the histogram will shift to the other side. Both ends of the histogram show a high-key or low-key portion. It is impossible to restore these area with a computer later. Adjust the exposure if necessary and shoot again.

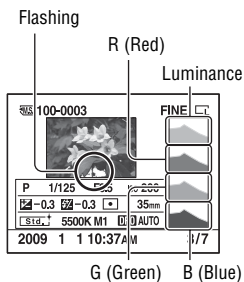
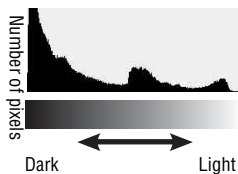

# Protecting images (Protect)

You can protect images against accidental erasure.

Protecting selected images/canceling the protection of the selected images

**1** MENU button →  1 → [Protect] → [Marked images]

**2** Select the image you want to protect with /  on the controller, then press the center of the controller.

A  mark appears on the selected image.

- To cancel a selection, press the center again.

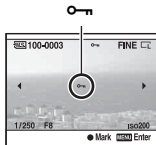

**3** To protect other images, repeat step 2.

**4** Press the MENU button.

**5** Select [OK] with , then press the center of the controller.

# Deleting images (Delete)

Once you have deleted an image, you cannot restore it. Check whether to delete the image or not beforehand.

## Note

- Protected images cannot be deleted.

## Deleting the image that is currently displayed

- 1 Display the image you want to delete and press the  button.

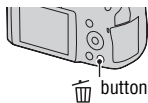

- 2 Select [Delete] with  $\blacktriangle$ , then press the center of the controller.

## Deleting the selected images

- 1 MENU button  $\rightarrow$   1  $\rightarrow$  [Delete]  $\rightarrow$  [Marked images]

- 2 Select the images you want to delete with the controller, then press the center of the controller.

A  mark appears on the selected image.

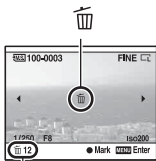

Total number

- 3 To delete other images, repeat step 2.

- 4 Press the MENU button.

- 5 Select [Delete] with  $\blacktriangle$ , then press the center of the controller.

## Deleting all the images in the folder

1 Press the  button.

2 Select the folder bar with  on the controller.

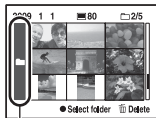

Folder bar

3 Press the center of the controller, then select the folder you want to delete with /.

4 Press the  button.

5 Select [Delete] with , then press the center of the controller.

## Deleting all the images all at once

**MENU button** →  **1** → [Delete] → [All images] → [Delete]

### Note

- It may take a long time to delete a lot of images by selecting [All images]. It is recommended that you delete images on a computer or format the memory card using the camera.

# Viewing images on a TV screen

To view images recorded on the camera on a TV set, an HDMI cable (sold separately) and an HD TV equipped with an HDMI connector are required.

## 1 Turn off both your camera and the TV, and connect the camera to the TV.

① To the HDMI connector

HDMI cable  
(sold separately)

② To the  
HDMI terminal

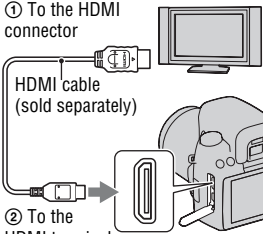

## 2 Turn on the TV and switch the input.

- See also the operating instructions supplied with the TV.

## 3 Turn on the camera.

Images shot with the camera appear on the TV screen.

Select the desired image with ◀▶ on the controller.

- The LCD monitor on the camera does not turn on.

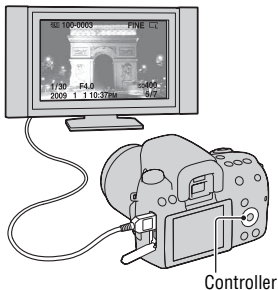

### Notes

- Use an HDMI cable with the HDMI logo.
- Use an HDMI mini connector on one end (for the camera), and a connector suitable for connection to your TV on the other end.

- By connecting your camera to Sony's VIDEO-A compatible TV using an HDMI cable, the TV automatically selects the appropriate image quality for viewing still pictures. Please refer to the operating instructions of Sony's VIDEO-A compatible TV for more details.
- Some devices may not work properly.
- Do not connect the output connector of the device with the HDMI terminal on the camera. This may cause a malfunction.

### **On "PhotoTV HD"**

This camera is compatible with the "PhotoTV HD" standard.

By connecting Sony's PhotoTV HD-compatible devices using an HDMI cable, a whole new world of photos can be enjoyed in breathtaking Full HD quality.

"PhotoTV HD" allows for a highly-detailed, photo-like expression of subtle textures and colors.

### **To use your camera abroad**

The camera automatically detects the color system to match that of the connected video device.

### **On TV color systems**

If you want to view images on a TV screen, you need a TV with a video input jack and the video cable. The color system of the TV must match that of your digital still camera. Check the following lists for the TV color system of the country or region where the camera is used.

#### **NTSC system**

Bahama Islands, Bolivia, Canada, Central America, Chile, Colombia, Ecuador, Jamaica, Japan, Korea, Mexico, Peru, Surinam, Taiwan, the Philippines, the U.S.A., Venezuela, etc.

#### **PAL system**

Australia, Austria, Belgium, China, Czech Republic, Denmark, Finland, Germany, Holland, Hong Kong, Hungary, Italy, Kuwait, Malaysia, New Zealand, Norway, Poland, Portugal, Singapore, Slovak Republic, Spain, Sweden, Switzerland, Thailand, United Kingdom, etc.

#### **PAL-M system**

Brazil

## PAL-N system

Argentina, Paraguay, Uruguay

## SECAM system

Bulgaria, France, Guiana, Iran, Iraq, Monaco, Russia, Ukraine, etc.

## Using “BRAVIA” Sync

By connecting the camera to a TV that supports “BRAVIA” Sync using an HDMI cable, you can operate the camera with the TV Remote Control.

### 1 Connect a TV that supports “BRAVIA” Sync to the camera (page 117).

The input is automatically switched and the image shot with the camera appears on the TV screen.

### 2 Press the LINK MENU button on the TV Remote Control.

### 3 Operate with the control button on the TV Remote Control.

#### The items for Link Menu

<b>Slide show</b>	Plays back images automatically (page 109).
<b>Single-image playback</b>	Returns to the single-image screen.
<b>Image Index</b>	Switches to the image index screen.
<b>Delete</b>	Selects the method for deleting images from single or all images (page 115).

#### Notes

- The operations available are restricted when the camera is connected to a TV using an HDMI cable.
- Only TVs that support “BRAVIA” Sync can provide these operations. For details, refer to the operating instructions supplied with the TV.
- If the camera performs unnecessary operations in response to the TV Remote Control when the camera is connected to another manufacturer’s TV using an HDMI connection, set [CTRL FOR HDMI] in the  Setup menu to [Off].

# Setting image size and image quality

## Image size

**MENU button** →  **1** → **[Image size]** → **Select the desired size**

**[Aspect ratio]: [3:2]**

<b>L:14M</b>	4592 × 3056 pixels
<b>M:7.4M</b>	3344 × 2224 pixels
<b>S:3.5M</b>	2288 × 1520 pixels

**[Aspect ratio]: [16:9]**

<b>L:12M</b>	4592 × 2576 pixels
<b>M:6.3M</b>	3344 × 1872 pixels
<b>S:2.9M</b>	2288 × 1280 pixels

### Note

- When you select a RAW image with [Quality], the image size of the RAW image corresponds to L. This size is not displayed on the LCD monitor.

## Aspect ratio

**MENU button** →  **1** → **[Aspect ratio]** → **Select the desired ratio**

<b>3:2</b>	A normal ratio.
<b>16:9</b>	An HDTV ratio.

## Quality

**MENU button** →  **1** → **[Quality]** → **Select the desired setting**

<b>RAW (RAW)</b>	File format: RAW (Records using the RAW compression format.) This format does not perform any digital processing on the images. Select this format to process images on a computer for professional purposes. <ul style="list-style-type: none"><li>• The image size is fixed to the maximum size. The image size is not displayed on the LCD monitor.</li></ul>
------------------	---



<b>RAW+J (RAW &amp; JPEG)</b>	File format: RAW (Records using the RAW compression format.) + JPEG A RAW image and a JPEG image are created at the same time. This is suitable when you need two image files, a JPEG for viewing, and a RAW for editing. • The image quality is fixed to [Fine] and the image size is fixed to [L].
<b>FINE (Fine)</b>	File format: JPEG
<b>STD (Standard)</b>	The image is compressed in the JPEG format when recorded. Since the compression rate of <b>STD</b> (Standard) is higher than that of <b>FINE</b> (Fine), the file size of <b>STD</b> is smaller than that of <b>FINE</b> . This will allow more files to be recorded on one memory card, but the image quality will be lower.

### Note

- For details on the number of images that can be taken when the image quality is changed, see page 29.

### About RAW images

You need the “Image Data Converter SR” software included on the CD-ROM (supplied) in order to open a RAW image recorded on this camera. With this software, a RAW image can be opened and converted to a common format, such as JPEG or TIFF, and its white balance, color saturation, contrast, etc., can be readjusted.

- The RAW format image cannot be printed using a DPOF (print) designated printer or a PictBridge compliant printer.
- You cannot set [Auto HDR] on RAW format images.

# Setting the method for recording on a memory card

Selecting the method for assigning file numbers to images

**MENU button** →  **2** → **[File number]** → **Select the desired setting**

<b>Series</b>	The camera does not reset numbers and assigns numbers to files in sequence until the number reaches “9999.”
<b>Reset</b>	The camera resets numbers in the following cases and assigns numbers to files from “0001.” When the recording folder contains a file, a number one higher than the largest number is assigned. <ul style="list-style-type: none"><li>– When the folder format is changed.</li><li>– When all the images in the folder are deleted.</li><li>– When the memory card is replaced.</li><li>– When the memory card is formatted.</li></ul>

Selecting the folder name format

The recorded images are stored in automatically-created folders in the DCIM folder of the memory card.

**MENU button** →  **2** → **[Folder name]** → **Select the desired setting**

<b>Standard form</b>	The folder name format is as follows: folder number + MSDCF. Example: 100MSDCF
<b>Date form</b>	The folder name format is as follows: folder number + Y (the last digit)/MM/DD. Example: 10090405 (Folder name: 100, date: 04/05/2009)

## Creating a new folder

You can create a folder in a memory card for recording images. A new folder is created with a number incremented one higher than the largest number currently used, and the folder becomes the current recording folder.

**MENU button** →  **2** → **[New Folder]**

## Selecting the recording folder

When a standard form folder is selected and there are two or more folders, you can select the recording folder to be used to record images.

**MENU button** →  **2** → **[Select folder]** → **Select the desired folder**

### Note

- You cannot select the folder when you select the setting [Date form].

## Formatting the memory card

Note that formatting irrevocably erases all data on a memory card, including protected images.

**MENU button** →  **1** → **[Format]** → **[OK]**

### Notes

- During the format, the access lamp lights up. Do not eject the memory card while the lamp is lit.
- Format the memory card using the camera. If you format it on a computer, the memory card may not be usable with the camera, depending on the format type used.
- Formatting may take several minutes depending on the memory card.

# Changing the noise reduction setting

## Disabling the noise reduction during long exposure shootings

When you set the shutter speed to a second or longer (Long exposure shooting), noise reduction is turned on for the same duration that the shutter is open.

This is to reduce the grainy noise typical in a long exposure. When noise reduction is in progress, a message appears and you cannot take another picture. Select [On] to prioritize the image quality. Select [Off] to prioritize the timing of shooting.

**MENU button** →  **2** → **[Long exp.NR]** → **[Off]**

### Notes

- Noise reduction is not performed on continuous shooting or continuous bracketing images even when it is set to [On].
- When the exposure mode is set to AUTO or Scene Selection, you cannot turn off noise reduction.

## Setting the noise reduction at high ISO sensitivity settings

When shooting with the ISO set at 1600 or above, the camera reduces the noise that becomes more noticeable when the camera sensitivity is high. Select [High] to prioritize the image quality. Select [Normal] to prioritize the timing of shooting.

**MENU button** →  **2** → **[High ISO NR]** → **Select the desired setting**

### Note

- [Normal] is selected automatically for continuous shooting or continuous bracketing images, even when you set it to [High].

# Changing the function of the AEL button

## Changing the operation of the AEL button

The function of the AEL button can be selected from the following two functions:

- Holding the locked exposure value by pressing the AEL button while the button is held down ([AEL hold]).
- Holding the locked exposure value by pressing the AEL button until the button is pressed again ([AEL toggle]).

**MENU button** → **⚙ 1** → **[AEL button]** → **Select the desired setting**

### Notes

- While the exposure value is locked, **\*** appears on the LCD monitor and in the viewfinder. Be careful not to reset the setting.
- The “Hold” and “Toggle” settings affect the manual shift (page 68) in the manual exposure mode.

# Changing other settings

## Setting the sound on/off

Selects the sound produced when the shutter is locked, during self-timer countdown, etc.

**MENU button** →  **2** → **[Audio signals]** → **Select the desired setting**

## Removing the Help Guide from the screen

You can turn off the Help Guide that is displayed when you operate the camera. This is convenient when you want to perform the next operation quickly.

**MENU button** →  **1** → **[Help Guide disp.]** → **[Off]**

## Setting the time to turn the camera to the power save mode

You can set different time intervals for the camera to switch to power save mode (Power save). Pressing the shutter button halfway down returns the camera to the shooting mode.

**MENU button** →  **1** → **[Power Save (OVF)]** → **Select the desired time**

### Notes

- Regardless of the setting here, the camera turns to power save mode after 30 minutes when the camera is connected to a TV or the drive mode is set to  (Remote Commander).
- Set up [Power Save (LV)] when using the manual focus check Live View.

## Selecting the language

**MENU button** →  **1** → **[ Language]** → **Select the language**

# Setting the LCD monitor

Setting the brightness of the LCD monitor manually

**MENU button** →  **1** → **[LCD brightness]** → **Select the desired setting**

Setting the displayed time of the image right after shooting (Auto review)

You can check the recorded image on the LCD monitor right after the shooting. You can change the displayed time.

**MENU button** →  **1** → **[Auto review]** → **Select the desired setting**

## Note

- In auto review, the image will not be displayed in the vertical position even if [PlaybackDisplay] is set to [Auto rotate] (page 106).

Keeping the LCD monitor tuned on while looking into the viewfinder

In the default setting, while looking into the viewfinder, the LCD monitor is turned off to prevent the battery pack from wearing down.

If you want to turn on the LCD monitor while looking into the viewfinder, select [Off].

**MENU button** →  **1** → **[Auto off w/ VF]** → **[Off]**

Turning the grid line on/off

You can select whether the grid line is displayed or not in manual focus check Live View mode (page 77).

**MENU button** →  **1** → **[Grid Line]** → **Select the desired setting**

# Confirming the version of the camera

## Displaying the version

Displays the version of your camera. Confirm the version when a firmware update is released.

**MENU button** →  **3** → **[Version]**

### Note

- An update can be performed only when the battery level is  (three remaining battery icons) or more. We recommend that you use a sufficient battery or the AC-PW10AM AC Adaptor (sold separately).



# Resetting to the default

You can reset the main functions of the camera.

**MENU button** →  **3** → **[Reset default]** → **[OK]**

The items to be reset are as follows.

Items	Reset to
Exposure compensation (87)	±0.0
Recording information display (39)	Graphic Display
Playback display (106)	Single-image screen (with recording information)
Drive mode (101)	Single-shot adv.
Flash mode (82)	Fill-flash (differs based on whether the built-in flash is open or not)
Autofocus mode (74)	AF-A
AF area (75)	Wide
ISO (96)	AUTO
Metering mode (90)	Multi segment
Flash compens. (88)	±0.0
White balance (97)	AWB (Auto white balance)
ColorTemperature/Color filter (98)	5500K, Color filter 0
Custom white balance (99)	5500K
DRO/Auto HDR (91)	DRO Auto
Creative Style (94)	Standard

## Recording menu

Items	Reset to
Image size (120)	L:14M
Aspect ratio (120)	3:2
Quality (120)	Fine
Flash control (89)	ADI flash
AF illuminator (84)	Auto
SteadyShot (49)	On
Color Space (95)	sRGB
Long exp.NR (124)	On

Items	Reset to
High ISO NR (124)	Normal

### Custom menu

Items	Reset to
Eye-Start AF (73)	On
AEL button (125)	AEL hold
Red eye reduc. (84)	Off
Auto review (127)	2 sec
Auto off w/ VF (127)	On
Grid Line (127)	On

### Playback menu

Items	Reset to
Specify Printing – Date imprint (144)	Off
Slide show – Interval (109)	3 sec
Slide show – Repeat (109)	Off
PlaybackDisplay (106)	Auto rotate

### Setup menu

Items	Reset to
LCD brightness (127)	±0
Power Save (LV) (126)	20 sec
Power Save (OVF) (126)	10 sec
CTRL FOR HDMI (119)	On
Help Guide disp. (126)	On
File number (122)	Series
Folder name (122)	Standard form
USB connection (132, 145)	Mass Storage
Audio signals (126)	On

# Using your computer

This section describes how to copy images in a memory card to a computer connected using a USB cable.

## Recommended computer environment

The following environment is recommended for a computer connected to the camera to import images.

### ■ Windows

OS (pre-installed): Microsoft Windows XP\*<sup>1</sup> SP3/Windows Vista\*<sup>2</sup> SP2/Windows 7

- Operation is not assured in an environment based on an upgrade of the operating systems described above or in a multi-boot environment.

\*1 64-bit editions and Starter (Edition) are not supported.

\*2 Starter (Edition) is not supported.

USB jack: Provided as standard

### ■ Macintosh

OS (pre-installed): Mac OS X (v10.4, 10.5, 10.6)

USB jack: Provided as standard

### Notes on connecting your camera to a computer

- Operations are not guaranteed for all the recommended computer environments mentioned above.
- If you connect two or more USB devices to a single computer at the same time, some devices, including your camera, may not operate, depending on the types of USB devices you are using.
- Operations are not guaranteed when using a USB hub or an extension cable.
- Connecting your camera using a USB interface that is compatible with Hi-Speed USB (USB 2.0 compliant) allows advanced transfer (high speed transfer) as this camera is compatible with Hi-Speed USB (USB 2.0 compliant).
- When your computer resumes from a suspend or sleep mode, communication between your camera and your computer may not recover at the same time.

## Stage 1: Connecting the camera and your computer

**1 Insert a memory card with recorded images into the camera.**

**2 Select the type of memory card you want to copy images from using the memory card switch.**

**3 Insert the sufficiently charged battery pack in the camera, or connect the camera to a wall outlet (wall socket) with the AC Adaptor (sold separately).**

- When you copy images to your computer using an insufficiently charged battery pack, copying may fail or image data may become corrupted if the battery pack shuts down too soon.

**4 Turn on the camera and the computer.**

**5 Check that [USB connection] in  2 is set to [Mass Storage].**

**6 Connect the camera and your computer.**

The AutoPlay wizard appears on the desktop.

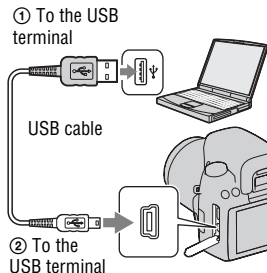

## Stage 2: Copying images to a computer

### For Windows

This section describes an example of copying images to a “Documents” (For Windows XP: “My Documents”) folder.

When you use the supplied “PMB” software, you can copy images easily (page 138).

### 1 Click [Open folder to view files] (For Windows XP: [Open folder to view files] → [OK]) as the wizard screen appears automatically on the desktop.

- When the wizard screen does not appear, click [Computer] (For Windows XP: [My Computer]) → [Removable Disk].



### 2 Double-click [DCIM].

### 3 Double-click the folder where the image files you want to copy are stored.

Then, right-click an image file to display the menu and click [Copy].

- On the storage destination of the image files, see page 136.



---

## 4 Double-click the [Documents] folder. Then, right-click on the “Documents” window to display the menu and click [Paste].

The image files are copied to the “Documents” folder.

- When an image with the same file name exists in the copy destination folder, the overwrite confirmation message appears. When you overwrite an existing image with a new one, the original file data is deleted. To copy an image file to the computer without overwriting, change the file name to a different name and then copy the image file. However, note that if you change the file name, you may not be able to play back that image with your camera (page 136).

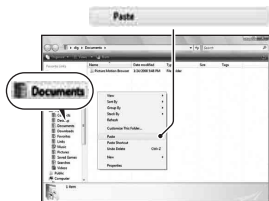

---

### For Macintosh

---

## 1 Double-click the newly recognized icon → [DCIM] → the folder where the images you want to copy are stored.

---

## 2 Drag and drop the image files to the hard disk icon.

The image files are copied to the hard disk.

---

## Viewing images on your computer

### For Windows

- ① Click [Start] → [Documents] (For Windows XP: [My Documents]).
  - To view RAW images, the supplied “Image Data Converter SR” software is required (page 141).
- ② Double-click the desired image file.

The image is displayed.

## For Macintosh



Double-click the hard disk icon → the desired image file to open the image file.

## Deleting the USB connection

Perform each procedure for Windows or Macintosh listed below beforehand when:

- Disconnecting the USB cable.
- Removing the memory card.
- Turning off the camera.

### ■ For Windows

Double-click  on the tasktray, then click  (USB Mass Storage Device) → [Stop]. Confirm the device on the confirmation window, then click [OK].

The device is disconnected.

### ■ For Macintosh

**Drag and drop the drive icon or the icon of the memory card to the “Trash” icon.**

The camera is disconnected from the computer.

## Image file storage destinations and file names

The image files recorded with your camera are grouped as folders on the memory card.

### Example: viewing folders on Windows Vista

- A** Folders containing image data recorded using this camera. (The first three digits show the folder number.)
- B** You can create a folder in date form (page 122).
- You cannot record/play back any images in the “MISC” folder.
- Image files are named as follows. □□□□ (file number) stands for any number within the range of 0001 to 9999. The numerical portions of the name of a RAW data file and its corresponding JPEG file are the same.
  - JPEG files: DSC0□□□□.JPG
  - JPEG files (Adobe RGB):  
\_DSC□□□□.JPG
  - RAW data file (other than Adobe RGB):  
DSC0□□□□.ARW
  - RAW data file (Adobe RGB):  
\_DSC□□□□.ARW
- The extension may not be displayed depending on the computer.

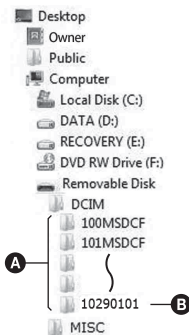

## Copying images stored on a computer to a memory card and viewing the images

This section describes the process using a Windows computer as an example. Step 1 is not necessary if the file name has not been changed. When you use the supplied “PMB” software, you can copy images easily (page 138).



## 1 Right-click the image file, then click [Rename]. Change the file name to “DSC0□□□□.”

- Enter a number from 0001 to 9999 for □□□□.
- If the overwrite confirmation message appears, enter a different number.
- An extension may be displayed depending on the computer settings. The extension for images is JPG. Do not change the extension.

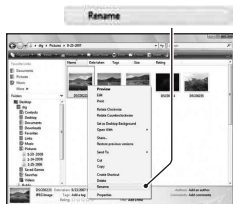

## 2 Copy the image file to the memory card folder in the following order.

- ① Right-click the image file, then click [Copy].
  - ② Double-click [Removable Disk] in [Computer] (For Windows XP: [My Computer]).
  - ③ Right-click the [□□□MSDCF] folder in the [DCIM] folder, then click [Paste].
- □□□ stands for any number within the range of 100 to 999.



### Notes

- You may be unable to play back some images depending on the image size.
- When an image file has been processed by a computer or when the image file was recorded using a model other than that of your camera, playback on your camera is not guaranteed.
- When there is no folder, first create a folder with your camera (page 123) and then copy the image file.

# Using the software

To utilize images recorded with the camera, the following software is provided:

- Sony Image Data Suite
  - “Image Data Converter SR”
  - “Image Data Lightbox SR”
- Sony Picture Utility
  - “PMB” (Picture Motion Browser)

## Note

- “PMB” is not compatible with Macintosh computers.

## Recommended computer environment

### ■ Windows

Recommended environment for using “Image Data Converter SR Ver.3”/  
“Image Data Lightbox SR”

OS (pre-installed): Microsoft Windows XP\*<sup>1</sup> SP3/Windows Vista\*<sup>2</sup> SP2/  
Windows 7\*<sup>2</sup>

\*1 64-bit editions and Starter (Edition) are not supported.

\*2 Starter (Edition) is not supported.

CPU/Memory: Pentium 4 or faster is recommended, RAM 1 GB or more is recommended.

Display: 1024 × 768 dots or more

Recommended environment for using “PMB”

OS (pre-installed): Microsoft Windows XP\*<sup>1</sup> SP3/Windows Vista\*<sup>2</sup> SP2/  
Windows 7\*<sup>2</sup>

\*1 64-bit editions and Starter (Edition) are not supported. To create a disc,  
Windows Image Mastering API (IMAPI) Ver. 2.0 or higher is required.

To download the IMAPI installer, an Internet connection is required.

\*2 Starter (Edition) is not supported.

CPU/Memory: Pentium III 500 MHz or faster, 256 MB of RAM or more  
(Recommended: Pentium III 800 MHz or faster and 512 MB of RAM or more)

Hard Disk: Disk space required for installation—500 MB or more

Display: 1024 × 768 dots or more

## ■ Macintosh

Recommended environment for using “Image Data Converter SR Ver.3”/“Image Data Lightbox SR”

OS (pre-installed): Mac OS X (v10.4, 10.5)

CPU: Power PC G4/G5 series (1.0 GHz or faster is recommended)/Intel Core Solo/Core Duo/Core 2 Duo or faster

Memory: 1 GB or more is recommended.

Display: 1024 × 768 dots or more

## Installing the software

### ■ Windows

- Log on as Administrator.

## 1 Turn on your computer, and insert the CD-ROM (supplied) into the CD-ROM drive.

The installation menu screen appears.

- If it does not appear, double-click [Computer] (For Windows XP: [My Computer]) →  (SONYPICTUTIL) → [Install.exe].
- Under Windows Vista, the AutoPlay screen may appear. Select “Run Install.exe” and follow the instructions that appear on the screen to proceed with the installation.



## 2 Click [Install].

- Verify that both “Sony Image Data Suite” and “Sony Picture Utility” are checked and follow the instructions on the screen.

---

### **3 Remove the CD-ROM after the installation is complete.**

The following software is installed and shortcut icons appear on the desktop.

- Sony Image Data Suite
    - “Image Data Converter SR”
    - “Image Data Lightbox SR”
  - Sony Picture Utility
    - “PMB”
    - “PMB Guide”
- 

#### **■ Macintosh**

- Log on as Administrator.
- 

### **1 Turn on your Macintosh computer, and insert the CD-ROM (supplied) into the CD-ROM drive.**

---

### **2 Double-click the CD-ROM icon.**

---

### **3 Copy the [IDS\_INST.pkg] file in the [MAC] folder to the hard disk icon.**

---

### **4 Double-click the [IDS\_INST.pkg] file in the copy-to folder.**

- Follow the instructions on the screen to complete the installation.
- 

#### **Note**

- When the restart confirmation message appears, restart the computer following the instructions on the screen.

## Using “Image Data Converter SR”

### Note

- If you save an image as RAW data, the image is saved in the ARW2.1 format.

With “Image Data Converter SR” you can:

- Edit images recorded in RAW format with various corrections, such as tone curve, and sharpness.
- Adjust images with white balance, exposure, and creative style, etc.
- Save the images displayed and edited on a computer. You can either save the image as RAW format or save it in the general file format.
- For details on “Image Data Converter SR,” refer to Help.

To start Help, click [Start] → [All Programs] → [Sony Image Data Suite] → [Help] → [Image Data Converter SR Ver.3].

The support information for the “Sony Image Data Suite” (English only):  
<http://www.sony.co.jp/ids-se/>

## Using “Image Data Lightbox SR”

With “Image Data Lightbox SR” you can:

- Display and compare RAW/JPEG images recorded with this camera.
- Rate the images on a scale of five.
- Set color labels and so on.
- Display an image with “Image Data Converter SR” and make adjustments to it.
- For details on “Image Data Lightbox SR,” refer to Help.

To start Help from the Start menu, click [Start] → [All Programs] → [Sony Image Data Suite] → [Help] → [Image Data Lightbox SR].

## Using “PMB”

### Note

- “PMB” is not compatible with Macintosh computers.

With “PMB” you can:

- Import images shot with the camera and display them on the computer.
- Organize images on the computer on a calendar by shooting date to view them.
- Retouch (Red Eye Correction, etc.), print, and send still images as e-mail attachments, change the shooting date and more.
- Print or save still images with the date.
- Create a data disc using a CD burner drive or DVD burner drive.
- For details on “PMB,” refer to “PMB Guide.”

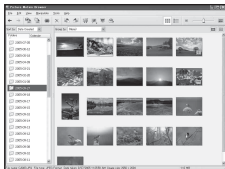

To start “PMB Guide,” double-click the shortcut of  (PMB Guide) on the desktop. When starting up from the start menu, click [Start] → [All Programs] → [Sony Picture Utility] → [Help] → [PMB Guide].

The support information for the “PMB” (English only):

<http://www.sony.co.jp/pmb-se/>

### Note

- The confirmation message of the Information tool appears on the screen when starting “PMB” for the first time. Select [Start]. This function informs you of news, such as software updates. You can change the setting later.

# Specifying DPOF

Using the camera, you can specify the images and the number of images to print before you print images at a shop or with your printer. Follow the procedure below.

DPOF specifications are left with images after printing. It is recommended that you unspecify them after printing.

## Specifying /unspecifying DPOF on selected images

---

**1** MENU button →  1 → [Specify Printing] → [DPOF setup] → [Marked images] → [OK]

---

**2** Select the image with ◀/▶ on the controller.

---

**3** Select the number of sheets with the center of the controller.

- To unspecify DPOF, set the number to “0.”
- 

**4** Press the MENU button.

---

**5** Select [OK] with ▲ on the controller, then press the center of the controller.

---

### Notes

- You cannot specify DPOF on RAW data files.
- You can specify any number up to 9.

## Dating images

You can date images when printing them. The position of the date (inside or outside the image, character size, etc.) depends on your printer.

**MENU button** →  **1** → **[Specify Printing]** → **[Date imprint]** → **[On]**

### Note

- This function may not be provided, depending on the printer.



# Printing images by connecting the camera to a PictBridge compliant printer

Even if you do not have a computer, you can print images shot using your camera by connecting the camera directly to a PictBridge compliant printer.

“PictBridge” is based on the CIPA standard. (CIPA: Camera & Imaging Products Association)



## Note

- You cannot print RAW images.

## Stage 1: Connecting the camera to the printer

### Note

- It is recommended to use the AC Adaptor (sold separately) to prevent the power from turning off partway through printing.

**1 MENU button** →  **2** → [USB connection] → [PTP]

**2 Turn the camera off and select the type of memory card you want to print images from using the memory card switch.**

**3 Connect the camera to the printer.**

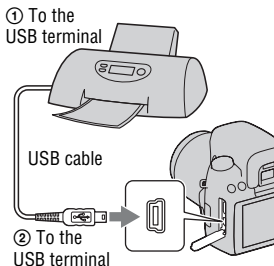

---

## **4 Turn on your camera and the printer.**

The screen used for selecting images you want to print appears.

---

### Stage 2: Printing

---

## **1 Select the image to print with ◀/▶ on the controller, then press the center of the controller.**

- To cancel, press the center again.
- 

## **2 Select [OK] in the menu, then press the center of the controller.**

The image is printed.

- After the screen indicating that the print is completed appears, press the center of the controller.
- 

## **3 Repeat steps 1 and 2 if you want to print other images.**

---

### **To cancel the print**

During printing, pressing the center of the controller cancels the print. Remove the USB cable or turn off the camera. When you want to print again, follow the procedure (Stages 1 and 2) above.

# Specifications

## Camera

### [System]

Camera Type	Digital Single Lens Reflex Camera with built-in flash and interchangeable lenses
Lens	All of $\alpha$ Lenses

### [Image sensor]

Image format	23.4×15.6 mm (APS-C format) CMOS image sensor
Total pixel number of image sensor	Approx. 14 600 000 pixels
Effective pixel number of camera	Approx. 14 200 000 pixels

### [SteadyShot]

System	Image sensor-shift mechanism
--------	------------------------------

### [Anti-Dust]

System	Charge protection coating on Low-Pass Filter and image sensor-shift mechanism
--------	---

### [Auto Focus System]

System	TTL phase-detection system, CCD line sensors (9 points, 8 lines with center cross-hair sensor)
Sensitivity Range	0 to 18 EV (at ISO 100 conversion)
AF illuminator	Approx. 1 to 5 m (3.3 to 16.4 feet)

### [Manual focus check Live View]

Image format	Image sensor for shooting
Frame Coverage	100%

### [Viewfinder]

Type	Fixed eye-level pentaprism-mirror
Frame Coverage	95%
Magnification	0.83 × with 50 mm lens at infinity, $-1 \text{ m}^{-1}$ (diopter)
Eye Point	Approximately 16.5 mm from the eyepiece, 10.9 mm from the eyepiece frame at $-1 \text{ m}^{-1}$
Diopter Adjustment	$-2.5$ to $+1.0 \text{ m}^{-1}$

### [Exposure control]

Metering Cell	SPC
Metering method	40-segment honeycomb-pattern
Metering Range	1 to 20 EV (3 to 20 EV with Spot metering), (at ISO 100 conversion with F1.4 lens)
ISO sensitivity (Recommended exposure index)	AUTO, ISO 200 to 12800
Exposure compensation	$\pm 2.0$ EV (1/3 EV step)
[Shutter]	
Type	Electronically-controlled, vertical-traverse, focal-plane type

Speed range 1/4000 second to 30  
seconds, bulb, (1/3 EV  
step)

Flash sync speed  
1/160 second

### [Built-In-Flash]

Flash guide number  
GN 12 (in meters at ISO  
100 conversion)

Recycling time  
Approx. 4 seconds

Flash coverage  
Covering 18 mm lens  
(focal length that the lens  
indicates)

Flash compensation  
±2.0 EV (1/3 EV step)

### [Recording media]

“Memory Stick PRO Duo”  
media, “Memory Stick  
PRO-HG Duo” media, SD  
memory card, SDHC  
memory card

### [LCD monitor]

LCD panel 6.7 cm (2.7 type) TFT  
drive

Total number of dots  
230 400 (960 × 240) dots

### [Input/output terminals]

USB miniB

HDMI HDMI type C minijack

### [Power, general]

Used battery pack  
Rechargeable battery pack  
NP-FM500H

### [Others]

PictBridge Compatible

Exif Print Compatible

PRINT Image Matching III  
Compatible

Dimensions Approx. 137 × 104 ×  
81 mm (5 1/2 × 4 1/8 ×  
3 1/4 inches) (W/H/D,  
excluding protrusions)

Mass Approx. 520 g (1 lb 2.3 oz)  
(without batteries, memory  
card and body accessories)

Operating temperature  
0 to 40°C (32 to 104°F)

File format JPEG (DCF Ver. 2.0, Exif  
Ver. 2.21, MPF Baseline)  
compliant, DPOF  
compatible

USB communication  
Hi-Speed USB (USB 2.0  
compliant)

## BC-VM10 Battery charger

Input rating 100 V – 240 V AC, 50/60  
Hz, 9 W

Output rating  
8.4 V DC, 0.75 A

Operating temperature range  
0 to 40°C (32 to 104°F)

Storage temperature range  
–20 to +60°C (–4 to  
+140°F)

Maximum dimensions  
Approx. 70 × 25 × 95 mm  
(2 7/8 × 1 × 3 3/4 inches)  
(W/H/D)

Mass Approx. 90 g (3.2 oz)

## Rechargeable battery pack NP-FM500H

Used battery

Lithium-ion battery

Maximum voltage

DC 8.4 V

Nominal voltage

DC 7.2 V

Maximum charge current

2.0 A

Maximum charge voltage

DC 8.4 V

Capacity

Typical 11.8 Wh (1 650 mAh)

Minimum 11.5 Wh (1 600 mAh)

Maximum dimensions

Approx. 38.2 × 20.5 × 55.6  
mm (1 9/16 × 13/16 × 2 1/4  
inches) (W/H/D)

Mass

Approx. 78 g (2.8 oz)

Design and specifications are subject to change without notice.

### On focal length

The picture angle of this camera is narrower than that of a 35 mm-format film camera. You can find the approximate equivalent of the focal length of a 35 mm-format film camera, and shoot with the same picture angle, by increasing the focal length of your lens by half. For example, by using a 50 mm lens, you can get the approximate equivalent of a 75 mm lens of a 35 mm-format film camera.

### On image data compatibility

- This camera conforms with DCF (Design rule for Camera File system) universal standard established by JEITA (Japan Electronics and Information Technology Industries Association).
- Playback of images recorded with your camera on other equipment and playback of images recorded or edited with other equipment on your camera are not guaranteed.

## Trademarks

- **α** is a trademark of Sony Corporation.
- “Memory Stick,” , “Memory Stick PRO,” **MEMORY STICK PRO**, “Memory Stick Duo,” **MEMORY STICK DUO**, “Memory Stick PRO Duo,” **MEMORY STICK PRO DUO**, “Memory Stick PRO-HG Duo,” **MEMORY STICK PRO-HG DUO**, “Memory Stick Micro,” “MagicGate,” and **MAGICGATE** are trademarks of Sony Corporation.
- “InfoLITHIUM” is a trademark of Sony Corporation.
- “PhotoTV HD” is a trademark of Sony Corporation.
- Microsoft, Windows, and Windows Vista are either registered trademarks or trademarks of Microsoft Corporation in the United States and/or other countries.
- HDMI, the HDMI logo and High-Definition Multimedia Interface are trademarks or registered trademarks of HDMI Licensing LLC.
- Macintosh and Mac OS are trademarks or registered trademarks of Apple Inc.
- PowerPC is a registered trademark of IBM Corporation in the United States.
- The SDHC logo is a trademark.
- MultiMediaCard is a trademark of MultiMediaCard Association.
- Intel, Intel Core, MMX, and Pentium are trademarks or registered trademarks of Intel Corporation.
- Adobe is a registered trademark or a trademark of Adobe Systems Incorporated in the United States and/or other countries.
- In addition, system and product names used in this manual are, in general, trademarks or registered trademarks of their respective developers or manufacturers. However, the <sup>TM</sup> or ® marks are not used in all cases in this manual.

# Troubleshooting

If you experience trouble with your camera, try the following solutions. Check the items on pages 151 to 159. Consult your Sony dealer or local authorized Sony service facility.

❶ Check the following items.

❷ Remove the battery pack, and insert the battery pack again after about one minute, and turn on the power.

❸ Reset the settings (page 129).

❹ Consult your Sony dealer or local authorized Sony service facility.

## Battery pack and power

### **The battery pack cannot be installed.**

- As you insert the battery pack, use the tip of the battery pack to push the lock lever (page 17).
- Check the model number of the battery pack (pages 12, 18).

### **The remaining battery indicator is incorrect, or sufficient remaining battery indicator is displayed but the power runs out too quickly.**

- This phenomenon occurs when you use the camera in an extremely hot or cold location (page 163).
- The battery pack is discharged. Install a charged battery pack (page 13).
- The battery pack is dead (page 19). Replace it with a new one.

### **Cannot turn on the camera.**

- Install the battery pack correctly (page 17).
- The battery pack is discharged. Install a charged battery pack (page 13).
- The battery pack is dead (page 19). Replace it with a new one.

---

### **The power turns off suddenly.**

- If you do not operate the camera for given period of time, the camera turns to power saving mode and nearly shuts down. To cancel the power save, operate the camera, such as pressing the shutter button halfway down (page 126).

---

### **The CHARGE lamp flashes when charging the battery pack.**

- Remove and re-insert the battery pack correctly.
- Charge the battery pack under the suitable temperatures between 10 and 30°C (50 and 86°F).

## Shooting images

---

### **Nothing is displayed on the LCD monitor when the power is turned on.**

- If you do not operate the camera for given period of time, the camera turns to power saving mode and nearly shuts down. To cancel the power save, operate the camera, such as pressing the shutter button halfway down (page 126).

---

### **The image is not clear in the viewfinder.**

- Adjust the diopter scale properly using the diopter-adjustment dial (page 26).

---

### **The shutter does not release.**

- You are using a memory card with a write-protect switch, and the switch is set to the LOCK position. Set the switch to the recording position.
- The position of the memory card switch is wrong. Set it to the correct position (page 22).
- Check the free capacity of the memory card (page 29).
- You cannot record images while charging the built-in flash (page 82).
- The shutter cannot be released when the subject is out of focus.
- The lens is not attached properly. Attach the lens properly (page 20).
- When an astronomical telescope, etc., is attached to the camera, set the exposure mode to M and do your shooting.
- The subject may require special focusing (page 72). Use the focus-lock or manual focus function (pages 73, 76).



---

### **Recording takes a long time.**

- The noise reduction function is turned on (page 124). This is not a malfunction.
- You are shooting in RAW mode (page 120). Since the RAW data file is large, the RAW mode shooting may take time.
- The Auto HDR is processing an image (page 91).

---

### **The image is out of focus.**

- The subject is too close. Check the minimum focal distance of the lens.
- You are shooting in manual focus mode, set the focus mode switch to AF (autofocus) (page 71).
- When the focus mode switch is equipped with the lens, set it to AF.
- Ambient light is insufficient.

---

### **Eye-Start AF does not work.**

- Set [Eye-Start AF] to [On] (page 73).
- Press the shutter button halfway down.

---

### **The flash does not work.**

- The flash mode is set to [Autoflash]. If you want to make sure the flash fires without fail, set the flash mode to [Fill-flash] (page 82).

---

### **The flash takes too long to recharge.**

- The flash has been fired in succession in a short period. When the flash has been fired in succession, the recharging process may take longer than usual to avoid overheating of the camera.

---

### **A picture taken with the flash is too dark.**

- If the subject is beyond the flash range (the distance that the flash can reach), the pictures will be dark because the flash light does not reach the subject. If the ISO is changed, the flash range also changes with it (page 84).

---

### **The date and time are recorded incorrectly.**

- Set the correct date and time (page 25).

---

**The aperture value and/or shutter speed flashes when you press the shutter button halfway down.**

- Since the subject is too bright or too dark, it is beyond the available range of the camera. Adjust the setting again.

---

**The image is whitish (Flare).**

**Blurring of light appears on the image (Ghosting).**

- The picture was taken under a strong light source, and excessive light has entered the lens. Attach a lens hood (sold separately).

---

**The corners of the picture are too dark.**

- If any filter or hood is used, take it off and try shooting again. Depending on the thickness of the filter and improper attachment of the hood, the filter or the hood may partially appear in the image. The optical properties of some lenses may cause the periphery of the image to appear too dark (insufficient light).

---

**The eyes of the subject come out red.**

- Activate the red eye reduction function (page 84).
- Get close to the subject, and shoot the subject within the flash range using the flash (page 84).

---

**Dots appear and remain on the LCD monitor.**

- This is not a malfunction. These dots are not recorded (page 7).

---

**The image is blurred.**

- The picture was taken in a dark location without the flash, resulting in camera shake. The use of a tripod or the flash is recommended (pages 50, 82).

---

**The EV scale ◀ ▶ is flashing on the LCD monitor or in the viewfinder.**

- The subject is too bright or too dark for the metering range of the camera.

## Viewing images

**Your camera cannot play back images.**

- The folder/file name has been changed on your computer (page 136).

- When an image file has been processed by a computer or when the image file was recorded using a model other than that of your camera, playback on your camera is not guaranteed.
- The camera is in USB mode. Delete the USB connection (page 135).

## Deleting/Editing images

### **Your camera cannot delete an image.**

- Cancel the protection (page 114).

---

### **You have deleted an image by mistake.**

- Once you have deleted an image, you cannot restore it. We recommend that you protect images that you do not want to delete (page 114).

---

### **You cannot mark a DPOF mark.**

- You cannot mark DPOF marks on RAW images.

## Computers

### **You do not know if the OS of your computer is compatible with the camera.**

- Check “Recommended computer environment” (pages 131, 138).

---

### **Your computer does not recognize your camera.**

- Check that the camera is turned on.
- When the battery level is low, install the charged battery pack (page 13), or use the AC Adaptor (sold separately).
- Use the USB cable (supplied) (page 132).
- Disconnect the USB cable, and connect it again firmly.
- Set [USB connection] to [Mass Storage] (page 132).
- Disconnect all equipment other than the camera, the keyboard and the mouse from the USB jacks of your computer.
- Connect the camera directly to your computer without passing through a USB hub or other device (page 131).

---

### **You cannot copy images.**

- Make the USB connection by properly connecting the camera with your computer (page 132).
- Follow the designated copy procedure for your OS (page 133).

- When you shoot images with a memory card formatted by a computer, you may not be able to copy the images to a computer. Shoot using a memory card formatted by your camera (page 123).

---

**The image cannot be played back on a computer.**

- If you are using “PMB,” refer to the “PMB Guide.”
- Consult the computer or software manufacturer.

---

**After making a USB connection, “PMB” does not start automatically.**

- Make the USB connection after the computer is turned on (page 132).

## Memory card

**Cannot insert a memory card.**

- Insertion direction of the memory card is wrong. Insert it in the correct direction (page 22).

---

**Cannot record on a memory card.**

- The memory card is full. Delete unnecessary images (page 115).
- An unusable memory card is inserted (page 23).

---

**You have formatted a memory card by mistake.**

- All the data on the memory card is deleted by formatting. You cannot restore it.

---

**“Memory Stick PRO Duo” media are not recognized by a computer with a “Memory Stick” media slot.**

- If “Memory Stick PRO Duo” media are not supported on your computer’s “Memory Stick” media slot, connect the camera to the computer (page 132). The computer will recognize the “Memory Stick PRO Duo” media.

## Printing

Also see “PictBridge compliant printer” (as follows) in conjunction with the following items.

---

### **The color of the image is strange.**

- When you print the images recorded in Adobe RGB mode using sRGB printers that are not compatible with Adobe RGB (DCF2.0/Exif2.21), the images are printed at a lower intensity level (page 95).

---

### **Images are printed with both edges cut off.**

- Depending on your printer, the left, right, top, and bottom edges of the image may be cut off. Especially when you print an image shot with the aspect ratio set to [16:9], the lateral end of the image may be cut off.
- When printing images using your own printer, cancel the trimming or borderless settings. Consult the printer manufacturer as to whether the printer provides these functions or not.
- When having images printed at a digital print shop, ask the shop whether they can print the images without cutting off both edges.

---

### **Cannot print images with the date.**

- Using “PMB,” you can print images with date (page 142).
- This camera does not have a feature for superimposing dates on images. However, because the images shot with the camera include information on the recording date, you can print images with the date superimposed if the printer or the software can recognize Exif information. For compatibility with Exif information, consult the manufacturer of the printer or the software.
- When you print images at a shop, images can be printed with the date if you ask them to do so.

## **PictBridge compliant printer**

For details, refer to the operating instructions supplied with the printer or consult with the manufacturer of the printer.

---

### **A connection cannot be established.**

- The camera cannot be connected directly to a printer that is not compliant with the PictBridge standard. Consult the printer manufacturer as to whether the printer is compliant with PictBridge or not.
- Set [USB connection] to [PTP] (page 145).
- Disconnect and connect the USB cable again. If an error message is indicated on the printer, refer to the operating instructions supplied with the printer.

---

### **Cannot print images.**

- Check that the camera and the printer are properly connected using the USB cable.
- RAW images cannot be printed.
- Images shot using cameras other than this camera or images modified with a computer may not be printed.

---

### **Cannot print the image at the size selected.**

- Disconnect the USB cable and reconnect it whenever you change the paper size after the printer has been connected to the camera.

---

### **Cannot operate the camera after canceling printing.**

- Wait for a while as the printer is carrying out the cancellation. It may take some time depending on the printer.

## Others

### **The lens gets fogged.**

- Moisture condensation has occurred. Turn off the camera and leave it for about an hour before using it (page 163).

---

### **The message “Set date and time?” appears when you turn on the camera.**

- The camera has been left unused for sometime with a low battery or no battery pack. Charge the battery pack and set the date again (pages 25, 163). If the date setting is lost every time the battery pack is charged, consult your Sony dealer or local authorized Sony service facility.

---

### **The number of recordable images does not decrease or decreases two at a time.**

- This is because the compression rate and the image size after compression change depending on the image when you shoot a JPEG image (page 120).

---

### **The setting is reset without the resetting operation.**

- The battery pack was removed when the power switch was set to ON. When removing the battery pack, make sure the camera is turned off and the access lamp is not illuminated (pages 17, 35).

---

**The camera does not work properly.**

- Turn off the camera. Remove the battery pack and insert it again. If an AC Adaptor (sold separately) is used, disconnect the power cord. If the camera is hot, allow it to cool down before trying this corrective procedure. If the camera does not work after doing these solutions, consult your Sony dealer or local authorized Sony service facility.

---

**The five bars of the SteadyShot scale flashes.**

- The SteadyShot function does not work. You can continue to shoot but the SteadyShot function will not work. Turn the camera off and on. If the SteadyShot scale continues to flash, consult your Sony dealer or local authorized Sony service facility.

---

**"--E-" is indicated on the screen.**

- Remove the memory card, and insert it again. If this procedure does not turn off the indication, format the memory card.

# Warning messages

If the following messages appear, follow the instructions below.

---

## Incompatible battery. Use correct model.

- An incompatible battery pack is being used (page 18).

---

## Set date and time?

- Set the date and time. If you have not used the camera for a long time, charge the internal rechargeable battery (pages 25, 163).

---

## Power insufficient

- You tried to perform [Cleaning mode] when the battery level is insufficient. Charge the battery pack or use the AC Adaptor (sold separately).

---

## Unable to use “Memory Stick.” Format?

### Unable to use SD memory card. Format?

- The memory card was formatted on a computer and the file format was modified.  
Select [OK], then format the memory card. You can use the memory card again, however, all previous data in the memory card is erased. It may take a some time to complete the format.

If the message still appears, change the memory card.

---

## Card error

- An incompatible memory card is inserted or the format has failed.

---

## Reinsert “Memory Stick.”

### Reinsert SD memory card.

- The inserted memory card cannot be used in your camera.
- The memory card is damaged.
- The terminal section of the memory card is dirty.

---

## SD memory card locked.

- You are using a memory card with a write-protect switch, and the switch is set to the LOCK position. Set the switch to the recording position.

---

## This “Memory Stick” is not supported. Use a supported “Memory Stick.”

- Use “Memory Stick” media available on this camera (page 23).

---

## The “Memory Stick” may not be capable of recording and playing normally.

- Since the card is not “Memory Stick” standard-compatible, it is not recommended that you use this card. Consult with the manufacturer of the card.



---

**No “Memory Stick” inserted.  
Shutter is locked.  
No SD memory card inserted.  
Shutter is locked.**

- No memory card is inserted. Insert a memory card.

---

**Processing...**

- When Long exposure noise reduction will be done for the same amount of time that the shutter was open. You cannot do any further shooting during this reduction.

---

**Unable to display.**

- Images recorded with other cameras or images modified with a computer may not be able to be displayed.

---

**No lens attached. Shutter is locked.**

- The lens is not attached properly, or the lens is not attached.
- When attaching the camera to an astronomical telescope or something similar, set the exposure mode to M.

---

**No images**

- There is no image in the memory card.

---

**Image protected**

- You tried to delete protected images.

---

**Unable to print.**

- You tried to mark RAW images with a DPOF mark.

---

**Initializing USB connection...**

- A USB connection has been established. Do not disconnect the USB cable.

---

**Check the connected device.**

- A PictBridge connection cannot be established. Disconnect the USB cable and connect it again.

---

**Camera overheating. Allow it to cool.**

- The camera has become hot because you have been shooting continuously. Turn the power off. Cool the camera and wait until the camera is ready to shoot again.



- The temperature of the camera in manual focus check Live View mode is increasing. If you intend to continue to use the camera, you cannot use the camera until the temperature decreases.

---

**Camera error  
System error**

- Turn the power off, remove the battery pack, then re-insert it. If the message appears frequently, consult your Sony dealer or local authorized Sony service facility.

---

**Unable to magnify.****Unable to rotate image.**

- Images recorded with other cameras may not be enlarged or rotated.

---

**No images changed**

- You attempted to specify DPOF without specifying images.

---

**Cannot create more folders.**

- The folder with a name beginning with “999” exists on the memory card. You cannot create any folders if this is the case.

---

**Printing canceled**

- The print job was canceled. Disconnect the USB cable or turn the camera off.

---

**Invalid operation**

- You attempted to mark RAW images on the PictBridge screen.

---

**Printer error**

- Check the printer.
- Check if the image you want to print is corrupted.

---

**Printer busy**

- Check the printer.

# Precautions

## Do not use/store the camera in the following places

- In an extremely hot, dry or humid place  
In places such as in a car parked in the sun, the camera body may become deformed and this may cause a malfunction.
- Under direct sunlight or near a heater  
The camera body may become discolored or deformed, and this may cause a malfunction.
- In a location subject to rocking vibration
- Near strong magnetic place
- In sandy or dusty places  
Be careful not to let sand or dust get into the camera. This may cause the camera to malfunction, and in some cases this malfunction cannot be repaired.

## On storing

Be sure to attach the lens cap or body cap when not using the camera. When attaching the body cap, remove all the dust from the cap before placing it on the camera. When you purchase the DT 18 – 55 mm F3.5 – 5.6 SAM Lens Kit, purchase the Rear Lens Cap ALC-R55 also.

## On operating temperatures

Your camera is designed for use under the temperatures between 0 and 40°C (32 and 104°F). Shooting in extremely cold or hot places that exceed this range is not recommended.

## On moisture condensation

If the camera is brought directly from a cold to a warm location, moisture may condense inside or outside the camera. This moisture condensation may cause a malfunction of the camera.

### How to prevent moisture condensation

When bringing the camera from a cold place to a warm place, seal the camera in a plastic bag and allow it to adapt to conditions at the new location over about an hour.

### If moisture condensation occurs

Turn off the camera and wait about an hour for the moisture to evaporate. Note that if you attempt to shoot with moisture remaining inside the lens, you will be unable to record clear images.

## On the internal rechargeable battery

This camera has an internal rechargeable battery for maintaining the date and time and other settings regardless of whether the power is on or off.

This rechargeable battery is continually charged as long as you are using the camera. However, if you use the camera for only short periods, it discharges gradually, and if you do not use the camera at all for about 3 months it becomes completely discharged. In this case, be sure to charge this rechargeable battery before using the camera.

However, even if this rechargeable battery is not charged, you can still use the camera as long as you do not record the date and time. If the camera resets the settings to the defaults each time you charge the battery, the internal rechargeable battery may be dead. Consult your Sony dealer or local authorized Sony service facility.

### **Charging method of the internal rechargeable battery**

Insert a charged battery pack in the camera, or connect the camera to a wall outlet (wall socket) using the AC Adaptor (sold separately), and leave the camera for 24 hours or more with the power off.

### **Notes on recording/playback**

- Before you record one-time events, make a trial recording to make sure that the camera is working correctly.
- This camera is neither dust-proof, nor splash-proof, nor water-proof.
- Do not look at the sun or a strong light through a removed lens or the viewfinder. This may cause irrecoverable damage to your eyes.

Or it may cause a malfunction of your camera.

- Do not use the camera near a location that generates strong radio waves or emits radiation. The camera may not be able to record or play back properly.
- Using the camera in sandy or dusty locations may cause malfunctions.
- If moisture condensation occurs, remove it before using the camera (page 163).
- Do not shake or strike the camera. In addition to malfunctions and an inability to record images, this may render the memory card unusable, or cause image data breakdown, damage or loss.
- Clean the flash surface before use. The heat of flash emission may cause dirt on the flash surface to become discolored or to stick to the flash surface, resulting in insufficient light emission.
- Keep the camera, supplied accessories, etc., out of the reach of children. A memory card, etc., may be swallowed. If such a problem occurs, consult a doctor immediately.

# Index

## Numerics

- 40-segment honeycomb pattern  
metering ..... 147

## A

- Adobe RGB..... 95
- AE Lock ..... 86
- AEL button ..... 125
- AF area..... 75
- AF illuminator..... 84
- Ambient light ..... 104
- Amount of exposure..... 60
- Anti-dust function ..... 32
- Aperture ..... 60, 62
- Aperture priority ..... 62
- Aspect ratio ..... 120
- Audio signals ..... 126
- Auto HDR..... 92
- Auto off w/ VF..... 127
- Auto review..... 127
- Autoflash..... 82
- Autofocus..... 71
- Autofocus mode ..... 74

## B

- Battery pack ..... 13, 17
- Bracket ..... 103
- BULB shooting ..... 69

## C

- Center weighted ..... 90
- Charging battery pack ..... 13
- Cleaning mode ..... 32
- Color filter..... 98
- Color Space ..... 95
- Color temperature ..... 98
- Compression ratio ..... 120
- Continuous AF ..... 74
- Continuous bracket ..... 103
- Continuous shooting ..... 101
- Contrast ..... 94
- Controller ..... 44
- Creative Style..... 94
- CTRL FOR HDMI ..... 119
- Custom white balance ..... 99

## D

- Date imprint ..... 144
- Date/Time setup ..... 25
- DC IN terminal..... 37
- Delete ..... 115
- Depth of field ..... 60
- Diopter-adjustment..... 26
- DPOF setup ..... 143
- D-Range Optimizer ..... 91
- Drive mode..... 101

## E

- Enlarged image ..... 107

EV scale.....	67, 87, 104
Exposure .....	60
Exposure compensation.....	87
Exposure mode .....	60
Eyecup .....	28
Eye-piece cover.....	28
Eye-piece sensors.....	127
Eye-Start AF.....	73

## F

File number.....	122
Fill-flash .....	82
Flash bracket.....	103
Flash compensation .....	88
Flash control .....	89
Flash mode.....	82
Flash Off.....	51, 82
Fn button.....	44
Focal length .....	149
Focus.....	71
Focus indicator .....	72
Focus mode.....	74
Focus-lock .....	73
Folder name .....	122
Format.....	123

## H

Help Guide disp.....	126
High ISO NR .....	124
High-speed sync .....	43
Histogram .....	113

## I

Image Data Converter SR.....	141
Image Data Lightbox SR .....	141
Image Index .....	108
Image quality .....	120
Image size .....	120
ISO sensitivity .....	96

## J

JPEG .....	120
------------	-----

## L

Landscape .....	55
Language.....	126
LCD brightness.....	127
LCD monitor.....	38, 80, 111
Lens.....	20
Long exp.NR.....	124

## M

Macro.....	56
Manual exposure.....	66
Manual focus .....	76
Manual focus check Live View .....	77
Manual shift.....	68
Memory card switch .....	22
“Memory Stick Duo” .....	22
“Memory Stick PRO Duo” .....	22
Menu .....	46
Metering mode.....	90
Moisture condensation.....	163
Multi segment .....	90

<b>N</b>	
New folder .....	123
Night Port./View .....	59
Noise reduction .....	124
Number of recordable images .....	29, 30
<b>P</b>	
PictBridge .....	145
PlaybackDisplay .....	106
PMB .....	142
Portrait .....	54
Power Save .....	126
Preset white balance.....	97
Pressing halfway down .....	52
Print.....	143, 145
Program auto.....	61
Protect .....	114
<b>Q</b>	
Quality .....	120
<b>R</b>	
RAW .....	120, 141
Rear sync.....	82
Red eye reduc.....	84
Reducing camera shake .....	48
Remote Commander .....	105
Reset.....	129
Rotate .....	107
<b>S</b>	
Saturation .....	94
Scene Selection .....	53
SD memory card .....	22
Select folder .....	123
Self-timer .....	102
Set the clock .....	25
Sharpness .....	94
Shooting .....	51
Shoulder strap .....	27
Shutter speed.....	60, 64
Shutter speed priority .....	64
Single-shot AF .....	74
Slide show .....	109
Slow sync.....	82
Specifications .....	147
Sports Action.....	57
Spot .....	90
SteadyShot function .....	49
Sunset .....	58
<b>U</b>	
USB connection .....	132
<b>V</b>	
Version .....	128
Viewfinder .....	26, 43
Viewing image .....	106
Viewing images on a TV screen .....	117
<b>W</b>	
White balance.....	97
White balance bracket.....	104
Wireless flash.....	85

Wireless Remote Commander  
.....105





