

Digital Single Lens Reflex Camera
Read This First

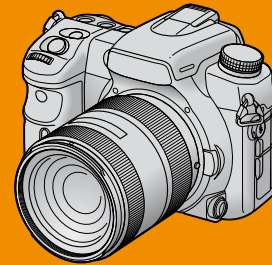

α700

DSLR-A700



HDMI

Operating Instructions

Before operating the unit, please read this manual and “**User’s Guide/Troubleshooting**” (separate volume) thoroughly, and retain them for future reference.

Additional information on this product and answers to frequently asked questions can be found at our Customer Support Website.

<http://www.sony.net/>



Printed on 70% or more recycled paper using VOC (Volatile Organic Compound)-free vegetableoil based ink.

Printed in Japan



3216919110

© 2007 Sony Corporation



Checking the accessories supplied

The number in parentheses indicates the number of pieces.

- BC-VM10 Battery charger (1)

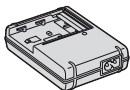

- Power cord (mains lead) (1)



- Rechargeable battery pack NP-FM500H (1)



- Wireless Remote Commander (Remote Commander) (1)



- USB cable (1)

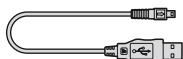

- Video cable (1)

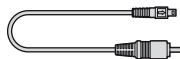

- Shoulder strap with eyepiece cover and Remote Commander clip (1)

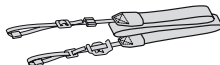

- Body cap (1) (Attached on the camera)



- Accessory shoe cap (1) (Attached on the camera)

- Eyecup (1) (Attached on the camera)

- CD-ROM (Application Software for α camera) (1)

- Operating instructions: "Read This First" (this manual) (1)

- Operating instructions: "User's Guide/ Troubleshooting" (1)

Composition of the operating instructions

This manual

Explains the set-up and basic operations for shooting/playback with your camera.

Prepare the camera and shoot images easily.

Checking the accessories supplied	2
1 Prepare the battery pack	4
2 Attach a lens	6
3 Insert a memory card (not supplied).....	8
4 Turn the camera on/set the clock.....	10
5 Shoot images easily (Auto adjustment mode)	12
The number of images that can be recorded.....	13
Holding the camera.....	13
Super SteadyShot function	14
Focus.....	15
Using the flash.....	16
Adjusting the diopter	17
6 View/delete images.....	18



“User’s Guide/Troubleshooting” (separate volume)

Get more friendly with your camera

- Shoot with your favorite settings → Using the shooting functions
- Playback with your favorite settings → Using the viewing functions
- Enjoy various shooting/playback functions using the menu → Using the menu

Connect your camera to a PC or a printer

- Copy your images to a computer and enjoy editing them in various ways
→ Using your computer
- Print images by connecting your camera directly to a printer
(PictBridge compliant printers only) → Printing images

1 Prepare the battery pack

1 Insert the battery pack.

Push the battery pack until it clicks.

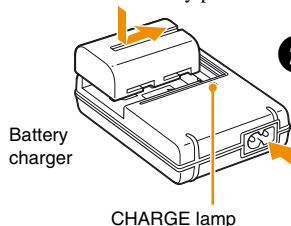

2 Connect the power cord (mains lead).

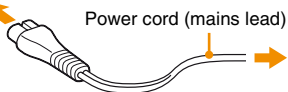

3 To wall outlet (wall socket)

Light on: Charging

Light off: Completed (**Normal Charge**)

If you continue charging the battery pack for approximately one more hour, until it is fully charged (**Full Charge**), the battery life will be slightly longer.

- Connect the battery charger to an easily accessible wall outlet (wall socket) close by.
- Even if the CHARGE lamp is not lit, the battery charger is not disconnected from the AC power source (mains) as long as it is connected to the wall outlet (wall socket). If some trouble occurs while using the battery charger, immediately shut off the power by disconnecting the plug from the wall outlet (wall socket).
- When charging is finished, disconnect the power cord (mains lead) from the wall outlet (wall socket), and remove the battery pack from the battery charger.
- Time required to charge a fully depleted battery pack (supplied) at a temperature of 25°C (77°F). Charging may take longer under certain circumstances or conditions.

Full charge	Normal charge
Approx. 235 min.	Approx. 175 min.

4 Insert the charged battery pack.

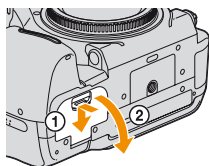

While sliding the battery cover open lever, open the battery cover.

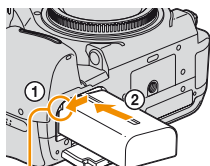

Lock lever

Firmly insert the battery pack all the way while pressing the lock lever with the tip of the battery.

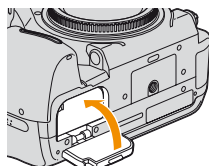

Close the cover.

Note on the battery pack

Use only an NP-FM500H battery pack. Note that the NP-FM55H, NP-FM50 and NP-FM30 cannot be used.

Using the AC Adaptor/charger

You can connect the camera to a wall outlet (wall socket) using the AC-VQ900AM AC Adaptor/charger (not supplied). → “User’s Guide/Troubleshooting” (page 165)

To check the remaining battery level



Set the POWER switch to ON and check the level on the LCD monitor. The level is indicated with the percent figures.

- The displayed level may not be correct under certain circumstances.

Battery level						“Battery exhausted”
	High Low					You cannot shoot any more pictures.

To remove the battery pack

Slide the lock lever in the direction of the arrow. Be careful not to drop the battery pack. Before removing the battery pack, check that the power is turned off.

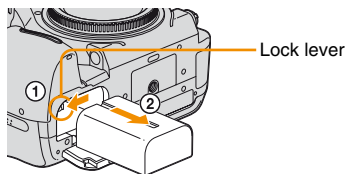

To use your camera abroad — Power sources

You can use your camera and the battery charger and the AC-VQ900AM AC Adaptor/charger (not supplied) in any country or region where the power supply is within 100 V to 240 V AC, 50/60 Hz. Use a commercially available AC plug adaptor [a], if necessary, depending on the design of the wall outlet (wall socket) [b].

- Do not use an electronic transformer (travel converter), as this may cause a malfunction.

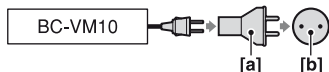

2 Attach a lens

- 1 Remove the body cap from the camera and the rear cap from the lens.

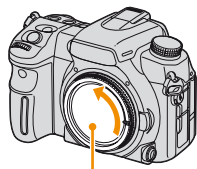

Body cap



Rear cap

- Make sure not to leave the interior of the camera exposed to dust or water droplets.

If dust enters the camera, perform [Cleaning mode] (→ “User’s Guide/Troubleshooting” (page 125)) and brush the dust away using a commercially available blower brush.

- 2 Attach the lens.

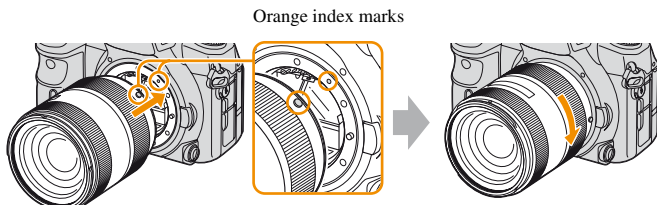

Orange index marks

Mount the lens by aligning the orange index marks on the lens and camera.

Turn the lens clockwise until it clicks into the locked position.

- When attaching a lens, do not press the lens release button.
- Do not use force when attaching a lens.
- When shooting without the flash, using a lens hood is recommended to prevent unnecessary light from affecting your images. For details on attaching the lens hood, refer to the operating instructions supplied with the lens.

To remove the lens

Press the lens release button all the way in and turn the lens counterclockwise until it stops.

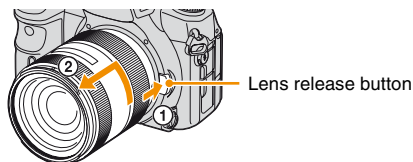

- Replace the cap on the lens and attach the body cap (or another lens) to the camera after removing the lens.

Keep dust from getting inside the camera when changing lenses!

If dust or debris gets inside the camera and lands on the surface of the image sensor (the part that acts as the film), it may appear on the image, depending on the shooting environment.

The camera is equipped with an anti-dust function to prevent dust from landing on the image sensor. However, take note of the following reminders when attaching/removing a lens.

- Avoid changing lenses in a dusty location.
- When storing the camera, always attach a lens or the body cap.
- When attaching the body cap, remove all the dust from the cap before placing it on the camera.

If dust or debris gets inside the camera, select [Cleaning mode] in the  Setup menu, and use a commercially available blower brush to clean the image sensor. → “User’s Guide/Troubleshooting” (page 125)

3 Insert a memory card (not supplied)

Available memory cards for the camera

"Memory Stick Duo"



CompactFlash/
Microdrive

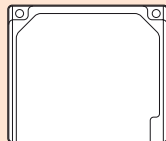

You can use a "Memory Stick Duo", CompactFlash card (CF card), or Microdrive as a memory card.

- Before using a memory card, be sure to format it using this camera. Otherwise, satisfactory performance may not be obtained. → "User's Guide/Troubleshooting" (page 115)
- For more information about the memory card → "User's Guide/Troubleshooting" (page 161)

Insert a memory card

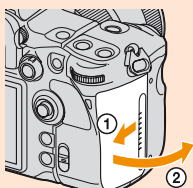

Open the memory card cover.

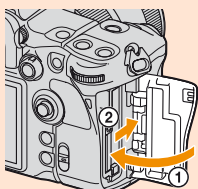

Close the cover.

"Memory Stick Duo"

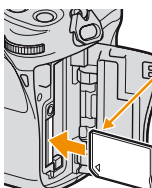

Terminal side

Insert a memory card all the way in until it clicks.

CompactFlash/Microdrive

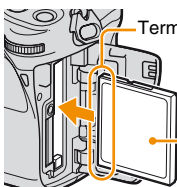

Terminal side

Front side

Insert a memory card from the terminal side (the terminal side has a number of small holes).

Wrong directions

Terminal side



Terminal side

- Be careful not to pinch your fingers when opening the cover.
- Straight insert a memory card by pressing the center of the memory card. Do not press the edges of the memory card.
- Be careful about insertion direction of a memory card. Inserting a memory card in a wrong direction may cause a malfunction.

When shooting using a “Memory Stick Duo”

You must set [Memory card] to [Memory Stick] in the  Setup menu. Follow the procedure below after turning on the camera.

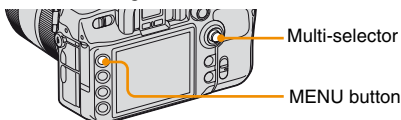

1 Press MENU.

2 Set up using the multi-selector.

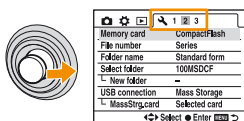

Move the multi-selector to the right to select [] → [2], then press the center.

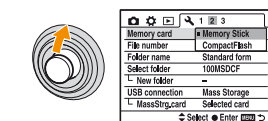

Move the multi-selector up and set [Memory card] to [Memory Stick], then press the center.

3 Press MENU to turn off the menu.

To remove the memory card

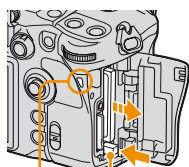

CF card eject lever

Access lamp

1 Open the memory card cover.

2 “Memory Stick Duo”:

Push the “Memory Stick Duo” once.

CompactFlash/Microdrive:

Push down the CF card eject lever.

- The memory card may be hot just after it has been used. Be careful when you handle it.

When the access lamp is lit

Never remove the memory card or the battery pack, or turn off the power. The data may be corrupted.

CompactFlash/Microdrive

We have checked the operations, however, we cannot guarantee proper operation of all CF cards/Microdrives.

- The Microdrive is a compact and lightweight hard disk drive that complies with CompactFlash Type II standards. For more information about the CompactFlash/Microdrive → “User’s Guide/Troubleshooting” (page 162)

4 Turn the camera on/set the clock

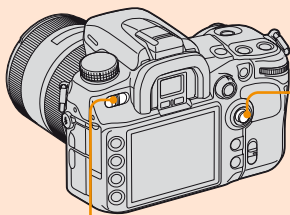

- 1 Set the POWER switch to ON by sliding it in the direction of the arrow.**



- 2 Set the clock with the multi-selector.**

The direction in which the multi-selector is moved is expressed as ▲/▼/◀/▶.



- ▲: Move up
- ▼: Move down
- ◀: Move to the left
- ▶: Move to the right



Press the center to execute.

- Verify that [OK] is selected, then press the center of the multi-selector.

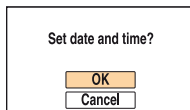

- If you want to set the clock later, select [Cancel] with ▼, then press the center of the multi-selector.

- Select each item with ◀/▶ and set the numeric value with ▲/▼.

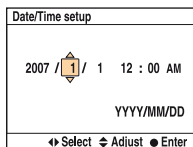

- Repeat Step 2 to set other items.

- [YYYY/MM/DD] represents the order of year, month, and day. You can change this order with ▲/▼.

- Press the center of the multi-selector.

- After checking whether [OK] is selected, press the center of the multi-selector.

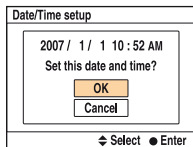

- To cancel, press MENU.

To change the date and time

See the “*User’s Guide/Troubleshooting*” (page 122)

Select [Date/Time setup] in the  Setup menu and perform the procedure in step ②-2 to -5.

When turning on the power

Unless you set the clock, “Set date and time?” appears each time the camera is turned on.

To turn off the power

Set the POWER switch to OFF sliding in the arrow direction. Attach the lens cap. After you remove the lens, store the camera with the body cap attached.











Power Save (The camera nearly shuts down if it is not operated)

If you do not operate the camera for about five seconds, the recording mode display on the LCD monitor disappears. Also, if you do not operate the camera for about three minutes, the camera turns to power saving mode and nearly shuts down (Power Save). To cancel the power save, operate the camera, for example, by pressing the shutter button halfway down.

- You can change the time that must elapse to activate the function (the default settings are [5 sec]/[3 min]).
→ “*User’s Guide/Troubleshooting*” (page 120)

Changing the language setting

You can change the screen display to show messages in a specified language. To change the language setting, follow the procedure below.

- 1 Press MENU to display the menu.
- 2 Select [] → [1] with /  on the multi-selector.
- 3 Select [ Language] with /  on the multi-selector, then press the center of the multi-selector.
- 4 Select the desired language with /  on the multi-selector, then press the center of the multi-selector.

5 Shoot images easily (Auto adjustment mode)

The main functions of the camera are adjusted automatically in auto adjustment mode. Using this mode, you can shoot easily, depending entirely on the camera. However, you can change any of the settings.

1 Set the mode dial to AUTO.

2 Hold the grip and look into the viewfinder.

The subject at the intersection of  (the 11 focus area sensors) comes into focus.

3 When using a zoom lens, turn the zoom ring, then decide on your shot.

4 Shoot with the shutter button.

Press the shutter button halfway down to focus.

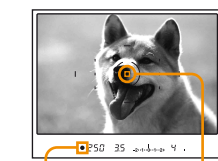
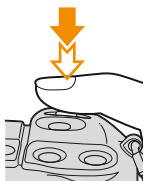

Focus indicator

(Indicates the status of the autofocus (page 15))

Press the shutter button fully down to shoot. The shutter sounds.

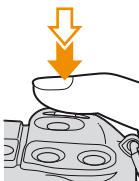

Sensor used for focus adjustment

(Illuminated in red briefly to indicate the point of focus.)

- The image is not displayed on the LCD monitor before the recording is completed. Use the viewfinder for monitoring.
- After shooting, the recorded image is displayed for two seconds on the LCD monitor. You can change the display time. → "User's Guide/Troubleshooting" (page 111)
- While the image is being recorded, the access lamp lights. Do not remove the memory card or turn off the power while this lamp is lit.

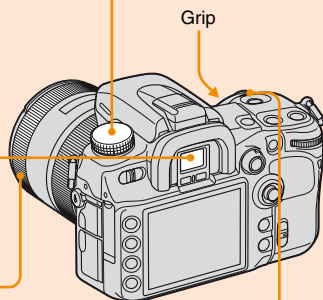

The number of images that can be recorded

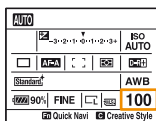

Once you insert a memory card into the camera and set the POWER switch to ON, the number of images that can be recorded (should you continue to shoot using the current settings) is displayed on the LCD monitor.

To identify items on the LCD monitor → “*User’s Guide/Troubleshooting*” (page 20)

- The number of images that can be recorded on a memory card differs depending on the capacity of the memory card, the image size setting, and the image quality setting. → “*User’s Guide/Troubleshooting*” (page 24)
- If “0” is flashing in yellow, the memory card is full. Replace the memory card with another one, or delete images in the current memory card (pages 8, 18).
- Since the data amount of each image is different, the remaining number of recordable images may not change after shooting.

Holding the camera

Hold the camera steady to avoid blurring of images due to hand movement. Turning on the Super SteadyShot function is also recommended (page 14).



- Grip the camera firmly with your right hand, keep your elbows at your side, and support the lens with the palm of your left hand.
- Step out with one foot to stabilize your upper body. Leaning against a wall or putting your elbow on a table will also provide support.
- When shooting in dark light without the flash, shooting in macro, or using a telephoto lens, camera shake that cannot be compensated for by the camera tends to occur. In such cases, turn off the Super SteadyShot function and use something to stabilize the camera, such as a tripod.

Super SteadyShot function

- 1 Make sure that the  (Super SteadyShot) switch is set to ON to activate the function.
- 2 Press the shutter button halfway down, and then press it fully down.

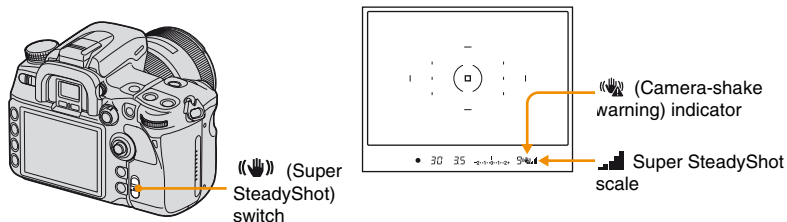

Super SteadyShot scale

This scale is displayed whenever the Super SteadyShot function is activated. A higher scale indicates more pronounced camera-shake (on a scale of five).

When the Super SteadyShot function is deactivated, the scale will not be displayed.

(Camera-shake warning) indicator

This indicator flashes regardless of the status of the Super SteadyShot function. It indicates the likelihood of camera-shake calculated from the shutter speed and focal length. If the indicator flashes, reduce the camera-shake by setting the  (Super SteadyShot) switch to ON or using the built-in flash or a tripod.

- The Super SteadyShot function may not work optimally when the power has just been turned on, when the subject has just entered the frame, or when the shutter button has been pressed all the way down without stopping halfway. Wait for the Super SteadyShot scale to go down, and then press the shutter button down slowly.
- Since the Super SteadyShot function is less effective in the following cases, mount the camera on a tripod.
 - Shooting a subject that is located within a very close range.
 - Shooting a moving subject
 - Shooting with shutter speeds of 1/4 second or longer, which are typically used in night-time shooting.
- When using a tripod, deactivate the Super SteadyShot function as it will not be fully effective.
- This Super SteadyShot function can reduce the effect of camera-shake by the equivalent of approximately 2.5 to 4 increments of shutter speed.

Focus

Within the focus area, there are 11 sensors to lock the focus on the subject.

Press the shutter button halfway down, and the sensor in the focused area illuminated briefly in red to indicate where the focus is.

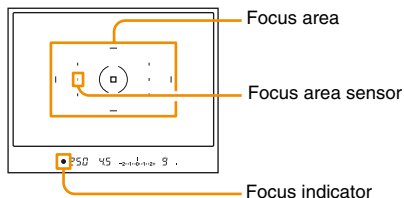

Focus indicator

Holding the grip and looking into the viewfinder or pressing the shutter button halfway down triggers the autofocus system. The focus indicator in the viewfinder indicates the status of the autofocus system.

Focus indicator	Status
● lit	Focus locked. Ready to shoot.
⊙ lit	Focus is confirmed. Focal point moves following a moving subject. Ready to shoot.
⊕ lit	Still focusing. You cannot release the shutter.
● flashing	Cannot focus. The shutter is locked. <ul style="list-style-type: none">• If the subject is closer than the minimum shooting distance of the attached lens, the focus cannot be confirmed. Make sure you put enough distance between the subject and the camera.• You can manually release the shutter even when the indicator is flashing. → "User's Guide/Troubleshooting" (page 102)

Using the flash

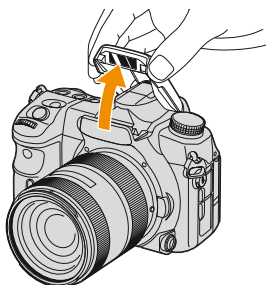

Pull the built-in flash up with your finger. With the flash pulled up, the camera triggers the flash if the amount of light is insufficient in auto adjustment mode (AUTO). Push the flash down with your finger when not using it.

- Do not hold the camera by grabbing the flash emitter.
- If you want to make sure the flash fires without fail, set the flash mode to ⚡ (Fill-flash). → “User’s Guide/Troubleshooting” (page 73)

Flash indicators in the viewfinder

⚡ flashing: The flash is being charged. When the indicator flashes, you cannot release the shutter.

⚡ lit: The flash has been charged and is ready to fire.

The flash range

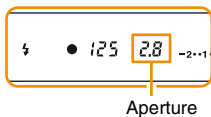

The flash range depends on the aperture value and ISO sensitivity setting. The following chart shows the approximate flash range when the ISO sensitivity is set to [AUTO] in auto adjustment mode (AUTO).

ISO sensitivity → “User’s Guide/Troubleshooting” (page 64)

- The built-in flash is designed to be used with lenses with focal lengths of 16 mm or longer.

Aperture	Flash range
F2.8	2 – 12 m (6.6 – 40 feet)
F4	1.4 – 8.6 m (4.6 – 28 feet)
F5.6	1 – 6 m (3.3 – 20 feet)

Notes on using the built-in flash

When shooting with the built-in flash, the lens may block the flash light and a shadow may appear on the lower part of the image. Be careful about the following:

- Shoot the subject at a distance of 1 m or longer.
- Remove the lens hood.

Adjusting the diopter

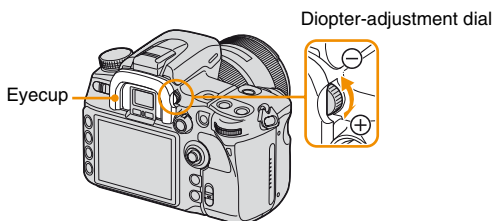

Adjust the diopter-adjustment dial to your eyesight until the indicators appear clearly in the viewfinder.

- Turn the dial toward + when you are far-sighted, toward – when you are near-sighted. The direction is indicated on the dial if you remove the eyecup. → “*User’s Guide/Troubleshooting*” (page 44)
- Training the camera on the light allows you to adjust the diopter easily.

6 View/delete images

To view images

1 Press  (Playback).



2 Select an image with  on the multi-selector.



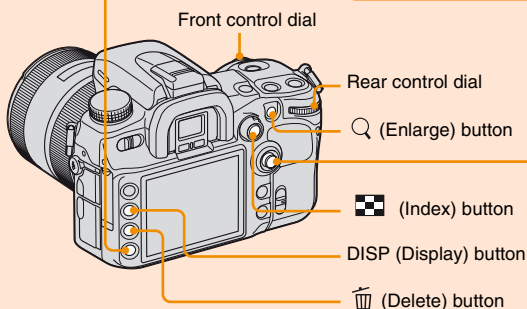

- You can easily view the next/previous image by turning the front or rear control dial.



To return to the recording mode

- Press  (Playback) again.
- Press the shutter button halfway down.

To delete images

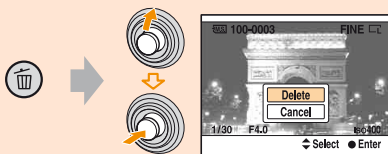

- 1 Display the image you want to delete and press  (Delete).
- 2 Select [Delete] with , then press the center of the multi-selector.



To cancel delete operation

- Select [Cancel], then press the center of the multi-selector.

While viewing images, you can operate the following functions.

- Switching the screen display with the DISP (Display) button.
- Viewing an image list on the index screen with the  (Index) button.
- Enlarging images with the  (Enlarge) button.

→ “User’s Guide/Troubleshooting” (pages 83, 84, 86)