

# SONY®

# Cyber-shot

**Digital Still Camera**

## **Instruction Manual**

**DSC-N2**

GB



CD-ROM  
(supplied)

For details on the advanced operations, please refer to  
**“Cyber-shot Handbook (PDF).”**

### Operating Instructions

Before operating the unit, please read this manual thoroughly, and retain it for future reference.

### Owner's Record

The model and serial numbers are located on the bottom. Record the serial number in the space provided below. Refer to these numbers whenever you call upon your Sony dealer regarding this product.

Model No. DSC-N2

Serial No. \_\_\_\_\_

## WARNING

To reduce fire or shock hazard, do not expose the unit to rain or moisture.

## For Customers in the U.S.A.

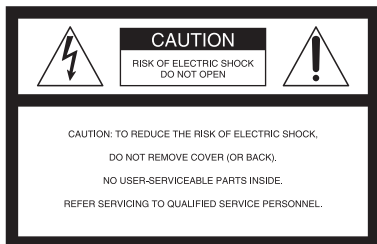

This symbol is intended to alert the user to the presence of uninsulated “dangerous voltage” within the product’s enclosure that may be of sufficient magnitude to constitute a risk of electric shock to persons.



This symbol is intended to alert the user to the presence of important operating and maintenance (servicing) instructions in the literature accompanying the appliance.

# IMPORTANT SAFEGUARDS

For your protection, please read these safety instructions completely before operating the appliance, and keep this manual for future reference.

Carefully observe all warnings, precautions and instructions on the appliance, or the one described in the operating instructions and adhere to them.

## Use

### Power Sources

This set should be operated only from the type of power source indicated on the marking label. If you are not sure of the type of electrical power supplied to your home, consult your dealer or local power company. For those sets designed to operate from battery power, or other sources, refer to the operating instructions.

### Polarization

This set may be equipped with a polarized ac power cord plug (a plug having one blade wider than the other).

This plug will fit into the power outlet only one way. This is a safety feature. If you are unable to insert the plug fully into the outlet, try reversing the plug. If the plug should still fail to fit, contact your electrician to have a suitable outlet installed. Do not defeat the safety purpose of the polarized plug by forcing it in.

### Overloading

Do not overload wall outlets, extension cords or convenience receptacles beyond their capacity, since this can result in fire or electric shock.

### Object and Liquid Entry

Never push objects of any kind into the set through openings as they may touch dangerous voltage points or short out parts that could result in a fire or electric shock. Never spill liquid of any kind on the set.

### Attachments

Do not use attachments not recommended by the manufacturer, as they may cause hazards.

## Cleaning

Unplug the set from the wall outlet before cleaning or polishing it. Do not use liquid cleaners or aerosol cleaners. Use a cloth lightly dampened with water for cleaning the exterior of the set.

## Installation

### Water and Moisture

Do not use power-line operated sets near water – for example, near a bathtub, washbowl, kitchen sink, or laundry tub, in a wet basement, or near a swimming pool, etc.

### Power-Cord Protection

Route the power cord so that it is not likely to be walked on or pinched by items placed upon or against them, paying particular attention to the plugs, receptacles, and the point where the cord exits from the appliance.

### Accessories

Do not place the set on an unstable cart, stand, tripod, bracket, or table. The set may fall, causing serious injury to a child or an adult, and serious damage to the set. Use only a cart, stand, tripod, bracket, or table recommended by the manufacturer.

### Ventilation

The slots and openings in the cabinet are provided for necessary ventilation. To ensure reliable operation of the set, and to protect it from overheating, these slots and openings must never be blocked or covered.

- Never cover the slots and openings with a cloth or other materials.
- Never block the slots and openings by placing the set on a bed, sofa, rug, or other similar surface.
- Never place the set in a confined space, such as a bookcase, or built-in cabinet, unless proper ventilation is provided.
- Do not place the set near or over a radiator or heat register, or where it is exposed to direct sunlight.

### Lightning

For added protection for this set during a lightning storm, or when it is left unattended and unused for

long periods of time, unplug it from the wall outlet and disconnect the antenna or cable system. This will prevent damage to the set due to lightning and power-line surges.

## Service

### Damage Requiring Service

Unplug the set from the wall outlet and refer servicing to qualified service personnel under the following conditions:

- When the power cord or plug is damaged or frayed.
- If liquid has been spilled or objects have fallen into the set.
- If the set has been exposed to rain or water.
- If the set has been subject to excessive shock by being dropped, or the cabinet has been damaged.
- If the set does not operate normally when following the operating instructions. Adjust only those controls that are specified in the operating instructions. Improper adjustment of other controls may result in damage and will often require extensive work by a qualified technician to restore the set to normal operation.
- When the set exhibits a distinct change in performance – this indicates a need for service.

### Servicing

Do not attempt to service the set yourself as opening or removing covers may expose you to dangerous voltage or other hazards.

Refer all servicing to qualified service personnel.

### Replacement parts

When replacement parts are required, be sure the service technician has used replacement parts specified by the manufacturer that have the same characteristics as the original parts.

Unauthorized substitutions may result in fire, electric shock, or other hazards.

### Safety Check

Upon completion of any service or repairs to the set, ask the service technician to perform routine safety checks (as specified by the manufacturer) to determine that the set is in safe operating condition.

## Read this first

### CAUTION

Replace the battery with the specified type only. Otherwise, fire or injury may result.

### For Customers in the U.S.A. and Canada

#### RECYCLING LITHIUM-ION BATTERIES

Lithium-Ion batteries are recyclable.

You can help preserve our environment by returning your used rechargeable batteries to the collection and recycling location nearest you.



For more information regarding recycling of rechargeable batteries, call toll free 1-800-822-8837, or visit <http://www.rbrc.org/>

**Caution:** Do not handle damaged or leaking Lithium-Ion batteries

### For the State of California, USA only

Perchlorate Material - special handling may apply, See

[www.dtsc.ca.gov/hazardouswaste/perchlorate](http://www.dtsc.ca.gov/hazardouswaste/perchlorate)

Perchlorate Material : Lithium battery contains perchlorate.

### For Customers in the U.S.A.

If you have any questions about this product, you may call:

Sony Customer Information Center  
1-800-222-SONY (7669)

The number below is for the FCC related matters only.

#### Regulatory Information

##### Declaration of Conformity

Trade Name: SONY

Model No.: DSC-N2

Responsible Party: Sony Electronics Inc.

Address: 16530 Via Esprillo,  
San Diego, CA 92127 U.S.A.

Telephone No.: 858-942-2230

This device complies with Part 15 of the FCC Rules. Operation is subject to the following two conditions: (1) This device may not cause harmful interference, and (2) this device must accept any interference received, including interference that may cause undesired operation.

#### CAUTION

You are cautioned that any changes or modifications not expressly approved in this manual could void your authority to operate this equipment.

The power unit is intended to be correctly orientated in a vertical or floor mount position.

## Note:

This equipment has been tested and found to comply with the limits for a Class B digital device, pursuant to Part 15 of the FCC Rules. These limits are designed to provide reasonable protection against harmful interference in a residential installation. This equipment generates, uses, and can radiate radio frequency energy and, if not installed and used in accordance with the instructions, may cause harmful interference to radio communications. However, there is no guarantee that interference will not occur in a particular installation. If this equipment does cause harmful interference to radio or television reception, which can be determined by turning the equipment off and on, the user is encouraged to try to correct the interference by one or more of the following measures:

- Reorient or relocate the receiving antenna.
- Increase the separation between the equipment and receiver.
- Connect the equipment into an outlet on a circuit different from that to which the receiver is connected.
- Consult the dealer or an experienced radio/TV technician for help.

The supplied interface cable must be used with the equipment in order to comply with the limits for a digital device pursuant to Subpart B of Part 15 of FCC Rules.

## For Customers in Europe

This product has been tested and found compliant with the limits set out in the EMC Directive for using connection cables shorter than 3 meters (9.8 feet).

## Attention

The electromagnetic fields at the specific frequencies may influence the picture and sound of this unit.

## Notice

If static electricity or electromagnetism causes data transfer to discontinue midway (fail), restart the application or disconnect and connect the communication cable (USB, etc.) again.

## Disposal of Old Electrical & Electronic Equipment (Applicable in the European Union and other European countries with separate collection systems)



This symbol on the product or on its packaging indicates that this product shall not be treated as household waste. Instead it shall be handed over to the applicable collection point for the recycling of electrical and electronic equipment. By ensuring this product is disposed of correctly, you will help prevent potential negative consequences for the environment and human health, which could otherwise be caused by inappropriate waste handling of this product. The recycling of materials will help to conserve natural resources. For more detailed information about recycling of this product, please contact your local Civic Office, your household waste disposal service or the shop where you purchased the product.

## Notice for customers in the United Kingdom

A moulded plug complying with BS 1363 is fitted to this equipment for your safety and convenience. Should the fuse in the plug supplied need to be replaced, a fuse of the same rating as the supplied one and approved by ASTA or BSI to BS 1362, (i.e., marked with an ⚡ or ⚡ mark) must be used.

If the plug supplied with this equipment has a detachable fuse cover, be sure to attach the fuse cover after you change the fuse. Never use the plug without the fuse cover. If you should lose the fuse cover, please contact your nearest Sony service station.

---

## Notes on using your camera

### Internal memory and “Memory Stick Duo” back up

Do not turn off the camera or remove the battery pack or “Memory Stick Duo” while the access lamp is lighted, as the internal memory data or “Memory Stick Duo” data may be destroyed. Always protect your data by making a back up copy.

### Notes on recording/playback

- This camera is neither dust-proof, nor splash-proof, nor water-proof. Read “Precautions” (page 30) before operating the camera.
- Before you record one-time events, make a trial recording to make sure that the camera is working correctly.
- Be careful not to get the camera wet. Water entering the inside of the camera may cause malfunctions which in some cases may not be repairable.
- Do not aim the camera at the sun or other bright light. It may cause the malfunction of your camera.
- Do not use the camera near a location that generates strong radio waves or emits radiation. The camera may not be able to record or playback properly.
- Using the camera in sandy or dusty locations may cause malfunctions.
- If moisture condensation occurs, remove it before using the camera (page 30).
- Do not shake or strike the camera. In addition to malfunctions and an inability to record images, this may render the recording medium unusable, or cause image data breakdown, damage or loss.
- Clean the flash surface before use. The heat of flash emission may cause dirt on the flash surface to become discolored or to stick to the flash surface, resulting in insufficient light emission.

### Notes on the LCD screen and lens

- The LCD screen is manufactured using extremely high-precision technology so over 99.99% of the pixels are operational for effective use. However, there may be some tiny black points and/or bright points (white, red, blue or green in color) that constantly appear on the LCD screen. These points are normal in the manufacturing process and do not affect the recording in any way.
- The camera will not function with the lens portion extended when the battery pack is discharged. Insert a charged battery pack, then turn on the camera again.

### On image data compatibility

- This camera conforms with DCF (Design rule for Camera File system) universal standard established by JEITA (Japan Electronics and Information Technology Industries Association).
- Playback of images recorded with your camera on other equipment and playback of images recorded or edited with other equipment on your camera are not guaranteed.

### Warning on copyright

Television programs, films, videotapes, and other materials may be copyrighted. Unauthorized recording of such materials may be contrary to the provisions of the copyright laws.

### No compensation for contents of the recording

The contents of the recording cannot be compensated for if recording or playback is not possible due to a malfunction of your camera or recording media, etc.

# Table of contents

IMPORTANT SAFEGUARDS .....	2
Read this first .....	4
Notes on using your camera .....	6
<b>Getting started .....</b>	<b>8</b>
Checking the accessories supplied .....	8
1 Preparing the battery pack .....	9
2 Inserting the battery pack/a "Memory Stick Duo" (not supplied) .....	10
3 Operating the touch panel .....	11
4 Turning the camera on/setting the clock .....	12
<b>Shooting images easily .....</b>	<b>13</b>
<b>Viewing/deleting images .....</b>	<b>16</b>
<b>Indicators on the screen .....</b>	<b>18</b>
<b>Changing the settings – Menu/Setup .....</b>	<b>20</b>
Menu items .....	21
Setup items .....	22
<b>Enjoying your computer .....</b>	<b>24</b>
Supported Operating Systems for USB connection and application software (supplied) .....	24
Viewing "Cyber-shot Handbook" .....	24
<b>Battery life and memory capacity .....</b>	<b>25</b>
Battery life and number of images that can be recorded/viewed .....	25
Number of still images and recording time of movies .....	26
<b>Troubleshooting .....</b>	<b>28</b>
Battery pack and power .....	28
Shooting still images/movies .....	29
Viewing images .....	29
<b>Precautions .....</b>	<b>30</b>
<b>Specifications .....</b>	<b>31</b>

# Getting started

## Checking the accessories supplied

- Battery charger BC-CSG/BC-CSGB (1)

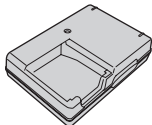

- Power cord (mains lead) (1)  
(not supplied in the USA and Canada)



- Rechargeable battery pack NP-BG1 (1)/  
Battery case (1)

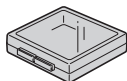
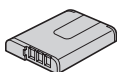

- Paint pen (1)

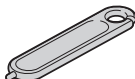

- USB, A/V, DC IN cable for multi-use terminal  
(1)

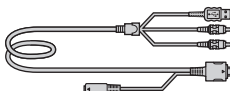

- Wrist strap (1)



- CD-ROM (Cyber-shot application software/  
“Cyber-shot Handbook”) (1)
- Instruction Manual (this manual) (1)

### About the paint pen

- You can paint or put stamps on still images with the paint pen.
- Attach the paint pen to the wrist strap (shown right).
- Do not carry the camera by holding the paint pen. The camera may fall off.

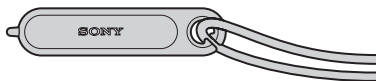

Attach the strap to prevent the camera from damage by being dropped, etc.

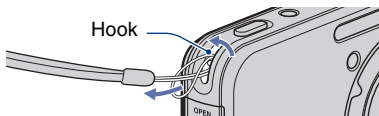



# 1 Preparing the battery pack

For customers in the USA and Canada

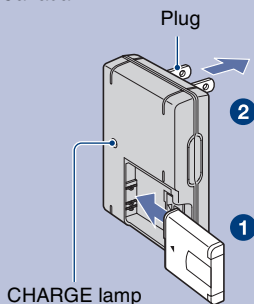

For customers other than those in the USA and Canada

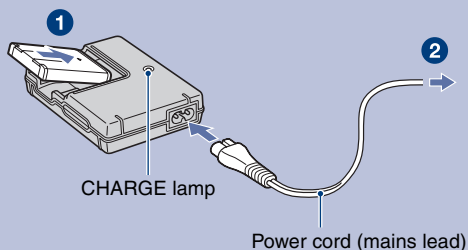

**1** Insert the battery pack into the battery charger.

**2** Connect the battery charger to the wall outlet (wall socket).

The CHARGE lamp lights on, and charging starts.

When the CHARGE lamp turns off, charging is finished (Practical charge).

If you continue charging the battery pack for about one more hour (until it is fully charged), the charge will last slightly longer.

## Charging time

Full charge time	Practical charge time
Approx. 330 min.	Approx. 270 min.

- Time required to charge a fully depleted battery pack at a temperature of 25°C (77°F). Charging may take longer under certain circumstances or conditions.
- Connect the battery charger to an easily accessible wall outlet (wall socket) close by.
- Even if the CHARGE lamp is not lit, the battery charger is not disconnected from the AC power source (mains) as long as it is connected to the wall outlet (wall socket). If some trouble occurs while using the battery charger, immediately shut off the power by disconnecting the plug from the wall outlet (wall socket).
- When charging is finished, disconnect the power cord (mains lead) from the wall outlet (wall socket), and remove the battery pack from the battery charger.
- Designed for use with compatible Sony batteries.

## 2 Inserting the battery pack/a “Memory Stick Duo” (not supplied)

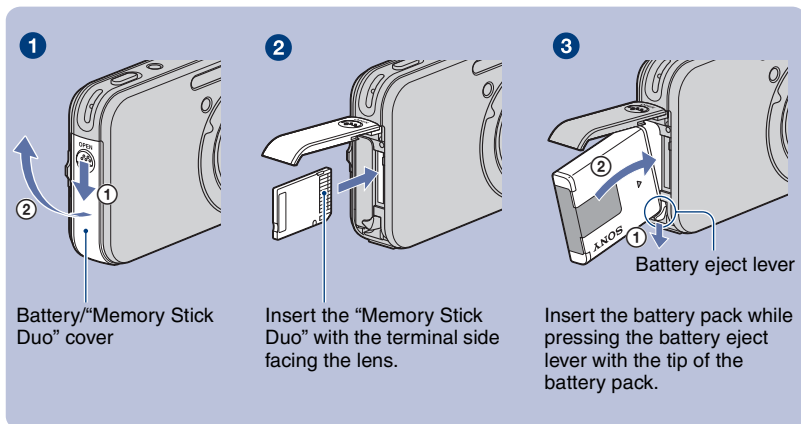

- 1 Open the battery/“Memory Stick Duo” cover.
- 2 Insert the “Memory Stick Duo” (not supplied) all the way in until it clicks.
- 3 Insert the battery pack in the correct direction.
- 4 Close the battery/“Memory Stick Duo” cover.

### When there is no “Memory Stick Duo” inserted

The camera records/plays back images using the internal memory (approx. 25 MB).

### To check the remaining battery time

Press POWER button to turn on and check the remaining battery on the LCD screen.

<b>Battery remaining indicator</b>				
<b>Battery remaining guidelines</b>	Sufficient power remaining	Battery half full	Battery low, recording/playback will stop soon.	Change the battery with fully charged one, or charge the battery. (The warning indicator flashes.)

- It takes about one minute until the correct battery remaining indicator appears.
- The displayed battery remaining indicator may not be correct under certain circumstances.
- The Clock Set screen appears when the camera is turned on for the first time (page 12).

## To remove the battery pack/“Memory Stick Duo”

Open the battery/“Memory Stick Duo” cover.

### “Memory Stick Duo”

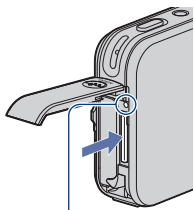

Make sure that **the access lamp** is not lit, then push the “Memory Stick Duo” in once.

### Battery pack

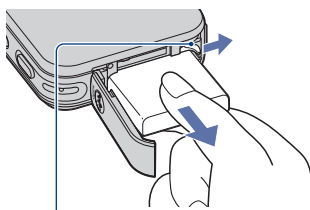

Slide **the battery eject lever**.

- Be sure not to drop the battery pack.
- Never remove the battery pack when the access lamp is lit.



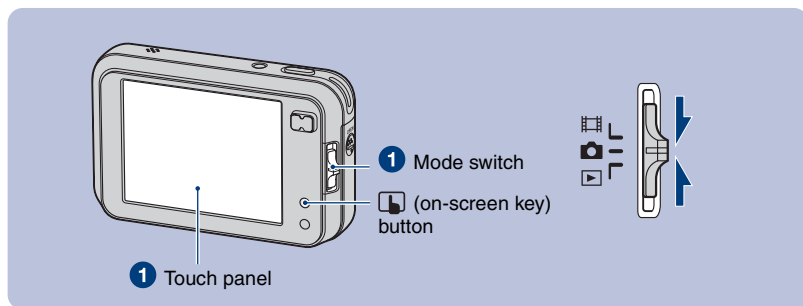

## 3 Operating the touch panel



### 1 Press (on-screen key) to display the touch panel buttons.

- When the mode switch is set to , skip this operation.

### 2 Lightly touch the buttons on the screen with your finger.

- Press  (on-screen key) again to turn off the touch panel buttons.
- When the item you want to set is not on the screen, touch / to change the page.
- You can return to the previous screen by touching .

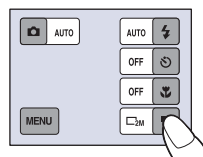

## 4 Turning the camera on/setting the clock

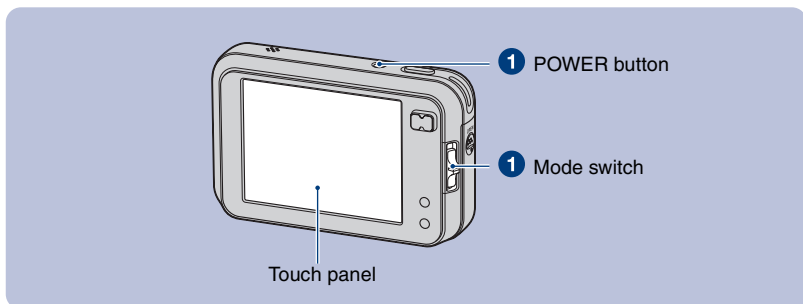

**1** Select with the mode switch, then press the POWER button.

**2** Set the clock by touching the buttons on the screen.

- 1 Touch the desired date display format, then →. The Clock Set 2/2 screen appears.
- 2 Touch the item to be set, then set the numeric value with ▲/▼.
- 3 Touch [OK].

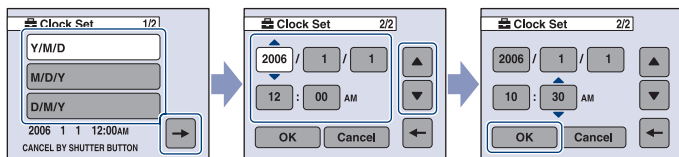

### To change the date and time

Select [Clock Set] in the (Setup) screen (page 20).

### When you turn on the power

- Unless you set the clock, the Clock Set screen appears each time the camera is turned on.
- If the camera is running on battery power and you do not operate the camera for about three minutes, the camera turns off automatically to prevent wearing down the battery pack (Auto power-off function).

# Shooting images easily

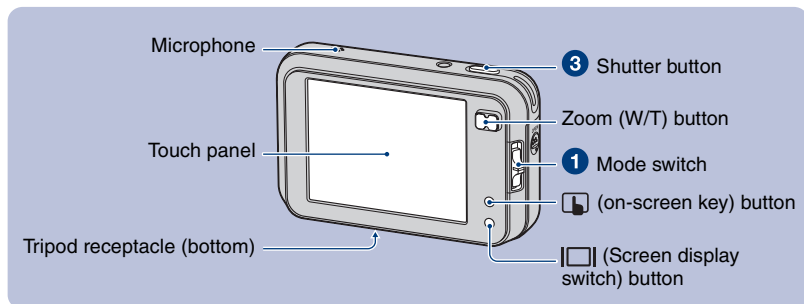

## 1 Select a mode with the mode switch.

**Still image:** Select .

**Movie:** Select .

## 2 Hold the camera steadily, keeping your arms at your side.

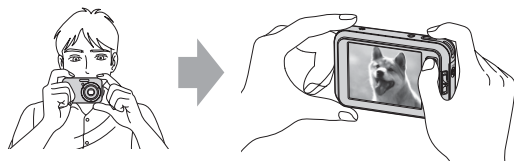

Position the subject in the center of the focus frame. Do not cover the microphone with your finger.

## 3 Shoot with the shutter button.

When shooting images during  displayed on the screen, those minimized copies of the original images can be saved in the Album.

**Still image:**

**1** Press and hold the shutter button halfway down to focus.

The ● (AE/AF lock) indicator (green) flashes, a beep sounds, the indicator stops flashing and remains lit.

**2** Press the shutter button fully down.

AE/AF lock indicator



**Movie:**

Press the shutter button fully down.

To stop recording, press the shutter button fully down again.



## Using the zoom

Press the zoom button.

- When the zoom scale exceeds 3x, the camera uses the Digital Zoom function.
- You cannot change the zoom scale while shooting a movie.

To select the following functions, press the  (on-screen key).

## Flash (Selecting a flash mode for still images)

Touch  on the screen. Touch the desired item, then .

Auto: Flash Auto

Strobes when there is insufficient light or backlight (default setting)



Forcedflash (): Flash forced on

Slow Synchro (): Flash forced on

The shutter speed is slow in a dark place to clearly shoot the background that is out of flash light.

No flash (): Flash forced off

## Using the self-timer

Touch  on the screen. Touch the desired item, then .



10 sec (): Setting the 10-second delay self-timer

2 sec (): Setting the 2-second delay self-timer

Off: Not using the self-timer



Press the shutter button, the self-timer lamp flashes, and a beep sounds until the shutter operates.

## Macro (Shooting close-up)









Touch  on the screen. Touch [On], then .

On (): Macro on (W side: Approx. 6 cm or farther (2 3/8 inches or farther), T side: Approx. 34 cm or farther (13 3/8 inches or farther))  
Off: Macro off

## Changing the image size



Touch  on the screen. Touch the desired item, then .

Still images



Image size	Guidelines
 10M : 10M	For storing important images or printing A3/A3+* size or fine A4 size images
 3:2 : 3:2	Match 3:2 Aspect Ratio
 8M : 8M	Up to A3/11x17" print
 5M : 5M	Up to A4/8x10" print
 3M : 3M	Up to 13x18cm /5x7" print
 2M : 2M	Up to 10x15cm /4x6" print
 VGA : VGA(E-Mail)	For E-mail
 16:9 : 16:9(HDTV)	Display On 16:9 HDTV

\* This is a size larger than A3 size. You can print images with a margin around the A3 size image.

Movies

Image size	Guidelines
 640(Fine)	Display on TV (high quality)
 640(Standard)	Display on TV (standard)
 160 : 160	For E-mail

## 📷 Selecting the still image shooting mode

Touch  on the screen. Touch the desired item, then .

Auto:

Allows easy shooting with the settings adjusted automatically.

Program:

Allows you to shoot with the exposure adjusted automatically (both the shutter speed and the aperture value). Also you can select various settings using the menu.



Manual:

Allows you to shoot with the exposure adjusted manually (both the shutter speed and the aperture value).

Scene Selection:

Allows you to shoot with preset settings according to the scene.

## 🔧 Adjusting the exposure manually





Set  (Camera) to a setting other than [Auto] and [Manual], then touch . Touch  (EV).

Toward +: Brightens an image.

0EV: The exposure is determined automatically by the camera.

Toward -: Darkens an image.

## 👁️ Changing the focus method

Set  (Camera) to a setting other than [Auto], then touch . Touch  (Focus). Touch the desired item, then .

Multi AF (Multipoint AF):

Focuses automatically on a subject in all ranges of the finder frame (default setting).

Center AF:

Focuses automatically on a subject in the center of the finder frame.

Spot AF (Flexible Spot AF):

By moving the AF range finder frame to wherever you like on the screen, you can focus on an extremely small subject or a narrow area.

## 🎞️ On the recordable number of still images and recordable time of movies

Recordable number of still images and recordable time of movies vary depending on the selected image size.

Still images

Maximum number of recordable images



Movies

Maximum recordable time

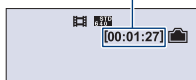

- The number of recordable images and time can differ according to shooting conditions.

# Viewing/deleting images

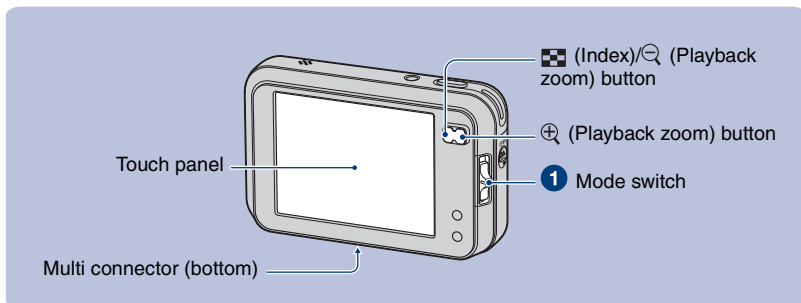

1 Select with the mode switch.

2 Select an image with / .

**Movie:**

Touch .

Rewind/Fast forward: /

(Return to normal playback: )

Volume: Touch [MENU] → [Volume] → +/- to adjust → [Exit].

Stop playback:

## To delete images

Display the image you want to delete, then touch [MENU] → [Delete] → [Delete] → [OK].

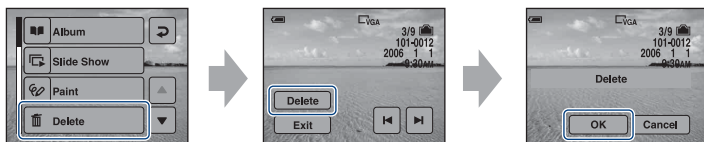

• Even when you delete an image, the minimized image recorded in the Album is still saved.

## To view an enlarged image (playback zoom)

Press while displaying a still image.

To undo the zoom, press .

Adjust the portion: / / /





Cancel playback zoom



## Viewing an index screen

Press  (Index). Touch the image you want to view on the single-image screen.

To display the previous/next screen, touch .

If you press  (Index) again, the 12-image index screen appears.

## To delete images in index mode

1 While an index screen is displayed, touch [MENU] → [Delete] → [Select].

2 Touch the image you want to delete to display the  (Delete) indicator.

3 Touch [OK] → [OK].

## To play back images stored in the Album

1 Set the mode switch to .

2 Touch [MENU] → [Album].

## To play back a series of images (Slide Show)

1 Set the mode switch to .

2 Touch [MENU] → [Slide Show] → [Start].

• To cancel, touch the screen, then [Exit].

## To paint or put stamps on still images

1 Set the mode switch to .

2 Touch [MENU] → [Paint].

3 Paint or put stamps on still images with paint pen.

## To view images on TV screen

1 Connect the camera to the TV with the cable for multi-use terminal (supplied).

2 Set the switch on the cable for multi-use terminal to "TV."

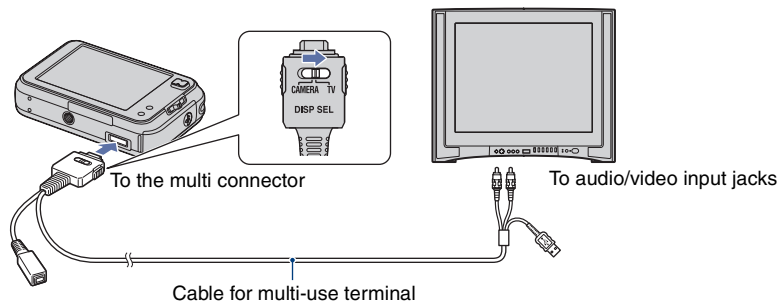

# Indicators on the screen

Each time you press the  (Screen display switch) button, the display changes.

## When shooting still images

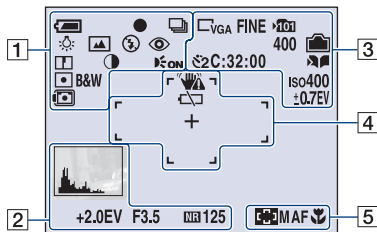

## When shooting movies

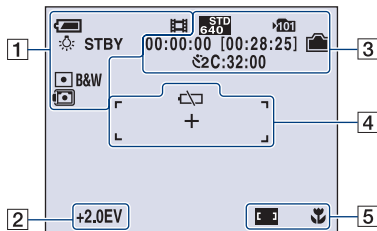



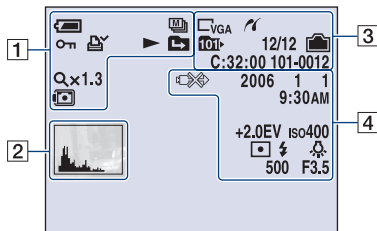



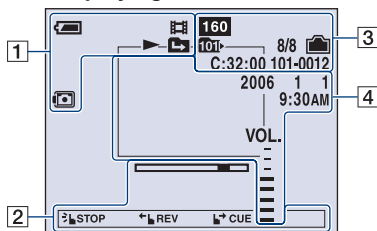













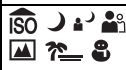









## When playing back still images









## When playing back movies























1

	Battery remaining
	AE/AF lock
 BRK 	Recording mode
  	White balance
  	White balance
STBY REC	Standby/Recording a movie
	Camera mode (Scene Selection)
P M	Camera mode (Program/Manual)
 	Flash mode
	Flash charging
W  T	Zoom scaling
x1.3  	Zoom scaling
	Red-eye reduction
	Sharpness
	Contrast
	AF illuminator
 	Metering mode
VIVID NATURAL SEPIA B&W	Color mode
	Protect
	Print order (DPOF) mark
	Playback
  	Change folder
Qx1.3	Zoom scaling
Step 12/16	Frame by frame playback
	Housing mode

2











	<b>Histogram</b> <ul style="list-style-type: none"> <li>During playback,  appears when histogram display is disabled.</li> </ul>
	NR slow shutter
125	Shutter speed
F3.5	Aperture value
+2.0EV	Exposure Value
	Playback bar
 STOP  REV  CUE	Control guide

3





 10M  3:2  8M  5M  3M  2M  1M  VGA  16:9  FINE 640  STD 640  160	Image size
	PictBridge connecting
FINE STD	Image quality
	Recording folder
	Playback folder
	Remaining internal memory capacity
	Remaining "Memory Stick" capacity
	Album
	Album playback
00:00:00 [00:28:05]	Recording time [maximum recordable time]
1/30"	Multi Burst interval
400	Remaining number of recordable images
 	Self-timer
C:32:00	Self-diagnosis display
iso400	ISO number
±0.7EV	Bracket Step value
101-0012	Folder-file number

8/8 12/12	Image number/Number of images recorded in selected folder
00:00:12	Counter

4

	Vibration warning
	Low battery warning
	PictBridge connecting
+2.0EV	Exposure Value
iso400	ISO number
	Metering mode
	Flash
AWB  	White balance
	Spot metering cross hair
+	AF range finder frame
	
500	Shutter speed
F3.5	Aperture value
	Playback image
2006 1 1 9:30 AM	Recorded date/time of the playback image
VOL. - - - - - - -	Volume

5

	Macro
S AF M AF	AF mode
  	AF range finder frame indicator
1.0m	Focus preset distance

# Changing the settings – Menu/Setup

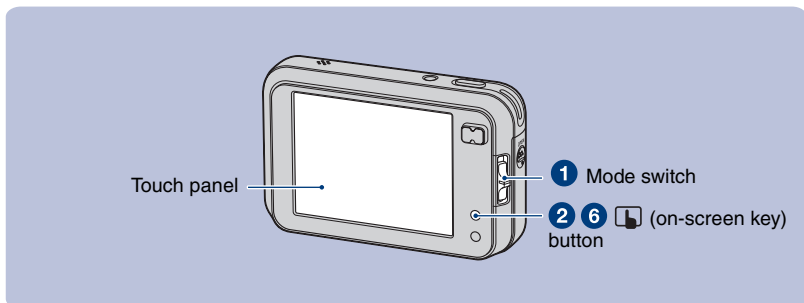

## 1 Set the mode switch.

Different items are available depending on the position of the mode switch and the (Camera) menu settings.

## 2 Press (on-screen key) to display the touch panel buttons.

• When the mode switch is set to , skip this operation.

## 3 Touch [MENU] to display the menu.

## 4 Touch the item you want to set.

• If the desired item is not visible, touch / until the item appears on the screen.

## 5 Touch the setting.

## 6 Press (on-screen key) to turn off the menu.

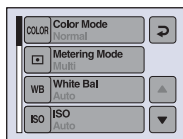

## To select a Setup item

Press (on-screen key) longer or display (Setup) in step 4, then touch it.







Touch / to display the item you want to set, then touch it.

















## Menu items

The available menu items vary depending on the mode switch position and the  (Camera) menu settings. Only the available items are displayed on the screen.

### Menu for shooting

COLOR (Color Mode)	Changes the vividness of the image or adds special effects.
 (Metering Mode)	Selects the metering mode.
WB (White Bal)	Adjusts the color tones.
ISO	Selects a luminous sensitivity.
 (P.Quality)	Selects the still image quality.
Mode (REC Mode)	Selects the continuous shooting method.
BRK (Bracket Step)	Shifts the EV when [Mode] is set to [Exp Brktg].
 (Interval)	Selects the frame interval when [Mode] is set to [Multi Burst].
 (Flash Level)	Adjusts the amount of flash light.
 (Contrast)	Adjusts the contrast of the image.
 (Sharpness)	Adjusts the sharpness of the image.
 (Setup)	Changes Setup items.

## Menu for viewing

 (Album)	Displays the still images in the Album.
 (Exit Album)	Finishes playing back of images in the Album.
 (Slide Show)	Plays back a series of images.
 (Paint)	Paints on the still images.
 (Delete)	Deletes images.
 (Volume)	Adjusts the volume.
 (Folder)	Selects the folder for viewing images.
 (Protect)	Prevents accidental erasure.
DPOF	Adds a Print order mark.
 (Print)	Prints images using a PictBridge compliant printer.
 (Resize)	Changes the image size of a recorded image.
 (Rotate)	Rotates a still image.
 (Divide)	Cuts movies.
 (Setup)	Changes Setup items.
 (Trimming)	Records an enlarged image. (Available only for playback zoom.)

## Setup items

### Camera 1

AF Mode	Selects the auto focus operation mode.
Digital Zoom	Selects the digital zoom mode.
Red Eye Reduction	Reduces the red-eye phenomenon when using the flash.
AF Illuminator	Supplies fill light to focus more easily on a subject in dark surroundings.

### Camera 2

Auto Review	Displays the recorded image on the screen for approximately two seconds immediately after shooting a still image.
-------------	---

### Internal Memory

Format	Formats the internal memory.
--------	------------------------------

 **Memory Stick**

Format	Formats the "Memory Stick Duo".
Create REC. Folder	Creates a folder in a "Memory Stick Duo" for recording images.
Change REC. Folder	Changes the folder currently used for recording images.
Copy	Copies all images in the internal memory to a "Memory Stick Duo".

 **Album**

Write in Album	Chooses to save minimized copies of the original images.
Format	Formats the Album.
Check Album	Repairs the image data in the Album, when "Album data error" appears on the screen.

 **Setup 1**

Download Music	Downloads the music to be played for the Slide show.
Format Music	Erases all the Music files.

 **Setup 2**

LCD Backlight	Selects the brightness of the LCD backlight when using the camera with battery pack.
Beep	Selects the sound produced when you operate the camera.
 Language	Selects the language to be used to display the menu items, warnings, and messages.
Initialize	Initializes the setting to the default setting.

 **Setup 3**

File Number	Selects the method used to assign file numbers to images.
USB Connect	Selects the USB mode to be used when connecting the camera to a computer or a PictBridge compliant printer using the cable for multi-use terminal.
Video Out	Sets the video signal output according to the TV color system of the connected video equipment.
Clock Set	Sets the date and time.

 **Setup 4**

Calibration	Enables you to perform calibration when the touch panel buttons do not react at the appropriate points where you touch.
Housing	Changes the function of some buttons to operate the camera installed in the Marine Pack.

# Enjoying your computer

You can display images shot with the camera on the computer. Also, you can use still images and movies from the camera more than ever by taking advantage of the software. For details, refer to “Cyber-shot Handbook.”

## Supported Operating Systems for USB connection and application software (supplied)

	For Windows users	For Macintosh users
USB connection	Windows Millennium Edition, Windows 2000 Professional, Windows XP Home Edition or Windows XP Professional	Mac OS 9.1/9.2/ Mac OS X(v10.1 to v10.4)
Application software “Picture Motion Browser”	Windows Millennium Edition, Windows 2000 Professional, Windows XP Home Edition or Windows XP Professional	Not compatible

- Must be installed with above OS at delivery.
- If your OS does not support USB connections, use a Memory Stick Reader/Writer (not supplied).
- For further details on the operating environment of Cyber-shot application software “Picture Motion Browser,” refer to “Cyber-shot Handbook.”

## Viewing “Cyber-shot Handbook”

### For Windows users

- 1 Turn on your computer, and insert the CD-ROM (supplied) into the CD-ROM drive. The screen below appears.



When you click the [Cyber-shot Handbook] button, the screen for copying “Cyber-shot Handbook” appears. Follow the on-screen instructions to copy.

- 2 After the installation is complete, double-click the shortcut created on the desktop.

### For Macintosh users

- 1 Turn on your computer, and insert the CD-ROM (supplied) into the CD-ROM drive. Select the “Handbook” folder and copy “Handbook.pdf” stored in the “GB” folder to your computer.
- 2 After copying is complete, double-click “Handbook.pdf.”



# Battery life and memory capacity

## Battery life and number of images that can be recorded/viewed

The tables show the approximate number of images that can be recorded/viewed and the battery life when you shoot images in [Normal] mode with the battery pack (supplied) at full capacity and at an ambient temperature of 25°C (77°F). The numbers of images that can be recorded or viewed take into account changing the “Memory Stick Duo” as necessary.

Note that the actual numbers may be less than those indicated in the table depending on the conditions of use.

- Battery capacity decreases as you use it more, as the time passes.
- The number of images that can be recorded/viewed and the battery life are decreased under the following conditions:
  - The surrounding temperature is low.
  - The flash is used frequently.
  - The camera has been turned on and off many times.
  - The zoom is used frequently.
  - The brightness of LCD Backlight is set to up.
  - [AF Mode] is set to [Monitor].
  - The battery power is low.

### When shooting still images

No. of images	Battery life (min.)
Approx. 300	Approx. 150

- Shooting in the following situations:
  -  (P.Quality) is set to [Fine].
  - [AF Mode] is set to [Single].
  - Shooting once every 30 seconds.
  - The zoom is switched alternately between the W and T ends.
  - The flash strobes once every two times.
  - The power turns on and off once every ten times.
- The measurement method is based on the CIPA standard.  
(CIPA: Camera & Imaging Products Association)
- The number of shooting images/battery life does not change, regardless of image size.

### When viewing still images

No. of images	Battery life (min.)
Approx. 6000	Approx. 300

- Viewing single images in order at about three second intervals

### When shooting movies

Battery life (min.)
Approx. 140

- Shooting movies continuously with an image size of [160]

## Number of still images and recording time of movies

The number of still images and the length of time for movies may vary depending on the shooting conditions.

- For image size, see page 14.

**I The approximate number of still images (The image quality is [Fine] on the upper line and [Standard] on the lower line.)**

(Units: Images)

Capacity Size	Internal memory	"Memory Stick Duo" formatted with this camera					
	Approx. 25MB	64MB	128MB	256MB	512MB	1GB	2GB
10M	5	12	25	46	94	192	394
	10	25	51	92	188	384	789
3:2	5	12	25	46	94	192	394
	10	25	51	92	188	384	789
8M	6	16	32	59	121	247	506
	12	30	60	109	223	456	934
5M	10	25	51	92	188	384	789
	19	48	96	174	354	723	1482
3M	16	41	82	148	302	617	1266
	29	74	149	264	537	1097	2250
2M	26	66	133	238	484	988	2025
	49	123	246	446	907	1852	3798
VGA(E-Mail)	158	394	790	1428	2904	5928	12154
	397	985	1975	3571	7261	14821	30385
16:9(HDTV)	26	66	133	238	484	988	2025
	49	123	246	446	907	1852	3798

- The number of images listed is for when [Mode] is set to [Normal].
- When the number of remaining shootable images is greater than 9,999, the ">9999" indicator appears.
- You can resize the images later ([Resize], page 22).

## The approximate recording time of movies

(Units: hour : minute : second)

Capacity Size	Internal memory	"Memory Stick Duo" formatted with this camera					
	Approx. 25MB	64MB	128MB	256MB	512MB	1GB	2GB
640(Fine)	–	–	–	0:02:50	0:06:00	0:12:20	0:25:10
640(Standard)	0:01:10	0:02:50	0:05:50	0:10:40	0:21:40	0:44:20	1:31:00
160	0:18:50	0:45:30	1:31:30	2:51:20	5:47:00	11:44:20	24:18:20

- Movies with the size set to [640(Fine)] can only be recorded on a "Memory Stick PRO Duo".
- When images recorded using earlier Sony models are played back on this camera, the display may differ from the actual image size.

# Troubleshooting

If you experience trouble with your camera, try the following solutions.

- 1 Check the items below, and refer to “Cyber-shot Handbook (PDF).”**  
If a code such as “C/E:□□:□□” appears on the screen, refer to “Cyber-shot Handbook.”

- 2 Remove the battery pack, and insert the battery pack again after about one minute, and turn on the power.**

- 3 Initialize the settings (page 23).**

- 4 Consult your Sony dealer or local authorized Sony service facility.**

Please understand that you give your consent that the contents of the internal memory, Music files may be checked when you send your camera to be repaired.

## Battery pack and power

### The battery pack cannot be installed.

- Install the battery pack correctly using the tip of the battery pack to push the battery eject lever (page 10).

### Cannot turn on the camera.

- Install the battery pack correctly (page 10).
- The battery pack is discharged. Install the charged battery pack (page 9).
- The battery pack is dead. Replace it with a new one.
- Use a recommended battery pack (page 8).

### The power turns off suddenly.

- If you do not operate the camera for about three minutes while the power is on, the camera turns off automatically to prevent wearing down the battery pack. Turn on the camera again (page 12).
- The battery pack is dead. Replace it with a new one.



---

### The battery remaining indicator is incorrect.

- This phenomenon occurs when you use the camera in an extremely hot or cold location.
- The displayed battery remaining differs from the current one. Fully discharge and then charge the battery pack to correct the display.
- The battery pack is discharged. Install the charged battery pack (page 9).
- The battery pack is dead. Replace it with a new one.

## Shooting still images/movies

### Your camera cannot record images.

- Check the free capacity of the internal memory or “Memory Stick Duo” (pages 26, 27). If it is full, do one of the following:
  - Delete unnecessary images (page 16).
  - Change the “Memory Stick Duo”.
- You are using the “Memory Stick Duo” with the write-protect switch, and the switch is set to the LOCK position. Set the switch to the recording position.
- You cannot record images while charging the flash.
- Set the mode switch to  when shooting still images.
- Set the mode switch to  when shooting movies.
- The image size is set to [640(Fine)] when recording movies. Do one of the following:
  - Set the image size to other than [640(Fine)].
  - Insert a “Memory Stick PRO Duo”.

---

### Cannot insert dates on images.

- This camera does not have a feature for superimposing dates on images. However, you can print images with the date superimposed.

## Viewing images

### Your camera cannot play back images.

- The folder/file name has been changed on your computer.
- When an image file has been processed by a computer or when the image file was recorded using a model other than that of your camera, playback on your camera is not guaranteed.
- The camera is in USB mode. Delete the USB connection.

# Precautions

## Do not use/store the camera in the following places

- In an extremely hot, cold or humid place  
In places such as in a car parked in the sun, the camera body may become deformed and this may cause a malfunction.
- Under direct sunlight or near a heater  
The camera body may become discolored or deformed, and this may cause a malfunction.
- In a location subject to rocking vibration
- Near strong magnetic place
- In sandy or dusty places  
Be careful not to let sand or dust get into the camera. This may cause the camera to malfunction, and in some cases this malfunction cannot be repaired.

## On carrying

Do not sit down in a chair or other place with the camera in the back pocket of your trousers or skirt, as this may cause malfunction or damage the camera.

## On cleaning

### Cleaning the LCD screen

Wipe the screen surface with an LCD cleaning kit (not supplied) to remove fingerprints, dust, etc.

### Cleaning the lens

Wipe the lens with a soft cloth to remove fingerprints, dust, etc.

### Cleaning the camera surface

Clean the camera surface with a soft cloth slightly moistened with water, then wipe the surface with a dry cloth. Do not use the following as they may damage the finish or the casing.

- Chemical products such as thinner, benzene, alcohol, disposable cloths, insect repellent, sunscreen or insecticide, etc.
- Do not touch the camera with the above on your hand.
- Do not leave the camera in contact with rubber or vinyl for a long time.

## On operating temperatures

Your camera is designed for use under the temperatures between 0°C and 40°C (32°F and 104°F). Shooting in extremely cold or hot places that exceed this range is not recommended.

## On moisture condensation

If the camera is brought directly from a cold to a warm location, moisture may condense inside or outside the camera. This moisture condensation may cause a malfunction of the camera.

### If moisture condensation occurs

Turn off the camera and wait about an hour for the moisture to evaporate. Note that if you attempt to shoot with moisture remaining inside the lens, you will be unable to record clear images.

## On the internal rechargeable backup battery

This camera has an internal rechargeable battery for maintaining the date and time and other settings regardless of whether the power is on or off.

This rechargeable battery is continually charged as long as you are using the camera. However, if you use the camera for only short periods, it discharges gradually, and if you do not use the camera at all for about one month it becomes completely discharged. In this case, be sure to charge this rechargeable battery before using the camera.

However, even if this rechargeable battery is not charged, you can still use the camera as long as you do not record the date and time.

### Charging method of the internal rechargeable backup battery

Insert charged battery pack in the camera, or connect the camera to a wall outlet (wall socket) using the AC Adaptor (not supplied), and leave the camera for 24 hours or more with the power off.

# Specifications

## Camera

### [System]

Image device: 9.15 mm (1/1.7 type) color CCD,  
Primary color filter  
Total pixel number of camera:  
Approx. 10 300 000 pixels  
Effective pixel number of camera:  
Approx. 10 054 000 pixels  
Lens: Carl Zeiss Vario-Tessar 3x zoom lens  
 $f = 7.9 - 23.7$  mm (38 - 114 mm when  
converted to a 35 mm still camera) F2.8 - 5.4  
Exposure control: Automatic exposure, Manual  
exposure, Scene Selection (8 modes)  
White balance: Automatic, Daylight, Cloudy,  
Fluorescent, Incandescent, Flash  
File format (DCF compliant):  
Still images: Exif Ver. 2.21 JPEG compliant,  
DPOF compatible  
Movies: MPEG1 compliant (Monaural)  
Recording media: Internal Memory  
(approx. 25 MB), "Memory Stick Duo"  
Flash: Recommended distance (ISO set to Auto):  
Approx. 0.2 to 4.8 m (7/8 inches to  
189 inches) (W)/approx. 0.34 to 2.5 m  
(13 1/2 inches to 98 1/2 inches) (T)

### [Input and Output connectors]

Multi connector  
USB communication: Hi-Speed USB (USB 2.0  
compliant)

### [LCD screen]

LCD panel: 7.5 cm (3.0 type) TFT drive  
Total number of dots: 230 400 (960x240) dots

### [Power, general]

Power: Rechargeable battery pack NP-BG1, 3.6 V  
AC-LS5K AC Adaptor (not supplied), 4.2 V  
Power consumption (during shooting): 1.3 W  
Operating temperature: 0 to 40°C (32 to 104°F)  
Storage temperature: -20 to +60°C (-4 to +140°F)  
Dimensions: 96.7x61.1x22.7 mm (3 7/8x2 1/2x  
29/32 inches) (W/H/D, excluding protrusions)  
Mass: Approx. 185 g (6.5 oz) (including NP-BG1  
battery pack and wrist strap, etc.)  
Microphone: Monaural  
Speaker: Monaural  
Exif Print: Compatible  
PRINT Image Matching III: Compatible  
PictBridge: Compatible

## BC-CSG/BC-CSGB battery charger

Power requirements: AC 100 V to 240 V,  
50/60 Hz, 2 W (BC-CSG)/ 2.6 W (BC-  
CSGB)  
Output voltage: DC 4.2 V, 0.25 A  
Operating temperature: 0 to 40°C (32 to 104°F)  
Storage temperature: -20 to +60°C (-4 to +140°F)  
Dimensions: Approx. 62x24x91 mm (2 1/2x  
3 1/32x3 5/8 inches) (W/H/D)  
Mass: Approx. 75 g (2.7 oz)

## Rechargeable battery pack NP-BG1

Used battery: Lithium-ion battery  
Maximum voltage: DC 4.2 V  
Nominal voltage: DC 3.6 V  
Capacity: 3.4 Wh (960 mAh)

Design and specifications are subject to change  
without notice.

## Trademarks

- **Cyber-shot** is a trademark of Sony Corporation.
- "Memory Stick", , "Memory Stick PRO", **MEMORY STICK PRO**, "Memory Stick Duo", **MEMORY STICK DUO**, "Memory Stick PRO Duo", **MEMORY STICK PRO DUO**, "MagicGate", and **MAGICGATE** are trademarks of Sony Corporation.
- Microsoft, Windows and DirectX are either registered trademarks or trademarks of Microsoft Corporation in the United States and/or other countries.
- Macintosh, Mac OS, iMac, iBook, PowerBook, Power Mac and eMac are trademarks or registered trademarks of Apple Computer, Inc.
- Intel, MMX, and Pentium are trademarks or registered trademarks of Intel Corporation.
- In addition, system and product names used in this manual are, in general, trademarks or registered trademarks of their respective developers or manufacturers. However, the <sup>TM</sup> or ® marks are not used in all cases in this manual.

Additional information on this product and answers to frequently asked questions can be found at our Customer Support Website.

<http://www.sony.net/>



Printed on 100% recycled paper using VOC (Volatile Organic Compound)-free vegetable oil based ink.

Printed in Japan



2887191130