

# SONY®

# Cyber-shot

**Digital Still Camera**

## **Instruction Manual**

**DSC-T70/T75/T200**

GB



For details on advanced operations, please read **“Cyber-shot Handbook” (PDF)** and **“Cyber-shot Step-up Guide”** on the CD-ROM (supplied) using a computer.

### Operating Instructions

Before operating the unit, please read this manual thoroughly, and retain it for future reference.

## Owner's Record

The model and serial numbers are located on the bottom. Record the serial number in the space provided below. Refer to these numbers whenever you call upon your Sony dealer regarding this product.

Model No. DSC-T70/T75/T200

Serial No. \_\_\_\_\_

## WARNING

**To reduce fire or shock hazard, do not expose the unit to rain or moisture.**

## For Customers in the U.S.A.

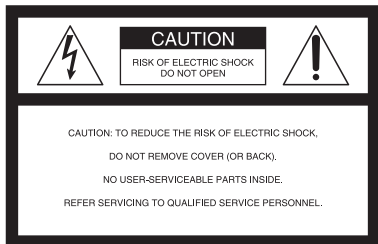

This symbol is intended to alert the user to the presence of uninsulated "dangerous voltage" within the product's enclosure that may be of sufficient magnitude to constitute a risk of electric shock to persons.



This symbol is intended to alert the user to the presence of important operating and maintenance (servicing) instructions in the literature accompanying the appliance.

# IMPORTANT SAFEGUARDS

For your protection, please read these safety instructions completely before operating the appliance, and keep this manual for future reference.

Carefully observe all warnings, precautions and instructions on the appliance, or the one described in the operating instructions and adhere to them.

## Use

### Power Sources

This set should be operated only from the type of power source indicated on the marking label. If you are not sure of the type of electrical power supplied to your home, consult your dealer or local power company. For those sets designed to operate from battery power, or other sources, refer to the operating instructions.

### Polarization

This set may be equipped with a polarized ac power cord plug (a plug having one blade wider than the other).

This plug will fit into the power outlet only one way. This is a safety feature. If you are unable to insert the plug fully into the outlet, try reversing the plug. If the plug should still fail to fit, contact your electrician to have a suitable outlet installed. Do not defeat the safety purpose of the polarized plug by forcing it in.

### Overloading

Do not overload wall outlets, extension cords or convenience receptacles beyond their capacity, since this can result in fire or electric shock.

### Object and Liquid Entry

Never push objects of any kind into the set through openings as they may touch dangerous voltage points or short out parts that could result in a fire or electric shock. Never spill liquid of any kind on the set.

### Attachments

Do not use attachments not recommended by the manufacturer, as they may cause hazards.

## Cleaning

Unplug the set from the wall outlet before cleaning or polishing it. Do not use liquid cleaners or aerosol cleaners. Use a cloth lightly dampened with water for cleaning the exterior of the set.

## Installation

### Water and Moisture

Do not use power-line operated sets near water – for example, near a bathtub, washbowl, kitchen sink, or laundry tub, in a wet basement, or near a swimming pool, etc.

### Power-Cord Protection

Route the power cord so that it is not likely to be walked on or pinched by items placed upon or against them, paying particular attention to the plugs, receptacles, and the point where the cord exits from the appliance.

### Accessories

Do not place the set on an unstable cart, stand, tripod, bracket, or table. The set may fall, causing serious injury to a child or an adult, and serious damage to the set. Use only a cart, stand, tripod, bracket, or table recommended by the manufacturer.

### Ventilation

The slots and openings in the cabinet are provided for necessary ventilation. To ensure reliable operation of the set, and to protect it from overheating, these slots and openings must never be blocked or covered.

- Never cover the slots and openings with a cloth or other materials.
- Never block the slots and openings by placing the set on a bed, sofa, rug, or other similar surface.
- Never place the set in a confined space, such as a bookcase, or built-in cabinet, unless proper ventilation is provided.
- Do not place the set near or over a radiator or heat register, or where it is exposed to direct sunlight.

### Lightning

For added protection for this set during a lightning storm, or when it is left unattended and unused for

long periods of time, unplug it from the wall outlet and disconnect the antenna or cable system. This will prevent damage to the set due to lightning and power-line surges.

## Service

### Damage Requiring Service

Unplug the set from the wall outlet and refer servicing to qualified service personnel under the following conditions:

- When the power cord or plug is damaged or frayed.
- If liquid has been spilled or objects have fallen into the set.
- If the set has been exposed to rain or water.
- If the set has been subject to excessive shock by being dropped, or the cabinet has been damaged.
- If the set does not operate normally when following the operating instructions. Adjust only those controls that are specified in the operating instructions. Improper adjustment of other controls may result in damage and will often require extensive work by a qualified technician to restore the set to normal operation.
- When the set exhibits a distinct change in performance – this indicates a need for service.

### Servicing

Do not attempt to service the set yourself as opening or removing covers may expose you to dangerous voltage or other hazards.

Refer all servicing to qualified service personnel.

### Replacement parts

When replacement parts are required, be sure the service technician has used replacement parts specified by the manufacturer that have the same characteristics as the original parts.

Unauthorized substitutions may result in fire, electric shock, or other hazards.

### Safety Check

Upon completion of any service or repairs to the set, ask the service technician to perform routine safety checks (as specified by the manufacturer) to determine that the set is in safe operating condition.

## Read this first

### CAUTION

Replace the battery with the specified type only. Otherwise, fire or injury may result.

Do not expose the batteries to excessive heat such as sunshine, fire or the like.

### For Customers in the U.S.A. and Canada

#### RECYCLING LITHIUM-ION BATTERIES

Lithium-Ion batteries are recyclable.

You can help preserve our environment by returning your used rechargeable batteries to the collection and recycling location nearest you.



For more information regarding recycling of rechargeable batteries, call toll free 1-800-822-8837, or visit <http://www.rbc.org/>

**Caution:** Do not handle damaged or leaking Lithium-Ion batteries.

#### HD Output Adaptor Cable

This device complies with Part 15 of the FCC Rules. Operation is subject to the following two conditions:

(1) This device may not cause harmful interference, and (2) this device must accept any interference received, including interference that may cause undesired operation.

This Class B digital apparatus complies with Canadian ICES-003.

### Battery charger

This power unit is intended to be correctly orientated in a vertical or floor mount position.

### For Customers in the U.S.A.

If you have any questions about this product, you may call:

Sony Customer Information Center  
1-800-222-SONY (7669)

The number below is for the FCC related matters only.

#### Regulatory Information

##### Declaration of Conformity

Trade Name: SONY  
Model No.: DSC-T200  
Responsible Party: Sony Electronics Inc.  
Address: 16530 Via Esprillo,  
San Diego, CA 92127U.S.A.  
Telephone No.: 858-942-2230

This device complies with Part 15 of the FCC Rules. Operation is subject to the following two conditions: (1) This device may not cause harmful interference, and (2) this device must accept any interference received, including interference that may cause undesired operation.

##### Declaration of Conformity

Trade Name: SONY  
Model No.: DSC-T70, DSC-T75  
Responsible Party: Sony Electronics Inc.  
Address: 16530 Via Esprillo,  
San Diego, CA 92127U.S.A.  
Telephone No.: 858-942-2230

This device complies with Part 15 of the FCC Rules. Operation is subject to the following two conditions: (1) This device may not cause harmful interference, and (2) this device must accept any interference received, including interference that may cause undesired operation.

## CAUTION

You are cautioned that any changes or modifications not expressly approved in this manual could void your authority to operate this equipment.

## Note:

This equipment has been tested and found to comply with the limits for a Class B digital device, pursuant to Part 15 of the FCC Rules.

These limits are designed to provide reasonable protection against harmful interference in a residential installation. This equipment generates, uses, and can radiate radio frequency energy and, if not installed and used in accordance with the instructions, may cause harmful interference to radio communications. However, there is no guarantee that interference will not occur in a particular installation. If this equipment does cause harmful interference to radio or television reception, which can be determined by turning the equipment off and on, the user is encouraged to try to correct the interference by one or more of the following measures:

- Reorient or relocate the receiving antenna.
- Increase the separation between the equipment and receiver.
- Connect the equipment into an outlet on a circuit different from that to which the receiver is connected.
- Consult the dealer or an experienced radio/TV technician for help.

The supplied interface cable must be used with the equipment in order to comply with the limits for a digital device pursuant to Subpart B of Part 15 of FCC Rules.

## For the State of California, USA only

Perchlorate Material - special handling may apply, See

[www.dtsc.ca.gov/hazardouswaste/perchlorate](http://www.dtsc.ca.gov/hazardouswaste/perchlorate)

Perchlorate Material: Lithium battery contains perchlorate.

## For Customers in Europe

This product has been tested and found compliant with the limits set out in the EMC Directive for using connection cables shorter than 3 meters (9.8 feet).

## Attention

The electromagnetic fields at the specific frequencies may influence the picture and sound of this unit.

## Notice

If static electricity or electromagnetism causes data transfer to discontinue midway (fail), restart the application or disconnect and connect the communication cable (USB, etc.) again.

## Disposal of Old Electrical & Electronic Equipment (Applicable in the European Union and other European countries with separate collection systems)



This symbol on the product or on its packaging indicates that this product shall not be treated as household waste. Instead it shall be handed over to the applicable collection point for the recycling of electrical and electronic equipment. By ensuring this product is disposed of correctly, you will help prevent potential negative consequences for the environment and human health, which could otherwise be caused by inappropriate waste handling of this product. The recycling of materials will help to conserve natural resources. For more detailed information about recycling of this product, please contact your local Civic Office, your household waste disposal service or the shop where you purchased the product.

## Disposal of waste batteries (applicable in the European Union and other European countries with separate collection systems)



This symbol on the battery or on the packaging indicates that the battery provided with this product shall not be treated as household waste.

By ensuring these batteries are disposed of correctly, you will help prevent potentially negative consequences for the environment and human health which could otherwise be caused by inappropriate waste handling of the battery. The recycling of the materials will help to conserve natural resources.

In case of products that for safety, performance or data integrity reasons require a permanent connection with an incorporated battery, this battery should be replaced by qualified service staff only.

To ensure that the battery will be treated properly, hand over the product at end-of-life to the applicable collection point for the recycling of electrical and electronic equipment.

For all other batteries, please view the section on how to remove the battery from the product safely. Hand the battery over to the applicable collection point for the recycling of waste batteries.



For more detailed information about recycling of this product or battery, please contact your local Civic Office, your household waste disposal service or the shop where you purchased the product.

## Notice for the customers in the countries applying EU Directives

The manufacturer of this product is Sony Corporation, 1-7-1 Konan Minato-ku Tokyo, 108-0075 Japan. The Authorized Representative for EMC and product safety is Sony Deutschland GmbH, Hedelfinger Strasse 61, 70327 Stuttgart, Germany. For any service or guarantee matters please refer to the addresses given in separate service or guarantee documents.

## Notice for customers in the United Kingdom

A moulded plug complying with BS 1363 is fitted to this equipment for your safety and convenience.

Should the fuse in the plug supplied need to be replaced, a fuse of the same rating as the supplied one and approved by ASTA or BSI to BS 1362, (i.e., marked with an  or  mark) must be used.

If the plug supplied with this equipment has a detachable fuse cover, be sure to attach the fuse cover after you change the fuse. Never use the plug without the fuse cover. If you should lose the fuse cover, please contact your nearest Sony service station.

# Table of contents

IMPORTANT SAFEGUARDS .....	2
Read this first .....	4
Notes on using your camera .....	8
<b>Getting started .....</b>	<b>9</b>
Checking the accessories supplied .....	9
1 Preparing the battery pack .....	10
2 Inserting the battery pack/a "Memory Stick Duo" (not supplied) .....	11
3 Turning the camera on/setting the clock .....	13
<b>Shooting images easily (Auto Adjustment mode) .....</b>	<b>15</b>
Image size/Self-timer/Shooting mode/Flash/Macro/Display .....	16
<b>Viewing/deleting images .....</b>	<b>19</b>
<b>Learning the various functions – HOME/Menu .....</b>	<b>22</b>
Using the HOME screen .....	22
HOME items .....	23
Using the menu items .....	24
Menu items .....	25
<b>Enjoying your computer .....</b>	<b>26</b>
Supported Operating Systems for USB connection and application software "Picture Motion Browser" (supplied) .....	26
Viewing "Cyber-shot Handbook" .....	27
<b>Indicators on the screen .....</b>	<b>28</b>
<b>Battery life and memory capacity .....</b>	<b>32</b>
Battery life and number of images that you can record/view .....	32
Number of still images and recording time of movies .....	33
<b>Troubleshooting .....</b>	<b>34</b>
Battery pack and power .....	34
Shooting still images/movies .....	35
Viewing images .....	35
<b>Precautions .....</b>	<b>36</b>
<b>Specifications .....</b>	<b>37</b>

---

## Notes on using your camera

### Internal memory and “Memory Stick Duo” back up

Do not turn off the camera or remove the battery pack or “Memory Stick Duo” while the access lamp is lighted, as the internal memory data or “Memory Stick Duo” data may be destroyed. Always protect your data by making a back up copy.

### Notes on recording/playback

- Before you start recording, make a trial recording to make sure that the camera is working correctly.
- This camera is neither dust-proof, nor splash-proof, nor water-proof. Read “Precautions” (page 36) before operating the camera.
- Be careful not to get the camera wet. Water entering the inside of the camera may cause malfunctions which in some cases may not be repairable.
- Do not aim the camera at the sun or other bright light. It may cause the malfunction of your camera.
- Do not use the camera near a location that generates strong radio waves or emits radiation. The camera may not be able to record or play back properly.
- Using the camera in sandy or dusty locations may cause malfunctions.
- If moisture condensation occurs, remove it before using the camera (page 36).
- Do not shake or strike the camera. In addition to malfunctions and an inability to record images, this may render the recording medium unusable, or cause image data breakdown, damage or loss.
- Clean the flash surface before use. The heat of flash emission may cause dirt on the flash surface to become discolored or to stick to the flash surface, resulting in insufficient light emission.

### Notes on the LCD screen

- The LCD screen is manufactured using extremely high-precision technology so over 99.99% of the pixels are operational for effective use. However, there may be some tiny black points and/or bright points (white, red, blue or green in color) that constantly appear on the LCD screen. These points are normal in the manufacturing process and do not affect the recording in any way.
- If water droplets or other liquids splash on the LCD screen and make it wet, immediately wipe off the screen with a soft cloth. Leaving liquids on the LCD screen surface can harm the quality and cause a malfunction.

### On image data compatibility

- This camera conforms with DCF (Design rule for Camera File system) universal standard established by JEITA (Japan Electronics and Information Technology Industries Association).
- Playback of images recorded with your camera on other equipment and playback of images recorded or edited with other equipment on your camera are not guaranteed.

### Warning on copyright

Television programs, films, videotapes, and other materials may be copyrighted. Unauthorized recording of such materials may be contrary to the provisions of the copyright laws.

### No compensation for contents of the recording

The contents of the recording cannot be compensated for if recording or playback is not possible due to a malfunction of your camera or recording media, etc.

### On illustrations

Illustrations used in this manual are of DSC-T200 unless noted otherwise.



# Getting started

## Checking the accessories supplied

- Battery charger BC-CSD (1)

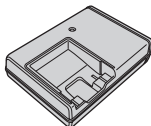

- Power cord (mains lead) (1)  
(not supplied in the USA and Canada)



- Rechargeable battery pack NP-BD1 (1)/  
Battery case (1)

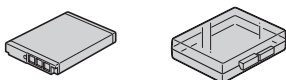

- Paint pen (1)

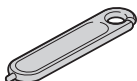

- Adaptor plate (1)  
You can place the camera on the Cyber-shot Station (not supplied) using the adaptor plate.

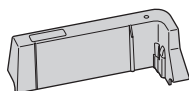

- USB, A/V cable for multi-use terminal (1)

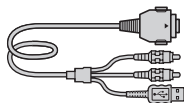

- HD Output Adaptor Cable (1) (DSC-T75 only)

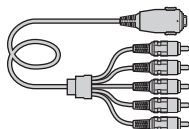

- Wrist strap (1)
- CD-ROM (Cyber-shot application software/  
"Cyber-shot Handbook"/"Cyber-shot Step-up  
Guide") (1)
- Instruction Manual (this manual) (1)

### About the paint pen

- You can paint or put stamps on still images with the paint pen.
- Attach the paint pen to the wrist strap (shown right).
- Do not carry the camera by holding the paint pen. The camera may fall off.

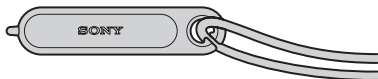

### About the wrist strap

Attach the strap and place your hand through the loop to prevent the camera from damage by being dropped.

DSC-T70/T75

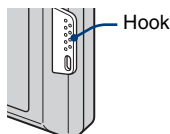

DSC-T200

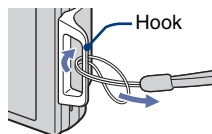

# 1 Preparing the battery pack

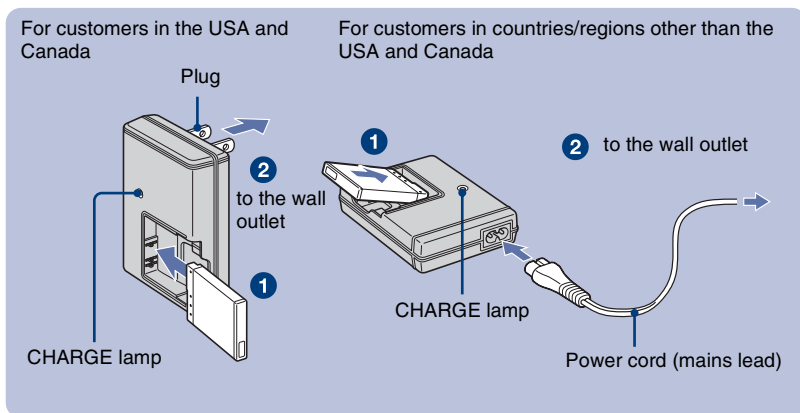

**1** Insert the battery pack into the battery charger.

**2** Connect the battery charger to the wall outlet (wall socket).

The CHARGE lamp lights up, and charging starts.

When the CHARGE lamp turns off, charging is finished (Practical charge).

If you continue charging the battery pack for about one more hour (until it is fully charged), the charge will last slightly longer.

## Charging time

Full charge time	Practical charge time
Approx. 220 min.	Approx. 160 min.

- Time required to charge a fully depleted battery pack at a temperature of 25°C (77°F). Charging may take longer under certain circumstances or conditions.
- See page 32 for the number of images that can be recorded.
- Connect the battery charger to the nearest wall outlet (wall socket) close by.
- Even if the CHARGE lamp is not lit, the battery charger is not disconnected from the AC power source (mains) as long as it is connected to the wall outlet (wall socket). If some trouble occurs while using the battery charger, immediately shut off the power by disconnecting the plug from the wall outlet (wall socket).
- When charging is finished, disconnect the power cord (mains lead) from the wall outlet (wall socket), and remove the battery pack from the battery charger.
- Designed for use with compatible Sony batteries.

## 2 Inserting the battery pack/a “Memory Stick Duo” (not supplied)

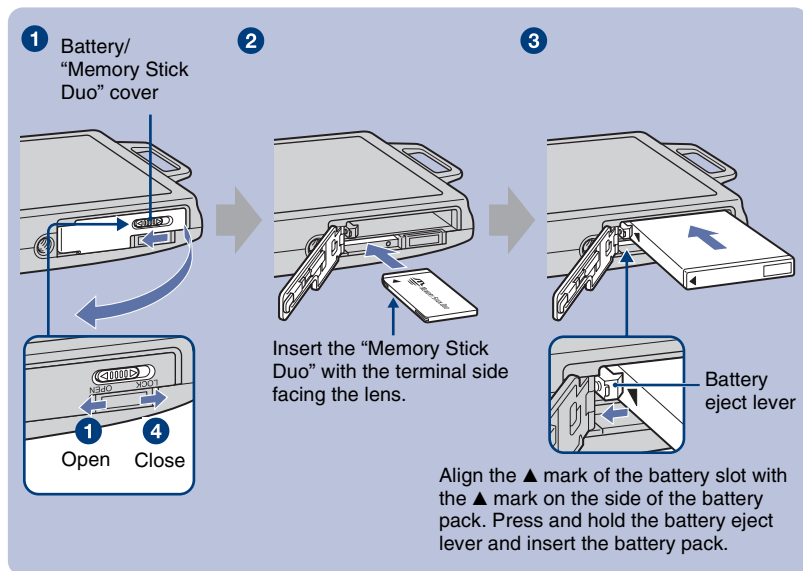

- 1** Open the battery/“Memory Stick Duo” cover.
- 2** Insert the “Memory Stick Duo” (not supplied) all the way in until it clicks.
- 3** Insert the battery pack.
- 4** Close the battery/“Memory Stick Duo” cover.

### When there is no “Memory Stick Duo” inserted

The camera records/plays back images using the internal memory (approx. 31 MB).

## To check the remaining battery charge

Press POWER button to turn on and check the remaining battery on the LCD screen.

<b>Battery remaining indicator</b>					
<b>Battery remaining guidelines</b>	Sufficient power remaining	Battery almost fully charged	Battery half full	Battery low, recording/playback will stop soon.	Change the battery with fully charged one, or charge the battery. (The warning indicator flashes.)

- If the NP-FD1 battery pack (not supplied) is used, the minute display ( 60 Min) is also shown after the battery remaining indicator.
- It takes about one minute until the correct battery remaining indicator appears.
- The displayed battery remaining indicator may not be correct under certain circumstances.
- The Clock Set screen appears when the camera is turned on for the first time (page 13).

## To remove the battery pack/“Memory Stick Duo”

Open the battery/“Memory Stick Duo” cover.

### “Memory Stick Duo”

Make sure that **the access lamp** is not lit, then push the “Memory Stick Duo” in once.

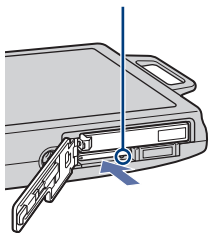

### Battery pack

Slide **the battery eject lever**. Be sure not to drop the battery pack.

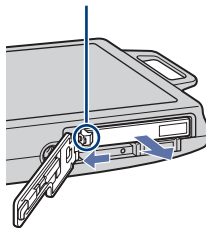

- Never remove the battery pack/“Memory Stick Duo” when the access lamp is lit. This may cause damage to data in the “Memory Stick Duo”/internal memory.
- Use the NP-BD1 battery pack (supplied) only with this camera.

### 3 Turning the camera on/setting the clock

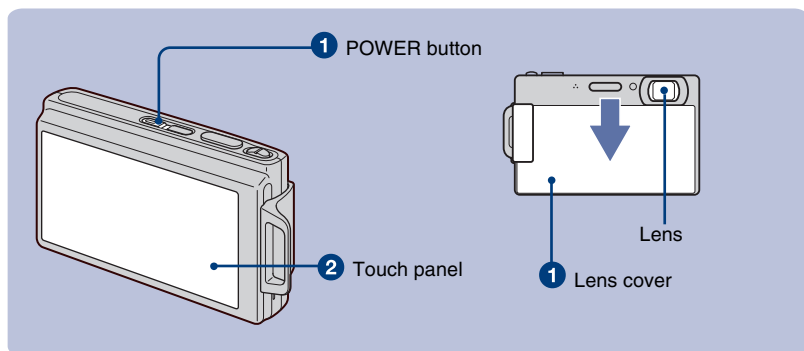

**1** Press the **POWER** button or slide the lens cover downward.

**2** Set the clock by touching the button on the touch panel.

1 Touch the desired date display format, then touch [→].

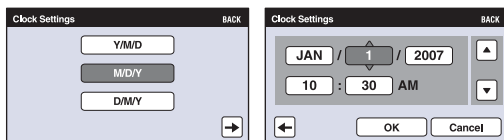

**2** Touch each item, then set its numeric value by touching ▲/▼.

**3** Touch [OK].



#### On the touch panel buttons

Perform settings on this camera by lightly touching the buttons or icons on the screen with your finger.

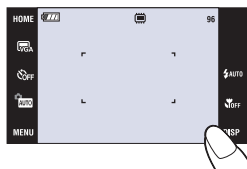
- When the item you want to set is not on the screen, touch ▲/▼ to change the page.
- You can return to the previous screen by touching [BACK].
- Touching [?] displays the guide about the touched item. To hide this guide, touch [?] again.
- When you touch the top right of the screen while shooting, the icons will momentarily disappear. Taking your finger off the screen will make the icons reappear.



## **I To set the date and time again**

Touch [HOME], then touch  (Settings) → [ Clock Settings] (pages 22, 23).

## **I When you turn on the power**

- Once the battery is inserted in the camera, it may take time before operation becomes possible.
- If the camera is running on battery power and you do not operate the camera for about three minutes, the camera turns off automatically to prevent wearing down the battery pack (Auto power-off function).

# Shooting images easily (Auto Adjustment mode)

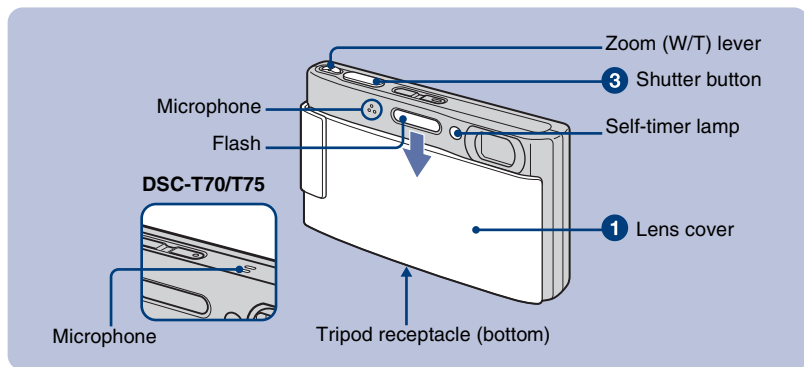

**1** Open the lens cover.

**2** Hold the camera steady, keeping your arm at your side.



Position the subject in the center of the focus frame or touch the point for focusing.

- is displayed if a face is detected in the touched position or is displayed if an object other than a person's face is detected.

**3** Shoot with the shutter button.

**When shooting still images:**

**1** Press and hold the shutter button halfway down to focus.

The (AE/AF lock) indicator (green) flashes, a beep sounds, the indicator stops flashing and remains lit.

**2** Press the shutter button fully down.



AE/AF lock indicator

**When shooting movies:**

Touch [HOME], then touch (Shooting) → [Movie Mode] (page 22).

Or, touch the shooting mode setting icon, then touch (Movie Mode).

**Using the zoom:**

Slide the zoom (W/T) lever to the T side to zoom and slide to the W side to return.

## Image size/Self-timer/Shooting mode/Flash/Macro/Display

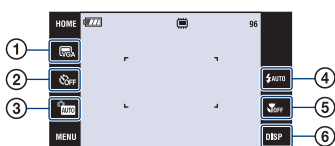

- ① Changing the image size
- ② Using the self-timer
- ③ Changing the shooting mode
- ④ Selecting a flash mode for still images
- ⑤ Shooting close-up
- ⑥ Changing the screen display

### Changing the image size

Touch the image size setting icon on the screen. Touch the desired item, then [BACK].

#### Still image

	For prints up to A3 (11 × 17")
	Shoot in 3:2 aspect ratio
	For prints up to A4(8.5 × 11")
	For prints up to 10 × 15 cm (4 × 6") or 13 × 18 cm(5 × 7")
	Shoot at a small image size for e-mail attachment
	Shoot in HDTV aspect ratio

#### Movie

(Fine)	Shoot high quality movie for display on TV
(Standard)	Shoot standard quality movie for display on TV
320	Shoot at a small image size for e-mail attachments

### Using the self-timer

Touch the self-timer setting icon on the screen. Touch the desired item, then [BACK].

**Self-Timer Off** (OFF): Not using the self-timer

**Self-Timer 10sec** (10): Setting the 10-second delay self-timer





**Self-Timer 2sec** (2): Setting the 2-second delay self-timer

Press the shutter button, the self-timer lamp flashes, and a beep sounds until the shutter operates.













## Changing the shooting mode

Touch the shooting mode setting icon on the screen. Touch the desired item, then [BACK].

	Auto Adjustment	Allows you to shoot still images with the setting adjusted automatically.
	Scene Selection	Allows you to shoot with preset settings according to the scene.
	Program Auto	Allows you to shoot with the exposure adjusted automatically (both the shutter speed and the aperture value). Also you can select various settings using the menu.
	Movie Mode	Allows you to record movies with audio.

### Scene Selection

	High Sensitivity	Allows you to shoot images without a flash under low light conditions.
	Smile Shutter	When the shutter button is pressed all the way down and the camera detects a smile, the shutter is released automatically to shoot the image. Holding down the shutter button again or shooting 6 images exits the capturing smile screen.
	Soft Snap	Allows you to shoot soft images for portraits.
	Twilight Portrait	Allows you to shoot sharp images of people in dark places without losing the dark atmosphere of the surroundings.
	Twilight	Allows you to shoot images without losing the dark atmosphere of the surroundings.
	Landscape	Focuses only on a distant subject to shoot landscapes, etc.
	Hi-Speed Shutter	Allows you to shoot moving subjects in bright places.
	Beach	When shooting seaside or lakeside scenes, the blue of the water is clearly recorded.
	Snow	Allows you to shoot bright images of snowy scenes.
	Fireworks	Allows you to record fireworks in all their splendor.

---

## Flash (Selecting a flash mode for still images)

Touch the flash mode setting icon on the screen. Touch the desired item, then [BACK].

### Flash Auto (🔆AUTO):

Strobes when there is insufficient light or backlight (default setting)

### Flash On (🔆):

### Slow Synchro (Flash forced on) (🔆SL):

The shutter speed is slow in a dark place to clearly shoot the background that is out of flash light.

### Flash Off (🔆):

---

## Macro/Close focus (Shooting close-up)

Touch the Macro/Close focus mode setting icon on the screen. Touch the desired item, then [BACK].

### Macro Off (🔍OFF):

### Macro On (🔍):

W side

DSC-T200: Approx. 8 cm or farther (3 1/4 inches or farther)

DSC-T70/T75: Approx. 8 cm or farther (3 1/4 inches or farther)

T side

DSC-T200: Approx. 80 cm or farther (31 1/2 inches or farther)

DSC-T70/T75: Approx. 25 cm or farther (9 7/8 inches or farther)

### Close focus enabled (🔍):

Locked to the W side: Approx. 1 to 20 cm (13/32 to 7 7/8 inches)

---

## Changing the screen display

Touch [DISP] on the screen to change to the display selection screen.

**Display Setup:** This sets whether or not to display the icons on the screen.

**LCD Brightness:** This sets the backlight brightness.

**Display Histogram:** This sets whether or not to display the histogram on the screen.

# Viewing/deleting images

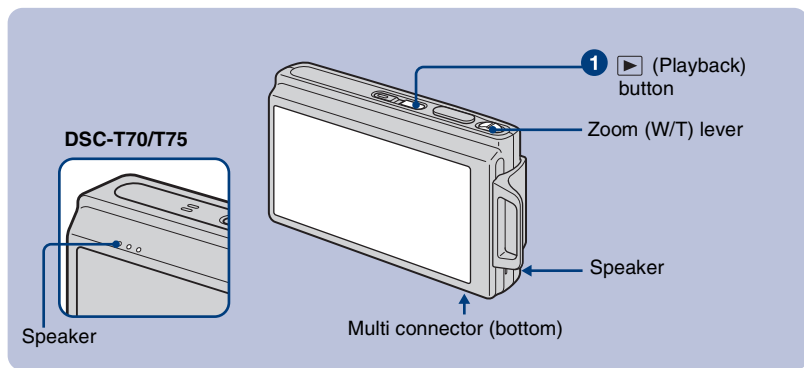

## 1 Press (Playback) button.

If you press (Playback) when the camera is powered off, the camera is turned on automatically and set to playback mode. To switch to the shooting mode, press (Playback) again.

## 2 Touch (previous) / (next) on the screen to select an image.

### Movie:

Touch to playback a movie.

Fast forward/Rewind: / (Touch or to return to normal playback.)

Volume control: Touch , then adjust the volume with / .

Touch again. The volume control bar disappears.

Stop: Touch .

## To delete images

1 Display the image you want to delete, then touch .

2 Touch [OK].

## To view an enlarged image (playback zoom)

Touch a still image while it is displayed to enlarge the corresponding area. Touch to zoom out.

/ / / : Adjusts the position.



[BACK]: Cancels playback zoom.

: Turns / / / on/off.



• You can also enlarge the image with the zoom (W/T) lever.

## To view an index screen

Touch  (Index) to display the index screen.

Touch  /  to display the previous/next page.

To return to the single image screen, touch the thumbnail image.

- You can also access the index screen by selecting [ Image Index] in  (View Images) on the HOME screen.
- If you touch [DISP] in index mode, you can set the number of images displayed in the index screen.

## To delete images in index mode



**1** Touch  while the index screen is displayed.

**2** Touch the thumbnail images to add a check mark to the images you want to delete.

✓ mark is checked in the check box of the image.

To cancel the deletion, touch the image again to deselect the mark.

**3** Touch [], and then touch [OK].

- To delete all the images in a folder, select  (All In This Folder) from  (Delete) in the menu screen, then touch [OK].

## To play back a series of images (Slideshow)

Touch .

## To view images on TV screen

Connect the camera to the TV with the cable for multi-use terminal (supplied).

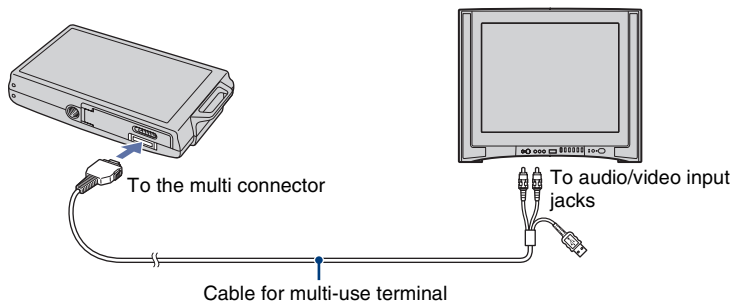

When viewing on a high definition TV, an HD output adaptor cable (DSC-T75 only) is required. If you shoot with the image size set to 16:9, the images will be shown in a full-screen display.

- Movies cannot be played back during HD(1080i) output.

Connect the camera to the HDTV with the HD Output Adaptor Cable (DSC-T75 only).

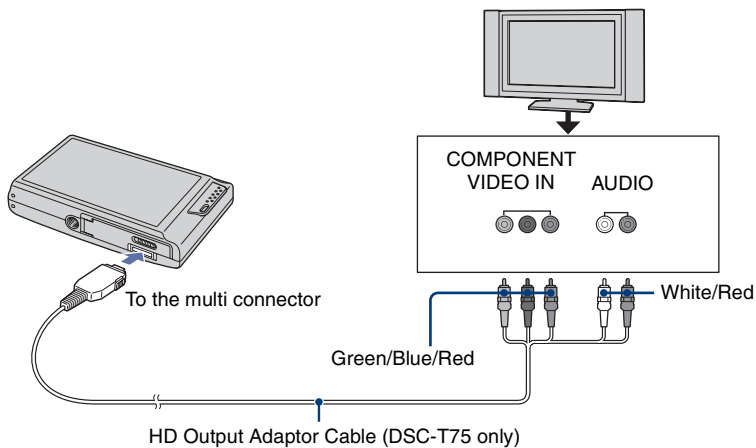

- The cable for video jacks (Green/Blue/Red) is the same color as the respective jacks.

# Learning the various functions – HOME/Menu

## Using the HOME screen

The HOME screen is the gateway screen for all the functions of your camera. You can access this screen regardless of whether the camera is in shooting mode or playback mode.

- 1 Touch [HOME] to display the HOME screen.

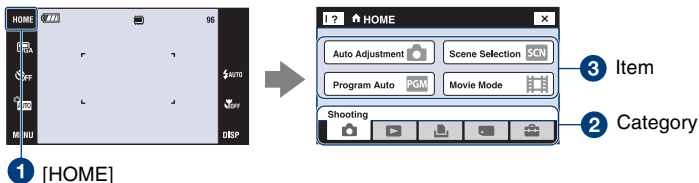



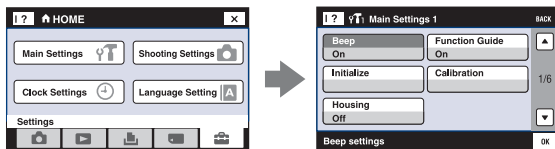

- 2 Touch the category you want to set.
- 3 Touch the item in the category you want to set.

When you select the  (Manage Memory) or  (Settings) category



## HOME items

Touching [HOME] displays the following items. Details on the items are displayed on the screen by the guide.

Category	Items
 <b>Shooting</b>	Auto Adjustment Scene Selection Program Auto Movie Mode
 <b>View Images</b>	Single Image Image Index Slideshow
 <b>Printing, Other</b>	Print Music Tool Download Music      Format Music
 <b>Manage Memory</b>	Memory Tool Memory Stick Tool Format      Create REC. Folder Change REC. Folder      Copy Internal Memory Tool Format
 <b>Settings</b>	Main Settings Main Settings 1 Beep      Function Guide Initialize      Calibration Housing Main Settings 2 USB Connect      COMPONENT Video Out      TV TYPE
	Shooting Settings Shooting Settings 1 AF Illuminator      Grid Line AF Mode      Digital Zoom Shooting Settings 2 Auto Orientation      Auto Review Smile Level
	Clock Settings
	Language Setting

## Using the menu items

### 1 Touch [MENU] to display the menu.

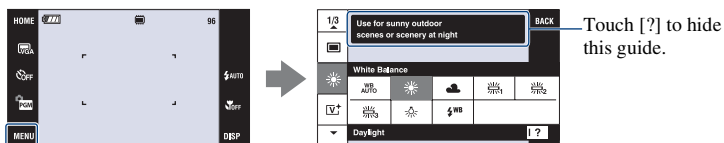

### 1 [MENU]

- Different items will become visible depending on the selected mode.

### 2 Touch the desired menu item.

- If the desired item is hidden, keep touching ▲/▼ until the item appears on the screen.

### 3 Touch the desired setting item.

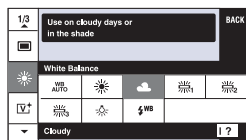

### 4 Touch [BACK] to turn off the menu.













## Menu items

The available menu items vary depending on the mode setting (shooting/viewing), and shooting mode. Only the available items are displayed on the screen.

### Menu for shooting

REC Mode	Selects the continuous shooting method.
EV	Adjusts Exposure.
Focus	Changes the focus method.
Metering Mode	Selects the metering mode.
White Balance	Adjusts the color tones.
Color Mode	Changes the vividness of the image or adds special effects.
Flash Level	Adjusts the amount of flash light.
Red Eye Reduction	Sets to reduce the red-eye phenomenon.
Face Detection	Detects the faces of your subjects and adjusts focus, etc.
SteadyShot	Selects the anti-blur mode.
Setup	Selects the shooting settings.

### Menu for viewing

 (Retouch)	Retouches still images.
 (Paint)	Paints on a still image and saves as a new image.
 (Multi Resizing)	Changes the image size according to usage.
 (Wide Zoom Display)	Displays still images in 16:9.
 (Slideshow)	Plays back a series of images.
 (Delete)	Deletes images.
 (Protect)	Prevents accidental erasure.
<b>DPOF</b>	Adds a Print order mark on image that you want to print out.
 (Print)	Prints images using a PictBridge compliant printer.
 (Rotate)	Rotates a still image.
 (Select Folder)	Selects the folder for viewing images.
 (Volume Settings)	Adjusts the volume.

## Enjoying your computer

You can display images shot with the camera on the computer. Also, you can use still images and movies from the camera more than ever by taking advantage of the software. For details, refer to “Cyber-shot Handbook” on the CD-ROM (supplied).

---

### Supported Operating Systems for USB connection and application software “Picture Motion Browser” (supplied)

	For Windows users	For Macintosh users
USB connection	Windows 2000 Professional SP4, Windows XP* SP2/Windows Vista*	Mac OS 9.1/9.2/ Mac OS X (v10.1 to v10.4)
Application software “Picture Motion Browser”	Windows 2000 Professional SP4, Windows XP* SP2/Windows Vista*	not compatible

\* 64-bit editions and Starter (Edition) are not supported.

- Your computer must be pre-installed with an OS listed above. OS upgrades are not supported.
- If your OS does not support USB connections, use a commercially available Memory Stick Reader/Writer.
- For further details on the operating environment of “Picture Motion Browser” Cyber-shot application software, refer to “Cyber-shot Handbook.”



## Viewing “Cyber-shot Handbook”

“Cyber-shot Handbook”, which is provided on the CD-ROM (supplied), describes in detail how to use the camera. Adobe Reader is required for viewing the handbook.

### For Windows users

- 1 Turn on your computer, and insert the CD-ROM (supplied) into the CD-ROM drive. The screen below appears.



When you click the [Cyber-shot Handbook] button, the screen for copying “Cyber-shot Handbook” appears.

- 2 Follow the on-screen instructions to copy. When you click the “Cyber-shot Handbook” button, both of the “Cyber-shot Handbook” and the “Cyber-shot Step-up Guide” will be installed.
- 3 After the installation is complete, double-click the shortcut created on the desktop.

### For Macintosh users

#### To view the “Cyber-shot Handbook”

- 1 Turn on your computer, and insert the CD-ROM (supplied) into the CD-ROM drive.
- 2 Select the [Handbook] folder and copy “Handbook.pdf” stored in the [GB] folder to your computer.
- 3 After copying is complete, double-click “Handbook.pdf”.

# Indicators on the screen

Touch [DISP] on the screen to change to the display selection screen (page 18).

## When shooting still images

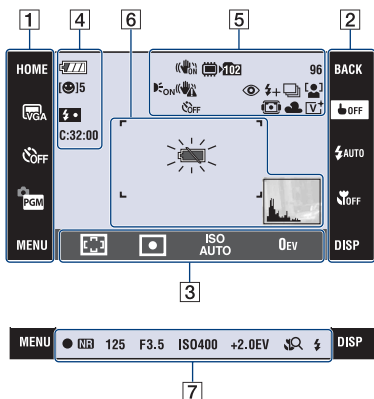

## When shooting movies

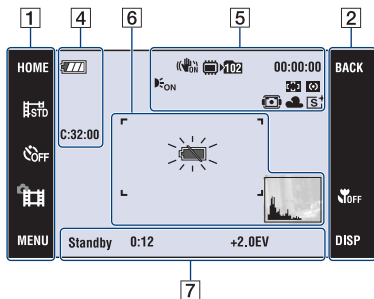

## Screen operation

You can change the settings by touching the following: **1**, **2**, **3**.

- Touching an icon displays the guide about the touched item. To hide this guide, touch [?] (page 13).

**1**

Display	Indication
<b>HOME</b>	Displays the HOME screen.
	Image size settings
	Self-timer settings
	Shooting mode settings
	Shooting mode (Scene Selection) settings
	<ul style="list-style-type: none"> <li>• Touch <b>SCN</b> in the shooting mode settings to select the Scene Selection mode.</li> </ul>
<b>MENU</b>	Displays the MENU screen.

**2**

Display	Indication
<b>BACK</b>	Backs to the previous screen.
	This cancels the focusing on the subject selected by the touch operation.
	Flash mode settings
	Macro/Close focus settings
<b>DISP</b>	Changes the screen display.

**3**

Display	Indication
 <b>0.5m 1.0m</b> <b>3.0m 7.0m ∞</b>	AF mode/focus preset settings
	Metering mode settings
	ISO number settings
<b>0EV</b>	Exposure Value settings

## Screen indicators

Screen indicators [4] to [7] show the current setting status.

[4]

Display	Indication
	Battery remaining
5	Smile shutter (number of still images)
 x1.3 S Q P Q	Zoom scaling
	Flash charging
C:32:00	Self-diagnosis display

[5]

Display	Indication
	SteadyShot
	Recording Media ("Memory Stick Duo", internal memory)
	Recording folder
	AF illuminator
	Vibration warning
	Self-timer
96	Number of recordable images
00:00:00	Recordable time (h:m:s)
	Red-eye reduction
	Flash level
	Recording mode
	Face Detection
	Touch AF indicator
	Housing
	White balance

Display	Indication
	Color mode

[6]

Display	Indication
	AF range finder frame
	Low battery warning
	Histogram

[7]

Display	Indication
	AE/AF lock
	NR slow shutter
125	Shutter speed
F3.5	Aperture value
ISO400	ISO number
+2.0EV	Exposure Value
	Macro/Close focus <ul style="list-style-type: none"> <li>When [Display Setup] is set to [Image Only], the current settings are displayed.</li> </ul>
	Flash mode <ul style="list-style-type: none"> <li>When [Display Setup] is set to [Image Only], the current settings are displayed.</li> </ul>
Standby REC	Standby a movie/Recording a movie
0:12	Recording time (m:s)

## When playing back still images

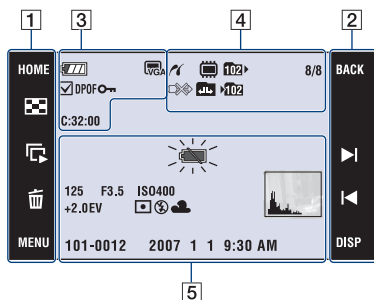

## When playing back movies

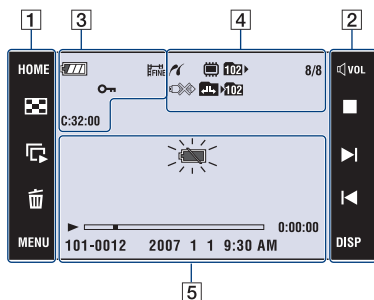

## Screen operation

You can change the settings by touching the following: **1**, **2**.

**1**

Display	Indication
<b>HOME</b>	Displays the HOME screen.
	Changes to index mode.
	Plays back the slide show.
	Deletes the image.
<b>MENU</b>	Displays the MENU screen.
	Selects the playback folder.
	Returns to the single image screen from the index screen.

**2**

Display	Indication
<b>BACK</b>	Backs to the previous screen.
	Adjusts the volume.
	Stop
	Playback
	Playback zoom
	Turns /// on/off.
	Displays the previous/next image.
	Fast forward/Rewind
<b>DISP</b>	Changes the screen display.







## Screen indicators

Screen indicators **3** to **5** show the current setting status.









**3**

Display	Indication
	Battery remaining
	Image size
	Check mark
<b>DPOF</b>	Print order (DPOF) mark
	Protect
<b>Qx2.0</b>	Playback zoom
<b>C:32:00</b>	Self-diagnosis display

4

Display	Indication
	PictBridge connecting
	Playback Media (“Memory Stick Duo”, internal memory)
	Playback folder
<b>8/8 12/12</b>	Image number/Number of images recorded in selected folder
	PictBridge connecting
	Change folder
	Recording folder

5

Display	Indication
	Low battery warning
<b>125</b>	Shutter speed
<b>F3.5</b>	Aperture value
<b>ISO400</b>	ISO number
<b>+2.0EV</b>	Exposure Value
	Metering mode
	Flash
<b>AWB</b> 	White balance
	Playback
	Playback bar
<b>0:00:00</b>	Counter
<b>101-0012</b>	Folder-file number
<b>2007 1 1</b> <b>9:30 AM</b>	Recorded date/time of the playback image
	Histogram <ul style="list-style-type: none"> <li>•  appears when histogram display is disabled.</li> </ul>

# Battery life and memory capacity

## Battery life and number of images that you can record/view

The tables show the approximate number of images that you can record/view and the battery life with the battery pack (supplied) at full capacity and at an ambient temperature of 25°C (77°F). The numbers of images that can be recorded or viewed take into account changing the “Memory Stick Duo” as necessary.

Note that the actual numbers may be less than those indicated in the table depending on the conditions of use.

### When shooting still images

	Battery life (min.)	No. of Images
DSC-T200	Approx. 125	Approx. 250
DSC-T70/T75	Approx. 135	Approx. 270

- Shooting in the following situations:
  - [REC Mode] is set to [Normal].
  - [AF Mode] is set to [Single].
  - [SteadyShot] is set to [Shooting].
  - Shooting once every 30 seconds.
  - The zoom is switched alternately between the W and T ends.
  - The flash strobes once every two times.
  - The power turns on and off once every ten times.
- The measurement method is based on the CIPA standard.  
(CIPA: Camera & Imaging Products Association)
- The battery life/number of images does not change, regardless of image size.

### When viewing still images

	Battery life (min.)	No. of Images
DSC-T200	Approx. 210	Approx. 4200
DSC-T70/T75	Approx. 220	Approx. 4400

- Viewing single images in order at about three second intervals

### Notes on the battery

- Battery capacity decreases as you use it more, as the time passes.
- The number of images that can be recorded/viewed and the battery life are decreased under the following conditions:
  - The surrounding temperature is low.
  - The flash is used frequently.
  - The camera has been turned on and off many times.
  - The zoom is used frequently.
  - The brightness of LCD Backlight is set to up.
  - [AF Mode] is set to [Monitor].
  - [SteadyShot] is set to [Continuous].
  - The battery power is low.
  - The Face Detect function is activated.



## Number of still images and recording time of movies

The number of still images and the length of time for movies may vary depending on the shooting conditions.

The number of still images and movie recording times may vary, even if the indicated capacities are the same as shown below.

### The approximate number of still images

(Units: Images)

Capacity Size	Internal memory	"Memory Stick Duo" formatted with this camera						
	Approx. 31 MB	128 MB	256 MB	512 MB	1 GB	2 GB	4 GB	8 GB
8M	10	40	72	150	306	618	1223	2457
3:2	10	40	72	150	306	618	1223	2457
5M	13	51	92	191	390	787	1557	3127
3M	21	82	148	306	626	1262	2498	5017
VGA	202	790	1428	2941	6013	12120	23980	48160
16:9	33	133	238	490	1002	2020	3997	8027

- The number of images listed is for when [REC Mode] is set to [Normal].
- When the number of remaining shootable images is greater than 9,999, the ">9999" indicator appears.
- When an image was recorded using an earlier Sony model and is played back on the camera, the image may not appear in the actual image size.

### The approximate recording time of movies

The table below shows the approximate maximum recording times. These are the total times for all movie files. Continuous shooting is possible for approximately 10 minutes.

(Units: hour : minute : second)

Capacity Size	Internal memory	"Memory Stick Duo" formatted with this camera						
	Approx. 31 MB	128 MB	256 MB	512 MB	1 GB	2 GB	4 GB	8 GB
640(Fine)	–	–	0:02:50	0:06:00	0:12:30	0:25:10	0:49:50	1:40:20
640(Standard)	0:01:30	0:05:50	0:10:40	0:22:00	0:45:00	1:30:50	2:59:50	6:01:10
320	0:06:00	0:23:40	0:42:50	1:28:10	3:00:20	6:03:30	11:59:30	24:04:50

- Movies with the size set to [640(Fine)] can only be recorded on a "Memory Stick PRO Duo".
- This camera does not support HD recordings or playbacks for movies.

# Troubleshooting

If you experience trouble with your camera, try the following solutions.

- 1 Check the items below, and refer to “Cyber-shot Handbook” (PDF).**  
If a code such as “C/E:□□:□□” appears on the screen, refer to “Cyber-shot Handbook.”

- 2 Remove the battery pack, and insert the battery pack again after about one minute, and turn on the power.**

- 3 Initialize the settings (page 23).**

- 4 Consult your Sony dealer or local authorized Sony service facility.**

Please understand that you give your consent that the contents of the internal memory, Music files may be checked when you send your camera to be repaired.

## Battery pack and power

### The battery pack cannot be inserted.

- Insert the battery pack correctly by pressing and holding the battery eject lever open (page 11).

---

### Cannot turn on the camera.

- After installing the battery pack into the camera, it may take a little while to get the camera powered.
- Insert the battery pack correctly (page 11).
- The battery pack is discharged. Insert charged battery pack (page 10).
- The battery pack is dead. Replace it with a new one.
- Use a recommended battery pack (page 9).

---

### The power turns off suddenly.

- If you do not operate the camera for about three minutes while the power is on, the camera turns off automatically to prevent wearing down the battery pack. Turn on the camera again (page 13).
- The battery pack is dead. Replace it with a new one.

---

### The battery remaining indicator is incorrect.

- This phenomenon occurs when you use the camera in an extremely hot or cold location.
- The displayed battery remaining differs from the current one. Fully discharge and then charge the battery pack to correct the display.
- The battery pack is discharged. Insert the charged battery pack (page 10).
- The battery pack is dead. Replace it with a new one.



---

### The battery cannot be charged while inside the camera.

- Use the battery charger (supplied) to charge the battery.

## Shooting still images/movies

### Cannot record images.

- Check the free capacity of the internal memory or “Memory Stick Duo” (page 33). If it is full, do one of the following:
  - Delete unnecessary images (page 19).
  - Change the “Memory Stick Duo”.
- You cannot record images while charging the flash.
- When shooting a still image, set the shooting mode other than .
- Set the shooting mode to  when shooting movies.
- The image size is set to [640(Fine)] when recording movies. Do one of the following:
  - Set the image size to other than [640(Fine)].
  - Insert a “Memory Stick PRO Duo.”

---

### Cannot insert dates on images.

- This camera does not have a feature for superimposing dates on images. By using “Picture Motion Browser,” you can print or save images with the date.

---

### Vertical streaks appear when you are shooting a very bright subject.

- The smear phenomenon is occurring and white, black, red, purple or other streaks appear on the image. This phenomenon is not a malfunction.

## Viewing images

### Cannot play back images.

- Press  (Playback) button (page 19).
- The folder/file name has been changed on your computer.
- When an image file has been processed by a computer or when the image file was recorded using a model other than that of your camera, playback on your camera is not guaranteed.
- The camera is in USB mode. Delete the USB connection.

# Precautions

## Do not use/store the camera in the following places

- In an extremely hot, cold or humid place  
In places such as in a car parked in the sun, the camera body may become deformed and this may cause a malfunction.
- Under direct sunlight or near a heater  
The camera body may become discolored or deformed, and this may cause a malfunction.
- In a location subject to rocking vibration
- Near strong magnetic place
- In sandy or dusty places  
Be careful not to let sand or dust get into the camera. This may cause the camera to malfunction, and in some cases this malfunction cannot be repaired.

## On carrying

Do not sit down in a chair or other place with the camera in the back pocket of your trousers or skirt, as this may cause malfunction or damage the camera.

## On cleaning

### Cleaning the LCD screen

Wipe the screen surface with an LCD cleaning kit (not supplied) to remove fingerprints, dust, etc.

### Cleaning the lens

Wipe the lens with a soft cloth to remove fingerprints, dust, etc.

### Cleaning the camera surface

Clean the camera surface with a soft cloth slightly moistened with water, then wipe the surface with a dry cloth. To prevent damage to the finish or casing:

- Do not expose the camera to chemical products such as thinner, benzene, alcohol, disposable cloths, insect repellent, sunscreen or insecticide.
- Do not touch the camera with any of the above on your hand.
- Do not leave the camera in contact with rubber or vinyl for a long time.

## On operating temperatures

Your camera is designed for use under the temperatures between 0°C and 40°C (32°F and 104°F). Shooting in extremely cold or hot places that exceed this range is not recommended.

## On moisture condensation

If the camera is brought directly from a cold to a warm location, moisture may condense inside or outside the camera. Note that if you shoot with moisture remaining inside the lens, images will not be clear.

### If moisture condensation occurs

Turn off the camera and wait about an hour for the moisture to evaporate. Note that if you attempt to shoot with moisture remaining inside the lens, you will be unable to record clear images.

## On the internal rechargeable backup battery

This camera has an internal rechargeable battery for maintaining the date and time and other settings regardless of whether the power is on or off.

This rechargeable battery is continually charged as long as you are using the camera. However, if you use the camera for only short periods, it discharges gradually, and if you do not use the camera at all for about one month it becomes completely discharged. In this case, be sure to charge this rechargeable battery before using the camera.

However, even if this rechargeable battery is not charged, you can still use the camera, but the date and time will not be indicated.

### Charging method of the internal rechargeable backup battery

Insert charged battery pack in the camera, and then leave the camera for 24 hours or more with the power off.

# Specifications

## Camera

### [System]

Image device: 7.18 mm (1/2.5 type) color CCD,  
Primary color filter

Total pixel number of camera:  
Approx. 8 286 000 pixels

Effective pixel number of camera:  
Approx. 8 083 000 pixels

Lens:

#### **DSC-T200**

Carl Zeiss Vario-Tessar 5× zoom lens  
f = 5.8 – 29.0 mm (35 – 175 mm when  
converted to a 35 mm still camera)F3.5 – 4.4

#### **DSC-T70/T75**

Carl Zeiss Vario-Tessar 3× zoom lens  
f = 6.33 – 19.0 mm (38 – 114 mm when  
converted to a 35 mm still camera)F3.5 – 4.3

Exposure control: Automatic exposure, Scene  
Selection (10 modes)

White balance: Automatic, Daylight, Cloudy,  
Fluorescent 1,2,3, Incandescent, Flash

File format (DCF compliant):

Still images: Exif Ver. 2.21 JPEG compliant,  
DPOF compatible

Movies: MPEG1 compliant (Monaural)

Recording media: Internal Memory  
(approx. 31 MB), "Memory Stick Duo"

Flash: Flash range (ISO sensitivity  
(Recommended exposure Index) set to Auto):

#### **DSC-T200**

Approx. 0.1 to 3.7 m (4 inches to 12 feet  
1 3/4 inches) (W)/approx. 0.8 to 2.9 m (2 feet  
7 1/2 inches to 9 feet 6 1/4 inches) (T)

#### **DSC-T70/T75**

Approx. 0.1 to 3.0 m (4 inches to 9 feet  
10 1/8 inches) (W)/approx. 0.25 to 2.5 m  
(9 7/8 inches to 8 feet 2 1/2 inches) (T)

### [Input and Output connectors]

Multi connector: Video output  
Audio output (Monaural)  
USB communication

USB communication: Hi-Speed USB (USB 2.0  
compliant)

### [LCD screen]

LCD panel:

#### **DSC-T200**

Wide (16:9), 8.8 cm (3.5 type) TFT drive

#### **DSC-T70/T75**

Wide (16:9), 7.5 cm (3.0 type) TFT drive

Total number of dots: 230 400 (960 × 240) dots

### [Power, general]

Power: Rechargeable battery pack NP-BD1, 3.6 V  
NP-FD1 (not supplied), 3.6 V  
AC-LS5K AC Adaptor (not supplied), 4.2 V

Power consumption (during shooting):

#### **DSC-T200**

1.0 W

#### **DSC-T70/T75**

1.0 W

Operating temperature: 0 to 40°C (32 to 104°F)

Storage temperature: –20 to +60°C (–4 to +140°F)

Dimensions:

#### **DSC-T200**

93.5 × 59.3 × 20.4 mm (3 3/4 × 2 3/8 ×  
13/16 inches) (W/H/D, excluding protrusions)

#### **DSC-T70/T75**

90.0 × 56.4 × 20.7 mm (3 5/8 × 2 1/4 ×  
27/32 inches) (W/H/D, excluding protrusions)

Mass (including NP-BD1 battery pack, paint pen  
and strap etc.):

#### **DSC-T200**

Approx. 186 g (6.6 oz)

#### **DSC-T70/T75**

Approx. 156 g (5.5 oz)

Microphone: Monaural

Speaker: Monaural

Exif Print: Compatible

PRINT Image Matching III: Compatible

PictBridge: Compatible

### BC-CSD battery charger

Power requirements: AC 100 V to 240 V,  
50/60 Hz, 2.2 W

Output voltage: DC 4.2 V, 0.33 A

Operating temperature: 0 to 40°C (32 to 104°F)

Storage temperature: –20 to +60°C (–4 to  
+140°F)

Dimensions: Approx. 62 × 24 × 91 mm (2 1/2 ×  
3 1/32 × 3 5/8 inches) (W/H/D)

Mass: Approx. 75 g (2.7 oz)

## Rechargeable battery pack NP-BD1

Used battery: Lithium-ion battery

Maximum voltage: DC 4.2 V

Nominal voltage: DC 3.6 V

Capacity: 2.4 Wh (680 mAh)

Design and specifications are subject to change without notice.

## Trademarks

- **Cyber-shot**, “Cyber-shot” are trademarks of Sony Corporation.
- “Memory Stick,”  “Memory Stick PRO,” **MEMORY STICK PRO**, “Memory Stick Duo,” **MEMORY STICK DUO**, “Memory Stick PRO Duo,” **MEMORY STICK PRO DUO**, “Memory Stick PRO-HG Duo,” **MEMORY STICK PRO-HG DUO**, “Memory Stick Micro,” “MagicGate,” and **MAGICGATE** are trademarks of Sony Corporation.
- “Info LITHIUM” is a trademark of Sony Corporation.
- Microsoft, Windows, DirectX and Windows Vista are either registered trademarks or trademarks of Microsoft Corporation in the United States and/or other countries.
- Macintosh, Mac OS, iMac, iBook, PowerBook, Power Mac and eMac are trademarks or registered trademarks of Apple Inc.
- Intel, MMX, and Pentium are trademarks or registered trademarks of Intel Corporation.
- Google is a registered trademark of Google, Inc.
- Adobe, the Adobe logo, and Reader are either registered trademarks or trademarks of Adobe Systems Incorporated in the United States and/or other countries.
- In addition, system and product names used in this manual are, in general, trademarks or registered trademarks of their respective developers or manufacturers. However, the ™ or ® marks are not used in all cases in this manual.



Additional information on this product and answers to frequently asked questions can be found at our Customer Support Website.

<http://www.sony.net/>



Printed on 70% or more recycled paper using VOC (Volatile Organic Compound)-free vegetable oil based ink.

Printed in Japan



3219483120