

SONY®

Cyber-shot

Digital Still Camera

Instruction Manual

DSC-W110/W115/W120/W125/W130

GB



For details on advanced operations, please read **“Cyber-shot Handbook”** (PDF) and **“Cyber-shot Step-up Guide”** on the CD-ROM (supplied) using a computer.

Operating Instructions

Before operating the unit, please read this manual thoroughly, and retain it for future reference.

Owner's Record

The model and serial numbers are located on the bottom. Record the serial number in the space provided below. Refer to these numbers whenever you call upon your Sony dealer regarding this product.

Model No. DSC-W110/W115/W120/
W125/W130

Serial No. _____

WARNING

To reduce fire or shock hazard, do not expose the unit to rain or moisture.

For Customers in the U.S.A.

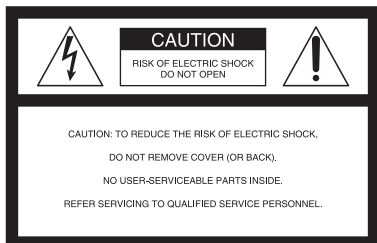

This symbol is intended to alert the user to the presence of uninsulated "dangerous voltage" within the product's enclosure that may be of sufficient magnitude to constitute a risk of electric shock to persons.



This symbol is intended to alert the user to the presence of important operating and maintenance (servicing) instructions in the literature accompanying the appliance.

IMPORTANT SAFEGUARDS

For your protection, please read these safety instructions completely before operating the appliance, and keep this manual for future reference.

Carefully observe all warnings, precautions and instructions on the appliance, or the one described in the operating instructions and adhere to them.

Use

Power Sources

This set should be operated only from the type of power source indicated on the marking label. If you are not sure of the type of electrical power supplied to your home, consult your dealer or local power company. For those sets designed to operate from battery power, or other sources, refer to the operating instructions.

Polarization

This set may be equipped with a polarized ac power cord plug (a plug having one blade wider than the other).

This plug will fit into the power outlet only one way. This is a safety feature. If you are unable to insert the plug fully into the outlet, try reversing the plug. If the plug should still fail to fit, contact your electrician to have a suitable outlet installed. Do not defeat the safety purpose of the polarized plug by forcing it in.

Overloading

Do not overload wall outlets, extension cords or convenience receptacles beyond their capacity, since this can result in fire or electric shock.

Object and Liquid Entry

Never push objects of any kind into the set through openings as they may touch dangerous voltage points or short out parts that could result in a fire or electric shock. Never spill liquid of any kind on the set.

Attachments

Do not use attachments not recommended by the manufacturer, as they may cause hazards.

Cleaning

Unplug the set from the wall outlet before cleaning or polishing it. Do not use liquid cleaners or aerosol cleaners. Use a cloth lightly dampened with water for cleaning the exterior of the set.

Installation

Water and Moisture

Do not use power-line operated sets near water – for example, near a bathtub, washbowl, kitchen sink, or laundry tub, in a wet basement, or near a swimming pool, etc.

Power-Cord Protection

Route the power cord so that it is not likely to be walked on or pinched by items placed upon or against them, paying particular attention to the plugs, receptacles, and the point where the cord exits from the appliance.

Accessories

Do not place the set on an unstable cart, stand, tripod, bracket, or table. The set may fall, causing serious injury to a child or an adult, and serious damage to the set. Use only a cart, stand, tripod, bracket, or table recommended by the manufacturer.

Ventilation

The slots and openings in the cabinet are provided for necessary ventilation. To ensure reliable operation of the set, and to protect it from overheating, these slots and openings must never be blocked or covered.

- Never cover the slots and openings with a cloth or other materials.
- Never block the slots and openings by placing the set on a bed, sofa, rug, or other similar surface.
- Never place the set in a confined space, such as a bookcase, or built-in cabinet, unless proper ventilation is provided.
- Do not place the set near or over a radiator or heat register, or where it is exposed to direct sunlight.

Lightning

For added protection for this set during a lightning storm, or when it is left unattended and unused for

long periods of time, unplug it from the wall outlet and disconnect the antenna or cable system. This will prevent damage to the set due to lightning and power-line surges.

Service

Damage Requiring Service

Unplug the set from the wall outlet and refer servicing to qualified service personnel under the following conditions:

- When the power cord or plug is damaged or frayed.
- If liquid has been spilled or objects have fallen into the set.
- If the set has been exposed to rain or water.
- If the set has been subject to excessive shock by being dropped, or the cabinet has been damaged.
- If the set does not operate normally when following the operating instructions. Adjust only those controls that are specified in the operating instructions. Improper adjustment of other controls may result in damage and will often require extensive work by a qualified technician to restore the set to normal operation.
- When the set exhibits a distinct change in performance – this indicates a need for service.

Servicing

Do not attempt to service the set yourself as opening or removing covers may expose you to dangerous voltage or other hazards.

Refer all servicing to qualified service personnel.

Replacement parts

When replacement parts are required, be sure the service technician has used replacement parts specified by the manufacturer that have the same characteristics as the original parts.

Unauthorized substitutions may result in fire, electric shock, or other hazards.

Safety Check

Upon completion of any service or repairs to the set, ask the service technician to perform routine safety checks (as specified by the manufacturer) to determine that the set is in safe operating condition.

Read this first

CAUTION

Replace the battery with the specified type only. Otherwise, fire or injury may result.

Do not expose the batteries to excessive heat such as sunshine, fire or the like.

For Customers in the U.S.A. and Canada

RECYCLING LITHIUM-ION BATTERIES

Lithium-Ion batteries are recyclable.

You can help preserve our environment by returning your used rechargeable batteries to the collection and recycling location nearest you.



For more information regarding recycling of rechargeable batteries, call toll free 1-800-822-8837, or visit <http://www.rbrcc.org/>

Caution: Do not handle damaged or leaking Lithium-Ion batteries.

Battery charger

This power unit is intended to be correctly orientated in a vertical or floor mount position.

For Customers in the U.S.A.

If you have any questions about this product, you may call:

Sony Customer Information Center
1-800-222-SONY (7669)

The number below is for the FCC related matters only.

Regulatory Information

Declaration of Conformity

Trade Name: SONY
Model No.: DSC-W130
Responsible Party: Sony Electronics Inc.
Address: 16530 Via Esprillo,
San Diego, CA 92127U.S.A.
Telephone No.: 858-942-2230

This device complies with Part 15 of the FCC Rules. Operation is subject to the following two conditions: (1) This device may not cause harmful interference, and (2) this device must accept any interference received, including interference that may cause undesired operation.

Declaration of Conformity

Trade Name: SONY
Model No.: DSC-W120, DSC-W125
Responsible Party: Sony Electronics Inc.
Address: 16530 Via Esprillo,
San Diego, CA 92127U.S.A.
Telephone No.: 858-942-2230

This device complies with Part 15 of the FCC Rules. Operation is subject to the following two conditions: (1) This device may not cause harmful interference, and (2) this device must accept any interference received, including interference that may cause undesired operation.

Declaration of Conformity

Trade Name: SONY
Model No.: DSC-W110, DSC-W115
Responsible Party: Sony Electronics Inc.
Address: 16530 Via Esprillo,
San Diego, CA 92127U.S.A.
Telephone No.: 858-942-2230

This device complies with Part 15 of the FCC Rules. Operation is subject to the following two conditions: (1) This device may not cause harmful interference, and (2) this device must accept any interference received, including interference that may cause undesired operation.

CAUTION

You are cautioned that any changes or modifications not expressly approved in this manual could void your authority to operate this equipment.

Note:

This equipment has been tested and found to comply with the limits for a Class B digital device, pursuant to Part 15 of the FCC Rules. These limits are designed to provide reasonable protection against harmful interference in a residential installation. This equipment generates, uses, and can radiate radio frequency energy and, if not installed and used in accordance with the instructions, may cause harmful interference to radio communications. However, there is no guarantee that interference will not occur in a particular installation. If this equipment does cause harmful interference to radio or television reception, which can be determined by turning the equipment off and on, the user is encouraged to try to correct the interference by one or more of the following measures:

- Reorient or relocate the receiving antenna.
- Increase the separation between the equipment and receiver.
- Connect the equipment into an outlet on a circuit different from that to which the receiver is connected.
- Consult the dealer or an experienced radio/TV technician for help.

The supplied interface cable must be used with the equipment in order to comply with the limits for a digital device pursuant to Subpart B of Part 15 of FCC Rules.

For Customers in Europe

This product has been tested and found compliant with the limits set out in the EMC Directive for using connection cables shorter than 3 meters (9.8 feet).

Attention

The electromagnetic fields at the specific frequencies may influence the picture and sound of this unit.

Notice

If static electricity or electromagnetism causes data transfer to discontinue midway (fail), restart the application or disconnect and connect the communication cable (USB, etc.) again.

Disposal of Old Electrical & Electronic Equipment (Applicable in the European Union and other European countries with separate collection systems)



This symbol on the product or on its packaging indicates that this product shall not be treated as household waste. Instead it shall be handed over to the applicable collection point for the recycling of electrical and electronic equipment. By ensuring this product is disposed of correctly, you will help prevent potential negative consequences for the environment and human health, which could otherwise be caused by inappropriate waste handling of this product. The recycling of materials will help to conserve natural resources. For more detailed information about recycling of this product, please contact your local Civic Office, your household waste disposal service or the shop where you purchased the product.

Disposal of waste batteries (applicable in the European Union and other European countries with separate collection systems)



This symbol on the battery or on the packaging indicates that the battery provided with this product shall not be treated as household waste.

By ensuring these batteries are disposed of correctly, you will help prevent potentially negative consequences for the environment and human health which could otherwise be caused by inappropriate waste handling of the battery. The recycling of the materials will help to conserve natural resources.

In case of products that for safety, performance or data integrity reasons require a permanent connection with an incorporated battery, this battery should be replaced by qualified service staff only. To ensure that the battery will be treated properly, hand over the product at end-of-life to the applicable collection point for the recycling of electrical and electronic equipment.

For all other batteries, please view the section on how to remove the battery from the product safely.

Hand the battery over to the applicable collection point for the recycling of waste batteries.



For more detailed information about recycling of this product or battery, please contact your local Civic Office, your household waste disposal service or the shop where you purchased the product.

Notice for the customers in the countries applying EU Directives

The manufacturer of this product is Sony Corporation, 1-7-1 Konan Minato-ku Tokyo, 108-0075 Japan. The Authorized Representative for EMC and product safety is Sony Deutschland GmbH, Hedelfinger Strasse 61, 70327 Stuttgart, Germany. For any service or guarantee matters please refer to the addresses given in separate service or guarantee documents.

Notice for customers in the United Kingdom

A moulded plug complying with BS 1363 is fitted to this equipment for your safety and convenience.

Should the fuse in the plug supplied need to be replaced, a fuse of the same rating as the supplied one and approved by ASTA or BSI to BS 1362, (i.e., marked with an  or  mark) must be used.

If the plug supplied with this equipment has a detachable fuse cover, be sure to attach the fuse cover after you change the fuse. Never use the plug without the fuse cover. If you should lose the fuse cover, please contact your nearest Sony service station.

Table of contents

IMPORTANT SAFEGUARDS	2
Read this first	4
Notes on using the camera	8
Getting started	9
Checking the accessories supplied	9
1 Preparing the battery pack	10
2 Inserting the battery pack/a "Memory Stick Duo" (not supplied)	11
3 Turning the camera on/setting the clock	13
Shooting images easily	14
Mode dial/Zoom/Flash/Macro/Self-timer/Display	15
Shooting in Smile Shutter mode	17
Viewing/deleting images	18
Learning the various functions – HOME/Menu	21
Using the HOME screen	21
HOME items	22
Using menu items	23
Menu items	24
Enjoying your computer	26
Supported Operating Systems for USB connection and application software (supplied)	26
Viewing "Cyber-shot Handbook"	27
Indicators on the screen	28
Battery life and memory capacity	30
Battery life and number of images you can record/view	30
Number of still images and recording time of movies	31
Troubleshooting	33
Battery pack and power	33
Shooting still images/movies	34
Viewing images	34
Precautions	35
Specifications	36

Notes on using the camera

Internal memory and “Memory Stick Duo” back up

Do not turn off the camera, remove the battery pack, or remove the “Memory Stick Duo” while the access lamp is lit. Otherwise, the internal memory data or “Memory Stick Duo” may be damaged. Be sure to make a backup copy to protect your data.

Notes on recording/playback

- Before you start recording, make a trial recording to make sure that the camera is working correctly.
- The camera is neither dust-proof, nor splash-proof, nor water-proof. Read “Precautions” (page 35) before operating the camera.
- Avoid exposing the camera to water. If water enters inside the camera, a malfunction may occur. In some cases, the camera cannot be repaired.
- Do not aim the camera at the sun or other bright light. It may cause the malfunction of the camera.
- Do not use the camera near a location that generates strong radio waves or emits radiation. Otherwise, the camera may not properly record or play back images.
- Using the camera in sandy or dusty locations may cause malfunctions.
- If moisture condensation occurs, remove it before using the camera (page 35).
- Do not shake or strike the camera. It may cause a malfunction and you may not be able to record images. Furthermore, the recording media may become unusable or image data may be damaged.
- Clean the flash surface before use. The heat of flash emission may cause dirt on the flash surface to become discolored or to stick to the flash surface, resulting in insufficient light emission.

Notes on the LCD screen and lens

- The LCD screen is manufactured using extremely high-precision technology so over 99.99% of the pixels are operational for effective use. However, some tiny black and/or bright dots (white, red, blue or green) may appear on the LCD screen. These dots are a normal result of the manufacturing process, and do not affect the recording.
- When the battery level becomes low, the lens might stop moving. Insert a charged battery pack and turn on the camera again.

On image data compatibility

- The camera conforms with DCF (Design rule for Camera File system) universal standard established by JEITA (Japan Electronics and Information Technology Industries Association).
- Sony does not guarantee that the camera will play back images recorded or edited with other equipment, or that other equipment will play back images recorded with the camera.

Warning on copyright

Television programs, films, videotapes, and other materials may be copyrighted. Unauthorized recording of such materials may be contrary to the provisions of the copyright laws.

No compensation for damaged content or recording failure

Sony cannot compensate for failure to record or loss or damage of recorded content due to a malfunction of the camera or recording media, etc.

Getting started

Checking the accessories supplied

- Battery charger BC-CSGB/BC-CSGC (1)

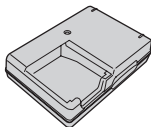

- Power cord (mains lead) (1)
(not supplied in the USA and Canada)



- Rechargeable battery pack NP-BG1 (1)/
Battery case (1)

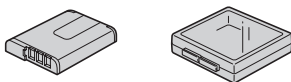

- USB, A/V cable for multi-use terminal (1)

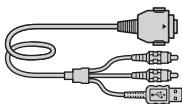

- Strap
Wrist strap (1) (DSC-W110/W115/W120/
W130)

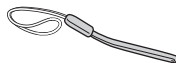

- Neck strap (1) (DSC-W125)



- Soft carrying case (1) (DSC-W115/W125
only)

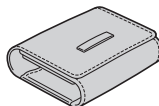

- CD-ROM (1)
 - Cyber-shot application software
 - “Cyber-shot Handbook”
 - “Cyber-shot Step-up Guide”
- Instruction Manual (this manual) (1)

Attach the strap and place your hand through the loop to prevent the camera from damage by being dropped.

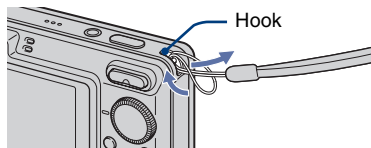

1 Preparing the battery pack

For customers in the USA and Canada

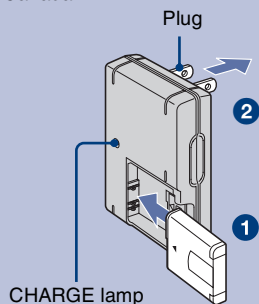

For customers in countries/regions other than the USA and Canada

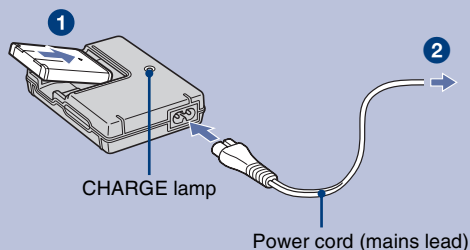

1 Insert the battery pack into the battery charger.

2 Connect the battery charger to the wall outlet (wall socket).

The CHARGE lamp lights up, and charging starts.

When the CHARGE lamp turns off, charging is finished (Normal charge).

If you continue charging the battery pack for about one more hour (until it is fully charged), the charge will last slightly longer.

Charging time

Full charge time	Normal charge time
Approx. 330 min.	Approx. 270 min.

- The table above shows the time required to charge a fully depleted battery pack at a temperature of 25°C (77°F). Charging may take longer depending on conditions of use and circumstances.
- See page 30 for the number of images that can be recorded.
- Connect the battery charger to the nearest wall outlet (wall socket).
- Even if the CHARGE lamp is not lit, the battery charger is not disconnected from the AC power source (mains) as long as it is connected to the wall outlet (wall socket). If some trouble occurs while using the battery charger, immediately shut off the power by disconnecting the plug from the wall outlet (wall socket).
- When charging is finished, disconnect the power cord (mains lead) from the wall outlet (wall socket), and remove the battery pack from the battery charger.
- Designed for use with compatible Sony batteries.

2 Inserting the battery pack/a “Memory Stick Duo” (not supplied)

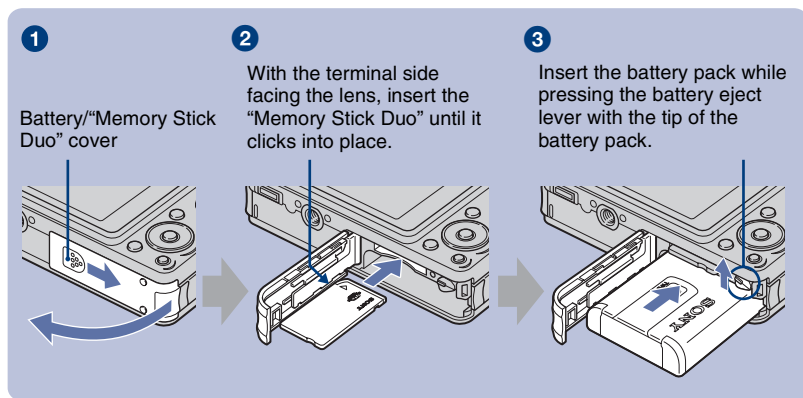

- 1** Open the battery/“Memory Stick Duo” cover.
- 2** Insert the “Memory Stick Duo” (not supplied).
- 3** Insert the battery pack.
- 4** Close the battery/“Memory Stick Duo” cover.

When there is no “Memory Stick Duo” inserted

The camera records/plays back images using the internal memory (approx. 15 MB).

To check the remaining battery charge

Press POWER to turn on and check the remaining battery charge on the LCD screen.

Remaining charge indicator					
Status	Sufficient power remaining	Battery almost fully charged	Battery half full	Battery low, recording/playback will stop soon.	Change the battery with fully charged one, or charge the battery. (The warning indicator flashes.)

- If you use the NP-FG1 battery pack (not supplied), the minutes also appear after the battery remaining indicator (60 Min).
- It takes about one minute until the correct remaining charge indicator appears.
- The remaining charge indicator may not be correct depending on conditions of use and circumstances.
- The Clock Set screen appears when you turn on the camera for the first time (page 13).

I To remove the battery pack/“Memory Stick Duo”

Open the battery/“Memory Stick Duo” cover.

“Memory Stick Duo”

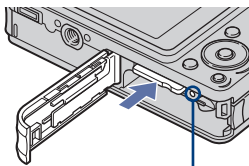

Make sure that **the access lamp** is not lit, then push the “Memory Stick Duo” in once.

Battery pack

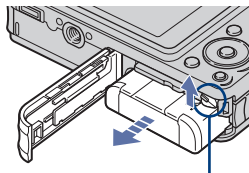

Slide **the battery eject lever**. Be sure not to drop the battery pack.

- Never remove the battery pack/“Memory Stick Duo” when the access lamp is lit. This may cause damage to data in the “Memory Stick Duo”/internal memory.

3 Turning the camera on/setting the clock

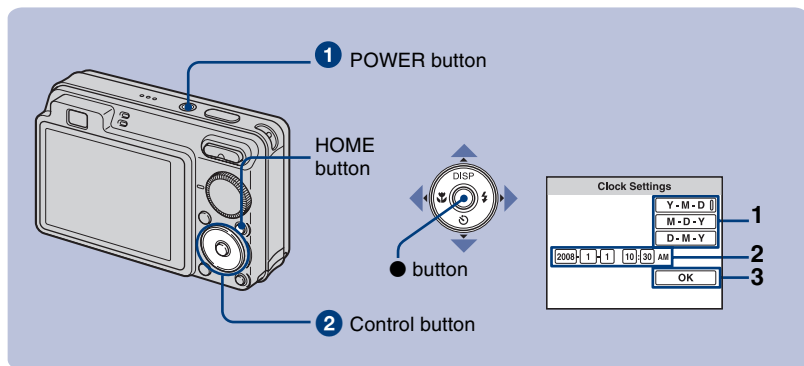

1 Press POWER.

2 Set the clock with the control button.

- 1 Select the date display format with ▲/▼, then press ●.
- 2 Select each item with ◀/▶ and set the numeric value with ▲/▼, then press ●.
- 3 Select [OK], then press ●.

- The camera does not have a feature for superimposing dates on images. By using “Picture Motion Browser” in the CD-ROM (supplied), you can print or save images with the date.
- Midnight is indicated as 12:00 AM, and noon as 12:00 PM.

To change the date and time

Press HOME, and select [⌚ Clock Settings] in  (Settings) (pages 21, 22).

Notes on when the power is turned on

- Once the battery pack is inserted in the camera, it may take time before operation becomes possible.
- If the camera is running on battery power and you do not operate the camera for about three minutes, the camera turns off automatically to prevent wearing down the battery pack (Auto power-off function).

Shooting images easily

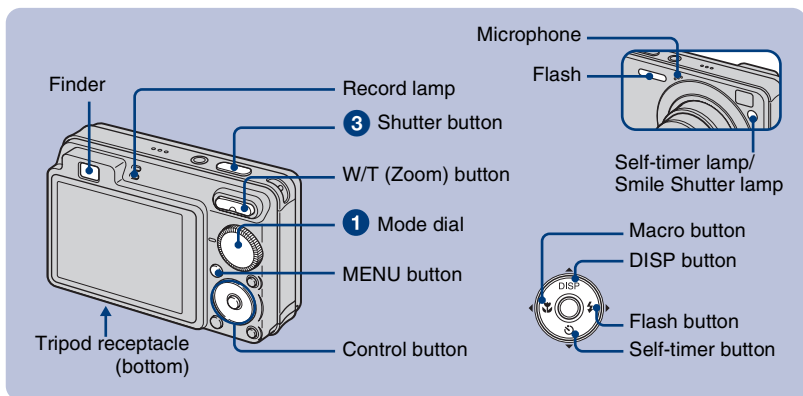

1 Select the desired function from the mode dial.

When shooting still images (Auto Adjustment mode): Select .

When shooting movies: Select .

2 Hold the camera, with your elbows pressed against your body to steady it.



Position the subject in the center of the focus frame.

3 Shoot with the shutter button.

When shooting still images:

1 Press and hold the shutter button halfway down to focus.

The ● (AE/AF lock) indicator (green) flashes, a beep sounds, the indicator stops flashing and remains lit.

2 Press the shutter button fully down.

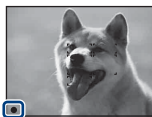

AE/AF lock indicator

When shooting movies:

Press the shutter button fully down.

To stop recording, press the shutter button fully down again.

• The shortest shooting distance is approx. 4 cm (1 5/8 inches) (W)/50 cm (1 foot 7 3/4 inches) (T) (from the lens).

Mode dial/Zoom/Flash/Macro/Self-timer/Display

Using the mode dial

Set the mode dial to the desired function.

Auto Adjustment

Allows you to shoot with the settings adjusted automatically.

EASY Easy Shooting

Allows easy shooting with easy-to-see indicators.

P Program Auto

Allows you to shoot with the exposure adjusted automatically (both the shutter speed and the aperture value). You can adjust other settings using the menu.

Movie Mode

Allows you to record movies with audio.

High Sensitivity

Shoots images without a flash even in low lighting.

Smile Shutter

When the camera detects a smile, the shutter is released automatically (page 17).

Soft Snap

Shoots images with a softer atmosphere for portraits of people, flowers, etc.

Landscape

Shoots with the focus on a distant subject.

Twilight Portrait

Shoots sharp images of people in a dark place without losing the nighttime atmosphere.

SCN* Scene Selection

Selects a setting from the Scene Selection menu.

* Scene Selection in SCN mode

Press MENU and select a setting.

Twilight

Shoots night scenes without losing the nighttime atmosphere.

Beach

Shoots seaside or lakeside scenes with the blueness of the water captured more vividly.

Snow

Shoots snow scenes in white more clearly.

Fireworks

Shoots fireworks in all their splendor.

I/W/T Using the zoom

Press T to zoom, press W to undo zoom.

I/⚡ Flash (Selecting a flash mode for still images)

Press (⚡) on the control button repeatedly until the desired mode is selected.

AUTO: Flash Auto

Flashes when there is insufficient light or backlight (default setting)

: Flash forced on

SL: Slow synchro (Flash forced on)

The shutter speed is slow in a dark place to clearly shoot the background that is out of flash light.

OFF: Flash forced off

I/🌸 Macro (Shooting close-up)

Press (🌸) on the control button repeatedly until the desired mode is selected.

AUTO: Auto

The camera adjusts the focus automatically from distant subjects to close-up.

Normally, put the camera in this mode.

: Macro

The camera adjusts the focus with priority on close-up subjects. Set Macro On when shooting close subjects.

I/⌚ Using the self-timer

Press (⌚) on the control button repeatedly until the desired mode is selected.

OFF: Not using the self-timer

10: Setting the 10-second delay self-timer

2: Setting the 2-second delay self-timer

When you press the shutter button, the self-timer lamp flashes and a beep sounds until the shutter operates.

I/DISP Changing the screen display

Press (DISP) on the control button.

Each time you press (DISP), the display and brightness changes as follows:

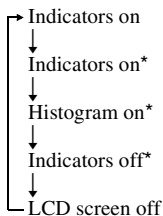

* The brightness of LCD Backlight is set to up.

Shooting in Smile Shutter mode

When the camera detects a smile, the shutter is released automatically.

- 1 Select ☺ (Smile Shutter) mode from the mode dial.**
- 2 Aim the camera at the subject and press the shutter button halfway down to focus.**
- 3 Press the shutter button all the way down to set Smile Detection mode.**

The Smile Shutter enters standby.

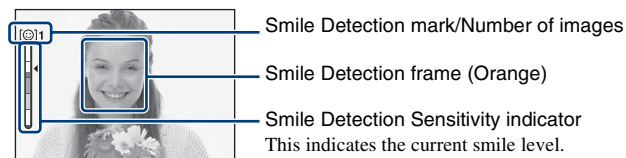

When the smile level reaches the set Smile Detection Sensitivity (indicated by ◀), the camera automatically operates the shutter and records up to six images. After recording the image, the Smile Shutter lamp lights.



- 4 Press the shutter button all the way down again to exit the Smile Shutter mode.**

- When the Smile Shutter is in standby, the Record lamp (Orange) flashes.
- Shooting using the Smile Shutter ends automatically when either the “Memory Stick Duo” or internal memory becomes full or when six images have been recorded.
- You can select the subject that has priority for smile detection with [Smile Detection] (page 24).
- If a smile is not detected, set the [Smile Detection Sensitivity] (page 24).
- You can have the camera shoot the image automatically when any person displayed in the smile detection frame (Orange) smiles after pressing the shutter button all the way down.
- The image may not be in focus if the distance between the camera and the subject is changed after pressing the shutter button all the way down. The suitable exposure may not be obtained if the surrounding brightness changes.
- Faces may not be detected correctly when:
 - It is too dark or too bright.
 - Faces are partially hidden by sunglasses, masks, hats, etc.
 - The subjects are not facing the camera.
- Smiles may not be detected correctly depending on the conditions.
- You cannot use the Digital Zoom function.
- You cannot change the zoom ratio when the Smile Shutter is in standby.

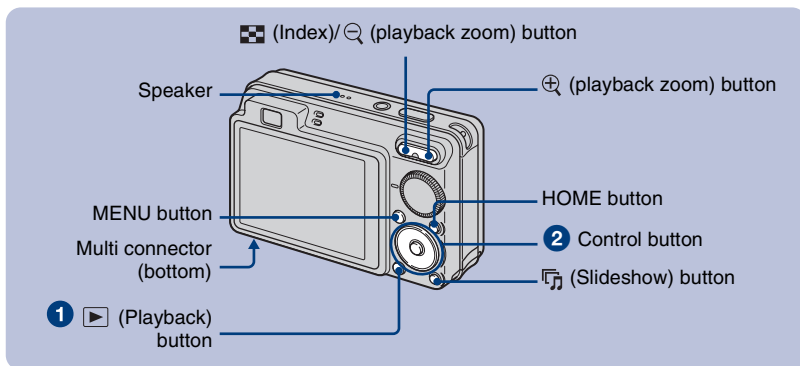
Viewing/deleting images







1 Press (Playback).



If you press  when the camera is powered off, the camera is turned on automatically and set to playback mode. To switch to the shooting mode, press  again.

2 Select an image with / on the control button.

Movie:







Press  to play back a movie. (Press  again to stop playback.)



Press  to fast forward,  to rewind. (Press  to return to normal playback.)

Press  to display the volume control screen, then press /  to adjust the volume.



To delete images





1 Display the image you want to delete, then press MENU.

2 Select  [Delete] with /  and select [This Image] with / , then press .

3 Select [OK] with , then press .

To view an enlarged image (playback zoom)



Press  while displaying a still image. To undo the zoom, press .

Adjust the position with / / / .



To cancel the playback zoom, press .

To view an index screen

Press  (Index) to display the index screen while a still image is displayed.

Then, select an image with ///.





To return to the single image screen, press .

- You can also access the index screen by selecting [ Image Index] in  (View Images) on the HOME screen.
- Each time you press  (Index), the number of images on the index screen increases.

To delete images in index mode

1 Press MENU while the index screen is displayed.

2 Select  [Delete] with / and select [Multiple Images] with /, then press .

3 Select the image you want to delete with ///, then press .

The  mark is checked in the checkbox of the image.

To cancel a selection, select an image you have selected for deletion, then press  again.

4 Press MENU and select [OK] with , then press .

- To delete all the images in a folder, select [All In This Folder], then press  in step 2.

To play back a series of images with effects and music (Slideshow)



1 Press  (Slideshow) button.

The setup screen appears.

2 Press  (Slideshow) button again.

The music will change together with the [Effects]. You can also transfer and change the music to your desired music.

To transfer and change the music, take the following steps.

- ① Press HOME button. Then select [ Music Tool] → [Download Music] in  [Slideshow] (pages 21, 22).
- ② Install the software included in the CD-ROM (supplied) to your computer.
- ③ Connect the camera and a computer with USB cable.
- ④ Start up “Music Transfer” installed to your computer and change the music.
For details on changing the music, refer to Help in “Music Transfer”.

To view images on TV

Connect the camera to the TV with the cable for multi-use terminal (supplied).

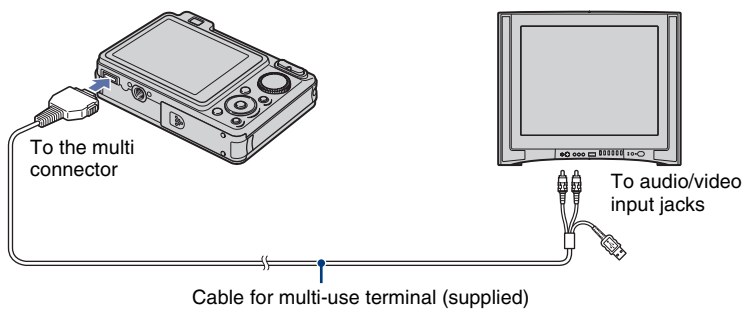

To view on HD (High Definition) TV, an HD Output Adaptor Cable (not supplied) is needed.

- If you set the image size to [16:9], you can record images in the size that fills the entire screen of the HD TV.
- You cannot view movies output in [HD(1080i)] signal format. Set [COMPONENT] to [SD] when shooting movies.

Learning the various functions – HOME/Menu

Using the HOME screen

The HOME screen is the gateway screen for all the functions of the camera, and can be called up regardless of the mode setting (shooting/viewing).

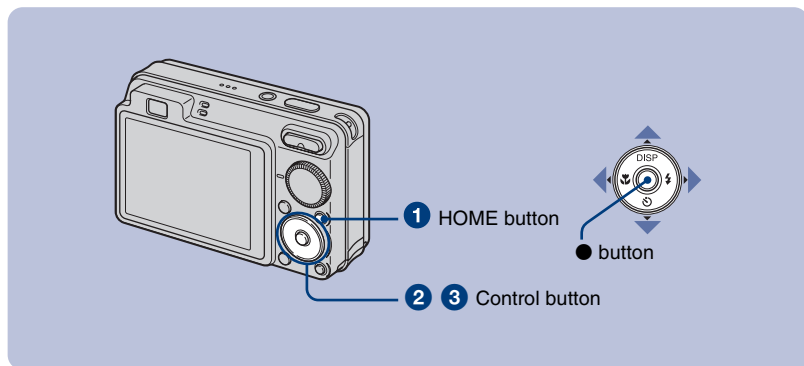

1 Press HOME to display the HOME screen.

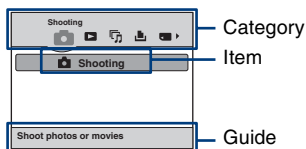

2 Select a category with ◀▶ on the control button.

3 Select an item with ▲▼, then press ●.

! When you select the 🗑️ (Manage Memory) or ⚙️ (Settings) category

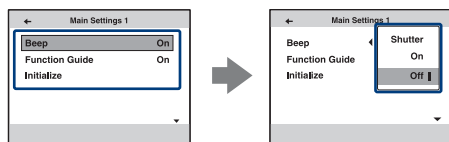

1 Select the desired setting with ▲▼, then press ●.







• HOME screen is displayed by pressing ◀.

2 Select a setting with ▲▼, then press ●.

• The camera is set to the shooting or viewing mode by pressing HOME again.

HOME items

Pressing HOME displays the following items. Details on the items are displayed on the screen by the guide.

Categories	Items
 Shooting	Shooting
 View Images	Single Image Image Index
 Slideshow	Slideshow Music Tool Download Music Format Music
 Print	Print
 Manage Memory	Memory Tool Memory Stick Tool Format Create REC. Folder Change REC. Folder Copy Internal Memory Tool Format
 Settings	Main Settings Main Settings 1 Beep Function Guide Initialize Main Settings 2 USB Connect COMPONENT Video Out Wide Zoom Display Shooting Settings Shooting Settings 1 AF Illuminator Grid Line AF Mode Digital Zoom Conversion Lens Shooting Settings 2 Auto Orientation* Auto Review Clock Settings Language Setting

* DSC-W120/W125/W130 only.

Using menu items

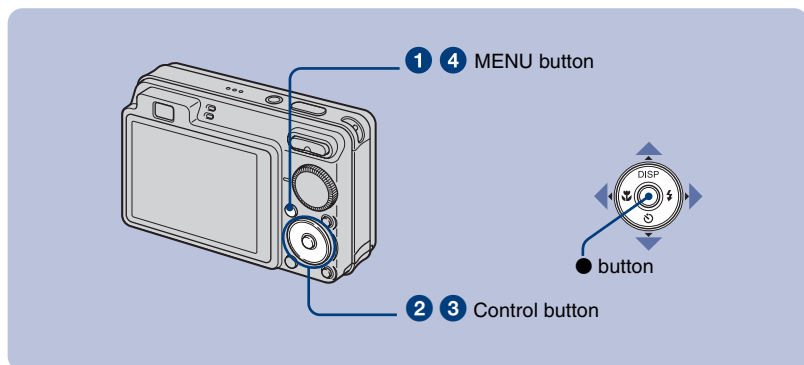

1 Press MENU to display the menu.

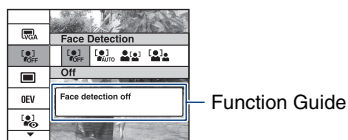

- The menu will be displayed only during shooting and playback mode.
- Different items will become visible depending on the selected mode.

2 Select a desired menu item with ▲/▼ on the control button.

- If the desired item is hidden, keep pressing ▲/▼ until the item appears on the screen.

3 Select a setting with ◀/▶.

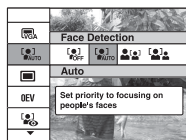

- If the desired item is hidden, keep pressing ◀/▶ until the item appears on the screen.
- Select an item in playback mode, and press ●.

4 Press MENU to turn off the menu.









Menu items

The available menu items vary depending on the mode setting (shooting/viewing), and the mode dial position in the shooting mode. Only the available items are displayed on the screen.

Shooting menu

Scene Selection	Selects the settings pre-adjusted to match various scene conditions.
Image Size	Selects the image size.
Flash	Selects the flash setting in Easy Shooting mode.
Face Detection	Selects the priority subject for adjusting the focus when using face detection.
Smile Detection	Selects the priority subject for the Smile Shutter function.
Smile Detection Sensitivity	Sets the level of sensitivity to detect smile.
REC Mode	Selects the continuous shooting method.
EV	Adjusts Exposure.
ISO	Selects the luminous sensitivity.
Metering Mode	Selects the metering mode.
Focus	Changes the focus method.
White Balance	Adjusts the color tones.
Flash Level	Adjusts the amount of flash light.
Red Eye Reduction	Sets to reduce red-eye phenomenon.
Color Mode	Changes the vividness of the image or adds special effects.
SteadyShot (DSC-W120/W125/W130 only)	Selects the anti-blur mode.
 Shooting Settings	Selects the shooting settings.

Viewing menu

 (Delete)	Deletes images.
 (Slideshow)	Plays back a series of images with effects and music.
 (Retouch) (DSC-W130 only)	Retouches still images.
 (Multi-Purpose Resize) (DSC-W130 only)	Changes the image size according to usage.
 (Protect)	Prevents accidental erasure.
DPOF	Adds a Print order mark on image that you want to print out.
 (Print)	Prints images using a PictBridge compliant printer.
 (Rotate)	Rotates a still image.
 (Select Folder)	Selects the folder for viewing images.

Enjoying your computer

You can view images shot with the camera on a computer. By using the software in the CD-ROM (supplied), you can enjoy still images and movies from the camera more than ever. For details, refer to “Cyber-shot Handbook” in the CD-ROM (supplied).

Supported Operating Systems for USB connection and application software (supplied)

	For Windows users	For Macintosh users
USB connection	Windows 2000 Professional SP4, Windows XP* SP2, Windows Vista*	Mac OS 9.1/9.2/ Mac OS X(v10.1 to v10.5)
Application software “Picture Motion Browser”	Windows 2000 Professional SP4, Windows XP* SP2, Windows Vista*	not compatible

* 64-bit editions and Starter (Edition) are not supported.

- Your computer must be pre-installed with an OS listed above. OS upgrades are not supported.
- If your OS does not support USB connections, copy images by inserting the “Memory Stick Duo” into the Memory Stick slot on your computer, or use a commercially available Memory Stick Reader/Writer.
- For further details on the operating environment of “Picture Motion Browser” Cyber-shot application software, refer to “Cyber-shot Handbook”.



Viewing “Cyber-shot Handbook”

“Cyber-shot Handbook” in the CD-ROM (supplied) explains how to use the camera in detail. Adobe Reader is required to view it.

For Windows users

- 1 Turn on your computer, and insert the CD-ROM (supplied) into the CD-ROM drive. The screen below appears.



When you click the [Cyber-shot Handbook] button, the screen for copying “Cyber-shot Handbook” appears.

- 2 Follow the on-screen instructions to copy.
 - When you install “Cyber-shot Handbook”, the “Cyber-shot Step-up Guide” will be installed automatically.
- 3 After the installation is complete, double-click the shortcut created on the desktop.

For Macintosh users

- 1 Turn on your computer, and insert the CD-ROM (supplied) into the CD-ROM drive.
- 2 Select the [Handbook] folder and copy “Handbook.pdf” stored in the [GB] folder to your computer.
- 3 After copying is complete, double-click “Handbook.pdf”.

Indicators on the screen

Each time you press ▲ (DISP) on the control button, the display changes (page 16).

When shooting still images

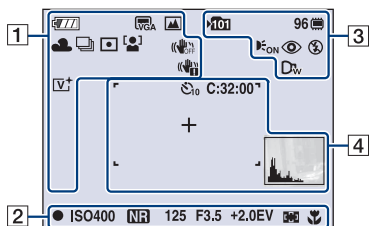

- The indicators are limited in Easy Shooting mode.

When shooting movies

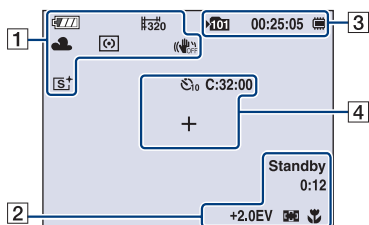

When playing back

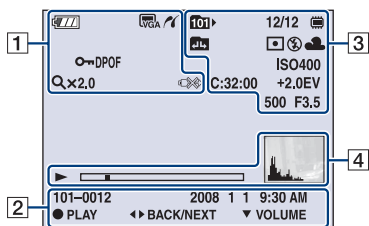

1

	Battery remaining
	Low battery warning
	Image size <ul style="list-style-type: none"> • 8M is for DSC-W130 only. • 7M is for DSC-W110/W115/W120/W125 only.
	Mode dial/Menu (Scene Selection)
P	Mode dial (Program Auto)
	White balance
	Recording mode/Bracket mode <ul style="list-style-type: none"> • Bracket mode is for DSC-W130 only.
	Metering mode
	Face Detection/Smile Detection
	SteadyShot (DSC-W120/W125/W130 only)
	Vibration warning
	Smile Detection Sensitivity indicator/Number of images
	Zoom scaling
	Color mode
	PictBridge connecting
	Protect
	Volume
	Print order (DPOF) mark
	Zoom scaling
	PictBridge connecting

2

	AE/AF lock
ISO400	ISO number
	NR slow shutter
125	Shutter speed
F3.5	Aperture value
+2.0EV	Exposure Value
	AF range finder frame indicator
1.0m	Semi manual value
	Macro
REC Standby	Recording a movie/Standby a movie
0:12	Recording time (minutes : seconds)
101-0012	Folder-file number
2008 1 1 9:30 AM	Recorded date/time of the playback image
STOP PLAY	Function guide for playing image
BACK/NEXT	Selecting images
VOLUME	Adjusting volume

3

	Recording folder
	Playback folder
96	Number of recordable images
12/12	Image number/Number of images recorded in selected folder
	Recording/playback Media (“Memory Stick Duo”, Internal memory)

00:25:05	Recordable time (hours : minutes : seconds)
	Changing folder
	AF illuminator
	Red-eye reduction
	Metering mode
	Flash mode
	Flash charging
AWB	White balance
C:32:00	Self-diagnosis display
ISO400	ISO number
+2.0EV	Exposure Value
500	Shutter speed
F3.5	Aperture value
	Conversion lens

4

C:32:00	Self-diagnosis display
	Self-timer
	AF range finder frame
+	Spot metering cross hair
	Playback
	Playback bar
	Histogram <ul style="list-style-type: none"> appears when histogram display is disabled.

Battery life and memory capacity

Battery life and number of images you can record/view

The numbers shown in the following tables assume a fully charged battery pack (supplied) is used at an ambient temperature of 25°C (77°F). The numbers shown for images you can record/view are approximations and allow for changing of the “Memory Stick Duo” as necessary. Note that the actual numbers may be less than those indicated in the table depending on the conditions of use.

When shooting still images

LCD screen	Battery life (min.)	No. of Images
DSC-W130		
On	Approx. 185	Approx. 370
Off	Approx. 225	Approx. 450
DSC-W120/W125		
On	Approx. 175	Approx. 350
Off	Approx. 215	Approx. 430
DSC-W110/W115		
On	Approx. 210	Approx. 420
Off	Approx. 260	Approx. 520

- Shooting in the following situations:
 - [REC Mode] is set to [Normal].
 - [AF Mode] is set to [Single].
 - [SteadyShot] is set to [Shooting].
 - Shooting once every 30 seconds.
 - The zoom is switched alternately between the W and T ends.
 - The flash strobes once every two times.
 - The power turns on and off once every ten times.
- The measurement method is based on the CIPA standard.
(CIPA: Camera & Imaging Products Association)
- The battery life and the number of images do not change, regardless of image size.

When viewing still images

Battery life (min.)	No. of Images
DSC-W130	
Approx. 410	Approx. 8200
DSC-W120/W125	
Approx. 400	Approx. 8000
DSC-W110/W115	
Approx. 480	Approx. 9600

- Viewing single images in order at about three second intervals

Notes on the battery pack

- Battery capacity decreases over time and through repeated use.
- The battery life and the number of images you can record/view are decreased under the following conditions:
 - The surrounding temperature is low.
 - The flash is used frequently.
 - The camera has been turned on and off many times.
 - The zoom is used frequently.
 - The brightness of LCD Backlight is set to up.
 - [AF Mode] is set to [Monitor].
 - [SteadyShot] is set to [Continuous].
 - The battery power is low.
 - The Face Detection function is activated.

Number of still images and recording time of movies

The number of still images and the length of time for movies may vary depending on the shooting conditions.

- Even if the capacity of your recording media is the same as the one in the table below, the number of still images and the length of time for movies may be different.
- You can select the image size from the menu (pages 23, 24).

The approximate recordable number of still images

DSC-W130

(Units: Images)

Capacity Size	Internal memory	"Memory Stick Duo" formatted with the camera						
	Approx. 15 MB	256 MB	512 MB	1 GB	2 GB	4 GB	8 GB	16 GB
8M	4	72	150	306	618	1223	2457	4981
5M	6	92	191	390	787	1557	3127	6340
3M	10	148	306	626	1262	2498	5017	10171
VGA	96	1428	2941	6013	12121	23983	48166	97646
3:2 (7M)	4	73	151	309	624	1236	2482	5033
16:9 (6M)	5	77	159	326	658	1303	2617	5306
16:9 (2M)	16	238	490	1002	2020	3997	8027	16274

DSC-W110/W115/W120/W125

(Units: Images)

Capacity Size	Internal memory	"Memory Stick Duo" formatted with the camera						
	Approx. 15 MB	256 MB	512 MB	1 GB	2 GB	4 GB	8 GB	16 GB
7M	5	74	153	313	631	1249	2508	5085
5M	6	92	191	390	787	1557	3127	6340
3M	10	148	306	626	1262	2498	5017	10171
VGA	96	1428	2941	6013	12121	23983	48166	97646
3:2 (6M)	5	74	153	313	631	1249	2508	5085
16:9 (5M)	5	88	181	371	748	1480	2973	6027
16:9 (2M)	16	238	490	1002	2020	3997	8027	16274

- The numbers of images listed assume [REC Mode] is set to [Normal].
- When the number of remaining shootable images is greater than 9,999, the ">9999" indicator appears.
- When an image was recorded using an earlier Sony model and is played back on the camera, the image may not appear in the actual image size.

The approximate recordable time of movies

The numbers in the table below show the approximate maximum recordable time obtained by totaling all movie files. The maximum length of time you can shoot continuously is about 10 minutes.

(Units: hour : minute : second)

Capacity Size	Internal memory	"Memory Stick Duo" formatted with the camera						
	Approx. 15 MB	256 MB	512 MB	1 GB	2 GB	4 GB	8 GB	16 GB
640(Fine)	–	0:02:50	0:06:00	0:12:30	0:25:10	0:49:50	1:40:20	3:23:20
640(Standard)	0:00:40	0:10:40	0:22:00	0:45:00	1:30:50	2:59:50	6:01:10	12:12:20
320	0:02:50	0:42:50	1:28:10	3:00:20	6:03:30	11:59:30	24:04:50	48:49:20

- Movies with the size set to [640(Fine)] can only be recorded on a "Memory Stick PRO Duo".
- The camera does not support HD recordings or playbacks for movies.

Troubleshooting

If you experience trouble with the camera, try the following solutions.

1 Check the items below, and refer to “Cyber-shot Handbook” (PDF).

If a code such as “C/E:□□:□□” appears on the screen, refer to “Cyber-shot Handbook”.

2 Remove the battery pack, wait for about one minute, re-insert the battery pack, then turn on the power.

3 Initialize the settings (page 22).

4 Consult your Sony dealer or local authorized Sony service facility.

Be aware that by sending the camera for repair, you give consent that the contents of the internal memory, Music files may be checked.

Battery pack and power

Cannot insert the battery pack.

- Insert the battery pack correctly to push the battery eject lever (page 11).

Cannot turn on the camera.

- After inserting the battery pack into the camera, it may take a few moments for the camera to power up.
- Insert the battery pack correctly (page 11).
- The battery pack is discharged. Insert charged battery pack (page 10).
- The battery pack is dead. Replace it with a new one.
- Use a recommended battery pack.

The power turns off suddenly.

- If you do not operate the camera for about three minutes while the power is on, the camera turns off automatically to prevent wearing down the battery pack. Turn on the camera again (page 13).
- The battery pack is dead. Replace it with a new one.

The remaining charge indicator is incorrect.



- This phenomenon occurs when you use the camera in an extremely hot or cold location.
- A discrepancy arose between the remaining charge indicator and the actual remaining battery charge. Fully discharge the battery pack once, then charge it to correct the indication.
- The battery pack is discharged. Insert the charged battery pack (page 10).
- The battery pack is dead. Replace it with a new one.

Cannot charge the battery pack.

- You cannot charge the battery pack using the AC Adaptor (not supplied). Use the battery charger to charge the battery.

Shooting still images/movies

Cannot record images.

- Check the free capacity of the internal memory or “Memory Stick Duo” (page 31). If it is full, do one of the following:
 - Delete unnecessary images (page 18).
 - Change the “Memory Stick Duo”.
- You cannot record images while charging the flash.
- When shooting a still image, set the mode dial to a position other than .
- Set the mode dial to  when shooting movies.
- The image size is set to [640(Fine)] when recording movies. Do one of the following:
 - Set the image size to other than [640(Fine)].
 - Insert a “Memory Stick PRO Duo”.
- In  (Smile Shutter) mode, no image is shot unless a smile is detected.

Vertical streaks appear when you are shooting a very bright subject.

- The smear phenomenon is occurring and white, black, red, purple, or other streaks appear on the image. This phenomenon is not a malfunction.

Viewing images

Cannot play back images.

- Press  (Playback) (page 18).
- The folder/file name has been changed on your computer.
- Sony does not guarantee playback of image files on the camera if the files have been processed using a computer or recorded with another camera.
- The camera is in USB mode. Delete the USB connection.
- Playback is impossible if the Smile Shutter is in standby mode. Exit standby mode by pressing the shutter button all the way down.

Precautions

Do not use/store the camera in the following places

- In an extremely hot, cold or humid place
In places such as in a car parked in the sun, the camera body may become deformed and this may cause a malfunction.
- Under direct sunlight or near a heater
The camera body may become discolored or deformed, and this may cause a malfunction.
- In a location subject to rocking vibration
- Near strong magnetic place
- In sandy or dusty places
Be careful not to let sand or dust get into the camera. This may cause the camera to malfunction, and in some cases this malfunction cannot be repaired.

On carrying

Do not sit down in a chair or other place with the camera in the back pocket of your trousers or skirt, as this may cause malfunction or damage the camera.

On cleaning

Cleaning the LCD screen

Wipe the screen surface with an LCD cleaning kit (not supplied) to remove fingerprints, dust, etc.

Cleaning the lens

Wipe the lens with a soft cloth to remove fingerprints, dust, etc.

Cleaning the camera surface

Clean the camera surface with a soft cloth slightly moistened with water, then wipe the surface with a dry cloth. To prevent damage to the finish or casing:

- Do not expose the camera to chemical products such as thinner, benzine, alcohol, disposable cloths, insect repellent, sunscreen or insecticide.
- Do not touch the camera with any of the above on your hand.
- Do not leave the camera in contact with rubber or vinyl for a long time.

On operating temperatures

The camera is designed for use under the temperatures between 0°C and 40°C (32°F and 104°F). Shooting in extremely cold or hot places that exceed this range is not recommended.

On moisture condensation

If the camera is brought directly from a cold to a warm location, moisture may condense inside or outside the camera. This moisture condensation may cause a malfunction of the camera.

If moisture condensation occurs

Turn off the camera and wait about an hour for the moisture to evaporate. Note that if you shoot with moisture remaining inside the lens, images will not be clear.

On the internal rechargeable backup battery

The camera has an internal rechargeable battery for maintaining the date and time and other settings regardless of whether the power is on or off.

This rechargeable battery is continually charged as long as you are using the camera. However, if you use the camera for only short periods, it discharges gradually, and if you do not use the camera at all for about one month it becomes completely discharged. In this case, be sure to charge this rechargeable battery before using the camera.

However, even if this rechargeable battery is not charged, you can still use the camera, but the date and time will not be indicated.

Charging method of the internal rechargeable backup battery

Insert charged battery pack in the camera, and then leave the camera for 24 hours or more with the power off.

Specifications

Camera

[System]

Image device:

DSC-W130

7.18 mm (1/2.5 type) color CCD, Primary color filter

DSC-W110/W115/W120/W125

7.20 mm (1/2.5 type) color CCD, Primary color filter

Total pixel number of camera:

DSC-W130

Approx. 8.3 Megapixels

DSC-W110/W115/W120/W125

Approx. 7.4 Megapixels

Effective pixel number of camera:

DSC-W130

Approx. 8.1 Megapixels

DSC-W110/W115/W120/W125

Approx. 7.2 Megapixels

Lens: Carl Zeiss Vario-Tessar 4× zoom lens

f = 5.35 – 21.4 mm (32 – 128 mm (35 mm film equivalent)) F2.8 (W) – F5.8 (T)

Exposure control: Automatic exposure, Scene

Selection (9 modes)

White balance: Automatic, Daylight, Cloudy,

Fluorescent 1,2,3, Incandescent, Flash

File format (DCF compliant):

Still images: Exif Ver. 2.21 JPEG compliant, DPOF compatible

Movies: MPEG1 compliant (Monaural)

Recording media: Internal Memory (approx.

15 MB), “Memory Stick Duo”

Flash: Flash range (ISO sensitivity

(Recommended exposure Index) set to Auto):

Approx. 0.2 to 3.9 m (7 7/8 inches to 12 feet 9 5/8 inches) (W)/approx. 0.5 to 1.9 m (1 foot 7 3/4 inches to 6 feet 2 7/8 inches) (T)

[Input and Output connectors]

Multi connector: Video output

Audio output (Monaural)

USB communication

USB communication: Hi-Speed USB (USB 2.0 compliant)

[LCD screen]

LCD panel: 6.2 cm (2.5 type) TFT drive

Total number of dots: 115 200 (480 × 240) dots

[Power, general]

Power: Rechargeable battery pack

NP-BG1, 3.6 V

NP-FG1 (not supplied), 3.6 V

AC-LS5K AC Adaptor (not supplied), 4.2 V

Power consumption (during shooting, LCD screen on):

DSC-W120/W125/W130

1.0 W

DSC-W110/W115

0.9 W

Operating temperature: 0 to 40°C (32 to 104°F)

Storage temperature: -20 to +60°C (-4 to +140°F)

Dimensions:

88.2 × 57.2 × 22.9 mm (3 1/2 ×

2 3/8 × 29/32 inches) (W/H/D, excluding protrusions)

Mass:

DSC-W110/W115/W120/W130

Approx. 156 g (5.5 oz) (including NP-BG1 battery pack, strap, etc.)

DSC-W125

Approx. 169 g (6.0 oz) (including NP-BG1 battery pack, strap, etc.)

Microphone: Monaural

Speaker: Monaural

Exif Print: Compatible

PRINT Image Matching III: Compatible

PictBridge: Compatible

BC-CSGB/BC-CSGC battery charger

Power requirements: AC 100 V to 240 V, 50/60 Hz, 2.6 W (BC-CSGB), 2 W (BC-CSGC)

Output voltage: DC 4.2 V, 0.25 A

Operating temperature: 0 to 40°C (32 to 104°F)

Storage temperature: -20 to +60°C (-4 to +140°F)

Dimensions: Approx. 62 × 24 × 91 mm (2 1/2 × 3 1/32 × 3 5/8 inches) (W/H/D)

Mass: Approx. 75 g (2.7 oz)

Rechargeable battery pack NP-BG1

Used battery: Lithium-ion battery

Maximum voltage: DC 4.2 V

Nominal voltage: DC 3.6 V

Capacity: 3.4 Wh (960 mAh)

Design and specifications are subject to change without notice.

Trademarks

- **Cyber-shot**, “Cyber-shot” are trademarks of Sony Corporation.
- “Memory Stick”, , “Memory Stick PRO”, **MEMORY STICK PRO**, “Memory Stick Duo”, **MEMORY STICK DUO**, “Memory Stick PRO Duo”, **MEMORY STICK PRO DUO**, “Memory Stick PRO-HG Duo”, **MEMORY STICK PRO-HG DUO**, “Memory Stick Micro”, “MagicGate”, and **MAGICGATE** are trademarks of Sony Corporation.
- “Info LITHIUM” is a trademark of Sony Corporation.
- “PhotoTV HD” is a trademark of Sony Corporation.
- Microsoft, Windows, DirectX and Windows Vista are either registered trademarks or trademarks of Microsoft Corporation in the United States and/or other countries.
- Macintosh, Mac OS, iMac, iBook, PowerBook, Power Mac and eMac are trademarks or registered trademarks of Apple Inc.
- Intel, MMX, and Pentium are trademarks or registered trademarks of Intel Corporation.
- Adobe and Reader are either registered trademarks or trademarks of Adobe Systems Incorporated in the United States and/or other countries.
- In addition, system and product names used in this manual are, in general, trademarks or registered trademarks of their respective developers or manufacturers. However, the ™ or © marks are not used in all cases in this manual.

Additional information on this product and answers to frequently asked questions can be found at our Customer Support Website.

<http://www.sony.net/>



Printed on 70% or more recycled paper using VOC (Volatile Organic Compound)-free vegetable oil based ink.

Printed in China



3700780110