

SONY®

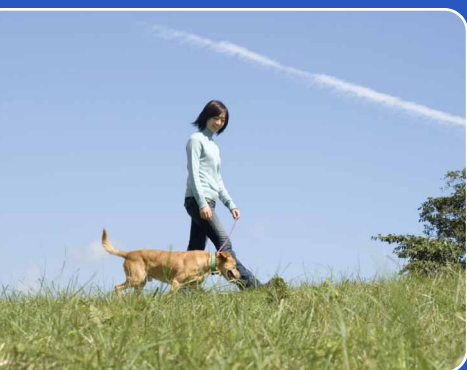

Table of contents

Operation Search

MENU/Settings Search

Index

Cyber-shot

Cyber-shot Handbook

DSC-W180/W190

How to use this handbook

Click on a button at upper right to jump to the corresponding page.
This is convenient when searching for a function you want to view.



← Search for information by function.

← Search for information by operation.

← Search for information in a listing of MENU/Settings items.

← Search for information by keyword.

Table of contents

Operation Search

MENU/Settings Search

Index

Marks and notations used in this handbook

Red Eye Reduction

The flash strobos two or more times before shooting to reduce the red-eye phenomenon when using the flash.

1 MENU → (Red Eye Reduction) → desired mode

☑	(Auto)	When the Face Detection function is activated, the flash strobos automatically to reduce the red-eye phenomenon.
	(On)	The flash always strobos to reduce the red-eye phenomenon.
	(Off)	Does not use Red Eye Reduction.

Notes

- [Red Eye Reduction] cannot be selected during Movie Mode or Smile Shutter.
- To avoid blurring of images, hold the camera firmly until the shutter is released. It usually takes a second after you press the shutter button. Be also sure not to allow the subject to move during this period.
- Red Eye Reduction may not produce the desired effects. It depends on individual differences and conditions, such as distance to the subject, or if the subject looked away from the pre-strobe.
- If you do not use the Face Detection function, Red Eye Reduction does not work, even when you select [Auto].

What causes the red-eye phenomenon?

Pupils become dilated in dark environments. Flash light is reflected off the blood vessels at the back of the eye (retina), causing the "red-eye" phenomenon.

In this handbook, the sequence of operations is shown by arrows (→). Operate the camera in the order indicated. Marks are shown as they appear in the camera's default setting.

☑ The default setting is indicated by ☑.

Notes Indicates cautions and limitations relevant to the correct operation of the camera.

What causes the red-eye phenomenon? Indicates information that is useful to know.

Notes on using the camera

Notes on the types of “Memory Stick” media that you can use (sold separately)



“Memory Stick Duo” media: You can use a “Memory Stick Duo” media with the camera.



“Memory Stick” media: You cannot use a “Memory Stick” media with the camera.

Other memory cards cannot be used.

- For details on “Memory Stick Duo” media, see page 99.

When using a “Memory Stick Duo” media with “Memory Stick” media compatible equipment

You can use the “Memory Stick Duo” media by inserting it into the “Memory Stick Duo” media Adaptor (sold separately).



“Memory Stick Duo” media Adaptor

Notes on the battery pack

- Charge the battery pack (supplied) before using the camera for the first time.
- You can charge the battery pack even if it is not completely discharged. In addition, even if the battery pack is not fully charged, you can use the partially charged capacity of the battery pack as is.
- If you do not intend to use the battery pack for a long time, use up the existing charge and remove it from the camera, then store it in a cool, dry place. This is to maintain the battery pack functions.
- For details on the usable battery pack, see page 101.

Notes on the LCD screen and lens

- The LCD screen is manufactured using extremely high-precision technology so over 99.99% of the pixels are operational for effective use. However, some tiny black and/or bright dots (white, red, blue or green) may appear on the LCD screen. These dots are a normal result of the manufacturing process and do not affect the recording.

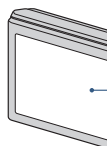

Black, white, red, blue or green dots

- Exposing the LCD screen or the lens to direct sunlight for long periods may cause malfunctions. Be careful when placing the camera near a window or outdoors.
- Do not press against the LCD screen. The screen may be discolored and that may cause a malfunction.
- Images may trail across on the LCD screen in a cold location. This is not a malfunction.
- Be careful not to bump the movable lens, and be careful not to apply force to it.

The images used in this Handbook

The images used as examples in this Handbook are reproduced images, and are not actual images shot using this camera.

Table of contents

Notes on using the camera

How to use this handbook	2
Notes on using the camera	3
Operation Search	7
MENU/Settings Search	9
Identifying parts	12
Using the mode switch	13
Changing the DISP (screen display) setting	14
Using the internal memory	16

Shooting

Auto Adjustment	17
Scene Selection	18
Movie	20
Program Auto	21
Smile Shutter	22
Zoom	23
Self-Timer	24
Macro	25
Flash	26

Viewing

Viewing still images	27
Playback zoom	28
Image Index	29
Delete	30
Viewing movies	31

MENU (Shooting)

MENU items (Shooting)	9
-----------------------------	---

MENU (Viewing)

MENU items (Viewing)	10
----------------------------	----

Settings

Setting items	11
---------------------	----

TV

Viewing images on a TV	69
------------------------------	----

Computer

Enjoying your Windows computer	71
Installing the software (supplied)	73
On “PMB (Picture Motion Browser)”	74
Enjoying images on your computer	75
Using your Macintosh computer	79
Viewing “Cyber-shot Step-up Guide”	81

Printing

Printing still images	82
Printing images directly using a PictBridge compliant printer	83
Printing at a shop	85

Troubleshooting

Troubleshooting	86
Warning messages	95

Others

Using the camera abroad — Power sources	98
On the “Memory Stick Duo” media	99
On the battery pack	101
On the battery charger	102

Index

Index	103
-------------	-----

Operation Search







Leaving the settings to the camera	Auto adjustment.....	17
	Scene Selection.....	18
Shooting portraits	Soft Snap	18
	Twilight Portrait	18
	Smile Shutter	22
	Face Detection	44
	Red Eye Reduction	46
Shooting close to objects	Macro	25
Shooting moving objects	Movie.....	20
	Burst.....	35
Shooting without blur	High Sensitivity.....	18
	2-second delay self-timer	24
	ISO.....	37
	SteadyShot.....	34
Shooting with backlight	Forced Flash.....	26
Shooting in dark places	High Sensitivity.....	18
	Slow Synchro.....	26
	ISO.....	37
Adjusting exposure	Histogram	15
	EV	36
Changing focus position	Focus	40
	Face Detection	44
Changing image size	Image Size.....	32

Deleting images	Delete.....	30
	Format	63
Displaying enlarged images	Playback zoom.....	28
	Trimming	50
Editing images	Retouch	50
	Multi-Purpose Resize	51
Playing back a series of images in order	Slideshow	48
Printing images with the date	Using the “PMB (Picture Motion Browser)”	74
Changing date and time settings	Clock Settings.....	67
Initializing settings	Initialize.....	59
Printing images	Print	82
Viewing on TVs	Viewing images on a TV.....	69
Information about optional accessories	“Cyber-shot Step-up Guide”	81

MENU/Settings Search







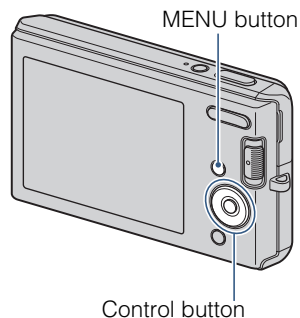

















MENU items (Shooting)

You can select the various shooting functions easily from the Menu button.

- 1 Set the mode switch to  (Still Image) or  (Movie) to switch to shooting mode.
- 2 Press the MENU button to display the Menu screen.
- 3 Select the desired menu item with /// on the control button.
- 4 Press the MENU button to turn off the Menu screen.



In the table below, ✓ indicates a function is available and — that it is unavailable. The icons below [Scene Selection] and  indicate the available modes.







Menu items	Mode switch 			
	Camera	AUTO	PGM	
Camera	✓	✓	✓	—
Image Size	✓	✓	✓	—
SteadyShot	✓	✓	   	—
REC Mode	✓	✓	   	—
EV	✓	✓	✓	✓
ISO	—	✓	—	—
White Balance	—	✓		✓
Focus	—	✓	—	—
Metering Mode	—	✓	—	✓
Smile Detection Sensitivity	✓	✓	    	—
Face Detection	✓	✓	   	—
Flash Level	—	✓	—	—
Red Eye Reduction	✓	✓	   	—
Color Mode	—	✓	—	✓
 (Settings)	✓	✓	✓	✓

Note

- Only the items that are available for each mode are displayed on the screen.







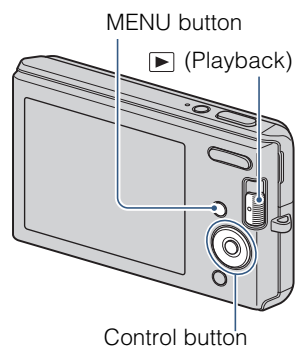

MENU items (Viewing)

You can select the various viewing functions easily from the Menu button.

- 1 Set the mode switch to  (Playback) to switch to playback mode.
- 2 Press the MENU button to display the Menu screen.
- 3 Select the desired menu item with /// on the control button.
- 4 Press  on the center of the control button.



In the table below, ✓ indicates a function is available and — that it is unavailable.









Menu items	"Memory Stick Duo" media	Internal Memory
 (Slideshow)	✓	✓
 (Retouch)	✓	✓
 (Multi-Purpose Resize)	✓	✓
 (Protect)	✓	✓
DPOF	✓	✓
 (Print)	✓	✓
 (Rotate)	✓	✓
 (Select Folder)	✓	—
 (Settings)	✓	✓

Note

- Only the items that are available for each mode are displayed on the screen.

Setting items

You can change the settings on the  (Settings) screen.

- 1 Press the MENU button to display the Menu screen.
- 2 Select  (Settings) with  on the control button, then press  on the center of the control button to display the setup screen.
- 3 Select each item with , , , or , then press .
- 4 Press the MENU button to turn off the Menu screen.

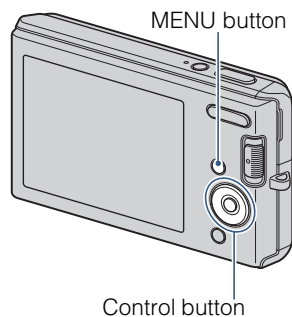

Categories	Items
Main Settings	Beep
	USB Connect
	Video Out
	Initialize
Shooting Settings	Grid Line
	Digital Zoom
	Auto Review
Internal Memory Tool	Format
“Memory Stick” Tool	Format
	Create REC.Folder
	Change REC.Folder
	Copy
Clock Settings	Clock Settings
Language Setting	Language Setting

Note

- [“Memory Stick” Tool] appears only when a “Memory Stick Duo” media is inserted in the camera, while [Internal Memory Tool] appears only when a “Memory Stick Duo” media is not inserted.

Identifying parts

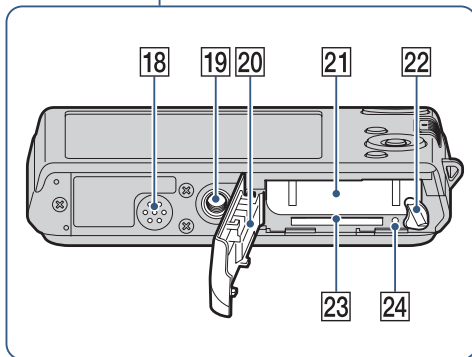
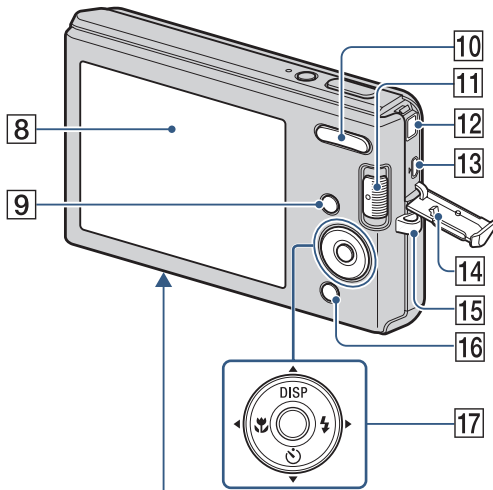
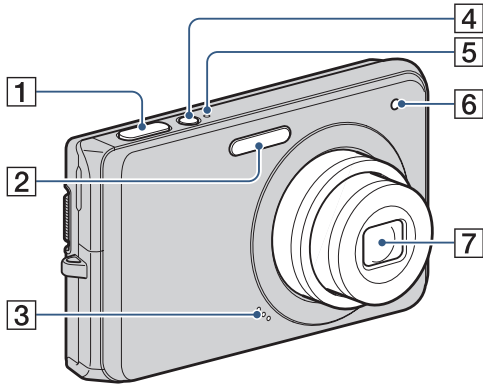



- 1 Shutter button
- 2 Flash
- 3 Microphone
- 4 ON/OFF (Power) button
- 5 ON/OFF (Power) lamp
- 6 Self-timer lamp
- 7 Lens
- 8 LCD screen
- 9 MENU button (9)
- 10 For shooting: W/T (zoom) button (23)
For viewing: Q (Playback zoom) button (28)/☒ (Index) button (29)
- 11 Mode switch (13)
- 12 DC IN jack
- 13 (USB)-A/V OUT terminal (side)
- 14 Jack cover
- 15 Hook for wrist strap
- 16 For shooting: 😊 (Smile) button (22)
For viewing: ☒ (Delete) button (30)
- 17 Control button
Menu on: ▲/▼/◀/▶/●
Menu off: DISP/😊/☒/🔋
- 18 Speaker
- 19 Tripod receptacle
- 20 Battery/"Memory Stick Duo" media cover
- 21 Battery insertion slot
- 22 Battery eject lever
- 23 "Memory Stick Duo" media slot
- 24 Access lamp

Using the mode switch

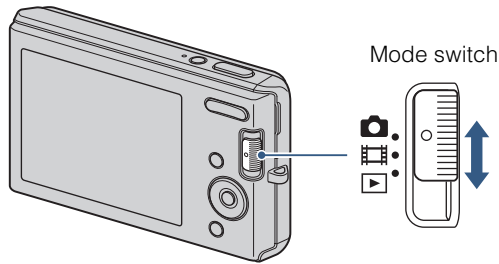
Set the mode switch to the desired function.



 (Still Image)	Allows you to shoot still images (page 17).
 (Movie)	Allows you to record movies with audio (page 20).
 (Playback)	Allows you to view the still images and movies (page 27, 31)

Changing the DISP (screen display) setting

1 Press DISP (screen display) on the control button.

Each time you press DISP (screen display), the setting will change.



* The brightness of the LCD Backlight increases.

Note

- If you view images in bright outside light, adjust the screen brightness to increase. However, the battery power may decrease faster under such condition.

Histogram

A histogram is a graph showing the brightness of an image. The graph display indicates a bright image when skewed to the right side, and a dark image when skewed to the left side.

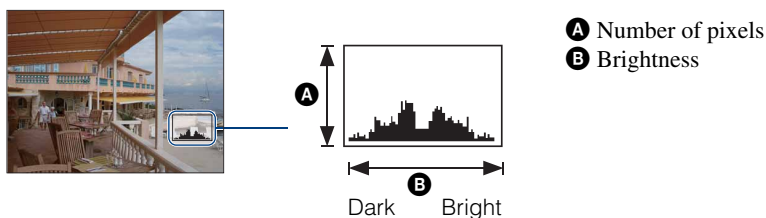

1 Press DISP (screen display) repeatedly until the histogram is displayed.

Notes

- The histogram also appears when playing back a single image, but you cannot adjust the exposure.
- The histogram does not appear while recording movies, playing back movies or viewing rotated still images.
- A large difference in the histogram displayed during shooting and playback may occur when:
 - The flash strobes.
 - The shutter speed is slow or fast.
- The histogram may not appear for images recorded using other cameras.

Using the internal memory

The camera has approximately 12 MB of internal memory. This memory is not removable. Even when there is no “Memory Stick Duo” media inserted in the camera, you can record images using this internal memory.

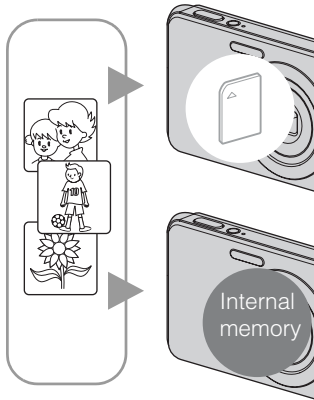

When a “Memory Stick Duo” media is inserted

[Recording]: Images are recorded on the “Memory Stick Duo” media.

[Playback]: Images on the “Memory Stick Duo” media are played back.

[Menu, Settings, etc.]: Various functions can be performed on images on the “Memory Stick Duo” media.

When there is no “Memory Stick Duo” media inserted

[Recording]: Images are recorded using the internal memory.

[Playback]: Images stored in the internal memory are played back.

[Menu, Settings, etc.]: Various functions can be performed on images in the internal memory.

On image data stored in the internal memory

We recommend that you copy (back up) data without error using one of the following methods.

To copy (back up) data on a hard disk of your computer

Perform the procedure on pages 75 to 76 without a “Memory Stick Duo” media inserted in the camera.

To copy (back up) data on a “Memory Stick Duo” media



Prepare a “Memory Stick Duo” media with sufficient free capacity, then perform the procedure explained in [Copy] (page 66).

Notes

- You cannot transfer image data on a “Memory Stick Duo” media to the internal memory.
- By making a USB connection between the camera and a computer with the dedicated USB cable, you can transfer data stored in the internal memory to a computer. However you cannot transfer data on a computer to the internal memory.

Auto Adjustment

Allows you to shoot still images with the setting adjusted automatically.

- 1 Set the mode switch to  (Still Image).
- 2 MENU →  (Camera) →  (Auto Adjustment) → ● on the control button.
- 3 Shoot with the shutter button.



If you shoot a still image of a subject that is difficult to focus on



- The shortest shooting distance is approximately 5 cm (2 inches) (W), 40 cm (1 feet 3 3/4 inches) (T) (from the lens).
- When the camera cannot focus on the subject automatically, the AE/AF lock indicator changes to flash slowly and the beep does not sound. Either recompose the shot or change the focus setting (page 40).















Focusing may be difficult in the following situations:

- It is dark and the subject is distant.
- The contrast between the subject and the background is poor.
- The subject is seen through glass.
- The subject is moving quickly.
- There is reflective light or shiny surfaces.
- The subject is backlit or there is a flashing light.



Scene Selection

Allows you to shoot with preset settings according to the scene.

- 1 Set the mode switch to  (Still Image).
- 2 MENU →  (Camera) → desired Scene Selection → ● on the control button.

 (High Sensitivity)	<p>Allows you to shoot images without a flash under low light conditions, reducing blur.</p>	
 (Soft Snap)	<p>Allows you to shoot images with a softer atmosphere for portraits and flowers, etc.</p>	
 (Landscape)	<p>Allows easy shooting of distant scenes by focusing in the distance. Shoots vivid blue sky and flora colors.</p>	
 (Twilight Portrait)	<p>Allows you to shoot sharp images of people with the night view in the background without compromising the atmosphere.</p>	
 (Twilight)	<p>Allows you to shoot night scenes at far distance without losing the dark atmosphere of the surroundings.</p>	
 (Beach)	<p>Allows you to record the blue of the water clearly when shooting seaside or lakeside scenes.</p>	
 (Snow)	<p>Allows you to record clear images preventing sunken colors in snowy scenes or other places where the whole screen appears white.</p>	

Note

- When you shoot images using  (Twilight Portrait) or  (Twilight) mode, the shutter speed is slower and the images tend to blur. To prevent blurring, the use of a tripod is recommended.

Functions you can use in Scene Selection

For shooting an image appropriately according to the scene condition, a combination of functions is determined by the camera. ✓ indicates a function is available, and — that it is unavailable. The icons below [Flash] indicate the available flash modes.

Some functions are not available, depending on the Scene Selection mode.

	Macro	Flash	Steady-Shot	Burst	White Balance	Smile Shutter	Face Detection	Red Eye Reduction
	✓		✓	—	✓*	✓	✓	—
	✓	✓	✓	✓	—	✓	—	✓
	—	 	✓	✓	—	—	—	✓
	✓	 SL	✓	—	—	✓	✓	✓
	—		✓	—	—	—	—	—
	✓	 	✓	✓	—	✓	✓	✓
	✓	 	✓	✓	—	✓	✓	✓

* [Flash] for [White Balance] cannot be selected.

Movie

Allows you to record movies with audio.

- 1 Set the mode switch to  (Movie).
- 2 Press the shutter button fully down.
- 3 To stop recording, press the shutter button fully down again.

Table of
contents



Operation
Search

MENU/Settings
Search

Index

Program Auto

Allows you to shoot with the exposure adjusted automatically (both the shutter speed and the aperture value). Also you can select various settings using the menu.

- 1 Set the mode switch to  (Still Image).
- 2 MENU →  (Camera) →  (Program Auto) → ● on the control button.
- 3 Shoot with the shutter button.

Smile Shutter

When the camera detects a smile, the shutter is released automatically.

1 Press 😊 (Smile) button.

2 Wait detecting a smile.

When the smile level exceeds the ◀ point on the indicator, the camera records images automatically.

If you press the shutter button during Smile Shutter, the camera shoots the image, then returns to Smile Shutter mode.

3 To stop shooting, press 😊 (Smile) button again.

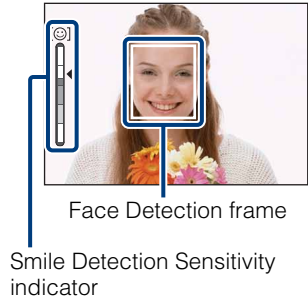

Notes

- Shooting using the Smile Shutter ends automatically when either the “Memory Stick Duo” media or internal memory becomes full.
- Smiles may not be detected correctly depending on the conditions.
- You cannot use the digital zoom function.
- When 🏞️ (Landscape) or 🌙 (Twilight) mode is selected in Scene Selection, you cannot use the Smile Shutter function.

💡 Hints for better capturing of smiles

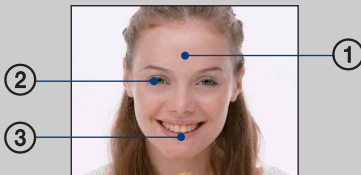

- ① Do not cover the eyes with the bangs.
Do not obscure the face by hat, masks, sunglasses, etc.
- ② Try to orient the face in front of the camera and be as level as possible. Keep the eyes narrowed.
- ③ Give a clear smile with an open mouth. The smile is easier to detect when the teeth are showing.

- The shutter operates when any person whose face is being detected smiles.
- If a smile is not detected, set the [Smile Detection Sensitivity] in setting menu.

Zoom

You can enlarge the image when shooting. The camera's optical zoom function can enlarge images up to 3×.

1 Press the W/T (zoom) button.

Press the T button to zoom in, and the W button to zoom out.

- When the zoom scale exceeds 3×, see page 61.

Note

- You cannot change the zoom scale while shooting a movie.

T button







W button



Self-Timer

1 Press  (Self-Timer) on the control button.

Each time you press , the setting will change.

✓	 OFF	Does not use the self-timer
	 10	Sets the 10-second delay self-timer When you press the shutter button, the self-timer lamp flashes and a beep sounds until the shutter operates. To cancel, press  again.
	 2	Sets the 2-second delay self-timer

Reducing blurring with the two-second self-timer



- Use the 2-second delay self-timer to prevent blur of an image. The shutter is released 2 seconds after you press the shutter button, which reduces camera shake when the shutter button is pressed.

Macro

Use this setting to capture beautiful close-up images of small subjects such as insects or flowers.

1 Press (Macro) on the control button.

Each time you press , the setting will change.

	 AUTO	Adjusts the focus automatically from distant subjects to close-up. <ul style="list-style-type: none">• Normally, put the camera in this mode.
		Adjusts the focus with priority on close-up subjects. Set Macro On when shooting close subjects. <ul style="list-style-type: none">• Setting the zoom all the way to the W side is recommended.





Note

- The Auto Focus speed becomes slower when you shoot images in the Macro mode.

Flash

1 Press (Flash) on the control button.

Each time you press  (Flash), the setting will change.

✓	 AUTO	Flashes when there is insufficient light or backlight.
		Flash always operates. (Flash On)
	 SL	Flash always operates. The shutter speed is slow in a dark place to clearly shoot the background that is out of flash light. (Slow Synchro)
		Flash does not operate.

Notes



- The flash strobos twice. The first flash adjusts the light quantity.
- While charging the flash,  is displayed.
- You cannot use the flash during burst shooting.

When the “White circular spots” appears in flash photos

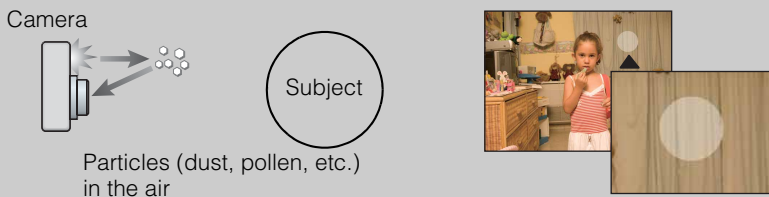
This is caused by particles (dust, pollen, etc.) floating close to the lens. When they are accentuated by the camera’s flash, they appear as white circular spots.



How can the “White circular spots” be reduced?

- Light the room and shoot the subject without a flash.
- Select  (High Sensitivity) mode in Scene Selection. ([Flash Off] is automatically selected.)
- Even though you selected  (High Sensitivity) mode in Scene Selection, the shutter speed might be slower under low-light conditions, or in a dark place. In that case, use a tripod or hold your arms firmly at your side after pressing the shutter button.

Viewing still images

- 1 Set the mode switch to  (Playback).
- 2 Select an image with the control button.

Table of contents

Operation Search

MENU/Settings Search

Index

Playback zoom

Plays back the enlarged image.

- 1 Press **Q** (Playback zoom) button during still image playback.

The image is enlarged to twice the previous size, at the center of the image.

- 2 Adjust the position with the control button.
- 3 Change the zoom scale with **W/T** (zoom) button.

Press **Q** button (**T**) to zoom in, **W** side to zoom out.
Press **●** to cancel playback zoom.





Shows the displayed area of the whole image

To save enlarged images

You can save an enlarged image by using the trimming function.
Press **MENU** → [Retouch] → [Trimming].

Image Index



Displays multiple images at the same time.

- 1 Set the mode switch to  (Playback).
- 2 Press the  (Index) button to display the image index screen.
Press the button again to display an index screen with even more images.
- 3 To return to the single-image screen, select an image with the control button, then press .



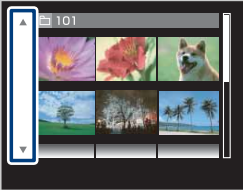

Displaying images of the desired folder







Select the left side bar with the control button, then select the desired folder with /.

Delete

Allows you to select unwanted images for deletion.

- 1 Set the mode switch to  (Playback).
- 2  (Delete) button → desired mode → ● on the control button

 (This Image)	Deletes the currently displayed image in single-image mode.
 (Multiple Images)	Allows you to select and delete multiple images. Do as the following after step 2. ① Select an image then press ●. Repeat the above steps until there are no more images to be deleted. Select an image with a ✓ mark again to release the ✓ mark. ② MENU → [OK] → ●
 (All in This Folder)	Deletes all images in the selected folder at once. Press [OK] → ● after step 2.

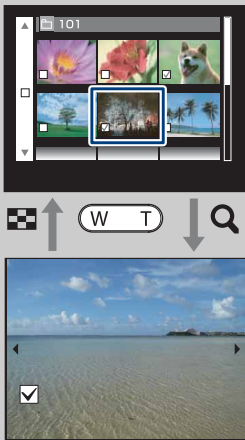

 You can switch between index and single-image mode when selecting images







Press the **Q** button (T) of the W/T (zoom) button in index mode to return to single-image mode, and press the  (Index) button (W) in single-image mode to return to index mode.

- You can also switch between index and single-image mode in [Protect] or [DPOF].

Viewing movies

- 1 Set the mode switch to  (Playback).
- 2 Select a movie with the control button.
- 3 Press .

Movie playback starts.

Control button	Playback feature
	Pause
	Fast forward
	Fast rewind
	Displays the volume control screen. Adjust the volume with  .

Note











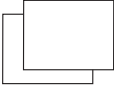



- You may not be able to play back some images shot using other cameras.

Image Size

The image size determines the size of the image file that is recorded when you take a image. The larger the image size, the more detail will be reproduced when the image is printed on large-format paper. The smaller the image size, the more images can be recorded. Select the image size that matches the way you will view your images.

1 MENU →  (Image Size) → desired size

When shooting still images

	Image size	Usage guidelines	No. of images	Printing
✓	 (4000×3000) (DSC-W190 only)	For prints up to A3+ size	Less 	Fine 
✓	 (3648×2736) (DSC-W180 only)			
	 (3264×2448) (DSC-W190 only)	For prints up to A3 size	↑ ↓  More	↑ ↓  Rough
	 (2592×1944)	For prints up to A4 size		
	 (2048×1536)	For prints up to L/2L size		
	 (640×480)	For e-mail attachments		
	 (4000×2672) (DSC-W190 only)	3:2 aspect ratio as in photo prints and postcards	Less	Fine
	 (3648×2432) (DSC-W180 only)			
	 (4000×2248) (DSC-W190 only)	For viewing on a high-definition TV	Less ↑ ↓ More	Fine ↑ ↓ Rough
	 (3648×2056) (DSC-W180 only)			
	 (1920×1080)			

Note

- When you print images recorded with 16:9 aspect ratio, both edges may be cut off.

When shooting movies

The image size is fixed to 320×240 .

The movies shot with this camera will be recorded in AVI (Motion JPEG), Approx. 30fps format.

💡 On “image quality” and “image size”

A digital image is made up of a collection of small dots called pixels.

If it contains a large number of pixels, the image becomes large, it takes up more memory, and the image is displayed in fine detail. “Image size” is shown by the number of pixels.

Although you cannot see the differences on the screen of the camera, the fine detail and data processing time differ when the image is printed or displayed on a computer screen.

Description of the pixels and the image size

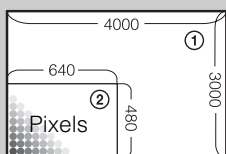

① Image size: 12M

$4000 \text{ pixels} \times 3000 \text{ pixels} = 12,000,000 \text{ pixels}$

② Image size: VGA

$640 \text{ pixels} \times 480 \text{ pixels} = 307,200 \text{ pixels}$

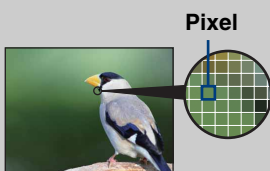

Pixel



Many pixels

(Fine image quality and large file size)





Few pixels

(Rough image quality but small file size)

SteadyShot

Selects the anti-blur mode.



1 MENU →  (SteadyShot) → desired mode

  (Off)	Does not use anti-blur mode.
 (Auto)	Activates the anti-blur function automatically when shooting conditions are likely to cause camera shake. You can stabilize images even when zooming up on a far subject.

Notes

- In Movie mode, [SteadyShot] is fixed to [Off].
- [SteadyShot] is fixed to [Off] while the Smile Shutter function is activated.
- Time is required for image processing.
- When shooting with a flash, the anti-blur function does not work.

Hints for preventing blur

The camera moved accidentally when you took the image. This is called “Camera shake.” On the other hand, if the subject moved when you took the image, it is called “subject blur.” Besides, camera shake and subject blur occur frequently under low-light or slow shutter speed conditions, such as those encountered in  (Twilight Portrait) or  (Twilight) mode. In such case, shoot with the below tips in mind.

Camera shake

Your hands or body shake while you hold the camera and press the shutter button, and the entire screen is blurred.

- Use a tripod or place the camera on a flat surface to hold the camera steady.
- Shoot with a 2-second delay self-timer and stabilize the camera by holding your arms firmly at your side after pressing the shutter button.

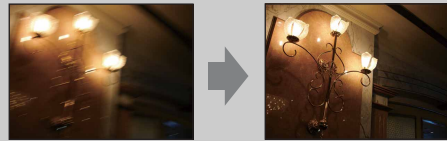

Subject blur

Even though the camera is steady, the subject moves during the exposure so the subject is shot blurred when the shutter button is pressed. Camera shake is reduced automatically using the anti-blur function. However, the function does not effectively reduce subject blur.

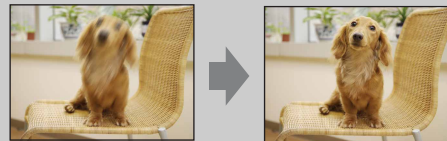

- Select  (High Sensitivity) mode in Scene Selection.
- Select a higher ISO sensitivity to make the shutter speed faster, and press the shutter button before the subject moves.



REC Mode

You can select Normal (single-image) or Burst as the shooting mode.

1 MENU →  (REC Mode) → desired mode

✓	 (Normal)	Records a single image.
	 (Burst)	<p>Records up to 100 images in succession when you press and hold down the shutter button.</p>  <p>Notes</p> <ul style="list-style-type: none">• Burst shooting is not available in Movie Mode.• The flash is set to [Flash Off].• When recording with the self timer, a series of a maximum of five images is recorded.• The recording interval becomes longer, depending on the setting for the image size.• When the battery level is low, or when the internal memory or “Memory Stick Duo” media is full, the Burst stops.• The focus, white balance, and exposure are adjusted for the first image, and these settings are also used for the other images.

EV

You can adjust the exposure manually in 1/3 EV steps in a range of -2.0 EV to +2.0 EV.

1 MENU → 0EV (EV) → desired EV setting

Note

- If you shoot a subject in extremely bright or dark conditions, or when you use the flash, the exposure adjustment may not be effective.

💡 Adjusting the exposure for better looking images

You can create various images by adjusting the exposure and the ISO sensitivity. Exposure is the amount of light that the camera will receive when you release the shutter.

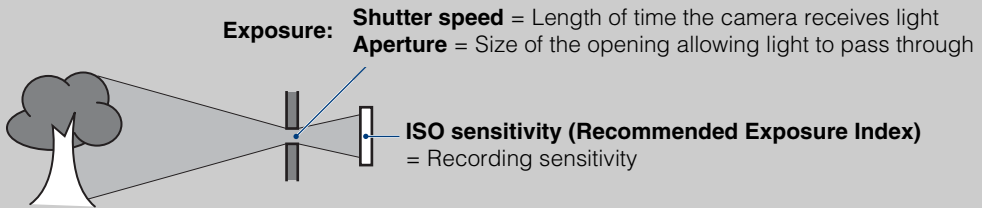

Overexposure = too much light
Whitish image



Lower EV setting -



Correct exposure



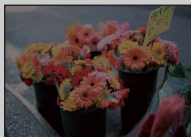

Higher EV setting +



Underexposure = too little light
Darker image

ISO

Adjusts the luminous sensitivity.

1 MENU →  (Camera) →  (Program Auto) →  (ISO) → desired mode

✓	ISO AUTO (Auto)	Sets the ISO sensitivity automatically.
	ISO / ISO / ISO / ISO / 100 / 200 / 400 / 800 / ISO / ISO 1600 / 3200	You can reduce image blurring in dark locations or moving subjects by increasing ISO sensitivity (select a larger number).

Note

- ISO settings other than [ISO AUTO], [ISO 100] to [ISO 400] cannot be selected when the recording mode is set to Burst.



Adjusting ISO Sensitivity (Recommended Exposure Index)

ISO sensitivity is a speed rating for recording media that incorporates an image sensor that receives light. Even when the exposure is the same, images differ depending on the ISO sensitivity.



High ISO sensitivity

Records a bright image even in dark locations while increasing shutter speed to reduce blur. However, the image tends to become noisy.







Low ISO sensitivity

Records a smoother image. However, when the exposure is insufficient, the image may become darker.

White Balance

Adjusts color tones according to the surrounding light conditions. Use this function if image color appears unnatural.

1 MENU → $\frac{WB}{AUTO}$ (White Balance) → desired mode





✓	$\frac{WB}{AUTO}$ (Auto)	Adjusts the white balance automatically so that the colors appear natural.	
	☀ (Daylight)	Adjusts for outdoors conditions on a fine day, evening views, night scenes, neon signs, fireworks, etc.	
	☁ (Cloudy)	Adjusts for a cloudy sky or a shady location.	
	𐀀 (Fluorescent Light 1) 𐀁 (Fluorescent Light 2) 𐀂 (Fluorescent Light 3)	[Fluorescent Light 1]: Adjusts for white fluorescent lighting. [Fluorescent Light 2]: Adjusts for natural white fluorescent lighting. [Fluorescent Light 3]: Adjusts for day white fluorescent lighting.	
	💡 (Incandescent)	Adjusts for places under incandescent lamp, or under bright lighting, such as in a photo studio.	
	⚡ (Flash)	Adjusts for the flash conditions.	

Notes

- [White Balance] cannot be adjusted in Auto adjustment mode.
- In Scene Selection mode, you can change the white balance setting only in iso (High Sensitivity) mode.
- When shooting movies or when Scene Selection is set to iso (High Sensitivity) mode, [Flash] in [White Balance] cannot be selected.
- Under fluorescent lights that flicker, the white balance function may not work correctly even though you select [Fluorescent Light 1], [Fluorescent Light 2] or [Fluorescent Light 3].
- When shooting with a flash in other than [Flash] mode, [White Balance] is set to [Auto].
- When the flash is set to Flash On, you can only set [White Balance] to [Auto] or [Flash].

💡 Effects of lighting conditions



The apparent color of the subject is affected by the lighting conditions. The color tones are adjusted automatically in the Auto adjustment mode, but you can adjust color tones manually using the White Balance function.





Weather/lighting	Daylight	Cloudy	Fluorescent	Incandescent
Characteristics of light	White (standard) 	Bluish 	Green-tinged 	Reddish 

Focus

You can change the focus method. Use the menu when it is difficult to get the proper focus in auto focus mode.

AF stands for “Auto Focus,” a function that adjusts the focus automatically.

1 MENU →  (Camera) →  (Program Auto) →  (Focus) → desired mode

✓	 (Multi AF)	<p>Focuses on a subject in all ranges of the finder frame automatically.</p> <p>When you press the shutter button halfway in still image shooting mode, a green frame is displayed around the area that is in focus.</p> <ul style="list-style-type: none"> When the Face Detection function is active, AF operates with priority on faces. 	 <p>AF range finder frame (Only for still image)</p>
	 (Center AF)	<p>Focuses on a subject in the center of the finder frame automatically. Using the AF lock function together, you can compose the image the way you want.</p>	 <p>AF range finder frame</p>
	0.5 m/1.0 m/ 3.0 m/7.0 m/ ∞ (unlimited distance)	<p>Automatically focuses quickly on the area around a previously set distance (Semi-manual). This mode is useful when repeatedly shooting a subject at the same distance. Use “Semi-manual” when it is difficult to get sharp focus with automatic focusing, such as when shooting a subject through a net or window.</p> <ul style="list-style-type: none"> Focuses on a subject in all ranges of the finder frame in Semi-manual mode. 	

Notes

- When you use [Digital Zoom], the AF range finder frame is disabled and appears in a dotted line. In this case, the camera works to focus on the subjects at the center of the screen.
- When the [Face Detection] is set to [Auto], the focus mode is fixed to [Multi AF].
- In the Movie shooting mode, the focus mode is fixed to [Multi AF].
- The focus mode is fixed to [Multi AF] while the Smile Shutter function is activated.
- The Semi-manual distance setting contains some errors, and this error increases when the zoom is set to the T side or the lens is tilted upward or downward.

Focusing on subjects near the edge of the screen

If the subject is out of focus, do as follows:



AF range finder
frame

AE/AF lock
indicator





- ① Recompose the shot so that the subject is centered in the AF range finder, and press the shutter button halfway to focus on the subject (AF lock).
 - ② When the AE/AF lock indicator stops flashing and remains on, return to the fully composed shot, and press the shutter button fully down.
- As long as you do not press the shutter button fully down, you can retry the procedure as many times as necessary.

Metering Mode





Selects the metering mode that sets which part of the subject to measure to determine the exposure.

In shooting still images:

1 MENU →  (Camera) →  (Program Auto) →  (Metering Mode) → desired mode

In shooting movies:

1 MENU →  (Metering Mode) → desired mode

✓	 (Multi)	Divides into multiple regions and measures each region. The camera determines a well-balanced exposure (Multi-pattern metering).
	 (Center)	Measures the center of the image, and determines the exposure based on the brightness of the subject there (Center-weighted metering).
	 (Spot)	Measures only a part of the subject (Spot metering). This function is useful when the subject is backlit or when there is strong contrast between the subject and the background.  Spot metering cross hairs Positions on the subject

Notes

- In Movie Mode, [Spot] cannot be selected.
- The Metering Mode is available only when the [Face Detection] is set to [Off].
- The Metering Mode is fixed to [Multi] while the Smile Shutter function is activated.





Smile Detection Sensitivity

Sets the sensitivity of the Smile Shutter function for detecting smiles.

1 MENU → 😊 (Smile Detection Sensitivity) → desired mode

	😊 (Low)	Detects a big smile.
✓	😊 (Medium)	Detects a normal smile.
	😊 (High)	Detects even a slight smile.

Notes

- Smiles may not be detected correctly depending on the conditions.
- [Smile Detection Sensitivity] cannot be adjusted in Movie Mode.
- You can change the Smile Detection Sensitivity setting when  (High Sensitivity), , ,  (Beach) or  (Snow) mode is selected in Scene Selection mode.

Face Detection

Selects whether to use the Face Detection function or not.

Detects the faces of your subjects and adjusts the focus, flash, exposure, white balance and red-eye reduction settings automatically.





Face Detection frame (Orange)

When the camera detects more than one subject, the camera will judge which is the main subject and set focus by priority. The Face Detection frame for the main subject will turn orange. The frame for which the focus is set will turn green by pressing the shutter button halfway down.

Face Detection frame (White)

1 MENU →  (Face Detection) → desired mode

<input checked="" type="checkbox"/>	 (Auto)	Selects the face the camera is to automatically focus on.
<input type="checkbox"/>	 (Off)	Does not use Face Detection function.

Notes

- [Face Detection] cannot be selected in Movie Mode.
- Up to 8 faces of your subjects can be detected. However, only up to 4 faces of your subjects can be detected when  (Soft Snap) mode is selected in the Scene Selection mode.
- During Smile Shutter shooting, [Face Detection] is automatically set to [Auto] even if it is set to [Off].



Making faces easier to detect





- Use an appropriate lighting level.
- Make sure the subjects' faces are not hidden by hats, masks, sunglasses, etc.
- Make sure the subjects are facing the camera.

Flash Level

Adjusts the amount of flash light.

1 MENU →  (Camera) →  (Program Auto) →  (Flash Level) → desired mode

	 (-)	Makes the flash level lower.
✓	 (Standard)	
	 (+)	Makes the flash level higher.

Note



- Sometimes effects do not show up when the subject being shot is too bright or too dark.

Red Eye Reduction

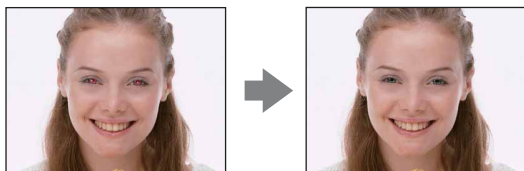
The flash strobescs two or more times before shooting to reduce the red-eye phenomenon when using the flash.



1 MENU →  (Red Eye Reduction) → desired mode

✓  (Auto)	When the Face Detection function is activated, the flash strobescs automatically to reduce the red-eye phenomenon.
 (On)	The flash always strobescs to reduce the red-eye phenomenon.
 (Off)	Does not use Red Eye Reduction.

Notes

- [Red Eye Reduction] cannot be selected during Movie Mode or Smile Shutter.
- To avoid blurring of images, hold the camera firmly until the shutter is released. It usually takes a second after you press the shutter button. Be also sure not to allow the subject to move during this period.
- Red Eye Reduction may not produce the desired effects. It depends on individual differences and conditions, such as distance to the subject, or if the subject looked away from the pre-strobe.
- If you do not use the Face Detection function, Red Eye Reduction does not work, even when you select [Auto].

What causes the red-eye phenomenon?

Pupils become dilated in dark environments. Flash light is reflected off the blood vessels at the back of the eye (retina), causing the “red-eye” phenomenon.

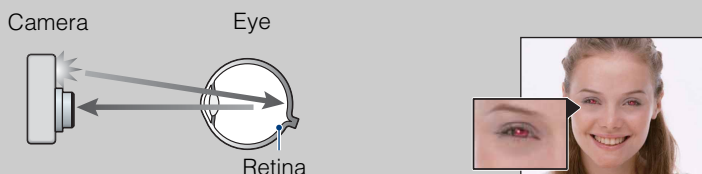



Other ways to reduce red-eye

- Select  (High Sensitivity) mode in Scene Selection. (The flash is set to [Flash Off] automatically.)
- When the eyes of the subject turn out red, correct the image with [Retouch] → [Red Eye Correction] on the viewing menu or with the supplied software “PMB”.

Color Mode







You can change the brightness of the image, accompanied by effects.

In shooting still images:

1 MENU →  (Camera) →  (Program Auto) →  (Color Mode) → desired mode



In shooting movies:

1 MENU →  (Color Mode) → desired mode

<input checked="" type="checkbox"/>	 (Normal)	Sets the image to standard color.	
<input type="checkbox"/>	 (Sepia)	Sets the image to sepia color.	
<input type="checkbox"/>	 (B & W)	Sets the image to black and white.	

Slideshow

Images are automatically played back in succession.

- 1 Set the mode switch to  (Playback) to switch to playback mode.
- 2 MENU →  (Slideshow) → ● on the control button
- 3 Select a desired setting.
- 4 [Start] → ●
- 5 Press ● to end the slideshow.

Notes

- You cannot play back movies.
- Settings other than [Image] are stored until the next time they are changed.

Image

Selects the group of images to be shown.

<input checked="" type="checkbox"/>	All	Plays a slideshow of all the still images in order.
<input type="checkbox"/>	Folder	Plays a slideshow of still images in the currently selected folder.

Effects

Selects the playback speed and mood for slideshows.

<input type="checkbox"/>	Simple	A simple slideshow switching still images at a preset interval. The playback interval is adjustable in [Interval] and you can thoroughly enjoy your images.
<input checked="" type="checkbox"/>	Basic	A basic slideshow suitable for a wide range of scenes.

Interval

Sets the screen switching interval.

<input type="checkbox"/>	1 sec	Sets the display interval of images for a [Simple] slideshow.
<input type="checkbox"/>	3 sec	
<input type="checkbox"/>	5 sec	
<input type="checkbox"/>	10 sec	
<input checked="" type="checkbox"/>	Auto	The interval is set to suit [Basic] slideshow.



Repeat



Turns slideshow repeat on or off.

✓	On	Plays back images in a continuous loop.
	Off	After all the images have been played back, the slideshow ends.

Retouch

Adds effects or makes corrections to a recorded image and records it as a new file.
The original image is retained.

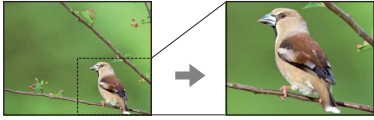
- 1 Set the mode switch to  (Playback) to switch to playback mode.
- 2 MENU →  (Retouch) → desired mode → ● on the control button
- 3 Perform retouching according to the operation method in each mode.

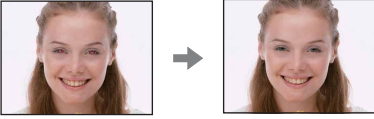
 (Trimming)	<p>Records the zoomed playback image.</p> <ol style="list-style-type: none">① Press the Q button (T) to zoom in and press W to zoom out.② Set the zoom point with the control button.③ MENU → select an image size to save → ●④ [OK] → ● <ul style="list-style-type: none">• The quality of trimmed images may deteriorate.• The image size that you can trim may vary depending on the image. 
 (Red Eye Correction)	<p>Corrects the red-eye phenomenon caused by flash.</p> <ol style="list-style-type: none">① Select [OK] with the control button → ●. <ul style="list-style-type: none">• You may not be able to correct the red-eye phenomenon depending on the image. 



Note







- Movies cannot be retouched.

Multi-Purpose Resize

You can change the aspect ratio and size of the shooting images, then record them as the new files.

You can convert images to the 16:9 aspect ratio for high definition viewing and to the VGA size for blog or e-mail attachments.

- 1 Set the mode switch to  (Playback) to switch to playback mode.
- 2 MENU →  (Multi-Purpose Resize) → desired mode → ● on the control button
- 3 Zoom to the range you want to trim with the W/T (zoom) button.
- 4 Specify the area you want to trim with the control button.
- 5 MENU → [OK] → ●



 (HDTV)	Changes the aspect ratio from 4:3/3:2 to 16:9 and saves as 2M size.		→	
 (Blog/E-mail)	Changes the aspect ratio from 16:9/3:2 to 4:3 and saves as VGA size.		→	



Notes

- You cannot resize movies.
- Images shot in VGA size cannot be resized to [HDTV] size.
- Enlarging the image and multi resizing can reduce the image quality.

Protect

Protects recorded images against accidental erasure.
The  mark is displayed for registered images.

- 1 Set the mode switch to  (Playback) to switch to playback mode.
- 2 MENU →  (Protect) → desired mode → ● on the control button

 (This Image)	Protects the currently displayed image in single-image mode.
 (Multiple Images)	You can select and protect multiple images. Do as the following after step 2. ① Select an image then press ●. Repeat the above steps until there are no more images to be protected. Select an image with a ✓ mark to release the ✓ mark. ② MENU → [OK] → ●



To cancel the protection



Select the image for which you want to cancel protection, and unlock it by pressing ● on the control button as the same procedure to protect it.
The  indicator disappears, and the protection is released.

DPOF

DPOF (Digital Print Order Format) is a function that allows you to specify the images of “Memory Stick Duo” media that you want to print out later.

The **DPOF** (Print order) mark is displayed for registered images.

- 1 Set the mode switch to  (Playback) to switch to playback mode.
- 2 MENU → **DPOF** → desired mode → ● on the control button

DPOF  (This Image)	Orders printing the currently displayed image in single-image mode.
DPOF  (Multiple Images)	You can select and order printing multiple images. Do as the following after step 2. ① Select an image then press ●. Repeat the above steps until there are no more images to be printed. Select an image with a ✓ mark to release the ✓ mark. ② MENU → [OK] → ●

Notes

- The **DPOF** (Print order) mark cannot be added to movies.
- You can add a **DPOF** (Print order) mark to a maximum 999 images.

Clearing the DPOF mark





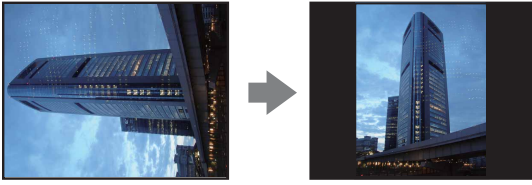

Select the image to clear the DPOF registration, then press ● on the control button in the same procedure as when making a DPOF mark.

The **DPOF** mark disappears and the DPOF registration is cleared.

Rotate

Rotates a still image. Use this to display a horizontal orientation image in vertical orientation.





- 1 Set the mode switch to  (Playback) to switch to playback mode.
- 2 MENU →  (Rotate) → ● on the control button
- 3 Rotate the image with [/] → /.
- 4 [OK] → ●

Notes

- You cannot rotate movies or protected still images.
- You may not be able to rotate images shot with other cameras.
- When viewing images on a computer, the image rotation information may not be reflected depending on the software.

Select Folder

When multiple folders are created in “Memory Stick Duo” media, this selects the folder containing the image you want to play back.

- 1 Set the mode switch to  (Playback) to switch to playback mode.
- 2 MENU →  (Select Folder) → ● on the control button
- 3 Select the folder with ◀/▶.
- 4 [OK] → ●



Note

- This item is not displayed when the internal memory is used to record images.



Viewing images across multiple folders

When multiple folders are created, the following indicators appear on the first and last images in the folder.

- : Moves to the previous folder
- : Moves to the next folder
- : Moves to either the previous or next folders

Beep

Selects or turns off the sound produced when you operate the camera.

- 1 MENU →  (Settings) → [Main Settings] → [Beep] → desired mode → ● on the control button

	Shutter	Turns on the shutter sound when you press the shutter button.
✓	On	Turns on the beep/shutter sound when you press the control/shutter button.
	Off	Turns off the beep/shutter sound.

USB Connect

Selects the USB mode when connecting the camera to a computer or a PictBridge compliant printer using the dedicated USB cable.

1 MENU →  (Settings) → [Main Settings] → [USB Connect] → desired mode → ● on the control button

	PictBridge	Connects the camera to a PictBridge compliant printer. When you connect the camera to a computer, the AutoPlay Wizard appears, and the still images in the recording folder on the camera are imported to the computer. (with Windows Vista/XP, Mac OS X)
✓	Mass Storage	Establishes a Mass Storage connection between the camera and a computer or other USB device.

Video Out

Sets the video signal output according to the TV color system of the connected video equipment. The TV color systems differ depending on the country and region.

To view images on a TV screen, check the TV color system of the country or region of use (page 70).

- 1 MENU →  (Settings) → [Main Settings] → [Video Out] → desired mode → ● on the control button

NTSC	Sets the video output signal to NTSC mode (e.g., for the USA, Japan).
PAL	Sets the video output signal to PAL mode (e.g., for Europe, China).

Initialize

Initializes the setting to the default setting.

Even if you execute this function, the images are retained.

1 MENU →  (Settings) → [Main Settings] → [Initialize] → [OK] → ● on the control button

Note

- Be sure not to turn off the camera while initializing.

Grid Line

With reference to the grid lines, you can easily set a subject in a horizontal/vertical position.

1 MENU →  (Settings) → [Shooting Settings] → [Grid Line] → desired mode → ● on the control button

	On	Displays the grid lines. The grid lines are not recorded.
✓	Off	Does not display the grid lines.

Digital Zoom

Selects the digital zoom mode. The camera enlarges the image using optical zoom (up to 3×). When the zoom scale is exceeded, the camera uses either smart or precision digital zoom.

1 MENU →  (Settings) → [Shooting Settings] → [Digital Zoom] → desired mode → ● on the control button

✓	Smart (SQ)	Enlarges the image digitally within the range where the image will not be distorted, according to the image size (Smart zoom).
	Precision (PQ)	Enlarges all image sizes by the total zoom scale of approximately 6×, including the optical zoom 3×. However, note that the picture quality deteriorates when the optical zoom scale is exceeded (Precision digital zoom).
	Off	Does not use the digital zoom.

Notes

- The digital zoom function does not operate when recording movies or while the Smile Shutter function is activated.
- The smart zoom is not available when the image size is set to [12M] (DSC-W190), [10M] (DSC-W180), [16:9(9M)] (DSC-W190), [16:9(7M)] (DSC-W180) or [3:2].
- The Face Detection function does not work when using the digital zoom.

Total zoom scale when using Smart zoom (including optical zoom 3×)

The supported zoom ratio differs depending on the image size.

DSC-W190

Size	Total zoom scale
8M	Approx. 3.7×
5M	Approx. 4.6×
3M	Approx. 5.9×
VGA	Approx. 18×
16:9(2M)	Approx. 6.2×

DSC-W180

Size	Total zoom scale
5M	Approx. 4.2×
3M	Approx. 5.3×
VGA	Approx. 17×
16:9(2M)	Approx. 5.7×

Auto Review

Displays the recorded image on the screen for approximately two seconds immediately after shooting a still image.

1 MENU →  (Settings) → [Shooting Settings] → [Auto Review] → desired mode → ● on the control button

✓	On	Uses the Auto Review.
	Off	Does not use Auto Review.



Shooting another image without delay

- When you press the shutter button halfway down, the display of the recorded image disappears and you can shoot another image immediately, even if Auto Review is set to [On].

Format

Formats the “Memory Stick Duo” media or the internal memory. A commercially available “Memory Stick Duo” media is already formatted, and can be used immediately.

1 MENU →  (Settings) → [“Memory Stick” Tool] or [Internal Memory Tool] → [Format] → [OK] → ● on the control button

Note

- Note that formatting permanently erases all data including even protected images.

Create REC.Folder

Creates a folder in “Memory Stick Duo” media for recording images.

Images are recorded in the newly created folder until you create another folder or select another recording folder.

1 MENU →  (Settings) → [“Memory Stick” Tool] → [Create REC.Folder] → [OK] → ● on the control button

Notes

- This item is not displayed when the internal memory is used to record images.
- When you insert a “Memory Stick Duo” media that was used with other equipment into the camera and shoot images, a new folder may be automatically created.
- Up to 9,999 images can be stored in one folder. When the folder capacity is exceeded, a new folder is automatically created.



On the folders

- After a new folder is created, you can change the storage destination folder (page 65) and select the folder for viewing images (page 55).

Change REC.Folder

Changes the folder in “Memory Stick Duo” media that is currently used for recording images.

- 1 MENU →  (Settings) → [“Memory Stick” Tool] → [Change REC.Folder]
- 2 Select a folder with ◀/▶ on the control button.
- 3 [OK] → ●

Notes

- This item is not displayed when the internal memory is used to record images.
- The “100” folder cannot be selected as a recording folder.
- You cannot move recorded images to another folder.

Copy

Copies all images in the internal memory to a “Memory Stick Duo” media.

- 1 Insert a “Memory Stick Duo” media with sufficient free capacity into the camera.
- 2 MENU →  (Settings) → [“Memory Stick” Tool] → [Copy] → [OK] → ● on the control button

Notes

- Use a fully charged battery pack. If you attempt to copy image files using a battery pack with little remaining charge, the battery pack may run out, causing copying to fail or possibly corrupting the data.
- Images cannot be copied individually.
- The original images in the internal memory are retained even after copying. To delete the contents of the internal memory, remove the “Memory Stick Duo” media after copying, then format the internal memory ([Format] in [Internal Memory Tool]).
- A new folder is created on the “Memory Stick Duo” media and all the data will be copied to it. You cannot choose a specific folder and copy images to it.

Clock Settings

Sets the date and time again.

- 1 MENU →  (Settings) → [Clock Settings] → [Clock Settings] → desired setting → [OK] → ● on the control button
Midnight is indicated as 12:00AM, and noon as 12:00PM.

Note

- The camera does not have a feature for superimposing dates on images. By using “PMB” in the CD-ROM (supplied), you can print or save images with the date.

Language Setting

Selects the language to be used in the menu items, warnings and messages.

- 1 MENU →  (Settings) → [Language Setting] → [Language Setting] → desired mode → ● on the control button

Table of contents

Operation Search

MENU/Settings Search

Index

Viewing images on a TV

You can view images on a TV by connecting the camera to a TV.
The connection varies according to the type of TV the camera is connected to.
Refer also to the operating instructions supplied with the TV.

Viewing images by connecting the camera to a TV with the supplied dedicated A/V cable

- 1 Turn off both the camera and the TV.
- 2 Connect the camera to the TV with the dedicated A/V cable (supplied).

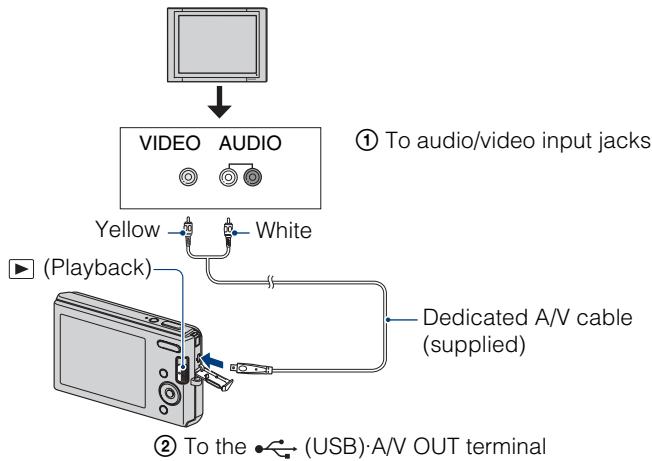

- 3 Turn on the TV and set the input.
- 4 Set the mode switch to ▶ (Playback), then turn on the camera.
Images shot with the camera appear on the TV. Select the desired image with the control button.

Notes

- When using the camera abroad, it may be necessary to switch the video signal output to match that of your TV system (page 58).
- The shooting image will not be displayed on the TV when the movie is shot under the condition of the camera and TV connected.

On TV color systems

If you want to view images on a TV screen, you need a TV with a video input jack and the dedicated A/V cable (supplied). The color system of the TV must match that of the digital still camera. Check the following lists for the TV color system of the country or region where the camera is used.

NTSC system

Bahama Islands, Bolivia, Canada, Central America, Chile, Colombia, Ecuador, Jamaica, Japan, Korea, Mexico, Peru, Surinam, Taiwan, the Philippines, the U.S.A., Venezuela, etc.

PAL system

Australia, Austria, Belgium, China, Czech Republic, Denmark, Finland, Germany, Holland, Hong Kong, Hungary, Italy, Kuwait, Malaysia, New Zealand, Norway, Poland, Portugal, Singapore, Slovak Republic, Spain, Sweden, Switzerland, Thailand, United Kingdom, etc.

PAL-M system

Brazil

PAL-N system

Argentina, Paraguay, Uruguay

SECAM system

Bulgaria, France, Guiana, Iran, Iraq, Monaco, Russia, Ukraine, etc.

Enjoying your Windows computer

For details on using a Macintosh computer, refer to “Using your Macintosh computer” (page 79).



Install the software (supplied) first (page 73)

- Installing the “PMB”

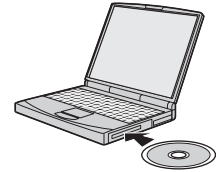

Connecting the camera to your computer (page 75)

- Enjoying images using “PMB” as follows:
 - Importing images to your computer
 - Exporting images to the camera
 - Editing images
 - Displaying the shooting locations of still images on maps online (this requires an Internet connection)
 - Creating a disc with the images shot (this requires CD or DVD disc writing drive)
 - Printing or saving still images with the date
 - Uploading images to a media service (this requires an Internet connection)

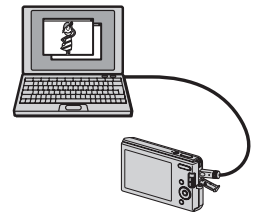

Additional information on this product and answers to frequently asked questions can be found at the Sony Customer Support Website.
<http://www.sony.net/>

Recommended computer environment

	OS (pre-installed)	Others
For using “PMB”	Microsoft Windows XP* ¹ SP3/Windows Vista SP1* ²	CPU: Intel Pentium III 500 MHz or faster (Recommended: Intel Pentium III 800 MHz or faster) Memory: 256 MB or more (Recommended: 512 MB or more) Hard Disk: Disk space required for installation—approximately 500 MB Display: Screen resolution: 1,024 × 768 dots or more Video memory: 32 MB or more (Recommended: 64 MB or more)
For importing images	Microsoft Windows 2000 Professional SP4, Windows XP* ¹ SP3/ Windows Vista SP1* ²	USB jack: Provided as standard

*¹ 64-bit editions and Starter (Edition) are not supported.

*² Starter (Edition) is not supported.

Notes

- The computer environment must also satisfy the operating requirements of the OS.
- Operation is not assured in an environment based on an upgrade of the operating systems described above or in a multi-boot environment.
- Operations are not guaranteed for all the recommended computer environments mentioned above.
- If you connect two or more USB devices to a single computer at the same time, some devices, including the camera, may not operate, depending on the types of USB devices you are using.
- Operations are not guaranteed when using a USB hub.
- Connecting the camera using a USB interface that is compatible with Hi-Speed USB (USB 2.0 compliant) allows advanced transfer (high speed transfer) as the camera is compatible with Hi-Speed USB (USB 2.0 compliant).
- There are two modes for a USB connection when connecting a computer, [Mass Storage] (default setting) and [PictBridge] modes. This section describes the [Mass Storage] as examples. For details on [PictBridge], see page 57.
- When your computer resumes from a suspend or sleep mode, communication between the camera and your computer may not recover at the same time.

Installing the software (supplied)

You can install the supplied software (PMB) using the following procedure.

- 1 Turn on your computer, and insert the CD-ROM (supplied) into the CD-ROM drive.

The installation menu screen appears.

- If it does not appear, double-click [Computer] (in Windows XP, [My Computer]) →  (SONYPICUTIL).
- If the AutoPlay screen appears, select “Run Install.exe.” and follow the instructions that appear on the screen to proceed with the installation.



- 2 Click [Install].

The “Choose Setup Language” screen appears.

- 3 Select the desired language, then click [Next].

The “License Agreement” screen appears.

- 4 Read the license agreement carefully. If you agree, click the radio button (changes to) then [Next].

- 5 Follow the instructions on the screen to complete the installation.

- When the restarting confirmation message appears, restart the computer following the instructions on the screen.
- DirectX may be installed depending on the system environment of your computer.

- 6 Remove the CD-ROM after the installation is complete.

The short cut icons for “ PMB” and “ PMB Guide” are created on the desktop. Double-click these icons to start the software.

Note

- Log on as Administrator.

On “PMB (Picture Motion Browser)”

You can use still images and movies from the camera more than ever by taking advantage of the software. This section summarizes the “PMB”. For details, see the “PMB Guide”.

“PMB” overview

With the “PMB”:

- You can import images shot with the camera to the computer and display them on the computer.
- You can export images in your computer to a “Memory Stick Duo” media, and display them on the camera.
- You can organize images on the computer on a calendar by shooting date to view them.
- You can retouch (Red Eye Correction, etc.), search for faces, print, send still images as e-mail attachments, and change the shooting date.
- You can display information on the positions where you shot the images on a map. (This requires an Internet connection.)
- You can print or save the still images with the date.
- You can create a data disc using a CD burner drive or DVD burner drive.
- You can upload the image to a media service. (This requires an Internet connection.)

Starting the “PMB Guide”

1 Double-click the  (PMB Guide) icon on the desktop.

To access “PMB Guide” from the Start menu, click [Start] → [All Programs] → [Sony Picture Utility] → [Help] → [PMB Guide].

Starting and exiting the “PMB”

1 Double-click the  (PMB) icon on the desktop.

Or, from the Start menu: Click [Start] → [All Programs] → [Sony Picture Utility] → [PMB].

The confirmation message of the Information tool appears on the screen when starting the “PMB” for the first time. Select [Start].

- This function informs you of news, such as software updates. You can change the setting later.

2 Click the  button on the top right corner of the screen to exit the “PMB.”

Enjoying images on your computer

For details on the “PMB” functions, see the “PMB Guide”.

Connecting the camera to the computer

When importing images from the internal memory, step 1 is unnecessary.



- 1 Insert a “Memory Stick Duo” media with recorded images into the camera.
- 2 Insert the sufficiently charged battery pack into the camera, or connect the camera to a wall outlet (wall socket) with the AC Adaptor (sold separately).
- 3 Turn on the camera and the computer.
- 4 Connect the camera to your computer.

“Connecting...” appears on the screen of the camera.

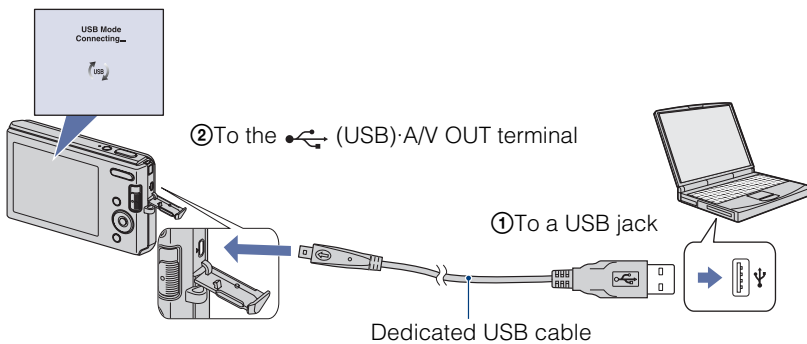
- When a USB connection is established for the first time, your computer automatically runs a program to recognize the camera. Wait for a while.



Notes

- When you import/export images from/to your computer using a battery pack with little remaining charge, transferring may fail or image data may become corrupted if the battery pack shuts down too soon.
-  is displayed on the screen during the communication session. Do not operate the computer while the indicator is displayed. When the indicator changes to , you can start using the computer again.
- If “Mass Storage” does not appear, set [USB Connect] to [Mass Storage] (page 57).

Importing images to a computer

1 Make a USB connection between the camera and a computer.

The [Import Media Files] screen of “PMB” appears automatically.

- If the AutoPlay Wizard appears, close it.

2 Click the [Import] button to import images.

The computer starts importing images.

- By default, images are imported into a folder created in “Pictures” (in Windows XP, “My Pictures”) that is named with the date of importing.

3 View images on your computer.

When importing is complete, the “PMB” starts.

Thumbnails of the imported images are displayed.

- The “Pictures” (in Windows XP, “My Pictures”) folder is set as the default folder in “Viewed folders”.

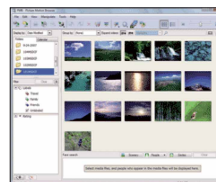

💡 Viewing images using “PMB”

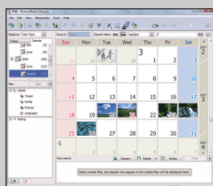

Example: Month display screen

Organize images on the computer on a calendar by shooting date to view them. For details on the “PMB”, see the “PMB Guide”.



Importing images to a computer without using “PMB”

When the AutoPlay Wizard appears in step 1, click [Open folder to view files] → [OK] → [DCIM] → copy the desired images to the computer.

Exporting images to view on the camera

You can export images in your computer to a “Memory Stick Duo” media, and view them on the camera.

For details, see the “PMB Guide”.

- 1 Make a USB connection between the camera and a computer.
 - If the AutoPlay Wizard appears, close it.
- 2 Double-click  (PMB) on the desktop to start up “PMB”.
- 3 Select the images to export in the main screen.
- 4 Click  on the top part of the screen → [Memory Card].
The [Export to Media] screen appears.
- 5 Select the driver of the media, and click [Export].

Notes

- You cannot play back some images depending on the image size.
- No guarantees are made for playing back, on this camera, files containing images which were processed on a computer or images which were shot using other cameras.

Deleting the USB connection

Perform the procedures from step 1 to 3 below before:

- Disconnecting the dedicated USB cable.
- Removing a “Memory Stick Duo” media.
- Inserting a “Memory Stick Duo” media into the camera after copying images from the internal memory.
- Turning off the camera.

- 1 Double-click the disconnect icon on the tasktray.
- 2 Click  (USB Mass Storage Device) → [Stop].
- 3 Confirm the device on the confirmation window, then click [OK].

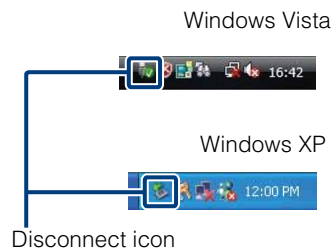
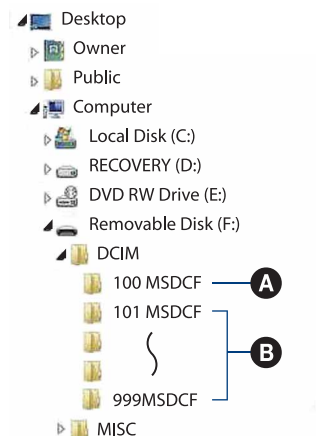

Image file storage destinations and file names

The image files recorded with the camera are grouped as folders on the “Memory Stick Duo” media or the internal memory.

- A** Folder containing image data recorded using a camera not equipped with the folder creating function.
- B** Folder containing image data recorded using the camera.

Example: viewing folders on Windows Vista



Notes

- You cannot record any images to the “100MSDCF” folder. The images in these folders are available only for viewing.
 - You cannot record/play back any images of the “MISC” folder.
 - Image files are named as follows:
 - Still image files: DSC0□□□□.JPG
 - Movie files: MOV0□□□□.AVI
 - Index image files that are recorded when you record movies: MOV0□□□□.THM
- stands for any number within the range from 0001 to 9999. The numerical portions of the name of a movie file recorded in Movie Mode and its corresponding index image file are the same.

Using your Macintosh computer

You can copy images to your Macintosh computer. “PMB” is not compatible with Macintosh computers.

Recommended computer environment

Recommended environment for copying images

OS (pre-installed): Mac OS 9.1/9.2/ Mac OS X (v10.1 to v10.5)

USB jack: Provided as standard

Notes

- Operations are not guaranteed for all the recommended computer environments mentioned above.
- If you connect two or more USB devices to a single computer at the same time, some devices, including the camera, may not operate depending on the types of USB devices you are using.
- Operations are not guaranteed when using a USB hub.
- Connecting the camera using a USB interface that is compatible with Hi-Speed USB (USB 2.0 compliant) allows advanced transfer (high speed transfer) as the camera is compatible with Hi-Speed USB (USB 2.0 compliant).
- There are two modes for a USB connection when connecting a computer, [Mass Storage] (default setting) and [PictBridge] modes. This section describes the [Mass Storage] as examples. For details on [PictBridge], see page 57.
- When your computer resumes from the suspend or sleep mode, communication between the camera and your computer may not recover at the same time.

Additional information on this product and answers to frequently asked questions can be found at the Sony Customer Support Website.

<http://www.sony.net/>

Importing and viewing images on a computer

When importing images from the internal memory, step 1 is unnecessary.

- 1 Insert a “Memory Stick Duo” media with recorded images into the camera.
- 2 Insert the sufficiently charged battery pack into the camera, or connect the camera to a wall outlet (wall socket) with the AC Adaptor (sold separately).
- 3 Turn on the camera and the Macintosh computer.
- 4 Connect the camera to your computer.

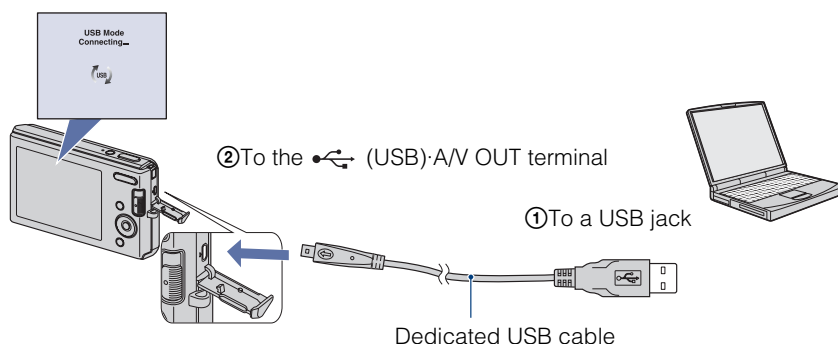

- 5 Double-click the newly recognized icon → [DCIM] → the folder where the images you want to import are stored.
- 6 Drag and drop the image files to the hard disk icon.
The image files are copied to the hard disk.
 - For details on the storage location of the images and file names, see page 78.
- 7 Double-click the hard disk icon → the desired image file in the folder containing the copied files.

Deleting the USB connection

Drag and drop the drive icon or the icon of the “Memory Stick Duo” media to the “Trash” icon beforehand when you perform the procedures listed below, or the camera is disconnected from the computer.

- Disconnecting the dedicated USB cable.
- Removing a “Memory Stick Duo” media.
- Inserting a “Memory Stick Duo” media into the camera.
- Turning off the camera.

Viewing “Cyber-shot Step-up Guide”

“Cyber-shot Step-up Guide” further introduces how to use the camera and optional accessories.

Viewing on Windows

When you install “Cyber-shot Handbook”, “Cyber-shot Step-up Guide” is also installed.

- 1 Double-click  (Step-up Guide) on the desktop.

To access “Step-up Guide” from the Start menu, click [Start] → [All Programs] → [Sony Picture Utility] → [Step-up Guide].

Viewing on Macintosh

- 1 Copy the [stepupguide] folder in the [stepupguide] folder to your computer.
- 2 Select [stepupguide], [language] and then [GB] folder stored in the CD-ROM (supplied), and copy all the files in the [GB] folder to the [img] folder in the [stepupguide] folder that you copied to your computer in step 1. (Overwrite the files in the [img] folder with the files from the [GB] folder.)
- 3 After copying is complete, double-click “stepupguide.hqx” in the [stepupguide] folder to uncompress it, then double-click the generated file “stepupguide”.

Note

- If an uncompress tool for HQX file is not installed, install the Stuffit Expander.

Printing still images

You can print still images by the following methods.

Printing directly using a PictBridge compliant printer (page 83)

You can print images by connecting the camera directly to a PictBridge compliant printer.

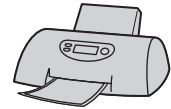

Printing directly using a “Memory Stick” media compliant printer

You can print images with a “Memory Stick” media compliant printer. For details, see the operating instructions supplied with the printer.

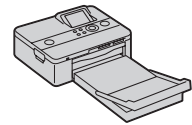

Printing using a computer

You can import images to a computer using the supplied “PMB” software and print the images.

You can insert the date on the image and print it. For details, see the “PMB Guide”.



Printing at a shop (page 85)

You can take a “Memory Stick Duo” media containing images shot with the camera to a photo printing service shop. You can make a **DPOF** (Print order) mark on the images which you want to print out in advance.

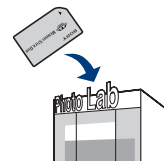

Note

- When you print images shot in [16:9] mode, both edges may be cut off.

Printing images directly using a PictBridge compliant printer

Even if you do not have a computer, you can print images shot using the camera by connecting the camera directly to a PictBridge compliant printer.

PictBridge “PictBridge” is based on the CIPA standard. (CIPA: Camera & Imaging Products Association)

Note

- You cannot print movies.

Preparing the camera

Prepare the camera for USB connection to the printer, using the dedicated USB cable.

- 1 Insert the sufficiently charged battery pack into the camera.
- 2 Connect the camera to the printer.

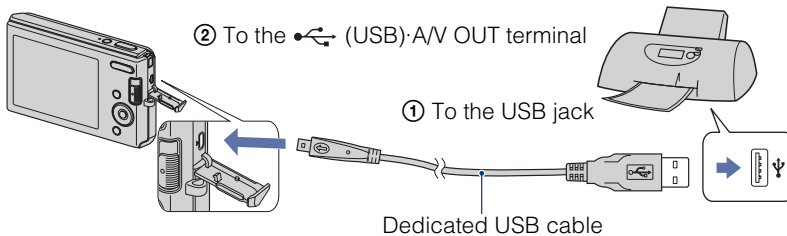

- 3 Turn on the camera and the printer.

After the connection is made, the  indicator appears on the screen.

If the  indicator flashes on the screen of the camera (error notification), check the connected printer.

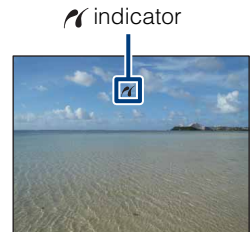

Note

- If it was impossible to connect to the printer, be sure to set [USB Connect] under [Main Settings] to [PictBridge].

Printing

1 MENU →  (Print) → desired mode → ● on the control button

This Image	Prints the currently displayed image in single-image mode.
Multiple Images	You can select and print multiple images. Do as following after step 1. ① Select an image then press ●. Repeat the above steps until there are no more images to be printed. ② MENU → [OK] → ●

2 Desired item → [OK] → ●

Quantity	Selects the number of copies of the specified image to be printed. • The designated number of images may not all fit onto a single sheet depending on the quantity of images.
Layout	Selects the number of images you want to print side by side on a sheet.
Size	Selects the size of the printing sheet.
Date	Selects [Date] or [Day&Time] to insert the date and time on images. • When you choose [Date], the date will be inserted in the order you select by [Clock Settings] of the camera. This function may not be provided depending on the printer.

Note

- Do not disconnect the dedicated USB cable while the  (PictBridge Connecting) indicator appears on the screen.

Printing at a shop

You can take a “Memory Stick Duo” media containing images shot with the camera to a photo printing service shop. As long as the shop supports photo printing services conforming to the DPOF, you can make a **DPOF** (Print order) mark on images in advance in viewing menu.

Notes

- You cannot print images stored in the internal memory at a print shop directly from the camera. Copy the images to a “Memory Stick Duo” media, then take the “Memory Stick Duo” media to the print shop (page 66).
- Consult your photo printing service shop as to what types of “Memory Stick Duo” media they handle.
- If a “Memory Stick Duo” media is not handled by your photo printing service shop, copy the images you want to print out to another medium such as a CD-R and take it to the shop.
- The “Memory Stick Duo” media Adaptor (sold separately) may be necessary. Consult your photo printing service shop.
- Before you take image data to a shop, always copy (back up) your data to a disk.
- You cannot set the number of prints.
- When you want to superimpose dates on images, consult your photo printing service shop.

Troubleshooting

If you experience trouble with the camera, try the following solutions.

1 Check the items on pages 87 to 94.

2 Remove the battery pack, wait for about one minute, re-insert the battery pack, then turn on the power.

3 Initialize the settings (page 59).

4 Consult your Sony dealer or local authorized Sony service facility.

On repairing cameras with internal memory included, data in the camera may be checked on minimum necessity to verify and improve the malfunction symptoms. Sony will not copy or save any of those data.

Additional information on this product and answers to frequently asked questions can be found at our Customer Support Website.
<http://www.sony.net/>

Click one of the following items to jump to the page explaining the symptom and cause or the appropriate corrective action.

Battery pack and power	87	Internal memory	92
Shooting still images/movies	88	Printing	92
Viewing images	90	PictBridge compliant printer.....	93
Deleting.....	90	Others	94
Computers	91	Warning messages	95
“Memory Stick Duo” media.....	92		

Battery pack and power

Cannot insert the battery pack.

- Insert the battery pack correctly by pushing the battery eject lever.

Cannot turn on the camera.

- After inserting the battery pack into the camera, it may take a few moments for the camera to power up.
- Insert the battery pack correctly.
- The battery pack is discharged. Insert a charged battery pack.
- The battery pack is dead (page 101). Replace it with a new one.
- Use a recommended battery pack.

The power turns off suddenly.

- Depending on the camera and battery temperature, the power may turn off automatically to protect the camera. In this case, a message is displayed on the LCD screen before the power turns off.
- If you do not operate the camera for about three minutes while the power is on, the camera turns off automatically to prevent wearing down the battery pack. Turn on the camera again.
- The battery pack is dead (page 101). Replace it with a new one.

The remaining charge indicator is incorrect.

- The battery charge will quickly get used up and the actual remaining battery charge will be lower than the indicator in the following cases:
 - When you use the camera in an extremely hot or cold location.
 - When you use the flash and zoom frequently.
 - When you repeatedly turn the power on and off.
 - When you set the screen brightness higher using DISP (screen display) settings.
- The battery pack is discharged. Insert a charged battery pack.
- The battery pack is dead (page 101). Replace it with a new one.

Cannot charge the battery pack.



- You cannot charge the battery pack using the AC Adaptor (sold separately). Use the battery charger to charge the battery.

The CHARGE lamp flashes while charging the battery.

- Remove and reinsert the battery pack, making sure it is installed correctly.
- The temperature may be inappropriate for charging. Try charging the battery pack again within the proper charging temperature range (10°C to 30°C (50°F to 86°F)).
- Refer to page 102 for details.

Shooting still images/movies



Cannot record images.

- Check the free capacity of the internal memory or “Memory Stick Duo” media. If it is full, do one of the following:
 - Delete unnecessary images (page 30).
 - Change the “Memory Stick Duo” media.
- You cannot record images while charging the flash.
- When shooting a still image, set the mode switch to  (Still Image).
- Set the mode switch to  (Movie) when shooting movies.

Smile Shutter function does not work.

- No image is shot if a smiling face is not detected.



The subject is not visible on the screen.

- The camera is set to the playback mode. Set the mode switch to  (Still Image) or  (Movie).

Anti-blur function does not work.

- The anti-blur function does not work when  appears on the display.
- The anti-blur function may not work properly when shooting night scenes.
- Shoot after pressing the shutter button halfway down; do not press it fully down suddenly.







The image is out of focus.

- The subject is too close. When shooting, make sure to position the lens farther away from the subject than the shortest shooting distance (approximately 5 cm (2 inches) (W)/40 cm (1 foot 3 3/4 inches) (T) from the lens).
-  (Twilight) or  (Landscape) mode is selected in the Scene Selection when shooting still images.
- The Semi-manual is selected. Select the auto focus mode (page 40).

Zoom does not work.

- You cannot use the Smart zoom depending on the image size (page 61).
- You cannot use the digital zoom when:
 - Shooting movies.
 - The Smile Shutter is working.



The flash does not work.

- You cannot use the flash when:
 - [REC Mode] is set to [Burst] (page 35).
 -  (High Sensitivity) or  (Twilight) mode is selected in the Scene Selection.
 - Shooting movies.
- Set the flash to  (Flash On) (page 26) when the Scene Selection mode is set to  (Landscape),  (Beach) or  (Snow).

Fuzzy white circular spots appear in images shot using the flash.

- Particles (dust, pollen, etc.) in the air reflected the flash light and appeared in the image. This is not a malfunction.

The close-up shoot function (Macro) does not work.

-  (Landscape) or  (Twilight) mode is selected in the Scene Selection.

Macro shooting cannot be turned off.

- There is no function for forcibly turning off macro shooting. In [Auto] mode, telephoto shooting is possible even in the macro shooting condition.

The date and time are not displayed on the LCD screen.

- While shooting, the date and time are not displayed. They are displayed only during playback.

Cannot insert dates on images.

- This camera does not have a feature for superimposing dates on images. By using “PMB”, you can print or save images with the date (page 74).

The F value and shutter speed flash when you press and hold the shutter button halfway down.

- The exposure is incorrect. Correct the exposure (page 36).

The LCD screen is too dark or too bright.

- Adjust the brightness of the backlight (page 14).

The image is too dark.

- You are shooting a subject with a light source behind the subject. Select the metering mode (page 42) or adjust the exposure (page 36).

The image is too bright.

- Adjust the exposure (page 36).

The image colors are not correct.

- Set [Color Mode] to [Normal] (page 47).
- Adjust the white balance (page 38).

White, black, red, purple or other vertical streaks appear, or the whole screen of the image becomes reddish when you are shooting a very bright subject.

- The smear phenomenon is occurring. This phenomenon is not a malfunction.

Noise appears in the image when you view the screen in a dark place.

- The camera is attempting to increase the visibility of the screen by temporarily brightening the image under conditions of low illumination. There is no effect on the recorded image.

The eyes of the subject come out red.

- Set [Red Eye Reduction] to [Auto] or [On] (page 46).
- Shoot the subject at a distance closer than the flash range using the flash.
- Light the room and shoot the subject.
- Retouch the image using [Retouch] → [Red Eye Correction] in viewing menu (page 50), or correct using “PMB”.

Dots appear and remain on the screen.

- This is not a malfunction. These dots are not recorded.

Cannot shoot images in succession.

- The internal memory or “Memory Stick Duo” media is full. Delete unnecessary images (page 30).
- The battery level is low. Insert charged battery pack.

The same image is shot several times.

- [REC Mode] is set to [Burst] (page 35).

Viewing images

Cannot play back images.

- Set the mode switch to  (Playback).
- The folder/file name has been changed on your computer.
- No guarantees are made for playing back, on this camera, files containing images which were processed on a computer or images which were shot using other cameras.
- The camera is in USB mode. Delete the USB connection (page 77).

The date and time are not displayed.

- The screen display is set to display images only. Press the DISP (screen display) button to display information (page 14).

The image appears rough right after playback starts.

- This may happen due to image processing. This is not a malfunction.

The image does not appear on the TV.

- Check [Video Out] to see if the video output signal of the camera is set to the color system of your TV (page 58).
- Check whether the connection is correct (page 69).
- If the dedicated USB cable is connected to another device, disconnect it (page 77).

Deleting

Cannot delete an image.

- Cancel the protection (page 52).

Computer OS compatibility with camera is unknown.

- Check “Recommended computer environment” on page 72 for Windows, and page 79 for Macintosh.

“Memory Stick PRO Duo” media is not recognized by a computer with a “Memory Stick” media slot.

- Check that the computer and the “Memory Stick” media Reader/Writer support “Memory Stick PRO Duo” media. Users of computers and “Memory Stick” media Readers/Writers made by manufacturers other than Sony should contact those manufacturers.
- If “Memory Stick PRO Duo” media is not supported, connect the camera to the computer (pages 75 and 80). The computer recognizes the “Memory Stick PRO Duo” media.

Your computer does not recognize the camera.

- When the battery level is low, insert the charged battery pack or use the AC adaptor (sold separately).
- Set [USB Connect] to [Mass Storage] (page 57).
- Use the dedicated USB cable (supplied).
- Disconnect the dedicated USB cable from both the computer and the camera, and connect it again firmly.
- Disconnect all equipment other than the camera, the keyboard and the mouse from the USB connectors of your computer.
- Connect the camera directly to your computer without passing through a USB hub or other device.

Cannot import images.

- Connect the camera and your computer correctly making a USB connection (page 75).
- When you shoot images with a “Memory Stick Duo” media formatted by a computer, you may not be able to import the images to a computer. Shoot using a “Memory Stick Duo” media formatted by the camera (page 63).

After making a USB connection, “PMB” does not start automatically.

- Make the USB connection after the computer is turned on.

Cannot play back images on your computer.

- If you are using “PMB”, refer to “PMB Guide” (page 74).
- Consult the computer or software manufacturer.

The image and sound are interrupted by noise when you view a movie on a computer.

- You are playing back the movie directly from the internal memory or the “Memory Stick Duo” media. Import the movie to the hard disk of your computer, then play back the movie from the hard disk (page 75).

Cannot print an image.

- Refer to the operation manual of the printer.

Images once exported to a computer cannot be viewed on the camera.

- Export them to a folder recognized by the camera, such as “101MSDCF” (page 78).

“Memory Stick Duo” media

Cannot insert a “Memory Stick Duo” media.

- Insert the “Memory Stick Duo” media in the correct direction.

You have formatted a “Memory Stick Duo” media by mistake.

- All the data on the “Memory Stick Duo” media is deleted by formatting. You cannot restore it.

Internal memory

Cannot playback or record images using the internal memory.

- There is a “Memory Stick Duo” media inserted in the camera. Remove it.

Cannot copy the data stored in the internal memory to a “Memory Stick Duo” media.

- The “Memory Stick Duo” media is full. Copy to a “Memory Stick Duo” media with sufficient capacity.

Cannot copy the data on the “Memory Stick Duo” media or the computer to the internal memory.

- This feature is not available.

Printing

See “PictBridge compliant printer” together with the following items.

Images are printed with both edges cut off.

- Depending on your printer, all the edges of the image may be cut off. Especially when you print an image shot with the image size set to [16:9], the lateral end of the image may be cut off.
- When printing images using your printer, cancel the trimming or borderless settings. Consult the printer manufacturer as to whether the printer provides these functions or not.
- When having images printed at a digital print shop, ask the shop whether they can print the images without cutting off both edges.

Cannot print images with the date.

- Using “PMB”, you can print images with date (page 74).
- The camera does not have a feature for superimposing dates on images. However, because the images shot with the camera include information on the recording date, you can print images with the date superimposed if the printer or the software can recognize Exif information. For compatibility with Exif information, consult the manufacturer of the printer or the software.
- If you use a photo printing service, ask them to superimpose the dates on images.

PictBridge compliant printer

A connection cannot be established.

- The camera cannot be connected directly to a printer that is not compliant with the PictBridge standard. Consult the printer manufacturer as to whether the printer is compliant with PictBridge or not.
- Check that the printer is turned on and can be connected to the camera.
- Set [USB Connect] to [PictBridge] (page 57).
- Disconnect and connect the dedicated USB cable again. If an error message is indicated on the printer, refer to the operating instructions supplied with the printer.

Cannot print images.

- Check that the camera and the printer are properly connected using the dedicated USB cable.
- Turn on the printer. For details, refer to the operating instructions supplied with the printer.
- If you select [Exit] during printing, images may not be printed. Disconnect and connect the dedicated USB cable again. If you still cannot print your images, disconnect the dedicated USB cable, turn the printer off and then on, then connect the dedicated USB cable again.
- Movies cannot be printed.
- Images shot using other cameras, or images modified with a computer may not be printed.

Printing is canceled.

- Confirm that you have disconnected the dedicated USB cable before the  (PictBridge Connecting) mark disappears.

Cannot insert the date or print images in the index mode.

- The printer does not provide these functions. Consult the printer manufacturer as to whether the printer provides these functions or not.
- The date may not be inserted in the index mode depending on the printer. Consult the printer manufacturer.

“---- -- --” is printed on the date-inserted part of the image.

- The image does not have the recording data so the date cannot be inserted. Set [Date] to [Off] and print the image again (page 84).

Cannot select the print size.

- Consult the printer manufacturer as to whether the printer can provide the desired size.

Cannot print the image at the size selected.

- When you use paper of a different size after connecting the printer to the camera, disconnect and then reconnect the dedicated USB cable.
- The print setting of the camera differs from that of the printer. Change the setting of either the camera (page 84) or the printer.

Cannot operate the camera after canceling printing.

- Wait for a while as the printer is carrying out the cancellation. It may take some time depending on the printer.

Others

The lens gets fogged.

- Moisture condensation has occurred. Turn off the camera and leave it for about an hour before using it.

The camera turns off with the lens portion extended.

- The battery pack is discharged. Replace it with a charged battery pack, then turn the camera on again.
- Do not attempt to force the lens that has stopped moving.

The camera becomes warm when you use it for a long time.

- This is not a malfunction.

The Clock Set screen appears when you turn on the camera.

- Set the date and time again (page 67).
- The internal rechargeable backup battery has discharged. Insert a charged battery, and set aside for 24 hours or more with the power left off.

You want to change the date or time.

- Change the settings by MENU → [Settings] → [Clock Settings] → [Clock Settings].

Warning messages

If the following messages appear, follow the instructions.



- The battery level is low. Charge the battery pack immediately. Depending on the conditions of use or the type of battery pack, the indicator may flash even though there are still 5 to 10 minutes of remaining battery time left.

For use with compatible battery only

- The battery inserted is not an NP-BK1 (supplied) battery pack.

System error

- Turn the power off and then on again.

Camera overheating

Allow it to cool

- The camera temperature has risen. The power may turn off automatically. Leave the camera in a cool location until the temperature drops.

Internal memory error

- Turn the power off and then on again.

Reinsert the “Memory Stick”

- Insert the “Memory Stick Duo” media correctly.
- The inserted “Memory Stick Duo” media cannot be used in the camera (page 99).
- The “Memory Stick Duo” media is damaged.
- The terminal section of the “Memory Stick Duo” media is dirty.

“Memory Stick” type error

- The inserted “Memory Stick Duo” media cannot be used in the camera (page 99).

Cannot access “Memory Stick”

Access denied

- You are using the “Memory Stick Duo” media with the access controlled.

Error formatting internal memory

Error formatting “Memory Stick”

- Format the media again (page 63).

“Memory Stick” locked

- You are using the “Memory Stick Duo” media with the write-protect switch, and the switch is set to the LOCK position. Set the switch to the recording position.

No memory space on “Memory Stick”

No memory space on internal memory

- Delete unnecessary images or files (page 30).

Read only “Memory Stick”

- The camera cannot record or delete images on this “Memory Stick Duo” media.

No images

- No images that can be played back have been recorded in the internal memory.
- No images that can be played back have been recorded in this folder of the “Memory Stick Duo” media.

Folder error

- A folder with the same first three digit number already exists on the “Memory Stick Duo” media (for example: 123MSDCF and 123ABCDE). Select another folder, or create a new folder (pages 64, 65).

Cannot create more folders

- The folder with a name beginning with “999” exists on the “Memory Stick Duo” media. You cannot create any folders if this is the case.

File error

- An error occurred while the image was playing back.
No guarantees are made for playing back, on this camera, files containing images which were processed on a computer or images which were shot using other cameras.

Read only folder

- You have selected a folder that cannot be set as a recording folder on the camera. Select another folder (page 65).

File protected

- Release the protection (page 52).

Image size over limit

- You are playing back an image with size that cannot be played back on the camera.

Unable to detect face for retouch

- You may not be able to retouch the image depending on the image.

(Vibration warning indicator)

- Camera shake may occur due to insufficient light. Use the flash, set the anti-blur function to [Auto], or mount the camera on a tripod to secure the camera.

Turn the power off and on again

- The lens malfunction.

Maximum number of images already selected

- Up to 100 files can be selected when using [Multiple Images].
- Up to 999 files can be selected when using [All in This Folder].
- You can add **DPOF** (Print order) marks to up to 999 files. Cancel the selection.

Low battery power

- When copying a image recorded in the internal memory to the “Memory Stick Duo” media, use a fully charged battery.

Printer busy

Paper error

No paper

Ink error

Low ink

No ink

- Check the printer.

Printer error

- Check the printer.
- Check if the image you want to print is corrupted.



- The data transmission to the printer may not be completed yet. Do not disconnect the dedicated USB cable.

Processing...

- The printer is canceling the current print job. You cannot print until it is finished. This may take time, depending on the printer.

Operation cannot be executed for movie files

- You have selected a function that is not available for movies.

Operation cannot be executed in unsupported files

- Processing and other editing functions of the camera cannot be performed on image files that have been processed using a computer or images that were recorded with other cameras.

Operation cannot be executed when using a PictBridge connection

- Some functions are restricted while the camera is connected to a PictBridge compliant printer.

Using the camera abroad — Power sources

You can use the camera, the battery charger (supplied), and the AC-LS5K AC Adaptor (sold separately) in any country or region where the power supply is within 100 V to 240 V AC, 50 Hz/60 Hz.

Note

- Do not use an electronic transformer (travel converter), as this may cause a malfunction.

Table of
contents

Operation
Search

MENU/Settings
Search

Index

On the “Memory Stick Duo” media

A “Memory Stick Duo” media is a compact, portable IC recording medium. The types of “Memory Stick Duo” media that can be used with the camera are listed in the table below. However, proper operation cannot be guaranteed for all “Memory Stick Duo” media functions.

“Memory Stick” media type	Recording/Playback
Memory Stick Duo (without MagicGate)	○*1
Memory Stick Duo (with MagicGate)	○*2
MagicGate Memory Stick Duo	○*1*2
Memory Stick PRO Duo	○*2
Memory Stick PRO-HG Duo	○*2*3

*1 High-speed data transfer using a parallel interface is not supported.

*2 “Memory Stick Duo” media, “MagicGate Memory Stick Duo” media and “Memory Stick PRO Duo” media are equipped with MagicGate functions. MagicGate is copyright protection technology that uses encryption technology. Data recording/playback that requires MagicGate functions cannot be performed with the camera.

*3 This camera does not support 8-bit parallel data transfer. It performs the same 4-bit parallel data transfer as the “Memory Stick PRO Duo” media.

Notes

- This product is compatible with “Memory Stick Micro” media (“M2”). “M2” is an abbreviation for “Memory Stick Micro” media.
- A “Memory Stick Duo” media formatted with a computer is not guaranteed to operate with the camera.
- Data read/write speeds differ depending on the combination of the “Memory Stick Duo” media and the equipment used.
- Do not remove the “Memory Stick Duo” media while reading or writing data.
- Data may be corrupted in the following cases:
 - When the “Memory Stick Duo” media is removed or the camera is turned off during a read or write operation
 - When the “Memory Stick Duo” media is used in locations subject to static electricity or electrical noise
- We recommend backing up important data.
- Do not press down hard when you write down on the memo area.
- Do not attach a label on the “Memory Stick Duo” media itself nor on a “Memory Stick Duo” media Adaptor.
- When you carry or store the “Memory Stick Duo” media, put it in the case supplied with it.
- Do not touch the terminal section of the “Memory Stick Duo” media with your hand or a metal object.
- Do not strike, bend or drop the “Memory Stick Duo” media.
- Do not disassemble or modify the “Memory Stick Duo” media.
- Do not expose the “Memory Stick Duo” media to water.
- Do not leave the “Memory Stick Duo” media within the reach of small children. They might accidentally swallow it.
- Do not insert anything other than a “Memory Stick Duo” media into the “Memory Stick Duo” media slot. Doing so will cause a malfunction.
- Do not use or store the “Memory Stick Duo” media under the following conditions:
 - High temperature locations such as the hot interior of a car parked in direct sunlight
 - Locations exposed to direct sunlight
 - Humid locations or locations with corrosive substances present

Notes on using the “Memory Stick Duo” media Adaptor (sold separately)

- To use a “Memory Stick Duo” media with a “Memory Stick” media compliant device, be sure to insert the “Memory Stick Duo” media into a “Memory Stick Duo” media Adaptor. If you insert a “Memory Stick Duo” media into a “Memory Stick” media compliant device without a “Memory Stick Duo” media Adaptor, you might not be able to remove it from the device.
- When inserting a “Memory Stick Duo” media into a “Memory Stick Duo” media Adaptor, make sure the “Memory Stick Duo” media is inserted facing in the correct direction, then insert it all the way in. Incorrect insertion may result in a malfunction.
- When using a “Memory Stick Duo” media inserted into a “Memory Stick Duo” media Adaptor with a “Memory Stick” media compliant device, make sure that the “Memory Stick Duo” media Adaptor is inserted facing the correct direction. Note that improper use may damage the equipment.
- Do not insert a “Memory Stick Duo” media Adaptor into a “Memory Stick” media compliant device without a “Memory Stick Duo” media attached. Doing so may result in malfunction of the unit.

Notes on using “Memory Stick PRO Duo” media (sold separately)

“Memory Stick PRO Duo” media with a capacity up to 16 GB have been confirmed to operate properly with the camera.

Notes on using “Memory Stick Micro” media (sold separately)

- To use a “Memory Stick Micro” media with the camera, be sure to insert the “Memory Stick Micro” media into an “M2” Adaptor as large as of Duo size. If you insert a “Memory Stick Micro” media into the camera without an “M2” Adaptor as large as of Duo size, you might not be able to remove it from the camera.
- Do not leave the “Memory Stick Micro” media within the reach of small children. They might accidentally swallow it.

On the battery pack

On charging the battery pack

- We recommend charging the battery pack in an ambient temperature of between 10°C to 30°C (50°F to 86°F). The battery pack may not be fully charged in temperatures outside this range.

Effective use of the battery pack

- Battery performance decreases in low temperature surroundings. So in cold places, the operational time of the battery pack is shorter. We recommend the following to ensure longer battery pack use:
 - Put the battery pack in a pocket close to your body to warm it up, and insert it in the camera immediately before you start shooting.
- The battery pack will run out quickly if you use the flash or zoom frequently.
- We recommend having spare battery packs handy for two or three times the expected shooting time, and making trial shots before taking the actual shots.
- Do not expose the battery pack to water. The battery pack is not water-resistant.
- Do not leave the battery pack in extremely hot places, such as in a car or under direct sunlight.

How to store the battery pack

- Fully discharge the battery pack before storing and store it in a cool, dry place. To maintain the battery pack's function, fully charge the battery pack and then fully discharge it on the camera at least once a year while storing.
- To use the battery pack up, leave the camera in slideshow playback mode until the power goes off.
- To prevent staining the terminal, short-circuiting, etc., be sure to use a supplied battery case when carrying and storing.

On battery life

- The battery life is limited. Battery capacity decreases over time and through repeated use. If decreased usage time between charges becomes significant, it is probably time to replace it with a new one.
- The battery life varies according to how it is stored and the operating conditions and environment in which each battery pack is used.

Compatible battery pack

- The NP-BK1 (supplied) can be used only in K type compatible Cyber-shot models.

On the battery charger

- Only NP-BK type battery packs (and no others) can be charged in the battery charger (supplied). Batteries other than the specified kind may leak, overheat, or explode if you attempt to charge them, posing a risk of injury from electrocution and burns.
- Remove the charged battery pack from the battery charger. If you leave the charged battery pack in the charger, battery life may be shortened.
- The CHARGE lamp of the supplied battery charger flashes in either way:
 - Fast flashing: Turns the light on and off repeatedly at the interval of 0.15 seconds.
 - Slow flashing: Turns the light on and off repeatedly at the interval of 1.5 seconds.
- When the CHARGE lamp flashes fast, remove the battery pack being charged, and then insert the same battery pack into the battery charger securely again. When the CHARGE lamp flashes fast again, this may indicate a battery error or that a battery pack other than the specified type has been inserted. Check that the battery pack is the specified type. If the battery pack is the specified type, remove the battery pack, replace it with a new one or another one and check if the battery charger operates correctly. If the battery charger operates correctly, a battery error may have occurred.
- When the CHARGE lamp flashes slowly, it indicates that the battery charger stops charging temporarily on standby. The battery charger stops charging and enters the standby status automatically when the temperature is outside of the recommended operating temperature. When the temperature gets back within the appropriate range, the battery charger resumes charging and the CHARGE lamp lights up again. We recommend charging the battery pack in an ambient temperature of between 10°C to 30°C (50°F to 86°F).

Index

A

Adjusting EV	36
AF range finder frame	40
Aperture	36
Auto Adjustment	17
Auto Review	62

B

Battery charger	102
Battery pack	101
Beach	18
Beep	56
Burst	35

C

Center AF	40
Center-weighted metering	42
Change REC.Folder	65
Changing the display	14
Clock Settings	67
Color Mode	47
Computer	71
Importing images	76, 80
Macintosh	79
Recommended environment	72, 79
Windows	71
Connecting	
Computer	75
Printer	83
TV	69
Copy	66
Create REC.Folder	64

D

Date	84
Dedicated A/V cable	69
Dedicated USB cable	75, 80, 83
Delete	30
Digital Zoom	61
DISP	14

E

Electronic transformer	98
------------------------------	----

EV	36
Exporting images	77
Exposure	36

F

Face Detection	44
Flash Level	45
Flash	26
Focus	40
Folder	
Changing	65
Creating	64
Selecting	55
Format	63

G

Grid Line	60
-----------------	----

H

High Sensitivity	18
Histogram	15

I

Identifying parts	12
Image Index	29
Image Size	32
Initialize	59
Install	73
Internal memory	16
ISO	36, 37

L

Landscape	18
Language Setting	68
LCD Screen	14

M

Macintosh computer	79
Macro	25
Mass Storage	57
“Memory Stick Duo” media	99
MENU	9
Menu screen	9
Metering Mode	42

Mode switch.....	13	Slideshow.....	48
Movie.....	20	Slow Synchro.....	26
Multi AF.....	40	Smart zoom.....	61
Multi-pattern metering.....	42	Smile Detection Sensitivity.....	43
Multi-Purpose Resize.....	51	Smile Shutter.....	22
N		Snow.....	18
NTSC.....	58	Soft Snap.....	18
O		Software.....	73, 74, 79
Optical zoom.....	23, 61	Spot metering.....	42
OS.....	72	T	
P		Trimming.....	50
PAL.....	58	Troubleshooting.....	86
PC.....	71	TV.....	69
PictBridge.....	57, 83	Twilight.....	18
Pixel.....	33	Twilight Portrait.....	18
Playback.....	27	U	
Playback zoom.....	28	USB Connect.....	57
PMB.....	74	USB-A/V OUT terminal.....	69, 75, 80, 83
Precision digital zoom.....	61	Using the camera abroad.....	98
Print.....	53, 82	V	
Print order mark.....	85	VGA.....	32
Printing directly.....	83	Video Out.....	58
Program Auto.....	21	W	
Protect.....	52	Warning messages.....	95
R		White Balance.....	38
REC Mode.....	35	Windows computer.....	71
Red Eye Correction.....	50	Z	
Red Eye Reduction.....	46	Zoom.....	23
Retouch.....	50		
Rotate.....	54		
S			
Scene Selection.....	18		
Screen.....	14		
Select Folder.....	55		
Self-Timer.....	24		
Semi-manual.....	40		
Settings.....	11		
Shooting			
Movie.....	20		
Still image.....	17		
Shutter speed.....	36		