

SONY®

Cyber-shot

Digital Still Camera

Cyber-shot Handbook

DSC-W80/W85/W90

Before operating the unit, please read this Handbook thoroughly together with the “**Instruction Manual**” and the “**Cyber-shot Step-up Guide**”, and retain them for future reference.

▼CLICK!



Table of contents



Basic Operations



Using functions for shooting



Using functions for viewing



Customizing the settings



Viewing images on a TV



Using your computer



Printing still images



Troubleshooting



Others



Index

Notes on using your camera

Types of “Memory Stick” that can be used (not supplied)

The IC recording medium used by this camera is a “Memory Stick Duo”. There are two types of “Memory Stick”.

“Memory Stick Duo”: you can use a “Memory Stick Duo” with your camera.



“Memory Stick”: you cannot use a “Memory Stick” with your camera.



Other memory cards cannot be used.

- For details on “Memory Stick Duo”, see page 113.

When using a “Memory Stick Duo” with “Memory Stick” compatible equipment

You can use the “Memory Stick Duo” by inserting it into the Memory Stick Duo Adaptor (not supplied).



Memory Stick Duo Adaptor

Notes on the battery pack

- Charge the battery pack (supplied) before using the camera for the first time.
- The battery pack can be charged even if it is not completely discharged. Also, even if the battery pack is not fully charged, you can use the partially charged capacity of the battery pack as is.

- If you do not intend to use the battery pack for a long time, use up the existing charge and remove it from your camera, then store it in a cool, dry place. This is to maintain the battery pack functions.
- For details on the usable battery pack, see page 115.

Carl Zeiss lens

This camera is equipped with a Carl Zeiss lens which is capable of reproducing sharp images with excellent contrast.

The lens for this camera has been produced under a quality assurance system certified by Carl Zeiss in accordance with the quality standards of Carl Zeiss in Germany.

Notes on the LCD screen and lens

- The LCD screen is manufactured using extremely high-precision technology so over 99.99% of the pixels are operational for effective use. However, there may be some tiny black points and/or bright points (white, red, blue or green in color) that constantly appear on the LCD screen. These points are normal in the manufacturing process and do not affect the recording in any way.



Black, white, red, blue or green points

- Exposing the LCD screen or the lens to direct sunlight for long periods may cause malfunctions. Be careful when placing the camera near a window or outdoors.
- Do not press against the LCD screen. The screen may be discolored and that may cause a malfunction.
- Images may trail across on the LCD screen in a cold location. This is not a malfunction.
- Be careful not to bump the movable lens, and be careful not to apply force to it.

The pictures used in this Handbook

The photographs used as examples of pictures in this Handbook are reproduced images, and are not actual images shot using this camera.

Table of contents

Notes on using your camera	2
Basic techniques for better images	7
Focus – Focusing on a subject successfully.....	7
Exposure – Adjusting the light intensity	8
Color – On the effects of lighting.....	9
Quality – On “image quality” and “image size”	10
Identifying parts.....	12
Indicators on the screen	14
Changing the screen display	18
Using the internal memory	20











Basic Operations

Using the mode dial.....	21
Shooting images easily (Auto Adjustment mode).....	22
Shooting still images (Scene Selection).....	26
Viewing images	29
Deleting images.....	31
Learning the various functions – HOME/Menu.....	33
Menu items.....	36









Using functions for shooting

Shooting menu	37
Image Size: Selecting the image size	
Face Detection: Detecting the face of subject	
REC Mode: Selecting the continuous shooting method	
Color Mode: Changing the vividness of the image or adding special effects	
ISO: Selecting a luminous sensitivity	
EV: Adjusting the light intensity	
Metering Mode: Selecting the metering mode	
Focus: Changing the focus method	
White Bal: Adjusting the color tones	
Flash Level: Adjusting the amount of flash light	
Red Eye Reduction: Reducing the red-eye phenomenon	
SteadyShot: Selecting the anti-blur mode	
SETUP: Selecting the shooting settings	

Using functions for viewing

<i>Playing back images from the HOME screen</i>	48
<ul style="list-style-type: none">  (Single Image): Playing back a single image  (Index Display): Playing back a list of images  (Slide Show): Playing back a series of images 	
<i>Viewing menu</i>	51
<ul style="list-style-type: none">  (Delete): Deleting images  (Slide Show): Playing back a series of images  (Retouch): Retouching still images after shooting  (Protect): Preventing accidental erasure DPOF: Adding a Print order mark  (Print): Printing images using a printer  (Rotate): Rotating a still image  (Select Folder): Selecting the folder for viewing images 	

Customizing the settings

<i>Customizing the Manage Memory feature and the Settings</i>	56				
 Manage Memory	58				
<ul style="list-style-type: none">  Memory Tool — Memory Stick Tool..... <table style="width: 100%; border: none;"> <tr> <td style="width: 50%;">Format</td> <td>Change REC. Folder</td> </tr> <tr> <td>Create REC. Folder</td> <td>Copy</td> </tr> </table> 	Format	Change REC. Folder	Create REC. Folder	Copy	58
Format	Change REC. Folder				
Create REC. Folder	Copy				
<ul style="list-style-type: none">  Memory Tool — Internal Memory Tool Format 	61				
 Settings	62				
<ul style="list-style-type: none">  Main settings — Main Settings 1..... <table style="width: 100%; border: none;"> <tr> <td style="width: 50%;">Beep</td> <td>Initialize</td> </tr> <tr> <td>Function Guide</td> <td></td> </tr> </table> 	Beep	Initialize	Function Guide		62
Beep	Initialize				
Function Guide					
<ul style="list-style-type: none">  Main settings — Main Settings 2..... <table style="width: 100%; border: none;"> <tr> <td style="width: 50%;">USB Connect</td> <td>Video Out</td> </tr> <tr> <td>COMPONENT</td> <td></td> </tr> </table> 	USB Connect	Video Out	COMPONENT		63
USB Connect	Video Out				
COMPONENT					
<ul style="list-style-type: none">  Shooting Settings — Shooting Settings 1..... <table style="width: 100%; border: none;"> <tr> <td style="width: 50%;">AF Illuminator</td> <td>AF Mode</td> </tr> <tr> <td>Grid Line</td> <td>Digital Zoom</td> </tr> </table> 	AF Illuminator	AF Mode	Grid Line	Digital Zoom	65
AF Illuminator	AF Mode				
Grid Line	Digital Zoom				
<ul style="list-style-type: none">  Shooting Settings — Shooting Settings 2..... <table style="width: 100%; border: none;"> <tr> <td style="width: 50%;">Auto Orientation</td> <td>Auto Review</td> </tr> </table> 	Auto Orientation	Auto Review	67		
Auto Orientation	Auto Review				
 Clock Settings	68				

A Language Setting.....	69
--------------------------------	----

Viewing images on a TV

Viewing images on a TV.....	70
-----------------------------	----

Using your computer

Enjoying your Windows computer	73
Installing the software (supplied).....	75
Copying images to your computer.....	76
Viewing image files stored on a computer with your camera (using a “Memory Stick Duo”)	82
Using the “Picture Motion Browser” (supplied).....	83
Using the “Music Transfer” (supplied).....	89
Using your Macintosh computer	90

Printing still images

How to print still images	92
Printing images directly using a PictBridge compliant printer	93
Printing at a shop	96

Troubleshooting

Troubleshooting	98
Warning indicators and messages	109

Others

To use your camera abroad — Power sources.....	112
On the “Memory Stick”	113
On the battery pack	115
On the battery charger	116

Index

Index	117
-------------	-----

Basic techniques for better images

Focus

Exposure

Color

Quality



This section describes the basics so you can enjoy your camera. It tells you how to use various camera functions such as the mode dial (page 21), the HOME screen (page 33), the menus (page 35), and so on.

Focus *Focusing on a subject successfully*

When you press the shutter button halfway down, the camera adjusts the focus automatically (Auto Focus). Remember to press the shutter button only halfway down.

Press the shutter button fully down suddenly.

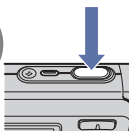

Press the shutter button halfway down.

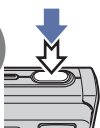

AE/AF lock indicator flashing → lit/beeps



Then press the shutter button fully down.

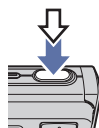

To shoot a still image difficult to focus on → [Focus] (page 42)

If the image looks blurred even after focusing, it may be because of camera shake. → See "Hints for preventing blur" (as follows).

Hints for preventing blur

Hold the camera steady, keeping your arms at your side. It is recommended to lean against a tree or a building nearby to steady yourself. Shooting with a 2-second delay self-timer or using a tripod is also effective. Use the flash when you shoot under a low light condition.



Exposure *Adjusting the light intensity*

You can create various images by adjusting the exposure and the ISO sensitivity. Exposure is the amount of light that the camera will receive when you release the shutter.

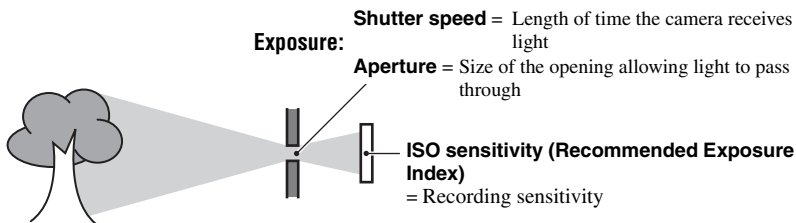

Overexposure
= too much light
Whitish image

The exposure is automatically set to the proper value in the auto adjustment mode. However, you can adjust it manually using the functions below.



Correct exposure

Adjusting EV:

Allows you to adjust the exposure determined by the camera (pages 19, 41).

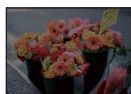

Underexposure
= too little light
Darker image

Metering Mode:

Allows you to change the part of the subject to be measured to determine the exposure (page 42).

Adjusting ISO Sensitivity (Recommended Exposure Index)

ISO sensitivity is a speed rating for recording media that incorporates an image sensor that receives light. Even when the exposure is the same, images differ depending on the ISO sensitivity.

To adjust the ISO sensitivity, see page 41.



High ISO sensitivity

Records a bright image even when shooting in a dark location. However, the image tends to become noisy.



Low ISO sensitivity

Records a smoother image.





However, when the exposure is insufficient, the image may become darker.

Color

On the effects of lighting

The apparent color of the subject is affected by the lighting conditions.

Example: The color of an image affected by light sources

Weather/lighting	Daylight	Cloudy	Fluorescent	Incandescent
Characteristics of light	White (standard) 	Bluish 	Green-tinged 	Reddish 

The color tones are adjusted automatically in the auto adjustment mode. However, you can adjust color tones manually with [White Bal] (page 45).

Quality

On “image quality” and “image size”

A digital image is made up of a collection of small dots called pixels.

If it contains a large number of pixels, the picture becomes large, it takes up more memory, and the image is displayed in fine detail. “Image size” is shown by the number of pixels.

Although you cannot see the differences on the screen of the camera, the fine detail and data processing time differ when the image is printed or displayed on a computer screen.

Description of the pixels and the image size

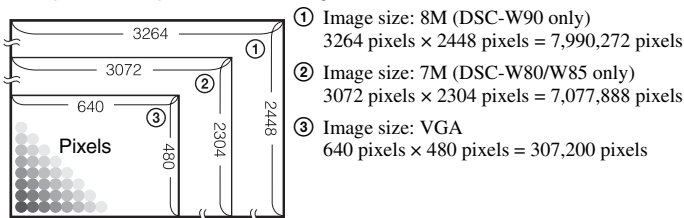

Selecting the image size for use (page 11)

The diagram shows a photograph of a bird on the left. A blue square highlights a small area, which is magnified into a grid of pixels. To the right, two circular insets show different levels of pixel density. The top inset shows a sharp, detailed image of the bird's head, labeled 'Many pixels (Fine image quality and large file size)'. The bottom inset shows a blurry, low-resolution image of the same bird's head, labeled 'Few pixels (Rough image quality but small file size)'. Arrows point from these insets to the right, where text provides examples: 'Example: Printing in up to A3 size' for many pixels and 'Example: An attached image to be sent by e-mail' for few pixels.



Pixel

Many pixels (Fine image quality and large file size) → Example: Printing in up to A3 size

Few pixels (Rough image quality but small file size) → Example: An attached image to be sent by e-mail

Basic techniques for better images

The default settings are marked with ✓.

	Image size	Guidelines	No. of images	Printing
✓	8M (3264×2448) (DSC-W90 only)	For prints up to A3 (11×17")		
	3:2 ¹⁾ (3264×2176) (DSC-W90 only)	Shoot in 3:2 aspect ratio		
✓	7M (3072×2304) (DSC-W80/W85 only)	For prints up to A3 (11×17")		
	3:2 ¹⁾ (3072×2048) (DSC-W80/W85 only)	Shoot in 3:2 aspect ratio		
	5M (2592×1944)	For prints up to A4 (8.5×11")		
	3M (2048×1536)	For prints up to 10×15 cm (4×6") or 13×18 cm (5×7")		
	VGA (640×480)	Shoot at a small image size for e-mail attachment		
	16:9 ²⁾ (1920×1080)	Shoot in HDTV aspect ratio		

1) Images are recorded in 3:2 aspect ratio, same as photograph printing paper or postcards, etc.

2) Both edges of the image may be cut off when printing (page 106).

	Movie image size	Frame/Second	Usage guidelines
	640(Fine) (640×480)	Approx. 30	Shoot high quality movie for display on TV
✓	640(Standard) (640×480)	Approx. 17	Shoot standard quality movie for display on TV
	320 (320×240)	Approx. 8	Shoot at a small size for email attachment

- The larger the image size, the higher the image quality.
- The more frames per second you played back, the smoother playback can be.

Identifying parts

See the pages in parentheses for details of operation.

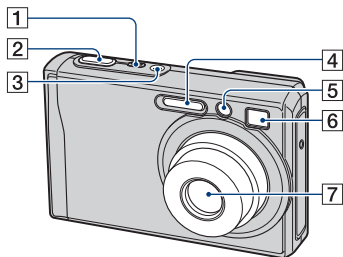

- 1** POWER button/POWER lamp
- 2** Shutter button (22)
- 3** Microphone
- 4** Flash (24)
- 5** AF illuminator (65)/Self-timer lamp (24)
- 6** Finder window
- 7** Lens

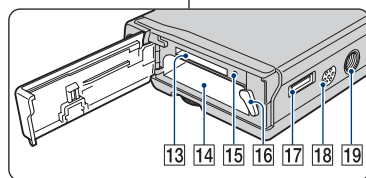
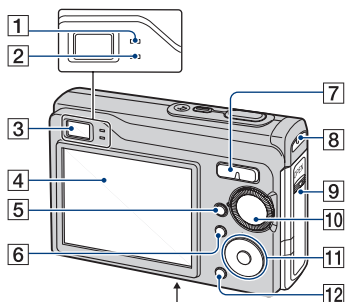

- 1** AE/AF lock lamp/Self-timer lamp (green) (24)
- 2** Flash charging lamp/Record lamp (orange)
- 3** Finder
- 4** LCD screen (18)
- 5** ▶ (Playback) button (29)
- 6** MENU button (35)
- 7** For shooting: Zoom (W/T) button (23)
For viewing: ◀/▶ (Playback zoom) button/☒ (Index) button (29, 30)
- 8** Hook for strap
- 9** Battery/"Memory Stick Duo" cover
- 10** Mode dial (21)
- 11** Control button
Menu on: ▲/▼/◀/▶/● (35)
Menu off: DISP/☺/☹/⚡ (18, 24)
- 12** HOME button (33)
- 13** "Memory Stick Duo" slot
- 14** Battery insertion slot

Identifying parts

15 Access lamp

16 Battery eject lever

17 Multi connector (bottom)

Used in the following situations:

- Making a USB connection between the camera and the computer.
- Making a connection to audio/video input jacks on a TV.
- Making a connection to a PictBridge compliant printer.

18 Speaker

19 Tripod receptacle (bottom)

- Use a tripod with a screw length of less than 5.5 mm (7/32 inch). You will be unable to firmly secure the camera to tripods having screws longer than 5.5 mm (7/32 inch), and may damage the camera.

Indicators on the screen

Each time you press ▲ (DISP) button, the display changes (page 18). See the pages in parentheses for details of operation.

When shooting still images

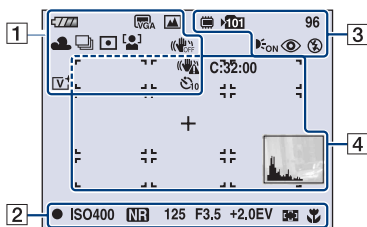

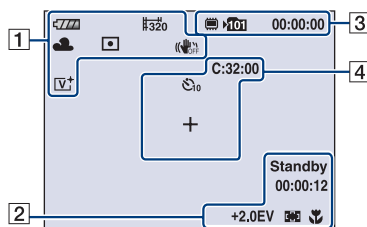

When shooting movies









1

Display	Indication
	Battery remaining
	Low battery warning (109)
	Image size (37) <ul style="list-style-type: none"> • 8M is displayed only for the DSC-W90. • 7M is displayed only for the DSC-W80/W85.
	Mode dial (Scene Selection) (26)
	Mode dial (Program) (21)
	White balance (45)
	Recording mode (39)
	Metering mode (42)
	Face Detection (38)
	SteadyShot (47)
	Vibration warning <ul style="list-style-type: none"> • Indicates vibration may prevent you from shooting clear images due to insufficient lighting. Even if the vibration warning appears, you can still shoot images. However, we recommend that you turn on the anti-blur function, using the flash for better lighting or using a tripod or other means to stabilize the camera (page 7).
	Self-timer (24)
	Zoom scaling (23, 66)
	Color mode (40)



2

Display	Indication
1.0m	Focus preset distance (42)
	AE/AF lock (22)
Standby REC	Standby a movie/Recording a movie
ISO400	ISO number (41)
NR	NR slow shutter <ul style="list-style-type: none"> When the shutter speed drops below a certain speed in low light conditions, the NR (Noise Reduction) slow shutter function activates automatically to reduce the picture noise.
125	Shutter speed
F3.5	Aperture value
+2.0EV	Exposure Value (41)
00:00:12	Recording time
	AF range finder frame indicator (42)
	Macro (24)

3

Display	Indication
	Recording Media
	Recording folder (58) <ul style="list-style-type: none"> This does not appear when using internal memory.
96	Remaining number of recordable images
00:00:00	Remaining recordable time
	AF illuminator (65)
	Red-eye reduction (46)
	Flash mode (24)
	Flash charging

4

Display	Indication
C:32:00	Self-diagnosis display (109)
	Self-timer (24)
+	Spot metering cross hair (42)
	AF range finder frame (42)
	Histogram (18)

When playing back still images

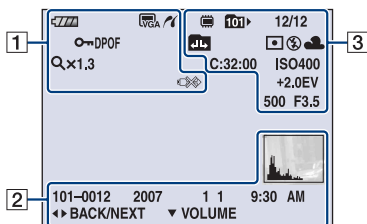

When playing back movies

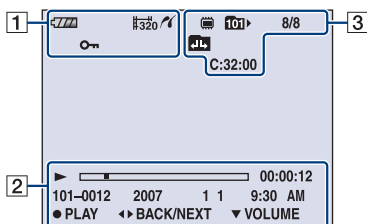







1

Display	Indication
	Battery remaining
	Image size (37) <ul style="list-style-type: none"> • 8M is displayed only for the DSC-W90. • 7M is displayed only for the DSC-W80/W85.
	Protect (53)
	Volume (29)
	Print order (DPOF) mark (96)
	Zoom scaling (29)
	PictBridge connecting (94)
	PictBridge connecting (95) <ul style="list-style-type: none"> • Do not disconnect the cable for multi-use terminal while the icon is displayed.

2

Display	Indication
	Playback (29)
	Playback bar
00:00:12	Counter
101-0012	Folder-file number (55)
2007 1 1 9:30 AM	Recorded date/time of the playback image
● STOP ● PLAY	Function guide for playing image
◀▶ BACK/NEXT	Select images
▼ VOLUME	Adjust volume
	Histogram (18) <ul style="list-style-type: none"> • appears when histogram display is disabled.

3

Display	Indication
	Playback Media
	Playback folder (55) <ul style="list-style-type: none"> This does not appear when using internal memory.
8/8 12/12	Image number/Number of images recorded in selected folder
	Change folder (55) <ul style="list-style-type: none"> This does not appear when using internal memory.
	Metering mode (42)
	Flash
AWB 	White balance (45)
C:32:00	Self-diagnosis display (109)
ISO400	ISO number (41)
+2.0EV	Exposure Value (41)
500	Shutter speed
F3.5	Aperture value

Changing the screen display

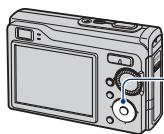

▲ (DISP)
(Screen display
button) button

Each time you press the ▲ (DISP) button, the display changes as follows.

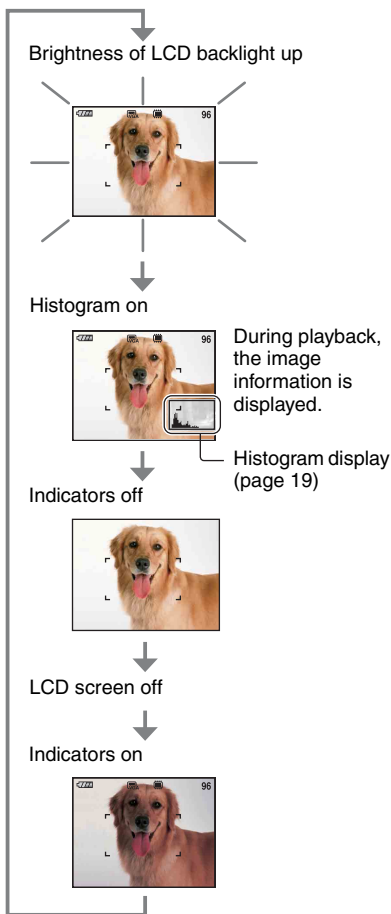

- If you view images in bright outside light, adjust the brightness of the LCD backlight up. However, the battery power may decrease faster under such condition.
- The display becomes Histogram on → Indicators off → Indicators on when connected to a TV (page 70).
- The histogram does not appear in the following situations:
 - While shooting
 - When the menu is displayed.
 - When recording movies
 - During playback
 - When the menu is displayed.
 - In index mode
 - When you are using playback zoom.
 - When you are rotating still images.
 - During playback of movies
- During image playback, you cannot turn the LCD screen off.
- A large difference in the histogram displayed when shooting and during playback may occur when:
 - The flash strobes.
 - The shutter speed is slow or fast.
- The histogram may not appear for images recorded using other cameras.
- When you set the LCD screen to off, the digital zoom does not function. When you select (flash mode)/ (self-timer)/ (macro), the image is displayed for about two seconds.

Changing the screen display

☞ Adjusting EV (Exposure Value) by displaying a histogram

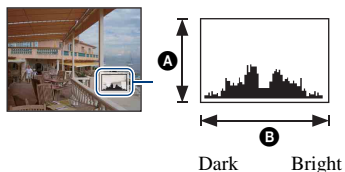

A histogram is a graph showing the brightness of an image. Press ▲ (DISP) repeatedly to display the histogram inside the screen. The graph display indicates a bright image when skewed to the right side, and a dark image when skewed to the left side.

- Ⓐ Number of pixels
- Ⓑ Brightness

- The histogram also appears when playing back a single image, but you cannot adjust the exposure.

Using the internal memory

The camera has approximately 31 MB of internal memory. This memory is not removable. Even when there is no “Memory Stick Duo” inserted in the camera, you can record images using this internal memory.

- Movies with the image size set to [640(Fine)] cannot be recorded using the internal memory.

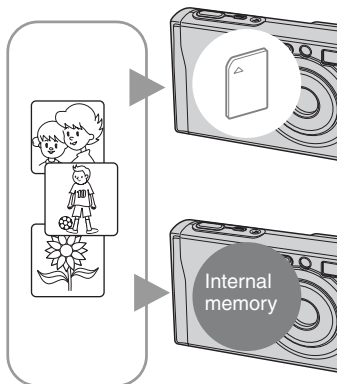

When a “Memory Stick Duo” is inserted

[Recording]: Images are recorded on the “Memory Stick Duo”.

[Playback]: Images on the “Memory Stick Duo” are played back.

[Menu, Settings, etc.]: Various functions can be performed on images on the “Memory Stick Duo”.

When there is no “Memory Stick Duo” inserted

[Recording]: Images are recorded using the internal memory.

[Playback]: Images stored in the internal memory are played back.

[Menu, Settings, etc.]: Various functions can be performed on images in the internal memory.

On image data stored in the internal memory

We recommend that you copy (back up) data without error using one of the following methods.

To copy (back up) data on a “Memory Stick Duo”

Prepare a “Memory Stick Duo” with a capacity of 64 MB or more, then perform the procedure explained in [Copy] (page 60).

To copy (back up) data on a hard disk of your computer

Perform the procedure on pages 76 to 78 without a “Memory Stick Duo” inserted in the camera.



- You cannot copy image data on a “Memory Stick Duo” to the internal memory.
- By connecting the camera and a computer with a cable for multi-use terminal, you can copy data stored in the internal memory to a computer. However you cannot copy data on a computer to the internal memory.

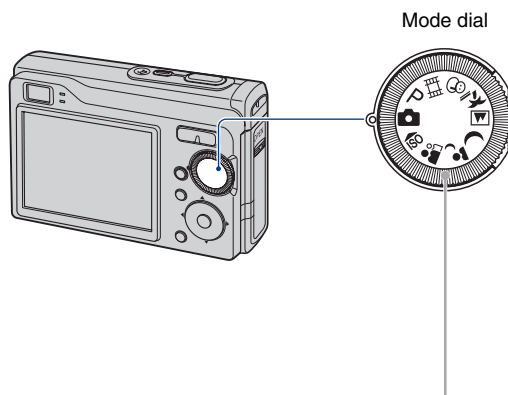

Using the mode dial

Set the mode dial to the desired function.



	Auto Adjustment mode Allows easy shooting with the settings adjusted automatically. → page 22
P :	Program Auto mode Allows you to shoot with the exposure adjusted automatically (both the shutter speed and the aperture value). Also you can select various setting using the menu. (For details on the functions available → page 36)
	Scene Selection mode Allows you to shoot with preset settings according to the scene. → page 26
	Movie recording mode Allows you to record movies with audio. → page 22

Shooting images easily (Auto Adjustment mode)

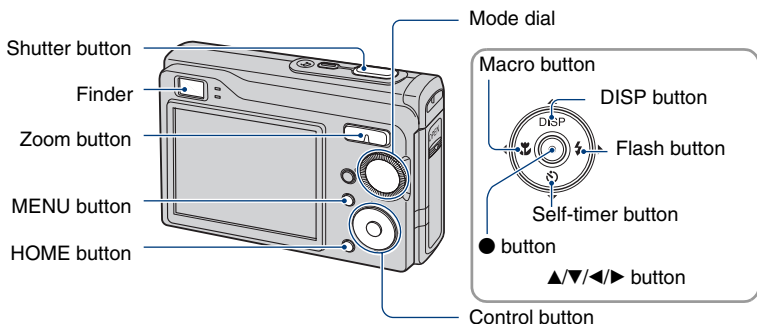

1 Select the desired function from the mode dial.

When shooting still images (Auto Adjustment mode): Select .

When shooting movies: Select .

2 Hold the camera steady, keeping your arm at your side.



Position the subject in the center of the focus frame.

3 Shoot with the shutter button.

When shooting still images:

① Press and hold the shutter button halfway down to focus.

The ● (AE/AF lock) indicator (green) flashes, a beep sounds, the indicator stops flashing and remains lit.

- ② Press the shutter button fully down.



AE/AF lock

When shooting movies:

Press the shutter button fully down.

To stop recording, press the shutter button fully down again.

If you shoot a still image of a subject that is difficult to focus on

- The shortest shooting distance is approx. 50 cm (19 3/4 inches). Shoot in the close-up (Macro) mode when you shoot a subject closer than the shooting distance (page 24).
- When the camera cannot focus on the subject automatically, the AE/AF lock indicator changes to flashing slowly and the beep does not sound. In addition, the AF range finder frame disappears. Recompose the shot and focus again.

Subjects difficult to focus on are:

- Distant from the camera and dark
- The contrast between the subject and its background is poor.
- Seen through glass
- Moving fast
- Reflective light or with a lustrous finish
- Flashing
- Backlit

W/T Using the zoom

Press T to zoom, press W to undo the zoom.

- When the zoom scale exceeds 3×, the camera uses the Digital Zoom function.
For details on the [Digital Zoom] settings and the image quality, see page 66.
- You cannot change the zoom scale while shooting a movie.

⚡ Flash (Selecting a flash mode for still images)

Press **▶** (⚡) on the control button repeatedly until the desired mode is selected.



(No indicator): Flash Auto

Strobes when there is insufficient light or backlight (default setting).

⚡: Flash forced on

⚡SL: Slow synchro (Flash forced on)

The shutter speed is slow in a dark place to clearly shoot the background that is out of flash light.

(⏸): Flash forced off

• The flash strobes twice. The first time is to adjust the light quantity.

• While charging the flash, **⚡** is displayed.

🌸 Macro (Shooting close-up)

Press **◀** (🌸) on the control button repeatedly until the desired mode is selected.



(No indicator): Macro Off

🌸: Macro On (W side: Approx. 4 cm or farther (1 5/8 inches or farther), T side: Approx. 35 cm or farther (13 7/8 inches or farther))

Macro

- Setting the zoom all the way to the W side is recommended.
- The in-focus range becomes narrow, and the complete subject may not entirely be in focus.
- The Auto Focus speed drops when you shoot images in the Macro.

⌚ Using the self-timer

Press **▼** (⌚) on the control button repeatedly until the desired mode is selected.



(No indicator): Not using the self-timer

⌚10: Setting the 10-second delay self-timer

⌚2: Setting the 2-second delay self-timer

Press the shutter button, the self-timer lamp flashes, and a beep sounds until the shutter operates.

Shooting images easily (Auto Adjustment mode)

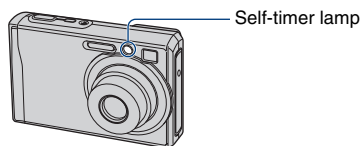

To cancel, press ▼ (⏏) again.

- Use the 2-second delay self-timer to prevent blur of an image made by the shaking of the camera when pressing the shutter button.

Shooting still images (Scene Selection)

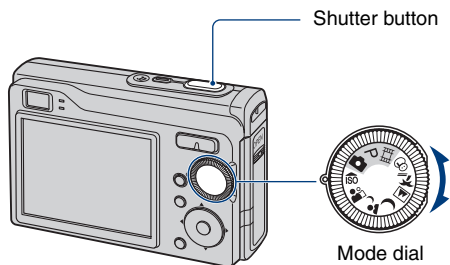

1 Select the desired mode of Scene Selection (ISO, , , , , , ) with the mode dial.

- For details on mode, see next page.

2 Shoot with the shutter button.

To cancel the Scene selection

Set the mode dial to other than the mode of Scene Selection.

Scene Selection modes

The following modes are predetermined to match the scene conditions.



High Sensitivity

Allows you to shoot images without a flash under low light conditions, reducing blur.



Soft Snap

Allows you to shoot images with a softer atmosphere for portraits of people, flowers, etc.



Twilight Portrait*

Suitable for shooting portraits in dark places. Allows you to shoot sharp images of people in dark places without losing the dark atmosphere of the surroundings.



Twilight*

Allows you to shoot night scenes at far distance without losing the dark atmosphere of the surroundings.



Landscape

Focuses only on a distant subject to shoot landscapes, etc.





Beach

When shooting seaside or lakeside scenes, the blue of the water is clearly recorded.



Snow

When shooting snowy scenes or other places where the whole screen appears white, use this mode to prevent sunken colors and record clear images.













*When you shoot images using  (Twilight Portrait) or  (Twilight) mode, the shutter speed is slower. To prevent a blurring, use of a tripod is recommended.

Shooting still images (Scene Selection)

Functions you can use in Scene Selection

For shooting an image appropriately according to the scene condition, a combination of functions is determined by the camera. Some functions are not available, depending on the Scene Selection mode.

(✓: you can select the desired setting)

	Macro	Flash	Face Detection	Burst/Bracket	EV	White Bal	Red Eye Reduction	SteadyShot
	✓		—	—	✓	✓*	—	✓
	✓	✓	✓	✓	✓	—	✓	✓
	✓		—	—	✓	—	✓	✓
	—		—	—	✓	—	—	✓
	—		—	✓	✓	—	✓	✓
	✓		—	✓	✓	—	✓	✓
	✓		—	✓	✓	—	✓	✓

* [Flash] cannot be selected.

Viewing images

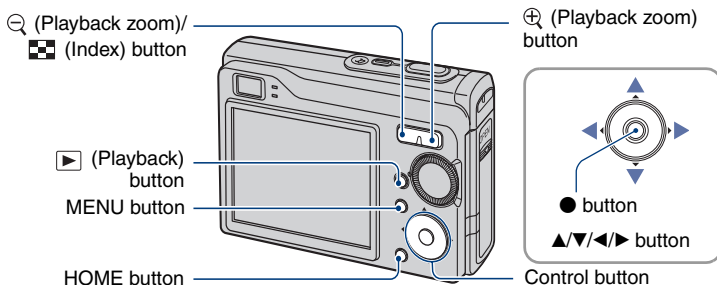

1 Press **▶** (Playback) button.

- If you press **▶** (Playback) when the camera is powered off, the camera is turned on automatically and set to playback mode. To switch to the shooting mode, press **▶** (Playback) again.

2 Select an image with **◀/▶** on the control button.

Movie:

Press **●** to playback a movie. (Press **●** again to stop playback.)

Press **▶** to fast forward, **◀** to rewind. (Press **●** to return to normal playback.)

Press **▼** to display the volume control screen, then press **◀/▶** to adjust the volume.

- Movies with the image size [320] are displayed a size smaller.

◀/⊕ To view an enlarged image (playback zoom)

Press **⊕** while displaying a still image.

To undo the zoom, press **◀**.





Adjust the position: **▲/▼/◀/▶**

Cancel playback zoom: **●**



- To store enlarged images: [Trimming] (page 52)

Viewing an index screen



Press  (Index) to display the index screen while a still image is displayed.

Select an image with ///.

To return to the single image screen, press .

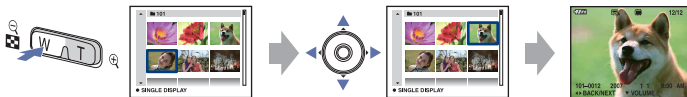
When using the “Memory Stick Duo”, if there are number of folders, select the folder selection bar with , then select the desired folder with /.



- You can also access the index screen by selecting  [Index Display] from  (View Images) on the HOME screen.
- Each time you press  (Index), the number of pictures on the index screen changes.

Deleting images

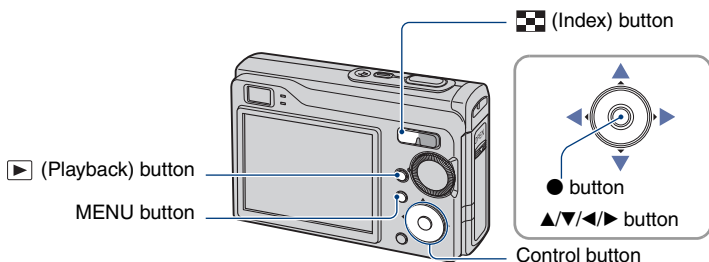

1 Press ▶ (Playback) button.

2 Press MENU while display in single-image mode or in index mode.

3 Select  [Delete] with ▲ on the control button.



4 Select the desired deletion method with ◀/▶ from among [This Image], [Multiple Images] and [All In This Folder], then press ●.

Deleting images

When you select [This Image]

Deletes the selected image.

Select [OK] with ▲, then press ●.

When you select [Multiple Images]

Selects and deletes multiple images at once.

- ① Select the images you want to delete, then press ●.
✓ mark is checked in the checkbox of the image.

Single Image



Index Display

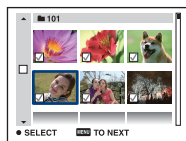

- ② Press MENU.
- ③ Select [OK] with ▲, then press ●.

When you select [All In This Folder]

Deletes all the images in the selected folder.

Select [OK] with ▲, then press ●.

- After you select [Multiple Images] on the index screen, you can delete all the images in a folder by selecting the folder selection bar with ◀ and attaching a ✓ mark on the folder.

Learning the various functions – HOME/Menu

Using the HOME screen

The HOME screen is the basic screen used for accessing the various functions you can access the HOME screen regardless of the shooting/viewing mode.

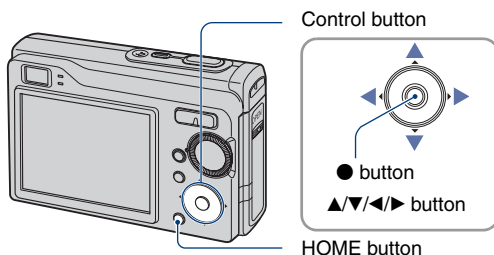

1 Press HOME to display the HOME screen.

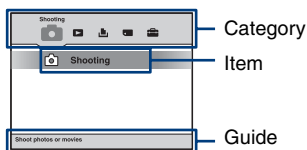





2 Select a category with ◀/▶ on the control button.

3 Select an item with ▲/▼, then press ●.

- You cannot display the HOME screen when a PictBridge connection or a USB connection is made.
- The camera is set to the shooting mode by pressing the shutter button halfway down.

HOME items

Pressing HOME button displays the following items. Details on the items are displayed on the screen by the guide.

Category	Items
 Shooting*	Shooting (page 21)
 View Images	Single Image (page 48)
	Index Display (page 48)
	Slide Show (page 48)
 Printing, Other	Print (page 93)
	Music Tool (page 89)
	Download Music Format Music
 Manage Memory	Memory Tool
	Memory Stick Tool (page 58)
	Format Create REC. Folder
	Change REC. Folder Copy
	Internal Memory Tool (page 61)
	Format
 Settings	Main settings
	Main Settings 1 (page 62)
	Beep Function Guide
	Initialize
	Main Settings 2 (page 63)
	USB Connect COMPONENT
	Video Out
	Shooting Settings
	Shooting Settings 1 (page 65)
	AF Illuminator Grid Line
	AF Mode Digital Zoom
	Shooting Settings 2 (page 67)
	Auto Orientation Auto Review
Clock Settings (page 68)	
Language Setting (page 69)	

*Shooting mode selected in the mode dial will be applied.

Using the menu items

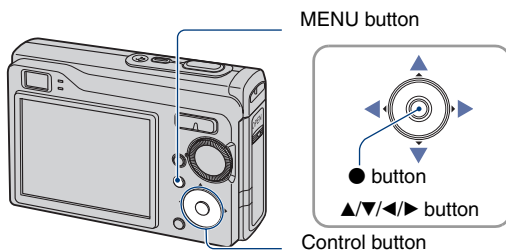

1 Press MENU to display the menu.

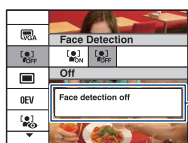

Function Guide

Setting [Function Guide] to [Off] turns off the function guide (page 62).

- The menu will be displayed only during shooting and playback mode.
- Different items will become visible depending on the selected mode.

2 Select the desired menu item with ▲/▼ on the control button.

- If the desired item is hidden, keep pressing ▲/▼ until the item appears on the screen.

3 Select a setting with ◀/▶.

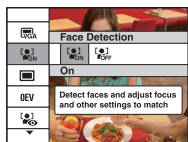

- If the desired setting is invisible, keep pressing ◀/▶ until the setting appears on the screen.
- Press ● after selecting an item in playback mode.

4 Press MENU to turn off the menu.

Menu items



The available menu items vary depending on the camera mode.

The shooting menu is available only in the shooting mode, and the viewing menu is available only in the playback mode.

Also, the menu items available vary depending on the mode dial position. Only the available items are displayed on the screen.

(✓: available)

Mode dial position:







	P	Scene	
---	---	-------	---

Menu for shooting (page 37)

Image Size	✓	✓	✓	✓
Face Detection	✓	—	✓*	—
REC Mode	✓	✓	✓*	—
Color Mode	—	✓	—	✓
ISO	—	✓	—	—
EV	✓	✓	✓	✓
Metering Mode	—	✓	—	✓
Focus	—	✓	—	✓
White Bal	—	✓	✓*	✓
Flash Level	—	✓	—	—
Red Eye Reduction	✓	✓	✓*	—
SteadyShot	—	✓	✓	✓
SETUP	✓	✓	✓	✓

*The operation is limited according to the selected Scene Selection mode (page 28).

Menu for viewing (page 51)

 (Delete)	 (Slide Show)
 (Retouch)	 (Protect)
DPOF	 (Print)
 (Rotate)	 (Select Folder)



The functions in shooting mode using MENU button are described below. For details on how to operate the menu, see page 35.

You cannot select the mode displayed in grey.



The default settings are marked with ✓.

Image Size: Selecting the image size



For still images

✓	(DSC-W90 only)	Selects image size for shooting still images. For details, see pages 10, 11.
✓	(DSC-W80/W85 only)	

For movie

	(Fine)	Selects image size for recording movies. For details, see page 11.
✓	(Standard)	

Face Detection: Detecting the face of subject



Selects whether to use the Face Detect function or not.

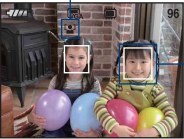





<input type="radio"/> ON (On)	<p>Detecting the faces of your subject will also adjust focus, strobe, exposure, white balance, and pre-strobe for red-eye reduction.</p>  <p>Face Detection mark</p> <p>Face Detection frame</p>
<input checked="" type="radio"/> OFF (Off)	<p>Does not use Face Detection function.</p>

- When [Face Detection] is set to [On], Digital zoom does not function.
- Available only for Soft Snap when you select the Scene Selection mode. In this case, the default setting will be [On].
- Up to 8 faces of your subjects can be detected. However, only up to 2 faces of your subjects can be detected when you shoot images with Soft Snap.
- When the camera detects more than subjects, the camera will judge which is the main subject and set focus by priority.
- The frame which the focus is set will turn green by pressing the shutter button half way down. Even when the frame does not turn green, if the distance of the subject which the focus is set on and other subjects are the same, the focus is set on all subjects.
- Face Detection may fail, depending on the conditions under which it is used.

REC Mode: Selecting the continuous shooting method



Selects whether the camera performs continuous shooting or not when you press the shutter button.

✓	 (Normal)	Does not shoot continuously.
	 (Burst)	<p>Records up to 100 images in succession when you press and hold down the shutter button.</p>  <ul style="list-style-type: none"> • The flash is set to  (Flash forced off).
	BRK ±0.3EV	<p>Records a series of three images with the exposure values automatically shifted (Exposure Bracket). The larger the bracket step value, the larger the shift of the exposure value.</p> <ul style="list-style-type: none"> • When you cannot decide the correct exposure, shoot in the Exposure Bracket mode, shifting the exposure value. You can select the image with the best exposure afterward.  <ul style="list-style-type: none"> • When the mode dial is set to , the Exposure Bracket mode is not available. • The flash is set to  (Flash forced off).
	BRK ±0.7EV	
	BRK ±1.0EV	

On the Burst











- When recording with the self timer, a series of a maximum of five images is recorded.
- The recording interval is approximately 0.46 seconds (DSC-W90) or 0.36 seconds (DSC-W80/W85). The recording interval becomes longer, depending on the setting for the image size.
- When the battery level is low, or when the internal memory or “Memory Stick Duo” is full, the Burst stops.
- You may not be able to shoot images in the Burst mode depending on the Scene Selection mode (page 28).

On the Exposure Bracket

- The focus and white balance are adjusted for the first image, and these settings are also used for the other images.
- When the exposure is manually adjusted (page 41), the exposure is shifted based on the adjusted brightness.
- The recording interval is approximately 0.5 seconds (DSC-W90) or 0.4 seconds (DSC-W80/W85).
- If the subject is too bright or too dark, you may be unable to shoot properly with the selected bracket step value.
- You may not be able to shoot images in the Exposure Bracket mode depending on the Scene Selection mode (page 28).

Color Mode: Changing the vividness of the image or adding special effects

You can change the brightness of the image, accompanied by effects.

✓	 (Normal)	
	 (Vivid)	Sets the image to bright and deep color. 
	 (Natural)	Sets the image to quiet color. 
	 (Sepia)	Sets the image to sepia color. 
	 (B & W)	Sets the image to monochromatic color. 

- You can select only [Normal], [Sepia] or [B & W] when shooting movies.

ISO: Selecting a luminous sensitivity



Low ISO sensitivity



High ISO sensitivity

Selects a luminous sensitivity with units of ISO. The larger the number, the higher the sensitivity.

<input checked="" type="checkbox"/>	ISO AUTO	Select a large number when shooting in dark locations or shooting a subject moving at high speed, or select a small number to obtain high image quality.
<input type="checkbox"/>	ISO 100	
<input type="checkbox"/>	ISO 200	
<input type="checkbox"/>	ISO 400	
<input type="checkbox"/>	ISO 800	
<input type="checkbox"/>	ISO 1600	
<input type="checkbox"/>	ISO 3200	

- For details on the ISO sensitivity, see page 8.
- Note that the image tends to become noisier as the ISO sensitivity number increases.
- [ISO] is set to [Auto] in the Scene Selection mode.
- You can select only from [ISO AUTO], [ISO 100] to [ISO 400] when set to Burst or Exposure Bracket.
- When shooting under brighter conditions, the camera automatically increases its tone reproduction and helps prevent images to become whitish (excluding when [ISO] is set to [ISO 100]).

EV: Adjusting the light intensity



Toward -



Toward +

Manually adjusts the exposure.





<input type="checkbox"/>	-2.0EV	Toward -: Darkens an image.
<input checked="" type="checkbox"/>	0EV	The exposure is determined automatically by the camera.
<input type="checkbox"/>	+2.0EV	Toward +: Brightens an image.

- For details on the Exposure, see page 8.
- The compensation value can be set in 1/3EV increments.
- If a subject is being shot in extremely bright or dark conditions, or the flash is used, the exposure adjustment may not be effective.

Metering Mode: Selecting the metering mode



Selects the metering mode that sets which part of the subject to measure to determine the exposure.



✓	 (Multi)	Divides into multiple regions and measures each region. The camera determines a well-balanced exposure (Multi-pattern metering).
	 (Center)	Measures the center of the image, and determines the exposure based on the brightness of the subject there (Center-weighted metering).
	 (Spot) (Only for still image)	Measures only a part of the subject (Spot metering). <ul style="list-style-type: none"> This function is useful when the subject is backlit or when there is strong contrast between the subject and the background.  <p>Spot metering cross hairs Positions on the subject</p>



- For details on the Exposure, see page 8.
- When using spot metering or center-weighted metering, setting [Focus] to [Center AF] is recommended to focus on the metering position (page 42).

Focus: Changing the focus method



You can change the focus method. Use the menu when it is difficult to get the proper focus in auto focus mode.

✓	 (Multi AF)	Focuses on a subject in all ranges of the finder frame automatically. <ul style="list-style-type: none"> This mode is useful when the subject is not in the center of the frame.  <p>AF range finder frame (Only for still image)</p> <p>AF range finder frame indicator</p>
---	--	--

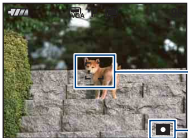
<p> (Center AF) (Only for still image)</p>	<p>Focuses on a subject in the center of the finder frame automatically.</p> <ul style="list-style-type: none"> Using together with the AF lock function lets you shoot in the desired image composition.  <p>AF range finder frame</p> <p>AF range finder frame indicator</p>
<p> (Spot AF) (Only for still image)</p>	<p>Focuses on an extremely small subject or a narrow area automatically.</p> <ul style="list-style-type: none"> Using together with the AF lock function lets you shoot in the desired image composition. Hold the camera steady not to misalign the subject and the AF range finder frame.  <p>AF range finder frame</p> <p>AF range finder frame indicator</p>
<p>0.5 m</p>	<p>Focuses on the subject using a previously set distance to the subject. (Focus preset)</p> <ul style="list-style-type: none"> When shooting a subject through a net or through window glass, it is difficult to get the proper focus in auto focus mode. In these cases, use of [Focus] is convenient.
<p>1.0 m</p>	
<p>3.0 m</p>	
<p>7.0 m</p>	
<p>∞ (unlimited distance)</p>	

- AF stands for Auto Focus.
- Distance setting information in “Focus Preset” is approximate. If you point the lens up or down, the error increases.
- When you use Digital Zoom or AF illuminator, the normal AF range finder frame is disabled and a new AF range finder frame is displayed by a dotted line. In this case, the priority of AF movement is given to subjects around the center of the frame.

 If the subject is out of focus

When shooting with the subject at the edge of the frame (or the screen), or when using [Center AF] or [Spot AF], the camera may not focus on a subject at the edge of the frame.



In such cases, do as follows.

- ① Recompose the shot so that the subject is centered in the AF range finder, and press the shutter button halfway down to focus on the subject (AF lock).

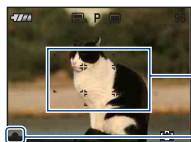

AF range finder frame

AE/AF lock indicator

As long as you do not press the shutter button fully down, you can retry the procedure as many times as you want.





- ② When the AE/AF lock indicator stops flashing and remains on, return to the fully composed shot, and press the shutter button fully down.



White Bal: Adjusting the color tones



Adjusts the color tones according to the lighting condition in a situation, for example, when the colors of an image look strange.

✓	WB AUTO (Auto)	Adjusts the White Balance automatically.
	☀ (Daylight)	Adjusts for conditions outside under a clear sky, at sundown, night scenes, the presence of neon signs or fireworks. 
	☁ (Cloudy)	Adjusts for a cloudy sky or a shady location. 
	𠄎 ₁ (Fluorescent Light 1)/ 𠄎 ₂ (Fluorescent Light 2)/ 𠄎 ₃ (Fluorescent Light 3)	Fluorescent Light 1: Adjust for white fluorescent lighting. Fluorescent Light 2: Adjust for natural white fluorescent lighting. Fluorescent Light 3: Adjust for day white fluorescent lighting. 
	💡 (Incandescent)	Adjusts for places under incandescent lamp, or under bright lighting, such as in a photo studio. 



 WB (Flash)	Adjusts for the flash conditions. • You cannot select this item when shooting movies. 
--	---

- For details on the white balance, see page 9.
- Under fluorescent lights that flicker, the white balance function may not work correctly even though you select [Fluorescent Light 1], [Fluorescent Light 2], [Fluorescent Light 3].
- Except in [Flash] modes, [White Bal] is set to [Auto] when the flash strobes.

Flash Level: Adjusting the amount of flash light



Adjusts the amount of flash light.



 - (-)	Toward -: Makes the flash level lower.
<input checked="" type="checkbox"/>  ±0 (Normal)	
 + (+)	Toward +: Makes the flash level higher.

- To change flash mode, see page 24.

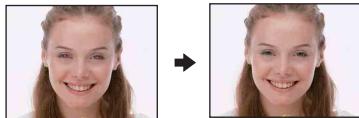
Red Eye Reduction: Reducing the red-eye phenomenon





The flash strobes two or more times before shooting to reduce the red-eye phenomenon when using the flash.

<input checked="" type="checkbox"/>  (Auto)	Reduces the red-eye phenomenon whenever necessary, only when using the Face Detection Function.
 ON (On)	The flash always strobes to reduce the red-eye phenomenon.
 OFF (Off)	Does not use Red Eye Reduction.

- Because it takes about a second until the shutter clicks, hold the camera firmly to prevent the effects of vibration. Also, do not let the subject move.
- Red-eye reduction may not produce the desired effects depending on individual differences, the distance to the subject, if the subject does not see the pre-strobe, or other conditions. In such a case, you can correct the red-eye phenomenon using [Retouch] in the viewing menu after shooting (page 52).
- When the Face Detection function is not used, the Red Eye Reduction will not function even when [Auto] is selected.

SteadyShot: Selecting the anti-blur mode

Selects the anti-blur mode.

<input checked="" type="checkbox"/>	 (Shooting)	Activates the anti-blur function when pressing the shutter button halfway down.
<input type="checkbox"/>	 (Continuous)	Always activates the anti-blur function. You can stabilize images even when zooming up a far subject. <ul style="list-style-type: none"> • Battery consumption is faster than in [Shooting] mode.
<input type="checkbox"/>	 (Off)	Does not use anti-blur mode.

- In Auto Adjustment mode, [SteadyShot] will be set to [Shooting].
- For movies, the options are limited to [Continuous] and [Off]. The default setting is set to [Continuous].
- The anti-blur function may not work properly in the following cases.
 - When camera shake is too strong
 - When the shutter speed is slow, for example, shooting night scenes

SETUP: Selecting the shooting settings

Select the settings for the shooting function. These items appearing in this menu are same ones as those in  Shooting Settings] on the HOME screen. See page 34.



Playing back images from the HOME screen

You can select the ways to playback images.

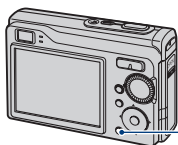

HOME button

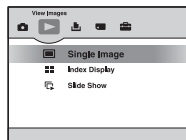

- 1 Press HOME.
- 2 Select (View Images) with / on the control button.
- 3 Select the desired viewing method with /.

(Single Image): Playing back a single image

Displays the image shot last. This is the same as pressing the (Playback) (page 29).

(Index Display): Playing back a list of images

Displays a list of images contained in the selected folder. This is the same as pressing the (Index) (page 30).

(Slide Show): Playing back a series of images

- 1 Select [Slide Show] on the HOME screen.

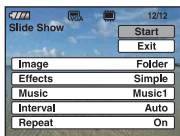

- 2 Select [Start] with /, then press to start playback.

To pause the slide show

Press on the control button.

To restart, select [Continue] with /, then press .

- The slide show resumes from the image which was paused, however, the music starts again from the beginning.

To display the previous/next image

Press ◀/▶ while the slide show is paused.

To adjust the volume of the music

Press ▼ to display the volume control screen, the press ◀/▶ to adjust the volume.

To end the slide show

Select [Exit] with ▲/▼ while the slide show is paused, then press ●.

To change the setup

The default settings are marked with ✓.

Image		
When you use a "Memory Stick Duo" (not supplied)		
✓	Folder	Plays back all the images in the selected folder.
	All	Plays back all the images in a "Memory Stick Duo" in order.

Effects		
✓	Simple	A simple slide show suitable for a wide range of scenes.
	Nostalgic	A moody slide show reproducing the atmosphere of a movie scene.
	Stylish	A stylish slide show proceeding at a middle tempo.
	Active	A high-tempo slide show suitable for active scenes.
	Normal	A basic slide show switching images at a predetermined interval.

- When set to [Simple], [Nostalgic], [Stylish] or [Active] only still images are displayed.
- Music is not played (set to [Off]) during a [Normal] slide show. The sound of movies will be heard.



Playing back images from the HOME screen

Music		
The preset-Music differs depending on the effect you select.		
<input checked="" type="checkbox"/>	Music 1	The default setting for a [Simple] slide show.
<input type="checkbox"/>	Music 2	The default setting for a [Nostalgic] slide show.
<input type="checkbox"/>	Music 3	The default setting for a [Stylish] slide show.
<input type="checkbox"/>	Music 4	The default setting for a [Active] slide show.
<input type="checkbox"/>	Off	Setting for a [Normal] slide show. No Music available.

Interval		
<input type="checkbox"/>	3 sec	Sets the display interval of images for a [Normal] slide show.
<input type="checkbox"/>	5 sec	
<input type="checkbox"/>	10 sec	
<input type="checkbox"/>	30 sec	
<input type="checkbox"/>	1 min	
<input checked="" type="checkbox"/>	Auto	The interval is set to suit the selected [Effects] item. The setting is fixed to [Auto] when [Normal] is not selected as the [Effects].

Repeat		
<input checked="" type="checkbox"/>	On	Plays back images in a continuous loop.
<input type="checkbox"/>	Off	After all the images have been played back, the slide show ends.

To add /change Music files



You can transfer a desired music file from your CDs or MP3 files to the camera to playback during Slide show. You can transfer music using [ Music Tool] in [ (Printing, Other)] on the HOME screen and the “Music Transfer” software (supplied) installed on a computer. For details, see pages 89 and 91.

- You can record up to four pieces of music on the camera (The four preset pieces (Music 1-4) can be replaced with the ones you transferred).
- A maximum length of each music file for music playback of the camera is 180 seconds.
- If you cannot playback a Music file due to damage or other malfunctions to the file, execute [Format Music] (page 89) and transfer the music again.

This section explains the menu items available when you press MENU button in playback mode. For details on how to use the menu, see page 35.

(Delete): Deleting images

Selects and deletes images on the single-image screen or the index screen. see page 31



 (This Image)	Deletes the image that is now selected.
 (Multiple Images)	Selects and deletes multiple images.
 (All In This Folder)	Deletes all the images in the selected folder.





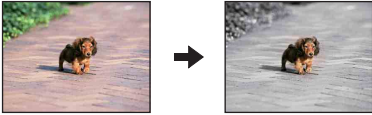

(Slide Show): Playing back a series of images

This item has same function as  Slide Show] on the HOME screen.
See page 48.

(Retouch): Retouching still images after shooting

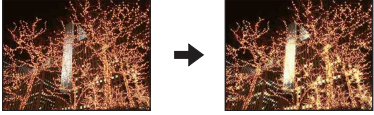
- The trimmed image is recorded as the newest file in the selected recording folder, and the original image is retained.

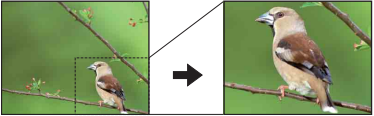
 (Soft Focus)	<p>Blurs the periphery around a chosen point to signalize a subject.</p>  <ol style="list-style-type: none"> ① Set the center point of the desired image to retouch with ▲/▼/◀/▶, then press MENU button. ② Select [Level] with ▲/▼ and press ●, adjust level of retouch with ▲/▼, then press ● again. ③ Adjust the desired range to retouch with W/T button. ④ Select [OK] with ▲/▼, then press ●.
 (Partial Color)	<p>Surrounds a chosen point in monochrome to signalize a subject.</p>  <ol style="list-style-type: none"> ① Set the center point of the desired image to retouch with ▲/▼/◀/▶, then press MENU button. ② Adjust the desired range to retouch with W/T button. ③ Select [OK] with ▲/▼, then press ●.



 (Fisheye Lens)	<p>Applies a fisheye effect around a chosen point.</p>  <ol style="list-style-type: none"> Set the center point of the desired image to retouch with ▲/▼/◀/▶, then press MENU button. Select [Level] with ▲/▼ and press ●, adjust level of retouch with ▲/▼, then press ● again. Select [OK] with ▲/▼, then press ●.
 (Cross Filter)	<p>Adds starburst effects to light sources.</p>  <ol style="list-style-type: none"> Select [Level] with ▲/▼ and press ●, adjust level of retouch with ▲/▼, then press ● again. Adjust the desired length to retouch with W/T button. Select [OK] with ▲/▼, then press ●.
 (Trimming)	<p>Records the zoomed playback image.</p>  <ol style="list-style-type: none"> Press W/T button to zoom in on the trimming range. Set the point with ▲/▼/◀/▶, then press MENU button. Selects [Image Size] with ▲/▼ and press ●. Selects Image Size to record with ▲/▼, then press ● again. Select [OK] with ▲/▼, then press ●.
 (Red Eye Correction)	<p>Corrects the red-eye phenomenon caused by flash.</p> <p>Select [OK] with ▲/▼, then press ●.</p> <ul style="list-style-type: none"> You may not be able to correct the red-eye phenomenon depending on the image.

When you select [Trimming]

- The image size that you can trim may vary depending on the image.
- The quality of trimmed images may deteriorate.

(Protect): Preventing accidental erasure

Protects images against accidental erasure.

 (This Image)	Protects/unlocks the currently selected image.
 (Multiple Images)	Selects and protects/unlocks multiple images.

To protect an image

- ① Select the images you want to protect while displaying images in single-image mode or in index mode.
- ② Press MENU.
- ③ Select [Protect] with ▲/▼, and select [This Image] with ◀/▶, then press ●.
The image is protected and the  (Protect) indicator appears on the image.

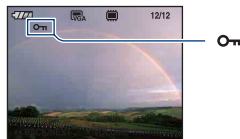

To select and protect images

- ① Press MENU in single-image mode or in index mode.
- ② Select [Protect] with ▲/▼, and select [Multiple Images] with ◀/▶, then press ●.

In single-image mode:

- ③ Select the image you want to protect with ◀/▶ on the control button, then press ●.
✓ is attached to the selected image.
- ④ Press ◀/▶ to display other images you want to protect, then press ●.
- ⑤ Press MENU.
- ⑥ Select [OK] with ▲, then press ●.

In index mode:

- ③ Select the image you want to protect with ▲/▼/◀/▶ on the control button, then press ●.
✓ is attached to the selected image.
- ④ To protect other images, repeat step ③.
- ⑤ To select all the images in a folder, select the folder selection bar with ◀, then press ●.
✓ is attached to the selected folder.
- ⑥ Press MENU.
- ⑦ Select [OK] with ▲, then press ●.
 (Protect) indicator appears on the selected images.

To cancel the protection

Select the image for which you want to cancel protection, and unlock it by performing the same procedure to protect it.



 (Protect) indicator disappears.

- Note that the formatting erases all the data stored on the recording media, even if the images are protected, and these images cannot be restored.
- It may take some time to protect an image.

DPOF: Adding a Print order mark

Adds DPOF (Print order) mark to images you want to print.

See page 96.

 (This Image)	Attaches/clears the DPOF-based print marks to (from) the image that is now selected.
 (Multiple Images)	Selects images and attaches/clears the DPOF-based print marks to (from) the images.

(Print): Printing images using a printer











See page 93.

This item has same function as [ Print] on the HOME screen.

(Rotate): Rotating a still image





Rotates a still image.

- ① Display the image to be rotated.
- ② Press MENU to display the menu.
- ③ Select [Rotate] with / on the control button, then press .
- ④ Select [ ], then rotate the image with /.
- ⑤ Select [OK] with /, then press .



- You cannot rotate protected images or movies.
- You may not be able to rotate images shot with other cameras.
- When viewing images on a computer, the image rotation information may not be reflected depending on the software.

(Select Folder): Selecting the folder for viewing images

Selects the folder containing the image you want to playback when using the camera with “Memory Stick Duo”.

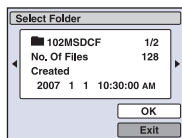
- ① Select the desired folder with   on the control button.



- ② Select [OK] with , then press .

To cancel selecting the folder selection

Select [Exit] in step ②, then press .

On the folder

The camera stores images in a specified folder of a “Memory Stick Duo”. You can change the folder or create a new one.

- To create a new folder → [Create REC. Folder] (page 58)
- To change the folder for recording images → [Change REC. Folder] (page 59)
- When multiple folders are created in the “Memory Stick Duo” and the first or last image in the folder is displayed, the following indicators appear.



Moves to the previous folder



Moves to the next folder



Moves to either the previous or next folders

Customizing the Manage Memory feature and the Settings

You can change the default settings using  (Manage Memory) or  (Settings) on the HOME screen.

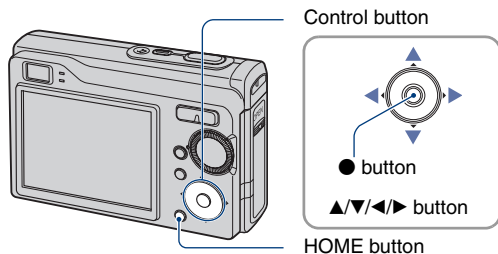

1 Press HOME to display the HOME screen.

2 Select  (Manage Memory) or  (Settings) with ▲/▼ on the control button.

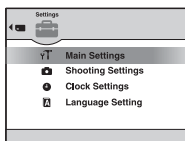

3 Select the desired item with ▲/▼, then press ●.

4 Press ▶ and select the desired setting with ▲/▼, then press ●.

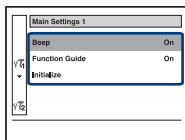

5 Select the desired setting with ▲/▼, then press ●.

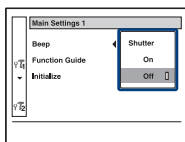

To cancel the setting change

Select [Cancel] if it is one of the setting item, then press ●.

If not, press ◀ on the control button.

- This setting is maintained even when the power is turned off.
- The camera is set to the shooting mode by pressing the shutter button halfway down.







Memory Tool — Memory Stick Tool

This item appears only when a “Memory Stick Duo” is inserted in the camera.

Format

Formats the “Memory Stick Duo”. A commercially available “Memory Stick Duo” is already formatted, and can be used immediately.

- Note that formatting irrevocably erases all data on a “Memory Stick Duo”, including even protected images.

- ① Select [Format] with /// on the control button, then press .
The message “All data on Memory Stick will be erased” appears.
- ② Select [OK] with  then press .
The format is completed.

To cancel the formatting



Select [Cancel] in step ②, then press .

Create REC. Folder

Creates a folder in a “Memory Stick Duo” for recording images.

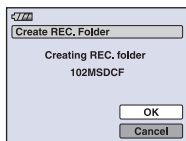
- ① Select [Create REC. Folder] with /// on the control button, then press .
The folder creation screen appears.



- ② Select [OK] with  then press .
A new folder is created with a number incremented one higher than the largest number, and the folder becomes the current recording folder.

To cancel the folder creation

Select [Cancel] in step ②, then press .

- When not creating a new folder, the “101MSDCF” folder is selected as the recording folder.
- You can create folders designated up to “999MSDCF”.
- Images are recorded in the newly created folder until a different folder is created or selected.
- You cannot delete a folder with the camera. To delete a folder, use your computer, etc.
- Up to 4,000 images can be stored in one folder. When the folder capacity is exceeded, a new folder is automatically created.
- For details, see “Image file storage destinations and file names” (page 81).

Change REC. Folder

Changes the folder currently used for recording images.

- ① Select [Change REC. Folder] with ▲/▼/◀/▶ on the control button, then press ●.
The folder selection screen appears.

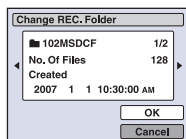

- ② Select the desired folder with ◀/▶, and [OK] with ▲, then press ●.

To cancel changing the recording folder

Select [Cancel] in step ②, then press ●.

- You cannot select the “100MSDCF” folder as a recording folder.
- You cannot move recorded images to a different folder.

Copy

Copies all images in the internal memory to a “Memory Stick Duo”.

- ① Insert a “Memory Stick Duo” having 64 MB or larger capacity.
- ② Select [Copy] with ▲/▼/◀/▶ on the control button, then press ●.
The message “All data in internal memory will be copied” appears.
- ③ Select [OK] with ▲, then press ●.
Copying starts.

To cancel the copying

Select [Cancel] in step ③, then press ●.

- Use a fully charged battery pack. If you attempt to copy image files using a battery pack with little remaining charge, the battery pack may run out, causing copying to fail or possibly corrupting the data.
- You cannot copy individual images.
- The original images in the internal memory are retained even after copying. To delete the contents of the internal memory, remove the “Memory Stick Duo” after copying, then execute the [Format] command in [Internal Memory Tool] (page 61).
- When you copy the data in the internal memory to the “Memory Stick Duo”, all the data will be copied. You cannot choose a specific folder on the “Memory Stick Duo” as the destination for the data to be copied.
- Even if you copy data, a **DPOF** (Print order) mark is not copied.

Memory Tool — Internal Memory Tool

This item does not appear when a “Memory Stick Duo” is inserted in the camera.

Format

Formats the internal memory.

- Note that formatting irrevocably erases all data in the internal memory, including even protected images.

- ① Select [Format] with ▲/▼/◀/▶ on the control button, then press ●.
The message “All data in internal memory will be erased” appears.
- ② Select [OK] with ▲, then press ●.
The format is completed.

To cancel the formatting

Select [Cancel] in step ②, then press ●.

Main settings — Main Settings 1

The default settings are marked with .

Beep

Selects the sound produced when you operate the camera.

	Shutter	Turns on the shutter sound when you press the shutter button.
	On	Turns on the beep/shutter sound when you press the control button/press the shutter button.
	Off	Turns off the beep/shutter sound.







Function Guide

When you operate the camera, the description of functions is displayed.

	On	Displays the function guide.
	Off	Does not display the function guide.

Initialize

Initializes the setting to the default setting. Even if you execute this function, the images stored in the internal memory are retained.

- ① Select [Initialize] with , then press .
The message “Initialize all settings” appears.
- ② Select [OK] with , then press .
The settings are reset to the default setting.

To cancel the resetting

Select [Cancel] in step ②, then press .

- Make sure that the power is not disconnected during resetting.

Main settings — Main Settings 2

The default settings are marked with .

USB Connect

Selects the USB mode to be used when connecting the camera to a computer or a PictBridge compliant printer using the cable for multi-use terminal.

	PictBridge	Connects the camera to a PictBridge compliant printer (page 93). When you connect the camera to a computer, the copy wizard starts automatically, and the images in the recording folder on the camera are copied to the computer. (with Windows XP, Mac OS X)
	Mass Storage	Establishes a Mass Storage connection between the camera and a computer or other USB device (page 77).
	Auto	<p>The camera recognizes automatically and sets up communication with a computer or PictBridge compliant printer (pages 77 and 93).</p> <ul style="list-style-type: none"> • If the camera and a PictBridge compliant printer cannot be connected when set to [Auto], change the setting to [PictBridge]. • If the camera and a computer or other USB device cannot be connected when set to [Auto], change the setting to [Mass Storage].

COMPONENT

Selects the video signal output type from SD and HD(1080i), according to the TV connected see page 70.

	HD(1080i)	Selects this item to connect the camera to a 1080i-capable High Definition TV.
	SD	Selects this item to connect the camera to a TV that is not compatible with an HD(1080i) signal.

Video Out

Sets the video signal output according to the TV color system of the connected video equipment. Different countries and regions use different TV color systems. If you want to view images on a TV screen, check page 72 for the TV color system of the country or region where the camera is used.

NTSC	Sets the video output signal to NTSC mode (e.g., for the USA, Japan).
PAL	Sets the video output signal to PAL mode (e.g., for Europe).



Shooting Settings — Shooting Settings 1

The default settings are marked with .

AF Illuminator



The AF illuminator supplies fill light to focus more easily on a subject in dark surroundings. The AF illuminator emits red light allowing the camera to focus easily when the shutter button is pressed halfway, until the focus is locked. The  indicator appears at this time.

	Auto	Uses the AF illuminator.
	Off	Does not use AF illuminator.

- If the AF illuminator light does not reach the subject sufficiently or the subject has no contrast, focus will not be achieved. (A distance of up to approximately 3.5 m (11 feet 5 7/8 inches) (zoom: W) / 2.5 m (8 feet 2 1/2 inches) (zoom: T) is recommended.) (DSC-W90)/(A distance of up to approximately 2.5 m (8 feet 2 1/2 inches) (zoom: W) / 2.0 m (6 feet 6 3/4 inches) (zoom: T) is recommended.) (DSC-W80/W85)
- Focus is achieved as long as the AF illuminator light reaches the subject, even if the light is slightly off the center of the subject.
- When Focus preset is set (page 42), AF Illuminator does not function.
- When you use AF illuminator, the normal AF range finder frame is disabled and new AF range finder frame is displayed by a dotted line. AF operates with priority on subjects located near the center of the frame.
- The AF illuminator does not operate when  (Twilight mode) or  (Landscape mode) is selected in the Scene mode.
- The AF illuminator emits very bright light. Although there are no problems with safety, do not look directly into the AF illuminator emitter at close range.
- When [Face Detection] is set to [On], AF Illuminator does not function.

Grid Line

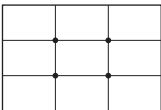
With reference to the grid lines, you can easily set a subject in a horizontal/vertical position.

	On	Displays the grid lines. 
	Off	Does not display the grid line.

- The grid lines are not recorded.

AF Mode

Selects the auto focus operation mode.

✓	Single	Automatically adjusts the focus when the shutter button is pressed and held halfway down. This mode is useful for shooting stationary subjects.
	Monitor	Automatically adjusts the focus before the shutter button is pressed and held halfway down. This mode shortens the time needed for focusing. <ul style="list-style-type: none"> Battery consumption is faster than in [Single] mode.

- When [Face Detection] is set to [On], the AF mode is disabled.

Digital Zoom

Selects the digital zoom mode. The camera enlarges the image using optical zoom (up to 3×). When the zoom scale exceeds 3×, the camera uses either smart or precision digital zoom.

✓	Smart (Smart zoom) (sQ)	Enlarges the image digitally within the range where the image will not be distorted, according to the image size. This is not available when the image size is set to [8M] (DSC-W90), [7M] (DSC-W80/W85) or [3:2]. <ul style="list-style-type: none"> The maximum zoom scale of Smart zoom is shown in the following table.
	Precision (Precision digital zoom) (PQ)	Enlarges all image sizes up to a maximum of 6×, but the image quality deteriorates.
	Off	Does not use the digital zoom.

Image size and maximum zoom scale using Smart zoom

Size	Maximum zoom scale	
	DSC-W90	DSC-W80/W85
5M	Approx. 3.8×	Approx. 3.6×
3M	Approx. 4.8×	Approx. 4.5×
VGA	Approx. 15×	Approx. 14×
16:9	Approx. 5.1×	Approx. 4.8×

- When [Face Detection] is set to [On], you cannot use the Digital Zoom.
- When you set the LCD screen to off, you cannot use the digital zoom.

Shooting Settings — Shooting Settings 2

The default settings are marked with .

Auto Orientation

When the camera is rotated to shoot a portrait image, the camera records its position change and displays the image in the portrait position.

	On	Records the image with the correct orientation.
	Off	Auto Orientation deactivated.

- Depending on the shooting angle of the camera, the orientation of the image may not be recorded correctly. If the orientation of the image is not recorded correctly, you can rotate the image as shown in page 54.

Auto Review

Displays the recorded image on the screen for approximately two seconds immediately after shooting a still image.

	On	Use the Auto Review.
	Off	Does not use Auto Review.

- If you press the shutter button halfway down during this period, the recorded image display disappears and you can immediately shoot the next image.







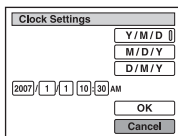

Clock Settings

Clock Settings

Sets the date and time.

- 1 Select [ Clock Settings] from  (Settings) on the HOME screen.



- 2 Select the date display format with /, then press .
- 3 Select each item with / and set the numeric value with /, then press .
- 4 Select [OK], then press .

To cancel the clock setting

Select [Cancel] in step ④, then press .

Language Setting

Language Setting

Selects the language to be used to display the menu items, warnings, and messages.



Viewing images on a TV

You can view images on a TV screen by connecting the camera to a TV.
The connection varies according to the type of TV the camera is connected to.

Viewing images by connecting your camera to a TV with the supplied cable for multi-use terminal

Turn off both your camera and the TV before connecting the camera and the TV.

1 Connect the camera to the TV.

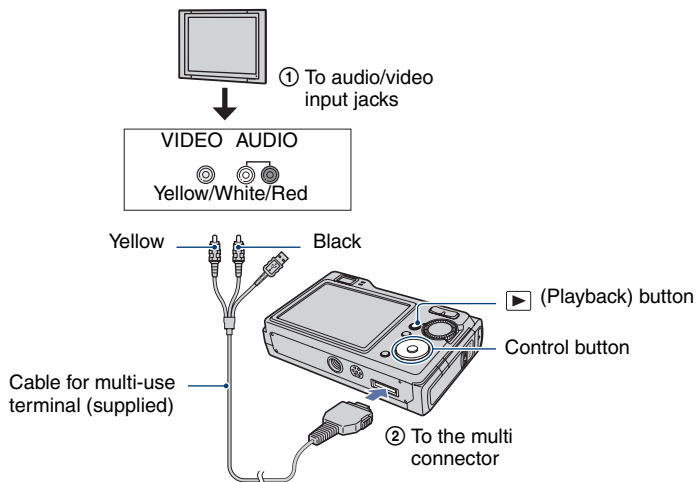

- Place the camera with the screen facing upwards.
- If your TV has stereo input jacks, connect the audio plug (black) of the cable for multi-use terminal to the left audio jack.

2 Turn on the TV and set the TV/video input switch to “video”.

- For details, see the operating instructions supplied with the TV.

3 Press (Playback) to turn on the camera.

Images shot with the camera appear on the TV screen.

Press   on the control button to select the desired image.

- When using your camera abroad, it may be necessary to switch the video signal output to match that of your TV system (page 64).

Viewing an image by connecting your camera to a HD TV

You can view an image recorded on the camera by connecting the camera to an HD (High Definition) TV with the component cable (not supplied).

Turn off both your camera and the TV before connecting the camera and the TV.

1 Connect the camera to the TV.

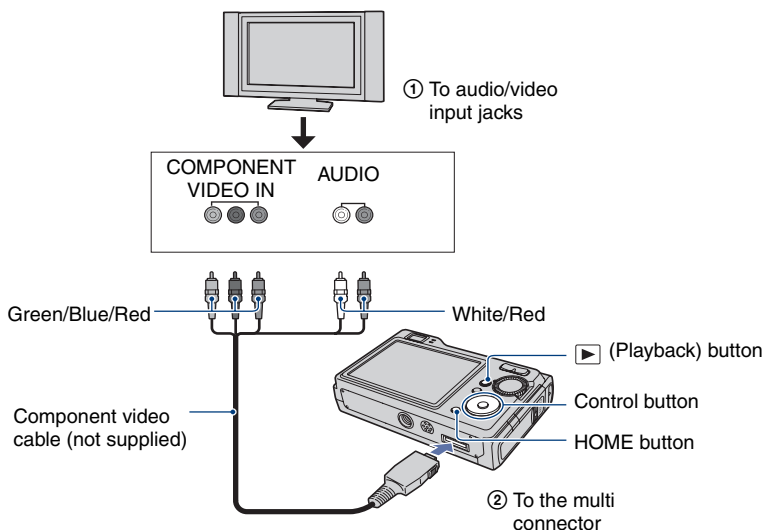

- Place the camera with the screen facing upwards.
- The input jacks (Green/Blue/Red) of the component video cable (not supplied) are the same colors as the respective terminals on the TV.

2 Turn on the TV and set the TV/video input switch to “video”.

- For details, see the operating instructions supplied with the TV.

3 Press (Playback) to turn on the camera.

Images shot with the camera appear on the TV screen.

Press  on the control button to select the desired image.

Viewing images on a TV

- Set [COMPONENT] to [HD(1080i)] in [Main Settings 2] by selecting  (Settings) on the HOME screen (page 63).
- When using your camera abroad, it may be necessary to switch the video signal output to match that of your TV system (page 64).
- You cannot view movies output in HD signal format.

On TV color systems

If you want to view images on a TV screen, you need a TV with a video input jack and the cable for multi-use terminal. The color system of the TV must match that of your digital still camera. Check the following lists for the TV color system of the country or region where the camera is used.

NTSC system

Bahama Islands, Bolivia, Canada, Central America, Chile, Colombia, Ecuador, Jamaica, Japan, Korea, Mexico, Peru, Surinam, Taiwan, the Philippines, the U.S.A., Venezuela, etc.

PAL system

Australia, Austria, Belgium, China, Czech Republic, Denmark, Finland, Germany, Holland, Hong Kong, Hungary, Italy, Kuwait, Malaysia, New Zealand, Norway, Poland, Portugal, Singapore, Slovak Republic, Spain, Sweden, Switzerland, Thailand, United Kingdom, etc.

PAL-M system

Brazil

PAL-N system

Argentina, Paraguay, Uruguay

SECAM system

Bulgaria, France, Guiana, Iran, Iraq, Monaco, Russia, Ukraine, etc.



For details on using a Macintosh computer, refer to “Using your Macintosh computer” (page 90).

This section describes the English version of screen contents.

- Under Windows Vista, some names and operations may differ from those described below.



Install the software (supplied) first (page 75)



Copying images to your computer (page 76)



- Viewing images on your computer

Enjoying images using the “Picture Motion Browser” and “Music Transfer” (pages 83 and 89)



- Viewing images saved on your computer
- Viewing photos organized by date
- Editing images
- Adding/changing Music using “Music Transfer”
- Displaying the shooting locations of still images on maps online (To do this, your computer needs to be connected to the Internet.)
- Creates a disc with the images shot (requires CD or DVD disc writing drive)
- Printing or saving still images with the date

Recommended computer environment

The following environment is recommended for a computer connected to the camera.

Recommended environment for copying images

OS (pre-installed): Microsoft Windows 2000 Professional, Windows XP* or Windows Vista*

- Operation is not assured in an environment based on an upgrade of the operating systems described above or in a multi-boot environment.

USB jack: Provided as standard

Recommended environment for using “Picture Motion Browser” and “Music Transfer”

OS (pre-installed): Microsoft Windows 2000 Professional, Windows XP* or Windows Vista*

Sound card: 16-bit stereo sound card with speakers

CPU/Memory: Pentium III 500 MHz or faster, 128 MB of RAM or more (Recommended: Pentium III 800 MHz or faster and 256 MB of RAM or more)

Software: DirectX 9.0c or later

Hard Disk: Disk space required for installation—200 MB or more

Display: Screen resolution: 1024 × 768 dots or more

Colors: High Color (16-bit color) or more

* 64-bit editions and Starter (Edition) are not supported.

- The software is compatible with DirectX technology. Installation of “DirectX” may be required.

Notes on connecting your camera to a computer

- Operations are not guaranteed for all the recommended computer environments mentioned above.
- If you connect two or more USB devices to a single computer at the same time, some devices, including your camera, may not operate, depending on the types of USB devices you are using.
- Operations are not guaranteed when using a USB hub.
- Connecting your camera using a USB interface that is compatible with Hi-Speed USB (USB 2.0 compliant) allows advanced transfer (high speed transfer) as this camera is compatible with Hi-Speed USB (USB 2.0 compliant).
- There are three modes for a USB connection when connecting a computer, [Auto] (default setting), [Mass Storage] and [PictBridge] modes. This section describes the [Auto] and [Mass Storage] as examples. For details on [PictBridge], see page 63.
- When your computer resumes from a suspend or sleep mode, communication between your camera and your computer may not recover at the same time.

Technical Support

Additional information on this product and answers to frequently asked questions can be found at the Sony Customer Support Website.
<http://www.sony.net/>

Installing the software (supplied)



You can install the software (supplied) using the following procedure.

- When using Windows 2000, do not connect the camera to the computer before installation.
- In Windows 2000/XP, log on as Administrator.
- When the software (supplied) is installed, the USB driver is installed automatically.

1 Turn on your computer, and insert the CD-ROM (supplied) into the CD-ROM drive.

The installation menu screen appears.



- If it does not appear, double-click  (My Computer) →  (SONYPICUTUTIL).
- Under Windows Vista, the AutoPlay screen may appear. Select “Run Install.exe” and follow the instructions that appear on the screen to proceed with the installation.

2 Click [Install].

The “Choose Setup Language” screen appears.

3 Select the desired language, then click [Next].

The [Location Settings] screen appears.

4 Select the [Region] and [Country/Area], then click [Next].

When the [Welcome to the InstallShield Wizard for SonyPicture Utility] appears, click [Next].

The “License Agreement” screen appears. Read the agreement carefully. If you accept the terms of the agreement, click the radio button next to [I accept the terms of the license agreement] and then click [Next].

5 Follow the instructions on the screen to complete the installation.

- When the restarting confirmation message appears, restart the computer following the instructions on the screen.
- DirectX may be installed depending on system environment of your computer.

6 Remove the CD-ROM after the installation is complete.

After you install the software, a shortcut icon for the customers registration website is created on the desktop.

Once you register on the website, you can get secure and useful customer support. <http://www.sony.net/registration/di>

Copying images to your computer

This section describes the process using a Windows computer as an example. You can copy images from the camera to your computer as follows.

For a computer with a Memory Stick slot

Remove the “Memory Stick Duo” from the camera and insert it in the Memory Stick Duo Adaptor. Insert the Memory Stick Duo Adaptor in the computer and copy the images.

- Even when you are using Windows 95/98/98 SecondEdition/NT/Me, you can copy images by inserting the “Memory Stick Duo” into the Memory Stick slot on your computer.
- If the “Memory Stick PRO Duo” is not recognized, see page 103.

For a computer without a Memory Stick slot

Follow Stages 1 through 4 on pages 76 to 80 to copy images.

- When you are using Windows 2000, install the software (supplied) before proceeding. With Windows XP, installation is unnecessary.
- The screen displays shown in this section are the examples for copying images from “Memory Stick Duo”.

With Windows 95/98/98 SecondEdition/NT/Me:

This camera is not compatible with these version of the Windows operating system. When you use a computer without a Memory Stick slot, use a commercially available Memory Stick Reader/Writer to copy images from a “Memory Stick Duo” to your computer.

To copy images in the internal memory to your computer, copy the images to a “Memory Stick Duo” first, then copy them to your computer.

Stage 1: Preparing the camera and the computer

1 Insert a “Memory Stick Duo” with recorded images into the camera.

- When copying images in the internal memory, this step is unnecessary.

2 Insert the sufficiently charged battery pack in the camera, or connect the camera to a wall outlet (wall socket) with the AC Adaptor (not supplied) and the USB, A/V, DC IN cable for multi-use terminal (not supplied).

- When you copy images to your computer using a battery pack with little remaining charge, copying may fail or image data may become corrupted if the battery pack shuts down too soon.

3 Press (Playback), then turn on the computer.

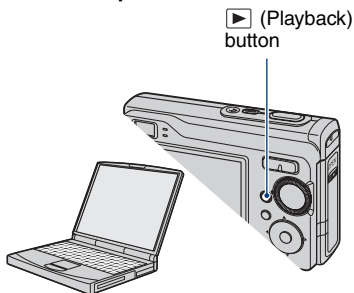

Stage 2: Connecting the camera and your computer

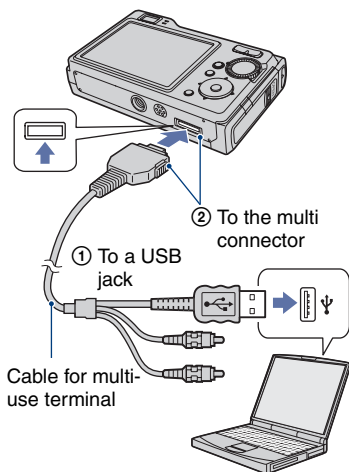

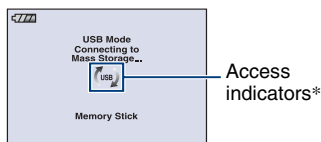

- With Windows XP/Vista, the AutoPlay wizard appears on the desktop.

“Connecting to Mass Storage...” appears on the screen of the camera.



When a USB connection is established for the first time, your computer automatically runs a program to recognize the camera. Wait for a while.

*  is displayed on the screen during the communication session. Do not operate the computer while the indicator is displayed. When the indicator changes to , you can start using the computer again.

- If “Connecting to Mass Storage...” does not appear, set [USB Connect] to [Mass Storage] (page 63).

- When the software (supplied) has been installed, the [Import Images] screen (page 84) may be displayed. In this case, you can import images directly using “Picture Motion Browser”.

Stage 3-A: Copying images to a computer

XP

- For Windows 2000, follow the procedure explained in “Stage 3-B: Copying images to a Computer” on page 78.
- For Windows XP/Vista, when the wizard screen does not appear automatically, follow the procedure explained in “Stage 3-B: Copying images to a Computer” on page 78.

This section describes an example of copying images to a “My Documents” folder.

- 1 After making a USB connection in Stage 2, click [Copy pictures to a folder on my computer using Microsoft Scanner and Camera Wizard] → [OK] as the wizard screen appears automatically on the desktop.

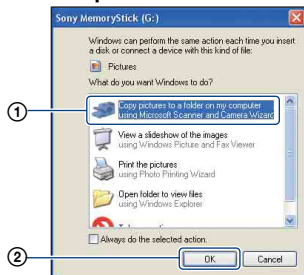

The “Scanner and Camera Wizard” screen appears.

- 2 Click [Next].

The images saved on the “Memory Stick Duo” of the camera appear.

- If no “Memory Stick Duo” is inserted, images in the internal memory appear.

3 Click the check box of unwanted images to remove the checkmark so they are not copied, then click [Next].

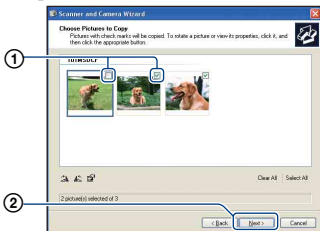

The “Picture Name and Destination” screen appears.

4 Select a name and destination for the images, then click [Next].

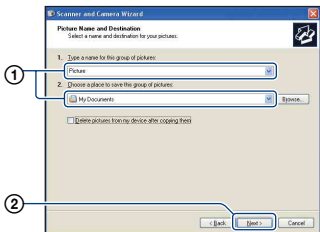

Image copying starts. When the copying is completed, the “Other Options” screen appears.

- This section describes an example of copying images to the “My Documents” folder.

5 Click the radio button next to [Nothing. I'm finished working with these pictures] to select it, then click [Next].



The “Completing the Scanner and Camera Wizard” screen appears.

6 Click [Finish].

The wizard screen closes.

- To continue copying other images, disconnect the cable for multi-use terminal (page 80). Then follow the procedure explained in “Stage 2: Connecting the camera and your computer” on page 77.

Stage 3-B: Copying images to a Computer

2000

- For Windows XP, follow the procedure explained in “Stage 3-A: Copying images to a computer” on page 77.

This section describes an example of copying images to the “My Documents” folder.

1 Double-click [My Computer] → [Removable Disk] → [DCIM].

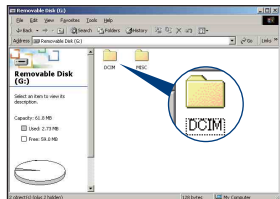

- If the “Removable Disk” icon is not displayed, see page 104.

2 Double-click the folder where the image files you want to copy are stored.

Then, right-click an image file to display the menu and click [Copy].

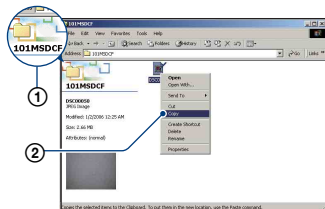

- On the storage destination of the image files, see (page 81).

3 Double-click the [My Documents] folder. Then, right-click on the “My Documents” window to display the menu and click [Paste].

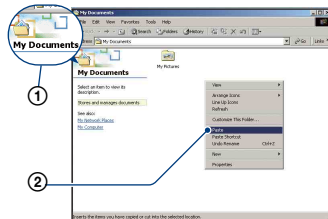

The image files are copied to the “My Documents” folder.

- When an image with the same file name exists in the copy destination folder, the overwrite confirmation message appears. When you overwrite an existing image with a new one, the original file data is deleted. To copy an image file to the computer without overwriting, change the file name to a different name and then copy the image file. However, note that if you change the file name (page 82), you may not be able to playback that image with your camera.

Stage 4: Viewing images on your computer

This section describes the procedure for viewing copied images in the “My Documents” folder.

1 Click [Start] → [My Documents].



The contents of the “My Documents” folder are displayed.

- If you are not using Windows XP, double-click [My Documents] on the desktop.

2 Double-click the desired image file.

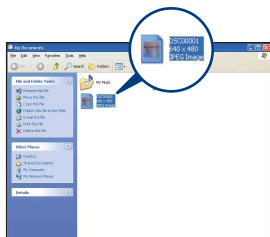

The image is displayed.

To delete the USB connection

Perform the procedures listed below beforehand when:

- Disconnecting the cable for multi-use terminal
- Removing a “Memory Stick Duo”
- Inserting a “Memory Stick Duo” into the camera after copying images from the internal memory
- Turning off the camera

① Double-click on the taskbar.



Double-click here

② Click (USB Mass Storage Device) → [Stop].

③ Confirm the device on the confirmation window, then click [OK].

④ Click [OK].

The device is disconnected.

- Step ④ is unnecessary for Windows XP.

Image file storage destinations and file names

The image files recorded with your camera are grouped as folders on the “Memory Stick Duo”.

Example: viewing folders on Windows XP

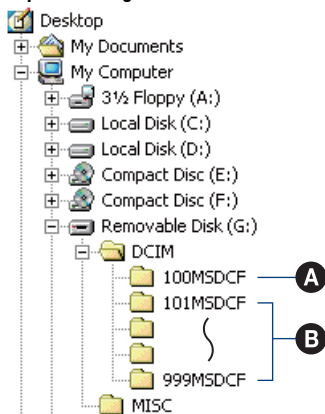

- A** Folder containing image data recorded using a camera not equipped with the folder creating function
 - B** Folder containing image data recorded using this camera
When no new folders are created, there are folders as follows:
 - “Memory Stick Duo”; “101MSDCF” only
 - Internal memory; “101_SONY” only
- You cannot record any images to the “100MSDCF” folder. The images in these folders are available only for viewing.
 - You cannot record/playback any images to the “MISC” folder.

- Image files are named as follows. □□□□ stands for any number within the range from 0001 to 9999. The numerical portions of the name of a movie file recorded in movie mode and its corresponding index image file are the same.
 - Still image files: DSC0□□□□.JPG
 - Movie files: MOV0□□□□.MPG
 - Index image files that are recorded when you record movies: MOV0□□□□.THM
- For more information about folders, see pages 55 and 58.

Viewing image files stored on a computer with your camera (using a “Memory Stick Duo”)

This section describes the process using a Windows computer as an example. When an image file copied to a computer no longer remains on a “Memory Stick Duo”, you can view that image again on the camera by copying the image file on the computer to a “Memory Stick Duo”.

- Step 1 is not necessary if the file name set with your camera has not been changed.
- You may be unable to playback some images depending on the image size.
- When an image file has been processed by a computer or when the image file was recorded using a model other than that of your camera, playback on your camera is not guaranteed.
- When there is no folder, create a folder with your camera (page 58) first, and then copy the image file.

1 Right-click the image file, then click [Rename]. Change the file name to “DSC0□□□□”.

Enter a number from 0001 to 9999 for □□□□.

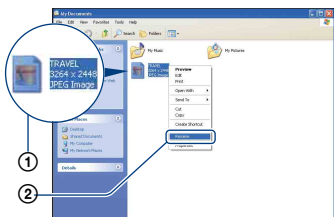

- If the overwrite confirmation message appears, enter a different number.
- An extension may be displayed depending on the computer settings. The extension for still images is JPG, and the extension for movies is MPG. Do not change the extension.

2 Copy the image file to the “Memory Stick Duo” folder in the following order.

- ① Right-click the image file, then click [Copy].
- ② Double-click [Removable Disk] or [Sony MemoryStick] in [My Computer].
- ③ Right-click the [□□□MSDCF] folder in the [DCIM] folder, then click [Paste].
 - □□□ stands for any number within the range from 100 to 999.

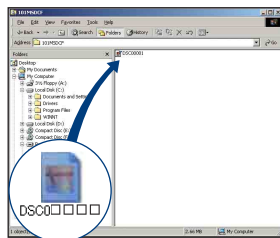

Using the “Picture Motion Browser” (supplied)

You can use still images and movies from the camera more than ever by taking advantage of the software.

This section summarizes the “Picture Motion Browser” and gives the basic instructions.

“Picture Motion Browser” overview

With the “Picture Motion Browser” you can:

- Import images shot with the camera and display them on the computer.
- Organize images on the computer on a calendar by shooting date to view them.
- Retouch (Red Eye Correction, etc.), print, and send still images as e-mail attachments, change the shooting date and more.
- Still images can be printed or saved with the date.
- You can create a data disc using a CD burner drive or DVD burner drive.
- For details on the “Picture Motion Browser”, refer to the Help.

To access the Help, click [Start] → [All Programs] (in Windows 2000, [Programs]) → [Sony Picture Utility] → [Help] → [Picture Motion Browser].

Starting and exiting the “Picture Motion Browser”

Starting the “Picture Motion Browser”

Double-click the  (Picture Motion Browser) icon on the desktop.

Or, from the Start menu: Click [Start] → [All Programs] (in Windows 2000, [Programs]) → [Sony Picture Utility] → [Picture Motion Browser].

- The confirmation message of the Information tool appears on the screen when starting the “Picture Motion Browser” for the first time. Select [Start]. This function informs you of news, such as software updates. You can change the setting later.

Exiting the “Picture Motion Browser”

Click  button in the top right corner of the screen.

Basic instructions

Follow these steps to import and view images from the camera.

Importing images

1 Make sure “Media Check Tool”* is running.

Look for a  (Media Check Tool) icon in the taskbar.

* “Media Check Tool” is a program that automatically detects and imports images when a “Memory Stick” is inserted or when the camera is connected.

- If there is no  icon: Click [Start] → [All Programs] (in Windows 2000, [Programs]) → [Sony Picture Utility] → [Tools] → [Media Check Tool].

2 Connect the camera to your computer with the cable for multi-use terminal.

After the camera is automatically detected, the [Import Images] screen is displayed.



- If you use the Memory Stick slot, refer to page 76.
- In Windows XP, if the AutoPlay Wizard appears, close it.

3 Import the images.

To start importing images, click the [Import] button.

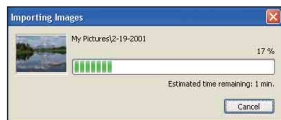

By default, images are imported into a folder created in “My Pictures” that is named with the date of importing.

- For instructions on changing the “Folder to be imported”, refer to page 87.

Viewing images

1 Checking imported images

When importing is complete, the “Picture Motion Browser” starts. Thumbnails of the imported images are displayed.

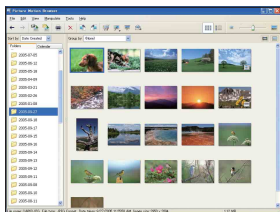

- The “My Pictures” folder is set as the default folder in “Viewed folders”.
- You can double-click a thumbnail to display the image by itself.

2 Viewing images in “Viewed folders” arranged by shooting date on a calendar

- ① Click the [Calendar] tab.
Years when images were shot are listed.
- ② Click the year.
Images shot that year are displayed, arranged on the calendar by shooting date.
- ③ To display images by month, click the desired month.
Thumbnails of images shot that month are displayed.
- ④ To display images by time, click the desired date.
Thumbnails of images shot that day are displayed, arranged by hour.

Year display screen

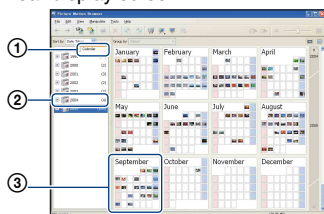

Month display screen

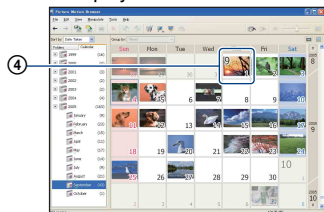

Hour display screen

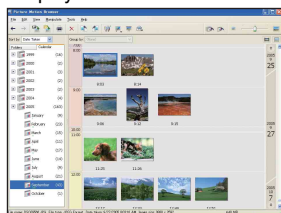

- To list images from a particular year or month, click that period on the left of the screen.

3 Displaying individual images

On the hour display screen, double-click a thumbnail to display the image by itself in a separate window.

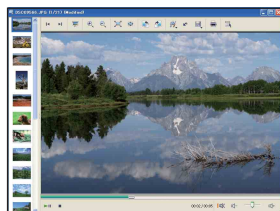



- You can edit displayed images by clicking the  button in the toolbar.

Displaying images in full-screen mode

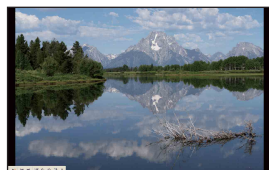
To display a slide show of current images in full-screen mode, click the  button.



- To play or pause the slide show, click the  button on the lower left of the screen.
- To stop the slide show, click the  button on the lower left of the screen.

Creating a data disc

Images can be saved in CD or DVD as a data disc.

- CD burner drive or DVD burner drive required.
- The following disc can be used for creating a data disc.
 - CD–R/RW (12 cm)
 - DVD±R/RW (12 cm)
 - DVD+R DL (12 cm)
 - DVD–R DL (12 cm)

1 Select images to save on the disc.

- To select consecutive images, click the first image, then press and hold down “Shift” key while you click the last image.
- To select two or more non-consecutive images, press and hold down “Ctrl” key while clicking images.

2 Click the button on the tool bar.

The [Create Data Disc] display appears.

3 Click [Start].

4 Follow the display instructions to proceed with creating the data disc.

- To add desired images, drag and drop on the [Create Data Disc] display.

Selecting all images in a folder

Click the [folders] tab, then right-click on the desired folder icon and select [Create Data Disc]. All images in a folder can be selected.

Using Map View to display still images on a map

If your still images have position information, you can see the images on maps online with Map View.

- To use the Map View function, your computer needs to be connected to the Internet.

1 Select a thumbnail marked with .

2 Click .

The Map View main window appears.



- Maps and satellite images powered by Google Maps mapping service.

-
- You can later add position information on the still images, using the Map View. For details, see the Help of Map View.

Other functions

Preparing images stored on the computer for viewing

To view them, register the folder that contains the images as one of the “Viewed folders”.

- 1 Click  on the main screen, or choose [Register Folders to View] from the [File] menu.

The settings screen for “Viewed folders” registration is displayed.

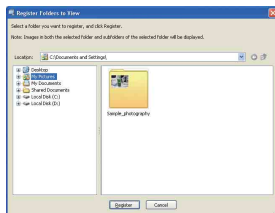

- 2 Specify the folder with images for importing to register the folder as one of the “Viewed folders”.

- 3 Click [OK].

The image information is registered in the database.

- Images in any subfolders of “Viewed folders” are also registered.

Changing the “Folder to be imported”

To change the “Folder to be imported”, access the “Import Settings” screen.

- 1 Choose [Import Settings] → [Location for Imported Images] from the [File] menu.

The “Location for Imported Images” screen is displayed.

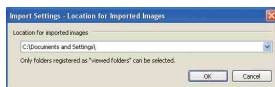

- 2 Choose the “Folder to be imported”.



- You can specify the “Folder to be imported” from folders registered as “Viewed folders.”

Updating image registration information

To update image information, choose [Update Database] from the [Tools] menu.

- Updating the database may take a while.
- If you rename image files or folders in “Viewed folders”, they cannot be displayed with this software. In this case, update the database.

Saving images with the date

- ① Double-click an image to display it.
- ② Click  and select [Insert Date] from the drop-down list.
- ③ Select your desired color and position, and then click [OK].
- ④ Click  to save.

Printing images with the date

- ① Select the still image you want to print.
- ② Click  on the toolbar.
- ③ Click the check box of [Print date taken] in Print Options.
- ④ Click [Print].

To uninstall the “Picture Motion Browser”

- ① Click [Start] → [Control Panel] (in Windows 2000, [Start] → [Settings] → [Control Panel]), then double-click [Add/Remove Programs].
- ② Select [Sony Picture Utility], then click [Remove] (in Windows 2000, [Change/Remove]) to execute the uninstallation.

Using the “Music Transfer” (supplied)



You can change the Music files that are preset at the factory with desired Music files using “Music Transfer” in the CD-ROM (supplied). Also, you can delete or add these files whenever you want.

Adding/Changing Music using “Music Transfer”

The music formats you can transfer with “Music Transfer” are listed below:

- MP3 files stored on the hard drive of your computer
- Music on CDs
- Preset-music saved on this camera

1 Press HOME to display the HOME screen.

2 Select  (Printing, Other) with /▶ on the control button, select [ Music Tool] with ▲/▼, then press ●.

3 Select [Download Music] with ▲/▼/◀/▶, then press ●.

The message “Connect to PC” appears.

4 Make a USB connection between the camera and your computer.

5 Start “Music Transfer”.

6 Follow the instructions on the screen to add/change Music files.

- To restore the music preset at the factory to the camera:

① Perform [Format Music] in step 3.

② Execute [Restore defaults] on “Music Transfer.”

All Music files return to the preset-music, and [Music] in the [Slide Show] menu is set to [Off].

③ Select a suitable Music file for the slide show effect (page 49).

You can reset the Music files to the preset ones using [Initialize] (page 62), however, other settings will also be reset.

- For details on using “Music Transfer”, see the on-line help in “Music Transfer”.

Using your Macintosh computer

You can copy images to your Macintosh computer.

- “Picture Motion Browser” is not compatible with Macintosh computers.

Recommended computer environment

The following environment is recommended for a computer connected to the camera.

Recommended environment for copying images

OS (pre-installed): Mac OS 9.1/9.2/ Mac OS X (v10.1 to v10.4)

USB jack: Provided as standard

Recommended environment for using “Music Transfer”

OS (pre-installed): Mac OS X (v10.3 to v10.4)

CPU: iMac, eMac, iBook, PowerBook, Power Mac G3/G4/G5 series, Mac mini

Memory: 64 MB or more (128 MB or more is recommended)

Hard Disk: Disk space required for installation—approximately 250 MB

Notes on connecting your camera to a computer

- Operations are not guaranteed for all the recommended computer environments mentioned above.
- If you connect two or more USB devices to a single computer at the same time, some devices, including your camera, may not operate depending on the types of USB devices you are using.
- Operations are not guaranteed when using a USB hub.
- Connecting your camera using a USB interface that is compatible with Hi-Speed USB (USB 2.0 compliant) allows advanced transfer (high speed transfer) as this camera is compatible with Hi-Speed USB (USB 2.0 compliant).

- There are three modes for a USB connection when connecting a computer, [Auto] (default setting), [Mass Storage] and [PictBridge] modes. This section describes the [Auto] and [Mass Storage] as examples. For details on [PictBridge], see page 63.
- When your computer resumes from the suspend or sleep mode, communication between your camera and your computer may not recover at the same time.

Copying and viewing images on a computer

1 Prepare the camera and a Macintosh computer.

Perform the same procedure as described in “Stage 1: Preparing the camera and the computer” on page 76.

2 Connect the cable for multi-use terminal.

Perform the same procedure as described in “Stage 2: Connecting the camera and your computer” on page 77.

3 Copy image files to the Macintosh computer.

- ① Double-click the newly recognized icon → [DCIM] → the folder where the images you want to copy are stored.
 - ② Drag and drop the image files to the hard disk icon.
The image files are copied to the hard disk.
- For details on the storage location of the images and file names, see page 81.

4 View images on the computer.

Double-click the hard disk icon → the desired image file in the folder containing the copied files to open that image file.

To delete the USB connection

Perform the procedures listed below beforehand when:

- Disconnecting the cable for multi-use terminal
- Removing a “Memory Stick Duo”
- Inserting a “Memory Stick Duo” into the camera after copying images from the internal memory
- Turning off the camera

Drag and drop the drive icon or the icon of the “Memory Stick Duo” to the “Trash” icon.

The camera is disconnected from the computer.

Adding/Changing Music using “Music Transfer”

You can change the Music files that are preset at the factory with desired Music files. Also, you can delete or add these files whenever you want.

The music formats you can transfer with “Music Transfer” are listed below:

- MP3 files stored on the hard drive of your computer
- Music on CDs
- Preset-music saved on this camera

To install “Music Transfer”

- Shut down all other application software before you install “Music Transfer”.
- For installation, you need to log on as Administrator.

- ① Turn on your Macintosh computer, and insert the CD-ROM (supplied) into the CD-ROM drive.
- ② Double-click  (SONYPICTUTIL).
- ③ Double-click the [MusicTransfer.pkg] file in [MAC] folder.
The installation of the software starts.

To add/change Music files

See “Adding/Changing Music using “Music Transfer”” on page 89.

Technical Support

Additional information on this product and answers to frequently asked questions can be found at the Sony Customer Support Website.
<http://www.sony.net/>

How to print still images

When you print images shot in [16:9] mode, both edges may be cut off, so be sure to check before printing (page 106).

Printing directly using a PictBridge compliant printer (page 93)



You can print images by connecting the camera directly to a PictBridge compliant printer.

Printing directly using a “Memory Stick” compliant printer

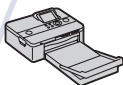

You can print images with a “Memory Stick” compliant printer. For details, see the operating instructions supplied with the printer.

Printing using a computer



You can copy images to a computer using the supplied “Picture Motion Browser” software and print the images. You can insert the date on the image and print it (page 87).

Printing at a shop (page 96)

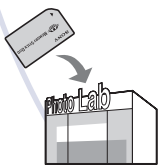

You can take a “Memory Stick Duo” containing images shot with your camera to a photo printing service shop. You can make a **DPOF** (Print order) mark on images which you want to print out in advance.

Printing images directly using a PictBridge compliant printer

Even if you do not have a computer, you can print images shot using your camera by connecting the camera directly to a PictBridge compliant printer.



- “PictBridge” is based on the CIPA standard. (CIPA: Camera & Imaging Products Association)
- You cannot print movies.
- If the  indicator flashes on the screen of the camera (error notification), check the connected printer.



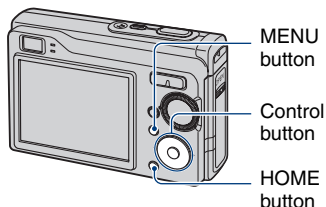

Stage 1: Preparing the camera



Prepare the camera to connect it to the printer with the cable for multi-use terminal. When connecting the camera to a printer that is recognized when [USB Connect] is set to [Auto], Stage 1 is unnecessary.





- It is recommended to use a fully charged battery pack to prevent the power from turning off partway through printing.

1 Press HOME to display the HOME screen.

2 Select  (Settings) with , and select [ Main settings] with , then press .

3 Select [Main Settings 2] with , and select [USB Connect], then press .

4 Select [PictBridge] with , then press .

The USB mode is set.

Stage 2: Connecting the camera to the printer

1 Connect the camera to the printer.

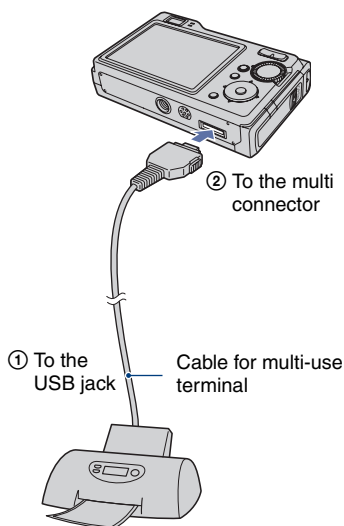

2 Press (Playback) and turn on your camera and the printer.

After the connection is made, the  indicator appears.

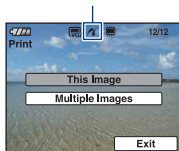

The camera is set to playback mode, then an image and the print menu appear on the screen.

Stage 3: Selecting images you want to print





Select [This Image] or [Multiple Images] with , , then press .

When you select [This Image]

You can print the selected image. Move on to Stage 4.

When you select [Multiple Images]

You can print multiple selected images.

- ① Select the image you want to print with , , then press .
✓ mark appears on the selected image.
- ② Press MENU to display the menu.
- ③ Select [OK] with the control button, then press .

- After you select [Multiple Images] on the index screen, you can print all the images in a folder by selecting the folder selection bar with  and attaching a ✓ mark on the folder.

Stage 4: Printing

1 Select print settings with the control button.

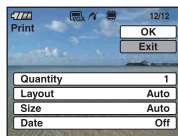

[Quantity]

When the [Layout] is set to [1-up/Borderless] or [1-up/Border]:

Select the number of sheets of an image that you want to print. The image will be printed as a single image.

When the [Layout] is not set to [1-up/Borderless] or [1-up/Border]:

Select the number of sets of images that you want to print as an index image. If you selected [This Image] in step 1, select the number of the same image you want to print side by side on a sheet as an index image.

- The designated number of images may not all fit onto a single sheet depending on the quantity of images.

[Layout]

Selects the number of image you want to print side by side on a sheet.

[Size]

Select the size of the printing sheet.

[Date]

Select [Day & Time] or [Date] to insert the date and time on images.

- When you choose [Date], the date will be inserted in the order you select (page 68). This function may not be provided depending on the printer.

Stage 5: Completing the printing

Make sure the screen has returned to Stage 2, and disconnect the cable for multi-use terminal from the camera.

2 Select [OK] with ▲, then press ●.

The image is printed.

- Do not disconnect the cable for multi-use terminal while the  (PictBridge Connecting) indicator appears on the screen.

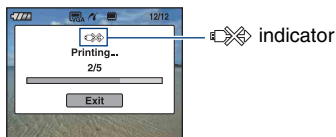

To print other images

Select [Multiple Images], then perform the process again stage 3, 4.

Printing at a shop

You can take a “Memory Stick Duo” containing images shot with your camera to a photo printing service shop. As long as the shop supports photo printing services conforming to the DPOF, you can make a **DPOF** (Print order) mark on images in advance so that you do not need to reselect them when you print them out at the shop.

- You cannot print images stored in the internal memory at a print shop directly from the camera. Copy the images to a “Memory Stick Duo”, then take the “Memory Stick Duo” to the print shop.

What is DPOF?

DPOF (Digital Print Order Format) is a function allowing you to make a **DPOF** (Print order) mark on images of “Memory Stick Duo” that you want to print out later.

- You can also print the images with the **DPOF** (Print order) mark using a printer that conforms to the DPOF (Digital Print Order Format) standard or using a PictBridge compliant printer.
- You cannot mark movies.

When taking a “Memory Stick Duo” to a shop

- Consult your photo printing service shop as to what types of “Memory Stick Duo” they handle.
- If a “Memory Stick Duo” is not handled by your photo printing service shop, copy the images you want to print out to other medium such as a CD-R and take it to the shop.
- Be sure to take the Memory Stick Duo Adaptor with it.
- Before you take image data to a shop, always copy (back up) your data to a disk.
- You cannot set the number of prints.
- When you want to superimpose dates on images, consult your photo printing service shop.

Marking a selected image

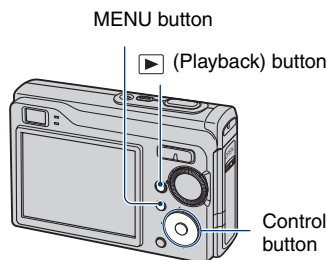

1 Press **(Playback)**.

2 Select the image you want to print.

3 Press **MENU** to display the menu.

4 Select **[DPOF]** with **▲/▼** on the control button and select **[This Image]** with **◀/▶**, then press **●**.

DPOF (Print order) mark is attached to the image.



To remove the mark

Select the images from which you want to remove the mark, then press **●** in step 3.

Selecting and marking the images

- 1 Press MENU while displaying images in single-image mode or in index mode.
- 2 Select [DPOF] with ▲/▼ and select [Multiple Images] with ◀/▶, then press ●.
- 3 Select an image to mark with the control button, then press ●.

✓ mark is attached to the selected image.

Single Image



Index Display

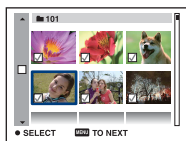

- 4 Press MENU.

- 5 Select [OK] with ▲, then press ●.

DPOF mark appears on the screen.

Single Image



Index Display

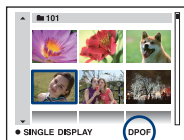

To cancel the selection

To cancel, select [Exit] in step 5, then press ●.

To remove the mark

Select the images that you want to remove the marks, then press ● in step 3.

To mark all the images in the folder

In step 3, move the frame to the folder selection bar with ◀, then press ● during the index mode.

✓ mark is attached to the selected folder and all the images.

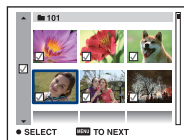



If you experience trouble with your camera, try the following solutions.

1 Check the items on pages 99 to 108.

If a code such as “C/E:□□:□□” appears on the screen, see page 109.

2 Remove the battery pack, and insert the battery pack again after about one minute, and turn on the power.

3 Initialize the settings (page 62).

4 Consult your Sony dealer or local authorized Sony service facility.

Please understand that you give your consent that the contents of the internal memory, Music files may be checked when you send your camera to be repaired.

Click one of the following items to jump to the page explaining the symptom and cause or the appropriate corrective action.

Battery pack and power

99

“Memory Stick Duo”

106

Shooting still images/movies

99

Internal memory

106

Viewing images

102

Printing

106

Deleting/Editing images

103

PictBridge compliant printer

107

Computers

103

Others

108

Picture Motion Browser

105

Battery pack and power

The battery pack cannot be inserted.

- Insert the battery pack correctly to push the battery eject lever.

Cannot turn on the camera.

- After installing the battery pack into the camera, it may take a little while to get the camera powered.
- Install the battery pack correctly.
- The battery pack is discharged. Insert charged battery pack.
- The battery pack is dead (page 115). Replace it with a new one.
- Use a recommended battery pack.

The power turns off suddenly.

- If you do not operate the camera for about three minutes while the power is on, the camera turns off automatically to prevent wearing down the battery pack. Turn on the camera again.
- The battery pack is dead (page 115). Replace it with a new one.

The battery remaining indicator is incorrect.

- This phenomenon occurs when you use the camera in an extremely hot or cold location.
- The displayed battery remaining differs from the current one. Fully discharge and then charge the battery pack to correct the display.
- The battery pack is discharged. Insert a charged battery pack.
- The battery pack is dead (page 115). Replace it with a new one.

Cannot charge the battery pack.

- You cannot charge the battery pack using the AC Adapter (not supplied).

Shooting still images/movies

The screen does not turn on even when the power is turned on.

- Turn on the screen (page 18).

Your camera cannot record images.

- Check the free capacity of the internal memory or “Memory Stick Duo”. If it is full, do one of the following:
 - Delete unnecessary images (page 31).
 - Change the “Memory Stick Duo”.
- You are using the “Memory Stick Duo” with a write-protect switch, and the switch is set to the LOCK position. Set the switch to the recording position (page 113).
- You cannot record images while charging the flash.
- When shooting a still image, set the mode dial to a position other than .

- Set the mode dial to  when shooting movies.
 - The image size is set to [640(Fine)] when recording movies. Do one of the following:
 - Set the image size to other than [640(Fine)].
 - Insert a “Memory Stick PRO Duo”.
-

Movie recording stops during shooting.

- Movie recording stops automatically when the file size of the movie reaches approximately 2 GB.
-

This subject is not visible on the screen.

- Your camera is set to the playback mode. Press  to change to the recording mode (page 29).
-



Anti-blur function does not work.

- The anti-blur function does not work when  appears on the display.
 - The anti-blur function may not work properly when shooting night scenes.
 - Shoot after pressing the shutter button halfway down; do not press it fully down suddenly.
-

Recording takes a long time.

- The NR slow shutter function is activated (page 15). This is not a malfunction.
-







The image is out of focus.

- The subject is too close. Shoot in  (Macro) recording mode. Make sure to position the lens farther away from the subject than the shortest shooting distance, approximately 4 cm (1 5/8 inches) (W)/35 cm (13 7/8 inches) (T), when shooting (page 24).
 -  (Twilight mode) or  (Landscape mode) is selected in the Scene mode when shooting still images.
 - The Focus preset function is selected. Select the auto focus mode (page 42).
 - Refer to “If the subject is out of focus” on page 44.
-

Zoom does not work.

- The smart zoom cannot be used when the image size is set to [8M] (DSC-W90), [7M] (DSC-W80/W85) or [3:2].
- The digital zoom cannot be used while shooting movies.
- You cannot change the zoom scale while shooting a movie.
- When [Face Detection] is set to [On], you cannot use the Digital Zoom.



The flash does not work.

- The flash is set to  (Flash forced off) (page 24).
- You cannot use the flash when:
 - [REC Mode] is set to [Burst] or Exposure Bracket (page 39).
 -  (High Sensitivity mode) or  (Twilight mode) is selected in the Scene mode (page 28).
 - Shooting movies.
- Set the flash to  (Flash forced on) when  (Landscape mode),  (Beach mode), or  (Snow mode) is selected in the Scene mode (page 24).

Fuzzy specks appear in images shot using the flash.

- Dust in the air reflected the flash light and appeared in the image. This is not a malfunction.

The close-up shoot function (Macro) does not work.

-  (Twilight mode) or  (Landscape mode) is selected in the Scene mode (page 28).

The date and time are not displayed on LCD screen.

- While shooting, the date and time are not displayed. They are displayed only during playback.

Cannot insert dates on image.

- This camera does not have a feature for superimposing dates on images (page 107). By using “Picture Motion Browser”, you can print or save images with the date (page 87).

The F value and shutter speed flash when you press and hold the shutter button halfway down.

- The exposure is incorrect. Correct the exposure (page 41).

The screen is too dark or too bright.

- Adjust the brightness of the LCD backlight (page 18).

The image is too dark.

- You are shooting a subject with a light source behind the subject. Select the metering mode (page 42) or adjust the exposure (page 41).
- Turn on the screen (page 18).

The image is too bright.

- Adjust the exposure (page 41).

The image colors are not correct.

- Set [Color Mode] to [Normal] (page 40).

Vertical streaks appear when you are shooting a very bright subject.

- The smear phenomenon is occurring and white, black, red, or purple streaks appear on the image. This phenomenon is not a malfunction.

Noise appears in the image when you view the screen in a dark place.

- The camera is attempting to increase the visibility of the screen by temporarily brightening the image under conditions of low illumination. There is no effect on the recorded image.

The eyes of the subject come out red.

- Set [Red Eye Reduction] to [On] (page 46).
- Shoot the subject at a distance closer than the flash range using the flash.
- Light the room and shoot the subject.
- Retouch the image using [Red Eye Correction] (page 52).

Dots appear and remain on the screen.

- This is not a malfunction. These dots are not recorded (page 2).

The image seen through the finder does not match with the actual recordable range.

- The parallax phenomenon is occurring when the subject is close. In this case, to confirm the recordable range, use the LCD screen.
- Images cannot be confirmed through the finder while the digital zoom is in use.

Cannot shoot images in succession.

- The internal memory or “Memory Stick Duo” is full. Delete unnecessary images (page 31).
- The battery level is low. Install charged battery pack.

Viewing images

Your camera cannot playback images.

- Press  (Playback) button (page 29).
- The folder/file name has been changed on your computer (page 82).
- When an image file has been processed by a computer or when the image file was recorded using a model other than that of your camera, playback on your camera is not guaranteed.
- The camera is in USB mode. Delete the USB connection (page 80).

The date and time are not displayed.

-  (DISP) button is turned off (page 18).

The image appears rough right after playback starts.

- The image may appear rough right after playback starts due to image processing. This is not a malfunction.

The image does not appear on the TV screen.

- Check [Video Out] to see if the video output signal of your camera is set to the color system of your TV (page 64).
- Check whether the connection is correct (page 70).
- If the USB connector of the cable for multi-use terminal is connected to another device, disconnect it (page 80).

Deleting/Editing images

Your camera cannot delete an image.

- Cancel the protection (page 53).
- You are using the “Memory Stick Duo” with the write-protect switch, and the switch is set to the LOCK position. Set the switch to the recording position (page 113).

You have deleted an image by mistake.

- Once you have deleted an image, you cannot restore it. We recommend that you protect images (page 53), or use the “Memory Stick Duo” with the write-protect switch and set the switch to the LOCK position (page 113) to prevent accidental erasure.

Computers

You do not know if the OS of your computer is compatible with the camera.

- Check “Recommended computer environment” on page 74 for Windows, and page 90 for Macintosh.

“Memory Stick PRO Duo” is not recognized by a computer with a “Memory Stick” slot.

- Check that the computer and the Memory Stick Reader/Writer support “Memory Stick PRO Duo”. Users of computers and Memory Stick Readers/Writers made by manufacturers other than Sony should contact those manufacturers.
- If “Memory Stick PRO Duo” is not supported, connect the camera to the computer (pages 77 and 90). The computer recognizes the “Memory Stick PRO Duo”.

Your computer does not recognize your camera.

- Turn on the camera.
- When the battery level is low, install the charged battery pack or use the AC adaptor (not supplied) (page 76).
- Set [USB Connect] to [Mass Storage] (page 63).
- Use the cable for multi-use terminal (supplied) (page 77).

- Disconnect the cable for multi-use terminal from both the computer and the camera, and connect it again firmly.
- Disconnect all equipment other than the camera, the keyboard and the mouse from the USB connectors of your computer.
- Connect the camera directly to your computer without passing through a USB hub or other device (page 77).
- The software (supplied) is not installed. Install the software (page 75).
- Your computer does not properly recognize the device because you connected the camera and your computer with the cable for multi-use terminal before you install the software (supplied). Delete the erroneously recognized device from your computer, then install the USB driver (see the next item).

The “Removable disk” icon does not appear on the computer screen when you connect your computer to the camera.

- Follow the procedure below to install the USB driver again. The following procedure is for a Windows computer.
 - 1 Right-click [My Computer] to display the menu, then click [Properties].
The “System Properties” screen appears.
 - 2 Click [Hardware] → [Device Manager].
The “Device Manager” appears.
 - 3 Right-click [Sony DSC], then click [Uninstall] → [OK].
The device is deleted.
 - 4 Install the software (page 75).
A USB driver is also installed.

You cannot copy images.

- Connect the camera and your computer correctly making a USB connection (page 77).
- Follow the designated copy procedure for your OS (pages 77 and 90).
- When you shoot images with a “Memory Stick Duo” formatted by a computer, you may not be able to copy the images to a computer. Shoot using a “Memory Stick Duo” formatted by your camera (page 58).

After making a USB connection, “Picture Motion Browser” does not start automatically.

- Start “Media Check Tool” (page 83).
- Make the USB connection after the computer is turned on (page 77).

The image cannot be played back on a computer.

- If you are using “Picture Motion Browser”, refer to the Help.
- Consult the computer or software manufacturer.

The image and sound are interrupted by noise when you view a movie on a computer.

- You are playing back the movie directly from the internal memory or the “Memory Stick Duo”. Copy the movie to the hard disk of your computer, then playback the movie from the hard disk (page 76).

You cannot print an image.

- Refer to the operation manual of the printer.

Images once copied to a computer cannot be viewed on the camera.

- Copy them to a folder recognized by the camera, such as “101MSDCF” (page 81).
- Follow the correct procedures (page 82).

Picture Motion Browser

Images are not displayed correctly with “Picture Motion Browser”.

- Make sure the folder of the images is registered in “Viewed folders”. If the images are not displayed even if the folder is registered in “Viewed folders”, update the database (page 87).

You cannot find images imported with “Picture Motion Browser”.

- Look in the “My Pictures” folder.
- If you have changed the default settings, refer to “Changing the “Folder to be imported”” on page 87 and check what folder is used for importing.

You want to change the “Folder to be imported”.

- Access the “Import Settings” screen to change “Folder to be imported”. You can specify a different folder after using “Picture Motion Browser” to register it in “Viewed folders” (page 87).

The date of all imported images is displayed differently from the date on the calendar.

- The date on the camera is not set correctly. Set the date and time correctly (page 68).

is displays on the screen.

- The recorded data is outdated, due to changing or deleting of the name of an image or a folder. Select [Update Database] from the [Tools] menu, and execute.

“Memory Stick Duo”

Cannot insert a “Memory Stick Duo”.

- Insert it in the correct direction.

Cannot format a “Memory Stick Duo”.

- You are using the “Memory Stick Duo” with the write-protect switch, and the switch is set to the LOCK position. Set the switch to the recording position (page 113).

You have formatted a “Memory Stick Duo” by mistake.

- All the data on the “Memory Stick Duo” is deleted by formatting. You cannot restore it. We recommend that you set the write-protect switch on the “Memory Stick Duo” to the LOCK position to prevent accidental erasure (page 113).

Internal memory

Cannot playback or record images using the internal memory.

- There is a “Memory Stick Duo” inserted in the camera. Remove it.

Cannot copy the data stored in the internal memory to a “Memory Stick Duo”.

- The “Memory Stick Duo” is full. Check the capacity (64 MB or more recommended).

Cannot copy the data on the “Memory Stick Duo” or the computer to the internal memory.

- Data on a “Memory Stick Duo” or a computer cannot be copied to the internal memory.

Printing

Also see “PictBridge compliant printer” (as follows) in conjunction with the following items.

Images are printed with both edges cut off.

- Depending on your printer, the left, right, top, and bottom edges of the image may be cut off. Especially when you print an image shot with the image size set to [16:9], the lateral end of the image may be cut off.
- When printing images using your own printer, cancel the trimming or borderless settings. Consult the printer manufacturer as to whether the printer provides these functions or not.
- When having images printed at a digital print shop, ask the shop whether they can print the images without cutting off both edges.

Cannot print images with the date.

- Using “Picture Motion Browser”, you can print images with date (page 87).
- This camera does not have a feature for superimposing dates on images. However, because the images shot with the camera include information on the recording date, you can print images with the date superimposed if the printer or the software can recognize Exif information. For compatibility with Exif information, consult the manufacturer of the printer or the software.
- When you print images at a shop, images can be printed with the date if you ask them to do so.

PictBridge compliant printer

A connection cannot be established.

- The camera cannot be connected directly to a printer that is not compliant with the PictBridge standard. Consult the printer manufacturer as to whether the printer is compliant with PictBridge or not.
- Check that the printer is turned on and can be connected to the camera.
- Set [USB Connect] to [PictBridge] (page 63).
- Disconnect and connect the cable for multi-use terminal again. If an error message is indicated on the printer, refer to the operating instructions supplied with the printer.

Cannot print images.

- Check that the camera and the printer are properly connected using the cable for multi-use terminal.
- Turn on the printer. For further information, refer to the operating instructions supplied with the printer.
- If you select [Exit] during printing, images may not be printed. Disconnect and connect the cable for multi-use terminal again. If you still cannot print your images, disconnect the cable for multi-use terminal, turn the printer off and then on, then connect the cable for multi-use terminal again.
- Movies cannot be printed.
- Images shot using cameras other than this camera or images modified with a computer may not be printed.

Printing is canceled.

- Confirm that you have disconnected the cable for multi-use terminal before the  (PictBridge Connecting) mark disappears.

Cannot insert the date or print images in the index mode.

- The printer does not provide these functions. Consult the printer manufacturer as to whether the printer provides these functions or not.
- The date may not be inserted in the index mode depending on the printer. Consult the printer manufacturer.

“---- -- --” is printed on the date-inserted part of the image.

- Images that do not have the recording data cannot be printed with the date inserted. Set [Date] to [Off] and print the image again (page 94).

Cannot select the print size.

- Consult the printer manufacturer as to whether the printer can provide the desired size.

Cannot print the image at the size selected.

- Disconnect the cable for multi-use terminal and reconnect it whenever you change the paper size after the printer has been connected to the camera.
- The print setting of the camera differs from that of the printer. Change the setting of either the camera (page 94) or the printer.

Cannot operate the camera after canceling printing.

- Wait for a while as the printer is carrying out the cancellation. It may take some time depending on the printer.

Others

The camera does not function with the lens portion extended.

- Do not attempt to force the lens that has stopped moving.
- Insert a charged battery, then turn on the camera again.

The lens gets fogged.

- Moisture condensation has occurred. Turn off the camera and leave it for about an hour before using it.

The lens does not move when you turn off the camera.

- The battery pack is discharged. Replace it with a charged battery pack.

The camera becomes warm when you use it for a long time.

- This is not a malfunction.

The Clock Set screen appears when you turn on the camera.

- Set the date and time again (page 68).

You want to change the date or time.

- Set the date and time again (page 68).

Warning indicators and messages

Self-diagnosis display

If a code starting with a letter of the alphabet appears, your camera has a self-diagnosis display. The last two digits (indicated by □□) will differ depending on the state of the camera.

If you are unable to solve the problem even after trying the following corrective actions a few times, your camera may need repair. Contact your Sony dealer or local authorized Sony service facility.

C:32:□□

- There is trouble with your camera's hardware. Turn the power off and on again.

C:13:□□

- The camera cannot read or write data on the "Memory Stick Duo". Try turning off and on the camera again, or taking out and inserting the "Memory Stick Duo" several times.
- The internal memory has experienced a format error, or an unformatted "Memory Stick Duo" is inserted. Format the internal memory or the "Memory Stick Duo" (pages 58, 61).
- The inserted "Memory Stick Duo" cannot be used with your camera, or the data is damaged. Insert a new "Memory Stick Duo".

E:61:□□

E:62:□□

E:91:□□

- A camera malfunction has occurred. Initialize the camera (page 62), then turn the power on again.

Messages

If the following messages appear, follow the instructions.



- The battery level is low. Charge the battery pack immediately. Depending on the conditions of use or the type of battery pack, the indicator may flash even though there are still 5 to 10 minutes of remaining battery time left.

For use with compatible battery only

- The battery inserted is not an NP-BG1 battery pack.

System error

- Turn the power off and then on again.

Internal memory error

- Turn the power off and then on again.

Reinsert the Memory Stick

- Insert the "Memory Stick Duo" correctly.
- The inserted "Memory Stick Duo" cannot be used in your camera (page 113).
- The "Memory Stick Duo" is damaged.
- The terminal section of the "Memory Stick Duo" is dirty.

Memory Stick type error

- The inserted "Memory Stick Duo" cannot be used in your camera (page 113).

Cannot access Memory Stick Access denied

- You are using the "Memory Stick" with the access controlled.

Memory Stick formatting error Internal memory formatting error

- Format the media again (pages 58 and 61).

Memory Stick locked

- You are using the “Memory Stick Duo” with the write-protect switch, and the switch is set to the LOCK position. Set the switch to the recording position (page 113).

No memory space in internal memory

No memory space on Memory Stick

- Delete unnecessary images or files (page 31).

Read only memory

- Your camera cannot record or delete images on this “Memory Stick Duo”.

No Images

- No images that can be played have been recorded in the internal memory.
- No images that can be played have been recorded in this folder.
- The selected folder does not contain a file that can be played in a Slide Show with music.

Folder error

- A folder with the same first three digit number already exists on the “Memory Stick Duo” (for example: 123MSDCF and 123ABCDE). Select another folders, or create a new folder (pages 58, 59).

Cannot create more folders

- The folder with a name beginning with “999” exists on the “Memory Stick Duo”. You cannot create any folders if this is the case.

File error

- An error occurred while the image was playing back.

Read only folder

- You have selected a folder that cannot be set as a recording folder on your camera. Select another folder (page 59).

File protect

- Release the protection (page 53).

Image size over

- You are playing back an image with size that cannot be played back on your camera.

Invalid operation

- You are trying to playback a file that is not compatible with the camera.
- You have selected a function that is not available for movies.



(Vibration warning indicator)

- Camera shake may occur due to insufficient light. Use the flash, turn on the anti-blur function, or mount the camera on a tripod to secure the camera.

640(Fine) is not available

- 640(Fine) size movies can be recorded only using a “Memory Stick PRO Duo”. Insert a “Memory Stick PRO Duo” or set the image size to a size other than [640(Fine)].

Macro is invalid

- The macro is unavailable under these settings (pages 24, 28).

Flash settings cannot be changed

- The flash is unavailable during these settings (pages 24, 28).

Maximum images selected

- You can select up to 100 images. Remove the checkmark.

No enough battery

- When copying a image recorded in the internal memory to the “Memory Stick Duo”, use a fully charged battery.

Printer busy

Paper error

No Paper

Ink error

Low Ink

No Ink

- Check the printer.

Printer error

- Check the printer.
- Check if the image you want to print is corrupted.



- The data transmission to the printer may not be completed yet. Do not disconnect the cable for multi-use terminal.

Processing

- The printer is canceling the current print job. You cannot print until it is finished. This may take time, depending on the printer.

Music Error

- Delete the Music file, or replace it with a normal Music file.
- Execute [Format Music], then download a new Music files.

Format Music Error

- Execute [Format Music].

Invalid operation

HD (1080i) output in progress...

- You are trying to playback movies.
- You are trying to [Retouch] function.

TV output in progress...

- The camera is playing back images in the Slide Show mode.

No red-eye detected

- You may not be able to correct the red-eye phenomenon depending on the image.



To use your camera abroad — Power sources

You can use your camera, the battery charger (supplied), and the AC-LS5K AC Adaptor (not supplied) in any country or region where the power supply is within 100 V to 240 V AC, 50/60 Hz.

- **Do not use an electronic transformer (travel converter), as this may cause a malfunction.**

On the “Memory Stick”

A “Memory Stick” is a compact, portable IC recording medium. The types of “Memory Stick” that can be used with this camera are listed in the table below. However, proper operation cannot be guaranteed for all “Memory Stick” functions.

“Memory Stick” type	Recording/Playback
Memory Stick (without MagicGate)	—
Memory Stick (with MagicGate)	—
Memory Stick Duo (without MagicGate)	○
Memory Stick Duo (with MagicGate)	○ ^{*1} *2
MagicGate Memory Stick	—
MagicGate Memory Stick Duo	○ ^{*1}
Memory Stick PRO	—
Memory Stick PRO Duo	○ ^{*1} *2*3

^{*1} “Memory Stick Duo”, “MagicGate Memory Stick Duo” and “Memory Stick PRO Duo” are equipped with MagicGate functions. MagicGate is copyright protection technology that uses encryption technology. Data recording/playback that requires MagicGate functions cannot be performed with this camera.

^{*2} Supports high-speed data transfer using a parallel interface.

^{*3} 640(Fine) size movies can be recorded.

- This product is compatible with “Memory Stick Micro” (“M2”). “M2” is an abbreviation for “Memory Stick Micro”.
- A “Memory Stick Duo” formatted with a computer is not guaranteed to operate with this camera.
- Data read/write speeds differ depending on the combination of the “Memory Stick Duo” and the equipment used.

Notes on using a “Memory Stick Duo” (not supplied)

- You cannot record, edit or delete images if you slide the write-protect switch to LOCK with a fine-tipped object.

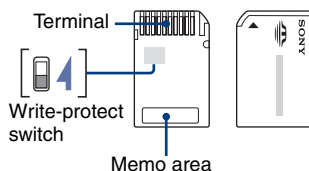

Some “Memory Stick Duo” cards do not have a write-protect switch. On “Memory Stick Duo” with this switch, the position and shape may vary depending on the “Memory Stick Duo”.

- Do not remove the “Memory Stick Duo” while reading or writing data.
- Data may be corrupted in the following cases:
 - When the “Memory Stick Duo” is removed or the camera is turned off during a read or write operation
 - When the “Memory Stick Duo” is used in locations subject to static electricity or electrical noise
- We recommend backing up important data.
- Do not press down hard when you write down on the memo area.
- Do not attach a label on the “Memory Stick Duo” itself nor on a Memory Stick Duo Adaptor.
- When you carry or store the “Memory Stick Duo”, put it in the case supplied with it.
- Do not touch the terminal section of the “Memory Stick Duo” with your hand or a metal object.
- Do not strike, bend or drop the “Memory Stick Duo”.
- Do not disassemble or modify the “Memory Stick Duo”.
- Do not expose the “Memory Stick Duo” to water.
- Do not leave the “Memory Stick Duo” within the reach of small children. They might accidentally swallow it.

On the “Memory Stick”

- Do not use or store the “Memory Stick Duo” under the following conditions:
 - High temperature locations such as the hot interior of a car parked in direct sunlight
 - Locations exposed to direct sunlight
 - Humid locations or locations with corrosive substances present

Notes on using the Memory Stick Duo Adaptor (not supplied)

- To use a “Memory Stick Duo” with a “Memory Stick” compliant device, be sure to insert the “Memory Stick Duo” into a Memory Stick Duo Adaptor. If you insert a “Memory Stick Duo” into a “Memory Stick” compliant device without a Memory Stick Duo Adaptor, you might not be able to remove it from the device.
- When inserting a “Memory Stick Duo” into a Memory Stick Duo Adaptor, make sure the “Memory Stick Duo” is inserted facing in the correct direction, then insert it all the way in. Incorrect insertion may result in a malfunction.
- When using a “Memory Stick Duo” inserted into a Memory Stick Duo Adaptor with a “Memory Stick” compliant device, make sure that the Memory Stick Duo Adaptor is inserted facing the correct direction. Note that improper use may damage the equipment.
- Do not insert a Memory Stick Duo Adaptor into a “Memory Stick” compliant device without a “Memory Stick Duo” attached. Doing so may result in malfunction of the unit.

Notes on using “Memory Stick PRO Duo” (not supplied)

“Memory Stick PRO Duo” with a capacity up to 8 GB have been confirmed to operate properly with this camera.

Notes on using “Memory Stick Micro” (not supplied)

- To use a “Memory Stick Micro” with this camera, be sure to insert the “Memory Stick Micro” into an “M2” Adaptor as large as of Duo size. If you insert a “Memory Stick Micro” into the camera without an “M2” Adaptor as large as of Duo size, you might not be able to remove it from the camera.
- Do not leave the “Memory Stick Micro” within the reach of small children. They might accidentally swallow it.

On the battery pack

On charging the battery pack

We recommend charging the battery pack in an ambient temperature of between 10°C to 30°C (50°F to 86°F). You may not be able to efficiently charge the battery pack outside of this temperature range.

Effective use of the battery pack

- Battery performance decreases in low temperature surroundings. So, the time that the battery pack can be used is shorter in cold places. We recommend the following to ensure longer battery pack use:
 - Put the battery pack in a pocket close to your body to warm it up, and insert it in your camera immediately before you start shooting.
- The battery pack will run out quickly if you use the flash or zoom frequently.
- We recommend having spare battery packs handy for two or three times the expected shooting time, and making trial shots before taking the actual shots.
- Do not expose the battery pack to water. The battery pack is not water-resistant.
- Do not leave the battery pack in extremely hot places, such as in a car or under direct sunlight.

How to store the battery pack

- If the battery pack is not to be used for a long time, fully charge it and then fully use it up once a year on your camera before storing the battery pack in a dry, cool place. Repeat this charging and using up once a year to maintain the battery pack's function.
- To use the battery pack up, leave your camera in slide show (page 48) playback mode until the power goes off.
- To prevent staining the terminal, short-circuiting, etc., be sure to use a supplied battery case when carrying and storing.

On battery life

- The battery life is limited. Battery capacity decreases little by little as you use it more and more, and as time passes. If the battery operating time seems shortened considerably, a probable cause is that the battery pack has reached the end of its life. Buy a new battery pack.

- The battery life varies according to how it is stored and the operating conditions and environment in which each battery pack is used.

On the battery charger

On the battery charger

- Do not charge any other battery pack other than the NP-BG type battery packs in the battery charger supplied with your camera. Batteries other than the specified kind may leak, overheat, or explode if you attempt to charge them, posing a risk of injury from electrocution and burns.
- Remove the charged battery pack from the battery charger. If you leave the charged battery pack in the charger, battery life may be shortened.
- When the CHARGE lamp flashes, this may indicate a battery error or that a battery pack other than the specified type have been inserted. Check that the battery pack is the specified type. If the battery pack is the specified type, remove the battery pack, replace it with new one or another one and check if the battery charger operates correctly. If the battery charger operates correctly, a battery error may have occurred.
- If the battery charger is dirty, charging may not be performed successfully. Clean the battery charger with dry cloth, etc.



- A**
- Adjusting EV19, 41
 - AE/AF lock indicator.....22, 44
 - AF Illuminator65
 - AF lock44
 - AF Mode.....66
 - AF range finder frame42
 - Aperture8
 - Auto Adjustment mode.....22
 - Auto Focus.....7
 - Auto Orientation67
 - Auto Review67
- B**
- B & W.....40
 - Battery charger.....116
 - battery pack.....115
 - Beach mode27
 - Beep62
 - Blur7
 - Burst.....39
- C**
- Cable for multi-use terminal
.....70, 77, 94
 - Center AF43
 - Center-weighted metering ...42
 - Change REC. Folder59
 - Clock Settings68
 - Cloudy45
 - Color9
 - Color Mode.....40
 - COMPONENT63
 - Computer73
 - Copying images76, 90
 - Macintosh90
 - Recommended
environment.....74, 90
 - Software.....75
 - Viewing image files stored
on a computer with your
camera.....82
 - Windows73
- Connecting
- Computer77
 - Printer.....94
 - TV70
- Copy60
- Copying images to your
computer76
- Create REC. Folder58
- Cross Filter.....52
- D**
- Date68, 87, 95
 - Daylight.....45
 - Delete51
 - Format58, 61
 - Deleting images.....31
 - Digital Zoom66
 - DirectX.....74
 - DISP18
 - Download Music89
 - DPOF54, 96
- E**
- EV41
 - Exposure.....8
 - Exposure Bracket39
 - Extension.....82
- F**
- Face Detection.....38
 - File name.....81
 - File storage destination81
 - Fisheye Lens.....52
 - Flash (White Bal)46
 - Flash forced off24
 - Flash forced on24
 - Flash Level46
 - Flash mode.....24
 - Fluorescent Light 1, 2, 3.....45
 - Focus.....7, 23, 42
 - Focus preset43
 - Folder.....55
 - Changing59
 - Creating58
 - Selecting55
 - Format.....58, 61
 - Format Music.....89
 - Function Guide62
- G**
- Grid Line65
- H**
- High Sensitivity mode27
 - Histogram18, 19
 - Holding the camera.....7, 22
 - HOME33
- I**
- Identifying parts.....12
 - Image file storage destinations
and file names.....81
 - Image quality10
 - Image Size37
 - Image size.....10
 - Incandescent45
 - Index Display48
 - Index screen.....30
 - Indicator.....14
 - Initialize62
 - Install75
 - Internal memory20
 - Internal Memory Tool.....61
 - ISO.....8, 41
- J**
- JPG81

L

Landscape mode	27
Language Setting	69
LCD backlight	18
LCD Screen	18

M

Macintosh computer	90
Recommended environment.....	90
Macro.....	24
Main Settings 1.....	62
Main Settings 2.....	63
Manage Memory	58
Map View	86
Mass Storage	63
“Memory Stick Duo”.....	113
Memory Stick Tool.....	58
Menu	
Items.....	36
Shooting	37
Viewing	51
Metering Mode	42
Mode Dial.....	21
Monitor	66
MPG	81
Multi AF.....	42
Multi Connector	70, 77, 94
Multi-pattern metering	42
Music	50
Music Tool.....	89
Music Transfer.....	89, 91

N

Natural	40
NR slow shutter	15
NTSC.....	64

O

Optical zoom.....	23, 66
OS	74, 90
Overexposure	8

P

PAL	64
Partial Color	51
PC.....	73
PictBridge	63, 93
Picture Motion Browser.....	83
Pixel	10
Playback zoom.....	29
Precision digital zoom	66
Pressing halfway down	7
Print.....	54, 92
Print order mark	96
Printing at a shop	96
Printing directly	93
Program Auto mode.....	21
Protect	53

R

REC Mode	39
Red Eye Correction.....	52
Red Eye Reduction	46
Retouch.....	51
Rotate.....	54

S

Scene Selection	26
Screen	
Changing the display	18
Indicator	14
LCD backlight	18
Select Folder	55
Self-diagnosis display	109
Self-timer	24
Sepia.....	40
Settings.....	62

SETUP.....	47
Shooting	37
Movies.....	22, 23
Still image	22
Shooting Settings 1.....	65
Shooting Settings 2.....	67
Shutter speed	8
Single.....	66
Single Image.....	48
Slide Show.....	48, 51
Slow synchro	24
Smart zoom	66
Snow mode	27
Soft Focus.....	51
Soft Snap mode	27
Software	75, 83, 89
Spot AF	43
Spot metering	42
Spot metering cross hairs	42
SteadyShot.....	47

T

Trimming	52
Troubleshooting.....	98
TV.....	70
Twilight mode.....	27
Twilight Portrait mode.....	27

U

Underexposure.....	8
USB Connect.....	63
Using your camera abroad	112

V

VGA	11
Video Out	64
Viewing images	29
Viewing menu.....	51
Vivid	40

Volume29

W

Warning indicators and
messages109

White Bal45

Windows computer73

 Recommended
 environment74

Write-protect switch113

Z

Zoom23

Notes on the License

“C Library”, “Expat”, and “zlib” software are provided in your camera. We provide this software based on license agreements with their owners of copyright. Based on requests by the owners of copyright of these software applications, we have an obligation to inform you of the following. Please read the following sections.

Read “license1.pdf” in the “License” folder on the CD-ROM. You will find licenses (in English) of “C Library”, “Expat”, “zlib” software.

On GNU GPL/LGPL applied software

The software that is eligible for the following GNU General Public License (hereinafter referred to as “GPL”) or GNU Lesser General Public License (hereinafter referred to as “LGPL”) are included in the camera.

This informs you that you have a right to have access to, modify, and redistribute source code for these software programs under the conditions of the supplied GPL/LGPL.

Source code is provided on the web. Use the following URL to download it.

<http://www.sony.net/Products/Linux/>

We would prefer you do not contact us about the contents of source code.

Read “license2.pdf” in the “License” folder on the CD-ROM. You will find licenses (in English) of “GPL”, and “LGPL” software.

To view the PDF, Adobe Reader is needed. If it is not installed on your computer, you can download it from the Adobe Systems web page:

<http://www.adobe.com/>

Additional information on this product and answers to frequently asked questions can be found at our Customer Support Website.

<http://www.sony.net/>