

SONY®



Table of  
contents

Operation  
Search

MENU/Settings  
Search

Index

# Cyber-shot

## ***Cyber-shot Handbook***

**DSC-WX1**

# How to use this handbook

Click on a button at upper right to jump to the corresponding page.  
This is convenient when searching for a function you want to view.



← Search for information by function.

← Search for information by operation.

← Search for information in a listing of MENU/Settings items.

← Search for information by keyword.

Table of contents

Operation Search

MENU/Settings Search

Index

## Marks and notations used in this handbook

In this handbook, the sequence of operations is shown by arrows (→). Operate the camera in the order indicated. Marks are shown as they appear in the camera's default setting.

The default setting is indicated by ✓.

Indicates cautions and limitations relevant to the correct operation of the camera.

Indicates information that is useful to know.

### Red Eye Reduction

The flash strobos two or more times before shooting to reduce the red-eye phenomenon when using the flash.

1 MENU → [Flash] (Red Eye Reduction) → desired mode

✓ [Auto]	When the Face Detection function is activated, the flash strobos automatically to reduce the red-eye phenomenon.
[On]	The flash always strobos to reduce the red-eye phenomenon.
[Off]	Does not use Red Eye Reduction.

**Notes**

- [Red Eye Reduction] cannot be selected during Easy Shooting, Anti Motion Blur, Hand-held Twilight, Sweep Panorama, Movie Mode or Smile Shutter.
- To avoid blurring of images, hold the camera firmly until the shutter is released. It usually takes a second after you press the shutter button. Be also sure not to allow the subject to move during this period.
- Red Eye Reduction may not produce the desired effects. It depends on individual differences and conditions, such as distance to the subject, or if the subject looked away from the pre-strobe.
- If you do not use the Face Detection function, Red Eye Reduction does not work, even when you select [Auto].

**What causes the red-eye phenomenon?**

Pupils become dilated in dark environments. Flash light is reflected off the blood vessels at the back of the eye (retina), causing the "red-eye" phenomenon.

**Other ways to reduce red-eye**

- Select [High Sensitivity] mode in Scene Selection. (The flash is set to [OFF] automatically.)
- When the eyes of the subject turn out red, correct the image with [Retouch] → [Red Eye Correction] on the viewing menu or with the supplied software "PMB".

# Notes on using the camera

## Notes on the types of “Memory Stick” media that you can use (sold separately)



**“Memory Stick Duo” media:** You can use a “Memory Stick Duo” media with the camera.



**“Memory Stick” media:** You cannot use a “Memory Stick” media with the camera.

## Other memory cards cannot be used.

- For details on “Memory Stick Duo” media, see page 127.

## When using a “Memory Stick Duo” media with “Memory Stick” media compatible equipment

You can use the “Memory Stick Duo” media by inserting it into the “Memory Stick Duo” media Adaptor (sold separately).



“Memory Stick Duo” media Adaptor

## Notes on the battery pack

- Charge the battery pack (supplied) before using the camera for the first time.
- You can charge the battery pack even if it is not completely discharged. In addition, even if the battery pack is not fully charged, you can use the partially charged capacity of the battery pack as is.
- If you do not intend to use the battery pack for a long time, use up the existing charge and remove it from the camera, then store it in a cool, dry place. This is to maintain the battery pack functions.
- For details on the usable battery pack, see page 129.

## Notes on the LCD screen and lens

- The LCD screen is manufactured using extremely high-precision technology so over 99.99% of the pixels are operational for effective use. However, some tiny black and/or bright dots (white, red, blue or green) may appear on the LCD screen. These dots are a normal result of the manufacturing process and do not affect the recording.

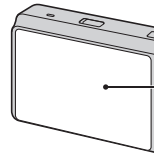

Black, white, red, blue or green dots

- Exposing the LCD screen or the lens to direct sunlight for long periods may cause malfunctions. Be careful when placing the camera near a window or outdoors.
- Do not press against the LCD screen. The screen may be discolored and that may cause a malfunction.
- Images may trail across on the LCD screen in a cold location. This is not a malfunction.
- Be careful not to bump the movable lens, and be careful not to apply force to it.

## On moisture condensation

- If the camera is brought directly from a cold to a warm location, moisture may condense inside or outside the camera. This moisture condensation may cause a malfunction of the camera.
- If moisture condensation occurs, turn off the camera and wait about an hour for the moisture to evaporate. Note that if you attempt to shoot with moisture remaining inside the lens, you will be unable to record clear images.

## The images used in this Handbook

The images used as examples in this Handbook are reproduced images, and are not actual images shot using this camera.

# Table of contents

---

## Notes on using the camera

How to use this handbook .....	2
Notes on using the camera .....	3
Operation Search .....	7
MENU/Settings Search .....	10
Identifying parts .....	13
List of icons displayed on the screen .....	14
Using the mode dial .....	16
Changing the DISP (Screen Display Settings) .....	17
Using the internal memory .....	19

---

## Shooting

Intelligent Auto Adjustment .....	20
Easy Shooting .....	21
Program Auto .....	23
Sweep Panorama .....	24
Anti Motion Blur .....	26
Hand-held Twilight .....	27
Scene Selection .....	28
Movie Mode .....	30
Zoom .....	31
Flash .....	32
Smile Shutter .....	33
Self-Timer .....	34
Burst/Bracket .....	35

---

## Viewing

Viewing still images .....	37
Playback zoom .....	38
Image Index .....	39
Delete .....	40
Viewing movies .....	41

---

## MENU (Shooting)

MENU items (Shooting) .....	10
-----------------------------	----

---

## MENU (Viewing)

MENU items (Viewing) .....	11
----------------------------	----

---

## Settings

Setting items .....	12
---------------------	----

---

## TV

Viewing images on a TV .....	101
------------------------------	-----

---

## Computer

Using with your computer .....	104
Using the software .....	105
Connecting the camera to the computer .....	108
Viewing “Cyber-shot Step-up Guide” .....	110

---

## Printing

Printing still images .....	111
-----------------------------	-----

---

## Troubleshooting

Troubleshooting .....	113
Warning indicators and messages .....	121

---

## Others

Image file storage destinations and file names .....	126
“Memory Stick Duo” media .....	127
Battery pack .....	129
Battery charger .....	130
Intelligent Pantiler .....	131

---

## Index

Index .....	132
-------------	-----

# Operation Search

Leaving the settings to the camera	Intelligent Auto Adjustment.....	20
	Scene Selection.....	28
	Scene Recognition.....	58
Shooting portraits	Soft Snap.....	28
	Twilight Portrait.....	28
	Smile Shutter.....	33
	Scene Recognition.....	58
	Face Detection.....	61
	Anti Blink.....	64
	Red Eye Reduction.....	65
Shooting panoramic images	Sweep Panorama.....	24
Shooting best shots of your pet	Pet.....	28
Shooting moving objects	Movie Mode.....	30
	Burst.....	35, 47
Shooting without blur	Anti Motion Blur.....	26
	Hand-held Twilight.....	27
	High Sensitivity.....	28
	2-second delay self-timer.....	34
	ISO.....	50
	SteadyShot.....	66
Shooting with backlight	Forced Flash.....	32
	Scene Recognition.....	58
	DRO.....	63

Table of contents

Operation Search

MENU/Settings Search

Index

Shooting in dark places	Anti Motion Blur.....	26
	High Sensitivity.....	28
	Slow Synchro.....	32
	ISO.....	50
Adjusting exposure	Histogram .....	18
	EV .....	49
Changing focus position	Focus .....	54
	Face Detection.....	61
Changing image size	Image Size.....	44
Deleting images	Delete.....	40, 73
	Format .....	93
Displaying enlarged images	Playback zoom.....	38
	Trimming.....	72
Editing images	Retouch .....	72
Playing back a series of images in order	Slideshow .....	67
Shooting/Viewing with easy-to-see indicators	Easy Shooting .....	21
Printing images with the date	Using the “PMB (Picture Motion Browser)” .....	105
Changing date and time settings	Area Setting .....	99
	Date & Time Setting.....	100
Initializing settings	Initialize.....	87
Printing images	Print .....	111



---

Viewing on TVs	Viewing images on a TV.....	101
Information about optional accessories	“Cyber-shot Step-up Guide” .....	110
	“Intelligent Pantiliter” .....	131

---

Table of contents

Operation Search

MENU/Settings Search

Index

# MENU/Settings Search

## MENU items (Shooting)

You can select the various shooting functions easily from the MENU button.

- 1 Press the MENU button to display the Menu screen.
- 2 Select the desired menu item with ▲/▼/◀/▶ on the control button.
- 3 Press the MENU button to turn off the Menu screen.

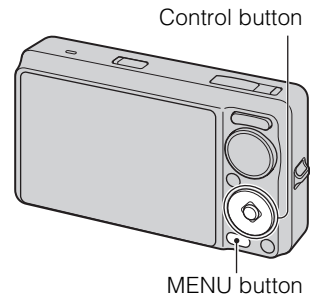

In the table below, ✓ indicates an available function. The icons below [SCN] and [⌘] indicate the available modes.







Menu items	Mode dial	i	EASY	P	(⊂)	☾	⌘	SCN	⌘
Scene Selection	—	—	—	—	—	—	—	✓	—
Movie shooting mode	—	—	—	—	—	—	—	—	✓
Shooting Direction	—	—	—	—	—	—	✓	—	—
Image Size	✓	✓	✓	✓	✓	✓	✓	✓	✓
Burst	✓	—	✓	—	—	—	—	⊂, ⌘, ⌘, ⌘, ⌘	—
Flash	—	✓	—	—	—	—	—	—	—
EV	✓	—	✓	✓	✓	✓	✓	✓	✓
ISO	—	—	✓	—	—	—	—	⌘	—
White Balance	—	—	—	✓	✓	✓	✓	ISO, ⌘, ⌘	⌘
Underwater White Balance	—	—	—	—	—	—	—	⌘	⌘
Focus	—	—	✓	—	—	—	✓	—	—
Metering Mode	—	—	—	✓	✓	✓	✓	—	✓
Bracket Settings	—	—	—	✓	—	—	—	⊂, ⌘, ⌘, ⌘	—
Scene Recognition	✓	—	—	—	—	—	—	—	—
Smile Detection Sensitivity	✓	—	✓	—	—	—	—	ISO, ⊂, ⊂, ⌘, ⌘	—
Face Detection	✓	—	✓	✓	✓	—	—	ISO, ⊂, ⊂, ⌘, ⌘	—
DRO	—	—	—	✓	—	—	—	—	—
Anti Blink	—	—	—	—	—	—	—	⊂	—
Red Eye Reduction	✓	—	—	✓	—	—	—	⊂, ⌘, ⊂, ⌘, ⌘	—
SteadyShot	—	—	—	✓	✓	✓	—	ISO, ⊂, ⌘, ⊂, ⊂, ⌘, ⌘	✓
⌘ (Settings)	✓	—	—	✓	✓	✓	✓	✓	✓

### Note

- Only the items that are available for each mode are displayed on the screen.







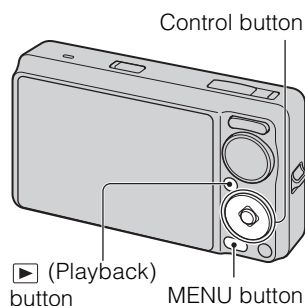





## MENU items (Viewing)

You can select the various viewing functions easily from the MENU button.

- 1 Press the  (Playback) button to switch to playback mode.
- 2 Press the MENU button to display the Menu screen.
- 3 Select the desired menu item with /// on the control button.
- 4 Press  on the center of the control button.



In the table below, ✓ indicates an available function.









View Mode \ Menu items	"Memory Stick Duo" media		Internal Memory
	 Date View	 Folder View	 Folder View
 (Slideshow)	✓	✓	✓
 (View Mode)	✓	✓	—
 (Display Burst Group)	✓	—	—
 (Retouch)	✓	✓	✓
 (Delete)	✓	✓	✓
 (Protect)	✓	✓	✓
DPOF	✓	✓	—
 (Print)	✓	✓	✓
 (Rotate)	✓	✓	✓
 (Select Folder)	—	✓	—
 (Settings)	✓	✓	✓

### Notes





- Only the items that are available for each mode are displayed on the screen.
- When the mode dial is set to **EASY** (Easy Shooting), if you press MENU, the Delete screen appears. You can select between [Delete Single Image] or [Delete All Images].

# Setting items

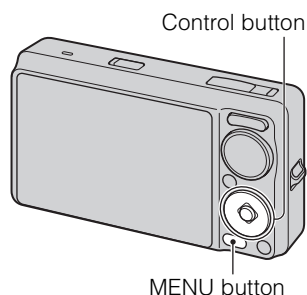
You can change the settings on the  (Settings) screen.

- 1 Press the MENU button to display the Menu screen.
- 2 Select  (Settings) with  on the control button, then press  on the center of the control button to display the setup screen.
- 3 Select the desired category with /, then press  to select each item, then .
- 4 Select the desired setting, then press .





Categories	Items
 <b>Shooting Settings</b>	AF Illuminator
	Grid Line
	Digital Zoom
	Auto Orientation
	Blink Alert
 <b>Main Settings</b>	Beep
	Language Setting
	Function Guide
	Demo Mode
	Initialize
	COMPONENT
	Video Out
	USB Connect
	Download Music
	Format Music
	 <b>“Memory Stick” Tool</b>
Create REC.Folder	
Change REC.Folder	
Delete REC.Folder	
Copy	
File Number	
 <b>Internal Memory Tool</b>	Format
	File Number
 <b>Clock Settings</b>	Area Setting
	Date & Time Setting



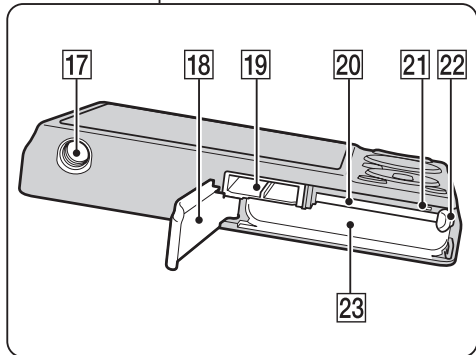
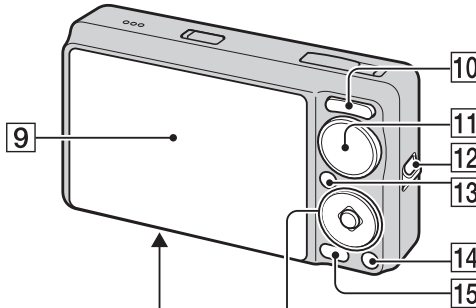
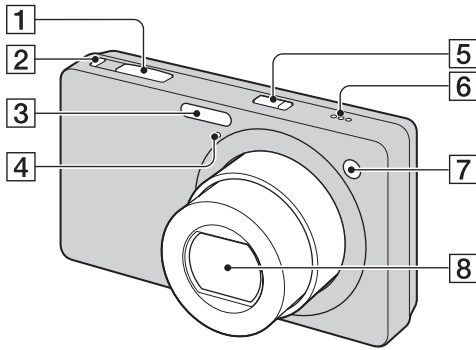

## Notes

- [Shooting Settings] appears only when settings have been entered from shooting mode.
- [“Memory Stick” Tool] appears only when a “Memory Stick Duo” media is inserted in the camera, while [Internal Memory Tool] appears only when a “Memory Stick Duo” media is not inserted.

# Identifying parts



- 1 Shutter button
- 2  (Burst/Bracket) button (35)
- 3 Flash
- 4 Microphone
- 5 ON/OFF (Power) button
- 6 Speaker
- 7 Self-timer lamp/Smile Shutter lamp/AF illuminator
- 8 Lens
- 9 LCD screen

- 10 For shooting: W/T (zoom) button (31)  
For viewing: Q (Playback zoom) button/  
 (Index) button (38, 39)
- 11 Mode dial (16)
- 12 Hook for wrist strap\*
- 13  (Playback) button (37)
- 14  (Delete) button (40)
- 15 MENU button (10)
- 16 Control button  
Menu on:   
Menu off: DISP/
- 17 Tripod receptacle
- 18 Battery/"Memory Stick Duo" media cover
- 19 Multi connector
- 20 "Memory Stick Duo" media slot
- 21 Access lamp
- 22 Battery eject lever
- 23 Battery insertion slot

## \* Using the wrist strap

Attach the strap and place your hand through the loop to prevent the camera from damage by being dropped.

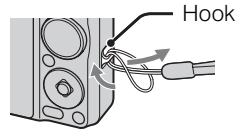

# List of icons displayed on the screen

Icons are displayed on the screen to indicate the camera status.

You can change the screen display using DISP (Screen Display Settings) on the control button.

## When shooting still images

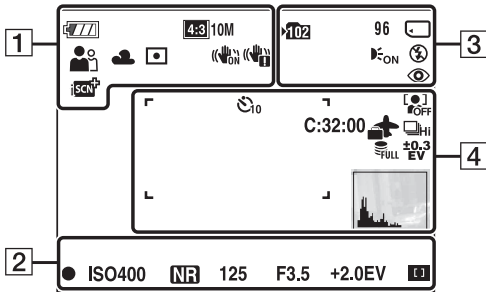

- The icons are limited in EASY (Easy Shooting) mode.

## When shooting movies

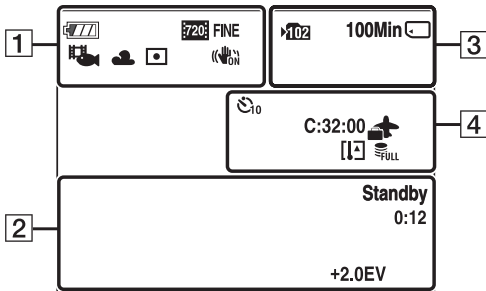

## When playing back

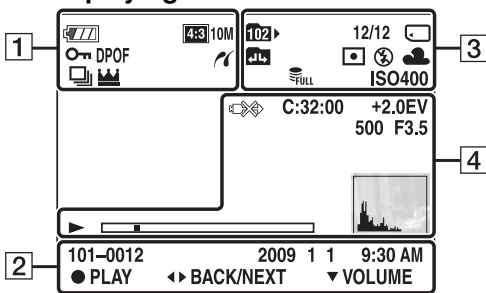

1

Display	Indication
	Battery remaining
	Low battery warning
	Image size
	Scene Selection
	Mode dial (Intelligent Auto Adjustment, Program Auto, Sweep Panorama, Anti Motion Blur, Hand-held Twilight, Movie Mode)
	Scene Recognition icon
	Movie shooting mode
	White balance
	Metering Mode
	SteadyShot
	Vibration warning
	Scene Recognition
	DRO
	Smile Detection Sensitivity indicator

Display	Indication
x1.4 s Q P Q	Zoom scaling
	PictBridge connecting
	Protect
DPOF	Print order (DPOF)
Q x2.0	Playback zoom
	Display burst group
	Main image in the burst group

2

Display	Indication
	AE/AF lock
ISO400	ISO number
NR	NR slow shutter
125	Shutter speed
F3.5	Aperture value
+2.0EV	Exposure Value
	AF range finder frame indicator
REC Standby	Recording a movie/Standby a movie
0:12	Recording time (m:s)
101-0012	Folder-file number
2009 11 9:30 AM	Recorded date/time of the playback image
STOP PLAY	Function guide for playing image
	Selecting images
	Adjusting volume

3

Display	Indication
	Recording folder
	Playback folder
96	Number of recordable images
12/12	Image number/Number of images recorded in selected folder
100Min	Recordable time
	Recording/Playback Media ("Memory Stick Duo" media, internal memory)
	Changing folder
	AF illuminator
	Red-eye reduction
	Metering mode

Display	Indication
	Flash mode
	Flash charging
	White balance
ISO 400	ISO number
	Database file full

4

Display	Indication
	Self-timer
C:32:00	Self-diagnosis display
	Destination
	Overheating warning
	Face Detection
	Burst/Bracket
	Database file full
	Bracket Settings
	AF range finder frame
	Spot metering cross hair
+2.0EV	Exposure value
500	Shutter speed
F3.5	Aperture value
	PictBridge connecting
	Playback
	Playback bar
35° 37' 32" N 139° 44' 31" E	Latitude and Longitude display
	Histogram •  appears when histogram display is disabled.
	Volume

# Using the mode dial

Set the mode dial to the desired function.

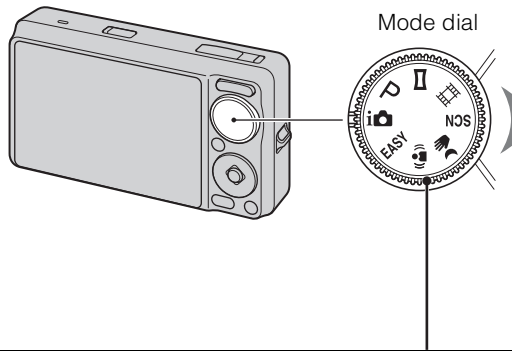







<b>i</b> (Intelligent Auto Adjustment)	Allows you to shoot with the settings adjusted automatically (page 20).
<b>EASY (Easy Shooting)</b>	Allows you to shoot/view still images with easy-to-see indicators (page 21).
<b>P (Program Auto)</b>	Allows you to shoot with the exposure adjusted automatically (both the shutter speed and the aperture value) (page 23). You can set various functions using the menu.
<b>⌂ (Sweep Panorama)</b>	Allows you to shoot a panoramic image after composing images (page 24).
<b>((⊂)) (Anti Motion Blur)</b>	Allows you to shoot with reduced blur without using the flash when composing burst shots taken in high-speed (page 26).
<b>☾☞ (Hand-held Twilight)</b>	Allows you to shoot with reduced blur in low light scenes without tripod when composing burst shots taken in high-speed (page 27).
<b>SCN (Scene Selection)</b>	Allows you to shoot with preset settings according to the scene (page 28).
<b>🎞 (Movie Mode)</b>	Allows you to record movies with audio (page 30).

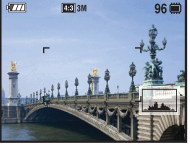

# Changing the DISP (Screen Display Settings)

- 1 Press DISP (Screen Display Settings) on the control button.
- 2 Select the desired mode with the control button.

	 <b>(Bright + Image Only)</b>	Sets screen brighter and displays only images.	
	 <b>(Bright + Histogram)</b>	Sets screen brighter and displays a graph of the image brightness. Image information is also displayed during playback.	
	 <b>(Bright)</b>	Sets screen brighter and displays the information.	
✓	 <b>(Normal)</b>	Sets screen to standard brightness and displays the information.	

## Note

- If you view images in bright outside light, adjust the screen brightness up. However, the battery power may decrease faster under such condition.

# Histogram

A histogram is a graph showing the brightness of an image. The graph display indicates a bright image when skewed to the right side, and a dark image when skewed to the left side.

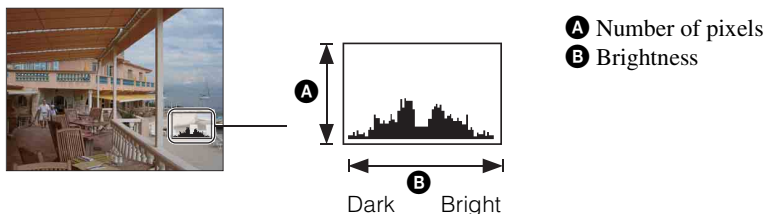

- 1 Press DISP (Screen Display Settings) on the control button, then select [Bright + Histogram].

## Notes

- The histogram also appears when playing back a single image, but you cannot adjust the exposure.
- The histogram does not appear when:
  - Recording movies
  - Playing back movies
  - Viewing vertical orientation images
  - Rotating still images
  - Shooting with Sweep Panorama
  - Viewing images shot with Sweep Panorama
  - Viewing main images
- A large difference in the histogram displayed during shooting and playback may occur when:
  - The flash strobes.
  - The shutter speed is slow or fast.
- The histogram may not appear for images recorded using other cameras.

# Using the internal memory

The camera has approximately 11 MB of internal memory. This memory is not removable. Even when there is no “Memory Stick Duo” media inserted in the camera, you can record images using this internal memory.

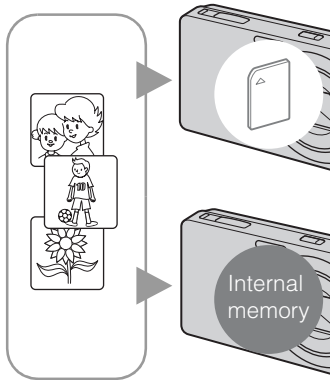

## When a “Memory Stick Duo” media is inserted

**[Recording]:** Images are recorded on the “Memory Stick Duo” media.

**[Playback]:** Images on the “Memory Stick Duo” media are played back.

**[Menu, Settings, etc.]:** Various functions can be performed on images on the “Memory Stick Duo” media.

## When there is no “Memory Stick Duo” media inserted

**[Recording]:** Images are recorded using the internal memory.

**[Playback]:** Images stored in the internal memory are played back.

**[Menu, Settings, etc.]:** Various functions can be performed on images in the internal memory.

## On image data stored in the internal memory

We recommend that you copy (back up) data without error using one of the following methods.

### To copy (back up) data on a hard disk of your computer

Perform the procedure on pages 108 to 109 without a “Memory Stick Duo” media inserted in the camera.

### To copy (back up) data on a “Memory Stick Duo” media

Prepare a “Memory Stick Duo” media with sufficient free capacity, then perform the procedure explained in [Copy] (page 97).

### Notes

- You cannot transfer image data on a “Memory Stick Duo” media to the internal memory.
- By making a USB connection between the camera and a computer with a cable for multi-use terminal, you can transfer data stored in the internal memory to a computer. However you cannot transfer data on a computer to the internal memory.

# Intelligent Auto Adjustment

Allows you to shoot still images with the setting adjusted automatically.

- 1 Set the mode dial to **i**  (Intelligent Auto Adjustment).
- 2 Shoot with the shutter button.

## Note









- Flash mode is set to [Auto] or [Off].

## On Scene Recognition

Scene Recognition operates in Intelligent Auto Adjustment mode. This function lets the camera automatically recognize the shooting conditions and shoot the image.



Scene Recognition icon (Guide)

The camera recognizes  (Twilight),  (Twilight Portrait),  (Twilight using a tripod),  (Backlight),  (Backlight Portrait),  (Landscape),  (Macro) or  (Portrait), and displays the corresponding icon and guide on the LCD screen when the scene is recognized. For details, see page 58.

## If you shoot a still image of a subject that is difficult to focus on

- The shortest shooting distance is approximately 5 cm (2 inches) (W), 50 cm (19 3/4 inches) (T) (from the lens).
- When the camera cannot focus on the subject automatically, the AE/AF lock indicator changes to flash slowly and the beep does not sound. Either recompose the shot or change the focus setting (page 54).

### **Focusing may be difficult in the following situations:**

- It is dark and the subject is distant.
- The contrast between the subject and the background is poor.
- The subject is seen through glass.
- The subject is moving quickly.
- There is reflective light or shiny surfaces.
- The subject is backlit or there is a flashing light.

# Easy Shooting

Allows you shoot still images using the minimum necessary functions.  
The text size increases and indicators become easier to see.

- 1 Set the mode dial to **EASY** (Easy Shooting).
- 2 Shoot with the shutter button.

## Note

- The battery charge is used up more quickly because the screen brightness increases automatically.

## 💡 Functions available in Easy Shooting mode

**Image Size:** MENU → [Image Size] → ● on the control button → desired mode → ●

Select between [Large] or [Small] size.

**Self-Timer:** ⌚ on the control button → desired mode  
Select between [10sec] or [Off] mode.

**Flash:** ⚡ on the control button → desired mode  
Select between [Auto] or [Off] mode.

MENU → [Flash] → ● on the control button → desired mode → ●

Select between [Auto] or [Off] mode.

**Smile Shutter:** 😊 on the control button

## 💡 On Scene Recognition

Scene Recognition operates in Easy Shooting mode. This function lets the camera automatically recognize the shooting conditions and shoot the image.





Scene Recognition icon

The camera recognizes 🌙 (Twilight), 🌃 (Twilight Portrait), 📷 (Twilight using a tripod), 🌅 (Backlight), 🌃 (Backlight Portrait), 🏔️ (Landscape), 🌸 (Macro) or 🧑 (Portrait), and displays an icon on the LCD screen when the scene is recognized.

For details, see page 58.

## On Easy Viewing mode

When you press the  (Playback) button with the mode dial set to **EASY** (Easy Shooting), the playback screen text becomes larger and easier to see. In addition, the functions that can be used are limited.

 **(Delete) button**      You can delete the currently displayed image.  
Select [OK] → ●.

**MENU button**      You can delete the currently displayed image with [Delete Single Image], delete all images in a folder with [Delete All Images].

- View Mode is set to [Folder View]. If you set the mode dial to a mode other than **EASY** (Easy Shooting), then playback images, the images are displayed in the preselected View Mode.

# Program Auto

Allows you to shoot with the exposure adjusted automatically (both the shutter speed and the aperture value). Also you can select various settings using the menu.

- 1 Set the mode dial to P (Program Auto).
- 2 Shoot with the shutter button.

# Sweep Panorama

Allows you to create a panoramic image from composed images.

- 1 Set the mode dial to  (Sweep Panorama).
- 2 Hold the camera at the position where you can see the LCD screen clearly, then press the shutter button fully down.
- 3 Pan the camera to the end, following the guidance on the LCD screen.

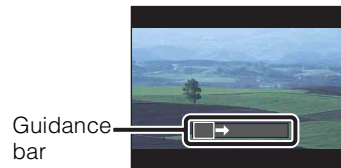

## Notes

- If you cannot pan the camera across the entire subject within the given time, a gray area occurs in the composed image. If this happens, move the camera fast to record a full panoramic image.
- Since several images are stitched together, the stitched part will not be recorded smoothly.
- Under low light conditions, panoramic images may be blurred.
- Under lights that flicker such as fluorescent light, the brightness or color of the combined image is not always the same.
- When the whole angle of panoramic shooting and the locked angle are extremely different in brightness, color and focus, the shooting will not be successful. If this happens, change lock angle and shoot again.
- Sweep Panorama is not suitable for the following situations:
  - Objects are moving
  - Objects are too close to the camera
  - Image with a repeating pattern such as tiles and image with little contrast such as sky, sandy beach, or lawn
  - Image with constant change such as waves or water falls
- You cannot create panoramic images in the following situations:
  - You pan the camera too fast or too slow
  - There is too much camera shake

## Changing the shooting direction or image size of a panoramic image

**Shooting Direction:** MENU → [Shooting Direction] → select [Right], [Left], [Up] and [Down] → ●

**Image Size:** MENU → [Image Size] → select [Standard] or [Wide] → ●



## 💡 Tips for shooting a panoramic image

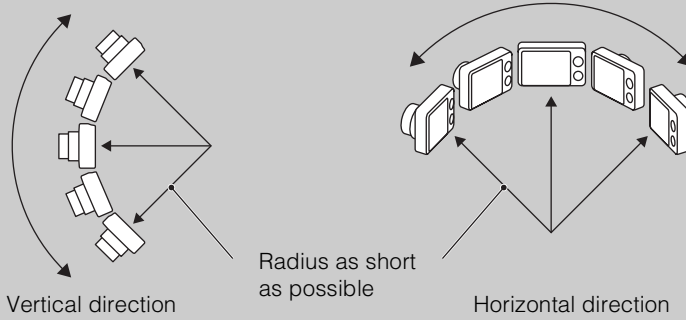

- Pan the camera in an arc with a constant velocity.
- Pan the camera in the same direction as the indication on the LCD screen.
- Determine the scene and press the shutter button halfway, so that you can lock the exposure and white balance.
- Adjust the frame composition so that a portion with greatly varied scenery is in the center of the image.

## 💡 Playing back scrolling panoramic images

You can scroll panoramic images by pressing ● on the control button while panoramic images are being displayed.



Shows the displayed area of the whole panoramic image

Operation button	Description
● (on the control button)	Plays back scrolling images/ Stops
◀/▶/▲/▼ (on the control button)	Scrolls images
W (zoom) button	Displays the whole image

- Panoramic images are played back with the supplied software “PMB” (page 105).

# Anti Motion Blur

This is suitable for indoor shots without using the flash to reduce the subject blur.

1 Set the mode dial to  (Anti Motion Blur).

2 Fully press the shutter button.

A series of burst shots are taken, and image processing is applied to reduce subject blur and noise.

## Notes

- The shutter sound beeps 6 times and an image is recorded.
- Reducing blur does not effective in the following situations:
  - Image with large-scale movement
  - Image with a main subject too close to the camera
  - Image with little contrast such as sky, sandy beach, or lawn
  - Image with constant change such as waves or water falls
- Smile Shutter cannot be used.
- When using a light source that flickers, such as fluorescent lighting, block noise may occur. In these cases, set Scene Selection to  (High Sensitivity).

# Hand-held Twilight

Although night scenes tend to blur by camera shake, this mode allows you to shoot night scenes with less noise and blur without using a tripod.

- 1 Set the mode dial to  (Hand-held Twilight).
- 2 Fully press the shutter button.

A series of burst shots are taken, and image processing is applied to reduce camera shake and noise.

## Notes



- The shutter sound beeps 6 times and an image is recorded.
- Reducing blur is less effective in the following situations:
  - Image with large-scale movement
  - Image with a main subject too close to the camera
  - Image with little contrast such as sky, sandy beach, or lawn
  - Image with constant change such as waves or water falls
- Smile Shutter cannot be used.
- When using a light source that flickers, such as fluorescent lighting, block noise may occur. In these cases, set Scene Selection to  (High Sensitivity).

# Scene Selection



Allows you to shoot with preset settings according to the scene.

- 1 Set the mode dial to **SCN** (Scene Selection).
- 2 Select the desired mode → ● on the control button.  
If you want to switch to another scene, press the MENU button.

 <b>(High Sensitivity)</b>	Allows you to shoot images without a flash under low light conditions, reducing blur.	
 <b>(Soft Snap)</b>	Allows you to shoot images with a softer atmosphere for portraits and flowers, etc.	
 <b>(Landscape)</b>	Allows easy shooting of distant scenes by focusing in the distance. Shoots vivid blue sky and flora colors.	
 <b>(Twilight Portrait)</b>	Allows you to shoot sharp images of people with the night view in the background without compromising the atmosphere.	
 <b>(Twilight)</b>	Allows you to shoot night scenes at far distance without losing the dark atmosphere of the surroundings.	
 <b>(Gourmet)</b>	Shifts to Macro mode, allowing you to shoot food arrangements in delicious and bright color.	
 <b>(Pet)</b>	Allows you to shoot images of your pet with the best settings.	
 <b>(Beach)</b>	Allows you to record the blue of the water clearly when shooting seaside or lakeside scenes.	
 <b>(Snow)</b>	Allows you to record clear images preventing sunken colors in snowy scenes or other places where the whole screen appears white.	
 <b>(Fireworks)</b>	Allows you to record fireworks in all their splendor.	

 <b>(Underwater)</b>	Allows you to shoot underwater in natural colors in housing (Marine pack, etc.).	
--	--	---

























### Note

- When you shoot images using  (Twilight Portrait),  (Twilight) or  (Fireworks) mode, the shutter speed is slower and the images tend to blur. To prevent blurring, the use of a tripod is recommended.

## Functions you can use in Scene Selection

For shooting an image appropriately according to the scene condition, a combination of functions is determined by the camera. ✓ indicates an available function. The icons below [Flash] indicate the available flash modes.

Some functions are not available, depending on the Scene Selection mode.

	Flash	Face Detection/ Smile Shutter	Burst/ Bracket	White Balance	Red Eye Reduction	Anti Blink	Steady-Shot
ISO		✓	—	✓* <sup>1</sup>	—	—	✓
	✓	✓* <sup>2</sup>	✓	—	✓	✓	✓
	 	—	✓	—	✓	—	✓
	 SL	✓	—	—	✓	—	✓
		—	—	—	—	—	✓
	 	—	—	✓	—	—	—
	 	—	—	✓	—	—	✓
	 	✓	✓	—	✓	—	✓
	 	✓	✓	—	✓	—	✓
		—	—	—	—	—	✓
	 	—	✓	✓* <sup>3</sup>	—	—	✓

\*<sup>1</sup> [Flash] for [White Balance] cannot be selected.

\*<sup>2</sup> [Off] for [Face Detection] cannot be selected.

\*<sup>3</sup> You can use [Underwater White Balance] instead of [White Balance].

# Movie Mode

Allows you to record movies with audio.

- 1 Set the mode dial to  (Movie Mode).
- 2 Press the shutter button fully down.
- 3 To stop recording, press the shutter button fully down again.

# Zoom

You can enlarge the image when shooting. The camera's optical zoom function can enlarge images up to 5×.

## 1 Press the W/T (zoom) button.

Press the T button to zoom in, and the W button to zoom out.

- When the zoom scale exceeds 5×, see page 80.

**T button**



**W button**







### Notes

- Zoom is fixed to the W side when shooting in Sweep Panorama mode.
- The operating sound of the lens might be recorded while shooting a movie.

# Flash

- 1 Press  (Flash) on the control button.
- 2 Select the desired mode with the control button.

✓	 <b>AUTO (Auto)</b>	Flash automatically operates in dark locations or when there is backlight.
	 <b>(On)</b>	Flash always operates.
	 <b>SL (Slow Synchro)</b>	Flash always operates. The shutter speed is slow in a dark place to clearly shoot the background that is out of flash light.
	 <b>(Off)</b>	Flash does not operate.

## Notes

- The flash strobes twice. The first flash adjusts the light quantity.
- While charging the flash,  is displayed.
- You cannot use the flash during burst or bracket shooting.
- [On] and [Slow Synchro] are not available when the camera is in Intelligent Auto Adjustment mode.
- In Easy Shooting mode, you can select only [Auto] or [Off].
- In Anti Motion Blur, Hand-held Twilight or Sweep Panorama, flash is set to [Off].

## When the “White circular spots” appears in flash photos

This is caused by particles (dust, pollen, etc.) floating close to the lens. When they are accentuated by the camera’s flash, they appear as white circular spots.

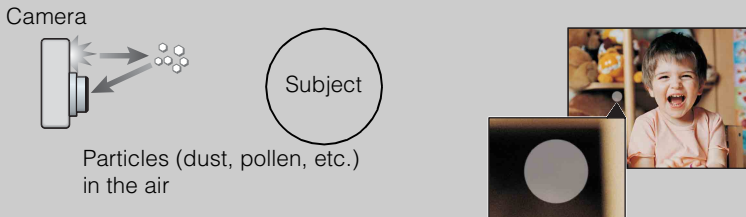

### How can the “White circular spots” be reduced?

- Light the room and shoot the subject without a flash.
- Select  (High Sensitivity) mode in Scene Selection. ([Off] is automatically selected.)



# Smile Shutter

When the camera detects a smile, the shutter is released automatically.

1 Press 😊 (Smile) on the control button.

2 Wait detecting a smile.

When the smile level exceeds the ◀ point on the indicator, the camera records images automatically.

If you press the shutter button during Smile Shutter, the camera shoots the image, then returns to Smile Shutter mode.

3 To stop shooting, press 😊 (Smile) again.

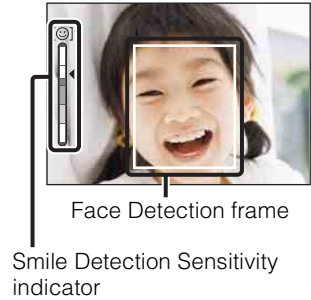

## Notes

- Shooting using the Smile Shutter ends automatically when either the “Memory Stick Duo” media or internal memory becomes full.
- Smiles may not be detected correctly depending on the conditions.
- You cannot use the digital zoom function.
- If Anti Motion Blur, Hand-held Twilight, Sweep Panorama or Movie Mode is selected, you cannot use the Smile Shutter function.

## 💡 Hints for better capturing of smiles

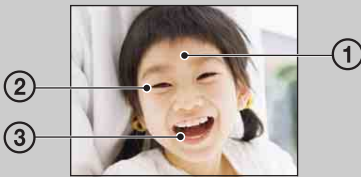





- ① Do not cover the eyes with the bangs. Do not obscure the face by hat, masks, sunglasses, etc.
- ② Try to orient the face in front of the camera and be as level as possible. Keep the eyes narrowed.
- ③ Give a clear smile with an open mouth. The smile is easier to detect when the teeth are shown.

- The shutter operates when any person whose face is being detected smiles.
- You can select or register the priority subject for face detection with [Face Detection]. When the selected-face is registered in the camera memory, Smile Detection is performed only for that face. To perform smile detection for a different face, change the priority face with ● on the control button (page 61).
- If a smile is not detected, set the [Smile Detection Sensitivity] in setting menu.

# Self-Timer

- 1 Press  (Self-Timer) on the control button.
- 2 Select the desired mode with the control button.

✓	 OFF (Off)	Does not use the self-timer.
	 10 (10sec)	Sets the 10-second delay self-timer. When you press the shutter button, the self-timer lamp flashes and a beep sounds until the shutter operates. To cancel, press  again.
	 2 (2sec)	Sets the 2-second delay self-timer.

## Notes

- In Easy Shooting mode, you can select only [10sec] or [Off].
- The self-timer is not valid when shooting in Sweep Panorama mode.









## Reducing blurring with the two-second self-timer

Use the 2-second delay self-timer to prevent blur of an image. The shutter is released 2 seconds after you press the shutter button, which reduces camera shake when the shutter button is pressed.

# Burst/Bracket

You can select normal (single-image), burst or exposure bracket mode. You can also select the mode from the MENU button (page 47).

- 1 Press the  (Burst/Bracket) button.
- 2 Select a shooting mode with the  (Burst/Bracket) button.  
You can also select the shooting mode with the control button.

✓	 <b>OFF (Off)</b>	Shoots a single image.
	 <b>Hi (High)</b>	Shoots up to 10 images per second in succession.
	 <b>Mid (Mid)</b>	Shoots up to 5 images per second in succession.
	 <b>Lo (Low)</b>	Shoots up to 2 images per second in succession.
	<b>BRK (Bracket)</b>	<p>Shoots a series of 3 images with the exposure values automatically shifted. For details on the bracket setting, see page 57.</p> <p><b>Notes</b></p> <ul style="list-style-type: none"><li>• Exposure bracket mode is not available in Intelligent Auto Adjustment, Easy Shooting, Movie Mode, Hand-held Twilight, Anti Motion Blur, Sweep Panorama, or Smile Shutter.</li><li>• The flash is set to [Off].</li><li>• The focus and white balance are adjusted for the first image, and these settings are also used for the other images.</li><li>• When you adjust the exposure manually, the exposure is shifted based on the adjusted brightness.</li><li>• The recording interval becomes longer according to the shooting conditions.</li><li>• If the subject is too bright or too dark, you may not be able to shoot properly with the selected bracket step value.</li><li>• [VGA] image size will be set while recording on internal memory.</li></ul>

## Burst shooting

Shoots up to 10 images in succession when you hold down the shutter button.

- 1 Press the  (Burst/Bracket) button.
- 2 Select [High], [Mid] or [Low].
- 3 Press the shutter button.

### Notes

- Burst shooting is not available in Easy Shooting, Sweep Panorama, Anti Motion Blur, Hand-held Twilight, Movie Mode, or Smile Shutter.
- The flash is set to [Off].
- When burst shooting with the self timer, a series of a maximum of 5 images is shot.
- In slow shutter speed conditions, the burst of shots per second may be decreased.
- [VGA] image size will be set while recording on internal memory.
- When the battery level is low, or when the internal memory or “Memory Stick Duo” media is full, the burst shooting stops.
- The focus, white balance and exposure are fixed to the adjusted value for the first image.



## About the recording of burst shooting images

After shooting burst images, the shot images are displayed in frames on the LCD screen.

When all the images are fitted in the frames, recording completes.

You can stop the recording by selecting [OK] with  on the control button.

When stopped, the image displayed in index and images in the image processing are recorded.

Table of  
contents

Operation  
Search

MENU/Settings  
Search

Index

# Viewing still images

- 1 Press the  (Playback) button to switch to playback mode.
- 2 Select an image with the control button.

## Note

- When the mode dial is set to **EASY** (Easy Shooting), the images are played back in Folder View, and the available function are limited. If you want to use all viewing functions, set the mode dial to a mode other than **EASY**.



## Viewing images taken with a different camera

If you insert into this camera a “Memory Stick Duo” media containing images taken both with this camera and another camera, a screen for selecting the playback method appears.

**“Playback only registered images”**: Images are played in the selected View Mode. Some images taken with other cameras may not be played back.

**“Playback all images with folder view”**: View Mode is switched to Folder View and all images are played back.

# Playback zoom

Plays back the enlarged image.

- 1 Press **Q** (Playback zoom) button during still image playback.

The image is enlarged to twice the previous size, at the center of the image.

- 2 Adjust the position with the control button.
- 3 Change the zoom scale with **W/T** (zoom) button.

Press **Q** button (**T**) to zoom in, **W** side to zoom out.  
Press **●** to cancel playback zoom.





Shows the displayed area of the whole image

## To save enlarged images

You can save an enlarged image by using the trimming function.  
Press **MENU** → [Retouch] → [Trimming].

# Image Index

Displays multiple images at the same time.



- 1 Press the  (Playback) button to switch to playback mode.
- 2 Press the  (Index) button to display the image index screen.  
Press the button again to display an index screen with even more images. Press the button yet again to view images with the Calendar.
- 3 To return to the single-image screen, select an image with the control button, then press .

## Note

- When the mode dial is set to **EASY** (Easy Shooting), you cannot view images in index mode.

## Displaying images of the desired date/folder





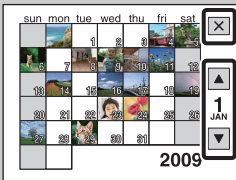

Select the left side bar with the control button, then select the desired date/folder with /.

## Viewing images with the Calendar



You can press the  (Index) button to view images with the Calendar during list display in Date View.



- Select the month you want to display with /.
- To exit from the Calendar, select  with the control button, then press .

# Delete

Allows you to select unwanted images for deletion. You can also delete images from the MENU button (page 73).

- 1 Press the  (Playback) button to switch to playback mode.
- 2  (Delete) button → desired mode → ● on the control button

<b>This Image</b>	Deletes the currently displayed image in single-image mode.
<b>Multiple Images</b>	Allows you to select and delete multiple images. Do as the following after step 2. ① Select an image then press ●. Repeat the above steps until there are no more images to be deleted. Select an image with a ✓ mark again to release the ✓ mark. ② MENU → [OK] → ●
<b>All in This Folder</b> <b>All in Date Range</b> <b>All In This Group</b>	Deletes all images in the selected folder, date range or burst group at once. Press [OK] → ● after step 2.
<b>All but this image</b>	Deletes burst group images other than the selected image in Display Burst Group mode.
<b>Exit</b>	Cancels the deletion.

## Notes

- When the mode dial is set to **EASY** (Easy Shooting), you can delete only the currently displayed image.
- When the internal memory is used to record images, View Mode is set to [Folder View].

 You can switch between index and single-image mode when selecting images











Press the **Q** button (T) of the W/T (zoom) button in index mode to return to single-image mode, and press the  (Index) button (W) in single-image mode to return to index mode.

- You can also switch between index and single-image mode in [Protect] or [DPOF].



# Viewing movies



- 1 Press the  (Playback) button to switch to playback mode.
  - 2 Select a movie with the control button.
  - 3 Press .
- Movie playback starts.

Control button	Playback feature
	Pause
	Fast forward
	Fast rewind
	Displays the volume control screen. Adjust the volume with  /  .

## Note



- You may not be able to play back some images shot using other cameras.

## On the movie viewing screen

Select the image you want to display using / on the control button, and press . The Playback bar appears, you can check a playback position of a movie.







Playback bar

 FINE,  STD or  VGA appears on the movie viewing screen. The icon displayed may vary depending on image size and quality.

# Movie shooting mode

Allows you to shoot movies with preset settings according to the scene.





- 1 Set the mode dial to  (Movie Mode).
- 2 MENU →  (Movie shooting mode) → desired mode

✓	 <b>(Auto)</b>	Adjusts the setting automatically.
	 <b>(Underwater)</b>	Shoots underwater in natural colors when using a water proof housing (Marine pack, etc.).

# Shooting Direction

Set the direction to pan the camera when you shoot a Sweep Panorama images.

- 1 Set the mode dial to  [Sweep Panorama].
- 2 MENU →  (Shooting Direction) → desired direction









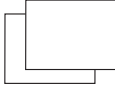

✓	 <b>(Right)</b>	Pan from left to right.
	 <b>(Left)</b>	Pan from right to left.
	 <b>(Up)</b>	Pan from down to up.
	 <b>(Down)</b>	Pan from up to down.

# Image Size

The image size determines the size of the image file that is recorded when you take a image. The larger the image size, the more detail will be reproduced when the image is printed on large-format paper. The smaller the image size, the more images can be recorded.

1 MENU →  (Image Size) → desired size

## When shooting still images

	Image size	Usage guidelines	No. of images	Printing
✓	 (3648×2736) 10M	For prints up to A3+ size	Less 	Fine 
	 (2592×1944) 5M	For prints up to A4 size	↑ ↓	↑ ↓
	 (2048×1536) 3M	For prints up to L/2L size		
	 (640×480) VGA	For e-mail attachments	More 	Rough 
	 (3648×2432) 8M	3:2 aspect ratio as in photo prints and postcards	Less	Fine
	 (3648×2056) 7M	For viewing on a high-definition TV	↑ ↓	↑ ↓
	 (1920×1080) 2M			



### Note

- When you print images recorded with 16:9 aspect ratio, both edges may be cut off.

## In Easy Shooting mode

✓	<b>Large</b>	Shoots images in [10M] size.
	<b>Small</b>	Shoots images in [3M] size.



## When shooting Sweep Panorama images

✓	 <b>(Standard)</b> <small>STD</small> <b>(Vertical direction: 3424×1920)</b> <b>(Horizontal direction: 4912×1080)</b>	Shoot images using standard size.
	 <b>(Wide)</b> <small>WIDE</small> <b>(Vertical direction: 4912×1920)</b> <b>(Horizontal direction: 7152×1080)</b>	Shoot images using wide size.

## When shooting movies

The larger the image size, the higher the image quality. The higher the amount of data used per second (average bit rate), the smoother the playback image.

The movies shot with this camera will be recorded in MPEG-4, Approx. 30fps, Progressive, AAC, mp4 format.

	Movie image size	Average bit rate	Usage guidelines
✓	 <b>1280×720(Fine)</b> <small>FINE</small>	9 Mbps	Shoot highest quality movie for display on HDTV
	 <b>1280×720(Standard)</b> <small>STD</small>	6 Mbps	Shoot standard quality movie for display on HDTV
	 <b>VGA</b>	3 Mbps	Shoot at an image size suitable for WEB upload

### Notes

- A telephoto image results when the [VGA] image size is selected for movies.
- Movies with the size set to [1280×720] can only be recorded on a “Memory Stick PRO Duo” media. When using recording media other than “Memory Stick PRO Duo” media, set the movie image size to [VGA].

## 💡 On “image quality” and “image size”

A digital image is made up of a collection of small dots called pixels. If it contains a large number of pixels, the image becomes large, it takes up more memory, and the image is displayed in fine detail. “Image size” is shown by the number of pixels. Although you cannot see the differences on the screen of the camera, the fine detail and data processing time differ when the image is printed or displayed on a computer screen.

### Description of the pixels and the image size

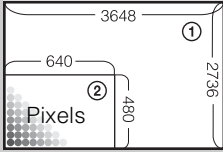

- ① Image size: 10M  
3648 pixels × 2736 pixels = 9,980,928 pixels
- ② Image size: VGA  
640 pixels × 480 pixels = 307,200 pixels

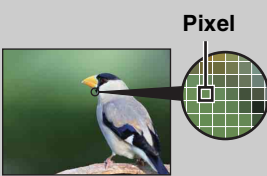

Pixel



#### Many pixels

(Fine image quality and large file size)







#### Few pixels

(Rough image quality but small file size)

# Burst

You can select normal (single-image), burst or exposure bracket mode. You can also select the mode from the  (Burst/Bracket) button (page 35).

1 MENU →  (Burst) → desired mode

✓	 <b>(Off)</b>	Shoots a single image.
	 <b>(High)</b>	Shoots up to 10 images per second in succession.
	 <b>(Mid)</b>	Shoots up to 5 images per second in succession.
	 <b>(Low)</b>	Shoots up to 2 images per second in succession.
	<b>BRK (Bracket)</b>	Shoots a series of 3 images with the exposure values automatically shifted. For details on the bracket setting, see page 57.

# Flash

In Easy Shooting mode, you can select the Flash setting also from the MENU button.

- 1 Set the mode dial to **EASY** (Easy Shooting).
- 2 MENU → [Flash] → ● on the control button
- 3 Select the desired mode → ●.

✓	<b>Auto</b>	Flash automatically operates in dark locations or when there is backlight.
	<b>Off</b>	Does not use the flash.



# EV

You can adjust the exposure manually in 1/3 EV steps in a range of -2.0 EV to +2.0 EV.

1 MENU → 0EV (EV) → desired EV setting

## Notes

- In Easy Shooting mode, the EV setting cannot be adjusted.
- If you shoot a subject in extremely bright or dark conditions, or when you use the flash, the exposure adjustment may not be effective.

## Adjusting the exposure for better looking images



Overexposure = too much light  
Whitish image



**Lower EV setting -**



Correct exposure



**Higher EV setting +**



Underexposure = too little light  
Darker image

# ISO

Adjusts the luminous sensitivity.

- 1 Set the mode dial to P (Program Auto) or **SCN** (Scene Selection) →  (Underwater).
- 2 MENU →  $\overset{\text{ISO}}{\text{AUTO}}$  (ISO) → desired mode

✓	<b>ISO AUTO (Auto)</b>	Sets the ISO sensitivity automatically.
	ISO / ISO / ISO / 160 / 200 / 400 / ISO / ISO / ISO 800 / 1600 / 3200	You can reduce image blurring in dark locations or moving subjects by increasing ISO sensitivity (select a larger number).

## Note

- ISO settings other than [ISO AUTO], [ISO 160] to [ISO 800] cannot be selected when the recording mode is set to Burst or Exposure Bracket mode, or when [DRO] is set to [DRO plus].

## Adjusting ISO Sensitivity (Recommended Exposure Index)

ISO sensitivity is a speed rating for recording media that incorporates an image sensor that receives light. Even when the exposure is the same, images differ depending on the ISO sensitivity.



### High ISO sensitivity

Records a bright image even in dark locations while increasing shutter speed to reduce blur. However, the image tends to become noisy.



### Low ISO sensitivity

Records a smoother image. However, when the exposure is insufficient, the image may become darker.

# White Balance

Adjusts color tones according to the surrounding light conditions. Use this function if image color appears unnatural.

1 MENU →  $\frac{WB}{AUTO}$  (White Balance) → desired mode

✓	$\frac{WB}{AUTO}$ (Auto)	Adjusts the white balance automatically so that the colors appear natural.
	☀ (Daylight)	Adjusts for outdoors conditions on a fine day, evening views, night scenes, neon signs, fireworks, etc.
	☁ (Cloudy)	Adjusts for a cloudy sky or a shady location.
	☀ <sub>1</sub> (Fluorescent White Balance 1) ☀ <sub>2</sub> (Fluorescent White Balance 2) ☀ <sub>3</sub> (Fluorescent White Balance 3)	[Fluorescent White Balance 1]: Adjusts for white fluorescent lighting. [Fluorescent White Balance 2]: Adjusts for natural white fluorescent lighting. [Fluorescent White Balance 3]: Adjusts for day white fluorescent lighting.
	💡 (Incandescent)	Adjusts for places under incandescent lamp, or under bright lighting, such as in a photo studio.
	⚡ <sub>WB</sub> (Flash)	Adjusts for the flash conditions.
	📷 (One Push)	Adjusts the white balance depending on the light source. The white color memorized in [One Push Set] mode becomes the basic white color. Use this mode when [Auto] or other modes cannot be set the color properly.
	📷 <sup>SET</sup> (One Push Set)	Memorizes the basic white color which will be used in [One Push] mode.

## Notes

- [White Balance] cannot be adjusted in Intelligent Auto Adjustment, or Easy Shooting mode.
- You cannot adjust [Flash] in [White Balance] in Sweep Panorama, Hand-held Twilight, Anti Motion Blur, or Movie Mode, or when Scene Selection is set to  $\text{iso}$  (High Sensitivity) mode.
- Under fluorescent lights that flicker, the white balance function may not work correctly even though you select [Fluorescent White Balance 1], [Fluorescent White Balance 2], or [Fluorescent White Balance 3].
- When shooting with a flash in other than [Flash] mode, [White Balance] is set to [Auto].
- When flash is [On] or [Slow Synchro], the white balance can only be adjusted to [Auto], [Flash], [One Push], or [One Push Set].
- [One Push Set] is unable to be selected while charging the flash.

## To capture the basic white color in [One Push Set] mode





- 1 Frame a white object such as a piece of paper filling the screen under the same lighting conditions as you will shoot the subject.
- 2 MENU → [White Balance] → [One Push Set] → ● on the control button
- 3 The screen momentarily turns black, and when the white balance has been adjusted and stored in the memory, the recording screen is displayed again.

### Notes



- If the  indicator flashes while shooting, the white balance is either not set or cannot be set. Use automatic white balance.
- Do not shake or strike the camera while [One Push Set] is in progress.
- When flash mode is set to [On] or [Slow Synchro], the white balance is adjusted to the condition with the flash emitting.
- The white references loaded using [White Balance] and [Underwater White Balance] are stored separately.

### Effects of lighting conditions







The apparent color of the subject is affected by the lighting conditions. The color tones are adjusted automatically, but you can adjust color tones manually using the White Balance function.

Weather/lighting	Daylight	Cloudy	Fluorescent	Incandescent
Characteristics of light	White (standard) 	Bluish 	Green-tinged 	Reddish 

# Underwater White Balance

Adjusts the color tone when the camera is set to  (Underwater) mode or  (Underwater) for movies.

1 MENU →  (Underwater White Balance) → desired mode

	 <b>(Auto)</b>	Automatically adjusts color tones underwater so they appear natural.
	 <b>(Underwater 1)</b>	Adjusts for underwater conditions where blue is strong.
	 <b>(Underwater 2)</b>	Adjusts for underwater conditions where green is strong.
	 <b>(One Push)</b>	Adjusts the white balance depending on the light source. The white color memorized in [One Push Set] mode becomes the basic white color. Use this mode when [Auto] or other modes cannot be set the color properly.
	 <b>(One Push Set)</b>	Memorizes the basic white color which will be used in [One Push] mode (page 52).

## Notes

- Depending on the color of the water, the Underwater White Balance may not work correctly even though you select [Underwater 1] or [Underwater 2].
- When flash is [On] the underwater white balance can only be adjusted to [Auto], [One Push], or [One Push Set].
- [One Push Set] is unable to be selected while charging the flash.
- The white references loaded using [White Balance] and [Underwater White Balance] are stored separately.







# Focus

You can change the focus method. Use the menu when it is difficult to get the proper focus in auto focus mode.

AF stands for “Auto Focus,” a function that adjusts the focus automatically.

1 Set the mode dial to P (Program Auto) or  (Movie Mode).

2 MENU →  (Focus) → desired mode

✓	 (Multi AF)	<p>Focuses on a subject in all ranges of the finder frame automatically.</p> <p>When you press the shutter button halfway in still image shooting mode, a green frame is displayed around the area that is in focus.</p> <ul style="list-style-type: none"> <li>• When the Face Detection function is active, AF operates with priority on faces.</li> <li>• When Scene Selection is set to  (Underwater) mode, focus operation is suited to underwater shooting. When focus is achieved by half-pressing the shutter button, a large frame is displayed in green.</li> </ul>	 <p>AF range finder frame (Only for still image)</p>
	 (Center AF)	<p>Focuses on a subject in the center of the finder frame automatically. Using the AF lock function together, you can compose the image the way you want.</p>	 <p>AF range finder frame</p>
	 (Spot AF)	<p>Focuses on an extremely small subject or a narrow area automatically. Using the AF lock function together, you can compose the image the way you want. Hold the camera steady so as not to misalign the subject and the AF range finder frame.</p>	 <p>AF range finder frame</p>

## Notes

- When you use [Digital Zoom] or [AF Illuminator], the AF range finder frame is disabled and appears in a dotted line. In this case, the camera works to focus on the subjects at the center of the screen.
- When the focus mode is set to other than [Multi AF], you cannot use the Face Detection function.
- The focus mode is fixed to [Multi AF] in Easy Shooting, Anti Motion Blur, Hand-held Twilight, Movie Mode or Smile Shutter.

## Focusing on subjects near the edge of the screen

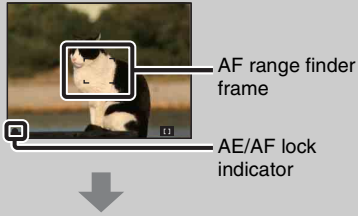

If the subject is out of focus, do as follows:







- ① Recompose the shot so that the subject is centered in the AF range finder, and press the shutter button halfway to focus on the subject (AF lock).
  - ② When the AE/AF lock indicator stops flashing and remains on, return to the fully composed shot, and press the shutter button fully down.
- As long as you do not press the shutter button fully down, you can retry the procedure as many times as necessary.

# Metering Mode

Selects the metering mode that sets which part of the subject to measure to determine the exposure.

- 1 Set the mode dial to P (Program Auto) or  (Movie Mode).
- 2 MENU →  (Metering Mode) → desired mode

✓	 <b>(Multi)</b>	Divides into multiple regions and measures each region. The camera determines a well-balanced exposure (Multi-pattern metering).
	 <b>(Center)</b>	Measures the center of the image, and determines the exposure based on the brightness of the subject there (Center-weighted metering).
	 <b>(Spot)</b>	Measures only a part of the subject (Spot metering). This function is useful when the subject is backlit or when there is strong contrast between the subject and the background.  <b>Spot metering cross hairs</b> Positions on the subject

## Notes

- In Movie Mode, [Spot] cannot be selected.
- If you set Metering Mode to other than [Multi], the Face Detection function cannot be used.
- Metering Mode is fixed to [Multi] in Easy Shooting or Smile Shutter.



# Bracket Settings

You can set the type of the bracket shooting using  (Burst/Bracket) button. In the bracket shooting mode, you can record a series of 3 images with the setting changed. You can select the most suitable image afterwards.

1 MENU → [Bracket Settings] → desired mode

✓	$\pm 0.3$ EV (EXP±0.3)	Records a series of 3 images with the exposure shifted in the following order: bright, standard, and dark. The larger the bracket step value, the larger the shift of the exposure value.
	$\pm 0.7$ EV (EXP±0.7)	
	$\pm 1.0$ EV (EXP±1.0)	

# Scene Recognition









The camera automatically detects shooting conditions, and then takes the shot. When motion is detected, the ISO sensitivity is increased according to the movement to reduce subject blur (Motion Detection).











Example of an image where  (Backlight) has activated.

## Scene Recognition icon (Guide)



The camera recognizes the following types of scenes. When the camera determines the optimal scene, it displays the corresponding icon and guide.

 (Twilight),  (Twilight Portrait),  (Twilight using a tripod),  (Backlight),  (Backlight Portrait),  (Landscape),  (Macro),  (Portrait)





- 1 Set the mode dial to  (Intelligent Auto Adjustment).
- 2 MENU →  (Scene Recognition) → desired mode





✓	 <b>(Auto)</b>	When the camera recognizes the scene, it switches to the optimal settings and shoots the image.
	 <b>(Advanced)</b>	<p>When the camera recognizes the scene, it switches to the optimal settings. If the camera recognizes  (Twilight),  (Twilight Portrait),  (Twilight using a tripod),  (Backlight) or  (Backlight Portrait), it automatically changes the setting and shoots another image.</p> <ul style="list-style-type: none"> <li>• When you shoot two images consecutively, the + mark on the  icon will turn green.</li> <li>• When two frames are shot, the two images are displayed side by side immediately after shooting.</li> <li>• When [Anti Blink] is displayed, 2 images are taken automatically and the image with eyes are open is selected automatically. For details on the Anti Blink function, see “What is the Anti Blink function?”.</li> </ul>

## Notes

- Scene Recognition does not function when using digital zoom.
- When the recording mode is set to Burst, or when the Smile Shutter function is activated, Scene Recognition is fixed to [Auto].
- The available flash settings are [Auto] and [Off].
-  (Twilight using a tripod) scenes sometimes cannot be recognized in an environment where vibrations are transferred to the camera even though it is fixed on a tripod.
- Sometimes a slow shutter results when a scene is recognized as a  (Twilight using a tripod). Keep the camera still during shooting.
- These scenes may not be recognized depending on the situation.

## Images shot with [Advanced]

In [Advanced], when the camera recognizes a difficult-to-shoot scene ( (Twilight),  (Twilight Portrait),  (Twilight using a tripod),  (Backlight) and  (Backlight Portrait)), it changes the settings as follows and shoots two images with different effects, allowing you to select the one you like.

	First Image*	Second Image
	Shoot in Slow Synchro	Shoots with sensitivity increased and shake reduced
	Shoot in Slow Synchro with the face which the flash strobes on as guide	Shoots with sensitivity increased with the face as guide and shake reduced
	Shoot in Slow Synchro	Shoots with even slower shutter speed without increasing sensitivity
	Shoots with the flash	Shoots with the brightness and contrast of the background adjusted (DRO plus)
	Shoots with the face which the flash strobes on as guide	Shoots with the brightness and contrast of the face and the background adjusted (DRO plus)

\* When flash is set to [Auto].

## What is the Anti Blink function?

When set to [Advanced], the camera automatically shoots two images consecutively\* when it recognizes  (Portrait). The camera will select, display, and record the image which the eyes are not blinked automatically. If the eyes are closed in both images, the message “Blinked eye detected” is displayed.

\* except when the flash strobes/when the shutter speed is slow

# Smile Detection Sensitivity

Sets the sensitivity of the Smile Shutter function for detecting smiles.

1 MENU → 😊 (Smile Detection Sensitivity) → desired mode

	😊 (Big Smile)	Detects a big smile.
✓	😊 (Normal Smile)	Detects a normal smile.
	😊 (Slight Smile)	Detects even a slight smile.

## Notes

- Smiles may not be detected correctly depending on the conditions.
- [Smile Detection Sensitivity] cannot be adjusted in Easy Shooting, Sweep Panorama, Anti Motion Blur, Hand-held Twilight or Movie Mode.

# Face Detection

Detects the faces of your subjects and adjusts the focus, flash, exposure, white balance and red-eye reduction settings automatically.







## Face Detection frame (Orange)

When the camera detects more than one subject, the camera will judge which is the main subject and set focus by priority. The Face Detection frame for the main subject will turn orange. The frame for which the focus is set will turn green by pressing the shutter button halfway down.

## Face Detection frame (White)

1 MENU →  (Face Detection) → desired mode

 (Off)	Does not use Face Detection function.
  (Auto)	Selects the face the camera is to automatically focus on.
 (Child Priority)	Detects and shoots with priority on child's face.
 (Adult Priority)	Detects and shoots with priority on adult's face.

## Notes

- [Face Detection] cannot be selected in Easy Shooting, Sweep Panorama or Movie Mode.
- You can select [Face Detection] only when the focus mode is set to [Multi AF] or the metering mode is set to [Multi].
- The Face Detection function does not work when using the digital zoom.
- Up to 8 faces of your subjects can be detected.
- Adults and children may not be recognized correctly depending on the conditions.
- During Smile Shutter shooting, [Face Detection] is automatically set to [Auto] even if it is set to [Off].

## 💡 Registering the priority face (Selected-face Memory)

Normally the camera automatically selects the face to focus on according to the [Face Detection] setting, but you can also select and register a face to be given priority.



Face Priority Frame Off

- ① Press ● on the control button during Face Detection. The leftmost face is registered as the priority face, and the frame changes from □ to an orange frame (□).
  - ② Each time you press ●, the priority face moves one face to the right. Press ● repeatedly until the orange frame (□) is on the face you want to register.
  - ③ To cancel the face registration (Off), move the orange frame to the rightmost face, then press ● again.
- When you remove the battery from the camera, the face registration is reset.
  - When the registered face disappears from the LCD screen, the camera returns to the setting selected by [Face Detection]. When the registered face is shown on the LCD screen again, the camera focuses on the registered face.
  - It may not be possible to detect the registered face correctly depending on the surrounding brightness, the subject's hairstyle, etc. In this case, register the face again under the conditions where the image will be shot.
  - When the Smile Shutter function is used with the Face Detection frame registered, Smile Detection is performed only on the registered face.
  - In Easy Shooting mode, the priority face cannot be registered.



# DRO

The camera analyzes the shooting scene and automatically corrects the brightness and contrast to improve the image quality.

DRO stands for “Dynamic Range Optimizer,” a function that automatically optimizes the difference between light and dark parts of an image.

1 Set the mode dial to P (Program Auto).

2 MENU →  (DRO) → desired mode



	 (Off)	Does not adjust.
✓	 (DRO standard)	Adjusts the brightness and contrast of the images automatically.
	 (DRO plus)	Adjusts image brightness and contrast automatically and strongly.



## Notes

- Depending on shooting conditions, it may not be possible to obtain correction effects.
- Only [ISO AUTO] or values from [ISO 160] to [ISO 800] can be set for the ISO value when [DRO plus] is set.

# Anti Blink

When Scene Selection is set to  (Soft Snap) while you are shooting an image, the camera automatically shoots two images consecutively. The camera will select, display and record the image which the eyes are not blinked automatically.

- 1 Set the mode dial to **SCN** (Scene Selection).
- 2 Select  (Soft Snap).
- 3 MENU →  (Anti Blink) → desired mode

✓	 <b>(Auto)</b>	When Face Detection is active, the Anti Blink function operates so that images with the subject's eyes open are recorded.
	 <b>(Off)</b>	Does not use the Anti Blink function.

## Notes

- Anti Blink does not function in the following situations.
  - When using the flash
  - During burst or bracket shooting
  - When the Face Detection function does not work
  - When the Smile Shutter function is activated
- Sometimes Anti Blink function does not work depending on the situation.
- When the Anti Blink function is set to [Auto] but only images with the subject's eyes closed are recorded, the message "Blinked eye detected" is displayed on the LCD screen. Shoot again as necessary.



# Red Eye Reduction

The flash strobescs two or more times before shooting to reduce the red-eye phenomenon when using the flash.

1 MENU → [Red Eye Reduction] → desired mode

✓ [Red Eye Reduction] (Auto)	When the Face Detection function is activated, the flash strobescs automatically to reduce the red-eye phenomenon.
[Red Eye Reduction] (On)	The flash always strobescs to reduce the red-eye phenomenon.
[Red Eye Reduction] (Off)	Does not use Red Eye Reduction.

## Notes

- [Red Eye Reduction] cannot be selected during Easy Shooting, Anti Motion Blur, Hand-held Twilight, Sweep Panorama, Movie Mode or Smile Shutter.
- To avoid blurring of images, hold the camera firmly until the shutter is released. It usually takes a second after you press the shutter button. Be also sure not to allow the subject to move during this period.
- Red Eye Reduction may not produce the desired effects. It depends on individual differences and conditions, such as distance to the subject, or if the subject looked away from the pre-strobe.
- If you do not use the Face Detection function, Red Eye Reduction does not work, even when you select [Auto].

## 💡 What causes the red-eye phenomenon?

Pupils become dilated in dark environments. Flash light is reflected off the blood vessels at the back of the eye (retina), causing the “red-eye” phenomenon.

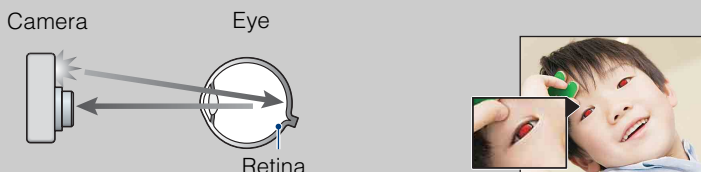



## Other ways to reduce red-eye

- Select [High Sensitivity] mode in Scene Selection. (The flash is set to [Off] automatically.)
- When the eyes of the subject turn out red, correct the image with [Retouch] → [Red Eye Correction] on the viewing menu or with the supplied software “PMB”.

# SteadyShot

Selects the anti-blur mode.



1 MENU →  (SteadyShot) → desired mode

✓	 <b>(Shooting)</b>	Activates the anti-blur function when pressing the shutter button halfway down.
	 <b>(Continuous)</b>	Always activates the anti-blur function. You can stabilize images even when zooming up a far subject.
	 <b>(Off)</b>	Does not use anti-blur mode.

## Notes

- In Intelligent Auto Adjustment, Easy Shooting mode or Scene Selection is set to  (Gourmet) mode, [SteadyShot] is fixed to [Shooting].
- [SteadyShot] is fixed to [Continuous] in Sweep Panorama, or the Smile Shutter function is activated.
- For movies, you can set [Continuous] or [Off] only. The default setting for movies is [Continuous].
- The battery charge is used up more quickly in [Continuous] mode than in [Shooting] mode.

## Hints for preventing blur

The camera moved accidentally when you took the image. This is called “Camera shake.” On the other hand, if the subject moved when you took the image, it is called “subject blur.” Besides, camera shake and subject blur occur frequently under low-light or slow shutter speed conditions, such as those encountered in  (Twilight Portrait) or  (Twilight) mode. In such case, shoot with the below tips in mind.

### Camera shake

Your hands or body shake while you hold the camera and press the shutter button, and the entire screen is blurred.

- Use a tripod or place the camera on a flat surface to hold the camera steady.
- Shoot with a 2-second delay self-timer and stabilize the camera by holding your arms firmly at your side after pressing the shutter button.
- Shoot with Hand-held Twilight.

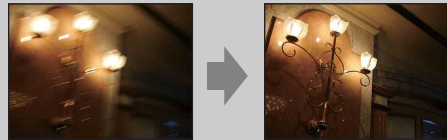

### Subject blur



Even though the camera is steady, the subject moves during the exposure so the subject is shot blurred when the shutter button is pressed. Camera shake is reduced automatically using the anti-blur function. However, the function does not effectively reduce subject blur.

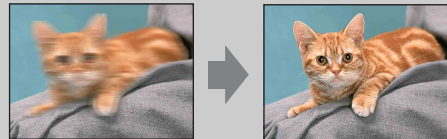

- Select Anti Motion Blur or  (High Sensitivity) mode in Scene Selection.
- Select a higher ISO sensitivity to make the shutter speed faster, and press the shutter button before the subject moves.



# Slideshow

Images are automatically played back in succession.

- 1 Press the  (Playback) button to switch to playback mode.
- 2 MENU →  (Slideshow) → desired slideshow → ● on the control button

 <b>(Continuous Playback)</b>	Plays back all the images in succession.
 <b>(Slideshow with music)</b>	Plays back still images along with effects and music.

## Continuous Playback

- 1 Select the desired image for playing with the control button.
- 2 MENU →  (Slideshow) → [Continuous Playback] → ●

Control button	Playback feature
●	Pause
▲	Sets the display settings.
▼	Displays the volume control screen. Adjust the volume with ▲/▼.
◀	Rewinds image
▶	Forwards image

### Note

- When [Display Burst Group] is [Display Main Image Only], only the main image is displayed.



### Viewing panoramic images during continuous playback

The whole panoramic image is displayed for 3 seconds.

You can scroll a panoramic image by pressing ●.



Press ● again while scrolling, the screen returns to the whole panoramic image.

# Slideshow with music

- 1 MENU →  (Slideshow) → [Slideshow with music] → ● on the control button  
Displays the setting screen.
- 2 Select a desired setting.
- 3 [Start] → ●
- 4 Press ● to end the slideshow.

## Notes

- You cannot play back movies or panoramic images.
- Settings other than [Image] are stored until the next time they are changed.

Image		
Selects the group of images to be shown.		
✓	<b>All</b>	Plays a slideshow of all the still images in order.
	<b>This Date</b>	Plays a slideshow of still images with the currently selected date range when View Mode is  (Date View).
	<b>Folder</b>	Plays a slideshow of still images in the currently selected folder when View Mode is  (Folder View).

## Notes

- This setting is fixed to [Folder] when the internal memory is used to record images.
- When [Display Burst Group] is [Display Main Image Only], only the main image is displayed.

Effects		
Selects the playback speed and mood for slideshows.		
✓	<b>Simple</b>	A simple slideshow switching still images at a preset interval. The playback interval is adjustable in [Interval] and you can thoroughly enjoy your images.
	<b>Nostalgic</b>	A moody slideshow reproducing the atmosphere of a movie scene.
	<b>Stylish</b>	A stylish slideshow proceeding at a middle tempo.
	<b>Active</b>	A high-tempo slideshow suitable for active scenes.

## Notes

- In [Nostalgic], [Stylish] and [Active], when there are 3 or more images in a burst group, and [Display Burst Group] is set to [Display Main Image Only], 3 images including the main image are played back.
- When [Display Burst Group] is set to [Display Main Image Only], the grouped burst images are displayed as follows;
  - When the Effects are set to [Simple], only the main image is displayed.
  - When the Effects are set to other than [Simple], only the main image is displayed when there are two burst images or less.
  - When the Effects are set to other than [Simple], the main image and images before and after the main image are displayed.

**Music**

Specifies the music to be played during slideshows. You can select more than one background music track. Press ▼ on the control button to display the volume control screen, then press ▲/▼ to adjust the volume.

	<b>Mute</b>	Does not use BGM.
✓	<b>Music1</b>	The default setting for a [Simple] slideshow.
	<b>Music2</b>	The default setting for a [Nostalgic] slideshow.
	<b>Music3</b>	The default setting for a [Stylish] slideshow.
	<b>Music4</b>	The default setting for a [Active] slideshow.

**Interval**

Sets the screen switching interval. The setting is fixed to [Auto] when [Simple] is not selected as the [Effects].

	<b>1 sec</b>	Sets the display interval of images for a [Simple] slideshow.
✓	<b>3 sec</b>	
	<b>5 sec</b>	
	<b>10 sec</b>	
	<b>Auto</b>	The interval is set to suit the selected [Effects] item.

**Repeat**

Turns slideshow repeat on or off.

✓	<b>On</b>	Plays back images in a continuous loop.
	<b>Off</b>	After all the images have been played back, the slideshow ends.



 **Selecting background music**



You can transfer a desired music file from your CDs or MP3 files to the camera to play back during slideshow. To transfer music, install the “Music Transfer” software (supplied) to your computer. For details, see pages 105 and 107.

- You can record up to four pieces of music on the camera (The 4 preset pieces (Music1 – Music4) can be replaced with the ones you transferred).
- A maximum length of each music file for music playback of the camera is about 5 minutes.
- If you cannot play back a music file due to damage or other malfunctions of the file, execute [Format Music] (page 92) and transfer the music again.

# View Mode

Allows you to select the display format for viewing multiple images.





- 1 Press the  (Playback) button to switch to playback mode.
- 2 MENU →  (View Mode) → desired mode → ● on the control button

	 <b>(Date View)</b>	Displays images by the date.
	 <b>(Folder View)</b>	Images are displayed, organized by folders. When a recording folder is already created, select [Select Folder] from the Menu to select a folder to view.

## Notes

- When using the internal memory, the view mode is set to [Folder View].
- When images recorded with other cameras cannot be played back on this camera, view the images in [Folder View].
- Event View is not available on this camera.

## Displaying the Calendar

- 1 MENU →  (View Mode) →  (Date View) → ● on the control button
- 2 Press the  (Index) button repeatedly until the Calendar is displayed.  
Select the month you want to display with /▼.



### Viewing images taken with a different camera



If you insert into this camera a “Memory Stick Duo” media containing images taken both with this camera and another camera, a screen for selecting the playback method appears.



**“Playback only registered images”:** Images are played in the selected View Mode. Some images taken with other cameras may not be played at this time.

**“Playback all images with folder view”:** The camera switches to Folder View and plays all images.

# Display Burst Group

You can select to display burst images in groups or display all images during playback.

- 1 Press the  (Playback) button to switch to playback mode.
- 2 MENU →  (Display Burst Group) → desired setting → ● on the control button

✓	 <b>(Display Main Image Only)</b>	Groups burst images, then plays back the main image only. <ul style="list-style-type: none"><li>• When Face Detection is performed in burst mode, the camera determines and displays the optimum image as the main image. When Face Detection is not performed, the first image in the burst group is displayed as the main image.</li></ul>
	 <b>(Display All)</b>	Plays back all burst images one at a time.

## Note

- When [View Mode] is set to [Folder View], this setting is fixed to [Display All].

## Displaying burst images side by side



In [Display Main Image Only] mode, the images in a burst group can be displayed side by side.





- ① Display the burst images.
- ② Press ● on the control button.  
Burst groups are displayed side by side at the bottom of the LCD screen.
- ③ Select images with ◀/▶.  
Display or hide the index with ▼ and press ● to go back to single playback.

# Retouch

Adds effects or makes corrections to a recorded image and records it as a new file. The original image is retained.

- 1 Press the  (Playback) button to switch to playback mode.
- 2 MENU →  (Retouch) → desired mode → ● on the control button
- 3 Perform retouching according to the operation method in each mode.

 <b>(Trimming)</b>	<p>Records the zoomed playback image.</p> <ol style="list-style-type: none"> <li>① Press the Q button (T) to zoom in and press W to zoom out.</li> <li>② Set the zoom point with the control button.</li> <li>③ MENU → select an image size to save → ●</li> <li>④ [OK] → ●</li> </ol> <ul style="list-style-type: none"> <li>• The quality of trimmed images may deteriorate.</li> <li>• The image size that you can trim may vary depending on the image.</li> </ul>
 <b>(Red Eye Correction)</b>	<p>Corrects the red-eye phenomenon caused by flash.</p> <ol style="list-style-type: none"> <li>① Select [OK] with the control button → ●.</li> </ol> <ul style="list-style-type: none"> <li>• You may not be able to correct the red-eye phenomenon depending on the image.</li> </ul>
 <b>(Unsharp masking)</b>	<p>Sharpens the image within a chosen frame.</p> <ol style="list-style-type: none"> <li>① Select the area (frame) of the desired image to retouch with the control button → MENU.</li> <li>② [OK] → ●</li> </ol> <ul style="list-style-type: none"> <li>• Depending on the image, sufficient correction may not be applied and the image quality may deteriorate.</li> </ul>



## Note







- You cannot retouch the following types of images.
  - Movies
  - Panoramic images
  - Images displayed in a burst group



# Delete

Allows you to select unwanted images for deletion. You can also delete images using the  (Delete) button (page 40).

- 1 Press the  (Playback) button to switch to playback mode.
- 2 MENU →  (Delete) → desired mode → ● on the control button
- 3 [OK] → ●

 (This Image)	Deletes the currently displayed image in single-image mode.
 (Multiple Images)	You can select and delete multiple images. Do as the following after step 2. ① Select an image then press ●. Repeat the above steps until there are no more images to be deleted. Select an image with a ✓ mark to release the ✓ mark. ② MENU → [OK] → ●
 (All in This Folder)  (All in Date Range)  (All In This Group)	Deletes all images in the selected folder, date range or burst group at once.
 (All but this image)	Deletes burst group images other than the selected image in Display Burst Group mode.



## Note



- When the mode dial is set to **EASY** (Easy Shooting), you can select between [Delete Single Image] or [Delete All Images].

# Protect

Protects recorded images against accidental erasure.

The  mark is displayed for registered images.

- 1 Press the  (Playback) button to switch to playback mode.
- 2 MENU →  (Protect) → desired mode → ● on the control button

 (This Image)	Protects the currently displayed image in single-image mode.
 (Multiple Images)	You can select and protect multiple images. Do as the following after step 2. ① Select an image then press ●. Repeat the above steps until there are no more images to be protected. Select an image with a ✓ mark to release the ✓ mark. ② MENU → [OK] → ●



## To cancel the protection

Select the image for which you want to cancel protection, and unlock it by pressing ● on the control button as the same procedure to protect it.



The  indicator disappears, and the protection is released.

# DPOF

DPOF (Digital Print Order Format) is a function that allows you to specify the images of “Memory Stick Duo” media that you want to print out later.

The **DPOF** (Print order) mark is displayed for registered images.

- 1 Press the  (Playback) button to switch to playback mode.
- 2 MENU → **DPOF** → desired mode → ● on the control button

<b>DPOF</b>  <b>(This Image)</b>	Orders printing the currently displayed image in single-image mode.
<b>DPOF</b>  <b>(Multiple Images)</b>	You can select and order printing multiple images. Do as the following after step 2. ① Select an image then press ●. Repeat the above steps until there are no more images to be printed. Select an image with a ✓ mark to release the ✓ mark. ② MENU → [OK] → ●

## Notes

- The **DPOF** (Print order) mark cannot be added to movies or to images in the internal memory.
- You can add a **DPOF** (Print order) mark to a maximum 999 images.

## Clearing the DPOF mark





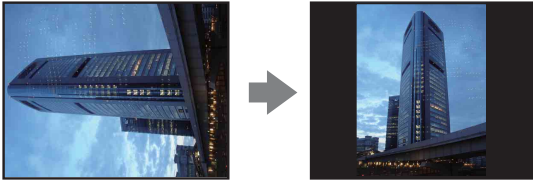

Select the image to clear the DPOF registration, then press ● on the control button in the same procedure as when making a **DPOF** mark.

The **DPOF** mark disappears and the DPOF registration is cleared.

# Rotate

Rotates a still image. Use this to display a horizontal orientation image in vertical orientation.



- 1 Press the  (Playback) button to switch to playback mode.
- 2 MENU →  (Rotate) → ● on the control button
- 3 Rotate the image with [/] → /.
- 4 [OK] → ●





## Notes

- You cannot rotate the following types of images.
  - Movies
  - Protected still images
  - Images displayed in a burst group
- You may not be able to rotate images shot with other cameras.
- When viewing images on a computer, the image rotation information may not be reflected depending on the software.

# Select Folder

When multiple folders are created in “Memory Stick Duo” media, this selects the folder containing the image you want to play back.

Step 2 is unnecessary when [Folder View] is already set.

- 1 Press the  (Playback) button to switch to playback mode.
- 2 MENU →  (View Mode) →  (Folder View) → ● on the control button
- 3 MENU →  (Select Folder) → ●
- 4 Select the folder with ◀/▶.
- 5 [OK] → ●



## Note

- This item is not displayed when the internal memory is used to record images.





## Viewing images across multiple folders

When multiple folders are created, the following indicators appear on the first and last images in the folder.

- : Moves to the previous folder
- : Moves to the next folder
- : Moves to either the previous or next folders





# AF Illuminator

The AF illuminator supplies fill light to focus more easily on a subject in dark surroundings. The AF illuminator emits red light allowing the camera to focus easily when the shutter button is pressed halfway, until the focus is locked. The  $\text{AF-ON}$  indicator appears at this time.

- 1 Set the camera to shooting mode.
- 2 MENU →  (Settings) →  (Shooting Settings) → [AF Illuminator] → desired mode → ● on the control button



<input checked="" type="checkbox"/>	<b>Auto</b>	Uses the AF illuminator.
<input type="checkbox"/>	<b>Off</b>	Does not use AF illuminator.

## Notes

- Focus is achieved as long as the AF illuminator light reaches the subject, regardless of whether light fails to reach the center of the subject.
- You cannot use the AF illuminator when:
  - Shooting in Sweep Panorama mode
  -  (Landscape),  (Twilight),  (Pet) or  (Fireworks) mode is selected in Scene Selection.
- When you use AF illuminator, the normal AF range finder frame is disabled and a new AF range finder frame is displayed by a dotted line. AF operates with priority on subjects located near the center of the frame.
- The AF illuminator emits very bright light. Although there is no health hazard, do not look directly into the AF illuminator emitter at close range.

# Grid Line



With reference to the grid lines, you can easily set a subject in a horizontal/vertical position.

- 1 Set the camera to shooting mode.
- 2 MENU →  (Settings) →  (Shooting Settings) → [Grid Line] → desired mode → ● on the control button

	<b>On</b>	Displays the grid lines. The grid lines are not recorded.
✓	<b>Off</b>	Does not display the grid lines.

# Digital Zoom

Selects the digital zoom mode. The camera enlarges the image using optical zoom (up to 5×). When the zoom scale is exceeded, the camera uses either smart or precision digital zoom.

- 1 Set the camera to shooting mode.
- 2 MENU →  (Settings) →  (Shooting Settings) → [Digital Zoom] → desired mode → ● on the control button

✓	<b>Smart (SQ)</b>	Enlarges the image digitally within the range where the image will not be distorted, according to the image size (Smart zoom).
	<b>Precision (PQ)</b>	Enlarges all image sizes by the total zoom scale of approximately 10×, including the optical zoom 5×. However, note that the image quality deteriorates when the optical zoom scale is exceeded (Precision digital zoom).
	<b>Off</b>	Does not use the digital zoom.

## Notes

- The Digital Zoom function does not operate in Sweep Panorama, Movie Mode or when the Smile Shutter function is activated.
- The smart zoom is not available when the image size is set to [10M], [3:2(8M)] or [16:9(7M)].
- The Face Detection function does not work when using the digital zoom.

## Total zoom scale when using Smart zoom (including optical zoom 5×)



The supported zoom ratio differs depending on the image size.

Size	Total zoom scale
5M	Approx. 7.0×
3M	Approx. 8.9×
VGA	Approx. 28×
16:9(2M)	Approx. 9.5×



# Auto Orientation

When the camera is rotated to shoot a portrait (vertical) image, the camera records its position change and displays the image in the portrait position.

- 1 Set the camera to shooting mode.
- 2 MENU →  (Settings) →  (Shooting Settings) → [Auto Orientation] → desired mode → ● on the control button

<input checked="" type="checkbox"/>	<b>On</b>	Records the image with the correct orientation.
<input type="checkbox"/>	<b>Off</b>	Does not use Auto Orientation.

## Notes



- Black is displayed to the left and right of vertical orientation images.
- Depending on the shooting angle of the camera, the orientation of the image may not be recorded correctly.
- You cannot use Auto Orientation when  (Underwater) mode is selected in the Scene Selection or in Movie Mode.

## Rotating images after recording

If the orientation of an image is incorrect, you can use the [Rotate] on the Menu screen to display the image in portrait position.

# Blink Alert



When an image with the subject's eyes closed is recorded while Face Detection is activated, the message "Blinked eye detected" is displayed.

1 MENU →  (Settings) →  (Shooting Settings) → [Blink Alert] → desired mode → ● on the control button

✓	<b>Auto</b>	Displays the "Blinked eye detected" message.
	<b>Off</b>	Does not display the message.

# Beep



Selects or turns off the sound produced when you operate the camera.

1 MENU →  (Settings) →  (Main Settings) → [Beep] → desired mode → ● on the control button

	<b>Shutter</b>	Turns on the shutter sound when you press the shutter button.
✓	<b>High</b>	Turns on the beep/shutter sound when you press the control/shutter button.
	<b>Low</b>	If you want to lower the volume, select [Low].
	<b>Off</b>	Turns off the beep/shutter sound.



# Language Setting

Selects the language to be used in the menu items, warnings and messages.

- 1 MENU →  (Settings) →  (Main Settings) → [Language Setting] → desired mode → ● on the control button

# Function Guide



You can select whether or not function guide is displayed when you operate the camera.

1 MENU →  (Settings) →  (Main Settings) → [Function Guide] → desired mode → ● on the control button

✓	<b>On</b>	Displays the function guide.
	<b>Off</b>	Does not display the function guide.

# Demo Mode

You can set whether to use a demonstration of the Smile Shutter and Scene Recognition. When there is no need to view a demonstration, set to [Off].

1 MENU →  (Settings) →  (Main Settings) → [Demo Mode] → desired mode → ● on the control button

	<b>Demo Mode1</b>	Demonstrates Scene Recognition mode.
	<b>Demo Mode2</b>	Automatically starts the Smile Shutter demonstration when no operation is performed for 15 seconds.
✓	<b>Off</b>	Does not perform a demonstration.



## Note

- Pressing the shutter button during the Smile Shutter demonstration operates the shutter, but no image is recorded.

# Initialize

Initializes the setting to the default setting.

Even if you execute this function, the images are retained.



- 1 MENU →  (Settings) →  (Main Settings) → [Initialize] → [OK] → ● on the control button

## Note

- Be sure not to turn off the camera while initializing.

# COMPONENT

Selects the video signal output type from SD and HD(1080i) when you connect the camera and TV using an HD Output Adaptor Cable (sold separately), according to the TV connected. Use a Type1a-compliant HD Output Adaptor Cable.

1 MENU →  (Settings) →  (Main Settings) → [COMPONENT] → desired mode → ● on the control button

✓	<b>HD(1080i)</b>	Select this item to connect the camera to a 1080i-capable High Definition TV.
	<b>SD</b>	Select this item to connect the camera to a TV that is not compatible with an HD(1080i) signal.

## Note



- When shooting movies in the condition with the camera and a TV connected using an HD Output Adaptor Cable (sold separately), the image being shot is not displayed in the TV side.



# Video Out

Sets the video signal output according to the TV color system of the connected video equipment. The TV color systems differ depending on the country and region.



To view images on a TV screen, check the TV color system of the country or region of use (page 103).

1 MENU →  (Settings) →  (Main Settings) → [Video Out] → desired mode → ● on the control button

<b>NTSC</b>	Sets the video output signal to NTSC mode (e.g., for the USA, Japan).
<b>PAL</b>	Sets the video output signal to PAL mode (e.g., for Europe, China).

# USB Connect

Selects the USB mode when connecting the camera to a computer or a PictBridge-compliant printer using the cable for multi-use terminal.

1 MENU →  (Settings) →  (Main Settings) → [USB Connect] → desired mode → ● on the control button



✓	<b>Auto</b>	The camera recognizes automatically and sets up communication with a computer or PictBridge-compliant printer.
	<b>PictBridge</b>	Connects the camera to a PictBridge-compliant printer.
	<b>PTP/MTP</b>	When you connect the camera to a computer, the AutoPlay Wizard appears, and the still images in the recording folder on the camera are imported to the computer. (with Windows Vista/XP, Mac OS X)
	<b>Mass Storage</b>	Establishes a Mass Storage connection between the camera and a computer or other USB device.

## Notes

- If you cannot connect the camera to a PictBridge-compliant printer with the [Auto] setting, select [PictBridge].
- If you cannot connect the camera to a computer or a USB device with the [Auto] setting, select [Mass Storage].
- When [USB Connect] is set to [PTP/MTP], you cannot export movies to a computer. To export movies to a computer, set [USB Connect] to [Auto] or [Mass Storage].

# Download Music

You can use “Music Transfer” in the CD-ROM (supplied) to change background music tracks.

- 1 MENU →  (Settings) →  (Main Settings) → [Download Music] → ● on the control button

The message “Change slideshow music Connect to PC” appears.

- 2 Make a USB connection between the camera and a computer, then start “Music Transfer”.
- 3 Follow the instructions on the screen to change music files.

# Format Music

You can delete all the background music files stored in the camera. It can be used in cases such as when the background music files are damaged and cannot be played.

1 MENU →  (Settings) →  (Main Settings) → [Format Music] → [OK] → ● on the control button





## Restoring the music preset at the factory to the camera

You can use “Music Transfer” in the CD-ROM (supplied) to reset music files to the preset ones.

- ① Execute [Download Music] and make a USB connection between the camera and a computer.
- ② Start “Music Transfer”, then restore the default music.
  - For details on using “Music Transfer”, see the help in “Music Transfer”.

# Format

Formats the “Memory Stick Duo” media or the internal memory. A commercially available “Memory Stick Duo” media is already formatted, and can be used immediately.

1 MENU →  (Settings) →  (“Memory Stick” Tool) or  (Internal Memory Tool) → [Format] → [OK] → ● on the control button



## Note

- Note that formatting permanently erases all data including even protected images.

# Create REC.Folder

Creates a folder in “Memory Stick Duo” media for recording images.

Images are recorded in the newly created folder until you create another folder or select another recording folder.

1 MENU →  (Settings) →  (“Memory Stick” Tool) → [Create REC.Folder] → [OK] → ● on the control button

## Notes

- This item is not displayed when the internal memory is used to record images.
- When you insert a “Memory Stick Duo” media that was used with other equipment into the camera and shoot images, a new folder may be automatically created.
- Up to 4,000 images can be stored in one folder. When the folder capacity is exceeded, a new folder is automatically created.





## On the folders

After a new folder is created, you can change the storage destination folder (page 95) and select the folder for viewing images (page 77).

# Change REC.Folder

Changes the folder in “Memory Stick Duo” media that is currently used for recording images.



- 1 MENU →  (Settings) →  (“Memory Stick” Tool) → [Change REC.Folder]
- 2 Select a folder with ◀/▶ on the control button.
- 3 [OK] → ●

## Notes

- This item is not displayed when the internal memory is used to record images.
- The following folder cannot be selected as a recording folder.
  - “100” folder
  - A folder with a number that has only either “□□□MSDCF” or “□□□MNV01”.
- You cannot move recorded images to another folder.

# Delete REC.Folder

Deletes a folder for recording images in “Memory Stick Duo” media.

- 1 MENU →  (Settings) →  (“Memory Stick” Tool) → [Delete REC.Folder]
- 2 Select a folder with ◀/▶ on the control button.
- 3 [OK] → ●



## Notes

- This item is not displayed when the internal memory is used to record images.
- If you delete the folder set as the recording folder using [Delete REC.Folder], the folder that has the largest folder number is selected as the next recording folder.
- You can delete only empty folders. If a folder contains images, or files that cannot be played back by the camera, first delete these images and files, and then delete the folder.



# Copy

Copies all images in the internal memory to a “Memory Stick Duo” media.



- 1 Insert a “Memory Stick Duo” media with sufficient free capacity into the camera.
- 2 MENU →  (Settings) →  (“Memory Stick” Tool) → [Copy] → [OK] → ● on the control button

## Notes

- Use a fully charged battery pack. If you attempt to copy image files using a battery pack with little remaining charge, the battery pack may run out, causing copying to fail or possibly corrupting the data.
- Images cannot be copied individually.
- The original images in the internal memory are retained even after copying. To delete the contents of the internal memory, remove the “Memory Stick Duo” media after copying, then format the internal memory ([Format] in [Internal Memory Tool]).
- A new folder is created on the “Memory Stick Duo” media and all the data will be copied to it. You cannot choose a specific folder and copy images to it.

# File Number



Selects the method used to assign file numbers to images.

- 1 MENU →  (Settings) →  (“Memory Stick” Tool) or  (Internal Memory Tool) → [File Number] → desired mode → ● on the control button

✓	<b>Series</b>	Assigns numbers to files in sequence even if the recording folder or the “Memory Stick Duo” media is changed. (When the replaced “Memory Stick Duo” media contains a file with a number higher than the last assigned number, a number one higher than the largest number is assigned.)
	<b>Reset</b>	Starts from 0001 each time the folder is changed. (When the recording folder contains a file, a number one higher than the largest number is assigned.)

# Area Setting

Adjusts the time to the local time of a selected area.

1 MENU →  (Settings) →  (Clock Settings) → [Area Setting] → desired setting → ● on the control button

✓	<b>Home</b>	You use the camera in your area. When the currently set area differs from your home area, you must make the Area Setting.
	<b>Destination</b>	You use the camera set to the time at your destination. Set the destination area.

## Changing Area Setting

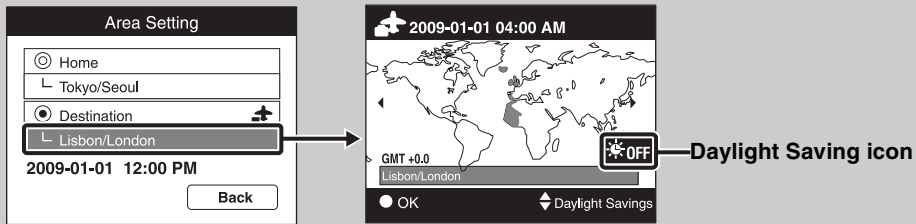

Setting a frequently visited destination lets you easily adjust the time when you visit that destination.



- ① Select the area part for [Destination], then press ● on the control button.
- ② Select an area with ◀/▶ on the control button, and select Daylight Savings time with ▲/▼.

# Date & Time Setting

Sets the date and time again.

1 MENU →  (Settings) →  (Clock Settings) → [Date & Time Setting]  
→ desired setting → ● on the control button

2 [OK] → ● on the control button

<b>Date &amp; Time Format</b>	You can select the date and time display format.
<b>Daylight Savings</b>	You can select Daylight Savings On/Off.
<b>Date &amp; Time</b>	You can set the date and time.

## Note

- The camera does not have a feature for superimposing dates on images. By using “PMB” in the CD-ROM (supplied), you can print or save images with the date.

# Viewing images on a TV

You can view images on a TV by connecting the camera to a TV.  
The connection varies according to the type of TV the camera is connected to.  
Refer also to the operating instructions supplied with the TV.

## Viewing images by connecting the camera to a TV with the supplied cable for multi-use terminal

- 1 Turn off both the camera and the TV.
- 2 Connect the camera to the TV with the cable for multi-use terminal (supplied).

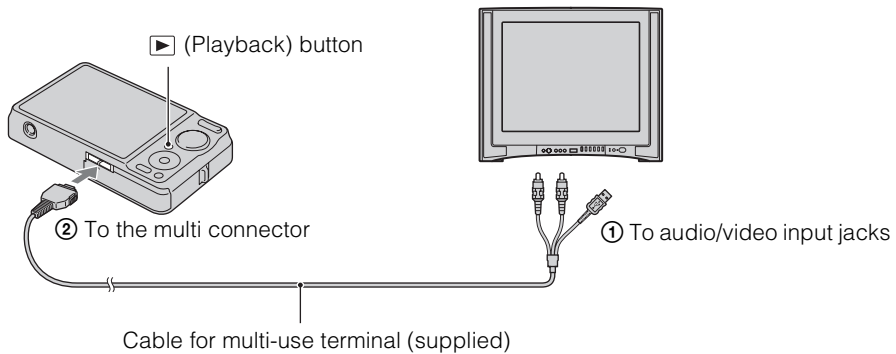

- 3 Turn on the TV and set the input.
- 4 Press ▶ (Playback) button to turn on the camera.

Images shot with the camera appear on the TV. Select the desired image with the control button.

### Notes

- When using the camera abroad, it may be necessary to switch the video signal output to match that of your TV system (page 89).
- The shooting image will not be displayed on the TV when the movie is shot under the condition of the camera and TV connected.
- When output to TV, easy viewing is invalid.

# Viewing an image by connecting the camera to an HD TV

You can view an image recorded on the camera by connecting the camera to an HD (High Definition) TV with the HD Output Adaptor Cable (sold separately). Use a Type1a-compliant HD Output Adaptor Cable.

- 1 Turn off both the camera and the TV.
- 2 Connect the camera to an HD (High Definition) TV with a HD Output Adaptor Cable (sold separately).

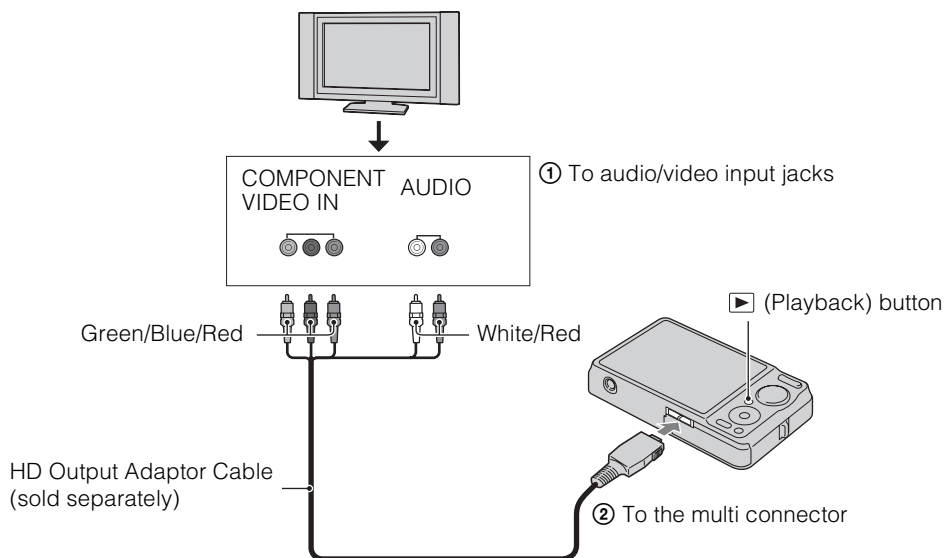

- 3 Turn on the TV and set the input.
- 4 Press  (Playback) button to turn on the camera.

Images shot with the camera appear on the TV. Select the desired image with the control button.

## Notes

- Set [COMPONENT] to [HD(1080i)] (page 88).
- Images shot in [VGA] image size cannot be played back in HD format.
- When shooting movies in the condition with the camera and a TV connected using an HD Output Adaptor Cable (sold separately), the image being shot is not displayed in the TV side.
- When using the camera abroad, it may be necessary to switch the video signal output to match that of your TV system (page 89).
- When output to TV, easy viewing is invalid.

## "PhotoTV HD"

This camera is compatible with the "PhotoTV HD" standard.

By connecting Sony PhotoTV HD-compatible devices using an HD Output Adaptor Cable (sold separately), whole new world of photos can be comfortably enjoyed in breathtaking Full HD quality.

- PhotoTV HD allows for a highly-detailed, photo-like expression of subtle textures and colors.
- The settings are also required to be made on the TV. For details, refer to the operating instruction of the TV.

## On TV color systems

If you want to view images on a TV screen, you need a TV with a video input jack and the cable for multi-use terminal. The color system of the TV must match that of the digital still camera. Check the following lists for the TV color system of the country or region where the camera is used.

### NTSC system

Bahama Islands, Bolivia, Canada, Central America, Chile, Colombia, Ecuador, Jamaica, Japan, Korea, Mexico, Peru, Surinam, Taiwan, the Philippines, the U.S.A., Venezuela, etc.

### PAL system

Australia, Austria, Belgium, China, Croatia, Czech Republic, Denmark, Finland, Germany, Holland, Hong Kong, Hungary, Indonesia, Italy, Kuwait, Malaysia, New Zealand, Norway, Poland, Portugal, Rumania, Singapore, Slovak Republic, Spain, Sweden, Switzerland, Thailand, Turkey, United Kingdom, Viet Nam, etc.

### PAL-M system

Brazil

### PAL-N system

Argentina, Paraguay, Uruguay

### SECAM system

Bulgaria, France, Greece, Guiana, Iran, Iraq, Monaco, Russia, Ukraine, etc.

# Using with your computer

“PMB” and other applications are contained on the CD-ROM (supplied) to allow more versatile use of images shot with your Cyber-shot camera.

## Recommended computer environment (Windows)

	OS (pre-installed)	Others
<b>For using “PMB” and “Music Transfer”, and when importing images</b>	Microsoft Windows XP* <sup>1</sup> SP3/Windows Vista* <sup>2</sup> SP2	<b>CPU:</b> Intel Pentium III 800 MHz or faster (For playing/editing the High Definition movies: Intel Pentium 4 2.8 GHz or faster/ Intel Pentium D 2.8 GHz or faster/ Intel Core Duo 1.66 GHz or faster/ Intel Core 2 Duo 1.20 GHz or faster) <b>Memory:</b> 512 MB or more (For playing/editing the High Definition movies: 1 GB or more) <b>Hard Disk:</b> Disk space required for installation—approximately 500 MB <b>Display:</b> Screen resolution: 1,024 × 768 dots or more

\*<sup>1</sup> 64-bit editions and Starter (Edition) are not supported.

Windows Image Mastering API (IMAPI) Ver.2.0 or later is required to use the function for creating discs.

\*<sup>2</sup> Starter (Edition) is not supported.

## Recommended computer environment (Macintosh)

	OS (pre-installed)	Others
<b>For using “Music Transfer”, and when copying images</b>	Mac OS X (v10.3 to v10.5)	<b>Memory:</b> 64 MB or more (128 MB or more is recommended) <b>Hard Disk:</b> Disk space required for installation—approximately 50 MB

### Notes

- Operation is not assured in an environment based on an upgrade of the operating systems described above or in a multi-boot environment.
- If you connect two or more USB devices to a single computer at the same time, some devices, including the camera, may not operate, depending on the types of USB devices you are using.
- Connecting the camera using a USB interface that is compatible with Hi-Speed USB (USB 2.0 compliant) allows advanced transfer (high speed transfer), as the camera is compatible with Hi-Speed USB (USB 2.0 compliant).
- When your computer resumes activity from suspend or sleep mode, communication between the camera and your computer may not recover at the same time.



# Using the software

## Installing “PMB (Picture Motion Browser)” and “Music Transfer” (Windows)

- 1 Turn on your computer, and insert the CD-ROM (supplied) into the CD-ROM drive.

The installation menu screen appears.

- If it does not appear, double-click [Computer] (in Windows XP, [My Computer]) →  (SONYPICUTIL).
- If the AutoPlay screen appears, select “Run Install.exe” and follow the instructions that appear on the screen to proceed with the installation.

- 2 Click [Install].

The “Choose Setup Language” screen appears.

- 3 Select the desired language, then proceed to the following screen.

The “License Agreement” screen appears.

- 4 Carefully read the agreement, click the radio button (○ → ●) to accept the terms of the agreement, and then click [Next].

- 5 Follow the instructions on the screen to complete the installation.

- When the restarting confirmation message appears, restart the computer following the instructions on the screen.
- DirectX may be installed depending on the system environment of your computer.

- 6 Remove the CD-ROM after the installation is complete.

- 7 Start up the software.

To start up “PMB”, click  (PMB) on the desktop.



For the detailed operation method, click  (PMB Guide).

To start up “PMB” from the Start menu, select [Start] → [All programs] → [Sony Picture Utility].

### Notes

- Log on as Administrator.
- Before starting up “Music Transfer”, perform MENU →  (Settings) → [Main Settings] → [Download Music], and connect the camera to a computer.
- When “PMB” is started up for the first time, the confirmation message of the Information tool appears on the screen. Select [Start].

## Introduction to “PMB”

- “PMB” allows you to import images shot with the camera to a computer for display. Make a USB connection between the camera and your computer, and click [Import].
- Images on a computer can be exported to a “Memory Stick Duo” media, and displayed on the camera. Make a USB connection between the camera and your computer, click  at the top of the screen, and click [Export].
- You can save and print images with the date.
- You can display images stored on a computer by shooting date in a calendar display.
- You can correct (Red Eye Reduction, etc.) still images, and change the shooting date and time.
- You can create discs with CD or DVD disc-writing drive.
- You can upload images to media services. (An internet connection environment is required.)
- For other details, see  (PMB Guide).

## Introduction to “Music Transfer”

“Music Transfer” allows you to replace the Music files provided in the camera at the factory with your favorite tracks, and to delete and add Music files.

You can also restore the tracks stored at the factory to your camera.

The following track types can be imported using “Music Transfer”.

- MP3 files stored on the hard disk of your computer
- Music CD tracks
- Preset-music saved on the camera

For other details, see the help in “Music Transfer”.

# Installing “Music Transfer” (Macintosh)

- 1 Turn on your Macintosh computer, and insert the CD-ROM (supplied) into the CD-ROM drive.
- 2 Double-click  (SONYPICUTIL).
- 3 Double-click the [MusicTransfer.pkg] file in the [Mac] folder.  
The installation of the software starts.

## Notes

- “PMB” is not compatible with Macintosh computers.
- For details on using “Music Transfer”, see help in “Music Transfer”.
- Before starting up “Music Transfer”, perform MENU →  (Settings) → [Main Settings] → [Download Music], and connect the camera to the computer.
- Shut down all other application software before you install “Music Transfer”.
- For installation, you need to log on as Administrator.



## Introduction to “Music Transfer”

“Music Transfer” allows you to replace the Music files provided in the camera at the factory with your favorite tracks, and to delete and add Music files. You can also restore the tracks stored at the factory to your camera.

The following track types can be imported using “Music Transfer”.

- MP3 files stored on the hard disk of your computer
- Music CD tracks
- Preset-music saved on the camera

For other details, see the help in “Music Transfer”.

# Connecting the camera to the computer

1 Insert a sufficiently charged battery pack into the camera, or connect the camera to a wall outlet (wall socket) using the AC-LS5K/AC-LS5 AC Adaptor (sold separately) and the USB/AV/DC IN Cable for multi-use terminal (sold separately).

- Use a Type1a-compliant USB/AV/DC IN Cable (sold separately).

2 Turn on the computer, then press  (Playback) button.

3 Connect the camera to your computer.

- When a USB connection is established for the first time, your computer automatically runs a program to recognize the camera. Wait for a while.

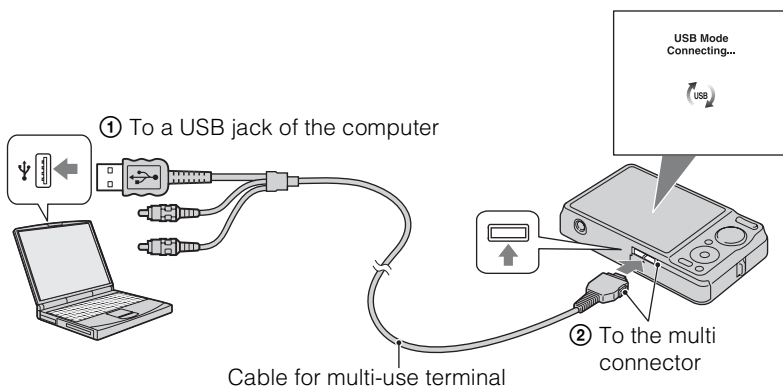

## Importing images to a computer (Windows)

“PMB” allows you to easily import images.

For details on “PMB” functions, see the “PMB Guide”.

### Importing images to a computer without using “PMB”

When the AutoPlay Wizard appears after making a USB connection between the camera and a computer, click [Open folder to view files] → [OK] → [DCIM] → copy the desired images to the computer.

## Importing images to a computer (Macintosh)

- 1 Connect the camera to your Macintosh computer first. Double-click the newly recognized icon on the desktop → [DCIM] → the folder where the images you want to import are stored.
- 2 Drag and drop the image files to the hard disk icon.  
The image files are copied to the hard disk.
  - For details on the storage location of the images and file names, see page 126.
- 3 Double-click the hard disk icon → the desired image file in the folder containing the copied files.  
The image is displayed.

## Deleting the USB connection

Perform the procedures from step 1 to 3 below before:

- Disconnecting the cable for multi-use terminal.
- Removing a “Memory Stick Duo” media.
- Inserting a “Memory Stick Duo” media into the camera after copying images from the internal memory.
- Turning off the camera.

- 1 Double-click the disconnect icon on the tasktray.
- 2 Click  (USB Mass Storage Device) → [Stop].
- 3 Confirm the device on the confirmation window, then click [OK].

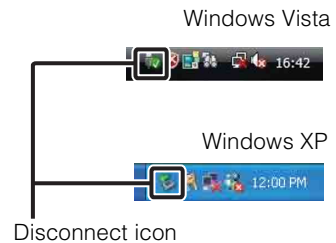

### Note

- Drag and drop the icon of the “Memory Stick Duo” media or the drive icon to the “Trash” icon beforehand when you use a Macintosh computer, and the camera is disconnected from the computer.

# Viewing “Cyber-shot Step-up Guide”

“Cyber-shot Step-up Guide” further introduces how to use the camera and optional accessories.

## Viewing on Windows

When you install “Cyber-shot Handbook”, “Cyber-shot Step-up Guide” is also installed.

- 1 Double-click  (Step-up Guide) on the desktop.

To access “Step-up Guide” from the Start menu, click [Start] → [All Programs] → [Sony Picture Utility] → [Step-up Guide].

## Viewing on Macintosh

- 1 Copy the [stepupguide] folder in the [stepupguide] folder to your computer.
- 2 Select [stepupguide], [language] and then [GB] folder stored in the CD-ROM (supplied), and copy all the files in the [GB] folder to the [img] folder in the [stepupguide] folder that you copied to your computer in step 1. (Overwrite the files in the [img] folder with the files from the [GB] folder.)
- 3 After copying is complete, double-click “stepupguide.hqx” in the [stepupguide] folder to uncompress it, then double-click the generated file “stepupguide”.

### Note

- If an uncompress tool for HQX file is not installed, install the Stuffit Expander.

# Printing still images

You can print still images using the following methods.

- Printing directly using a PictBridge-compliant printer
- Printing directly using a “Memory Stick” media-compliant printer  
For details, see the operating instructions supplied with the printer.
- Printing using a computer  
You can import images to a computer using the supplied “PMB” software and print the images.  
You can insert the date on the image and print it. For details, see the “PMB Guide”.
- Printing at a shop (page 112)

## Notes

- When you print images shot in [16:9] mode, both edges may be cut off.
- You cannot print panoramic images depending on the printer.

## Printing images directly using a PictBridge-compliant printer

Even if you do not have a computer, you can print images shot using the camera by connecting the camera directly to a PictBridge-compliant printer.

**PictBridge** “PictBridge” is based on the CIPA standard. (CIPA: Camera & Imaging Products Association)

- 1 Insert a sufficiently charged battery pack into the camera.
- 2 Connect the camera to the printer.

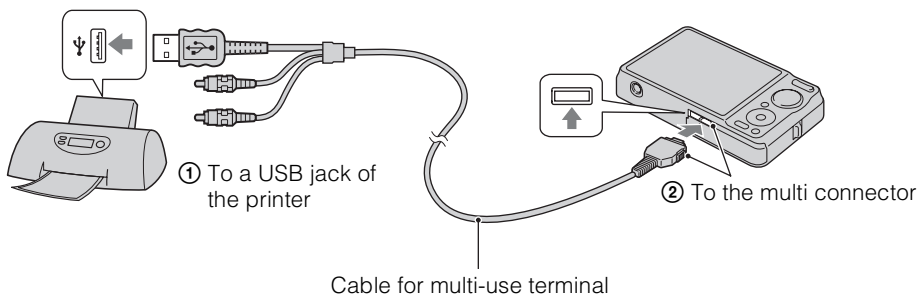

- 3 Turn on the camera and the printer.

After the connection is made, the  indicator appears on the screen.

If the  indicator flashes on the screen of the camera (error notification), check the connected printer.



4 MENU →  (Print) → desired mode → ● on the control button

<b>This Image</b>	Prints the currently displayed image in single-image mode.
<b>Multiple Images</b>	<p>You can select and print multiple images. After step 4, perform the following.</p> <p>① Select an image then press ●. Repeat the above steps until there are no more images to be printed.</p> <p>② MENU → [OK] → ●</p>

5 Desired item → [Start] → ●

<b>Quantity</b>	<p>Selects the number of copies of the specified image to be printed.</p> <ul style="list-style-type: none"> <li>The designated number of images may not all fit onto a single sheet depending on the quantity of images.</li> </ul>
<b>Layout</b>	Selects the number of images you want to print side by side on a sheet.
<b>Size</b>	Selects the size of the printing sheet.
<b>Date</b>	<p>Selects [Date] or [Day&amp;Time] to insert the date and time on images.</p> <ul style="list-style-type: none"> <li>When you choose [Date], the date will be inserted in the order you have selected using [Date &amp; Time Setting] on the camera. This function may not be available depending on the printer.</li> </ul>

### Notes

- Movies cannot be printed.
- If the camera could not be connected to the printer, be sure to set [USB Connect] under  (Main Settings) to [PictBridge].
- Do not disconnect the cable for multi-use terminal while the  (PictBridge Connecting) indicator appears on the screen.

## Printing at a shop

You can take a “Memory Stick Duo” media containing images shot with the camera to a photo printing service shop. As long as the shop supports photo printing services conforming to DPOF, you can make a **DPOF** (Print order) mark on images in advance in the playback mode so that you do not have to reselect them when you print them out at the shop.

### Notes

- You cannot print images stored in the internal memory at a print shop directly from the camera. Copy the images to a “Memory Stick Duo” media (page 97), then take the “Memory Stick Duo” media to the print shop.
- Consult your photo printing service shop as to what types of “Memory Stick Duo” media they handle.
- If “Memory Stick Duo” media are not handled by your photo service shop, copy the images you want to print to another medium such as a CD-R and take it to the shop.
- A “Memory Stick Duo” media Adaptor (sold separately) may be necessary. Consult your photo printing service shop.
- Before you take image data to a shop, always copy (back up) your data to a disk.
- You cannot set the number of prints.
- If you want to superimpose dates on images, consult your photo printing service shop.



# Troubleshooting

If you experience trouble with the camera, try the following solutions.

## ❶ Check the items on pages 113 to 120.

If a code such as “C/E:□□:□□” appears on the screen, see page 121.

## ❷ Remove the battery pack, wait for about one minute, re-insert the battery pack, then turn on the power.

## ❸ Initialize the settings (page 87).

## ❹ Consult your Sony dealer or local authorized Sony service facility.

On repairing cameras with internal memory or Music files function included, data in the camera may be checked on minimum necessity to verify and improve the malfunction symptoms. Sony will not copy or save any of those data.

Additional information on this product and answers to frequently asked questions can be found at our Customer Support Website.  
<http://www.sony.net/>

## Battery pack and power

### Cannot insert the battery pack.

- Insert the battery pack correctly by pushing the battery eject lever.

### Cannot turn on the camera.

- After inserting the battery pack into the camera, it may take a few moments for the camera to power up.
- Insert the battery pack correctly.
- The battery pack is discharged. Insert a charged battery pack.
- Use a recommended battery pack.

### The power turns off suddenly.

- Depending on the camera and battery temperature, the power may turn off automatically to protect the camera. In this case, a message is displayed on the LCD screen before the power turns off.
- If you do not operate the camera for about two minutes while the power is on, the camera turns off automatically to prevent wearing down the battery pack. Turn on the camera again.

---

### The remaining charge indicator is incorrect.

- This phenomenon occurs when you use the camera in an extremely hot or cold location.
- A discrepancy arose between the remaining charge indicator and the actual remaining battery charge. Fully discharge the battery pack once, then charge it to correct the indication.
- The battery pack is dead (page 129). Replace it with a new one.

---

### Cannot charge the battery pack.

- You cannot charge the battery pack using the AC-LS5K/AC-LS5 AC Adaptor (sold separately). Use the battery charger to charge the battery.

---

### The CHARGE lamp flashes while charging the battery.

- Remove and reinsert the battery pack, making sure it is installed correctly.
- The temperature may be inappropriate for charging. Try charging the battery pack again within the proper charging temperature range (10°C to 30°C (50°F to 86°F)).
- Refer to page 130 for details.

## Shooting still images/movies

---

### Cannot record images.

- Check the free capacity of the internal memory or “Memory Stick Duo” media. If it is full, do one of the following:
  - Delete unnecessary images (page 40).
  - Change the “Memory Stick Duo” media.
- You cannot record images while charging the flash.
- Movies with the size set to [1280×720] can only be recorded on a “Memory Stick PRO Duo” media. When using recording media other than “Memory Stick PRO Duo” media, set the movie image size to [VGA].
- Set [Demo Mode] to [Off] (page 86).

---

### Smile Shutter function does not work.

- No image is shot if a smiling face is not detected.
- Set [Demo Mode] to [Off] (page 86).

---

### Anti-blur function does not work.

- The anti-blur function does not work when  appears on the display.
- The anti-blur function may not work properly when shooting night scenes.
- Shoot after pressing the shutter button halfway down.



---

### Recording takes a long time.

- When the shutter speed becomes slower than a certain speed in low light conditions, the NR (Noise Reduction) slow shutter function is activated automatically to reduce the image noise. Under such conditions, recording takes a long time.
- The Anti Blink function is working. Reset [Anti Blink] to [Off] (page 64).

---

### The image is out of focus.

- The subject is too close. When shooting, make sure to position the lens farther away from the subject than the shortest shooting distance (approximately 5 cm (2 inches) (W)/50 cm (19 3/4 inches) (T) from the lens).
-  (Twilight),  (Landscape) or  (Fireworks) mode is selected in the Scene Selection when shooting still images.

---

### Zoom does not work.

- You cannot use the optical zoom when shooting in Sweep Panorama.
- You cannot use the Smart zoom depending on the image size (page 80).
- You cannot use the digital zoom when:
  - Shooting movies.
  - The Smile Shutter is working.











---

### Cannot select the Face Detection function.

- You can select Face Detection only when the focus mode is set to [Multi AF] and the metering mode is set to [Multi].

---

### The flash does not work.

- You cannot use the flash when:
  - Burst or Exposure Bracket mode is selected (page 35).
  -  (High Sensitivity),  (Twilight) or  (Fireworks) mode is selected in Scene Selection.
  - Shooting in Sweep Panorama, Movie Mode, Anti Motion Blur or Hand-held Twilight mode.
- Set the flash to  (On) (page 32) when the Scene Selection mode is set to  (Landscape),  (Gourmet),  (Pet),  (Beach),  (Snow) or  (Underwater) mode.



---

### Fuzzy white circular spots appear in images shot using the flash.

- Particles (dust, pollen, etc.) in the air reflected the flash light and appeared in the image. This is not a malfunction.

---

### The close-up shoot function (Macro) does not work.

- The camera automatically adjusts the focus. Press and hold the shutter button halfway down. Focus adjustment may take some time when shooting a close subject.
-  (Landscape),  (Twilight) or  (Fireworks) mode is selected in the Scene Selection.

---

### The date and time are not displayed on the LCD screen.

- While shooting, the date and time are not displayed. They are displayed only during playback.

---

### Cannot insert dates on images.

- This camera does not have a feature for superimposing dates on images. By using “PMB”, you can print or save images with the date (page 105).

---

### The F value and shutter speed flash when you press and hold the shutter button halfway down.

- The exposure is incorrect. Correct the exposure (page 49).

---

### The image colors are not correct.

- Adjust the White Balance (page 51).

---

**Noise appears in the image when you view the screen in a dark place.**

- The camera is attempting to increase the visibility of the screen by temporarily brightening the image under conditions of low illumination. There is no effect on the recorded image.

---

**The eyes of the subject come out red.**

- Set [Red Eye Reduction] to [Auto] or [On] (page 65).
- Shoot the subject at a distance closer than the flash range using the flash.
- Light the room and shoot the subject.
- Retouch the image using [Retouch] → [Red Eye Correction] in viewing menu (page 72), or correct using “PMB”.

---

**Dots appear and remain on the screen.**

- This is not a malfunction. These dots are not recorded.

---

**Cannot shoot images in succession.**

- The internal memory or “Memory Stick Duo” media is full. Delete unnecessary images (page 40).
- The battery level is low. Insert charged battery pack.

---

**The same image is shot several times.**

- Set [Burst/Bracket] to [Normal] (page 35).
- [Scene Recognition] is set to [Advanced] (page 58).

## Viewing images

---

**Cannot play back images.**

- The folder/file name has been changed on your computer.
- No guarantees are made for playing back, on this camera, files containing images which were processed on a computer or images which were shot using other cameras.
- The camera is in USB mode. Delete the USB connection (page 109).
- You may not be able to play back some images stored on the “Memory Stick Duo” media shot using other cameras. Play such images in Folder View (page 70).
- This is caused by copying images on your computer to the “Memory Stick Duo” media without using the “PMB”. Play such images in Folder View (page 70).

---

**The date and time are not displayed.**

- The screen display is set to display images only. Press the DISP (Screen Display Settings) button to display information (page 17).

---

**The image appears rough right after playback starts.**

- This may happen due to image processing. This is not a malfunction.

---

**Left and right sides of the screen are shown in black.**

- [Auto Orientation] is set to [On] (page 81).

---

**Cannot display images in index mode.**

- The mode dial is set to EASY (Easy Shooting). Set the mode dial to other modes to play back images.

---

### Cannot hear music during slideshow.

- Transfer music files to the camera with “Music Transfer” (pages 105, 107).
- Confirm that the volume setting and slideshow setting are correct (page 67).
- Slideshow is played back with [Continuous Playback]. Select [Slideshow with music] and play back.

---

### The image does not appear on the TV.

- Check [Video Out] to see if the video output signal of the camera is set to the color system of your TV (page 89).
- Check whether the connection is correct (page 101).
- If the USB connector of the cable for multi-use terminal is connected to another device, disconnect it (page 109).
- When shooting movies with the camera and a TV connected, the image being shot is not displayed on the TV.

## Deleting

### Cannot delete an image.

- Cancel the protection (page 74).

## Computers

### “Memory Stick PRO Duo” media is not recognized by a computer with a “Memory Stick” media slot.

- Check that the computer and the “Memory Stick” media Reader/Writer support “Memory Stick PRO Duo” media. Users of computers and “Memory Stick” media Readers/Writers made by manufacturers other than Sony should contact those manufacturers.
- If “Memory Stick PRO Duo” media is not supported, connect the camera to the computer (pages 108, 109). The computer recognizes the “Memory Stick PRO Duo” media.

---

### Your computer does not recognize the camera.

- When the battery level is low, insert the charged battery pack or use the AC adaptor (sold separately).
- Set [USB Connect] to [Auto] or [Mass Storage] (page 90).
- Use the cable for multi-use terminal (supplied).
- Disconnect the cable for multi-use terminal from both the computer and the camera, and connect it again firmly.
- Disconnect all equipment other than the camera, the keyboard and the mouse from the USB connectors of your computer.
- Connect the camera directly to your computer without passing through a USB hub or other device.

---

### Cannot import images.

- Connect the camera and your computer correctly making a USB connection (page 108).
- When you shoot images with a “Memory Stick Duo” media formatted by a computer, you may not be able to import the images to a computer. Shoot using a “Memory Stick Duo” media formatted by the camera (page 93).

---

### After making a USB connection, “PMB” does not start automatically.

- Make the USB connection after the computer is turned on.

---

### Cannot play back images on your computer.

- If you are using “PMB”, refer to “PMB Guide” (page 105).
- Consult the computer or software manufacturer.

---

### The image and sound are interrupted by noise when you view a movie on a computer.

- You are playing back the movie directly from the internal memory or the “Memory Stick Duo” media. Import the movie to the hard disk of your computer, then play back the movie from the hard disk (page 105).

---

### Images once exported to a computer cannot be viewed on the camera.

- Export them to a folder recognized by the camera, such as “101MSDCF” (page 126).
- When using software other than “PMB”, the information may not be updated correctly, so images may turn blue or otherwise not be displayed correctly. This is not a malfunction.
- When blue images appear, view them in the Folder View mode or delete them with the camera.
- Event View is not available on this camera.

## “Memory Stick Duo” media

---

### Cannot insert a “Memory Stick Duo” media.

- Insert the “Memory Stick Duo” media in the correct direction.

---

### You have formatted a “Memory Stick Duo” media by mistake.

- All the data on the “Memory Stick Duo” media is deleted by formatting. You cannot restore it.

## Internal memory

---

### Cannot playback or record images using the internal memory.

- There is a “Memory Stick Duo” media inserted in the camera. Remove it.

---

### Cannot copy the data stored in the internal memory to a “Memory Stick Duo” media.

- The “Memory Stick Duo” media is full. Copy to a “Memory Stick Duo” media with sufficient capacity.

---

### Cannot copy the data on the “Memory Stick Duo” media or the computer to the internal memory.

- This feature is not available.

## Printing

See “PictBridge-compliant printer” together with the following items.

---

### Cannot print an image.

- Refer to the operation manual of the printer.

---

### Images are printed with both edges cut off.

- Depending on your printer, all the edges of the image may be cut off. Especially when you print an image shot with the image size set to [16:9], the lateral end of the image may be cut off.
- When printing images using your printer, cancel the trimming or borderless settings. Consult the printer manufacturer as to whether the printer provides these functions or not.
- When having images printed at a digital print shop, ask the shop whether they can print the images without cutting off both edges.

---

### Cannot print images with the date.

- Using “PMB”, you can print images with date (page 105).
- The camera does not have a feature for superimposing dates on images. However, because the images shot with the camera include information on the recording date, you can print images with the date superimposed if the printer or the software can recognize Exif information. For compatibility with Exif information, consult the manufacturer of the printer or the software.
- If you use a photo printing service, ask them to superimpose the dates on images.

## PictBridge-compliant printer

### A connection cannot be established.

- The camera cannot be connected directly to a printer that is not compliant with the PictBridge standard. Consult the printer manufacturer as to whether the printer is compliant with PictBridge or not.
- Check that the printer is turned on and can be connected to the camera.
- Set [USB Connect] to [PictBridge] (page 90).
- Disconnect and connect the cable for multi-use terminal again. If an error message is indicated on the printer, refer to the operating instructions supplied with the printer.

---

### Cannot print images.

- Check that the camera and the printer are properly connected using the cable for multi-use terminal.
- Turn on the printer. For details, refer to the operating instructions supplied with the printer.
- If you select [Exit] during printing, images may not be printed. Disconnect and connect the cable for multi-use terminal again. If you still cannot print your images, disconnect the cable for multi-use terminal, turn the printer off and then on, then connect the cable for multi-use terminal again.
- Movies cannot be printed.
- Images shot using other cameras, or images modified with a computer may not be printed.
- Panoramic images may not be printed depending on the printer or may print in cut off panoramic image.

---

### Printing is canceled.

- Confirm that you have disconnected the cable for multi-use terminal before the  (PictBridge Connecting) mark disappears.

---

### Cannot insert the date or print images in the index mode.

- The printer does not provide these functions. Consult the printer manufacturer as to whether the printer provides these functions or not.
- The date may not be inserted in the index mode depending on the printer. Consult the printer manufacturer.

---

**“---- -- --” is printed on the date-inserted part of the image.**

- The image does not have the recording data so the date cannot be inserted. Set [Date] to [Off] and print the image again (page 111).

---

**Cannot print the image at the size selected.**

- When you use paper of a different size after connecting the printer to the camera, disconnect and then reconnect the cable for multi-use terminal.
- The print setting of the camera differs from that of the printer. Change the setting of either the camera (page 111) or the printer.
- Consult the printer manufacturer as to whether the printer can provide the desired size.

---

**Cannot operate the camera after cancelling printing.**

- Wait for a while as the printer is carrying out the cancellation. It may take some time depending on the printer.

## Others

---

**The lens gets fogged.**

- Moisture condensation has occurred. Turn off the camera and leave it for about an hour before using it.

---

**The camera turns off with the lens portion extended.**

- The battery pack is discharged. Replace it with a charged battery pack, then turn the camera on again.
- Do not attempt to force the lens that has stopped moving.

---

**The camera becomes warm when you use it for a long time.**

- This is not a malfunction.

---

**The Clock Set screen appears when you turn on the camera.**

- Set the date and time again (page 100).
- The internal rechargeable backup battery has discharged. Insert a charged battery, and set aside for 24 hours or more with the power left off.

---

**The date or time is incorrect.**

- The Area Setting is set to a different location than your current location. Change the setting by MENU → [Settings] → [Clock Settings] → [Area Setting].



# Warning indicators and messages

## Self-diagnosis display

If a code starting with a letter of the alphabet appears, the self-diagnosis function on the camera is working. The last two digits (indicated by □□) will differ depending on the state of the camera.

If you cannot solve the problem even after trying the following corrective actions a few times, the camera may need repair.

Contact your Sony dealer or local authorized Sony service facility.

---

### C:32:□□

- There is trouble with the camera's hardware. Turn the power off and on again.

---

### C:13:□□

- The camera cannot read or write data on the "Memory Stick Duo" media. Try turning off and on the camera again, or taking out and inserting the "Memory Stick Duo" media several times.
- The internal memory has experienced a format error, or an unformatted "Memory Stick Duo" media is inserted. Format the internal memory or the "Memory Stick Duo" media (page 93).
- The inserted "Memory Stick Duo" media cannot be used with the camera, or the data is damaged. Insert a new "Memory Stick Duo" media.

---

### E:61:□□

### E:62:□□

### E:91:□□

- A camera malfunction has occurred. Initialize the camera (page 87), then turn the power on again.

## Messages

If the following messages appear, follow the instructions.



- The battery level is low. Charge the battery pack immediately. Depending on the conditions of use or the type of battery pack, the indicator may flash even though there are still 5 to 10 minutes of remaining battery time left.

---

### For use with compatible battery only

- The battery inserted is not an NP-BG1 (supplied)/NP-FG1 (sold separately) battery pack.

---

### System error

- Turn the power off and then on again.

---

## Camera overheating

### Allow it to cool

- The camera temperature has risen. The power may turn off automatically, or you may be unable to record movies. Leave the camera in a cool location until the temperature goes down.

---

## Internal memory error

- Turn the power off and then on again.

---

## Reinsert the “Memory Stick”

- The inserted “Memory Stick Duo” media cannot be used in the camera (page 127).
- The terminal section of the “Memory Stick Duo” media is dirty.
- The “Memory Stick Duo” media is damaged.

---

## “Memory Stick” type error

- The inserted “Memory Stick Duo” media cannot be used in the camera (page 127).

---

## This “Memory Stick” may not record or play

- The inserted “Memory Stick Duo” media cannot be used in the camera (page 127).

---

## Error formatting internal memory

### Error formatting “Memory Stick”

- Format the media again (page 93).

---

## “Memory Stick” locked

- You are using the “Memory Stick Duo” media with the write-protect switch, and the switch is set to the LOCK position. Set the switch to the recording position.

---

## Read only “Memory Stick”

- The camera cannot record or delete images on this “Memory Stick Duo” media.

---

## No images

- No images that can be played back have been recorded in the internal memory.
- No images that can be played back have been recorded in this folder of the “Memory Stick Duo” media.
- When images recorded with other cameras cannot be played back on this camera, view the images in Folder View mode (page 70).

---

## No still images

- The selected folder or date does not contain a file that can be played back in a slideshow.

---

## File found which was not recognized

- You tried to delete a folder containing a file that cannot be played on this camera. Delete the file with a computer and then delete the folder.

---

### Folder error

- A folder with the same first three digit number already exists on the “Memory Stick Duo” media (for example: 123MSDCF and 123ABCDE). Select another folder, or create a new folder (pages 94, 95).

---

### Cannot create more folders

- The folder with a name beginning with “999” exists on the “Memory Stick Duo” media. You cannot create any folders if this is the case.

---

### Empty folder contents

- You tried to delete a folder containing one or more files. Delete all of the files and then delete the folder.

---

### Folder protected

- You tried to delete a folder that was made read-only by PC or an other device.

---

### File error

- An error occurred while the image was playing back.  
No guarantees are made for playing back, on this camera, files containing images which were processed on a computer or images which were shot using other cameras.

---

### Read only folder

- You have selected a folder that cannot be set as a recording folder on the camera. Select another folder (page 95).

---

### File protected

- Release the protection (page 74).

---

### Image size over limit

- You are playing back an image with size that cannot be played back on the camera.

---

### Unable to detect face for retouch

- You may not be able to retouch the image depending on the image.

---

### (Vibration warning indicator)

- Camera shake may occur due to insufficient light. Use the flash, turn on the anti-blur function, or mount the camera on a tripod to secure the camera.

---

### 1280×720 (Fine) is not available

### 1280×720 (Standard) is not available

- Only “Memory Stick PRO Duo” media is compatible of recording movies with an image size of [1280×720]. Use “Memory Stick PRO Duo” media or set the movie image size to [VGA].

---

### Turn the power off and on again

- The lens malfunction.

---

## Maximum number of images already selected

- Up to 100 files can be selected when using [Multiple Images].
  - You can add **DPOF** (Print order) marks to up to 999 files. Cancel the selection.
- 



- The data transmission to the printer may not be completed yet. Do not disconnect the cable for multi-use terminal.
- 

## Processing...

- The printer is canceling the current print job. You cannot print until it is finished. This may take time, depending on the printer.
- 

## Error Playing Music

- Delete the Music file, or replace it with an uncorrupted Music file.
  - Execute [Format Music], then download a new Music files.
- 

## Error Formatting Music

- Execute [Format Music].
- 

## Operation cannot be executed in unsupported files

- Processing and other editing functions of the camera cannot be performed on image files that have been processed using a computer or images that were recorded with other cameras.
- 

## Recovering Image Database File...

- The camera restores the date information etc. in cases where images have been deleted on a PC, etc.
- 



- The number of images exceeds that for which date management in a database file by the camera is possible. Delete images from Date View.
- 

## No internal memory space remaining

### Delete images?

- The internal memory is full. To record to the internal memory, select [Yes] and delete unwanted images.
- 

## Image Database File error Cannot recover

- Import all of the images to the computer with “PMB”, and format the “Memory Stick Duo” media or the internal memory (page 93).  
When you cannot import all of the images to the computer with “PMB”, import all of the images to the computer without using “PMB” (page 108).  
To view the images again with the camera, export the imported images to the camera with “PMB”.

---

## Recording function unavailable due to high internal temperature

- The camera temperature has risen. You cannot record images until the temperature has dropped.

---

## Recording has stopped due to increased camera temperature

- Recording has stopped due to a rise in temperature while recording a movie. Please wait until the temperature goes down.



- When you record movies for a long time, the camera temperature rises. In this case, stop recording movies.

# Image file storage destinations and file names

The image files recorded with the camera are grouped as folders on the “Memory Stick Duo” media or the internal memory.

- A** Folder containing image data recorded using a camera not equipped with the folder creating function.
- B** Folder containing still image data recorded using the camera.
- C** Folder containing movie data recorded using the camera.

Example: viewing folders on Windows Vista

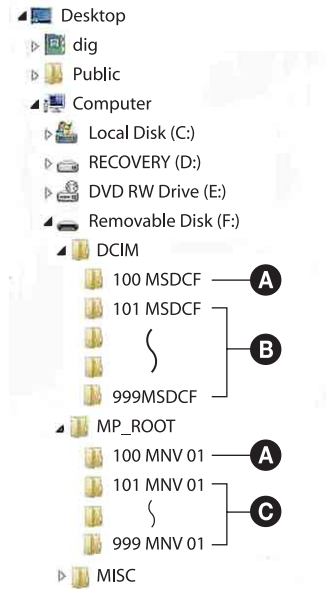

## Notes

- You cannot record any images to the “100MSDCF” or “100MNV01” folders. The images in these folders are available only for viewing.
  - You cannot record/play back any images of the “MISC” folder.
  - Image files are named as follows:
    - Still image files: DSC0□□□□.JPG
    - Movie files
      - 1280×720: M4H0□□□□.MP4
      - VGA: M4V0□□□□.MP4
    - Index image files that are recorded when you record movies
      - 1280×720: M4H0□□□□.THM
      - VGA: M4V0□□□□.THM
- stands for any number within the range from 0001 to 9999. The numerical portions of the name of a movie file recorded in Movie Mode and its corresponding index image file are the same.

# “Memory Stick Duo” media

A “Memory Stick Duo” media is a compact, portable IC recording medium. The types of “Memory Stick Duo” media that can be used with the camera are listed in the table below. However, proper operation cannot be guaranteed for all “Memory Stick Duo” media functions.

“Memory Stick” media type	Recording/Playback
Memory Stick Duo (without MagicGate)	○* <sup>1</sup>
Memory Stick Duo (with MagicGate)	○* <sup>2</sup>
MagicGate Memory Stick Duo	○* <sup>1</sup> * <sup>2</sup>
Memory Stick PRO Duo	○* <sup>2</sup> * <sup>3</sup>
Memory Stick PRO-HG Duo	○* <sup>2</sup> * <sup>3</sup> * <sup>4</sup>

\*<sup>1</sup> High-speed data transfer using a parallel interface is not supported.

\*<sup>2</sup> “Memory Stick Duo” media, “MagicGate Memory Stick Duo” media and “Memory Stick PRO Duo” media are equipped with MagicGate functions. MagicGate is copyright protection technology that uses encryption technology. Data recording/playback that requires MagicGate functions cannot be performed with the camera.

\*<sup>3</sup> [1280×720] size movies can be recorded.

\*<sup>4</sup> This camera does not support 8-bit parallel data transfer. It performs the same 4-bit parallel data transfer as the “Memory Stick PRO Duo” media.

## Notes

- This product is compatible with “Memory Stick Micro” media (“M2”). “M2” is an abbreviation for “Memory Stick Micro” media.
- A “Memory Stick Duo” media formatted with a computer is not guaranteed to operate with the camera.
- Data read/write speeds differ depending on the combination of the “Memory Stick Duo” media and the equipment used.
- Do not remove the “Memory Stick Duo” media while reading or writing data.
- Data may be corrupted in the following cases:
  - When the “Memory Stick Duo” media is removed or the camera is turned off during a read or write operation
  - When the “Memory Stick Duo” media is used in locations subject to static electricity or electrical noise
- We recommend backing up important data.
- Do not press down hard when you write down on the memo area.
- Do not attach a label on the “Memory Stick Duo” media itself nor on a “Memory Stick Duo” media Adaptor.
- When you carry or store the “Memory Stick Duo” media, put it in the case supplied with it.
- Do not touch the terminal section of the “Memory Stick Duo” media with your hand or a metal object.
- Do not strike, bend or drop the “Memory Stick Duo” media.
- Do not disassemble or modify the “Memory Stick Duo” media.
- Do not expose the “Memory Stick Duo” media to water.
- Do not leave the “Memory Stick Duo” media within the reach of small children. They might accidentally swallow it.
- Do not insert anything other than a “Memory Stick Duo” media into the “Memory Stick Duo” media slot. Doing so will cause a malfunction.
- Do not use or store the “Memory Stick Duo” media under the following conditions:
  - High temperature locations such as the hot interior of a car parked in direct sunlight
  - Locations exposed to direct sunlight
  - Humid locations or locations with corrosive substances present

## Notes on using the “Memory Stick Duo” media Adaptor (sold separately)

- To use a “Memory Stick Duo” media with a “Memory Stick” media compliant device, be sure to insert the “Memory Stick Duo” media into a “Memory Stick Duo” media Adaptor. If you insert a “Memory Stick Duo” media into a “Memory Stick” media compliant device without a “Memory Stick Duo” media Adaptor, you might not be able to remove it from the device.
- When inserting a “Memory Stick Duo” media into a “Memory Stick Duo” media Adaptor, make sure the “Memory Stick Duo” media is inserted facing in the correct direction, then insert it all the way in. Incorrect insertion may result in a malfunction.
- When using a “Memory Stick Duo” media inserted into a “Memory Stick Duo” media Adaptor with a “Memory Stick” media compliant device, make sure that the “Memory Stick Duo” media Adaptor is inserted facing the correct direction. Note that improper use may damage the equipment.
- Do not insert a “Memory Stick Duo” media Adaptor into a “Memory Stick” media compliant device without a “Memory Stick Duo” media attached. Doing so may result in malfunction of the unit.

## Notes on using “Memory Stick PRO Duo” media (sold separately)

“Memory Stick PRO Duo” media with a capacity up to 16 GB have been confirmed to operate properly with the camera.

## Notes on using “Memory Stick Micro” media (sold separately)

- To use a “Memory Stick Micro” media with the camera, be sure to insert the “Memory Stick Micro” media into an “M2” Adaptor as large as of Duo size. If you insert a “Memory Stick Micro” media into the camera without an “M2” Adaptor as large as of Duo size, you might not be able to remove it from the camera.
- Do not leave the “Memory Stick Micro” media within the reach of small children. They might accidentally swallow it.



# Battery pack

## On charging the battery pack

We recommend charging the battery pack in an ambient temperature of between 10°C to 30°C (50°F to 86°F). The battery pack may not be effectively charged in temperatures outside this range.

## Effective use of the battery pack

- Battery performance decreases in low temperature surroundings. So in cold places, the operational time of the battery pack is shorter. We recommend the following to ensure longer battery pack use:
  - Put the battery pack in a pocket close to your body to warm it up, and insert it in the camera immediately before you start shooting.
- The battery pack will run out quickly if you use the flash or zoom frequently.
- We recommend having spare battery packs handy for two or three times the expected shooting time, and making trial shots before taking the actual shots.
- Do not expose the battery pack to water. The battery pack is not water-resistant.
- Do not leave the battery pack in extremely hot places, such as in a car or under direct sunlight.

## How to store the battery pack

- Fully discharge the battery pack before storing and store it in a cool, dry place. To maintain the battery pack's function, fully charge the battery pack and then fully discharge it on the camera at least once a year while storing.
- To use the battery pack up, leave the camera in slideshow playback mode until the power goes off.
- To prevent staining the terminal, short-circuiting, etc., be sure to use a supplied battery case when carrying and storing.

## On battery life

- The battery life is limited. Battery capacity decreases over time and through repeated use. If decreased usage time between charges becomes significant, it is probably time to replace it with a new one.
- The battery life varies according to how it is stored and the operating conditions and environment in which each battery pack is used.

## Compatible battery pack

- The NP-BG1 (supplied) can be used only in G type compatible Cyber-shot models.
- If you use the NP-FG1 battery pack (sold separately), the minutes also appear after the battery remaining indicator ( 60 Min).

# Battery charger

- Only NP-BG type or NP-FG type battery packs (and no others) can be charged in the battery charger (supplied). Batteries other than the specified kind may leak, overheat, or explode if you attempt to charge them, posing a risk of injury from electrocution and burns.
- Remove the charged battery pack from the battery charger. If you leave the charged battery pack in the charger, battery life may be shortened.
- The CHARGE lamp of the supplied battery charger flashes in either way:
  - Fast flashing: Turns the light on and off repeatedly at the interval of 0.15 seconds.
  - Slow flashing: Turns the light on and off repeatedly at the interval of 1.5 seconds.
- When the CHARGE lamp flashes fast, remove the battery pack being charged, and then insert the same battery pack into the battery charger securely again. When the CHARGE lamp flashes fast again, this may indicate a battery error or that a battery pack other than the specified type has been inserted. Check that the battery pack is the specified type. If the battery pack is the specified type, remove the battery pack, replace it with a new one or another one and check if the battery charger operates correctly. If the battery charger operates correctly, a battery error may have occurred.
- When the CHARGE lamp flashes slowly, it indicates that the battery charger stops charging temporarily on standby. The battery charger stops charging and enters the standby status automatically when the temperature is outside of the recommended operating temperature. When the temperature gets back within the appropriate range, the battery charger resumes charging and the CHARGE lamp lights up again. We recommend charging the battery pack in an ambient temperature of between 10°C to 30°C (50°F to 86°F).

# Intelligent Pantilter

Intelligent Pantilter (sold separately) allows you to shoot images automatically by having the camera detect the faces of subjects.

For details, see the operating instructions supplied with Intelligent Pantilter.

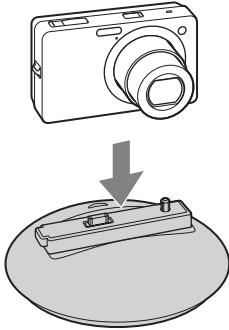

Table of  
contents

Operation  
Search

MENU/Settings  
Search

Index

# Index

## A

AF Illuminator .....	78
AF range finder frame .....	54
Anti Blink .....	64
Anti Motion Blur .....	26
Area Setting .....	99
Auto Orientation .....	81

## B

Battery charger .....	130
Battery pack .....	129
Beach .....	28
Beep .....	83
Blink Alert .....	82
Bracket .....	35
Bracket Settings .....	57
Burst .....	35, 47

## C

Calendar .....	70
CD-ROM .....	104
Center AF .....	54
Center-weighted metering .....	56
Change REC.Folder .....	95
Changing the display .....	17
Clock Settings .....	100
COMPONENT .....	88
Computer .....	104
Importing images .....	108, 109
Connecting	
Computer .....	108
Printer .....	111
TV .....	101
Continuous Playback .....	67
Control button .....	13
Copy .....	97
Create REC.Folder .....	94

## D

Date .....	112
Date & Time Setting .....	100
Delete .....	40, 73
Delete REC.Folder .....	96
Demo Mode .....	86
Digital Zoom .....	80
DISP .....	17
Display Burst Group .....	71
Download Music .....	91
DPOF .....	75
DRO .....	63

## E

Easy Shooting .....	21
Easy Viewing .....	22
EV .....	49
Exposure .....	49

## F

Face Detection .....	61
File Number .....	98
Fireworks .....	28
Flash .....	32, 48
Focus .....	54
Folder	
Changing .....	95
Creating .....	94
Deleting .....	96
Selecting .....	77
Format .....	93
Format Music .....	92
Function Guide .....	85

## G

Gourmet .....	28
Grid Line .....	79

**H**

Hand-held Twilight.....	27
HD(1080i).....	88
High Sensitivity.....	28
Histogram.....	18

**I**

Identifying parts.....	13
Image Index.....	39
Image Size.....	44
Initialize.....	87
Install.....	105
Intelligent Auto Adjustment.....	20
Intelligent Pantiliter.....	131
Internal memory.....	19
ISO.....	50

**L**

Landscape.....	28
Language Setting.....	84

**M**

Macintosh computer.....	104
Mass Storage.....	90
“Memory Stick Duo” media.....	127
MENU.....	10
Menu screen.....	10
Metering Mode.....	56
Mode dial.....	16
Movie Mode.....	30, 41
Movie shooting mode.....	42
MTP.....	90
Multi AF.....	54
Multi connector.....	101, 108, 111
Multi-pattern metering.....	56
Music Transfer.....	105, 107

**N**

NTSC.....	89
-----------	----

**O**

Optical zoom.....	31, 80
OS.....	104

**P**

PAL.....	89
PC.....	104
Pet.....	28
PictBridge.....	90, 111
Pixel.....	46
Playback.....	37
Playback zoom.....	38
PMB.....	105
Precision digital zoom.....	80
Print.....	75, 111
Print order mark.....	75, 112
Program Auto.....	23
Protect.....	74
PTP.....	90

**R**

Red Eye Correction.....	72
Red Eye Reduction.....	65
Retouch.....	72
Rotate.....	76

**S**

Scene Recognition.....	58
Scene Selection.....	28
Screen.....	17
SD.....	88
Select Folder.....	77
Selected-face Memory.....	62
Self-diagnosis display.....	121
Self-Timer.....	34
Settings.....	12
Shooting	
Movie.....	30
Still image.....	20
Shooting Direction.....	43
Slideshow.....	67
Slideshow with music.....	68
Slow Synchro.....	32
Smart zoom.....	80
Smile Detection Sensitivity.....	60
Smile Shutter.....	33
Snow.....	28

Soft Snap .....	28
Software .....	105
Spot AF .....	54
Spot metering .....	56
SteadyShot .....	66
Sweep Panorama .....	24

## T

Trimming .....	72
Troubleshooting .....	113
TV .....	101
Twilight .....	28
Twilight Portrait .....	28

## U

Underwater .....	29
Underwater White Balance .....	53
Unsharp masking .....	72
USB Connect .....	90

## V

VGA .....	44
Video Out .....	89
View Mode .....	70

## W

Warning indicators and messages .....	121
White Balance .....	51
Windows computer .....	104

## Z

Zoom .....	31
------------	----

## Notes on the License

“C Library”, “Expat” and “zlib” software are provided in the camera. We provide this software based on license agreements with their owners of copyright. Based on requests by the owners of copyright of these software applications, we have an obligation to inform you of the following. Please read the following sections.

Read “license1.pdf” in the “License” folder on the CD-ROM. You will find licenses (in English) of “C Library”, “Expat”, “zlib”, “dtoa”, “pcre” and “libjpeg” software.

THIS PRODUCT IS LICENSED UNDER THE MPEG-4 VISUAL PATENT PORTFOLIO LICENSE FOR THE PERSONAL AND NON-COMMERCIAL USE OF A CONSUMER FOR (i) ENCODING VIDEO IN COMPLIANCE WITH THE MPEG-4 VISUAL STANDARD (“MPEG-4 VIDEO”)

AND/OR

(ii) DECODING MPEG-4 VIDEO THAT WAS ENCODED BY A CONSUMER ENGAGED IN A PERSONAL AND NON-COMMERCIAL ACTIVITY AND/OR WAS OBTAINED FROM A VIDEO PROVIDER LICENSED BY MPEG LA TO PROVIDE MPEG-4 VIDEO.

NO LICENSE IS GRANTED OR SHALL BE IMPLIED FOR ANY OTHER USE. ADDITIONAL INFORMATION INCLUDING THAT RELATING TO PROMOTIONAL, INTERNAL AND COMMERCIAL USES AND LICENSING MAY BE OBTAINED FROM MPEG LA, LLC.

SEE

[HTTP://WWW.MPEGLA.COM](http://www.mpegla.com)

## On GNU GPL/LGPL applied software

The software that is eligible for the following GNU General Public License (hereinafter referred to as “GPL”) or GNU Lesser General Public License (hereinafter referred to as “LGPL”) are included in the camera.

This informs you that you have a right to have access to, modify, and redistribute source code for these software programs under the conditions of the supplied GPL/LGPL.

Source code is provided on the web. Use the following URL to download it.

<http://www.sony.net/Products/Linux/>

We would prefer you do not contact us about the contents of source code.

Read “license2.pdf” in the “License” folder on the CD-ROM. You will find licenses (in English) of “GPL”, and “LGPL” software.

To view the PDF, Adobe Reader is needed. If it is not installed on your computer, you can download it from the Adobe Systems web page:

<http://www.adobe.com/>

## Regarding the license for “Music Transfer” included on the CD-ROM (supplied)

MPEG Layer-3 audio coding technology and patents licensed from Fraunhofer IIS and Thomson.