

GPSmile⁶² NAV Slim

Portable Automobile Navigation System

Product User Manual



Version: 1.0

September 2008

Registered info

HOLUX and GPSmile are trademarks of HOLUX Technology, Inc.

All other trademarks belong to registered companies.

Note

- The contents of this manual will be modified without further notice.
- The operation temperature for the product is between 0°C ~40°C .
- Operating or recharging in an environment with a temperature over 45 °C might cause the system to malfunction. However, this should be considered a normal phenomenon. Please do not operate under extreme temperatures.

Safety Precautions

- Use the power adapter included with the package. Using other power adapters than the one provided will result to malfunction and could prove to be dangerous.
- The device should only be used with the supplied batteries.
- About the power adapter:
 1. Do not use the power adapter in a wet environment. When hands and feet are wet, do not touch the power adapter.
 2. While using the power adaptor, ensure that the area is well ventilated. Do not let paper or other material cover the power adaptor, as this will interfere with cooling. Do not use the power adaptor whilst it is in a bag.
 3. Do not attempt to repair the device. If device is damaged or is in a wet environment, replace the device immediately.
 4. It is not recommended to charge from a PC because the PC power voltage is not enough to supply the device.
- About the battery
 1. Use only the original factory approved charger.
 2. A Lithium battery is built into the device. To prevent fire or skin burns, do not disassemble, pierce, impact, or expose the battery to fire. The battery will crack, explode, or release dangerous chemicals if placed in a fire.
- Important instructions
 1. Note: Replacing with an incorrect battery may result in an explosion. When disposing of the battery, follow the instructions. The replacement battery must be a factory approved original.
 2. Regulations must be observed when recycling or disposing of batteries.
 3. The battery should only be used in this device.

Warranty Statement

- This warranty applies to parts and services of GPSmile 62 that are manufactured and sold through Holux Technology Inc. The local area covered is Taiwan; the warranty length is one year from date of purchase (starting from the date on the sales receipt). Under normal user operation, Holux Technology provides free repair services.
 - ❖ After repair, the replaced parts are the properties of Holux Technology Inc.
- Holux Technology is not responsible for providing repairs or replacements of any software; Holux Technology does not provide any warranty service for third party software/hardware.
- Important instructions

Note: This warranty does not cover damage or malfunction from the below causes: unauthorized disassembly/modification of unit, abuse or incorrect usage, accidental and other unpreventable causes, operation under variables mentioned that are different from those in this product user manual, using parts not made or sold by Holux Technology, or repairs done by anyone other than Holux Technology and authorized retail/service providers.

- ❖ Expendable parts are not covered in the warranty.
- ❖ Holux Technology is not responsible for any program, data, or portable storage media damages or loss. Please contact your local Holux Technology authorized service provider to learn more about geographical limitations, proof of purchase requests, response time agreements, and other specific maintenance service requests.

Technical Support

- If there are any questions regarding the use of this product, please log on to the website www.holux.com and see the FAQ.
- If answers cannot be found on the website, please send us an e-mail at info@holux.com, stating your query and location.

Maintenance Service

HOLUX Technology, Inc.

+886-3-6687000

Web Site: www.holux.com

E-mail: info@holux.com

or

Contact your nearest dealer, for further support.

HOLUX Technology, Inc.

www.holux.com

Table of Contents

Warranty Statement	iii
Technical Support	iv
Maintenance Service	iv
Preface	1
Symbols	1
Important Notice	1
Other Functions	2
First time use	3
Copyright	3
Important Notice	3
Package Contents	4
Basic Operation	5
Introduction	5
Getting Started	8
Micro SD memory card installation	8
Charging	10
Using Home / Travel adapter:	10
Using the In-Vehicle Bracket	13
Operating Methods	17
Startup	17
Shutdown	17
Using Functions	18
Function Menu Image Browsing Function	19
Setting	21
Volume & Light	21

Time	23
Panel Adjustment	24
Reset GPS	26
Version.....	28
Language	29
Startup Message	29
Hot Key	30
Bluetooth (Optional function)	31
Make a call	31
Phonebook.....	33
Call History	35
Device List	36
Device Manager	37
Settings.....	37
Search Device	38
Disconnect	41
Information	41
Troubleshooting.....	42
System reset	42
Normal Care and Maintenance	43
Storage	44
Appendix.....	45
Specifications	45
Federal regulations	47

Preface

We appreciate your purchase of the GPSmile 62.

Please read all instructions thoroughly for a full understanding of the products' features.

Symbols

For fast reference of the data you wish to find, this manual uses the following symbols.

- ✓ This icon means you should take note of the message and read during use.
- ☠ This icon means warning and you should take care not to damage the unit.
- ☞ This icon means useful tips for extra information while using.

Important Notice

- This system only provides a navigational reference. Do not use this system for any directional, distance, and geographic precise measurements.
- The first GPS positioning should be performed at a single set point in a wide-open area without building shelters. The length of time it takes to position will depend on the satellite signal strength, and cloud levels. It will possibly taking up to 10 minutes.
- GPS (Global Positioning System) is the satellite system used by the United States of America Department of Defense. All maintenance and operations are also managed by the United States of America Department of Defense. Should the system be modified and adjusted, the precision and operation of the GPS related systems might be affected.
- Any wireless communication products (mobile phone, radio, speed detection unit etc) might affect the GPS signal and result in a poor signal.
- For safety reasons, do not operate this system while driving a vehicle.

- Do not leave this unit under your front windshield after you leave the vehicle. Exposure to high temperatures might be dangerous and cause the battery to overheat, resulting in malfunction of the device.
- Window tinting might interfere with the reception of satellite signals. We recommend that you install a vehicle antenna to strengthen and stabilize the signal.
- The planned navigational route is for reference only; changes in roadside conditions (one way streets, no right turns) may happen so please respond according to the situation and decide whether or not to follow the planned course.
- When placing this system in the vehicle, please secure it on the car with brackets to ensure safety. The recommended installation location is illustrated below.

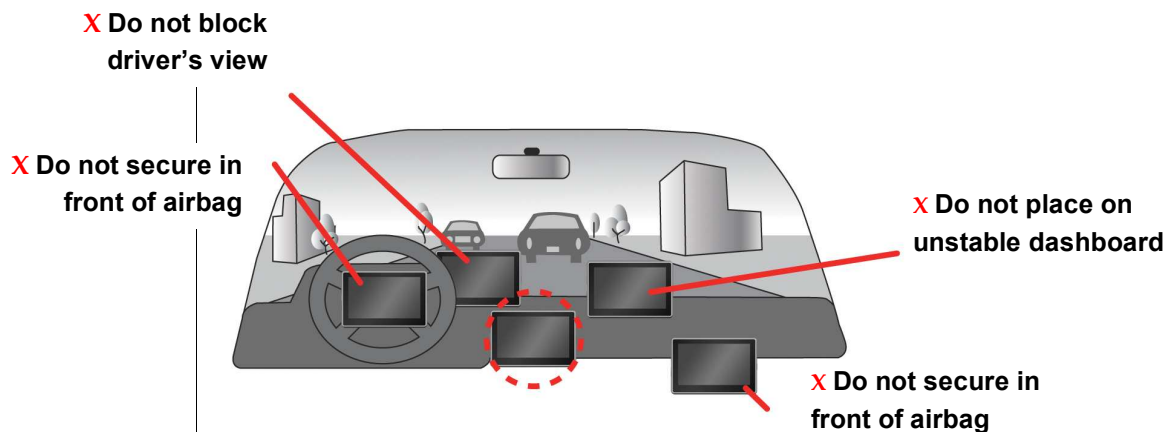

- Differences between manufactured and shipped versions may be present; this software may be updated frequently. If the descriptions in this manual are different from your software version, please follow the software version currently on hand.

Other Functions

- Image display: displays photographs or image files

First time use

Copyright

Without the written consent of HOLUX Technology, Inc, this manual, including the product and the software, may not be duplicated, transmitted, recorded or saved on storage devices. Furthermore, it shall not be translated under any circumstances into any other languages.

Copyright ©2008 HOLUX Technology, Inc. All rights reserved.

Important Notice

Please thoroughly read this manual of operating instructions and explanations. Only use original factory approved batteries and accessories to prevent unexpected damage. If the correct procedures were not followed for operation or incompatible accessories were connected, this is a violation of the warrantee agreement and will automatically void the warrantee. This may also cause personal safety issues.

Package Contents

Your product should include the following accessories:



NAV-62 Unit



In-vehicle Bracket fixing



Car Adapter



Home / Travel Adapter
(Optional)



Micro SD Card
(Optional)



CD-ROM

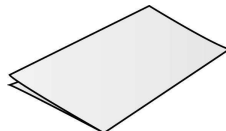

Quick Guide

Basic Operation

Introduction

Front View

5" TFT
LCD with
touch
screen



Rear View

External Antenna port



Left Side

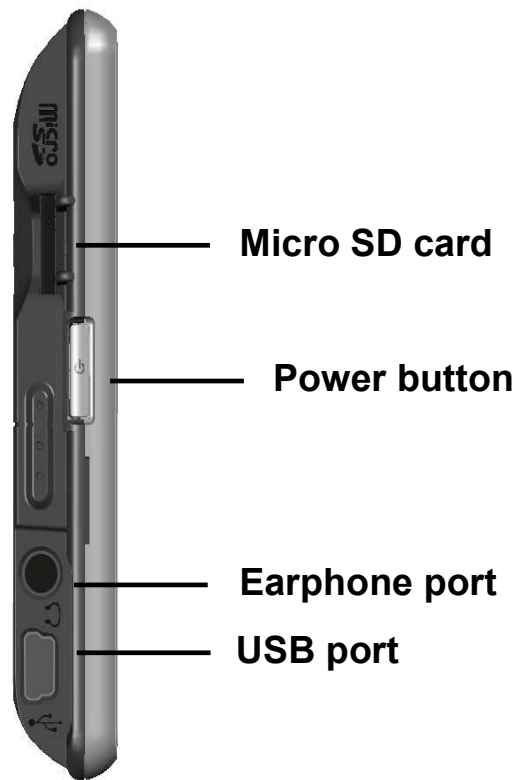

Right Side

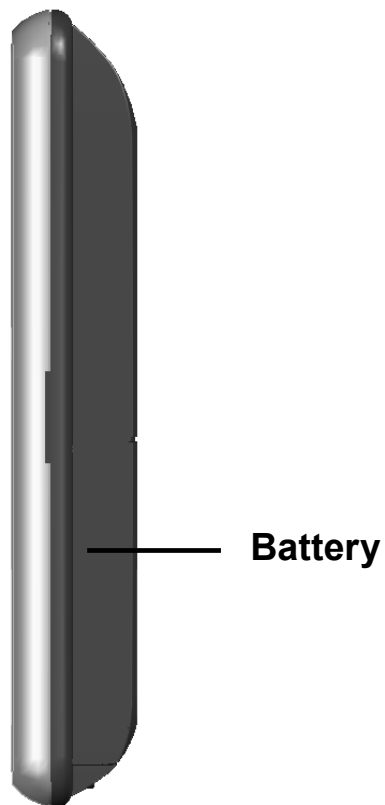

Top View

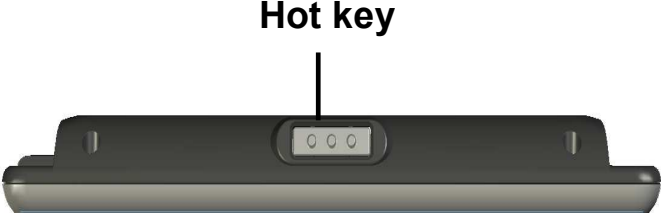

Bottom View



Getting Started

If you are a first-time system user, the following explanations will help you quickly understand the system operations, and experience the system's powerful and convenient functions.

Micro SD memory card installation

This unit is equipped with a Micro SD memory card slot. You can purchase Micro SD Cards to expand the memory capacity.

To insert the memory card:

With the metal contacts of the memory card facing back, insert the card into the slot on the right side of the unit.

To remove the memory card:

1. Gently press the top of the memory card, and the card will eject automatically.
2. Then, pull to remove the memory card.



- ✓ The included memory card contains the digital map files that are required for the GPS navigational data. Please do not delete.
- ✓ When removing the memory card, please make sure the card is not reading data, or it will cause a system crash.

- ✓ Do not set the Micro SD memory card as write protected, or the system will not operate properly.
 - When operating, accidental removal of the memory card will result in showing an error message. Please reinsert the memory card and the system may need to be reset before further use.

Charging

Using Home / Travel adapter:

Before using the device for the first time, we strongly suggest you use a fully charged battery.

1. Insert the USB connector into the unit.
2. Plug the adapter into a power outlet.



- ⚡ Please do not use USB cable to connect with PC/Laptop when battery low or without battery, it will be causing device can not boot.

Using the car charger:

While using the device in a vehicle, use the included car charger for long periods of usage.

1. Plug the small plug into the power jack on the ❶ rear 1-1 side of the device bracket is optional.
2. Insert the other end into the cigarette lighter.

***1-1 Optional in basic version.**

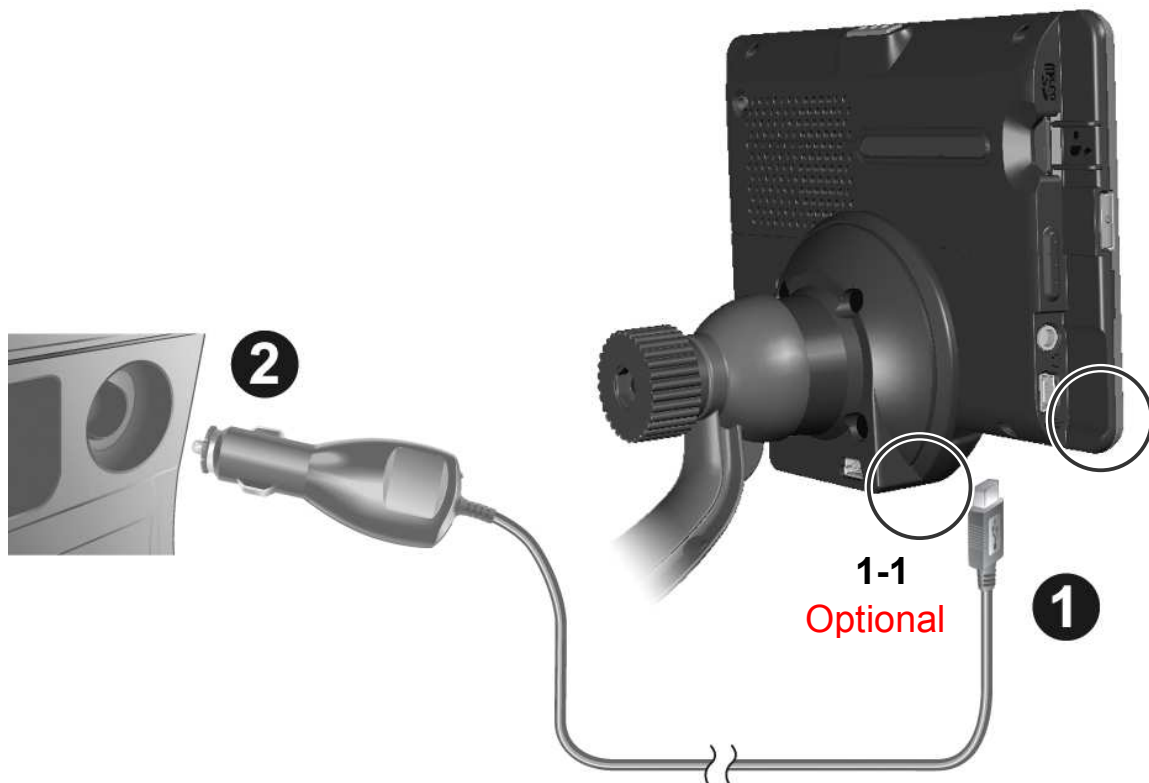

- ✓ This device uses a built-in rechargeable battery. Please note the following:
- Please do not charge in a hot environment, such as on a balcony or an area exposed to direct sunlight.
 - Do not wait until the battery is depleted to recharge.
 - When the unit is not in use for a long time, please remove the battery pack from the device.
 - When charging a completely depleted battery, wait at least one minute before starting up the system. This will prevent excessive battery discharge.

Using the In-Vehicle Bracket

The included in-vehicle bracket set can be securely suctioned on the front windshield, or secured on top of the glove compartment using the adhesive plate. This device will effectively secure the GPS unit in the vehicle. Follow the procedures below to secure the bracket:

1. Follow the arrows and secure the unit into the in-vehicle bracket fitting holes.
2. Gently push the unit until the unit is tightly fixed with the bracket.





Note: Please note the directions of the arrows. When secured, the assembly should be tight. If these directions are not followed, a loose fit will result, and components must be reassembled.

3. Suction the vehicle bracket securely to the windshield, ensuring its base is resting firmly on the dashboard ❶. Bend the bracket support to a proper angle (❷ & ❸).



4. The in-vehicle bracket assembly is complete.
5. To remove the GPS unit, press the release button **1** and unscrew **2**.



- ✓ When using the in-vehicle secure bracket, do not install it in a location that will block the view of the driver
- ✓ Recommended installation requirements:
The bracket base should rest securely on the dashboard to prevent excessive shock.

Operating Methods

Startup

For first time use, please press and hold the power button for about 0.5 second to turn on the power.

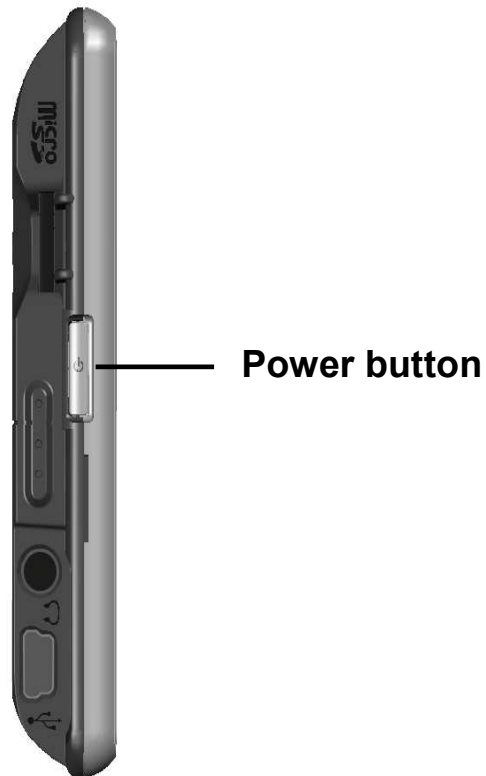

Shutdown

While power is on, press the power button to turn the power off.

Using Functions

During the first startup, the screen will show the main screen consisting of three functions: navigation, photo and settings. Directly select an icon on the screen to use the function.



GPS

Loads the navigation program and navigation screen

Note: If a Micro SD card with navigator software is inserted, the system will automatically enter GPS function after startup.

PHOTO

Plays images

SETTING

System setup

Function Menu

Image Browsing Function



1. The system has an Image Browsing function that is capable of displaying images/photographs stored on Micro SD memory cards. All the files need to be stored under the **Image** directory, and the file format needs to be "*.jpg".
2. Insert the Micro SD memory card with stored image files into the Micro SD memory card slot on the unit.
3. Turn the power on, and select the **[PHOTO]** icon to start image browsing function.
4. The Image Browsing Window.



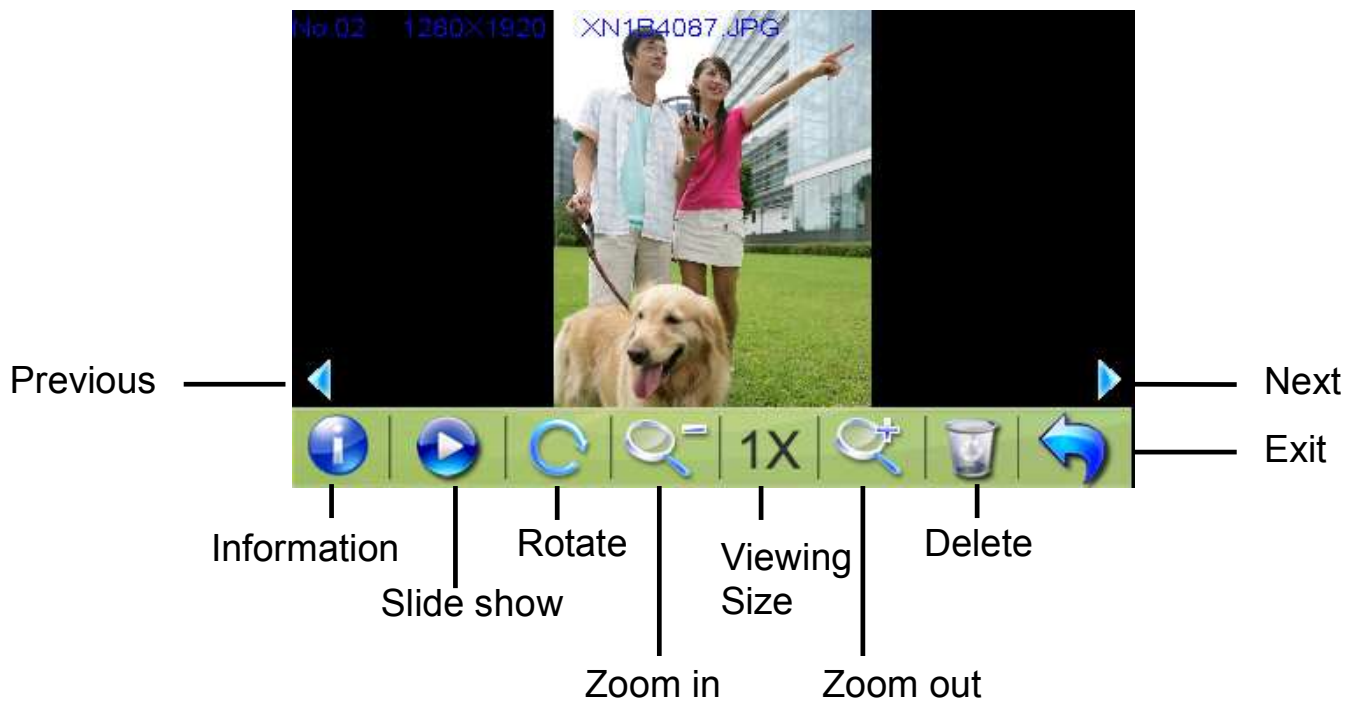

Setting

Volume & Light

1. After starting up the system, select the **[SETTING]** icon to enter.



2. Select **[Volume & Light]** from the main screen to access the settings screen.

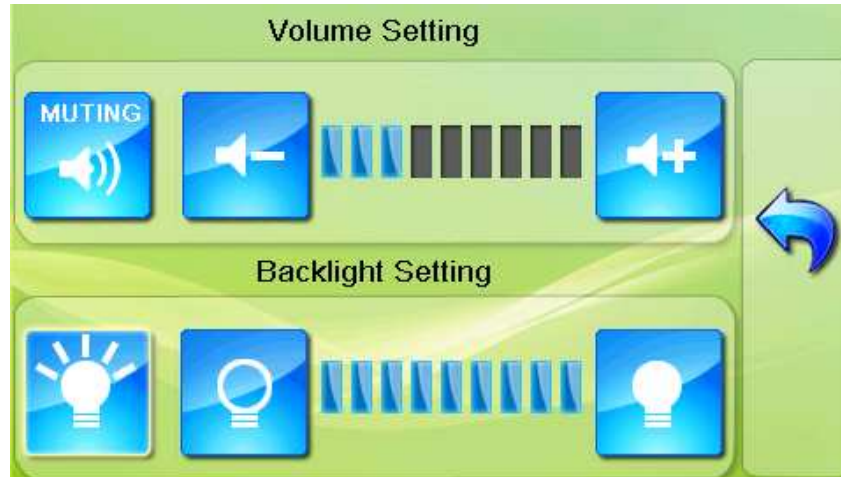

- a. Control the volume directly with the “speaker” icon. There are nine levels of volume.
Select the “MUTING” icon to mute the Volume.
- b. Control the LCD Brightness with “light bulb” icon. There are nine levels of brightness.

Time

1. Select **[Time]** from the main screen to access the Time settings screen.



2. Access the **Date** pull down menu and choose the correct value.
3. Access the **Time** pull down menu and choose the correct value.
4. Access the **Time Zone** pull down menu and choose the correct value.



5. Select  to return to main menu screen.

Panel Adjustment

Control the unit through the finger or stylus by touching/writing on the screen. If the system cannot correctly identify your input, please run through the screen calibration procedure.

1. From the settings window, select **[Panel Adjustment]** to start the screen calibration procedure.



Carefully press and briefly hold stylus on the center of the target.
Repeat as the target moves around the screen.



2. Use the finger/stylus and touch the cross at the center of the screen once.
3. Touch the cross in the second position once.
4. Touch the cross in the third position once.
5. Continue the calibration by touching the cross.
6. The setting page will return when adjustment is finished.

Reset GPS

1. Select [**Reset GPS**] from the main screen to access the **GPS** settings screen.



2. Select the “YES” icon to start the GPS reset procedure.
3. Select the “NO” icon to return to the main “Setting” screen.

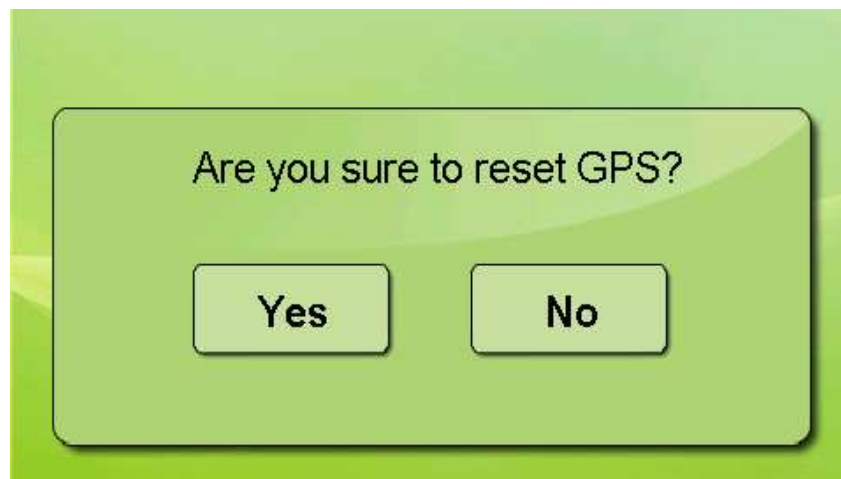

4. The following information is for "GPS reset fail!"

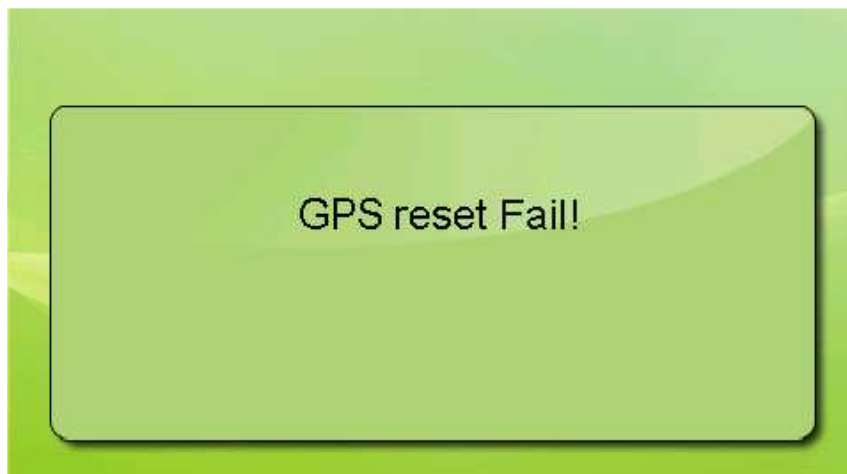

5. The following information is for "GPS reset OK!"

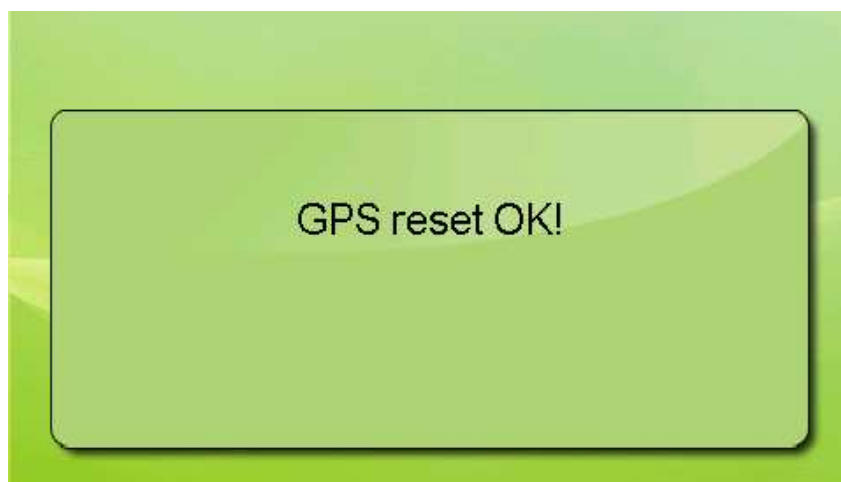

Version

1. Select [**Version**] from the main screen to access the **Version** screen.



2. The screen display will show the version information.



Language

Select **[Language]** from the main screen to access the Language screen. Select the language what you want under the screen.



Startup Message

1. **Warning Voice:** Under the settings window, check the **Warning Voice** to / (check / uncheck) if you would like the startup message is to be broadcast.



2. **Click Voice:** Under the setting windows, check the click voice to / (check/uncheck) to enable / disable the click voice.

Hot Key

Press the [Hot key] to enter the “Volume” and “LCD Brightness” screen.

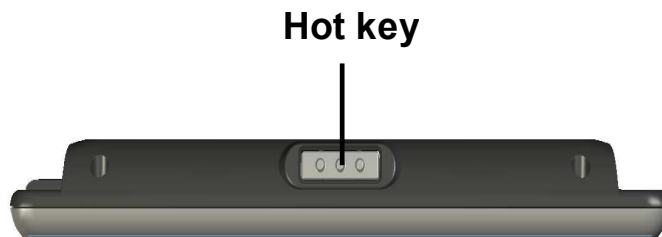

Bluetooth (Optional function)

Make a call

1. Turn the power on and select **"Bluetooth"**  in the main menu. The GPS will display **"Bluetooth HF Phone"** Menu.





2. Select “**Dialer**” and the system will display the calling function menu.

a. Use “**Phonebook**”  to enter its menu.

b. Use “**Call History**”  to enter “**Call History**” menu.

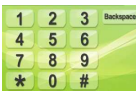

3. Use “**Numbers**”  to enter the desired telephone number and press “**Dial**”  to dial.





Phonebook

1. Select "**Phonebook**" on the main menu to enter the "**Phonebook**" menu.



2. Use "**Download Phonebook**"  to download the Phonebook in the Bluetooth device.
3. The information below is used in "**Downloading Phonebook**".



4. The information below is used for "**The remote device does not support Phonebook Download**".
5. Use up/down arrows to select the number to dial and then press "**Dial**"
.
6. Use "**Delete all contacts**"  to delete all Phonebooks.





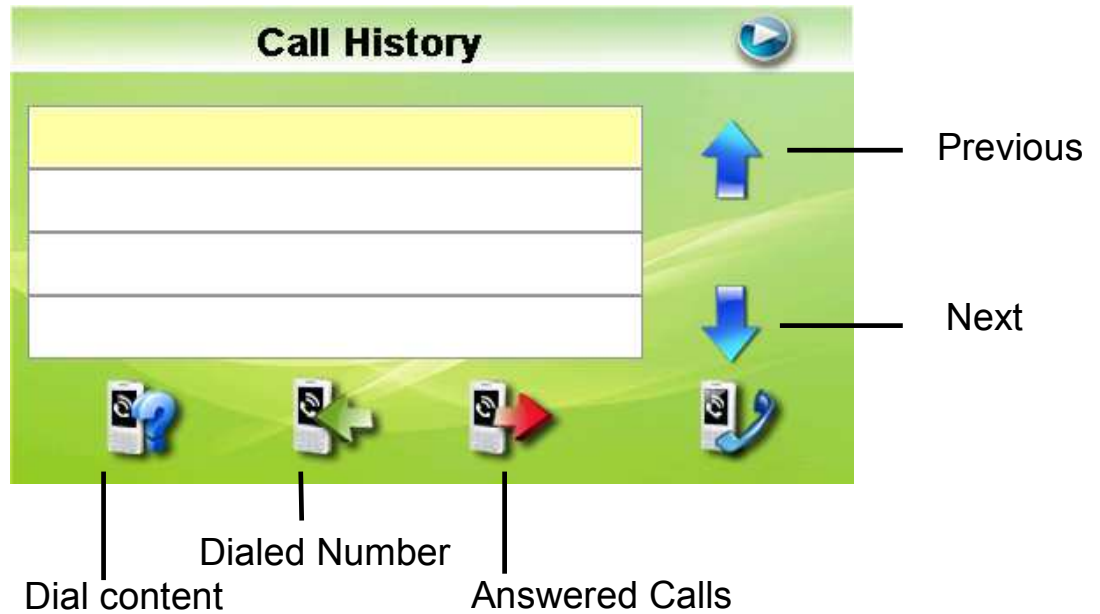

7. Select  Start deleting.

Call History

Select "Call History"  from the main menu, and enter the "Call History" menu.





- Use up/down arrows to view Call History.
- Use "Content"  to view conversation content.
- Use "Dialed Number"  to view dial record.
- Use "Answered Calls"  to view callers.
- Select the desired number and press "Dial" .

Device List

From main menu, select "Device List"  and enter "Device List" menu.



- Use up/down arrow to see Device List(s).
- Select desired device and press "Connect Device"  to connect to device.
- Select the device to be deleted and press "Delete Device"  to delete device.

Device Manager

From the main menu, select "Device Manager"  to enter "Device Manager".

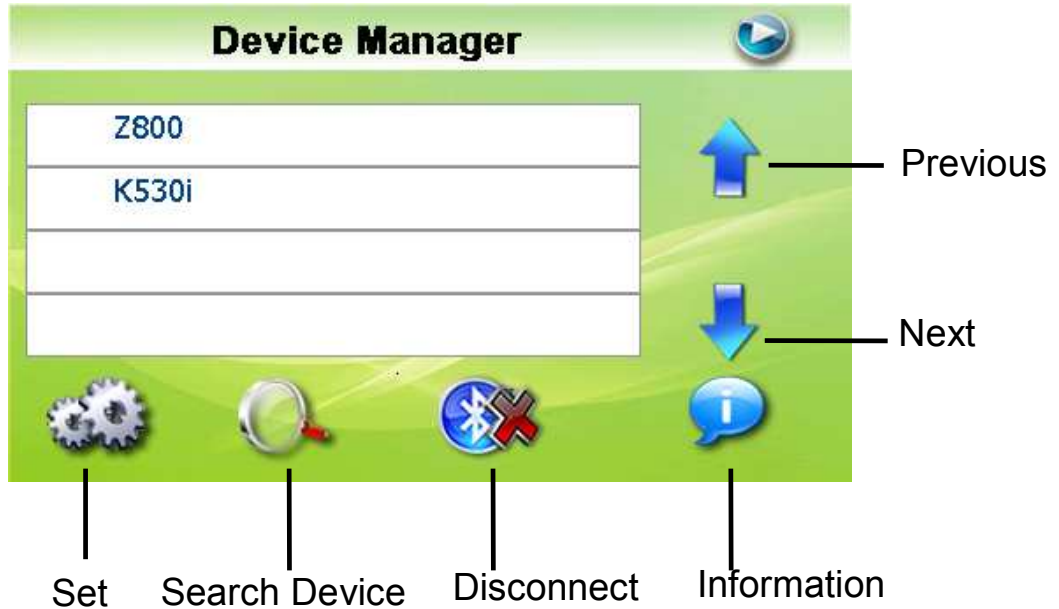

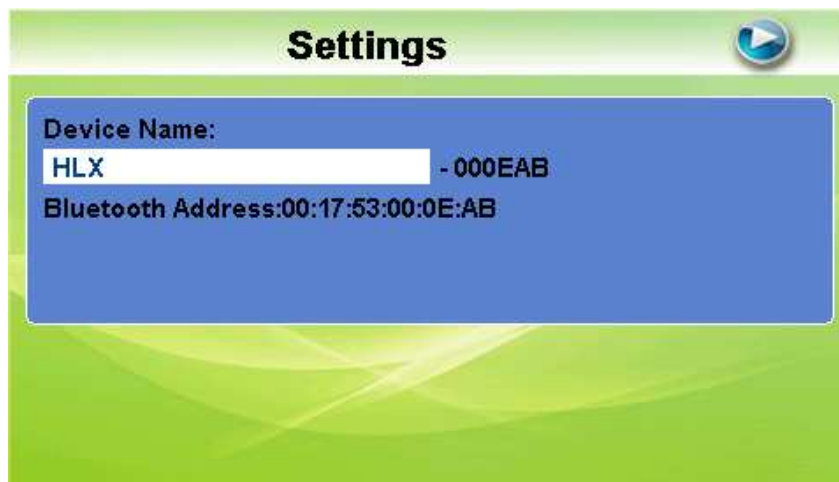

Settings

1. Select "Settings"  to enter "Settings" menu.



2. Touch the name of the device and enter "**Set Device Name**" menu.



3. Use "**Alphabet / Number Switch**"  to change to English characters or numbers.
4. Use "**keypad**" to enter the name for the new device and select  to start using new name.

Search Device

1. Use "**Search Device**" to search for Blue tooth device and enter Device found menu.

2. Use "**Search Device**" to find Bluetooth device again.



3. Use up/down arrows to select the device you desire to Connect and press "**Connect**"  to connect.

4. The information below is used during "**Connection Established**".



5. The information below is used during "**Pairing Fail**".



Disconnect

Select the device to be disconnected, and then press **"Disconnect"**  to disconnect connected Bluetooth device.



Information

Use **"Information"**  to display version information.



Troubleshooting

System reset

It will only be required to reboot the system under extremely few circumstances. Reset your system if the following situations occur:

1. You experience heavy lag while refreshing a screen or operations, which results in an inoperable system.
2. Cannot turn off the system with the power button.
3. No response from a selection made on the screen.

Follow below processes to reset the system:

- Remove the battery cover and then take out the battery pack.
- Insert the battery pack to the system and insert the battery cover.
- The system will immediately reset.
- You will now see the main screen and the system is ready for use.





Normal Care and Maintenance

To ensure the unit's normal operation and extended life span, please note the following while using and storing:

Keep dry

This product is not waterproof. If it comes into contact with water or is submerged into water, it will seriously damage the components and result in irreversible damages.

Do not drop the unit

A serious damage may be caused if it is violently impacted or shocked.

Avoid sudden temperature changes

Condensation may occur when entering a warm room on a cold day. To prevent condensation from damaging the unit, please place it into an airtight plastic bag before exposing it to sudden temperature changes.

Keep away from strong magnetic fields

When using or storing, please keep away from strong electromagnetic/radioactive or magnetic field equipment.

Operating temperature

The products operating temperature is between 0°C ~ 40°C. Please do not operate it under extreme temperatures.

Avoid exposure to sunlight

Please avoid long periods of sunlight or exposure to high temperatures.

Cleaning the screen

Use a soft clean cloth to wipe the screen. Do not use ordinary tissue to wipe the screen.

Do not disassemble

Please do not disassemble the product. This may void the warranty and damage the unit.

Storage

For storage, keep the unit in a dry box.

Please do not keep the product in the following environments:

1. Unventilated and humid locations.
2. In a car window that is exposed to excessive amounts of sunlight.
3. In an environment where humidity is over 90%.

Appendix

Specifications

Integrated GPS Receiver	32 parallel channels
Acquisition Time	◇ Reacquisition : 0.1 sec. ◇ Hot start : 1 sec. ◇ Warm start : 33 sec. ◇ Cold start : 36 sec.
Accuracy	◇ Position: 10 m. for 90% ◇ Velocity: 0.1 m/s
GPS antenna	Built-in patch antenna
Handheld Software (Pre-loaded)	◇ Companion CD: Adobe Acrobat Reader® for Pocket PC - PDF file viewer ◇ GPSmile 62 Handheld Manual
Processor	Samsung S3C2443 400 MHz.
Operating System	Microsoft Windows CE. Net 5.0 Core Version
Memory	◇ 64 MB Flash ◇ 64 MB Mobile SDRAM
Weight	<190 g
Size	135 (W) x 89 (H) x 12 ~ 14.5 (D) mm
Car Holder / Charger	◇ Input voltage: 10~30V, 1.3A max. ◇ Output voltage: 5.4V/1.2A
Battery	◇ Removable Rechargeable 1050 mAh Li-Ion Battery
Extension Slot	Micro SD
Display	◇ 5" (16:9) TFT LCD with touch screen ◇ 480 x 272 pixels ◇ 16 M colors
Audio	◇ Built-in speaker.

	<ul style="list-style-type: none"> ◇ Software volume control. ◇ 3.5mm headphone jack
Temperature	<ul style="list-style-type: none"> ◇ Operation: -10°C ~ 60°C ◇ Storage: -20°C ~ 70°C
Humidity	<ul style="list-style-type: none"> ◇ Operation: 0%~90% ◇ Storage: 0%~90%
USB	<ul style="list-style-type: none"> ◇ USB 2.0 ◇ mini USB Connector for USB client & DC power in
Backlight Adjustment	Software Backlight Adjustment Control
Software	◇ Photo
Bluetooth (Optional Function)	<ul style="list-style-type: none"> ◇ Support PBAP (Phonebook) ◇ Support HFP (Hands-Free)
TMC (Optional Function)	TMC Traffic Receiver
Flash Memory (Optional Function)	Built-in 2G Flash
High Speed Processor (Optional Function)	Samsung S3C2443 533 MHz.

Federal regulations

This device complies with Part 15 of the FCC Rules. Operation is subject to the following two conditions: (1) this device may not cause harmful interference, and (2) this device must accept any interference received, including interference that may cause undesired operation.

FEDERAL COMMUNICATIONS COMMISSION INTERFERENCE STATEMENT

This equipment has been tested and found to comply with the limits for a Class B digital device, pursuant to part 15 of the FCC Rules. These limits are designed to provide reasonable protection against harmful interference in a residential installation. This equipment generates, uses and can radiate radio frequency energy and, if not installed and used in accordance with the instructions, may cause harmful interference to radio communications. However, there is no guarantee that interference will not occur in a particular installation. If this equipment does cause harmful interference to radio or television reception, which can be determined by turning the equipment off and on, the user is encouraged to try to correct the interference by one or more of the following measures:

- Reorient or relocate the receiving antenna.
- Increase the separation between the equipment and receiver.
- Connect the equipment into an outlet on a circuit different from that to which the receiver is connected.
- Consult the dealer or an experienced radio/ TV technician for help.

CAUTION:

Any changes or modifications not expressly approved by the grantee of this device could void the user's authority to operate the equipment.

This equipment is in compliance with the essential requirements and other relevant provisions of directive 1999/5/EC.

RF exposure warning

This equipment must be installed and operated in accordance with provided instructions and the antenna(s) used for this transmitter must be installed to provide a separation distance of at least 20 cm from all persons and must not be co-located or operating in conjunction with any other antenna or transmitter. End-users and installers must be provide with antenna installation instructions and transmitter operating conditions for satisfying RF exposure compliance.