

Nokia Display Car Kit CK-600

User and Installation Guide

DECLARATION OF CONFORMITY

Hereby, NOKIA CORPORATION declares that this HF-23 product is in compliance with the essential requirements and other relevant provisions of Directive 1999/5/EC. The product is in conformity with the limits defined in Directive 2004/104/EC (amending Directive 72/245/EEC), Annex I, paragraph 6.5, 6.6, 6.8 and 6.9. A copy of the Declaration of Conformity can be found at http://www.nokia.com/phones/declaration_of_conformity/.

CE 0560

© 2008 Nokia. All rights reserved.

Nokia, Nokia Connecting People, Navi and the Nokia Original Accessories logo are trademarks or registered trademarks of Nokia Corporation. Other product and company names mentioned herein may be trademarks or tradenames of their respective owners.

Bluetooth is a registered trademark of Bluetooth SIG, Inc.

Reproduction, transfer, distribution, or storage of part or all of the contents of this document in any form without the prior written permission of Nokia is prohibited.

Nokia operates a policy of ongoing development. Nokia reserves the right to make changes and improvements to any of the products described in this document without prior notice.

To the maximum extent permitted by applicable law, under no circumstances shall Nokia be responsible for any loss of data or income or any special, incidental, consequential or indirect damages howsoever caused.

The contents of this document are provided "as is". Except as required by applicable law, no warranties of any kind, either express or implied, including, but not limited to, the implied warranties of merchantability and fitness for a particular purpose, are made in relation to the accuracy, reliability or contents of this document. Nokia reserves the right to revise this document or withdraw it at any time without prior notice.

The availability of particular products may vary by region. Please check with your Nokia dealer for details.

Export controls

This device may contain commodities, technology or software subject to export laws and regulations from the US and other countries. Diversion contrary to law is prohibited.

9211132/Issue 2 EN

Contents

| | | | |
|-------------------------------------|----|---|----|
| For your safety | 5 | Speed dialling..... | 19 |
| Quick start | 6 | Switch a call between car kit and connected device | 20 |
| First time setup | 6 | Send DTMF tones..... | 20 |
| Input device | 6 | | |
| 1. Introduction | 9 | 4. Music player | 21 |
| About this document..... | 9 | Listen to music..... | 21 |
| Bluetooth wireless technology | 10 | Adjust music volume..... | 22 |
| | | Music player settings | 22 |
| 2. Get started | 11 | 5. Contacts | 23 |
| Parts | 11 | Search for a contact..... | 23 |
| Input device CU-10..... | 12 | Speed dials | 23 |
| Display and standby mode..... | 12 | Copy contacts to car kit | 24 |
| Rotate the display..... | 12 | | |
| Store the display in the pouch..... | 13 | 6. Settings | 25 |
| Information shown | | Bluetooth settings..... | 25 |
| in the standby mode | 13 | User and installation settings..... | 25 |
| Navigate the menus..... | 13 | Audio settings..... | 25 |
| Switch the car kit on or off | 14 | Display settings | 26 |
| Switch on | 14 | General settings | 26 |
| Switch off..... | 14 | Installation settings | 27 |
| First time use | 15 | 7. Troubleshooting | 28 |
| Pair and connect the car kit..... | 15 | Reset the car kit..... | 28 |
| Pair and connect with | | Connection issues..... | 28 |
| phone or music player | 16 | Audio issues | 29 |
| Connect the car kit manually..... | 17 | Other issues..... | 30 |
| Connect the car kit | | | |
| automatically | 17 | 8. Installation | 31 |
| Disconnect the car kit..... | 17 | Safety information | 31 |
| Manage or clear the list | | Integration with a car radio | |
| of paired devices | 17 | system..... | 32 |
| | | Use the ISO cable CA-152..... | 33 |
| 3. Calls | 18 | Use the power cable CA-153P | 36 |
| Make a call..... | 18 | Install the car kit in a vehicle | 38 |
| Answer a call | 18 | Hands-free unit HF-23..... | 39 |
| Adjust call volume..... | 19 | Input device CU-10 | 40 |
| Mute or unmute the microphone... .. | 19 | Display SU-34 | 40 |
| Call register..... | 19 | Microphone MP-2..... | 43 |

| | | | |
|---------------------------|----|---------------------------|-----------|
| ISO cable CA-152..... | 43 | Care and maintenance..... | 46 |
| Motion sensor..... | 44 | Additional safety | |
| Optional accessories..... | 44 | information | 47 |
| Mobile holder | 44 | | |
| External antenna | 44 | | |
| Check the operation | | | |
| of the car kit..... | 45 | | |
| Software updates..... | 45 | | |

For your safety

Read these simple guidelines. Not following them may be dangerous or illegal. Read the complete user and installation guide for further information.



SWITCH ON SAFELY

Do not switch the device on when wireless phone use is prohibited or when it may cause interference or danger.



ROAD SAFETY COMES FIRST

Obey all local laws. Always keep your hands free to operate the vehicle while driving. Your first consideration while driving should be road safety.



INTERFERENCE

All wireless devices may be susceptible to interference, which could affect performance.



SWITCH OFF IN RESTRICTED AREAS

Follow any restrictions. Switch the device off near fuel, chemicals, or blasting areas.



QUALIFIED SERVICE

Only qualified personnel may install or repair this product.



ACCESSORIES

Use only approved accessories. Do not connect incompatible products.

When connecting to any other device, read its user guide for detailed safety instructions. Do not connect incompatible products.

Quick start

This section briefly describes the basic features of the car kit. For details, see the respective sections in this guide.

■ First time setup

1. Switch on the car kit (see p. 14) and your mobile phone or music player.
2. When you are prompted to select a language for the texts on the car kit display, turn the Navi™ wheel to scroll to the desired language, and press the wheel.
3. Activate the Bluetooth feature on your phone or music player, and set up a Bluetooth connection between the car kit and your device.
4. When you are prompted to copy the contacts from your device to the car kit, turn the Navi wheel to scroll to **Yes**, and press the wheel to start the copying. If you select **No**, you cannot use your saved contacts to make calls with the car kit.

■ Input device

When you use the input device to operate the music player connected to the car kit, the available music player functions are shown on the car kit display.

1. Voice dialling key

Press  to activate voice dialling on a compatible mobile phone when no call is in progress.

2. Mute key

Press  to mute or unmute the external loudspeaker in the standby mode.

Press  to mute or unmute the microphone during a call.

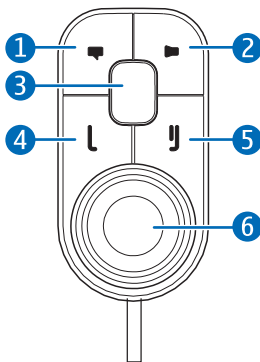



Press and hold  for about 2 seconds to switch a call from the car kit to the compatible device connected to it.

3. Mode key





Press the mode key to switch between the standby mode and the music player menu.

In the music player menu, press the mode key to start, pause, or resume music playback on the compatible music player connected to the car kit.

4. Call key

- Press  to make or answer a call or to switch between an active call and a call on hold.
- Press  to view the list of last dialled numbers in the standby mode.
- Press  twice to redial the last dialled number in the standby mode.

5. End key

- Press  to end or reject a call.
- Press  to delete a single character when you write text or numbers.
- Press  to return to the previous menu level or display view.
- Press and hold  to return to the standby mode from the menu functions.
- Press and hold  to switch the car kit on or off (if the car kit is not connected to the ignition system).

6. Navi wheel (hereafter referred to as wheel)

- Turn the wheel left or right to adjust the volume during a call or while listening to music, or to scroll through menu items.
- Turn the wheel left in the standby mode to enter a phone number or to use speed dialling.
- Turn the wheel right in the standby mode to search for a contact in [Contacts](#).

Quick start

- Press the wheel to perform the function shown at the bottom of the display.

1. Introduction

With the Nokia Display Car Kit CK-600, you can conveniently make and answer calls hands-free and listen to music from your compatible device.

You can also copy contacts from two compatible devices to the car kit, which allows two users to use their contacts immediately after their device is connected to the car kit. The contacts and the menu functions of the car kit can be accessed with the supplied input device and display.

The car kit can be paired with up to eight Bluetooth devices at a time and connected to a compatible mobile phone and music player at the same time.

Read this guide carefully before having the car kit professionally installed and using it. Also, read the user guide for the device that you connect to the car kit. It provides important safety and maintenance information.

Check www.nokia.com/support or your local Nokia website for the latest guides, additional information, and downloads related to your Nokia product.

This product may contain small parts. Keep them out of the reach of small children.

■ About this document

Setup and operation are described in "Get started", p. 11, "Calls", p. 18, "Music player", p. 21, "Contacts", p. 23, and "Settings", p. 25.

Troubleshooting tips can be found in "Troubleshooting", p. 28.

Installation in a car is described in "Installation", p. 31. The car kit should only be installed by a qualified service technician using the original Nokia parts supplied in the sales package.

■ Bluetooth wireless technology

Bluetooth wireless technology allows you to connect compatible devices without cables. The car kit and the other device do not need to be in line of sight, but they should be within 10 metres (33 feet) of each other. Connections may be subject to interference from obstructions, such as walls, or other electronic devices.

The car kit is compliant with the Bluetooth Specification 2.0 supporting the following profiles: the Hands-Free Profile (HFP) 1.5 (to use the car kit hands free with your mobile device for calling), Phone Book Access Profile (PBAP) 1.0 (to copy contacts from your mobile device to the car kit), Advanced Audio Distribution Profile (A2DP) 1.0 (to stream music from your music player to the car kit), and Audio Video Remote Control Profile (AVRCP) 1.0 (to operate the connected music player with the input device). Check with the manufacturers of other devices to determine their compatibility with this device.

2. Get started

■ Parts

The car kit contains the following parts:

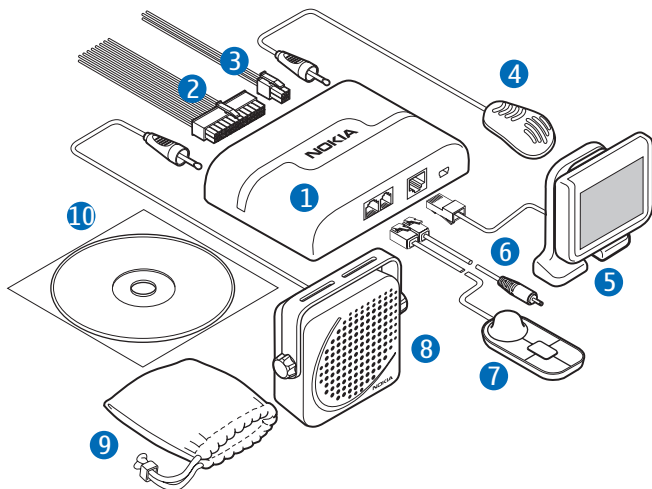

1. Hands-free unit HF-23
2. ISO cable CA-152 (if supplied in the sales package)
3. Power cable CA-153P (if supplied in the sales package)
4. Microphone MP-2
5. Display SU-34
6. Charging cable CA-134 with a Nokia 2.0 mm plug
7. Input device CU-10 with Navi wheel
8. Loudspeaker SP-3 (if supplied in the sales package)
9. Pouch CP-335 for storing the display when it is not used

10. CD that contains this user and installation guide

■ Input device CU-10

You can operate the car kit using the input device. The device is provided with the Navi wheel that you can turn or press.

1. Voice dialling key
2. Mute key
3. Mode key
4. Call key
5. End key
6. Navi wheel (hereafter referred to as wheel)

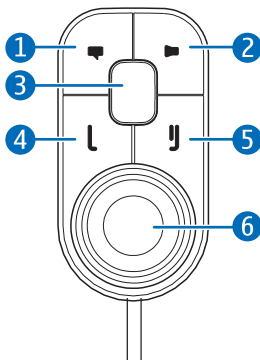

The keys are illuminated for easy operation in the dark. For functions that can be performed with the input device, see "Input device", p. 6.

■ Display and standby mode

Rotate the display

When the display is attached to the dashboard using the supplied stand, you can rotate the display up to about 24 degrees left or right and up to about 20 degrees up or down.

When the display is attached to the dashboard using the supplied mounting plate, you can rotate the display up to about 15 degrees left or right and up to about 10 degrees up or down.

Do not try to force the display to rotate more.

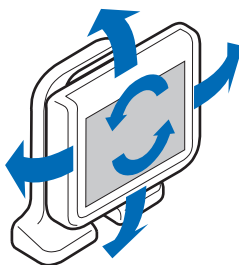

Store the display in the pouch

When you do not use the display, detach it from the stand or mounting plate, and put it into the supplied pouch to protect it against scratches.

Information shown in the standby mode

When the car kit is in the standby mode and connected to a compatible device using Bluetooth wireless technology, the following information is displayed:

1. Current status of the car kit, for example, type of the connected device (compatible mobile phone or music player)
2. Signal strength of the cellular network at the current location if this information is provided by the connected phone; the higher the bar, the stronger the signal
3. Name or logo of the service provider if this information is provided by the connected phone
4. Battery status of the connected phone if this information is provided by the phone; the higher the bar, the more power left
5. Function that can be performed by pressing the wheel; in the standby mode, pressing the wheel opens the list of menu functions

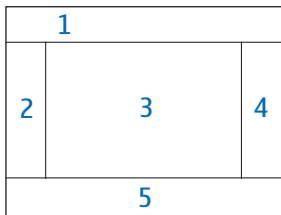

To enter a phone number manually or use speed dialling, turn the wheel left. For details, see "Speed dials", p. 23.

To search for a contact from [Contacts](#) in the car kit, turn the wheel right. For details, see "Search for a contact", p. 23.

To view the last dialled numbers, press . For details, see "Call register", p. 19.

Navigate the menus

Many of the car kit functions are grouped into menus.

To open the list of menu functions in the standby mode, press the wheel when *Menu* is displayed at the bottom of the display.

To scroll to an item (such as a menu function) or through a list, turn the wheel left or right. To select an item, scroll to the item, and press the wheel.

To return to the previous menu level, press **⏪**. To return to the standby mode, press and hold **⏪** until the standby mode screen is displayed.

■ Switch the car kit on or off

If you are not certain whether the ignition sense wire is connected or not, consult with the technician who installed the car kit.

Switch on

If the ignition sense wire is connected, turn on the car ignition. When the car kit is switched on, the display and the indicator light of the input device turn on.

If the ignition sense wire is not connected, press and hold **⏪** for about 5 seconds. Alternatively, turn on the ignition, start driving, and wait until the built-in motion sensor switches the car kit on automatically (if the motion sensor is turned on). When the motion sensor is on, the car kit switches off after 2 minutes if no phone is connected to the car kit during this time; to switch the car kit back on, press and hold **⏪** for about 5 seconds. To turn the motion sensor on or off, press the wheel in the standby mode, and select *Settings* > *Installation* > *Ignition sensor*.

After the car kit is switched on, it tries to make a Bluetooth connection to the phone that was last used with it.

Switch off

If the ignition sense wire is connected, turn off the car ignition. If you have a call in progress on your phone connected to the car kit, the car kit switches off after you end the call. When the car kit switches off, the display and the indicator light of the input device turn off.

If the ignition sense wire is not connected, press and hold **J** for about 5 seconds to switch off the car kit. If the ignition sense wire is not connected and you disconnect your device from the car kit (for example, to take it with you), the car kit automatically switches off after 2 minutes.

After you turn off the car ignition, do not leave the phone or music player connected to the car kit to prevent accidental draining of the car battery. If the phone or music player is left connected to the car kit, the car kit automatically switches off after 12 hours.

■ First time use

When you switch on the car kit for the first time, you are asked to select the desired language for the texts on the car kit display. Turn the wheel to scroll to the desired language, and press the wheel.

After the language selection, you are asked to pair and connect the car kit with a compatible device using Bluetooth wireless technology. See also steps 3 to 5 in "Pair and connect the car kit", p. 15.

When your device is connected to the car kit, you are prompted to copy the contacts from the device to the car kit. To start the copying, select **Yes**. If you select **No**, you cannot use your saved contacts to make calls with the car kit. To copy the contacts later, see "Copy contacts to car kit", p. 24.

■ Pair and connect the car kit

Before using the car kit, you must associate (pair) and connect it with a compatible mobile phone or music player that supports Bluetooth wireless technology. See also "Bluetooth wireless technology", p. 10.

When you use your device with the car kit, secure the device in the car using a compatible mobile holder. However, you can maintain the Bluetooth connection in the car even if you keep your device, for example, in a handbag.

To charge the battery in your compatible Nokia device while using the car kit, connect the device to the car kit using the supplied charging cable.

You can pair the car kit with up to eight devices but connect it to only one device supporting the HFP Bluetooth profile and another device supporting the A2DP (and possibly AVRCP) profile at a time.

Pair and connect with phone or music player

If your phone supports the HFP and A2DP (and possibly AVRCP) Bluetooth profiles and has a music player feature, you can use the car kit to handle calls and play music.

If your phone does not support the A2DP Bluetooth profile, you can separately pair the car kit with the phone and a music player that supports this profile.

To pair and connect the car kit with a compatible phone or music player after the first time use:

1. Switch on the car kit and your phone or music player.

If you want to pair and connect a music player that supports the A2DP Bluetooth profile, disconnect the car kit from your phone if the phone supports this profile.

2. Press the wheel in the standby mode, and select *Bluetooth > Paired devices > Pair new device*.
3. Activate the Bluetooth feature on your device, and set it to search for Bluetooth devices. For instructions, see the user guide of your device.
4. Select the car kit (Nokia CK-600) from the list of found devices on your device, or follow the related instructions in the user guide for the device.

The Bluetooth passcode 0000 is shown on the car kit display.

5. Enter the Bluetooth passcode 0000 to pair and connect the car kit with your device. In some devices you may need to make the connection separately after pairing. See "Connect the car kit manually", p. 17, or the user guide of your device.

If your device does not have a keypad, it may use the passcode 0000 by default. If this is not the case, see the user guide of the device to change the default Bluetooth passcode to 0000.

If the pairing is successful and your device is connected to the car kit, a related message is shown on the car kit display. The car kit also appears in the menu of your phone or music player where you can view the currently paired Bluetooth devices.

Connect the car kit manually

To manually connect the car kit to a paired phone or music player when the car kit is switched on, press the wheel in the standby mode, select *Bluetooth* > *Connect phone* or *Connect music player*, and select the device from the list.

Connect the car kit automatically

You may be able to set your phone so that the car kit connects to it automatically. To activate this feature in a Nokia device, change the paired device settings in the Bluetooth menu.

When you switch on the car kit, the car kit tries to make a Bluetooth connection to the last used phone. If this fails, the car kit tries to connect to the second last used phone.

Disconnect the car kit

To disconnect the car kit from your phone or music player, close the connection in the Bluetooth menu of your device. Alternatively, press the wheel in the standby mode, and select *Bluetooth* > *Active devices* and the device you want to disconnect.

Manage or clear the list of paired devices

The car kit saves the pairing information about the last eight Bluetooth devices that have been paired with it.

To remove a device from the list of paired devices, press the wheel in the standby mode, and select *Bluetooth* > *Paired devices*, the desired device, and *Delete pairing*.

To clear the list of paired devices and reset the car kit to the factory settings, press the wheel in the standby mode, and select *Settings* > *Restore factory settings*.

3. Calls

■ Make a call

To enter a phone number, turn the wheel left in the standby mode. Scroll to the first digit of the phone number, and press the wheel. Select the other digits of the phone number in the same way. (To delete the most recent digit, press **⏮**.) Once the phone number is displayed, press **⏮** to call it. To end the call (or cancel the call attempt), press **⏮**.

To search for a contact from *Contacts*, see "Search for a contact", p. 23.

To call the most recently dialed number, press **⏮** twice. To call one of the other recently dialed numbers, press **⏮**, scroll to the desired name or phone number, and press **⏮**.

To activate the voice dialling feature on the connected phone, press **🗨️** when you are not in a call, if your phone supports the use of this feature with the car kit. Proceed as instructed in the phone user guide. For voice dialling, you must save voice tags for the desired contacts in your phone.

■ Answer a call

To answer a call, press **⏮** or the wheel. The caller's name is displayed if the cellular network supports this function and you have copied the caller's contact information from the connected device to the car kit (see "Copy contacts to car kit", p. 24). If you do not answer the call, you can view the caller's name (or phone number) by pressing wheel after the call (see also "Call register", p. 19).

To reject an incoming call, press **⏮**.

If you have set the *Automatic answer* function to *On*, the car kit automatically answers the call. See "User and installation settings", p. 25.

To put a call on hold, press the wheel when *Call options* is displayed, and select *Hold*; to make the call on hold active, select *Unhold*.

To answer a new call during a call if you have activated the call waiting feature in your phone, press **⏮**. The first call is put on hold. To reject the

new call, press . To switch between the active call and the call on hold, press . To end the active call and make the call on hold active, press .

■ Adjust call volume

To adjust the volume during a call or when a call is alerting, turn the wheel left to decrease the volume or right to increase it. When you change the volume, the horizontal bar at the top of the display moves accordingly. The volume is set only for the current call. To set the default volume for calls, see "Audio settings", p. 25.

To mute the volume, press in the standby mode or when you receive a call. To restore the original volume, press .

■ Mute or unmute the microphone

To mute or unmute the microphone during a call, press ; or press the wheel when *Call options* is displayed, and select the desired option. When the microphone is muted, is displayed.

■ Call register

The car kit registers the phone numbers of recent missed, received, and dialled calls. The car kit registers missed and received calls only if the cellular network supports these functions, and the device that you have connected to the car kit is switched on and within the network service area.

To view the recent calls, press the wheel in the standby mode, and select *Call register* and a call type. To view the phone number of the selected call, press the wheel. To call the phone number, press .

■ Speed dialling

You can assign a contact to one of the speed dialling numbers, 1 - 9. See "Speed dials", p. 23.

To use speed dialling, turn the wheel left in the standby mode, and scroll to the desired speed dialling number. The contact assigned to the speed dialling number is displayed. To call the contact, press .



■ Switch a call between car kit and connected device

To switch a call from the car kit to your compatible phone, press and hold  for about 2 seconds. Some phones may close the Bluetooth connection until the call ends.

To switch the call back to the car kit, press the wheel when *Reconnect* is displayed, or use the relevant function on your device.

■ Send DTMF tones

You can send DTMF tone strings (for example, a password) during a call. Press the wheel when *Call options* is displayed, and select *Send DTMF*.

Scroll to the first digit of the string, and press the wheel. Select the other digits of the string in the same way. (To delete the most recent digit, press .) Once the whole string is displayed, press  to send it as DTMF tones.

4. Music player

You can use the car kit to listen to music from a compatible music player (or its memory card) that supports the A2DP (and possibly AVRCP) Bluetooth profile.

To open the music player menu, press the wheel in the standby mode, and select *Music*. Alternatively, press the mode key to switch between the standby mode and the music player menu. The car kit detects the Bluetooth profiles supported by the connected music player and shows the available functions.



Warning: Listen to music at a moderate level. Continuous exposure to high volume may damage your hearing.

■ Listen to music



To listen to music from your music player through the car kit, ensure that the player is connected to the car kit and is ready for use, and open the music player menu. The car kit shows the music player functions that can be controlled with the input device.

If your music player supports the A2DP Bluetooth profile, you can do the following:

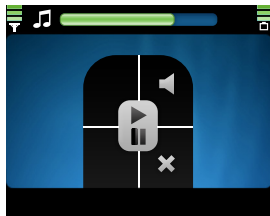
- To play or pause the song that you have selected on the music player, press the mode key.
- To mute or unmute playback, press .



If your music player supports the AVRCP Bluetooth profile, you can also do the following:

- To select the previous song, press .
- To select the next song, press .

To return to the previous screen without stopping playback, press .

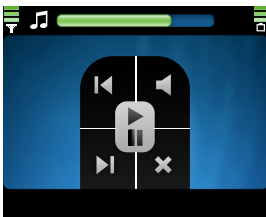

To exit to the standby mode without stopping playback, press and hold  for about 2 seconds.

If you receive or make a call while listening to music, the music is paused until you end the call.



■ Adjust music volume

To adjust the volume during music playback, turn the wheel left to decrease the volume or right to increase it, or set the volume on your car radio. To set the default volume for music, see "Audio settings", p. 25.

To mute the volume, press  during music playback. To restore the original volume, press .

■ Music player settings

To adjust the music player settings, open the music player menu, and press the wheel when *Music settings* is displayed.

To view or change the music player connected to the car kit, select *Active music player*. To change the music player, select the desired player from the list. See also "Bluetooth settings", p. 25.

To modify the tone of the music playback, select *Equaliser* and the desired option. This setting cannot be changed if you use the car radio amplifier for music.

To exit from the music settings, select *Back*.

5. Contacts

You can copy names and phone numbers (contacts) from two compatible mobile phones to the car kit, and use the contacts for calling. This is convenient when you use the car kit with two phones because you can access the contacts immediately while the contacts saved in the phone are synchronised with the car kit in the background.

The copied contacts are saved in the *Contacts* menu. For details, see "Copy contacts to car kit", p. 24.

■ Search for a contact

The car kit uses predictive search for faster access to the saved contacts. The search only shows the available characters, and non-available characters are greyed out.

To search for a contact in the standby mode, turn the wheel right, or press the wheel, and select *Contacts* > *Search*.

To view all the contacts saved in *Contacts*, press **L**, or select **✓**.

To only view contact names that start with certain letters, scroll to the first letter of the name, and press the wheel. (For more available characters, select the right arrow.) You can repeat this four times. To delete the most recent letter, press **⏏**. To view the list of names that start with the entered letters, press **L**, or select **✓**. To switch back to the character list, press **⏏**.

To call the default phone number of the selected contact, scroll to the desired contact, and press **L**. To call some other phone number of the contact, press the wheel, scroll to the desired number, and press **L**.

■ Speed dials

Speed dialling is a quick way to call frequently used phone numbers. You can assign a phone number to the speed dialling numbers, 1 - 9.

Speed dials must be turned on before using speed dialling (see "User and installation settings", p. 25).

To set up speed dialling, press the wheel in the standby mode, and select **Contacts** > **Speed dials**.

- To allow or prevent speed dialling, select **Activate** or **Deactivate**. If you deactivate speed dialling, you are prompted to activate it when you try to use speed dialling.
- To view the contacts assigned to speed dialling numbers, select **View**, and scroll through the list. To call the selected contact, press the wheel.
- To assign a name or phone number to a speed dialling number, select **Assign**. To select the name from the contacts list, select the first letter of the name. The names starting with this letter are shown. Select the desired name, phone number, and speed dialling number.
- To delete an assigned speed dial, select **Delete** and the contact that you want to remove from the speed dial list. The contact is removed only from the speed dial list, not from **Contacts**.

■ Copy contacts to car kit

You can copy the contacts saved in the internal memory of two compatible mobile phones that you connect to the car kit.

To copy the contacts from the connected device, press the wheel in the standby mode, and select **Contacts** > **Download Contacts** > **Yes**.  is displayed during the copying.

If you make or receive a call while the contacts are copied, the copying may be stopped. In this case, start the copying again. While the contacts are being copied, you cannot use the contacts saved in **Contacts**.

If you connect another device to the car kit, the contacts copied from the previous device cannot be used. To use the contacts saved in the new device with the car kit, copy the contacts to the car kit.

Each time you connect your device to the car kit, the contacts saved in **Contacts** are updated if the contacts saved in the device have changed.

6. Settings

■ Bluetooth settings

To manage Bluetooth connections, press the wheel in the standby mode, and select *Bluetooth*.

To view the devices that are currently connected to the car kit, select *Active devices*. To disconnect a device from the car kit, select the desired device. To connect to a paired device when the device list is empty, press the wheel and select the desired device.

To view the devices that are currently paired with the car kit, select *Paired devices*. To pair the car kit with a compatible phone or music player, select the device and *Pair new device*. To remove the pairing, select the device and *Delete pairing*.

To connect the car kit with a paired phone or music player, select *Connect phone* or *Connect music player*, and select the device from the list. See also "Pair and connect the car kit", p. 15.

■ User and installation settings

You can save different user and installation settings for up to eight paired devices.

Audio settings

To adjust the audio settings, press the wheel in the standby mode, and select *Settings* > *Audio*.

To set the default volume for phone calls, select *Handsfree volume*, turn the wheel left to decrease or right to increase the volume, and press the wheel. See also "Adjust call volume", p. 19.

To set the default volume for the music player, select *Music volume*, turn the wheel left to decrease or right to increase the volume, and press the wheel.

To define when the car radio is muted, select *Phone sounds* and the desired option. If you select *Calls only*, the car radio is muted only when

you receive a call. If you select *Always on*, the car radio is muted when the connected device produces any sound, for example, a text message tone.

To turn the warning tones of the car kit on or off, select *Warning tones* and the desired option.

Display settings

To adjust the display settings, press the wheel in the standby mode, and select *Settings > Display*.

To turn the night mode on or off, select *Night mode* and the desired option. If you select *On*, the display backlight is dimmer.

To set the direction of the menu rotation when you turn the wheel, select *Menu rotation* and the desired option. If you select *Clockwise*, the menu is rotated to the same direction to which you turn the wheel.

To change the colour of the display, such as the background and the signal strength bar, select *Colour themes* and the desired colour theme.

To adjust the brightness of the display, select *Brightness* and the desired brightness level.

To set the time after which the display backlight turns off in the standby mode, select *Auto dimming* and the desired time. If you select *Off*, the backlight remains always on when the car kit is switched on.

General settings

To adjust the general settings, press the wheel in the standby mode, and select *Settings > General*.

To select whether the contacts saved in *Contacts* are sorted by first or last name, select *Sort order* and the desired option.

To turn speed dialling on or off, select *Speed dials* and the desired option. If you select *On*, the phone numbers assigned to the speed dialling numbers, 1 - 9, can be dialled as described in "Speed dialling", p. 19.

To turn automatic answer on or off, select *Automatic answer* and the desired option. If you select *On*, the car kit automatically answers an

incoming call. To set the time period after which the call is answered, see the phone user guide.

To change the car kit language, select *Language setting* and the desired language.

To view the software and hardware versions of the product, select *Product info*. To scroll through the information, press the wheel repeatedly.

To reset the car kit to the factory settings, select *Restore factory settings*. Alternatively, switch on the car kit, and press and hold the wheel for about 5 seconds.

Installation settings

The installation settings should only be changed by a qualified service technician during the installation of the car kit. To adjust the settings, press the wheel in the standby mode, and select *Settings > Installation*.

To turn the built-in motion sensor on or off, select *Ignition sensor* and the desired option.

To select the appropriate music output, select *Music output* and the correct mode according to the car radio setup. For details, see "Integration with a car radio system", p. 32.

7. Troubleshooting

■ Reset the car kit

The car kit doesn't react to my actions. How can I reset it?

Press and hold **L** for about 10 seconds when the car kit is switched on. The car kit restarts. The reset does not clear the car kit settings.

■ Connection issues

I can't connect the car kit to my device through a Bluetooth connection.

- Ensure that the car kit is switched on and paired with your device.
- Check that the Bluetooth feature is activated on your device.

The car kit doesn't establish a Bluetooth connection to my paired device when I turn on the ignition or switch on the car kit.

- Check that the Bluetooth feature is activated on your device.
- Ask the technician who installed the car kit to ensure that the ignition sense wire is properly connected.
- Ensure that your device is set to connect to the car kit automatically when the car kit is switched on.

My car radio doesn't have a stereo or auxiliary input.

Ask the technician who installs the car kit to use an adapter that allows to connect the stereo outputs of the car kit to some other input on the car radio (such as the CD changer connector) for stereo sound.

I can't pair my compatible music device with the car kit.

Check that the Bluetooth passcode of the music device is 0000. If this is not the case, change the passcode to 0000 as instructed in the user guide of the music device.

■ Audio issues

My voice echoes at the other end of the line.

- Lower the volume of your car speaker. If the car kit is connected to your car stereo system, decrease the input level, if possible.
- Ensure that the distance between the microphone and speakers is optimal.
- Ensure that the microphone does not point toward the speaker.

The caller can't hear my voice during a call.

Ensure that the device is properly connected to the car kit through a Bluetooth connection.

The audio quality isn't good or I can't hear sound.

- If the car kit is connected to the car radio, check that the car radio volume is set properly.
- If the car kit is connected to the supplied loudspeaker, check that the car kit volume is set properly.

The car kit doesn't play sound in stereo.

- Check that the car radio is set to receive audio through the stereo input.
- Check that you have selected the correct audio source in the car radio.
- Check that the car radio volume is set properly.

The sound quality of music is similar to a phone call.

If you use the music player feature of your mobile phone, check that the phone supports the A2DP Bluetooth profile and that no other A2DP device is connected to the car kit. If your phone supports this profile and another A2DP device is connected to the car kit, disconnect the other device from the car kit and connect your phone.

If you use a music device that supports the A2DP Bluetooth profile, check that no other A2DP device is connected to the car kit.

I can't hear music played when the mobile phone or music device is connected to the car kit.

- Check that your phone or music device supports the A2DP Bluetooth profile and that no other A2DP device (for example, a Bluetooth adapter using A2DP) is connected to the car kit.
- Check that the phone or music device is properly connected to the car kit.
- Check that the car kit is properly connected to the stereo input on your car radio. See "Integration with a car radio system", p. 32, or consult with the technician who installed the car kit.

The car radio isn't muted when I answer a call.

Ask the technician who installed the car kit to ensure that the car radio mute wire is properly connected.

■ Other issues

The car kit doesn't switch on when I turn on the car ignition.

Ask the technician who installed the car kit to ensure that the ignition sense wire is properly connected.

The battery of the mobile phone doesn't charge when the device is connected to the car kit.

Check that the mobile phone is connected to the car kit with the supplied charging cable.

8. Installation

■ Safety information

Observe the following safety guidelines when installing the car kit.

- Only a qualified service technician should install or service the car kit using the approved original Nokia parts supplied in the sales package. Faulty installation or service may be dangerous and may invalidate any warranty which may apply to the car kit.

End users should remember that the car kit comprises of complex technical equipment that requires professional installation using special tools and expert know-how.

- Instructions given in this guide are general guidelines that apply to the installation of the car kit in an automobile. However, due to the wide variety of car types and models available on the market, this guide cannot consider the individual technical requirements relevant for any particular vehicle. Contact the vehicle manufacturer for detailed information about the vehicle in question.
- The car kit is suitable for use only in a vehicle with a 12-V, negative grounding. Use on other supply voltages or alternative polarity will damage the equipment.
- Remember that modern automotive systems include onboard computers where key vehicle parameters are stored. Improper disconnection of the car battery may cause loss of data, necessitating extensive effort for reinitialisation of the system. If you have any concerns, contact your car dealer before any installation work is done.
- Do not wire the car kit equipment to the high-voltage lines of the ignition system.
- When installing the parts of the car kit, ensure that none of them interfere with or hinder the steering or braking systems or other controls or systems used in the operation of the vehicle (for example, airbags). Ensure that the car kit and any of its components are not

installed where you might come in contact with it in the event of an accident or collision.

If the display of a mobile device is to be used, ensure that the device is mounted in a holder and that the device display is clearly visible to the user.

- Your service technician or dealer may be able to provide you with information on alternatives for mounting the equipment suitably in your vehicle without requiring bore holes.
- Do not smoke when working on the car. Ensure that there is no source of fire or flame nearby.
- Take care not to cause damage to electrical cables, fuel or brake lines, or safety equipment during installation work.
- RF signals may affect improperly installed or inadequately shielded electronic systems in motor vehicles such as electronic fuel injection systems, electronic antiskid (antilock) braking systems, electronic speed control systems, and airbag systems. If you notice a fault or change in the operation of such a system, contact your car dealer.
- Ensure that cables are placed so that they will not be subject to mechanical wear and tear (for example, not laid under car seats or over sharp edges).

■ Integration with a car radio system

The car kit can be connected to a car radio system in three different ways. Select the appropriate option according to the parts supplied in the sales package.

For information about the connectors on the hands-free unit HF-23, see "Hands-free unit HF-23", p. 39.

You can connect the car kit to a loudspeaker with an impedance of at least 2 ohms. The optimal impedance for the car kit is 4 ohms. If the impedance is over 8 ohms, the output power is significantly lower than normal.

Use the ISO cable CA-152

When you connect the car kit to the car radio system with the ISO cable CA-152, you can select if the car kit amplifier is used for calls and the car radio amplifier is used for music, or if the car kit amplifier is used for both.

Use the car kit amplifier for calls and music

In this setup, the car radio is muted when you make or receive a call or listen to music from a connected device that supports the A2DP Bluetooth profile.

The built-in amplifier of the car kit is used for calls and music played on the A2DP device.

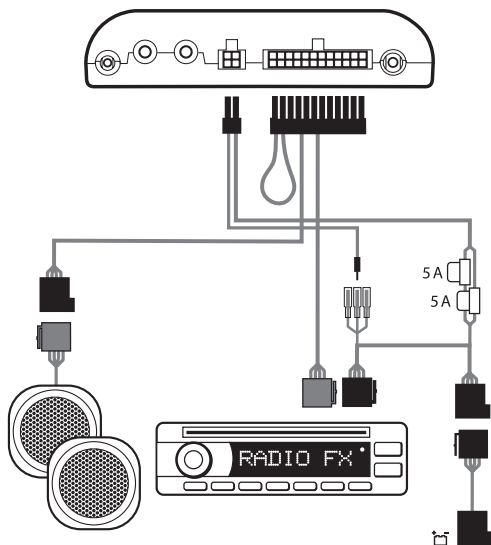

- To connect the ISO cable to the car radio:
 - Unplug the appropriate cables from the car radio, and insert the ISO cable plug instead. Connect the open ends of the cables to the car radio speakers.

- Connect one of the wires labelled Mute 1, Mute 2, or Mute 3 on the car radio to the ISO cable. Leave the other mute wires connected as they are.
 - Insert the power cable plug of the ISO cable to the respective connector on the hands-free unit.
 - Check the +12-V power pin and the ignition pin on the car radio and the respective pins of the ISO cable. If necessary, swap the pins on the fuses of the ISO cable. Plug the ISO cable to the two open ISO connectors.
2. Plug the ISO cable to the respective connector on the hands-free unit.
 3. Connect the external input device CU-10 and the microphone MP-2 to the respective connectors on the hands-free unit.
 4. To charge a compatible Nokia mobile phone through the car kit, connect one end of the supplied charging cable CA-134 to the hands-free unit and the other end to the 2.0 mm (0.08 inch) charging connector of the phone.
 5. Switch on the car kit, press the wheel in the standby mode, and select *Settings > Audio > Music output > System connector*.

Use the car kit amplifier for calls and the car radio amplifier for music

In this setup, the car radio is muted when you make or receive a call.

The amplifier and equaliser of your car radio are used for music played on a connected device that supports the A2DP profile. The built-in amplifier of the car kit is used for calls.

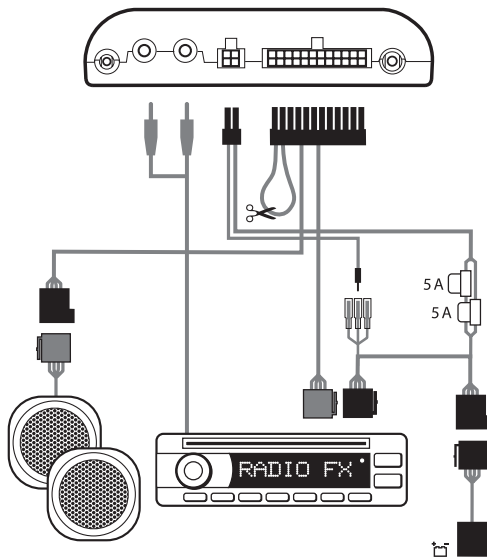

1. To connect the ISO cable to the car radio:

- Unplug the appropriate cables from the car radio, and insert the ISO cable plug instead. Connect the open ends of the cables to the car radio speakers.
- Connect one of the wires labelled Mute 1, Mute 2, or Mute 3 on the car radio to the ISO cable. Leave the other mute wires connected as they are.
- Insert the power cable plug of the ISO cable to the respective connector on the hands-free unit.
- Check the +12-V power pin and the ignition pin on the car radio and the respective pins of the ISO cable. If necessary, swap the

pins on the fuses of the ISO cable. Plug the ISO cable to the two open ISO connectors.

2. Plug the ISO cable to the respective connector on the hands-free unit.
3. Cut the loop indicated with scissors in the figure.
4. Connect the stereo outputs of the hands-free unit to the AUX input of the car radio. Use an appropriate cable specific to your car radio (this cable is not supplied with the car kit).
5. Connect the external input device CU-10 and the microphone MP-2 to the respective connectors on the hands-free unit.
6. To charge a compatible Nokia mobile phone through the car kit, connect one end of the supplied charging cable CA-134 to the hands-free unit and the other end to the 2.0 mm (0.08 inch) charging connector of the phone.
7. Switch on the car kit, press the wheel in the standby mode, and select [Settings](#) > [Audio](#) > [Music output](#) > [Automatic detection](#).

Use the power cable CA-153P

In this setup, the car radio is muted when you make or receive a call.

The loudspeaker SP-3 is used for calls, and the amplifier and equaliser of your car radio are used for music played on a connected device that supports the A2DP Bluetooth profile.

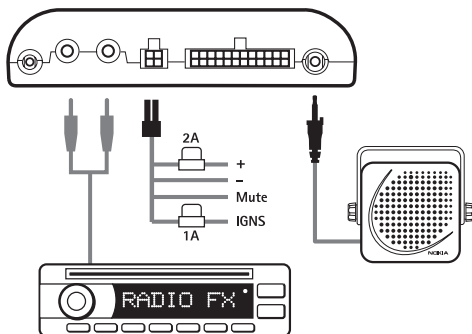

1. Connect the respective wires of the power cable CA-153P to the car battery and ignition sense (if available). Connect the car radio mute wire (if available) to the car radio.
2. Plug the power cable to the respective connector on the hands-free unit.
3. Connect the loudspeaker SP-3 to the respective connector on the hands-free unit.
4. Connect the stereo outputs of the hands-free unit to the AUX input of the car radio. Use an appropriate cable specific to your car radio (this cable is not supplied with the car kit).
5. Connect the external input device CU-10 and the microphone MP-2 to the respective connectors on the hands-free unit.
6. To charge a compatible Nokia mobile phone through the car kit, connect one end of the supplied charging cable CA-134 to the hands-free unit and the other end to the 2.0 mm (0.08 inch) charging connector of the phone.
7. Switch on the car kit, press the wheel in the standby mode, and select [Settings](#) > [Audio](#) > [Music output](#) > [Automatic detection](#). Alternatively, if the music is to be played back through an external

loudspeaker (such as the SP-3), select *Mono speaker* instead of *Automatic detection*.

Do not use the internal amplifier of the hands-free unit to drive external loudspeakers to play back music. If you need to replace a fuse on the CA-153P cable, only use a fuse with a rating of 2 A or less.

■ Install the car kit in a vehicle

This section describes how to install the car kit parts in a vehicle. The parts are explained in "Parts", p. 11.

When installing the parts of the car kit, ensure that none of them interfere with or hinder the steering or braking systems or other controls or systems used in the operation of the vehicle (for example, airbags). Do not use screws to install the display if you mount it within the head impact area. Use the supplied adhesive instead.

Installation of the car kit may cause warning or other alert tones in the vehicle (such as reversing warning tones or lights left on alerts) to be muted. For further information, contact the manufacturer of the vehicle or its representative.

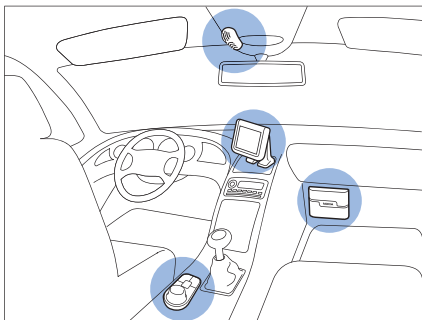

Example of appropriate installation, with the display mounted using the supplied stand

Hands-free unit HF-23

The hands-free unit has the following connectors:

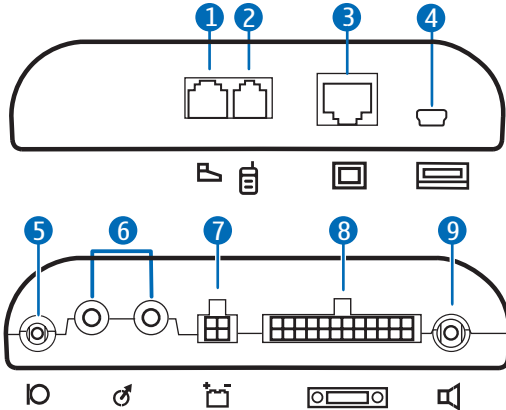

1. Connector for input device CU-10
2. Connector for charging cable CA-134 (to charge a compatible Nokia phone)
3. Connector for the display unit SU-34
4. Mini-USB connector for firmware update
5. Connector for microphone MP-2
6. Stereo outputs (standard RCA connectors) for connection to a car radio with appropriate line-in ports. The outputs are active only when you listen to music from a device that supports the A2DP Bluetooth profile and that is connected to the car kit.
7. Connector for power cable CA-153P
8. Connector for ISO cable CA-152
9. Connector for loudspeaker SP-3

When you install the hands-free unit, ensure that the cables for the microphone and loudspeaker reach the places where you intend to mount these parts.

Do not mount the hands-free unit inside a metal housing or on a metal surface, because this will impair the Bluetooth connection between the hands-free unit and the Bluetooth device that is connected to the car kit. For an optimal connection, ensure that the distance between the hands-free unit and a metal surface is over 4 mm (0.16 inch).

Install the hands-free unit in the car using suitable mounting material (not supplied in the sales package). Ensure that the hands-free unit stays securely in place.

Input device CU-10

The input device should be located so that it is within easy reach of the user. Do not mount the input device within the head impact area.

Ensure that the input device cable reaches to the hands-free unit for connection. The best location to mount the input device is horizontally on the console between the driver's and front passenger's seat so that the input device keys are toward the front of the vehicle.

To mount the input device:

1. Attach the supplied tape pad to the desired location in the car: peel off the protective sheet from a side of the pad, and press the pad into place.

When you peel off the protective sheet, do not touch the adhesive side with a finger. Ensure that the surface where you attach the pad is dry and free from dirt and dust.

2. Peel off the protective sheet from the pad on the underside of the input device and from the other side of the pad attached to the car.
3. Press the pads firmly against each other, and check that the input device stays securely in place.

Display SU-34

The display should be located so that it is clearly visible for the user and it can be easily rotated left, right, up, or down.

When installing the display, ensure that it does not interfere with or hinder the steering or braking systems or other controls or systems used in the operation of the vehicle (for example, airbags).

Ensure that the display cable reaches to the hands-free unit for connection. Mount the display on the dashboard in the upright position.

When you peel off the protective sheet from the supplied adhesive, do not touch the adhesive with a finger.

Mount the stand to the dashboard

To use the display with the supplied stand:

1. Peel off the protective sheet from a side of the supplied adhesive, and attach it to the feet of the stand.
2. Place the display cable between the two feet of the stand, and lock it in place between the teeth of the feet.
3. Peel off the protective sheet from the other side of the adhesive, and press the stand firmly to the dashboard.

Ensure that the surface where you attach the stand is dry and free from dirt and dust.

Mount the plate to the dashboard

To use the display with the supplied mounting plate:

1. Peel off the protective sheet from a side of the adhesive, and attach it to the plate.
2. Peel off the protective sheet from the other side of the adhesive, and press the plate firmly to a mounting device (such as a mounting bracket) that is attached to the dashboard.

When you use screws instead of adhesives to install the plate, do not use screws if you mount it within the head impact area. To drill the bore holes, check the markings on the inner side of the plate that show where the screws can be placed.

Attach the display to the stand or plate

To attach the display to the stand:

1. Press the ball hinge on the stand into the socket on the connector part of the display cable (1).

2. Slide the display onto the connector part (2).
3. Set the display to the appropriate position (3).

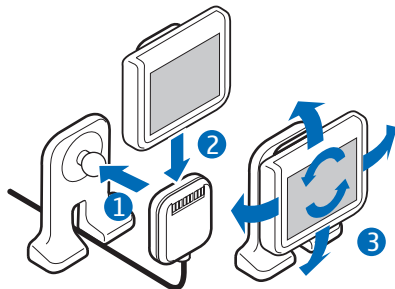

To attach the display to the plate:

1. Press the ball hinge on the stand or plate into the socket on the connector part of the display cable (1).
2. Slide the display onto the connector part (2).
3. Set the display to the appropriate position (3).

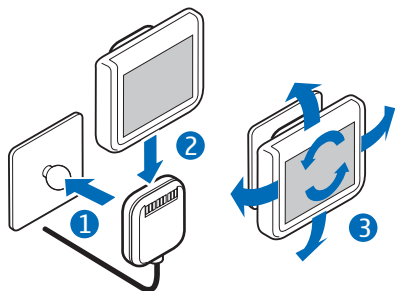

If you need to change the mounting, pull the connector part of the display cable from the ball hinge. To detach the display, pull it from the connector part.

Microphone MP-2

Select the mounting location of the microphone carefully to increase the quality of voice transmission.

The best place to mount the microphone is close to the rear view mirror. Mount the microphone so that it points toward the driver's mouth and at least 1 metre (3 feet) from the car kit loudspeaker to avoid audio feedback.

Ensure that the microphone cable reaches to the hands-free unit for connection.

Mount the microphone so that it is not exposed to air streams from the vents. Do not place the microphone cable in the heating, ventilation, or air-conditioning system. Use the supplied double-sided adhesive tape to fix the microphone to reduce the amount of background noise of the car that can interfere with your calls.

Insert the microphone plug into the microphone connector on the hands-free unit, and turn the plug clockwise to lock it firmly. Use of any other microphone than the supplied microphone may impact the audio quality.

ISO cable CA-152

If the ISO cable CA-152 is supplied with the car kit, you can use it to easily connect the car kit to a car radio that has ISO connectors. See "Integration with a car radio system", p. 32.

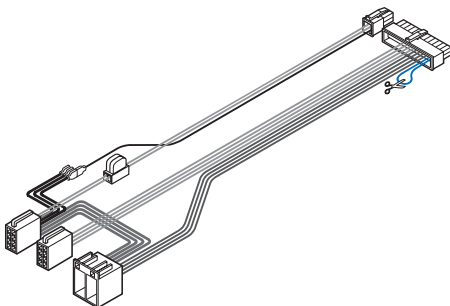

Motion sensor

The hands-free unit HF-23 contains a motion sensor that allows the car kit to automatically switch on when you turn on the ignition and start driving. The motion sensor works if it is activated and the ignition sense wire is not connected.

To activate the motion sensor, switch on the car kit, press the wheel in the standby mode, select [Settings](#) > [Installation](#) > [Ignition sensor](#) > [On](#).

■ Optional accessories

You can extend the features of the car kit with optional accessories. Consult your dealer or service technician for suitable accessories for the car kit. Use only approved and compatible accessories.

Mobile holder

To use your mobile device in a car, you can mount a mobile holder designed for the device. For compatible holders for your device, contact your dealer.

If the display of a mobile device is to be used, ensure that the device is mounted in a holder and that the device display is clearly visible to the user. Ensure that the holder does not interfere with or hinder the steering or braking systems or other controls or systems used in the operation of the vehicle (for example, airbags).

For mounting instructions, see the documentation that came with the mobile holder.

External antenna

The external antenna improves the reception of the mobile phone in a car. For availability, contact your dealer.



Note: In order to comply with RF exposure guidelines, install the external antenna so that a minimum distance of 20 centimetres (8 inches) can be maintained between the external antenna and all persons, with external antenna gain not exceeding 3 dBi.

■ Check the operation of the car kit

After the car kit has been installed, check that it is mounted and working properly. See also "Troubleshooting", p. 28.

■ Software updates

The firmware of the car kit can be updated from a compatible PC using a standard USB cable (not supplied with the car kit) that has a USB plug at one end and a mini-USB plug at the other end. Keep the USB cable connected while the firmware is being updated. To update the firmware, you need to download and install an installation program to your PC.

Check www.nokia.com/support or your local Nokia website for the installation program, the latest firmware version, and additional information.

Care and maintenance

Your car kit is a product of superior design and craftsmanship and should be treated with care. The following suggestions will help you protect your warranty coverage.

- Keep the car kit dry. Precipitation, humidity and all types of liquids or moisture can contain minerals that will corrode electronic circuits.
- Do not use or store the car kit in dusty, dirty areas. Its moving parts and electronic components can be damaged.
- Do not attempt to open the car kit.
- Do not use harsh chemicals, cleaning solvents, or strong detergents to clean the car kit parts.
- Do not paint the car kit parts. Paint can clog the moving parts and prevent proper operation.

If the car kit is not working properly, take the defective part to your nearest authorised service facility for service.

Additional safety information

■ Vehicles

RF signals may affect improperly installed or inadequately shielded electronic systems in motor vehicles such as electronic fuel injection systems, electronic antiskid (antilock) braking systems, electronic speed control systems, and air bag systems. For more information, check with the manufacturer or its representative of your vehicle or any equipment that has been added.

Faulty installation or service may be dangerous and may invalidate any warranty that may apply to the device. Check regularly that all wireless device equipment in your vehicle is mounted and operating properly. Do not store or carry flammable liquids, gases, or explosive materials in the same compartment as the device, its parts, or accessories. For vehicles equipped with an air bag, remember that air bags inflate with great force. Do not place objects, including installed or portable wireless equipment in the area over the air bag or in the air bag deployment area. If in-vehicle wireless equipment is improperly installed and the air bag inflates, serious injury could result.