

Nokia Speakerphone HF-510

User Guide

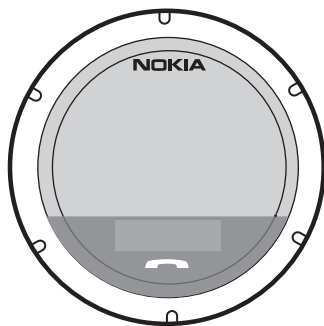

DECLARATION OF CONFORMITY

Hereby, NOKIA CORPORATION declares that this HF-510 product is in compliance with the essential requirements and other relevant provisions of Directive 1999/5/EC. The product is in conformity with the limits defined in Directive 2004/104/EC (amending Directive 72/245/EEC), Annex I, paragraph 6.5, 6.6, 6.8 and 6.9. A copy of the Declaration of Conformity can be found at http://www.nokia.com/phones/declaration_of_conformity.

CE 0560

© 2009 Nokia. All rights reserved.

Nokia, Nokia Connecting People and the Nokia Original Accessories logo are trademarks or registered trademarks of Nokia Corporation. Nokia tune is a sound mark of Nokia Corporation. Other product and company names mentioned herein may be trademarks or tradenames of their respective owners.

Reproduction, transfer, distribution, or storage of part or all of the contents in this document in any form without the prior written permission of Nokia is prohibited.

Bluetooth is a registered trademark of Bluetooth SIG, Inc.

Nokia operates a policy of ongoing development. Nokia reserves the right to make changes and improvements to any of the products described in this document without prior notice.

TO THE MAXIMUM EXTENT PERMITTED BY APPLICABLE LAW, UNDER NO CIRCUMSTANCES SHALL NOKIA OR ANY OF ITS LICENSORS BE RESPONSIBLE FOR ANY LOSS OF DATA OR INCOME OR ANY SPECIAL, INCIDENTAL, CONSEQUENTIAL OR INDIRECT DAMAGES HOWSOEVER CAUSED.

THE CONTENTS OF THIS DOCUMENT ARE PROVIDED "AS IS". EXCEPT AS REQUIRED BY APPLICABLE LAW, NO WARRANTIES OF ANY KIND, EITHER EXPRESS OR IMPLIED, INCLUDING, BUT NOT LIMITED TO, THE IMPLIED WARRANTIES OF MERCHANTABILITY AND FITNESS FOR A PARTICULAR PURPOSE, ARE MADE IN RELATION TO THE ACCURACY, RELIABILITY OR CONTENTS OF THIS DOCUMENT. NOKIA RESERVES THE RIGHT TO REVISE THIS DOCUMENT OR WITHDRAW IT AT ANY TIME WITHOUT PRIOR NOTICE.

The availability of particular products may vary by region. Please check with your Nokia dealer for details.

Export controls

This device may contain commodities, technology or software subject to export laws and regulations from the US and other countries. Diversion contrary to law is prohibited.

9213535/Issue 1 EN

Contents

For your safety.....	4	4. Basic use	14
1. Introduction	5	Copy contacts to the speakerphone	14
Bluetooth wireless technology	5	Make or end a call	15
2. Get started.....	6	Call a recently dialed number.....	15
Charge the battery	6	Voice dialling.....	15
Switch on or off.....	7	End a call.....	15
Switch on	7	Answer or reject a call	16
Switch off.....	8	Adjust volume.....	16
Pair and connect with another device.....	8	Switch a call to the connected device.....	16
Disconnect the speakerphone	9	Clear settings or reset.....	16
Connect the speakerphone manually.....	9	Troubleshooting.....	17
3. Mount in a car	10	5. Battery and charger information.....	18
General safety instructions.....	10	Care and maintenance	19
Attach to a sunvisor	10	Additional safety information.....	21
Attach to a windscreen	11		
Attach to a dashboard	12		

For your safety

Read these simple guidelines. Not following them may be dangerous or illegal.
Read the complete user guide for further information.



ROAD SAFETY COMES FIRST

Obey all local laws. Always keep your hands free to operate the vehicle while driving. Your first consideration while driving should be road safety.



INTERFERENCE

All wireless devices may be susceptible to interference, which could affect performance.

1. Introduction

With the Nokia Speakerphone HF-510, you can make and answer calls hands free. You can also copy the phonebook of your compatible mobile device to the speakerphone and view the copied contacts on the built-in display to make calls.

You can connect the speakerphone to a compatible mobile device that supports Bluetooth wireless technology.

Read this user guide carefully before using the speakerphone. Also, read the user guide for the device that you connect to the speakerphone. For the latest version of the user guide and additional information related to your Nokia product, see www.nokia.com/support or your local Nokia website.

This product may contain small parts. Keep them out of the reach of small children. The surface of this device does not contain nickel in the platings. The surface of this device contains stainless steel.

■ Bluetooth wireless technology

In a Bluetooth connection, the mobile device and the speakerphone should be within 10 meters (33 feet) of each other. Connections can be subject to interference from other electronic devices.

The speakerphone is compliant with the Bluetooth Specification 2.1 supporting the Hands-Free Profile (HFP) 1.5, Phone Book Access Profile (PBAP) 1.1, and Object Push Profile (OPP) 1.1. Check with the manufacturers of other devices to determine their compatibility with this device.

2. Get started

The speakerphone contains the following parts:

1. Power key
2. Microphone
3. Speaker
4. Display
5. Volume wheel
6. Indicator light
7. Answer/end key
8. Charger connector

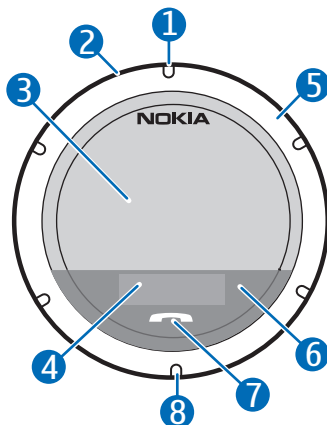

Before using the speakerphone, you must charge the battery and pair the speakerphone with a compatible device.

Parts of the speakerphone are magnetic. Metallic materials may be attracted to the speakerphone. Do not place credit cards or other magnetic storage media near the speakerphone, because information stored on them may be erased.

■ Charge the battery

Before charging the battery, carefully read "Battery and charger information", p. 18.



Warning: Use only chargers approved by Nokia for use with this particular model. The use of any other types may invalidate any approval or warranty, and may be dangerous.

When you disconnect the power cord of any accessory, grasp and pull the plug, not the cord.

1. Connect the charger cable to the charger connector.
2. Connect the charger to the power source. For example, connect the DC-4 charger to the cigarette lighter socket of your car or the AC-5



charger to a wall outlet. During charging, a battery animation scrolls on the display and the red indicator light is displayed. Charging the battery fully may take up to 2 hours and 10 minutes.

If you use a charger that is connected to the cigarette lighter socket, power must be supplied by a 12-volt car battery. Ensure that the charger is properly inserted in the cigarette lighter socket and does not interfere with the normal operation of the car.

In some car models, the cigarette lighter socket is powered by the car battery even when you remove the ignition key. In those cases, the car battery might be discharged even if the speakerphone is not in use. For more information, contact the vehicle manufacturer.

3. When the battery is fully charged, the speakerphone beeps and  is displayed. Disconnect the charger from the speakerphone, then from the power source.

The fully charged battery has power for up to 30 hours of talk time or up to 180 hours of standby time.

To check the battery charge when the speakerphone is not connected to a charger, see the battery indicator on the display. When the battery is fully charged,  is displayed. When the battery charge is low,  is displayed, the red indicator light flashes slowly, and the speakerphone beeps about every 5 minutes. Recharge the battery.

■ Switch on or off

Switch on

To switch on, press the power key. The speakerphone plays an ascending sequence of beeps, the green indicator light flashes once, and the display turns on. The speakerphone tries to connect to the device that was last connected to it ( is displayed).

When the speakerphone is connected to your device and ready for use, the battery indicator and the Bluetooth name of the device is displayed.

Switch off

To switch off, press the power key. The speakerphone plays a descending sequence of beeps, the red indicator light flashes once, and the display turns off.

If the speakerphone is not connected to a device within about 30 minutes, it switches off automatically.

The display is automatically dimmed if the speakerphone is not used within about 10 seconds to save power.

■ Pair and connect with another device

1. Ensure that the speakerphone is switched off and your mobile device is switched on.
2. If you have not previously paired the speakerphone with a device, switch on the speakerphone. The speakerphone enters pairing mode, and  is displayed.

If you have previously paired the speakerphone with another device, switch off the device, and switch on the speakerphone.

3. Within about 5 minutes, activate the Bluetooth feature on the mobile device, and set the device to search for Bluetooth devices. For details, see the user guide of your device.
4. On your device, select the speakerphone (Nokia HF-510) from the list of found devices.
5. Enter the Bluetooth passcode 0000 to pair and connect the speakerphone to your device. In some devices, you may need to make the connection separately after pairing.

If pairing succeeds, the speakerphone is shown on the list of currently paired Bluetooth devices in your mobile device.

When the speakerphone is connected to your device and ready for use, the Bluetooth name of the device is displayed.

You can pair the speakerphone with up to four devices but connect it to only one device at a time.

Disconnect the speakerphone

To disconnect the speakerphone from your mobile device, do one of the following:

- Switch off the speakerphone.
- Disconnect the speakerphone in the Bluetooth menu of your device.
- Move the speakerphone more than 10 metres (33 feet) away from the device.

You do not need to delete a pairing with the speakerphone to disconnect it.

Connect the speakerphone manually

When you switch on the speakerphone, it tries to connect to the device that was last connected to it.

To manually connect the speakerphone to the last used device (for example, after connection loss), ensure that the other device is switched on, and press and hold the answer/end key for about 2 seconds. Alternatively, switch the speakerphone off and back on. To connect the speakerphone to another paired device, make the connection in the Bluetooth menu of the device.

You may be able to set your mobile device so that the speakerphone connects to it automatically. To activate this feature in a Nokia device, change the paired device settings in the Bluetooth menu.

3. Mount in a car

You can attach the speakerphone to the sunvisor, windscreen, or dashboard in your car.

■ General safety instructions

The figure shows possible mounting locations.

When you install the speakerphone in a car, ensure that it does not interfere with or hinder the systems used in the operation of the vehicle (for example, airbags) or disturb your field of vision while driving.

Check that the deployment of the airbags is not blocked or impaired in any way. Only operate the speakerphone if it is safe to do so under all driving conditions.

To use the speakerphone when it is attached to the sunvisor, ensure that the sunvisor is up against the car roof.

Do not adjust the mounting device while driving.

■ Attach to a sunvisor

You can attach the speakerphone to the sunvisor of your car using the supplied clip.

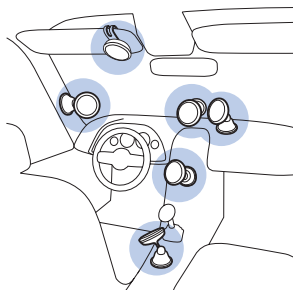

1. To attach the speakerphone to the clip, insert the catch on the clip into the slot at the back of the speakerphone (1). Rotate the speakerphone clockwise until it locks into place (2). (To detach the speakerphone, rotate it anticlockwise.)

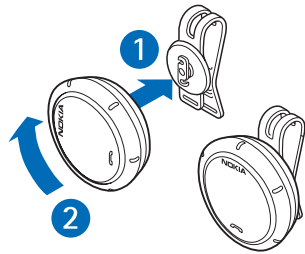

2. Slide the clip around the sunvisor from the driver's or passenger's side (3), and wrap the strap attached to the clip around the sunvisor from the back.

3. Thread the strap through the slot on the clip (4). Tighten the strap to keep the speakerphone securely in place, and firmly press the hook and loop end of the strap against the felt on the strap.

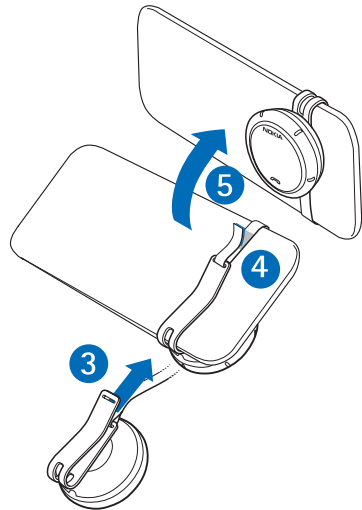

4. Fold the sunvisor up against the car roof (5).

■ Attach to a windscreen

You can attach the speakerphone to the windscreen using the supplied mounting device.

1. Insert the catch on the mounting device into the slot at the back of the speakerphone (1). Rotate the speakerphone clockwise until it locks into place (2).
2. Locate a safe mounting surface on the windscreen, and clean the surface thoroughly with a glass cleaner and a clean towel.

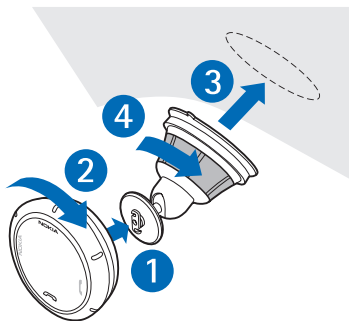

If the ambient temperature is below +15°C (60°F), carefully warm the surface and the suction cup with a hair dryer to ensure a firm grip on the windscreen. Ensure that you do not heat the windscreen excessively to avoid damage to it.

3. Press the suction cup of the mounting device against the windscreen (3), and rotate the mounting device clockwise (4) to create a vacuum between the suction cup and the windscreen. Check that the suction cup is firmly attached.
4. Turn the speakerphone to the desired position.

To detach the speakerphone from the mounting device, rotate it anticlockwise.

To detach the suction cup from the windscreen, rotate the mounting device anticlockwise, and pull the strap located on the edge of the suction cup.

■ Attach to a dashboard

You can attach the speakerphone to the dashboard using the supplied mounting device and adhesive pad.

1. Ensure that the surface where you attach the adhesive pad on the dashboard is flat, dry, and free from dirt and dust.

2. Insert the catch on the mounting device into the slot at the back of the speakerphone (1). Rotate the speakerphone clockwise until it locks into place (2).

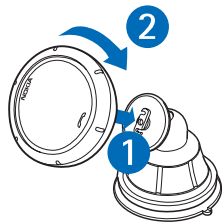

3. Peel off the protective sheet from the adhesive side of the pad (3), and press the pad against the dashboard (4) so that it stays firmly in place.

When you peel off the protective sheet from the pad, do not touch the adhesive side.

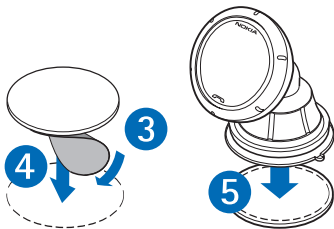

4. Peel off the protective sheet from the other side of the pad, and press the suction cup on the mounting device against the pad (5).
5. Turn the speakerphone to the desired position (6).
6. Rotate the mounting device clockwise to create a vacuum (7). Check that the suction cup is firmly attached.

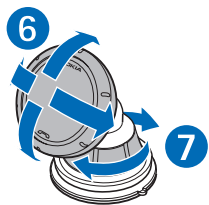





To detach the speakerphone from the mounting device, rotate it anticlockwise.

To detach the mounting device from the dashboard, rotate the mounting device anticlockwise, and pull the strap located on the edge of the suction cup.

4. Basic use

■ Copy contacts to the speakerphone

When the speakerphone is connected to a compatible mobile device that supports the PBAP Bluetooth profile, you can copy the contacts (names and phone numbers) from the internal memory of the device to the speakerphone. When the speakerphone is connected to a compatible device that supports the OPP Bluetooth profile, you can copy the contacts to the speakerphone by sending them through a Bluetooth connection from your device. For information about the Bluetooth profiles supported by your device, see the user guide of the device.

To copy the contacts if your device supports the PBAP profile, turn the volume wheel left until   is displayed, and press the answer/end key.  flashes during copying. If  is displayed, try to copy the contacts using the OPP profile.

To copy a contact if your device supports the OPP profile, select the contact in your device, and send the contact to the speakerphone through a Bluetooth connection. Sending several contacts using the OPP profile takes longer than using the PBAP profile.

Copying may take a few minutes and is automatically stopped after 600 contacts; to stop copying manually when you use the PBAP profile, press and hold the answer/end key. While the contacts are being copied, you cannot use the contacts that you have previously copied to the speakerphone.

If you want to update the contacts from your device to the speakerphone, copy the contacts again. If you use the PBAP profile, the previously copied contacts are replaced with the new ones.

The speakerphone supports three phone numbers per contact. If a contact has more than three phone numbers saved in your device and you want three particular numbers to be copied to the speakerphone, save the three numbers as a new contact in your device.

■ Make or end a call

To make a call from your mobile device that is connected to the speakerphone, use the device in the normal way. Speak towards the speakerphone. For optimal performance, check that there are no objects in front of the microphone and that the microphone is in front of you. During a call,  is displayed.

To call a number that you have copied to the speakerphone, turn the volume wheel when no call is in progress. If the name of the contact contains Latin characters, scroll to the initial letter, press the answer/end key, and scroll to the name. If the name does not contain Latin characters, scroll to the name, and press the answer/end key. To make the call, scroll to the desired number, and press the answer/end key. To exit from the contacts, scroll to , and press the answer/end key; alternatively, wait for 10 seconds, or press the answer/end key twice.

Call a recently dialled number

To redial the number you last called (if your device supports this feature with the speakerphone), press the answer/end key twice when no call is in progress.

Voice dialling

To activate voice dialling (if your device supports this feature with the speakerphone), press and hold the answer/end key for about 2 seconds when no call is in progress. When  is displayed, say the voice tag of the desired contact clearly.

For voice dialling, you must save voice tags for the desired contacts in your mobile device. For details, see the user guide of your device.

End a call

To end a call or cancel a call attempt, press the answer/end key.

■ Answer or reject a call

When you receive a call, you hear a ringing tone through the speakerphone. The caller's number is displayed on the speakerphone if the cellular network supports this function. The name saved with the number is displayed if you have copied the name and number to the speakerphone. If the name and number are not available, only  is displayed.

To answer the call, press the answer/end key.

To reject the call, press the answer/end key twice.

■ Adjust volume

To increase the speakerphone volume during a call, turn the volume wheel right. To decrease the volume, turn the wheel left. The volume level is displayed on the speakerphone.



Warning: Do not hold the device near your ear when the loudspeaker is in use, because the volume may be extremely loud.

■ Switch a call to the connected device

To switch a call from the speakerphone to the connected device, switch off the speakerphone, or press and hold the answer/end key for about 2 seconds. When the call is switched to the connected device,  is displayed.

To switch the call back to the speakerphone, switch on the speakerphone (if it is off), or press and hold the answer/end key for about 2 seconds.

■ Clear settings or reset

To clear the pairing settings and copied contacts from the speakerphone, press and hold the power key and the answer/end key (for over 4 seconds) until the red and green indicator lights start to alternate and  is displayed. After the settings are cleared, the speakerphone enters pairing mode.

To reset the speakerphone if it stops functioning even though it is charged, connect the speakerphone to a charger while you press and hold the answer/end key.

■ Troubleshooting

If you cannot connect the speakerphone to your compatible device, do the following:

- Ensure that the speakerphone is charged, switched on, and paired with your device.
- Ensure that the Bluetooth feature is activated on your device.
- Ensure that the speakerphone is within 10 metres (33 feet) of your device and that there are no other electronic devices between the speakerphone and the device.

If the name of the person who is calling you is not shown on the speakerphone display, even though it is saved in the connected mobile device, check that the device supports the PBAP Bluetooth profile and that the cellular network provides the caller's number.

5. Battery and charger information

This device has an internal, nonremovable, rechargeable battery. Do not attempt to remove the battery from the device as you may damage the device. This device is intended for use when supplied with power from the following chargers: AC-3, AC-4, AC-5, and DC-4. The exact charger model number may vary depending on the type of plug. The plug variant is identified by one of the following: E, EB, X, AR, U, A, C, or UB. The battery can be charged and discharged hundreds of times, but it will eventually wear out. Recharge your battery only with Nokia approved chargers designated for this device. Use of an unapproved charger may present a risk of fire, explosion, leakage, or other hazard.

If a battery is being used for the first time or if the battery has not been used for a prolonged period, it may be necessary to connect the charger, then disconnect and reconnect it to begin charging the battery. If the battery is completely discharged, it may take several minutes before the charging indicator light is displayed.

Unplug the charger from the electrical plug and the device when not in use. Do not leave a fully charged battery connected to a charger, since overcharging may shorten its lifetime. If left unused, a fully charged battery will lose its charge over time.

Always try to keep the battery between 15°C and 25°C (59°F and 77°F). Extreme temperatures reduce the capacity and lifetime of the battery. A device with a hot or cold battery may not work temporarily. Battery performance is particularly limited in temperatures well below freezing.

Do not dispose of batteries in a fire as they may explode. Batteries may also explode if damaged.

Never use any charger that is damaged.



Important: Battery talk and standby times are estimates only and depend on network conditions, features used, battery age and condition, temperatures to which battery is exposed, and many other factors. The amount of time a device is used for calls will affect its standby time. Likewise, the amount of time that the device is turned on and in the standby mode will affect its talk time.

Care and maintenance

Your device is a product of superior design and craftsmanship and should be treated with care. The following suggestions will help you protect your warranty coverage.

- Keep the device dry. Precipitation, humidity, and all types of liquids or moisture can contain minerals that will corrode electronic circuits. If your device does get wet, allow it to dry completely.
- Do not use or store the device in dusty, dirty areas. Its moving parts and electronic components can be damaged.
- Do not store the device in hot areas. High temperatures can shorten the life of electronic devices, damage batteries, and warp or melt certain plastics.
- Do not store the device in cold areas. When the device returns to its normal temperature, moisture can form inside the device and damage electronic circuit boards.
- Do not attempt to open the device.
- Do not drop, knock, or shake the device. Rough handling can break internal circuit boards and fine mechanics.
- Do not use harsh chemicals, cleaning solvents, or strong detergents to clean the device.
- Do not paint the device. Paint can clog the moving parts, microphone, or speaker and prevent proper operation.

These suggestions apply equally to your device, charger, or any accessory. If any device is not working properly, take it to the nearest authorised service facility for service.



Recycle

The crossed-out wheeled-bin symbol on your product, battery, literature, or packaging reminds you that all electrical and electronic products, batteries, and accumulators must be taken to separate collection at the end of their working life. This requirement applies in the European Union. Do not dispose of these products as unsorted municipal waste. For more environmental information, see the product Eco-Declarations at www.nokia.com/environment. Always return your used electronic products, batteries, and packaging materials to a dedicated collection point. This way you help prevent uncontrolled waste disposal and promote the recycling of materials. More detailed information is available from the product retailer, local waste authorities, national producer

Care and maintenance

responsibility organisations, or your local Nokia representative. Check how to recycle your Nokia products at www.nokia.com/werecycle, or if browsing on a mobile device, www.nokia.mobi/werecycle.

Additional safety information

■ Vehicles

RF signals may affect improperly installed or inadequately shielded electronic systems in motor vehicles such as electronic fuel injection systems, electronic antiskid (antilock) braking systems, electronic speed control systems, and air bag systems. For more information, check with the manufacturer, or its representative, of your vehicle or any equipment that has been added.

Faulty installation or service may be dangerous and may invalidate any warranty that may apply to the device. Check regularly that all wireless device equipment in your vehicle is mounted and operating properly. Do not store or carry flammable liquids, gases, or explosive materials in the same compartment as the device, its parts, or enhancements. For vehicles equipped with an air bag, remember that air bags inflate with great force. Do not place objects, including installed or portable wireless equipment in the area over the air bag or in the air bag deployment area. If in-vehicle wireless equipment is improperly installed and the air bag inflates, serious injury could result.